

РОССИЙСКАЯ АКАДЕМИЯ ЕСТЕСТВЕННЫХ НАУК

В.А.АЦЮКОВСКИЙ

Общая
эфиродинамика



RUSSIAN ACADEMY OF NATURAL SCIENCES

V.A. ATSYUKOVSKY

General ether dynamics

MODELING OF
MATTER AND FIELD
STRUCTURES ON THE
BASIS OF
REPRESENTATIONS
ABOUT THE GAS-
LIKE ETHER

Edition 2nd



MOSCOW
ENERGOATOMIZDAT
2003

UDC 530.3.

Atsyukovsky V.A. General Ether Dynamics. Modeling of structures of matter and fields on the basis of representations about gas-like ether. Second edition. Moscow: Energoatomizdat, 2003. 584 c.

ISBN 5-283-03229-9

On the basis of ideas about the ether as a real viscous and compressible gas the ether-dynamic interpretation of the basic structures of matter and mechanisms of physical fields of interactions is given. The models of basic stable elementary particles: proton, neutron, electron, photon, as well as atomic nuclei, atoms and some molecules are considered. The ether dynamical bases of the mechanisms of strong and weak nuclear, electromagnetic and gravitational interactions are developed. The ether dynamical interpretation of the basic equations of quantum mechanics is given. The equations of electromagnetic field and gravitation are clarified. The model of the stationary dynamical Universe is developed.

For researchers and university students specializing in applied physics.

Table 28, fig. 151. Bibliogr. 517 names.

Orders for the book and CD-ROM should be sent to:
140182 Zhukovsky-2, Moscow region, P.O. Box 285

ISBN

Author, 2003

5-283-03229-9©

 Table of contents

Preface	7
Introduction.....	8
Chapter 1: The Methodological Crisis of Modern Physics ..	14
1.1. The crisis of physics at the end of the 19th century and the "physical revolution" early twentieth century	14
1.2. The role of Einstein's theory of relativity and quantum theory. mechanics in preparation for a new crisis of physics.....	17
1.3. The crisis of modern theoretical physics.....	23
1.4. Physical revolutions as major milestones in the development of natural science	29
1.5. On the significance of militant materialism today.....	40
Conclusions	43
Chapter 2: A Brief History of the Ether.....	46
2.1. A brief overview of the theories and models of the ether.....	46
2.2. Disadvantages of known hypotheses, theories and models of the ether	62
2.3. Etheric Wind. Reality and falsification.....	64
Conclusions	71
Chapter 3: Methodological Foundations of Ether Dynamics	74
3.1. On some provisions of dialectical materialism.....	74
3.2. Methodology of ether dynamics	80
3.2.1. General physical invariants.....	80
3.2.2. Model (qualitative) representations of structures and processes ...	90
3.2.3. Ways to uncover the inner workings of phenomena	95
Conclusions	100
Chapter 4. The structure of ether.....	103
4.1. The structure of ether.....	103
4.2. Determination of numerical values of ether parameters	108
4.3. Forms of ether motion	116
Conclusions	126
Chapter 5. Structure of gas vortices and their environmental interaction	127
5.1. A brief history of the theory of vortex motion	127

5.2. Formation and structure of a linear gas vortex	134
5.3. Gas vortex energetics	139
5.4. The motion of a gas around a linear vortex. Energy paradox.....	149
5.5. Formation and structure of toroidal gas vortices. Formation of helical motion	152
5.6. Gas motion in the vicinity of a toroidal vortex	161
5.6.1. Toroidal and annular gas motion in the vicinity of a helical toroidal vortex.....	161
5.6.2. Temperature field near the vortex and vortex absorption of the surrounding gas	164
5.7. Vortex diffusion.....	167
5.8. Force interactions of gas and vortices	170
5.8.1. Essence of force effects of the gas medium on the bodies.....	170
5.8.2. Frontal impact of gas flow on a body	171
5.8.3. Lateral effects of gas flow on the body.....	172
5.8.4. Thermodynamic effect of the medium on the body	175
Conclusions	178
Chapter 6. Nucleons and atomic nuclei	181
6.1. A brief history of atomic nucleus research	181
6.2. Determination of ether dynamical parameters of the proton	185
6.3. The physical nature of strong nuclear and electromagnetic interactions of protons.....	196
6.4. Neutron formation and structure	206
6.5. Models of atomic nuclei.....	207
6.5.1. Basic etherodynamic principles of structural organization of atomic nuclei	207
6.5.2. Some general properties of composite nuclei	212
6.5.3. Structure of complex nuclei	223
6.6. Excited states of vortex toroids are weak nuclear interactions.....	234
6.7. Nuclear isomerism.....	238
Conclusions	241
Chapter 7: Atoms, Molecules, Matter.....	243
7.1. A brief history of the development of atomic physics and the quantum mechanics	243
7.2. On some features of the philosophy of quantum mechanics	249
7.3. Hydromechanical treatment of the equations of quantum mechanics	253
7.4. Structure of electron shells of atoms and molecules	265

7.5. Formation of molecules	275
7.6. Formation of intermolecular bonds	277
7.7. Heat and aggregate states of matter	283
7.8. Physical essence of electrical and thermal conductivity of metals	286
7.9. Aura	290
7.10. Mechanism of catalysis	292
Conclusions	294
Chapter 8: Electromagnetic Phenomena	297
8.1. A brief history of the development of the theory of electromagnetism	297
8.2. Physical essence of electromagnetism	307
8.2.1. Units of electric and magnetic quantities in the ISS system	307
8.2.2. Free electron structure	310
8.2.3. Physical essence of the electric field	313
8.2.4. Capacitor (capacitance)	317
8.2.5. Free electron in electric field	319
8.2.6. Physical essence of electric current in metal	323
8.2.7. Physical essence of the magnetic field	328
8.2.8. Free electron in a magnetic field	334
8.2.9. Inductance. Mechanism of the phenomenon of self-induction	337
8.3. Electromagnetic interactions	341
8.3.1. Force interaction of conductors with current	341
8.3.2. Conductor mutual induction	346
8.3.3. Electrical transformer	358
8.3.4. Electromagnetic induction	364
8.3.5. DC-magnet interaction	366
8.3.6. Permanent magnet interaction	368
8.4. Electromagnetic field	370
8.4.1. Maxwell's equations and their limitations	370
8.4.2. Some refinements of the equations of electrodynamics	381
8.4.3. Types of electromagnetic radiation	397
8.4.4. Quasi-static field of stray currents	399
8.4.5. Structure of a transverse electromagnetic wave	402
8.4.6. Structure of a longitudinal electromagnetic wave	404
Conclusions	408
Chapter 9. Light	410
9.1. A brief history of optics	410
9.2. Photon structure	415
9.3. Moving photons in space	429
9.4. Optical phenomena	434
9.4.1. Reflection of light	434

9.4.2. Refraction of light.....	436
9.4.3. Interference.....	438
9.4.4. Diffraction	439
9.4.5. Aberration	441
9.4.6. Interaction of light rays	445
Conclusions	446
Chapter 10. Gravitational interactions	448
10.1. Brief history of the development of ideas about gravitation	448
10.2. Thermodiffusion processes in the ether as a basis for gravitational interactions of bodies	454
10.3. Propagation speed of gravitational interaction	466
10.4. Absorption of ether by gravitational masses	467
10.5. Magnetism of celestial bodies as a consequence of their absorption of ether.....	476
Conclusions	479
Chapter 11: Ether and cosmology.....	481
11.1. Modern cosmology and cosmogony.....	481
11.2. Circulation of ether in the Universe.....	483
11.3. Structure of a spiral galaxy	489
11.4. Ephyrodynamic functional classification galaxies and extragalactic astronomy.....	496
11.5. Stars and their evolution.....	507
11.6. Solar system as an element of the Galaxy.....	515
11.7. Etheric wind and the structure of the Earth	526
11.8. Resistance of the ether to the motion of celestial bodies.....	534
11.9. Comets.....	536
11.10. Resolution of cosmological paradoxes in ether dynamics	547
Conclusions	554
Conclusion.....	556
<i>Literature</i>	<i>557</i>

Preface

I see the future of physics in the continuation
mechanical models.

A.Rey.

There is nothing in the world but ether and its vortices
R. Descartes. The beginnings of philosophy.
1650 z.

The present work is a development of the ether-dynamic picture of the world, presented by the author for the first time in the article "Dynamik des Aethers" (Ideen des exakten Wissens. Stuttgart 1974. N 2. S. 48-58), further in the book

"Introduction to Ether Dynamics. Model representations of structures of matter and fields on the basis of gas-like ether", published by VINITI in 1980, then in the work "General ether dynamics", published there in 1987, then in the book "General ether dynamics. Modeling of the structures of matter and fields on the basis of the gas-like aether" (M., Energoatomizdat, 1990).

In the time since the books were published, the author has repeatedly had to present these materials to a variety of audiences, including several year-long cycles of lectures in the Lecture Hall of the Polytechnic Museum, with interest usually shown by applied physicists and practicing engineers. This can be explained by the fact that it is to this circle of persons that new problems arise that cannot be solved by existing and recognized theories alone. The comments received during the discussions of the papers, as well as the comments of numerous readers, were the reason for the appearance of additions and in some cases clarifications of some provisions of ether dynamics.

The materials presented in this book should not be regarded as a solution to the problem of the universe, but rather as a statement of this problem, in the solution of which many researchers of private directions should take part.

The author expresses his deep gratitude to all the persons who have had the opportunity to review this work and whose advice he has benefited from in preparing the manuscript for publication.

* (Lenin V.I. Philosophical Notebooks. PSS, 5th ed. M.: T.29. P. 499)

Introduction .

The form of development of natural science, as it thinks, is the hypothesis. Observation discovers some new fact that makes impossible the previous way of explaining facts belonging to the same group. From this point onwards, the need for new ways of explanation arises.

F.Engels. Dialectics of Nature.

In the theory of cognition, as in all other fields of science, one should approach dialectically, i.e. not to assume that our cognition is ready-made and unchangeable, but to analyze how knowledge emerges from ignorance, how incomplete, inaccurate knowledge becomes more and more complete and accurate.

V.I.Lenin. Materialism and Empiriocriticism.

At the end of the twentieth century it became clear to many that modern physics had reached a dead end and its traditional phenomenological, postulative and axiomatic methods could not give anything new for the development of natural science. Attempts

"The accumulation of new data in some areas does not practically lead to an understanding of their essence, but on the contrary, increasingly obscures the overall picture of the universe. The accumulation of new data on individual directions practically does not lead to the understanding of their essence, but, on the contrary, increasingly obscures the overall picture of the universe. Theory provides less and less help to practitioners in solving their applied problems. This means that natural science as a whole and its leading branch - physics - are in a deep crisis, first of all, in a crisis of methodology.

It should be recalled that natural science in general and physics, in particular, have already been in crisis during the last centuries. It happened at the end of the XVIII century, when the possibility of creating a wide variety of substances from the same initial components was discovered, at the end of the XIX century, when new physical phenomena appeared that did not fit into the usual concepts of "classical" physics, and now, at the crossroads of the XX and XXI centuries, history has repeated itself. This situation should be understood not as a scientific catastrophe, but as exhaustion of the outdated methodology. This means the *necessity of revision of all the accumulated experience*

*material, including that which **does** not fit into the established concepts, and the need to search for a new methodology capable of covering all this material on a unified basis and, on this basis, to identify new research directions and solve the accumulated applied problems.*

Attention is drawn to the fact that the way out of the crisis state has always been found in the ways of deepening into the structure of matter, i.e. attracting to the consideration of the building material of already mastered forms of organization of matter. This corresponds to the position put forward by the famous chemist A. M. Butlerov that

"the properties of any system are determined by its composition and structure". When there were many molecules, atoms - the building material of molecules - were introduced into consideration; molecules turned out to be a combinatorics of atoms. When atoms became many, elementary particles of matter were introduced into consideration - the building material of atoms, atoms turned out to be a combinatorics of elementary particles. The same way is possible now: elementary particles turned out to be many - from 200 to 2000, depending on what to take for elementary particles. But all of them are able to transform into each other, and this is a direct indication that they have in their basis a common building material, the "bricks" of which are many times smaller than the elementary particles themselves. And since it was possible to create such particles in vacuum by creation of strong fields, it means that in the whole world space there are such bricks, they form a single medium - aether. And now the main tasks are to determine the properties of this world medium and to find out the mechanism of formation of all these "elementary particles" of matter, and then of the entire universe.

The present work is an attempt to present the author's ideas about the inner unity of various forms of material entities and physical phenomena.

The necessity of writing this book was caused by the fact that the author has long ago realized the limited capabilities of existing methods of theoretical physics in solving applied problems. Phenomenological, descriptive methods cover the surface of phenomena, external sides and do not allow to reveal their essence. Failure to understand the internal mechanism of phenomena, the essence of material structures leads to the impossibility of finding out the reasons why physical phenomena are the way they are and not other. It also leads to impossibility of prediction of new directions of researches. There appears a closed ring in which science indicates the directions of experiments in a narrow circle of phenomena, and

experiments confirm with their results the statements of science that are true for this circle. New ideas do not arise here.

However, modern science needs exactly the inflow of new ideas to solve new practical problems arising before it. This requires an in-depth understanding of processes, penetration into the inner essence of material formations and physical phenomena, revealing the essence of internal motion of the constituent parts of processes. And it means the necessity of application of dynamic methods of researches, search of laws of formation of material structures and internal mechanisms of phenomena. Dynamic methods of research require the attraction of model representations, the study of analogies with known phenomena, and at this stage - the search for common structures of material formations at all levels of organization of matter and common bases of all physical phenomena and interactions.

It is experimentally proved that the "physical vacuum" is able under certain conditions to "give birth" to elementary particles of matter. Hence, firstly, the confirmation of the idea of the monism of nature from the matter of the "physical vacuum" to the Universe as a whole, and secondly, it points to the presence in the "physical vacuum" of parts of "elementary particles" of matter and to the fact that the totality of these parts forms a material medium filling the world space. Such medium should have quite concrete physical properties and be the basis of all material formations, physical fields and phenomena.

Thus, the search for the basis of various forms of material formations and physical phenomena leads to the necessity of using the next, deeper compared to the achieved one, level of matter organization. Since the level of organization of matter into material particles should be considered as more or less mastered, the element of organization of matter at the new, next level should be a material formation, the size of which is essentially smaller than the size of the smallest of the known ones "elementary particles" of matter. Such a material formation was once called by Democritus a "amer". The aggregate of amers forms aether, a medium that fills the entire world space, is a building material for all kinds of matter and is responsible for all kinds of physical interactions: nuclear strong, nuclear weak, electromagnetic and gravitational, as well as some others, nowadays not yet realized and mastered.

Unlike known theories, hypotheses and models of the ether, the proposed work does not idealize the ether. Logical analysis

phenomena of the microcosm and macrocosm showed that the ether has properties of an ordinary real gas - density, pressure, temperature, viscosity, compressibility and other properties of ordinary gases. Such a model has not been considered by anyone before, but it allows us to avoid the mistakes made by the authors of the previous theories, hypotheses and models of the ether, who idealized the ether in one way or another, which inevitably led to the emergence of contradictions within the initial assumptions of these theories, hypotheses and models.

The ideas about the ether as a gas-like medium could appear only on the basis of the analysis of the behavior of "elementary particles" of matter during their interactions, and not only on the basis of the analysis of the properties of the macrocosm, as it was done earlier. Consequently, before the accumulation of data on the behavior of now known microparticles, i.e. before the 60s of the last century, such representations practically could not arise. Therefore, attempts to make a consistent picture of the world on the basis of ideas about the ether could not succeed at that time. However, now such an attempt is quite timely.

The paper shows that at all levels of organization of matter, from the Universe as a whole to elementary particles and ether, the same physical laws operate. This means that for the functional analysis of phenomena the apparatus of ordinary mathematical physics can and should be used, which, of course, does not exclude the use of any other mathematics for individual cases, but there can be no question of any preferential position of mathematics with respect to physics. In the first place should always be the physical essence of phenomena, reflected in the physical model. Mathematics is an auxiliary means of analysis, which can be applied only after the development of a clear physical model.

To analyze the states of the ether as a gas-like body, the apparatus of gas- and hydromechanics can be used to a great extent. Unfortunately, in these traditional areas of classical physics there are not only achievements, but also shortcomings, in many respects complicating research. Nevertheless, many provisions developed by the above sections of physics allow us to construct models of various forms of matter and physical interactions and to carry out their investigations.

Attempts to use the apparatus of gas and hydromechanics to explain the structure of material entities and various physical phenomena and to build a unified picture of the world have

centuries of history. It is enough to recall the names of Thales of Miletus, Democritus, Anaximander, R.Descartes, I.Newton, M.V.Lomonosov, L.Boltzmann, W.Thomson (Lord Kelvin), M.Faraday, J.K.Maxwell, J.J.Thomson, A.K. Timiryazev, N.P.Kasterin, V.F.Mitkevich and many others to realize that this direction has a solid foundation to which currently there is an unprecedented progress. Timiryazev, N.P.Kasterin, V.F.Mitkevich and many others to realize that this direction has a solid foundation, which is currently undeservedly neglected. The task of the author of the proposed work was to attract and generalize, taking into account the experimental data of the last decades, the disparate results obtained by numerous researchers. As in every generalization, in some cases the ideas about particular phenomena were clarified.

The emergence of ether-dynamics at present is predetermined by the whole course of development of natural science for the whole previous history of natural science. The development of natural science has always proceeded by deepening into hierarchical levels of organization of matter. From nature as a whole (Thales, VI century BC) to substances (Aristotle, IV century BC), then to substances (Paracelsus, XVI century), then to molecules and atoms (corpuscles - Lomonosov, elements - Lavoisier, XVIII century; Dalton, XIX century), then to elementary particles of matter (Faraday, XIX century; Rutherford, XX century). Each such transition marked a physical revolution and led to qualitatively new discoveries and qualitatively new knowledge. Now the next transition to the next, even deeper level of matter organization - ether and its element - amer is ripe.

The material presented below can be divided into two parts according to the degree of reliability. The first, the most reliable, includes everything related to the problem statement and the general methodology of the approach to its solution. This material is presented in the first three chapters and partially in the fourth chapter. To the second part, which requires clarification during the subsequent development of ether dynamics, we should refer all numerical calculations of the ether parameters, presented in the fourth chapter, as well as all structural constructions of models of material formations, interactions and specific physical phenomena. In spite of the logical closedness of the whole material, the presence of numerical calculations, mainly corresponding to the experimental data, the realization of some experiments confirming the initial assumptions, all this, of course, is still in an incomplete form, and some constructions correspond so far only to the level of hypotheses.

It should be specially emphasized that, in spite of the rich prehistory of the question, etherrodynamics makes only the first real steps connected with the engineering approach to the problem

of the world order. Undoubtedly, the subsequent development of these provisions will require the intervention of specialists in specific areas, who are likely to change and clarify a lot of things.

Chapter 1: The methodological crisis of modern physicists

The history of ideas is the history of struggle and, therefore, the struggle of ideas.

V.I.Lenin.

Views on the nature of things must be continuously improved by learning new facts and generalizing them scientifically.

August Kekule

1.1. The crisis of physics in the late **nineteenth** century and the "physical revolution" **of the** early twentieth century.

As it is known, at the end of XIX - beginning of XX centuries there was a crisis in physics. This crisis was expressed in the fact that in the process of realizing the consequences to which the provisions of the so-called "classical physics", recognized by all, lead, their contradictions with the real reality became clear.

Thus, the extension of Newton's Law of Universal Gravitation to the whole Universe led to the Neumann-Seliger gravitational paradox, according to which at any point of infinite space the gravitational potential is infinitely large, and this cannot be. The notion of infinite space led to the photometric paradox of Shezo-Olbers, according to which at any point of the firmament a star should be observed and the whole sky should shine, but this is not observed. Finally, the Second Beginning of Thermodynamics led to the Clausius Thermodynamic Paradox, according to which all temperatures in the Universe will one day equalize, all processes will stop, and the "Heat Death of the Universe" will occur. If the first two paradoxes were still somehow tolerable, the third paradox caused a general panic. And it did not occur to anybody that all these consequences are only consequences of incompleteness of the accumulated knowledge.

And when at the end of XIX - beginning of XX century in physics there were a number of discoveries that did not fit into the ideas of "classical" physics - X-rays (K.Röntgen, 1895), radioactivity (A.Becquerel, 1896), electron (J.Thomson, 1897), inconsistency of black body radiation energy distribution with experience (M.Planck, 1900), presence of nucleus in atom (E.Rutherford, 1911), then there was a general confusion. But instead of recognizing the incompleteness of the "generally accepted" theories, physicists followed the way of denying the matter itself and preferring abstract mathematics to it.

In 1909, Lenin's book "Materialism and Empiriocriticism" [1] was published. Extensive literature is devoted to the analysis of this widely known work. Let us recall some provisions expressed and substantiated by V.I.Lenin in this book.

The development of science in the 19th century showed the limited nature of the physical picture of the world that existed until then. The revision of a number of concepts developed by the former classical physics began, whose representatives, as a rule, stood on the positions of spontaneous, unconscious, often metaphysical materialism, from the point of view of which new physical discoveries seemed inexplicable. This was because classical physics proceeded from the metaphysical identification of matter with certain and very limited ideas about its structure. When it turned out that these ideas did not correspond to the data obtained by experience, then instead of clarifying their incomplete ideas about the essence of matter, idealist philosophers, as well as individual physicists began to prove the "inconsistency" of materialism, deny the objective value of scientific theories, see the purpose of science only in the description of phenomena, etc.

Lenin pointed out that the possibility of idealistic interpretation of scientific discoveries is contained in the very process of cognition of objective reality, generated by the very progress of science.

The penetration into the depths of the atom, attempts to isolate its elementary parts led to the strengthening of the role of mathematics in the development of physical knowledge, which in itself was a positive phenomenon. However, mathematization of physics, as well as incompleteness, relativity, relativism of our knowledge in the period of radical change of ideas about the physical world contributed to the crisis of physics and were epistemological sources "physical" idealism.

In the conditions of crisis situation in physics, idealist philosophers made an attempt to oust materialism from natural science, to impose their explanation of new discoveries on physics, to reconcile science and religion. According to the figurative expression of V.I.Lenin, "the new physics went mad in idealism, mainly because physicists did not know dialectics" [1, pp. 276-2-2]. [1, pp. 276-277], i.e. physicists did not take into account the necessity to clarify their ideas about the structure of matter and instead preferred to simply throw matter out of the theory and replace it with abstract mathematics. Physicists, as Lenin rightly noted, "matter has disappeared, only equations remain"[1, p. 326].

because scientists have actually abandoned the ideas about the physical essence of phenomena, the model ideas about the structure and motions of matter, which constitute the essence of any physical phenomenon.

Lenin pointed out in his work that "modern physics lies in labor. It gives birth to dialectical materialism. The labor is painful. In addition to a living and viable being, they give inevitably some dead products, some garbage, to be sent to the premises for filth. Among these garbage are all physical idealism, all empiriocritical philosophy together with empiriosymbolism, empiriomonism, etc." [1, c. 332]. To the great regret, all this turned out to be true also in relation to the state of physics of the late twentieth century. The birth of dialectical materialism by physics was clearly delayed. Physical idealism, empiriocriticism, all the dregs of the "painful genera of physics", about which Lenin warned, blossomed lushly. **It can be argued that all of Lenin's criticisms of theoretical physics of the late 19th - early 20th centuries have fully retained their significance in relation to modern theoretical physics - the physics of the second half - late 20th century.**

What was the philosophical basis of such a situation? Today it can be argued that the philosophical basis of the crisis of physics in the late XIX - early XX centuries was the dogmatism of physical theory, the so-called "classical" physics [2, pp. 7-12; 66-71]. It fetishized several "well-studied" "laws" of nature and became deadlocked whenever these "laws" led to obvious incongruities or, as they are commonly called, paradoxes. **It did not set itself the task of understanding the inner essence of physical phenomena, but limited itself to their external description, i.e. phenomenology.** It practically did not set itself the task of elucidating the structures of matter at the deep levels of organization. This inevitably led to a superficial understanding of phenomena, did not prepare her for the perception of new facts, the appearance of which always turned out to be a complete surprise for her. But most importantly, it had no methodological basis, no philosophical common ground, no clear understanding of the fact that the whole nature is a set of bodies and phenomena of moving self-organizing matter. **No one had formulated an approach to the universal physical invariants, i.e. categories inherent to all bodies and phenomena, which, due to their universality, are not subject to any transformations.**

And vice versa, all specific phenomena and laws derived from specific conditions were given the character of universality, thus excluding the very possibility of their correction. Newton's law of gravitation is "universal", the Principles of thermodynamics are universal, Maxwell's equations of electrodynamics are absolute truth. And the confirmation of the prediction of any particular phenomenon made these "laws" unquestionable.

Meanwhile, any formulaic expression of any phenomena is at best only a first linear approximation to what actually exists, and that only in terms of the set research goal. Deepening into the essence of the phenomenon will inevitably reveal its nonlinearity, and setting a different goal will simply lead to a different form of description of this phenomenon.

Thus, it was the idealistic approach to the development of physical theories that predetermined the crisis of physics at the end of the XIX century. But instead of changing the very essence of methodology, physicists followed the further path of abstraction from reality by introducing postulates, i.e., provisions formulated on the basis of "ingenious conjectures" and infinitely applicable to the whole world and all phenomena. And here a special role was played by Einstein's Theory of Relativity and quantum mechanics.

1.2. The role of Einstein's theory of relativity and quantum mechanics in preparing a new crisis of physics

The reasoning of Einstein's Special Theory of Relativity (STO) is based on the fundamental denial of the ether, recognizing the existence of the ether in nature would make the emergence of the Theory of Relativity impossible [3].

Einstein came to the idea that there is no ether in nature on the basis of comparison of the results of experiments of Fizeau (1851) [4] and Michelson (1881,1887) [5, 6].

As is known, as a result of the experiment Fizeau found that light is partially entrained by a moving medium (water). As a result of experiments on detection of ether wind, conducted in 1881 by Michelson and in 1887 by Michelson and Morley, it turned out that there is no ether wind on the surface of the Earth, at least that is how the results of these experiments were interpreted. In fact, the etheric wind was already detected in Michelson's very first experiment.

although its velocity was slower than expected. This was in contradiction with Lorentz's theory of an absolutely stationary ether.

Detailed justification of the principles underlying the Special Theory of Relativity, Einstein gave in the article

"The principle of relativity and its consequences" (1910) [3, p. 140]. Here he pointed out that the partial entrainment of light by a moving liquid (Fizeau's experiment) "...rejects the hypothesis of complete entrainment of the ether. Consequently, two possibilities remain:

1) the ether is completely motionless, i.e. it takes absolutely no part in the motion of matter (what about Fizeau's experiment, which showed partial entrainment? - *V.A.*);

2) the ether is carried away by moving matter, but it moves at a different speed from that of matter.

The development of the second hypothesis requires the introduction of any assumptions concerning the relation between the ether and moving matter. The first possibility is *very simple* (italics is mine - *V.A.*), and for its development on the basis of Maxwell's theory no additional hypothesis is required, which can complicate the foundations of the theory".

Pointing out further that Lorentz's theory of a fixed ether is not supported by the result of experiment and thus there is a contradiction, Einstein concluded that it was necessary to abandon the medium that fills world space, for, as he believed,

"...it is impossible to create a satisfactory theory without rejecting the existence of a medium that fills all space." [3, c. 145-146].

The rejection of the ether gave the author of the Special Theory of Relativity the opportunity to formulate five (and not two, as is usually considered) postulates on which the STO is based:

1. *The absence of the ether in nature*, which was justified only on the grounds that recognizing the ether leads to a complex theory, while denying the ether allows for a simpler theory;

2. *The principle of relativity*, stating that *all processes* in the system, which is in a state of uniform and rectilinear motion, occur according to the same laws as in the resting system (earlier in relation to mechanical processes this principle was formulated by Galileo);

3. *The principle of constancy of the speed of light* (independence of the speed of light from the speed of the source);

4. *Invariance of the four-dimensional interval* in which space (coordinates) is related to time through the speed of light;

5. *The principle of simultaneity*, according to which an observer judges the passage of events in time by the light signal reaching him from those events.

In accordance with these postulates, it is asserted that it is fundamentally impossible for any physical experiment conducted inside a laboratory (reference frame) to establish whether this laboratory is at rest or moving uniformly and linearly, as well as the constancy of the speed of light in any inertial system.

It is easy to see that the presence of ether would not allow us to formulate any of the above postulates. If the ether is omnipresent, then the ether wind must be observed inside the moving laboratory, and consequently it is possible to determine the fact of its motion by measuring the velocity of the ether wind inside the laboratory without going outside the laboratory. The presence of the ether would also raise the question of the transient process occurring during the generation of light by the source, as well as the magnitude of the velocity of light relative to the source at the moment of exit in the immediate vicinity of the source, the velocity of light relative to the ether, the displacement of the ether relative to the source, and many other questions. Searching for answers to all these questions would hardly leave the ground for formulation of the listed postulates.

The General Theory of Relativity (GTR) of the same author extended the postulates of STO to gravitation. Thus the speed of light, which is a purely electromagnetic quantity, was interpreted as the speed of propagation of gravitation, although gravitation is a different fundamental interaction than electromagnetism, differing in the interaction constant by 36 (!) orders of magnitude. OTO - General Theory of Relativity added to the previous five more postulates - the extension of all the postulates of STO on gravitation, the dependence of the rate of clocks on the gravitational field, the covariance of coordinate transformations (bringing formulaic expressions in the same form for any reference frame), the equality of the propagation speed of gravity to the speed of light and, finally, the presence (!) in nature of the ether. About the latter, Einstein in the works "Ether and the Theory of Relativity" (1920) [7] and "On Ether" (1924) [8] expressed himself quite definitely: "According to the general theory of relativity, the ether exists. Physical space is inconceivable without ether". That's how it is!

Without examining in detail all the circumstances related to the criticism of the logic of the construction of the postulates underlying Einstein's theory of relativity, and the so-called "experimental-

It should be noted only that the logic of both these parts is closed on itself, when the conclusions lead to the initial positions, that both parts of this unified theory contradict each other in the essential for them question of the existence of the ether (STO asserts the absence of the ether in Nature, and OTO its presence) and that neither STO nor OTO have any experimental confirmations and never had. All these "confirmations" are either elementary explained at the level of ordinary classical physics, as it takes place, for example, with acceleration of particles in gas pedals, or have always been self-evident, as it was with the problem of equivalence of inert and gravitational masses (classical physics has never distinguished between them), or are a consequence of the directed processing of results, as it took place with the deflection of light near the Sun, when from all methods of extrapolation the one which most corresponds to the theory is chosen, or simply does not correspond to it. (For more details on all this, see [9]).

The special theory of relativity from the moment of its creation is based on the false idea that in the experiments on ether wind, which were conducted by A.Michelson and his followers in the period from 1880 to 1933 years was not found ether wind, which was to be observed on the surface of the Earth due to its movement in orbit around the Sun. Then the concept of G.Lorentz was checked (this concept was put forward by O.Fresnel in the beginning of XIX century), according to which the all-penetrating ether was absolutely motionless in space. The conducted experiments gave other results, but there was never a "zero" result.

Huge work on the study of the ether wind was done by a student and follower Michelson D.K.Miller, but his results were rejected by the supporters of Einstein's theory of relativity, which thereby committed a scientific forgery. And even when in 1929 Michelson himself with his assistants Pis and Pearson confirmed the existence of the ether wind, it did not change anything: the theory of relativity has already gained supporters who were scorned anyone who dared to contradict them.

All this is not accidental. Recognition of the presence of the ether in nature would immediately destroy the basis of the Special Theory of Relativity, for all its postulates cannot be justified in any way if there is an ether in nature.

Something similar happened in atomic physics, in which quantum mechanics took the dominant position.

According to the provisions of quantum mechanics, born when Einstein's theory of relativity was recognized worldwide as the main physical theory, there are "fields" inside the atom, but not a specific material medium, especially not the ether. The field, on the other hand, was ascribed the status of a "special material medium", without any explanation of what this medium is and what its specific parameters are.

All quantum mechanics, which "explains" intraatomic processes and radiation spectra, is based on postulates, the total number of which today is already dozens. The beginning of the postulation process was laid by M. Planck in 1900, who assumed that light is emitted in portions - quanta - and that each quantum carries energy proportional to frequency. This position was soon confirmed by experiments, which gave grounds for the widespread use of new postulates.

E. Rutherford's development in 1911 of the planetary model of the atom, according to which all electrons - elementary particles carrying equal negative charges - revolve around a positively charged nucleus, led to new problems, such as why electrons do not fall on the nucleus, although they move accelerated. The fact that the acceleration is not longitudinal but transverse, in which the rotational energy should not change at all, was not taken into account by anyone. To explain this mysterious phenomenon, N. Bohr put forward a postulate about "allowed" orbits, being on which is possible and without radiation. Then followed a whole chain of postulates, reasoning and inferences, including quantization of parameters of orbits and electrons themselves, quantization of radiation spectra, etc., but without any explanation of reasons of all these positions and phenomena. Nevertheless, all this gave good methods of calculations, which as if confirmed the legitimacy of such approach.

It is curious that Schrödinger, who developed his famous equation, proceeded from the usual mechanical model of the oscillation of a material point in a potential field, i.e., from the model of an ordinary mechanical pendulum, replacing, however, the usual description of the oscillation of a pendulum through amplitude and period by the description of the same oscillation through the change in the difference of total and potential energy. Of course, the ensemble of such points located in space should have been treated as a mass density, which was emphasized by some researchers, for example, by Madelung. However, instead of the *physical notion* of mass density, a *mathematical* notion was substituted for it.

the probability density of finding an electron at a given point in space. Thus the very possibility of attempts to find the internal structure of the atom and the mechanism of all atomic phenomena was excluded. The absence of the ether in nature also here played an extremely negative role in the possibility of understanding the structure of the atom and the causes of atomic phenomena.

On the question of recognition or denial of the ether in the 30's, and then in the 50's in Soviet science discussions took place, spilling out onto the pages of the party press, first of all on the pages of the journal "Under the Banner of Marxism" (now "Questions of Philosophy") [10]. These discussions touched not only the ether proper, but also the problems of Einstein's theory of relativity, as well as the old problem of "action at a distance", the point of view according to which no intermediate medium is needed at all for the transfer of interaction energy at any distance. The content and course of these discussions are described quite fully, but extremely tendentiously by A.S.Sonin in his book "Physical Idealism" [11], as well as in a large article by V.P.Vizgin [12]. Omitting the numerous vicissitudes of these discussions, we should note some main points.

The point of view of the existence of the ether in nature, the incorrectness of Einstein's theory of relativity and the unsuitability of the principle of the In the 30s, the viewpoint of "action at a distance" without an intermediate medium was defended by professors A.K.Timiryazev and Z.A.Tseytlin of Moscow State University, academician A.A.Maksimov and philosopher E.Kolman (Moscow) and academician-electrotechnician V.F.Mitkevich (Leningrad). The point of view of relativists, i.e. supporters of Einstein's theory of relativity, who categorically denied the ether and recognized the possibility of action at a distance, was expressed by physicists O.D.Khvolson, A.F.Ioffe, V.A.Fok, I.E.Tamm, L.D.Landau, Y.I.Frenkel. The discussion was held on the pages of the journal "Under the Banner of Marxism". The opposing sides in the discussion in the 1950s were represented by Mitkevich (a practicing electrical engineer) and Frenkel (a theoretical physicist).

"For a number of reasons," wrote Mitkevich, "the construction of a physical theory covering all the material accumulated by science is unthinkable without recognizing the special significance of the medium that fills all three-dimensional space. In the language of the past epochs experienced by physics, this universal medium is called aether".

Frenkel objected to him: "I do not deny the validity of the idea of the field as a certain reality. I deny only the validity of the idea that this field corresponds to some material image...". His theoretical scheme accepted

the hypothesis of long-range action - the charges or points of interaction acted through an empty medium. "But if," Frenkel continued, "V.F. by the presence of a process called the electromagnetic field is not satisfied, and requires the preservation of the carrier of this process, which is Faraday's and Maxwell's aether, then modern physics responds to this with a decisive - no" [13].

It should be noted with regret that the point of view of the supporters of the theory of relativity and the absence of the ether in nature has won and up to the present time is in domestic and world physics prevailing.

1.3. Crisis of modern theoretical physics

Today, physics is in a deep crisis.

In spite of numerous public speeches, statements, popular and special articles aimed at proving the greatness of the edifice of modern physics and the grandiose possibilities awaiting mankind in connection with its achievements, it has to be stated that in fact there is nothing of the kind.

Numerous attempts to unite the basic fundamental interactions on the basis of the existing concepts in modern physics were practically unsuccessful. The Great Unification Theory (GUT), about which theoretical physicists have been trumpeting for many years as the main goal of physical understanding of nature, has not been created. And if it had been created, what would have changed from it? Would new directions have been developed, new devices created? Or would physicists just enjoy the "beauty" of the new theory? The number of discovered "elementary particles" of matter has long been out of sync with the complete uncertainty of their structure, and long ago no one is surprised or amused by the discovery of another one "elementary particle."

Theoretical physics continues to accumulate contradictions, delicately called "paradoxes", "divergences", which are of fundamental character and are a serious brake in further development of fundamental and applied science. Even in such a mastered field as electrodynamics, there are whole classes of problems that cannot be solved with the help of the existing theory. For example, when two identical charges move, a paradox arises: resting identical charges repel each other according to Coulomb's law, but when they move, they attract each other because

are currents. But they are still at rest relative to each other, so why do they attract when they move?

Such difficulties, existing in most areas of physics, are not, as it is commonly believed, objective difficulties in the development of human cognitive activity. Misunderstanding of the essence of processes, preference of phenomenology, i.e. external description of phenomena to the detriment of studies of the internal mechanism, the inner essence of phenomena inevitably gives rise to all these difficulties.

Today it is already clear to many that both the theory of relativity and quantum mechanics in its modern presentation lead researchers away from the clarification of the essence of phenomena, replacing the understanding of the essence of the external, superficial description based on some private postulates and assumptions. It should not be surprising, therefore, that this approach is becoming less and less productive. The limited research directions resulting from such a methodology do not allow to find out the deep processes of nature, naturally leading to the fact that many essential factors in experiments and theoretical studies are not taken into account, and numerous useful opportunities - unused. The phenomenological method, entrenched in science, increasingly shows its helplessness.

"Generally accepted" mathematical dependencies of the theory of relativity and quantum mechanics have acquired the status of absolute truth, and all new theories are checked for conformity to them, which are discarded if there is no such conformity.

However, it is not superfluous to recall the trivial fact that every physical phenomenon has innumerable sides and properties and that for a complete description of even a simple phenomenon it is necessary to have an infinitely large number of equations. And in no case can it be assumed that the equations we deal with today describe phenomena in any complete way, be it Schrödinger's equations for the phenomena of the microcosm, Maxwell's equations for the electromagnetic field, or Newton's "law" of universal gravitation. This means that the refinement of fundamental laws and their mathematical description should become a regular working matter and the halo of infallibility, which today sanctifies a few initial formulas or "principles", should be removed.

In this connection it is appropriate to recall Engels' statement:

"Exceptional empiricism, which allows itself to think at best except only in the form of mathematical calculations, imagines."

as if it operated only with indisputable facts. In reality, it operates mainly with traditional ideas, mostly outdated products of the thinking of its predecessors... The latter serve as a basis for endless mathematical calculations, in which, because of the rigor of mathematical formulas, the hypothetical nature of the assumptions is easily forgotten. ... This empiricism is no longer able to correctly depict the facts, because in the image of them it is paved with the traditional interpretation of these facts " [14, c. 114].

The current situation in theoretical physics - accumulation of contradictions, disunity and differentiation of its directions, superficiality of description of phenomena, lack of understanding of the deep essence of phenomena and, as a consequence of all this, loss of the leading role in setting and carrying out applied research testify to a deep methodological crisis that has engulfed theoretical physics. There is no reason to believe that the crisis will be solved on the same paths on which theoretical physics continues to move, or on the paths of creation, as recommended by Niels Bohr,

"crazy ideas" (i.e. when everyone has stopped understanding anything at all).

The methods of modern fundamental theoretical science have long been exhausted and have become a brake in the development of productive forces, in the use of the forces of nature by man.

For a long time and a lot has been said about NTR - scientific and technological revolution, about the achievements of science: atomic weapons and nuclear energy have been created, flights to near space have been mastered, numerous materials have been developed, the most complex computing machines, robots, etc. have been created. However, today qualitatively new discoveries are becoming less and less, the development is mainly quantitative, and even in the study of "elementary particles" of matter, not qualitatively new techniques are used, but simply increasing the power of particle gas pedals in the blind faith that the new energy level, maybe, will give something new, although so far it does not give anything qualitatively new.

In applied physics, various solemn promises never come true. Many years have already passed since a "stable" plasma was obtained, which existed for "as little as" 0.01 seconds. Over the years, numerous facilities for thermonuclear reactions have been built to provide mankind with thermonuclear energy forever. However, there are installations, institutes and plants have been created for these purposes, conferences and

honoring. There is no only thermonuclear, for which all this was conceived, and a number of thermonuclear programs have already been closed not only in our country, but also abroad.

Same with MHD - magnetic hydrodynamics. It is the same with superconductivity, and the same with all the applied cases. And only in the field of nuclear energy things have somehow moved forward, since nuclear power plants actually exist and continue to be built. But even here the well-known events that have taken place show the lack of knowledge, which directly affects the safety of their operation.

Fundamental research in the physical sciences, based on generally recognized ideas, has become incredibly expensive, and not every state is able to bear such a heavy burden of expenditure on science. This suggests that physics has been hit, if I may say so, by an economic crisis. However, the main sign of the crisis of physics is that the theory and methodology of modern fundamental physical science are becoming less and less able to help applied sciences in solving the problems posed by practice.

The presence of "paradoxes", the absence of qualitatively new ideas mean that the ideas existing in physics have already been exhausted and that physics in general and physical theory in particular are in a deep crisis.

Here there is no need to go into details of criticism of the state and methodology of modern theoretical physics, it is to some extent fulfilled by the author in [2], but it is quite possible to recognize that all predictions of V.I.Lenin concerning that physics at the beginning of the century is carried to idealism, were confirmed at the end of the twentieth century completely. It was carried there.

The provisions of modern theoretical physics are in flagrant contradiction with the provisions of dialectical materialism.

Indeed, in the material world, as dialectical materialism asserts, there is no limit to the divisibility of matter. "The electron is as inexhaustible as the atom", Lenin asserted in his famous work "Materialism and Empiriocriticism" [1]. This means that an electron is obliged to have a structure, the material basis of which is some building material. This building material has motion, its parts interact with each other. The same applies to all "elementary particles" of the microcosm, which can *all* transform into each other. But it is also a direct indication of nature that they all have the same basis.

and the same "building material"! This building material is also contained in the whole space, because experiments have shown that force fields in the "physical vacuum", i.e. in the world space are able to "give birth" to elementary particles. Thus, the results of physical experiments directly indicate the presence of the world medium - aether - in Nature.

Meanwhile, modern theoretical physics does not recognize the existence of such building material in principle. All elementary particles, according to physicists, not only have no structure, but even have no dimensions! All their properties - electric charge, magnetic moment, spin, etc. - come from nowhere, they are innate properties that have no mechanism under them. Thus, there remains only the possibility of phenomenological, i.e. only external description of phenomena, which imposes restrictions on the cognitive ability of man: it is impossible to penetrate into the depths of processes, because these processes themselves do not exist! But then the external description also turns out to be very superficial, for any phenomenon is an external manifestation of the very internal movement of its parts, and if the internal mechanism is not taken into account, the observation of these or those external manifestations turns out to be a matter of chance. Then there remains only phenomenology, an external description of the phenomenon, taking into account only "observable" factors. And since these "observable factors" in physics are connected by mathematical expressions, it turns out that "matter has disappeared, only equations remain" (Lenin).

Dialectical materialism asserts the eternity of the universe, the uncreated and indestructible nature of matter, space, time and motion. Einstein's theory of relativity asserts the existence of "Beginnings" of the universe when it was created as a result of the so-called "Big Bang," with claims that prior to this The "Big Bang" was nothing at all. Dialectical materialism requires a generalization of the accumulated experience of natural science. The theory of relativity considers it possible to "freely invent the axiomatic basis of physics". The theory of relativity demands that the continuity of physical theories be respected: all new theories are obliged to conform to Einstein's theory of relativity, but it itself does not conform in any way to the entire previous history of natural science and prides itself on its "revolutionary thinking".

How, in principle, does materialism in physics differ from idealism? Materialism recognizes nature, matter, as primary, and consciousness, ideas about nature, i.e., in this case, theory, as secondary. If

is found any fact that contradicts the theory, then the materialist is forced to change the theory in accordance with the new facts, and the idealist rejects unwanted facts, which happened in the theory of relativity.

"Classical physics" of the XIX century, faced with new facts, had to reconsider its positions, but by no means to abandon the materialistic approach to the theory. But the philosophical insufficiency of physics led to the fact that physicists literally burned down their house - physics, giving everything at the mercy of abstract mathematics, which began to represent itself and physics, and philosophy, and the universe itself. Matter disappeared...

Ignoring the existence of the ether in nature by the supporters of the "long-range action" today has led to an unjustified absolutization of some formulaic dependencies, which their authors claim to be natural laws. Following such a position fundamentally removes the question about the possibility of any clarification of fundamental laws, which is wrong in principle, since any formulas only approximate the real reality. The idea of "long-range action" ("actio in distance") has been revived, according to which we do not need to know whether the medium through which the interaction is transmitted exists or not. Physics abandoned its role as an investigator of nature and fell into abstraction, which has nothing to do with the real nature....

Thus, modern fundamental science and its basis - theoretical physics - have been in a deep crisis for many years. External signs of this crisis are:

- no new discoveries, except for the discovery of many-numbered "elementary particles", the number of which is already several hundred (from 200 to 2000, depending on how you count);
- the high cost of fundamental research, for which such facilities have been built as, for example, the Serpukhov gas pedal, housed in an underground tunnel 22 km long (!), in which 6000 magnets weighing tens of tons each are installed, entangled with pipelines in which liquid helium must be run, or "Tokamaks" designed to produce controlled fusion; however, ramping up the results is envisioned by increasing the capacity of the physical instruments;
- a complete misunderstanding of the structure of matter;
- actual cessation of basic science's assistance to researchers in solving practical problems (created sectoral research centers)

fields of applied science have not only separated from basic science, but have in many ways outpaced it).

The latter is a decisive circumstance. The signs of this crisis, in addition, are:

- the impossibility, within the framework of today's theories, to understand the nature of phenomena that we have long and widely used - electricity and magnetism, gravity, nuclear energy and many others;

- physicists prefer not to generalize the phenomena of nature, but to postulate them, thus consciousness (idea, postulate) goes ahead of matter (nature, facts), if the facts do not fit into the theory, it is not the theory that is corrected, as materialists would do, but the facts are discarded (what is only the story of discarding the results of the ether wind research discovered by Michelson and his followers);

- mathematics, i.e. a way of description, imposes its very superficial models and laws on physics, i.e. nature; all processes, in its opinion, are probabilistic in nature, and they have no internal mechanism;

- Theoretical physics justifies concepts that are directly contradictory to dialectical materialism, such as the theory of the "Big Bang", i.e. "the beginning of the creation of the Universe", although it is stated that dialectical materialism itself is obsolete....

All this is not accidental, but predetermined by the very methodology of modern fundamental science and its head field - theoretical physics.

1.4. Physical revolutions as major Milestones of development of natural science

The history of the development of natural science and, in particular, physics, shows that such crises in natural science have already happened more than once, and each time they were solved stereotypically - by introducing a new hierarchical level.

In order to find a way out of this impasse, to resolve the accumulated contradictions and to advance in fundamental and applied research, it is necessary to recall that the most important results of classical physics were obtained on the basis of the dynamic approach in which each structure is assumed to consist of moving parts and each part of the

even smaller ones. The movement of these parts and their interaction in concrete cases is a concrete phenomenon. The description of external sides of the phenomenon in the dynamic approach is only a consequence, not the main content of the phenomenon, as it follows from phenomenology. The dynamic approach implies the possibility of creating illustrative physical models at all levels of the organization of matter.

The dynamic method proceeds from the assumption that each structure is made up of parts, and each part is made up of even smaller parts. The movement of these parts and their interaction in specific cases is a concrete phenomenon.

The dynamic method in natural science has always justified itself. The main line of development of natural science has always been a step-by-step deepening into the structure of matter, transition to deeper and deeper levels of its organization. Each such transition meant a radical breakdown of old ideas, was another physical revolution and provided a way out of the crisis. And each such transition gave much to mankind.

However, each such transition did not occur by itself, but under the pressure of accumulated new facts, the explanation of which turned out to be impossible within the framework of the existing theories. The resulting crisis situation could not be solved within the framework of the mastered hierarchical level of material formations. But it was solved quite simply after a new, deeper hierarchical level of matter organization was introduced into consideration.

It is noteworthy that practically all physical theories up to the beginning of the twentieth century had physical models as their basis. This is understandable, because any phenomenon has countless properties, and it is impossible to describe them all at once. After all, even such a simple device as a weight suspended on a thread makes a complex motion and can be, depending on the purpose, described in a variety of ways - as a pendulum in the field of gravity, as a torsion pendulum or, finally, as a spring pendulum. And this, not yet counting the combination of all the motions, interaction with the environment, internal processes, etc. All this was well understood by physicists of the XVII-XIX centuries.

In fact, the dynamic method has its origins in the deepest antiquity.

In his time, the German dialectical philosopher Hegel, in his principal's speech to the gymnasium students, made this comparison:

"Just as Antaeus renewed his strength by contact with mother earth, just as every new dawn and increase of science and enlightenment arises by turning to antiquity."

For all his rich imagination, Hegel could not imagine the impact of science in the twentieth century on all spheres of life. In the 19th century, interest in antiquity was almost always the domain of the humanities. In our time, natural science itself has become seriously interested in ancient thought, first of all in its leading fields - physics and mathematics.

As science penetrates more and more deeply into the structure of matter, it is found to be following in the footsteps of the ancient philosophers. It is useful to recall that Dalton, for example, borrowed the word "atom" from Democritus, the ancient Greek materialist philosopher, and from him we now borrow the word "amer" to denote the indivisible part of the atom, which is the molecule of ether. And the word ether itself also came to us from ancient times.

To be fair, although we consider the origin of science to be from the ancient Greeks, in fact this is certainly not the case. Democritus repeatedly emphasized that he was not the originator of atomism, this knowledge he borrowed from the Egyptian priests and Midian magicians (the mighty), from whom he interned for five years. The roots of science lie in the deepest antiquity, of which we know practically nothing. Nevertheless, throughout the history of mankind known to us it has been accompanied by unconventional secret knowledge, which has even received an independent name "esoteric".

However, continuing the tradition, we will start considering the formation of science from Thales of Miletus, who lived in the 6th century B.C. and who already then posed the question: if all of nature is unified, what is the basis of this unity? He believed that nature at the basis of all phenomena has a certain unified medium of "wet" nature - apeiron, otherwise how can they interact and influence each other?

This question has accompanied natural science throughout its history, and only now are we getting the first opportunity to approach an answer to it.

The history of natural science is inextricably linked with the history of the whole society, and each type and development of productive forces, technology corresponds to the corresponding period in the history of natural science.

The first stage of the development of natural science is considered to be preparatory, natural philosophical, and is characteristic of antiquity. In general, technology was still underdeveloped, although there were already some outstanding technical achievements. This stage can be attributed to the period from

VI century B.C. to the beginning of the new era, although realistically it can be considered extended to the beginning of the second millennium of the new era.

In the 5th century B.C. Empedocles and in the 4th century B.C. Aristotle proposed to decompose all nature into "substances" - "earth" (solid), "water" (liquid), "air" (gas) and "fire" (energy). In fact, he introduced the aggregate states of matter and energy, which ensures the transition of matter from one state to another. The Chinese added "wood" (life) to these four "substances". On this basis, some analysis of the physical state of substances became possible and philosophy was born. Aristotle's philosophy lasted in Europe for almost 2 thousand years.

This stage is connected with the transition *from nature as a whole to substances* ("earth" - solid, "water" - liquid, "air" - gas, "fire" - energy). This transition was the *first revolution in natural science*.

This transition itself was stimulated by the desire to realize the world in which man lived, his desire to understand his place in nature. It was impossible to do this without appropriate analysis. The task to understand the aggregate states of bodies came first. And when philosophers of antiquity singled out this problem, introduced the concepts of substances, then on this basis and began to develop philosophy, and already it allowed the formation of independent branches of knowledge, such as statics, astronomy and mathematics. Alchemy began to form, although it should be recognized that in all this there were also echoes of the most ancient (esoteric) knowledge, about the essence of which we still know almost nothing.

Medicine and physics were in their infancy. All natural-scientific knowledge and views were included in a single undifferentiated science under the aegis of philosophy. The differentiation of sciences for the first time appeared at the end of this period closer to the Middle Ages.

The very transition from a unified nature to substances marked the first revolution in natural science.

The second stage of the development of natural science is also considered preparatory. It can be attributed to the X-XIII centuries A.D., i.e. to the Middle Ages, to the period of development of feudal relations. This stage is characterized by the dominance of theology in Western Europe. Science in the West became an appendage of theology, religion. By this time there was an urgent need to save people from numerous epidemics, which literally mowed down the population of Europe. Paracelsus (Philip von Hohenheim, 1493-1541), a prominent physician of the Middle Ages, believed,

that all human processes are chemical processes and that all diseases are related to disturbances in the composition of substances. His method of treatment - the addition of missing chemicals to the sick person's body - laid the foundation for pharmacology, the science of drugs.

These applied tasks required dealing with substances. The transition in natural science from substances to substances was the *second revolution in natural science*.

The progress of technology in the West was extremely slow. Technique did not yet need systematic study of nature, and therefore did not have a noticeable influence on the development of natural scientific knowledge. But even at this time there was already accumulation of new facts that prepared the transition to the next period.

The third stage of development of natural science is called mechanical and metaphysical. The stage lasted from the second half of the XV century and lasted until the end of the XVIII century. This is the time of the establishment of capitalist relations in Western Europe. This stage is associated with the transition from substances to the molecule (small mass). Natural science of this period is revolutionary in its tendencies. Here the natural science of the beginning of the XVII century (Galileo) and the end of the XVII - beginning of the XVIII century (Newton) is distinguished. *Metaphysics* became the dominant method of thinking. But even then, discoveries were made in natural science that revealed dialectics, i.e. development. Natural science was connected with production, transforming from a craft into a manufactory, the energy base of which was mechanical motion. Hence the task to study mechanical motion, to find its laws. Natural science was mechanical, because all the processes of nature were applied exclusively to the scale of mechanics.

The introduction of the idea of the minimal particle of matter - molecule - contributed to the emergence of mechanics of the material point (Newton), a direct consequence of which was the invention by him and G. Leibniz of the mathematics of the analysis of infinitesimal quantities. To the same time belongs the creation of analytical geometry by R. Descartes, the cosmogonic hypothesis of Kant-Laplace, as well as the ideas of development in biology by W.K. Wolf, which prepared the next stage.

In the early 18th century, Russian scientist M. V. Lomonosov formulated the concept of a "corpuscle", i.e. a minimal amount of substance, which was later called a molecule. This gave rise to the development of chemistry. At the end of the same XVIII century, French chemist A. Lavoisier introduced the concept of elements - the simplest substances from the combination of which any substance can be created.

Transition in natural science from substances to molecule (name of the "molecule" - small mass - appeared later) was the *third revolution in natural science*, this transition gave a powerful impetus to the development of chemistry.

The period of the late 18th - early 19th century is characterized by the beginning of the rapid development of capitalism on the basis of the industrial revolution. There was a need for dyes for fabrics, and so there was an increased interest in chemistry. But the development of chemistry was impossible without the following transition to the depth of matter. Therefore, the transition from the molecule to the minimum particle of simple matter was made, which in 1824 was called an atom by the Englishman Dalton, a name borrowed from Democritus. By atom was meant the minimum amount of an element, further indivisible (from Democritus, indivisible). This transition gave rise to the development of chemistry and electromagnetism. Physics and chemistry came to the fore, studying the interconversion of forms of energy and types of matter.

At the same time, the limitations of water engines became clear, and engines were required that could be used in any terrain and under a wide range of conditions. The invention of the steam engine gave rise to industrial capitalism, and industry entered the phase of large-scale machine production. But the steam engine did not completely satisfy production either. There was a need for a compact engine that could be installed in any room and even on individual machines. This gave impetus to the development of electrical engineering, which had the opportunity to develop using the achievements of chemistry.

At this time, the theory of the slow development of the Earth emerged in geology, while evolutionary theory, paleontology, and embryology were born in biology. The second third of the 19th century saw the emergence of cell theory, the doctrine of energy transformation and Darwinism, which dealt a blow to the old metaphysics, forcing us to consider substances and processes in their development.

The transition to atomism was followed by discoveries that revealed the dialectics of nature - the creation of the theory of chemical structure of organic compounds (A.M. Butlerov, 1861), the Periodic System of Elements (D.I. Mendeleev, 1869), electromagnetism (J.K. Maxwell, 1873).

The transition from the molecule to the atom was the *fourth revolution in natural science*. From the end of the 19th century, capitalism entered the stage of imperialism, which entailed an arms race in which

advances in physics, chemistry and emerging electrical engineering were essential.

The stimulating effect of new technical needs on the development of natural science led to the fact that in the mid-1990s new discoveries appeared, mainly in physics - the discovery of electromagnetic waves by H. Hertz, short-wave radiation by K. Roentgen, radioactivity, the electron, the introduction of the idea of the quantum by M. Planck, the creation of the theory of relativity by A. Einstein, the invention of radio by A. Popov. Chemistry (development of the Periodic System of Elements by D.I.Mndeleev) and biology (emergence of genetics) were also significantly advanced.

The late nineteenth and early twentieth centuries saw the emergence of the notion of the "elementary particles" of matter. In 1887, English researcher J.J. Thomson proved the existence of the first elementary particle, the electron. In 1911 E. Rutherford put forward the planetary model of the atom, on the basis of which in 1913-1921 appeared the ideas about the atomic nucleus, electrons and quanta. The proton was discovered by him in 1919, and in 1932 the neutron was discovered by J. Chadwick. Further, a wide range of "elementary particles" of matter was obtained, which led to the development of atomic energy.

N.Bohr developed Rutherford's model of the atom, and in fact from that moment quantum mechanics began to develop rapidly. The next revolution in natural science was prepared by all this.

The fifth revolution in natural science was the introduction of "elementary particles of matter" into consideration, and this led to the advent of atomic energy and semiconductor technology.

In the twentieth century, the development of physics (atomic energy, radar, radioelectronics, communications, automation and cybernetics, quantum electronics - lasers, electronic optics, etc.) was accelerated. Physics as the leading branch of all natural science began to play a stimulating role in relation to other branches of natural science, for example, the invention of the electron microscope caused a revolution in all biology, physiology, biochemistry. Physical methods determined the successes of chemistry, geology, astronomy, contributed to the development of space science and space exploration.

In biology, deepening of the cell structure led to the creation of genetics and molecular biology, in chemistry - to polymer chemistry. And cybernetics and computer science began to develop on the basis of semiconductors.

Thus, the fifth revolution in natural science led to a revolutionary leap in technology, the NTR - the scientific and technological revolution.

The main task of chemistry becomes the synthesis of polymers (rubber, artificial fiber), production of synthetic fuel, light alloys and metal substitutes for aviation and astronautics. The energy base of industry in the twentieth century became increasingly electric (dynamo machine), chemical energy (internal combustion engines), and then, after the Second World War, atomic energy.

The transition to a new deep level of matter organization was also preceded by a crisis expressed in the misunderstanding of the variety of variants of properties of mastered material formations. Introduction of building material of the already mastered level of matter helped to understand the structure of these formations. Thus, the introduction of molecules helped to understand substances, atoms - molecules, elementary particles - atoms. The crisis was overcome, all perplexities were solved, science received a new powerful impetus of development. But the starting point was always applied needs.

Properties and behavior of material formations became clear if material formations of deeper level were introduced into consideration. The transition to a new level always meant a radical breakdown of the established ideas, was another physical revolution and provided a way out of the crisis (Fig. 2.1).

To explain chemical transformations, atoms - the constituent parts of molecules of chemical compounds - were introduced into the theory. And when it became clear that atoms transform into each other, the concept of atoms emerged

"elementary particles" of matter, of which atoms are composed. At the same time, the properties of higher levels of matter organization became clear. It turned out that material formations of the senior hierarchical level differed from each other first of all by a set of elements - material formations of the junior hierarchical level. At the same time the younger formations, for example atoms or "elementary particles", were endowed at first with only the simplest, most essential properties, which was even reflected in the name: atom ("indivisible"), "elementary particles", i.e. the simplest particles. With the accumulation of experimental data, the ideas about the inner essence of phenomena changed, and the physical models of these phenomena changed accordingly. The change of models entailed changes in the equations describing the phenomena.

Revealing the structures, understanding the internal mechanism created an opportunity for directed actions. Directed research was organized, new methods appeared, the increase in the number of senior level varieties did not scare anyone anymore, as it was clear how it all happened and why. Completely new perspectives of theoretical and applied research and applications were opening up. The next physical revolution demonstrated to the world its qualitatively new possibilities. These new possibilities immediately became the property of applied scientists and served mankind.

It is also necessary to pay attention to the fact that all physical revolutions fully corresponded to the provisions of dialectical materialism: they proceeded from objective facts, assumed the independence of nature from the methods of its research, implied the inexhaustibility of matter in depth, all processes and phenomena occurred with uncreated and indestructible matter in Euclidean space and uniformly flowing time.

However, at the beginning of the twentieth century there was a fundamental change in physical methodology. Along with deepening into the structure of matter through the use of ideas about "elementary particles of matter" in physics, and after it practically in the whole natural science, there was a refusal from the methods of classical physics in the study of nature. If classical physics reduced a complex phenomenon to a set of simple components, the essence of the phenomenon was determined by the movement of matter at levels deeper than the phenomenon in question, and the explanation of the essence of the phenomenon was reduced to tracing cause-and-effect relations between the parts of the phenomenon, then theoretical physics, born in the early twentieth century, posed the question in a fundamentally different way.

Quantum mechanics and theory of relativity, and after them all fundamental natural sciences refused to consider internal processes of phenomena. Everything began to be reduced to phenomenology - external description of phenomena and their mathematical description. So-called "postulates" - free assumptions, which, according to the authors of postulates, are supposed to correspond to nature, were massively introduced into practice.

This approach to the study of natural phenomena could not but lead to an increasing divergence of theories from reality, which resulted in the crisis of physics, and with it the whole of natural science.

However, it can be stated that at the present time there is a situation typical for the eve of another revolution in natural science.

By the mid-60s, numerous statistical data had been obtained on the "elementary particles" of matter. It turned out that all "elementary particles" consist of "each of all others", i.e. at transformation of any particle as a result of their collisions any particles can be obtained. On the other hand, there is no information about the internal structure of the "elementary particles" themselves, because as a result of the postulative approach in quantum mechanics and in the theory of relativity, the building material of particles - the ether - the world medium - was thrown out of consideration. It appeared the main obstacle for progressive development of natural science. Further advancement in the depth of matter requires a return to the methodology of classical physics, a return to the concept of ether, which was an obligatory attribute of natural science throughout its history up to the beginning of the twentieth century, which allows to solve this crisis.

Thus, natural science is on the eve of the *sixth revolution*, which will give impetus to a new, extremely powerful development. Today we can only guess about the consequences to which it will lead. Presumably, it may be a complete solution of energy, resource and ecological problems, and possibly health care and much more.

However, it should be noted that, as in all previous revolutions of natural science, the next sixth transition to a new hierarchical level of organization of matter requires revision of the foundations of existing natural science, preservation of everything that corresponds to the new tasks, and rejection of what is superfluous, artificial, not corresponding to the real nature of physical phenomena.

The foregoing shows that the impetus to the development of natural science and the revision of its established ideas is given by the accumulated contradictions, the main of which are the need to solve practical problems arising from social development, or, more precisely, from the needs of social production, and the impossibility to fulfill this within the framework of existing concepts.

The development of natural science occurs in stages. Each stage is connected with mastering of deeper and deeper level of organization of matter, it is the next physical revolution.

ФИЗИЧЕСКИЕ РЕВОЛЮЦИИ

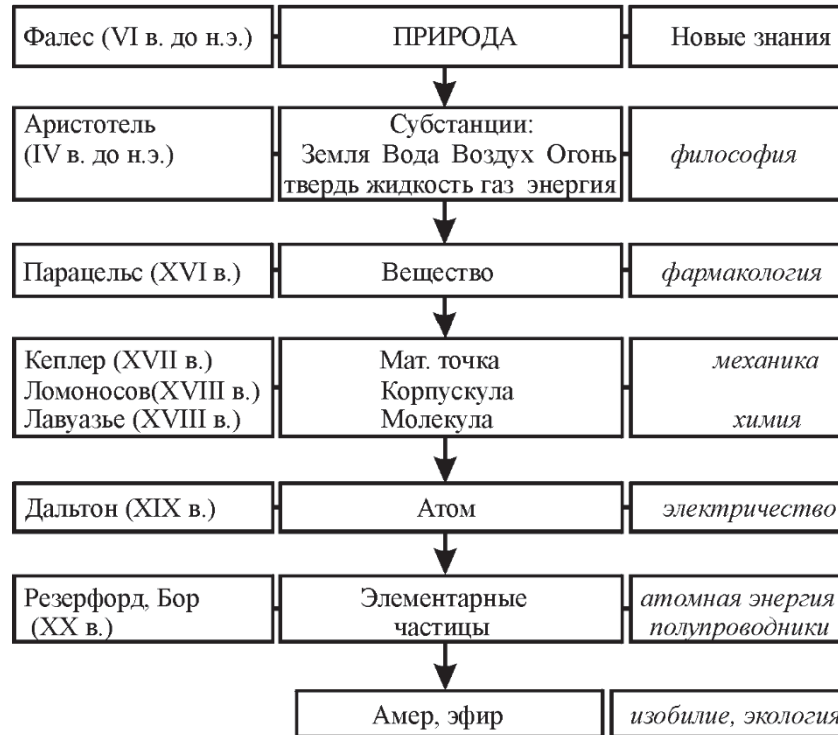

Figure 1.1. Physical revolutions in natural science

Today in science there is a typical situation. Many so-called elementary particles of matter have been obtained in various experiments. All of them are able to transform into each other, which testifies to their common building material. The vacuum is able to, with a certain combination of electromagnetic fields,

"give birth" to elementary particles, which testifies that both vacuum and force fields have the same building material in their basis. And since the vacuum is infinite, it means that the whole world space is filled with this building material. This material has always been called ether in natural science, and it should be called ether.

get. And the element of ether, aka the indivisible element of the atom, was called a'mer in ancient times, and this name must also be assigned to it.

Should we not now, considering that the number of "elementary particles" of matter is already from 200 to 2000 (depending on how one counts), that all of them are capable of changing into each other, apply the same method, accept Lenin's words that "the electron is as inexhaustible as the atom, nature is infinite" [11, p. 277] as a direct instruction to action and allow the existence of even more elementary particles?

the "elementary" particle that makes up all the so-called

The "elementary particles" of matter, which are actually complex entities? Such a particle should be called "a'mer" because that is what Democritus called it. In his opinion, a'mer - a particle of an atom - is a truly indivisible particle of matter, and the aggregate of a'mer is aether, a medium that fills the entire world space and is the building material for all kinds of matter. Thus, it is necessary to return to the question of the existence of ether, its structure and role in nature.

By the end of the 19th century, natural science had largely defined its position. Physics, already then considered the basis of natural science, had also defined its positions. Two insignificant moments remained not quite clear - inconsistency of experimental data with calculated curves in the part of black body radiation and non-detection of ether wind in Michelson's experiments. However, it soon became clear that these inconsistencies gave rise to "a complete scientific catastrophe, the collapse of those provisions that formed the basis of classical physics". The result of the proceedings was a change in the approach to the study of nature, a change in the goals of all natural science.

1.5. On the Meaning of Militant Materialism today

Modern theoretical physics prides itself on its peculiarity, its complexity, its elitism. It is often impossible for a mere mortal to understand what a physical theory states. This allows the physical theory itself to avoid criticism from applied physicists, it also separates it from applied problems and creates conditions for the creation of a special clan of theoretical physicists, to which people from outside are no longer able to join

are allowed. Thus, the problem from a scientific one grows into a social one.

What is the reason of all this? The reason is in the methodology, which physical theory adopted at the beginning of the twentieth century, in the counter-revolution (not a "revolution" at all), which took place then in physics and to which Lenin devoted his famous work "Materialism and Empiriocriticism", in the fact that the main methodological technique in physics was the advancement of postulates.

What is a "postulate"? According to the Great Soviet Encyclopedia (3rd ed., vol. 20, p. 423), a postulate is "a proposition that, for some reason, is 'accepted' without proof but, as a rule, with *justification*, and it is this justification that usually serves as an argument in favor of 'accepting' the postulate. ...sparing no arguments designed to *convince* us of the reasonableness ("validity") of the postulates we propose, we ultimately *simply demand this acceptance...*". That's it, neither more nor less. We demand it, that's all!

And since 1900, when M. Planck put forward the first postulate, physicists have been inventing postulates to which, in their opinion, nature must conform.

Einstein's special theory of relativity is based on five postulates, of which the main one is the declaration of the absence of ether in nature. This postulate is based on a false understanding of the results of the first experiments of Michelson, who allegedly obtained "zero result" when measuring the ether wind, i.e., nothing, which is false. The general theory of relativity of the same author adds to these five postulates five more, and the last one is a categorical statement of the presence of ether in nature [7, p. 689, 8 p. 160].

Quantum mechanics has taken all the postulates of the theory of relativity and added to them nine more, and quantum field theory - four more [2, p. 23-26]. But the total number of postulates that have found a shelter in the physical theory, is counted already many dozens.

And then under the invented and not at all properly substantiated postulates begins to fit the facts, which is the purest idealism, with which Lenin unsuccessfully tried to fight. Theoretical natural science followed the idealistic path, and as a result it led to the modern crisis in natural science.

In recent decades, idealistic ideas about nature of various kinds have been gaining strength in natural science. The question of synthesis of science and religion is officially raised.

Creationist theories about the creation of nature and the establishment of its "wise" laws by a supreme being, God, are being revived.

In other theories, the concept of God is replaced by the so-called The theories that one of the categories - matter, space or time - should be excluded from consideration at all, because "it is possible to do without them". On the other hand, theories appear that one of the categories - matter, space or time - should be excluded from consideration at all, because "we can do without them". Energeticism - attempts to reduce matter to energy, which in fact has long been done in theoretical physics - and physical idealism, according to which nature can be invented and which has long dominated theoretical physics, are revived. However, all this testifies not to the correctness of the idealistic trends, subjective or objective, which are being recalled from oblivion, but to the insufficiency of materialistic philosophy, which has not yet succeeded in creating the appropriate methodological foundations for the development of materialistic science.

The exclusion of the ether as a building material of the microcosm deprived physicists of the possibility to analyze the structures of microobjects, to understand the origin of their properties as the results of the internal motion of matter, made them prefer phenomenology, i.e. external description, to the study of internal mechanisms of phenomena. All this led to a complete misunderstanding by physicists of the structure of material entities

"elementary particles" of matter, atomic nuclei, atoms and their electron shells, as well as interaction fields. This immediately imposed restrictions on the possibilities of studying the real world and spread to all areas of natural science.

The whole problem of the ether should be treated from these positions.

By throwing out of the theory the ether, the medium that fills all world space and is the building material for all kinds of matter, physicists deprived themselves of the possibility to penetrate into the depths of matter, to find out the structure of material formations and the structure of interaction fields. They have fetishized a few postulated mathematical dependencies, declaring that they now know everything. They have been treading on the ground for many years without discovering anything new and increasing the capacity of experimental facilities in the blind hope to get something new at the expense of it. However, nothing new has not arisen for many years, and we can confidently say that it will not arise, because without understanding the internal structures of material formations and internal mechanisms of phenomena, there remains only the method of "scientific poking", which is very unproductive.

By rejecting the ether, physicists have robbed themselves, excluding the very possibility of further penetration into the depths of matter.

The problem of recognizing or denying the existence of the ether in nature goes far beyond the formation of a private physical theory. Recognition of the fact of the existence of the ether as a world medium must essentially and inevitably concern all kinds of material formations, all physical phenomena and processes and, consequently, the whole of natural science. However, to no less extent, the recognition or negation of the ether in nature also concerns the entire philosophical basis of natural science, and through this the entire philosophy of science as a whole. And now it is actually a question of restoration of materialistic positions in physics, and through it in the whole natural science.

Lenin attached great importance to the ideological struggle for the introduction of the ideology of materialism and atheism into the masses. "...We must understand," he wrote, "that without a solid philosophical foundation, no natural science, no materialism can withstand the struggle against the onslaught of bourgeois ideas and the restoration of the bourgeois worldview" [16] [16]. In the emergence of a materialist theory of natural science and the materialist methodology arising from it, the most interested today are the applied scientists, who face the most important tasks, the solution of which directly affects the future of mankind. These are, of course, the problems of energy, ecology, technology, space security, raw material supply, durability of materials, food supply, health care, and much, much more. These problems can be solved only by understanding the objective laws of nature, the structures of material entities at all hierarchical levels of organization of matter, understanding the internal processes of phenomena. Consequently, applicants need a materialistic theory that reflects objective reality, not the inventions of cabinet "scientists". It is through applications that the main front of the struggle between materialism and idealism passes. And there can be no compromise in this struggle, because too much depends on its outcome.

Conclusions

1. The crisis of physics in the late nineteenth and early twentieth centuries was expressed in the failure of physical theory to realize the numerous new experimental data obtained by many researchers in the

at the end of the XIX century. This was due to the dogmatic attitude to the physical theories available at that time, to the idealization of the "well-tested" physical laws obtained by that time and to the lack of understanding of the inner physical essence of phenomena. The leading theoretical physicists of that time found a way out of this situation in the increasing abstraction from reality, in the creation of abstract models, in the prevalence of mathematical models over the physical content, in the postulation of initial positions for the construction of theories. The result of this was temporary successes of physics and at the same time preparation of a new crisis.

2. Modern theoretical physics is in a deep crisis, expressed in its increasing inability to assist applicators in solving urgent technological problems and in the ever-increasing cost of research. The reason for this is the entrenched idealistic ideology, according to which it is allowed to put forward postulates, neglect the factual material, replace the physical essence of phenomena with spatial and temporal distortions, i.e. the rejection of materialistic philosophy and the absolutization of a few "laws", and in fact a few mathematical expressions. Change of methodology of theoretical physics in the direction of idealization, wide application of postulates, axiomatics, fitting of experimental data to fashionable theories is not a "revolution" as it is presented by theoretical physicists and philosophers, but a counter-revolution.

3. Real physical revolutions in natural science have always been the generalization of the accumulated experimental data (induction) on the basis of revealing their general properties and on this basis the transition to a deeper hierarchical level of the organization of matter. Involvement of deep levels of matter allowed to consider the matter of this new for the next stage of natural science level as a building material of material formations of the previous senior level. This resolved the accumulated contradictions and opened new directions of research (deduction).

4. The way out of this impasse is possible only through a return to materialist ideology. The goal of natural science as a science of nature should be the understanding of cause-and-effect relations between material objects and phenomena. The means for this is the dynamic method, which implies the presence of structures in any material objects and internal mechanisms in any phenomena, thereby recognizing the inexhaustibility of matter in depth

and the fundamental possibility of understanding the internal mechanisms of any interactions and phenomena.

5. Nowadays, there is a necessity of transition to the next level of matter organization after "elementary particles". This transition is a transition to the recognition of the existence in nature of the ether, a medium that fills the entire world space, is a building material for all kinds of material formations, the movements of which are manifested in the form of various interactions of material structures and physical phenomena.

6. As always in a crisis situation, the ideological struggle in theory between materialism and idealism is unfolding. The materialistic direction is supported and developed by those who face actual applied problems, the idealistic direction is associated with attempts to preserve the positions of outdated theories that are not able to help applicants in solving practical problems. However, as always, the idealistic direction is doomed to defeat. Natural science is on the eve of the next physical revolution, which is inevitable.

Chapter 2. A brief history of ether

The unified ether permeates the entire universe.
Ancient Chinese Taoism.

2.1. A brief overview of theories and models ether

The necessity of a critical examination of the numerous pre-existing hypotheses, models and theories of the ether arises from the fact that, despite the correct initial premise that the interaction between bodies must be conditioned by some intermediate medium - the ether, none of the theories of the ether has been able to satisfactorily explain the totality of all known phenomena, on the one hand, and has not allowed to predict any new directions of research, on the other. As a result, not only these theories, models and hypotheses were discarded in the course of the development of physics, but also the very concept of the ether as a "utterly discredited."

Let us consider the main concepts of the ether that existed in natural science and try to analyze their positive sides and disadvantages.

Despite the fact that a number of researchers of the history of the ether and the development of physical concepts attribute the introduction of the idea of the ether into natural science to René Descartes (1596-1650), and the idea of atomism to Democritus (470-380 BC), it should be considered that both the concept of the ether as a world medium and the concept of atoms - the elements of matter - were known long before that and accompanied almost the entire known history of human civilization.

First of all, it should be noted that all religions of the world in one form or another recognized the existence of some invisible supernatural sacred Power underlying all the existing world. Belief in the reality of such a power, the desire to cognize it and find a connection with this mysterious and omnipresent force is one of the most important aspects of any religion [1].

Alexander Men, a contemporary Christian theologian, describes this unknown force in the following way [2]:

"...The Algonquin Indians under the name of Manitou honor the supra-worldly force. We find ideas of it in the Malayan inhabitants. This power has a certain supernatural character. It is called Mana. In Papuans this mysterious force is called Onim.

According to the Australian Aborigines, there is a certain Wangarr - an eternal irresistible impersonal force that manifests itself in the days of creation and continues to have a fruitful influence on life to this day. With the American peoples, too, we find the notion of Mana. In the inhabitants of the Western Sudan her name is Nyala, in the Pygmies - Megbe, in the Zulus - Umoya, in the Ugandans - Jok, in the northern Congolese - Elima. The North American Indians have very interesting and deep in meaning ideas about the Supreme Beginning. "The religious beliefs of the Dakotas," writes one researcher, "are not in deities, as such, but in a mysterious unrecognizable Something, of which they are incarnations. The greatest object of worship is Taku Wakan, who is supernatural and mysterious. This power, called Orenda by the Iroquois and Wangarr by the Yulengors, pervades the whole of nature".

This is echoed in many peoples' idea of the Mother Goddess, who gives birth to all living things.

With the Egyptians, Atum is the god of eternity, everything and nothing. He existed when there was nothing but chaos, and will exist in the same praoccean after the world has completed its destined path. Atum contains all things. In many peoples, chaos was the foundation of the world, from which everything was reborn.

Hesiod, the famous ancient Greek poet, in his poem "Theogony" describes the creation of the world by the gods as a process of overcoming the chaos of immobility; from the gods came the ether - the upper radiant layer of air. This picture has its source in Eastern cosmogonic schemes.

There is every reason to believe that at least in the VI-IV centuries B.C., and most likely much earlier, the ideas of ether were widespread enough [3]. Thus, the main ancient Indian teachings - Jainism, Lokayata, Vaisheshika, Nyaya, etc., such religions as Brahmanism and Buddhism, originally contained the doctrine of ether (akasha) as a single, eternal and all-permeable physical substance, which is not directly perceived by the senses. The ether is one and eternal. Matter in general (pudgala) consists of tiny particles (anu) forming atoms (paramana), which possess mobility (dharma). All events take place in space and time.

Prakriti, matter in the sankhya doctrine created by the sage Kanada (Gluka), is the unoriginated root cause of all things. It is eternal and omnipresent. It is the most subtle, mysterious and immense force,

periodically creating and destroying worlds. Its elements (gunas) simple, indivisible and eternal.

Jainists believe that their teachings were transmitted to them by 24 teachers. The last, Vardhamana, lived in the 6th century B.C., his predecessor Parshvanatha in the 9th century B.C., and the rest in prehistoric times.

In ancient Chinese Taoism (4th century B.C.) in the canon "Tao De Jing" and treatises "Zhuang-tzu" and "Lao-tzu" it is indicated that everything in the world consists of particles of coarse "tsu" and subtle "jing". They form a single "chi" - ether, primordial, one for all things. "The unified ether permeates the entire universe. It consists of "yin" (material) and "yang" (fire, energy). There is not a single thing that is not related to the other, and yin and yang manifest everywhere" [4].

In ancient Japan, philosophers believed that space was filled with mukyoku, an infinite universal supernatural force, devoid of qualities and forms, inaccessible to human perception. The mystical absolute of takyoku is the nature of the ideal primordial "ri" connected with the material primordial "ki". "Ri" is energy, which is eternally connected with "ki" - matter and does not exist without it.

There is every reason to suppose that all world religions - Buddhism, Christianity, Confucianism, Shintoism, Hinduism, Judaism, etc. - at an early stage borrowed materialistic ideas of ancient aetherdynamics and at a later stage of development emasculated the doctrine, abandoning materialism in favor of mysticism. - in one form or another at an early stage borrowed materialistic ideas of ancient ether-dynamics, and at a later stage of development emasculated the doctrine, abandoning materialism in favor of mysticism to please the ruling classes that came to power. In Ancient Greece it happened, most likely, after the revolution of VII-VI centuries BC, which put an end to the patrimonial system and led to the victory of slavery.

However, advanced thinkers tried to preserve ancient materialistic knowledge. Thales of Miletus (625-547 B.C.), an ancient Greek philosopher, the founder of ancient and European philosophy and science in general, the founder of the Miletian school of philosophy, raised the question of the necessity of reducing the diversity of phenomena and things to a single basis (the primary or original), which he considered to be liquid ("wet nature") [5-8].

Anaximander (610-546 B.C.), a student of Thales, introduced into philosophy the concept of the primordial, "apeiron," a single eternal indefinite matter that gives rise to an infinite variety of things.

Anaximenes (585-525 B.C.), a disciple of Anaximander, considered this original to be gas ("air"), through the condensation and rarefaction of which all things arise.

The development of the ideas of the "original" was made by Leucippus (V century BC), who put forward the idea of emptiness, dividing all things into many elements, the properties of which depend on their size and form of motion, and further - a student of Leucippus Democritus, whom European science considers the founder of atomism.

According to a number of testimonies, Democritus first learned from the Chaldeans and magicians sent to his father's house, and then in the country of Midian when visiting magicians. Democritus himself did not attribute the authorship of atomism to himself, mentioning that atomism was borrowed by him from the Midians, in particular from the Magi, a priestly caste (tribe, according to Herodotus), one of the six tribes that inhabited Midia (northwestern regions of the Iranian Plateau).

The dominant idea of the magi (mighty) was inner greatness and power, the power of wisdom and knowledge. According to a number of evidences, magicians borrowed their knowledge from the Chaldeans, who were considered to be the founders of stargazing and astronomy. Chaldeans, to whom in ancient Greece and ancient Rome was given great importance, were priests - fortune-tellers, and also naturalists, mathematicians, theosophists. Magicians founded the doctrine - magic, which allowed on the basis of knowledge of secrets of nature to produce extraordinary phenomena. Later this doctrine, unfortunately, was discredited by numerous pseudo-magicians - charlatans.

The most detailed atomism of antiquity is reflected in the works of Democritus, to which many literary studies are devoted. It should be noted, however, that some provisions of Democritus' atomism have remained misunderstood until now by almost all researchers of his work. First of all, we are talking about the relationship between atoms and parts of atoms - amers.

Democritus pointed out that atoms ($\alpha\tau\omicron\mu\omicron\varsigma$), the elements of matter, are physically indivisible, not cut by virtue of their density and lack of emptiness. Atoms are endowed with many properties of the bodies of the visible world: curvature, hookedness, pyramidality, etc. In their infinite variety in form, size, and order, atoms form the entire contents of the real world. At the heart of these varying in size and shape, however, atoms are amers ($\alpha\mu\epsilon\rho\eta\zeta$) - truly indivisible, devoid of parts.

The idea of two kinds of atoms was also mentioned by later explorers, such as Epicurus (342-271 BC).

Amers (according to Democritus) or "elements" (according to Epicurus), being parts of atoms, have properties quite different from those of atoms. For example, while atoms have gravity, amers are completely devoid of this property.

The complete misunderstanding for many centuries of this seeming contradiction has led to a significant distortion of the interpretation of the teachings of Democritus. Already Alexander of Aphrodisias reproached Leucippus and Democritus for the fact that the indivisible, which have no parts, comprehended by the mind in atoms and are their parts, are weightless. This misunderstanding continues in our time. Thus, S.Y.Lurie mentions ameres as mathematical quantities. M.D.Akhundov continues to interpret amers as an abstract mathematical concept [9].

The mentioned seeming contradiction is based on the idea that weight (gravity) is an innate property of any matter. Meanwhile, gravitation can be explained as a result of motion and interaction (collisions) of amers. Then an atom as a set of amers, surrounded by amers, can experience attraction from other atoms due to energy impulses transmitted by amers in different ways, depending on which side of the atom there are other atoms, which creates the effect of mutual attraction of atoms. In fact, there is not attraction, but pushing of an atom to other atoms by the amers of the medium. The amers, being carriers of kinetic energy, will not possess any gravity themselves. Consequently, if we suppose gravitation to be a consequence of the manifestation of the motion of the aggregate of amers, and not an innate property of matter (a phenomenon peculiar to the complex and not belonging to its parts), the contradiction is easily solved. The whole aggregate of amers, moving in the void, is a common world medium, apeiron, according to Anaximander, in later Russian - ether.

Later, the Roman poet and materialist philosopher Titus Lucretius Carus (1st century B.C.) in his philosophical poem "On the Nature of Things" set forth in poetic form the materialist ideas of Democritus and Epicurus about the structure of nature. The elements of the ether were called "primordials", and it is from them that all objects consist, and the ether as a whole practically had the properties of a gas, because "...The primordials of things in the void of the immense mumble" [10] [10].

Thus, the ether has a rather ancient history, going back to the very beginnings of the known history of cultured humanity.

René Descartes (1596-1650), in considerably later times, reopened the question of the existence of matter solidly filling the

and responsible for the transport of light waves. Descartes explained the formation of matter in general and planets in particular by the property of vortices of the ether, consisting of many round particles. In some of his works [11] Descartes tried to construct mechanical models of physical phenomena, sometimes contradictory. However, the main distinctive feature of Descartes' works is that he tried to find the inner mechanism of physical phenomena.

Isaac Newton (1643-1727) changed his point of view several times regarding the structure of the ether, as well as the fact of its existence [12-14]. However, in the end Newton expressed himself quite definitely and in his last works he improved and developed his views on the ether, but did not change them cardinally. Newton considered it possible to "deduce from the principles of mechanics and all other phenomena of nature," believing that "all these phenomena are conditioned and some forces with which the particles of bodies due to causes, still unknown, or aspire to each other and interlock in the correct figures, or mutually repelled and removed from each other. In "Optics or a treatise on Reflections, Refractions, Bends and Colors of Light" [12] Newton develops, in particular, the idea of the possibility of transformation of light into matter and vice versa.

In a letter to R. Boyle on February 28, 1679, Newton clarifies his ideas about the ether in five sentences.

1. It is assumed that there is an etheric substance scattered throughout space, capable of contraction and expansion and extremely elastic, "in a word," says Newton, "similar in every respect to air, but only considerably finer.

2. The ether is supposed to penetrate all bodies, but it is rarer in the pores of bodies than in free space, and the rarer the thinner the pores.

3. It is assumed that the rarefied ether inside bodies and the denser ether outside them pass into each other gradually and are not confined to sharp mathematical surfaces.

4. It is supposed that when two bodies approach each other, the ether between them becomes rarer than before, and a region of gradual rarefaction extends from the surface of one body to the surface of the other.

"The reason for this is," Newton writes, "that in the narrow space between bodies the ether can no longer move and travel back and forth so freely.

5. "It follows from the fourth proposition that when bodies come close together, and when the ether between them is rarefied at close proximity, there must appear a resistance to this and a desire of the bodies to move away from each other. Such resistance and endeavor to separate will increase at the

But finally, when the bodies come so close together that the excess of pressure of the external ether surrounding the bodies over the rarefied ether between the bodies becomes so great that it prevents the resistance of the bodies to approach, the excess of pressure will force the bodies to forcefully approach each other and to adhere very closely to each other.

It should be noted that Newton anticipated a lot of things at the qualitative level in determining the properties of the ether, although he confused the density of the ether (rarefaction) with the pressure in it.

In 1717, in the 75th year of his life, in the second English edition of the "Optics" Newton, in the form of questions and answers, sets forth his view of the ether. Thus, the gradient of the density of the ether as it passes from body to space is applied to explain gravitation, the ether being implied to be composed of individual particles. "This increase of density," Newton writes, "may be extremely slow at great distances; but if the elastic force of this medium is extremely great, this increase may be sufficient to rush bodies from the denser parts of the medium to the more rarefied ones with all the force which we call gravitation.

Newton again raises the question of the atomistic structure of the ether:

"If anyone supposes that the ether (like our air) may perhaps contain particles which tend to repel one from another (I do not know what this ether is), that its particles are extremely small in comparison with those of air and even of light, the extreme smallness of these particles may contribute to the magnitude of the force by which the particles repel one another, making the medium extremely rarefied and elastic in comparison with air, and consequently in a negligible degree capable of resisting the motion of thrown bodies and extremely capable of

Thus, Newton himself pointed out the possibility of circumventing the difficulty arising from the resistance of the ether to the motion of celestial bodies.

"If this ether be supposed 700,000 times more elastic than our air, and more than 700,000 times more rarefied, its resistance will be 600,000,000 times less than that of water. Such a small resistance would scarcely produce any appreciable change in the motions of the planets in ten thousand years."

In the same work, Newton asks whether vision is not the result of aether vibrations in the retina and nerves.

Michael Faraday (1791-1867), convinced of the existence of the ether ("world ether"), represented it as a set of force lines. Faraday categorically denied the possibility of action at a distance ("actio in distance") through the void, a point of view held by many physicists of the time. However, Faraday did not reveal the nature and the principle of force lines [15-17].

James Clerk Maxwell (1831-1879) in his works, among which one should first of all note [18-22], draws a conclusion about the propagation of perturbations from point to point in the world ether.

"Indeed," writes Maxwell, "if at all energy is transmitted from one body to another, not instantaneously, but in a finite time, there must exist a medium in which it temporarily resides, leaving the first body and not reaching the second. These theories must therefore lead to the notion of a medium in which this propagation takes place."

Adopting completely Faraday's point of view, Maxwell, like Faraday, does not give any model of the ether and confines himself to a general idea of "force lines". It should, however, still be pointed out that in [21] Maxwell mentions the ether as a liquid and derives his famous equations in [20, 22], relying on the ideas of Helmholtz, Rankin and other hydromechanists about the motion of vortices in an ideal liquid medium.

During the XIX century, several models of the ether were put forward. A considerable part of them did not answer the question about the structure of the ether and the nature of interactions. The authors of these theories tried to attribute to the ether those or other properties with the help of which one could expect at least a fundamental explanation of some phenomena [23-26].

Thus, to explain the annual aberration of starlight, discovered by Bradley in 1728 and reaching 20.5", Fresnel in 1818 for the first time in a letter to Arago expressed the idea of a fixed ether [27-29], which was later substantially developed and supplemented by Lorentz. [31-33].

According to Fresnel's idea, the ether is a continuous elastic medium in which there is a substance of particles of atoms, in general, in no way connected with this medium. The role of the ether is the transmission of mechanical vibrations and waves. In explaining the aberration Fresnel first proceeded from the simple addition of the velocities of the Earth and light. However, some experiments, in particular, the experiment of Arago (1818-1819) on the interference of polarized beams of light and the experiment of Voskovich-Eré with a telescope filled with water, showed that the additional deviations of light, which should be, if the aberration of the Earth and the Earth's velocity is not aberrant, are the same as the aberration of light.

if the ether remained stationary, no. To save the hypothesis, Fresnel proposed to introduce a coefficient of entrainment of light by the medium

$$k = 1 - 1/n^2,$$

where n is the optical refractive index of the medium.

The explanation is reduced to the fact that the moving medium with its atoms tries to entrain light, while the ether, remaining stationary, prevents it. Fresnel himself also did not try to reveal the reason for the entrainment of the ether by this medium. As it turns out, there are three independent physical substances: separately ether, separately optical medium and, finally, separately light with complete obscurity of their physical interaction.

The Fresnel-Lorentz theory, however, contradicts the initial idea of the ether as a carrier of interactions. In fact, if the ether does not take any part in the motion of matter, then matter cannot interact with the ether. Consequently, the ether cannot transfer to the substance the energy of its motion. There is a logical contradiction arising from the absence of a qualitative picture of the structure of the ether and the mechanism of its interaction with matter.

Stokes in 1845 suggested the idea of the entrainment of the surrounding aether by the Earth [28]. More detailed calculations have shown, however, that accepting Stokes' idea without any reservations means that there must be an aether velocity potential in the entire space surrounding the Earth. "In order to circumvent this difficulty," writes Lorenz [33, 34], "one could use the fact that the existence of a velocity potential is not necessary in the whole space surrounding the Earth, since we are dealing only with a limited region. However, this assumption would lead us to very artificial and unlikely constructions." Thus, the idea of Stokes did not find further development due to the complexity of the construction, although it certainly contained a rational grain. In addition, Stokes did not make any assumptions about the nature of interaction of the ether with the Earth and the nature of the ether itself.

Planck showed that the difficulties in Stokes' hypothesis could be avoided by assuming that the ether could be compressed and that it was influenced by gravity. No suggestion was made by Planck as to the possible causes of this influence. In his speeches Planck showed that this assumption points to a substantial condensation of the ether in the field of gravity. Near the Earth this condensation compared with open space is

60000, near the Sun - even 28 times more. Planck's hypothesis was not further developed.

Fizeau's experiment of light entrainment by a moving medium (water), conducted by him in 1851. [35] and repeated by Zeeman in 1914-1915. [36], numerically corresponded to the Fresnel entrainment coefficient. It should be noted, however, that, although taking into account the entrainment coefficient allowed, in Fizeau's opinion, to obtain a good match between theory and experience, the statistics necessary for such a statement was not collected, many circumstances accompanying the experiment were not taken into account, and on the basis of these experiments, at best, we can speak only of a qualitative confirmation of Fresnel's idea, although even this can be doubted. Despite the fact that numerically the Fresnel entrainment coefficient is calculated with high accuracy for many substances, in fact, the experimental verification of its value has not been carried out by anyone else, and this coefficient itself is not used in any physical device

Hertz proposed the idea of a complete capture of the ether by matter [37,38]. Hertz's hypothesis, however, is in contradiction with Fizeau's experiment, since this experiment has shown only partial capture of the ether by matter.

Ritz, by introducing the reduced time into Maxwell's equations and essentially returning to Lorentz's hypothesis, obtained a satisfactory coincidence of Maxwell's equations with the results of optical experiments. As a result, the "ballistic hypothesis" of Ritz [39] was born, from which it followed that a moving light source emits light with a velocity equal in absolute coordinates to the geometric sum of the velocities of light in vacuum and the velocity of the source. In his reasoning Ritz operates only with mathematical calculations and, like Lorentz, does not indicate the nature of the connections between matter and ether, does not consider the nature of light and the structure of the ether. Such a statement, being infinitely common, leads to the position that for double stars there must be moments when a star moving towards the earth must appear to be moving backwards. The observations of De Sitter (1913) [40] showed that there is no such phenomenon.

Thus, the listed hypotheses, models and theories of the ether, which appeared in the XIX century, firstly, considered the ether as a continuous homogeneous medium with constant properties identical for all points of space and any physical conditions, and secondly, did not make any assumptions either about the structure of the ether or about the nature of interactions between matter and the ether. Such a position led to

to the impossibility within the framework of these theories, which actually rely on any one particular property of the ether, to satisfy the whole variety of known phenomena. The Fresnel theory, which made the speed of light depend on the properties of the medium in which light propagates, is a certain exception. Fresnel's theory was further developed in the works of Einstein.

In parallel with the descriptive concepts of the ether, some hypotheses were developed that tried to find the structure of the ether. These hypotheses were called "mechanical" because they operate with mechanical concepts - displacements and forces.

As already mentioned, the first mechanical models of the ether were proposed by René Descartes and Isaac Newton. Some mechanical theories and models of the ether were developed in the 18th and 19th centuries and later.

The theory of J.L. Lesage, designed to explain the essence of gravitation, is of certain interest. According to Lesage [41, 42], the ether is something similar to gas, with the essential difference that the ether particles practically do not interact with each other, colliding extremely rarely. Weighty matter absorbs particles, so bodies shield the aether particle streams. This leads to the fact that the second body experiences unequal from different sides pushing from the aether particles and begins to aspire to the first body. Lesage's theory did not meet the proper understanding at the moment of its appearance, but a hundred years later it received much attention from Prévost [43], Schramm [44, 45], W. Thomson [46], and Tath [47].

The theory of the ether as an elastic medium was proposed by Navier (1824), Poisson (1828), and Cauchy (1830) [23]. Navier considered the ether as an incompressible fluid possessing viscosity. The viscosity of the ether was considered by him as the cause of interactions between particles of matter and the ether, as well as between the ether and particles of matter, hence, particles of matter among themselves through the ether.

Cauchy considered the ether as a continuous medium and operated with stresses and deformations in each point of space. In works on optics Cauchy gave mathematical development of Fresnel theory and dispersion theory. Later it became clear that this explanation actually leads to the interpretation of the magnetic field as the displacement of aether particles, which contradicted the fact of dielectric displacement.

In his works Neumann [48, 49] proceeded from the assumption of constancy of the aether density in all media. Considering the ether as an elastic medium, Neumann analyzed the processes of light polarization.

Green considered the ether [50] as a continuous elastic medium, on the basis of which, based on the law of conservation of energy applied to a deformed elastic body, he considered the reflection and refraction of light in crystalline media. In the above mechanical models the nature of the ether and the reasons that the ether behaves as an elastic body were not elucidated.

In the mathematical works of McCullagh (1809-1847) [51], in which a geometrical study of the surface of a light wave was carried out, the aether was considered as a medium in which the potential function is a quadratic function of rotation angles. McCullagh's aether is continuous. Although McCullagh's theory is a theory of an elastic medium, and there is no mention of any electromagnetism in it, the equations he derived, as Lorentz notes, are essentially the same as those of Maxwell's electromagnetic theory. A comparison with other theories of the elastic ether shows that the essential positive feature of McCullagh's theory lies precisely in the presence of the concept of vortex motion. According to Van Guerin's expression, the McCullagh theory is a vortex theory of the aether.

W. Thomson (Lord Kelvin, 1824-1907) proposed several models of the ether [52-58]. First, Kelvin tried to improve the McCullagh ether model, then he proposed a model of quasi-labile ether - a homogeneous isotropic medium in which vortices are present. The disadvantage of the model turned out to be the instability of the aether equilibrium, since the potential energy in this model has no minimum anywhere. The model of quasi-labile aether requires fixing of boundary conditions, which contradicts the ideas about the limitless and boundless space of the Universe.

Kelvin hypothesized the velocity of the ether as a magnetic flux and the velocity of rotation of the ether as a value of dielectric displacement. These hypotheses were not properly developed due to mathematical difficulties. Further developments led Kelvin to construct a model of the aether from solid and liquid gyrostats (gyroscopes) to obtain a system resisting only the deformations associated with rotation. Kelvin showed that in this case the resulting equations coincide with the equations of electrodynamics. Such a model also makes it possible to explain the propagation of light waves. In addition, Kelvin tried to consider the ether as a fluid in turbulent motion; he showed that turbulent motion is accompanied by oscillatory motion.

The theory was further developed in Kelvin's paper "On Vortex Atoms" (1867) [55], where the ether is presented as a perfect incompressible frictionless fluid. Kelvin showed that atoms are Helmholtz toroidal rings. This idea was somewhat earlier put forward by Runnig in "On Molecular Vortices" (1849- 1850), where the author considered some of the simplest interactions. A possible mechanism of interaction between ether and matter was considered by Larmor [59].

The school of J. J. Thomson (1856-1940) continued this line. In the works "Electricity and Matter", "Matter and Ether", "The Structure of Light", "Faraday's Force Tubes and Maxwell's Equations" and others. [60- 64] J.J.Thomson consistently developed the vortex theory of matter and interactions. He showed that under known simple assumptions, the expression of the quantum vortex ring coincides with the expression of Planck's law $E = h\nu$. Thomson, on the basis of the vortex theory of the ether, showed that $E = mc^2$. The authorship of this formula is attributed to Einstein, although J.J.Thomson obtained it in 1903 long before Einstein, and, most importantly, from completely different assumptions than Einstein, based, in particular, on the presence of the aether in nature.

J.J.Thomson created a very slender theory, set forth in a number of works published from 1880 to 1928. The only, perhaps, drawback of this theory is the idealization of the properties of the ether, the idea of it as a continuous ideal incompressible fluid, which led this theory to some significant contradictions.

Thus, W.Thomson (Lord Kelvin) and J.J.Thomson considered a single matter - ether, and its different manifestations were conditioned by different forms of its kinetic motion.

It is interesting to note that the vortex theories of the ether did not pass the attention of Engels. In the section "Electricity" (Dialectics of Nature) [65, p. 97] he writes: "Electricity is a movement of ether particles, and the molecules of the body take part in this movement. Different theories portray the nature of this motion in different ways. The theories of Maxwell, Hankel, and Renard, drawing on the latest research on vortex motions, see it, each in its own way, also as a vortex motion. And thus the vortices of old Descartes again find a place of honor in all new fields of knowledge." "The Aether Theory," as Engels puts it, "gives hope of finding out *what is* the actual material substratum of electrical motion, *what is* the actual thing that causes electrical phenomena by its motions." Here it is also interesting that Engels paid much attention to the following

to elucidate the physical essence of a phenomenon, not just a descriptive abstraction.

A number of theories of the ether were created in Russia. The ideas of Euler (1707-1783) about the properties of the world ether [66-68] influenced Riemann (1826- 1866), who in his lecture "On the Hypotheses Underlying the Foundations of Geometry" (1854) outlined the concept of world space, resolving some of the difficulties encountered by Euler.

M.V.Lomonosov (1711-1765) rejected all specific types of matter - heat, light, recognized only ether, with the help of which he, in particular, explained gravitation as a result of pushing the planets by ether particles due to the pressure difference [69-75]. This idea of Lomonosov was expressed earlier than the similar idea of Lesage, almost forty years earlier.

D.I.Mendeleev's attempt to determine the chemical properties of ether was of great interest [76]. Extensive research on the elasticity of gases at very low pressures was conducted by D.I.Mendeleev in order to experimentally approach the ether. "Already in the 70-ies, - writes Mendeleev, - I persistently got the question: what is the ether in the chemical sense? At first I believed that the ether is the sum of rarefied gases in the limit state. I made experiments at low pressures to get a hint of the answer." "It seems to me conceivable that the world ether is not a perfectly homogeneous gas, but a mixture of several gases close to the limit state, i.e., it is composed like our earthly atmosphere of a mixture of several gases"

Mendeleev included ether in the table of chemical elements in the "zero" line and called "newtonium", this line was later removed from the table.

I.O. Yarkovsky [77] proposed in the 70s of the XIX century the theory of gas-like ether. In his opinion, the aether elements had the innate property of mutually braking each other at collision, and at elimination of an obstacle to continue their motion in the same way as it was before stopping. The nature of such behavior of ether particles was not considered by Yarkovsky. Relying on the idea of the ether as a gas-like medium, Yarkovsky considered some physical phenomena, in particular, made an attempt to create a model of gravitation. In the 1920s, the model of gas-like aether was considered by P.A. Piotrovsky, but only at the level of a qualitative model of some individual phenomena, mainly gravitation.

In later times, when the theory of relativity was already widely known, some Soviet and foreign scientists defended the mechanical theory of the aether, becoming at the same time on the point of the

from the viewpoint of the vortex model. Among these works, it is necessary to note the works of K.E. Tsiolkovsky [78], Z.A. Tseytlin [79, 80], which are mainly of a review nature, the works of Whiteaker [81], N.P. Kasterin [82], V.F. Mitkevich [83-85], and others.

Kasterin [82] shows the analogy between vortex motions of air flows and electromagnetic phenomena and points out the insufficiency of Euler's mathematical conclusions concerning vortex motions, since Euler's conclusions were based on the idea of a continuous medium, while gas consists of individual particles and is not continuous. Kasterin clarified both the equations of aerodynamics mainly with respect to vortex motions and the electromagnetic field equation, and showed their deep analogy.

In the works of the Soviet academician V.F.Mitkevich "Works of W.Thomson" (1930), "Basic views of modern physics" (1933), "Basic physical views" (1934) [81-83] and others not only advocates the necessity of recognizing the fact of the existence of the ether, but also proposes a model in which the ideas of J.J.Thomson are actually embedded, which Mitkevich explicitly says.

Mitkevich advocated a mechanical view of the aether. In one of his works he considered "a ring electron, which can be calculated as an elementary magnetic vortex moving along a rigid orbit and accommodated in the volume normally assigned to the electron". Mitkevich considered "a closed magnetic line detached from the source and shrinking as the energy is given away" and pointed out the similarity of the magnetic flux to Helmholtz vortices. However, the main thing in Mitkevich's works was not this model, which was rather imperfect, but the belief in the existence of the ether.

In "Basic Physical Views," Mitkiewicz writes:

"Absolutely empty space, devoid of any physical content, cannot serve as an arena for the propagation of any waves whatsoever... The recognition of an ether in which mechanical motions can take place, i.e., spatial displacements of elementary volumes of this prime matter continuously filling our entire three-dimensional space, is not in itself a sign of a mechanistic point of view... It is necessary, finally, to rehabilitate "mechanical motion" quite definitely, properly modernizing, of course, the content of this ter

The struggle against the erroneous scientific and philosophical attitude, which is called the mechanistic point of view, should not be replaced in modern physics by a completely unjustified persecution of legitimate attempts to consider those mechanical motions, which undoubtedly constitute the basis of the structure of any physical process, although in no way exhausting in themselves. It is necessary, at last, to stop identifying the terms "mechanical" and "mechanistic" as is unfortunately often the case in contemporary scientific, philosophical and physical literature."

The papers [23-26, 79, 80, 89-91, 92-96] give reviews on the history of development of ether concepts and modern views on the nature of the "physical vacuum".

Along with the development of theories and models of the ether, the view that there is no ether as such in nature was developed.

In 1910 in the work "The principle of relativity and its consequences", Einstein wrote that "it is impossible to create a satisfactory theory without denying the existence of some medium that fills all space. Later, in the works "The Ether and the Theory of Relativity" (1920) and "On the Ether" (1924), Einstein changed his point of view regarding the existence of the ether, but this fact is little known, and it did not affect the attitude to the ether on the part of most theoretical physicists.

Academician Ya.I.Frenkel categorically denied the existence of the world ether, comparing the search for the properties of the ether with "god-seeking and god-building" [89] and defended the principle of long-range action. [89], and defended the principle of long-range action. At present the ideas related to "action at a distance" continue to develop, but along with this, in many works the idea of "physical vacuum", "vacuum liquid", etc. is more and more often used, which actually restores the ideas about the world medium under another name. A number of vacuum effects - the zero-point energy level of fields, virtual states of particles, polarization of vacuum, etc. - have been found, which forces to abandon the ideas about vacuum as a void and to raise again the question about its structure [90, 91].

The discussion described above is actually a dispute about whether it is necessary to search for the material basis of the internal mechanism of phenomena or whether it is enough to find a suitable mathematical apparatus for the external one.

to describe phenomena. This is a dispute between dynamics and phenomenology. But for the dynamic approach, the phenomenon is the result of the inner mechanism, the hidden forms of motion of matter, and the external description is just a consequence of this mechanism. Understanding the reasons why a physical phenomenon is the way it is, allows us to take into account many aspects that escape the attention of a researcher who limits himself to phenomenology, to its external description.

2.2. Disadvantages of known hypotheses, theories and models ether

Despite the abundance and variety of various hypotheses, models and theories of the ether, their authors failed to create any complete and consistent picture of the world, covering at least the basic forms of matter and types of interactions. All these hypotheses and models are characterized by some or other fundamental shortcomings that did not allow them to develop. And the main reason for these shortcomings is methodological.

The main drawbacks were three.

The first disadvantage was that all hypotheses, models and theories of the ether, from the very first to the last, considered a certain narrow range of phenomena without affecting the rest. The models of Descartes and Newton, of course, could not take into account electromagnetic phenomena, much less intraatomic interactions. The works of Faraday, Maxwell, Lorentz, Hertz and other researchers did not take into account gravitation and did not consider the structure of matter. In their works Stokes and Fresnel tried to explain actually only the phenomena of aberration. In the mechanical models of Navier, McCullagh and further V. Thomson and J. Thomson considered mainly the range of electromagnetic phenomena, however, V. Thomson and J. Thomson tried to penetrate to some extent into the essence of the structure of matter.

Thus, no theory of the ether has attempted to answer either the questions of the structure of matter or the basic kinds of interactions, thus disconnecting them from each other.

The second major drawback of practically all theories and models of the ether without exception, except the models of Newton and Lesage, is that the ether was considered as a continuous medium. Furthermore, most authors have treated the ether as an ideal fluid or an ideal solid. Such metaphysical idealization of properties

The ether, admissible for some physical conditions or phenomena, extended automatically to all conceivable physical conditions and phenomena, which inevitably led to contradictions.

The third disadvantage of many theories, except for the last ones of W. Thomson and J. Thomson, is the separation of the matter of matter of atoms and particles from the matter of ether. The ether appears as an independent substance, perceiving energy from the particles of matter in a completely incomprehensible way and transmitting energy to the particles of matter. In the works of Fresnel and Lorentz there are three actually independent substances: matter, independent of ether; ether, freely penetrating through matter, and light, incomprehensibly created by matter, transmitted by matter to ether and again perceived by matter without any disclosure of the mechanism of all these transmissions and transformations.

Although the authors of the above hypotheses, models and theories of the ether asserted correctly the very fact of existence of the medium - the carrier of energy of interactions and the basis of the structure of matter, the above drawbacks made it practically impossible to use these theories and their development within the framework of the initial assumptions.

However, the main drawback of all theories and models of the ether was the actual postulation of its properties. Practically nobody ever put forward any philosophical or methodological bases for determination of physical parameters of the ether. In this respect the determination of the ether parameters had the same postulative character as the statement about its absence in the nature. The physical properties of the ether were not determined from the known experimental data, which were obviously insufficient in those times, but were postulated based on the tastes of each author of the concept. But they all agreed that the ether was something ideal and absolute, such as an ideal liquid. The aether had the property of all-penetration, and the mechanism of this all-penetration was not substantiated in any way. The idea that when penetrating through a substance the ether flow could be slowed down due to viscosity or other reasons was never even discussed.

The Fresnel ether, as well as the Lorentz ether, is an absolutely stationary ether. Hertz's ether has the property of being absolutely trapped by a moving body. Maxwell's aether is a perfect fluid in which Helmholtz's laws of vortices apply. Maxwell did not pay attention to the fact that, according to Helmholtz, vortices, and Maxwell's magnetic field are vortex formations of the ether, they can neither

to form or disappear in an ideal fluid, which is clearly contradicted by experiments. Thus, the idealization of the properties of the ether immediately dooms all such theories to contradictions and to defeat.

The fact that such idealization of the ether was adopted by many authors of various concepts of the ether is methodologically understandable, since the data for more or less correct determination of the properties of the ether did not exist at that time: natural science had not accumulated data on the behavior of elementary particles of matter and their mutual transformations, gas dynamics had not been developed. **However, some points were known even then, but they were not given importance. At all stages of development of natural science it was possible to formulate the idea of general physical invariants. Postulating the properties of the ether, it was possible to propose the gas medium as a model, at least on the basis of the fact that the medium should naturally fill the entire world space and not provide any noticeable resistance. However, nothing of this was done, which testifies to the insufficient development of the methodological foundations of physics practically at all stages of the development of natural science.** Dialectical materialism filled this gap to a certain extent, but, as experience shows, it never became a working tool for all those who tried to develop theories, hypotheses and models of the ether, and even less became a guide for those who indiscriminately denied and continue to deny its existence in nature.

2.3. Etheric Wind. Reality and falsification

The history of the search for the ether wind [92, 93] is one of the most confusing histories of modern natural science. The significance of ether wind research goes far beyond the research of any particular physical phenomenon: the results of the first works in this direction had a decisive influence on the entire natural science of the twentieth century. The so-called "zero result" of the first experiments of A. Michelson and E. Morley, performed by these researchers in 1881 and 1887, led physicists of the XX century to the idea not only of the absence of ether wind on the Earth's surface, but also to the conviction that the ether - the world medium, filling all space, does not exist in nature. No positive results obtained by these and other researchers in later years have not shaken this confidence. And even when A. Einstein himself in the

1920 and 1924 began to claim that "physics is inconceivable without the ether," it didn't change anything.

However, as it is revealed now, in the field of ether wind in due time a number of scientists carried out very solid works. Some of them gave exceptionally rich positive material. To these, of course, we must first of all refer the research conducted by the remarkable American scientist Professor Dayton Clarence Miller of the Case School of Applied Science, who spent practically his entire life on this research. It is not his fault, but his and our misfortune that all the results obtained by him and his group by contemporaries of the scientist and later theoretical physicists are categorized as

"unrecognized." By 1933, when the studies of Miller and his group were completed, the school of relativists - followers of Einstein's Special Theory of Relativity stood firmly on its feet and vigilantly watched that nothing could not shake its foundations. Such "non-recognition" also contributed to the results of experiments, in which some other authors, without wishing to do so, made mistakes and did not get the desired effect. They should not be blamed for the intentionality of such an outcome: they simply did not realize the nature of the ether, its properties, its interaction with matter, and therefore they made fundamental mistakes in conducting the experiments, which did not allow them to succeed. Today the reasons for these failures have become quite clear.

However, the negative opinion of the so-called "scientific community" still hangs over the problem of the ether wind, and this is a serious obstacle to the restoration of ideas about the ether and the deployment of work in this extremely promising field of natural science. Today it is necessary to critically reconsider the whole history of the search for the ether wind at least in order to understand the true situation in this matter and in the future to avoid the mistakes that were made by various researchers, which was the immediate reason for the rejection of further research in this direction.

The origin of the ether wind problem is the phenomenon of aberration of light in astronomy, which was discovered by J. Bradley in 1728. To explain the aberration, a number of hypotheses were proposed, the most fruitful of which was O. Fresnel's hypothesis of a stationary ether, put forward by him in 1825 and then used by H. Lorentz in his electrodynamics of moving media.

J. C. Maxwell shortly before his death noted [94] that when the Earth moves through the ether, there must be an etheric on its surface

wind, which accordingly should change the speed of light propagating in the ether. Unfortunately, noted Maxwell, all methods of measuring the change in the time of passage of light on a segment of the path require the return of light to the starting point, so the difference in time appears to depend on the ratio of the squares of the velocities of the ether wind and the speed of light, and this is a very small value, and it is practically impossible to measure.

Despite this, in 1880 A. Michelson developed a device - an interferometer with two intersecting optical paths, with the help of which such measurements became possible. However, it turned out that the obtained results did not correspond to the expected ones and the deviations were within the error values [95].

Not satisfied with the results of the 1881 experiment and due to the high sensitivity of the interferometer to vibration interference, Michelson 1886-1887, together with Prof. E. Morley, continued the work, significantly improving the interferometer and placing it on a float immersed in a mercury bath, which got rid of the influence of vibrations [96]. The results were again positive, but they again did not correspond to the expected results, for they gave a value of the velocity of the ether wind at least 10 times less. The question arose as to the reasons for this discrepancy.

In 1892 J. Fitzgerald and H. Lorentz independently of each other hypothesized that the reason for the absence of displacement of interference fringes could be the contraction of the arms of the interferometer when the substance of the arms moves through the ether: there is a deformation of the field of each charge, and since all the bonds in the substance have an electrical character, the atoms will get closer (the width of the body will increase proportionally). Then it was suggested that different substances would probably undergo different relative contraction, and therefore it would be possible to catch the difference in the contraction of two rods made of different materials (steel and pine wood were used). The testing of this circumstance did not lead to positive results. It was suggested, however, that it was wrong to carry out experiments in basement rooms, since the surface layers of the earth might [25-27] screen the etheric currents, and that it would be advisable to raise the interferometer on a freestanding mountain.

In 1905, E. Morley and D. C. Miller continued the experiments at Euclidean heights at a height of 250 m above sea level. The result was firmly fixed: the magnitude of the ether wind was 3-3.5 km/s [97].

The work was then continued by Prof. D.C. Miller, who spent about 40 years conducting the experiments, completing them in 1925, reporting them to the Washington Academy of Sciences [98] and issuing the corresponding report [99] (Fig. 2.1).

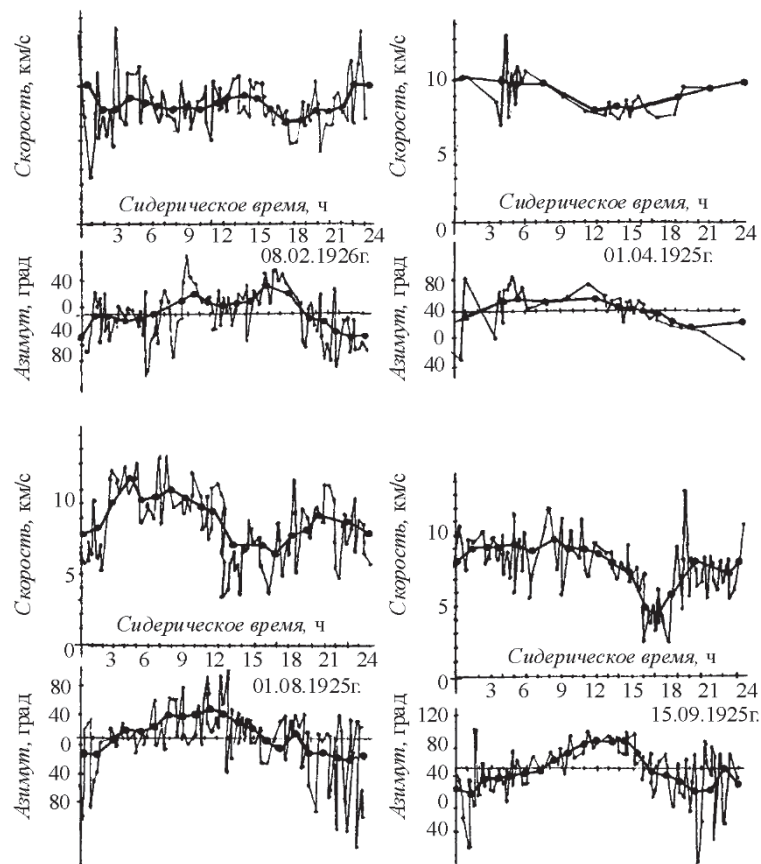

Figure 2.1. Fragments of ether wind recordings by D.C. Miller's group at Mount Wilson in 1925.

The experiments were conducted at Mount Wilson Observatory at an altitude of 6,000 feet (1,860 m) using a large interferometer. Tremendous statistics were collected by Miller and his group, with over 100,000 counts taken in 1925 alone. As a result, it was discovered that the velocity of the ether wind at this altitude was about 10 km/s, and its direction was not orbital but galactic. Taking into account the variation of the wind velocity by height, it was concluded that the etheric flow was partially captured by the Earth, which is quite consistent with today's ideas of gas dynamics about the regularities of the boundary layer and about the flow of a balloon (the Earth) by a gas flow.

As a result of the works of Miller, who in 1905-1907 and 1921-1925 put in 1905-1907 and 1921-1925 a series of experiments with the interferometer, inherited by him from Michelson and Morley, it became clear that there is a clear dependence of the velocity of the ether wind on height, and on the surface of the Earth, as it was shown in 1881 and 1887, the relative velocity of the ether wind is small and at a height of 250 m above sea level is about 3 km / s, and at a height of 1860 m - from 8 to 10 km / s. Thus, the relative velocity of the ether wind increases with altitude.

As a result of data processing, Miller found that the direction of the etheric wind is as if the Earth in its motion in the stationary ether is moving towards the star of the constellation Dragon (declination $+65^\circ$, direct ascension 262°). The probable error in Miller's experiments did not exceed 2° .

Miller reported his results to a special conference assembled at Mount Wilson Observatory on February 4-5, 1927 [100], and then published a large review article in 1933. [101].

The results obtained by Miller are in good agreement with the theory of the balloon flowing with a stream of gas.

When flowing around a balloon, gas forms a boundary layer, and the layers nearest to the body surface move together with the body, while the distant ones have some intermediate velocity, and starting from some value, the gas velocity corresponds to its velocity in free space. In other words, the boundary layer has a certain thickness determined by the parameters of both the gas and the ball.

At points with coordinates relative to the central axis of the gas flow $\varphi_{otr} = 109.6^\circ$, the boundary layer breaks away. Starting from this coordinate, the gas should be stationary relative to the ball at various distances from it up to the boundary layer that has broken away and passes at some distance from the ball.

Work in a similar direction was also carried out by other researchers. At the same conference, R.J.Kennedy reported that, after Miller published his results in 1926, he, Kennedy, invented and developed another device, simpler, but possessing, in his opinion, extremely high sensitivity, which amounted to 0.001 interference fringes (although the blurring of the edges of interference fringes is 10-20%! - *V.A.*). The device was packed in a hermetically sealed metal box, which was filled with helium. By the beginning of 1927 the device was debugged, and all experiments had already been performed. Kennedy did not get any results, which he reported to the conference. This was interpreted by him not as the unsuitability of his device, which was carefully isolated by a metal box from the penetration of etheric currents, but as the absence of etheric wind in nature. There were other similar attempts, such as the lifting of the interferometer on a stratospheric balloon over Brussels in 1926. Here the researchers A.Piccard and E.Stael also corked the device in a metal box. The results in this case were uncertain [93].

In 1929, A. Michelson, together with F.G. Pease and F. Pearson, repeated experiments on the detection of the ether wind [102, 103], this time quite successfully completed: at the same height in the Mount Wilson Observatory, they obtained a value of wind speed of 6 km/s. The decrease of the velocity in comparison with Miller's data is easily explained by the fact that, unlike Miller, Michelson conducted his experiments in a fundamental house, the walls of which somewhat reduced the velocity of etheric flows.

Thus, there is no reason to consider as "firmly established" the absence of ether in nature on the basis of the results of the experiments carried out in 1881 and 1887. On the contrary, these works, and especially those of Miller, speak definitely in favor of the existence of the ether, and the uncertainty of the brief verifications by other authors can rather be attributed to the careless preparation of the experiments than to any evidence.

It is interesting to note that Miller obtained the direction of the ether wind, which does not coincide with the expected in the plane of the Earth's orbit around the Sun. His results reflect not even so much the motion of the Earth together with the Sun and the Galaxy in the world space, as the motion of etheric flows inside the Galaxy.

Between 1929 and 1933. Michelson and his collaborators (Michelson died in 1931) set up an experiment in a partial vacuum. The speed of light was measured in an iron tube 1600 m long and

a 1-meter diameter pipe located on Mount Wilson. The air was pumped out of the pipe. No effect of the ether wind was detected, which is not surprising since metals have a particularly high ether dynamic resistance and iron pipes shield the effect. One might as well try to measure the air wind blowing outside with a device placed in a sealed room.

In 1958-1962, a group of American researcher C. Townes, the inventor of the maser, tried to measure the speed of the ether wind using two masers located on a rotating platform. It was supposed that the ether wind should, by accelerating light, change the frequency of the received radiation. The effect was not obtained, which allowed the authors to declare the absence of ether wind in nature.

This experiment contained a gross error: the ether wind could change the phase of the signal, but not its frequency, since the Doppler effect of mutually stationary sources of oscillations (masers) and the receiver (interference picture) is always and fundamentally equal to zero.

In [93] the listed experiments are described and the question is raised about the necessity of returning to the problem of the existence of the ether wind in nature.

At present, a number of researchers are proactively carrying out work on the study of the ether wind. These works are carried out using the first order effects (the effect is proportional to the first degree of the ratio of the ether wind speed to the speed of light) - measuring the phase of the signal in the radio band and measuring the deviation of the laser beam from its average position. The results of these works confirmed the presence of ether wind even on the surface of the Earth, but they have not yet shaken the supporters of the theory of relativity.

In 1998-2002 in Kharkov at the Institute of Radiophysics and Electronics of the National Academy of Sciences of Ukraine, the group of Y.M.Galaev performed a large range of studies on the influence of meteorological conditions on the propagation of radio waves of the 8-millimeter range on the base of 13 km. Daily and annual variations were revealed. Processing of the results showed an almost complete correlation with Miller's 1925 results. [104]. Thus, there are no grounds to consider the absence of ether wind allegedly confirmed experimentally. On the contrary, the conducted experiments clearly showed that the ether wind exists, that it increases with height and that it has a galactic, not orbital direction. It is

means that work on the ether wind must continue, particularly with experiments on mountaintops and in space using satellites.

What will ether wind measurements give for science and practice? For science, they will give the possibility of much more complete ideas about the processes occurring in near-Earth space, in the Solar System and in the Galaxy, and, finally, about the structure of the Universe as a whole.

For practical purposes, a systematic study of the ether wind in near-Earth and more distant space will make it possible to timely detect and take into account the influence of cosmic factors on the processes occurring on the Earth. Since all processes without exception are inertial, one can eventually learn to predict future Earth processes by the state of ether parameters - its density, viscosity, temperature, changes in the directions and speed of ether flows in near-Earth space. This, in turn, will significantly reduce many negative consequences of space influence on the Earth, and possibly prevent or even completely avoid them.

Conclusions

1. The concept of ether accompanies the development of natural science from ancient times to the present. The pictures of the world and various physical theories developed by different authors until the beginning of the twentieth century correctly assumed the existence in nature of a world medium - the ether, which is the basis of the structure of matter and the carrier of energy of physical fields and interactions.

2. Failures of numerous authors of theories, models and hypotheses of the ether were predetermined by the erroneous methodical approach of these authors to the problem of the ether. In accordance with this approach, the properties of the ether were not deduced from the results of generalization of observations of real reality, but were postulated and idealized, which inevitably led to contradictions. However, this is explained, first of all, by the fact that natural science had not passed the stage of necessary accumulation of facts, there were no gas dynamics and data on elementary particles. Both appeared only by the middle of the twentieth century, when any research on the aether theory was administratively stopped.

3. The phenomenological approach to physical phenomena, rooted in the twentieth century, associated, in particular, with the introduction of the theory of relativity and quantum mechanics into theoretical physics, led to the rejection of the concept of ether and, as a consequence, to the neglect of the internal mechanisms of phenomena, to the neglect of the internal motions of matter. Physical phenomena began to be explained as a result of spatial and temporal distortions. Thus some properties of electromagnetic interactions, in particular, quantization of electromagnetic energy, speed of light, were artificially and unjustifiably extended to all without exception physical interactions, including nuclear and gravitational ones. This approach has set a limit in the cognitive capabilities of nature by man.

4. Modern theoretical physics has to indirectly introduce the concept of the world medium under the names "physical vacuum", "field - a special kind of matter", etc., avoiding the name "ether" as supposedly discredited, thus showing inconsistency in its philosophical basis.

5. The coincidence of the obtained experimental results with the calculated results according to the formulas of the theory of relativity and quantum mechanics does not mean the validity of these theories, as similar numerical results can be obtained on completely different bases, for example, on the basis of the dependences of gas mechanics, arising from the ideas about the existence in nature of the ether, possessing the properties of ordinary real gas.

6. Experiments on detection of "ether wind", which gave negative results and were the basis for the statement about the absence of ether in nature, were set either methodologically wrong (Ch. Towns, 1958-1962), or instrumentally incorrect (Kennedy, 1925-1927; Illingworth, 1926-1927; Piccard and Stael, 1926). The results of these experiments do not provide grounds for an unequivocal conclusion about the absence of ether in nature.

7. There is direct experimental evidence indicating the presence of an "ether wind" in near-Earth space. These data were obtained by Morley (1901-1905), Miller (1921- 1925) and Michelson (1929). The results of their investigations testify not only to the fact of the existence of ether in nature, but also to its gas-like structure. At present, new successful attempts to measure the aether wind have been made, and highly sensitive 1st order devices have been created, which allow us to put the research of the aether wind on a qualitatively higher level.

8. The need for systematic studies of the ether wind in near-Earth space, in addition to general cognitive purposes, is also connected with practical tasks, since all space influences on the Earth pass through the ether surrounding the Earth. Taking into account the inertia of all processes in general, systematic studies of the state of ether parameters in near-Earth space - density, pressure, viscosity, temperature, velocity and direction of flows, etc. can be used along with already known other methods to create an effective system of forecasting many terrestrial events, the root cause of which are cosmic influences. This will make it possible to minimize the negative consequences of such influences, including many natural and man-made disasters.

Chapter 3. Methodological Foundations etherdynamics

...Science, whose task is to understand nature, must proceed on the assumption that this understanding is possible, and according to this assumption must make its conclusions and investigations.

H. Helmholtz [1].

3.1. O certain provisions dialectical materialism

Before restoring the ideas about the ether, it is necessary to answer the question why all this is needed at all. For this purpose we will have to remember why science is needed in general and, in particular, why natural science is needed. And here we cannot do without analyzing what social production is.

In order to live, man must consume certain objects - consumption items. Nature does not produce consumption items by itself, for this we need means of production. Means of production do not work by themselves, man works on them. In order to produce with the help of means of production the consumer goods needed by man, raw materials and technologies are needed. But in order to create the necessary technologies capable of producing the necessary consumer goods with the help of extracted raw materials, it is necessary to know the structure of nature, to find its objective laws, because only on their basis it is possible to create the necessary technologies and extract the necessary raw materials for them. Thus, it is the creation of technologies that is the ultimate goal of natural science, and this is confirmed by the whole history of science development: the knowledge that is mastered by technologies is preserved, and the knowledge that is not mastered by technologies is sooner or later lost, and then, if there is a need for it, is rediscovered. Hence the famous formulation of science.

Science is a sphere of human activity, the function of which is the development and theoretical systematization of objective knowledge about reality, one of the forms of social consciousness [2]. Accordingly, *natural science is a* system of sciences about nature, studying various forms of existence, changes of state, motion of matter in nature: their material carriers (substrate), forming a hierarchical ladder of successive levels of structural organization of matter; their interrelations, internal structure and genesis; the main cognized forms of existence - space and time;

the regular relationship between the phenomena of nature of both a general nature, covering a number of forms of motion, and of a specific nature, concerning only certain aspects of certain forms of motion, their substrate and structure [3]. "The subject of natural science is moving matter. The cognition of various forms of motion is the main subject of natural science" (Engels) [4].

Hence the task of physics. *Physics* is a science that studies the simplest and at the same time the most general *objective* regularities of natural phenomena, properties and structure of matter and laws of its motion. The concepts of physics and its laws are the basis of all natural science. Physics studies functional and quantitative *objective regularities of phenomena* [5].

The world around us, of which we ourselves are a part, is material. "The real unity of the world, Engels wrote, consists in its materiality, and this latter is proved not by a couple of magical phrases, but by a long and difficult development of philosophy and natural science" [6, p. 39]. [6, c. 39].

It is all a matter of discovering the laws of this movement. The significance of materialism follows directly from the above: materialism shows the necessity of studying the objective laws of nature rather than inventing them. The basic question of philosophy, what comes first - matter or consciousness, i.e., objective reality or our perceptions of it, is solved by materialism in favor of matter, and by idealism in favor of consciousness.

Recognizing the primacy of matter means that it is not created by anyone, but exists eternally, that space and time are objectively existing forms of being matter, that thinking is not separable from the matter that thinks, that the unity of the world consists in its materiality.

The materialist solution of the second side of the main question of philosophy - about the cognizability of the world - means the belief in the adequacy of the reflection of reality in human consciousness, in the cognizability of the world and its regularities. "Our subjective thinking and objective world are subject to the same laws" [7, c. 231].

Dialectical materialism is the science of the most general laws of movement and development of nature, society and consciousness. The initial category for materialist dialectics is the category of matter and forms of its existence - motion, space and time. All objects have external sides, which are directly perceived by sensations. This is the qualitative side of the object, its

difference from other objects. Realization of quality precedes cognition of quantitative aspects of the object. Hence, it is immediately obvious that any functional-quantitative description of an object must be preceded by its qualitative model. However, the qualities of an object are determined by its internal content, which is the reason why objects have certain qualities. And that is why cognition goes "from coexistence to causality (causality - *V.A.*) and from one form of connection and interdependence to another, deeper, more general" [8]. In-depth realization of the relationship between the external and internal is revealed in the categories of form and content.

Dialectical materialism indicates that every object and every phenomenon should be considered in the process of its formation, development and degradation. Development is the transition of an object from one state to a qualitatively different one, from one structure to another. Degradation of an object up to its destruction does not mean the disappearance of matter, but only the transition of matter into a structure of a different quality. "All of nature, from its smallest particles to the greatest bodies, from grains of sand to suns, from the simplest to the human being, is in eternal emergence and disappearance, in a continuous flow, in ceaseless motion and change" [7, p. 15]. [7, c. 15].

It follows directly from all this that the task of the materialist researcher is to study nature as it is, whether one likes it or dislikes it does not matter. Accordingly, the task of materialistic theory is to describe the laws of nature and to discover the reasons why these laws are so. Therefore, if it is found that some facts, previously discovered or new, do not correspond to the theory, the theory should be changed, clarified or even canceled completely as not corresponding to objective reality. And thus all objects should be considered as structural organizations of matter, i.e. having some "building material" organized into a structure, and this structure should be considered in the process of its organization, development, degradation with the transition of this "building material" into another structure.

Materialism admits of no postulation; a materialist theory rests on conclusions from established facts, and these conclusions may be adjusted as new facts accumulate. Mathematics here is a useful complement to qualitative physical ideas about the structure of material objects and about physical processes and phenomena.

The same issue is resolved by idealism in favor of consciousness. Here it is considered that the task of science is to create a certain logic based on several initial statements. The criterion of truth is not correspondence to reality, but the "simplicity" or "beauty" of the theory, the possibility of the most "simple" description of the laws of nature. Here the "principle of economy of thinking", once proclaimed by E. Mach, is possible. And if a fact is found in nature that does not fit into the legalized theory, this fact is simply discarded as "unrecognized". Just such a story and happened with the ether wind, which was discovered as a result of many years of experiments, but which turned out to be "unrecognized" because Einstein's theory of relativity did not correspond to these experimental data.

Postulating, i.e., putting forward postulates, i.e., free statements to which reality is supposedly obliged to conform, is one of the main methods of idealistic theories. What is worth such postulates as "the electron in the atom does not fall on the nucleus and does not radiate because it moves along allowed (! - *V.A.*) orbits" (N.Bohr) or "the axiomatic basis of physics must be freely invented" (Einstein). Here mathematics is not a supplement to qualitative physical representations, but the basis of nature, and qualitative representations appear to be unnecessary at all. In physical theories, as Lenin rightly noted, "matter has disappeared, only equations remain".

From this we can immediately see the difference between materialist and idealist approaches to scientific theory. Materialists study nature, and if the facts do not fit the theory, they change the theory. Idealists "invent" nature, and if the facts do not fit the theory, they discard the unwanted facts. It has happened with the ether wind: when unambiguous results have been received and it has been defined, where the ether wind blows from, having galactic direction, and with what speed, these results have been "not recognized" by relativistic physicists and thus have committed a scientific forgery, having rejected both the ether wind and the ether itself as a world medium and building material for all kinds of matter and fields. If such a thing happened to the materialistic theory, the authors of the theory would be forced to revise their theory.

The materialist approach is based on the whole experience of natural science, and from it some fundamental points for any materialist theory are directly derived. This experience tells us that any concrete material thing

formation has a beginning and an end, but matter does not disappear, it passes into other material formations. The universe as a whole has neither beginning nor end, and therefore every material formation must be considered as becoming, arising as a result of some processes, existing for a finite period of time and being destroyed as a result of other processes. At the same time, everything occurs in space and time, which is motion, which also does not arise from nothing, but only passes from one form to another. This circulation of matter in the Universe is eternal.

There can be no immaterial processes in the Universe and at any point of space and at any moment of time. And since both space and time are defined as properties of matter, whatever small fraction of space is to be considered, there must always be matter in it, and whatever smallest segment of time is to be considered, there is always a material process in it.

Recently, some researchers have begun to consider energy-information processes as some fundamental property of matter. Without denying the legitimacy of such an approach, however, it should be noted that the transmission of information requires a material carrier - a signal, which has a certain structure, carries a certain energy and is capable of being not only emitted by a material transmitter, but also received by a material receiver in the form in which it is emitted. And if at least one of these attributes is absent, then any energy-information process is out of the question.

No "action at a distance" ("actio in distance") - the interaction of bodies in the absence of a material carrier of this interaction - exists in nature, and if this material carrier is not taken into account in theoretical constructions, it should be considered not as a device of nature, but as a defect of the theory.

It must not be forgotten that just as innumerable higher-order curves can be drawn through a finite number of points lying in the plane, any finite number of facts can be

"explained" by countless theories. Any concrete fact does not confirm a theory, but merely contradicts or does not contradict it. For example, the correspondence of the obtained experimental results to the Lorentz transformations can be interpreted as follows

"confirmation" of two mutually exclusive theories - Einstein's Special Theory of Relativity, which denies the ether, and Lorentz's own theory of the immobile ether.

And it is also necessary to note that every process and every phenomenon has an internal mechanism, hidden movements of matter at a deeper hierarchical level, which give rise to this process and phenomenon. But any process and any phenomenon, as well as their internal mechanism cannot be determined with absolute certainty, because the number of properties of each of them is infinitely large. Any object can be cognized with a certain approximation, but this process of cognition must continue, gradually refining the knowledge obtained. This is the problem of relative and absolute truths.

The whole accumulated experience of natural science testifies to the validity of the provisions of dialectical materialism. Modern physical theories, and first of all Einstein's theory of relativity and quantum mechanics in its philosophical part, are in flagrant contradiction with the provisions of dialectical materialism. Theoretical physicists recognize this fact, but it is explained by the fact that dialectical materialism itself is obsolete. In fact, the opposite is true, and although the theory of relativity and quantum mechanics have provided many useful methods of calculating concrete phenomena, this does not at all indicate the correctness of the theories themselves. Moreover, putting the main task of physics phenomenology - external description of phenomena, they limited the possibilities of man in the knowledge of nature and led physics and all natural science in a dead end. The task of natural science is to return to materialistic methodology and with its help to solve all the accumulated contradictions.

From all of the above it is quite natural to determine the role of ether dynamics - a section of physics devoted to the study of everything that is related to the ether.

Ether dynamics is a section of physics that studies the structure of material and non-material entities, force and information fields of interactions on the basis of ideas about the ether - a material medium that fills the entire world space and is a building material for all kinds of organization of matter and fields, the movements of which are manifested in the form of certain physical phenomena.

Etherrodynamics is in its infancy. However, we can already see that on its basis new directions of research are being defined, many hypotheses, technologies and even discoveries are appearing. It is natural, as the transition to a new level of matter organization allows to understand the essence of physical phenomena and to make on this basis

on the basis of many new conclusions. The introduction of ether dynamics into physics is the next, sixth in the history of natural science, physical revolution. Thus, it is necessary to return to the question of existence of ether, its structure and role in nature. However, it is necessary to make certain warnings here.

Ether-dynamics has materialism in its basis, i.e. it proceeds from the idea of materiality, objectivity and independence from our perceptions of the surrounding reality. But it should be ready to make corrections in any of its provisions, if in the real world there are facts that contradict them. The supporters of ether-dynamics, and there are many of them today, should not forget that every phenomenon is inexhaustible, and therefore everything that is considered by ether-dynamics from the position of the existence of ether in nature is only a model of real processes. These models will be refined and improved by subsequent researchers, and this process of improvement of models - ideas about the essence of physical phenomena - will last as long as natural science will exist.

The introduction of ether-dynamics into physics will be opposed in every possible way by the dominant theoretical schools. Recognition of ether-dynamics is ruinous for them, because the question naturally arises, what physical theories have been doing up to now? It is almost senseless to try to re-educate the existing scientific schools. The way out is that independently of them ether-dynamics becomes an independent scientific school. There is no doubt that it will be so.

3.2. Methodology etherdynamics

3.2.1. Universal physical invariants

To determine the basic principles of the methodology of ether-dynamics, it is necessary to answer the question about the purpose of natural science. Clarification of the purpose of natural science is necessary, in particular, because this or that answer determines to a great extent the methodology itself.

There are known statements when the purpose of natural science was declared to be the possibility of applied use of new knowledge. There are opinions about descriptive purposes of science, for example, about obtaining mathematical dependencies extrapolating the obtained knowledge.

experimental results and further declared to be laws of the material world.

However, there is reason to argue that the above views are, on the one hand, extreme, on the other - clearly insufficient. In fact, treating the pragmatic goals of science as a whole and its individual directions as primary and only, rather than ultimate, inevitably leads to the fact that the actual knowledge of nature is relegated to the background or removed altogether, as a result of which applied achievements are superficial and incidental. Experience shows that the best practical results lie at the junction of sciences seemingly unrelated to the applied task at hand. This requires additional efforts, and consequently, the real maximization of science is in contradiction with the idea of quick application results.

Mathematical quantitative-functional description of phenomena turns out to be a useful, and in some cases a necessary condition for obtaining applied results, as well as for predicting new effects and phenomena. However, given the infinite variety of qualities and properties of each material body, it can be argued that any mathematical description is a very narrow and one-sided representation of the real reality. In this case: 1) there is no guarantee that the mathematical dependence reflects all essential sides of the phenomenon; 2) there is no guarantee that the setting of new experiments will reveal any new sides of the phenomena, because the very setting of new experiments is based on the same mathematical dependencies, therefore, refers to the same narrow area of phenomena, from which the previously obtained "law" itself follows.

Thus,

The "law" is confirmed all the time. It is practically extremely difficult to go beyond the "law" once found, since every experiment has errors, deviations from the "well-established law" are written off to them, and qualitatively new experiments are not set up. The search for new areas turns out to be random, and the expected result is uncertain.

As correctly pointed out by Maxwell [9], mathematical formulas are the result of simplification of real phenomena, and the use of mathematical formulas, not supported by physical concepts, leads to the fact that "... we completely lose sight of the phenomena to be explained and therefore cannot come to a broader idea of their internal relationship, although we can calculate the consequences of these laws".

Thus, neither the applied nor the descriptive side can be the main goal of natural science.

Such a goal for natural science in general, and physics in particular, at all stages and levels of development should be to uncover the nature of phenomena, to find out the reasons why these phenomena are exactly such and not others, and whether there are any qualities in them that are still unknown. But this approach requires understanding of the internal mechanism of phenomena, analysis of cause-and-effect relations between material entities involved in the studied phenomena and effects. Revealing these connections and relations allows us to *explain the phenomena*, i.e. to explain why this phenomenon is the way it is and not the other way around. Disclosure of internal connections, internal movements of matter in phenomena makes it possible to reveal the essence of phenomena more fully than when using only external description. At the same time, the areas of distribution of the obtained mathematical dependencies can be taken into account and the assumed approximations can be formulated. This makes it possible, if necessary, to refine the obtained dependencies.

The supreme goal of physics as the basis of natural science should be the identification of a common physical basis for all phenomena, common building material for all kinds of matter, structural organization of material entities at all levels of hierarchical organization of matter and the identification of a common mechanism of the basic fundamental interactions between them. But in order that this can be done, it is necessary first to define universal physical invariants, i.e. those categories that remain unchanged at any transformations of material structures and at any processes.

As is known, the result of any experiment is the relations between physical quantities. Depending on which of these quantities are considered to be constant, independent invariants, the other quantities, which are related to the first relations obtained in the experiment, turn out to be variable. In some cases, the conclusions from such relations turn out to be so important that they essentially influence the development of the whole natural science.

Thus, as a result of experiments to determine the mass of a particle when its velocity approaches the speed of light, a complex dependence is obtained relating the field strength of the capacitor and the magnetic field strength through which the particle flies to its charge, flight velocity, radius of curvature of the trajectory, and mass [10]. Taking as invariants the field and charge strengths

of the particle leads to the conclusion about the variability of mass. However if to consider as invariant the mass, the same dependence can be interpreted as a detection of dependence of charge on velocity, which was pointed out by Busch. If we take into account that when the velocity of a particle approaches the velocity of light (the propagation velocity of the electric field) the interaction between the particle and the field should decrease (by analogy with the rotor of an induction motor moving in a running magnetic field), the same dependence should be interpreted as a dependence of the interaction coefficient between a charged particle and the field when the charge and mass are unchanged. There may be other interpretations of this dependence.

In Einstein's theory of relativity, the speed of light and the four-dimensional interval in which the increments of coordinates are related to the increment of time through the same speed of light are taken as universal invariants. This, firstly, made all kinds of interactions dependent on the speed of light, although the speed of light is an electromagnetic quantity and has nothing to do with nuclear or gravitational interactions, and secondly, led to the notions of curvature of space and time dilation. The direct result of this choice of invariants was the variability of mass when the velocity of bodies changes, the change of their sizes, the equivalence of energy and mass, etc. If other quantities were chosen as universal invariants, the result would be quite different, and the theory of relativity would have a completely different form.

It is clear from the above that the choice of invariants should be treated with great caution. Due to the possibility of arbitrariness in the choice of invariants, it is necessary to develop methodological foundations of this subject. Let us consider the main requirements for general physical invariants.

It is obvious that the role of universal physical invariants can be claimed only by such physical quantities, which are inherent in absolutely all physical phenomena and in one way or another manifest themselves in a significant way in any forms of matter structure at any level and at any types of interactions. These quantities must be present at the level of organization of matter into objects and substances, into molecules, atoms, elementary particles, as well as at the level of planets, stars, galaxies and the Universe as a whole. This requirement is necessary because the basis of each macro-process is the corresponding micro-process, which conditions the regularities of the macro-process. The unity of nature forces both the microcosm and the macrocosm to search for universal invariants, relative to which it is possible to estimate

other quantities present in processes, phenomena and experiments. This approach leads to the necessity to search for physical invariants only among the quantities present at any level of organization of matter and essential for any phenomena.

From this position, such a quantity, for example, as electric charge cannot act as a universal physical invariant, because this category, really present in the microcosm, does not manifest itself significantly at the level of organization of matter into molecules, substances, stars, galaxies. In any case, the presence of charges inside atoms and molecules is not essential for physical interactions at a higher stage of organization. Gravitation, in particular, does without any notion of electric charge at all. Moreover, even at the level of elementary particles the category of electric charge does not always play an essential role, because there are particles that have no charge.

For the same reasons the characteristics of separate physical phenomena or separate forms of matter, for example, the parameters of photons of light (constancy of the photon's shape, constancy of its velocity - the speed of light, straightness of propagation, etc.) cannot act as universal physical invariants.

Considering the most general characteristics of matter at any level of its organization, we can state that for all these levels there are only four really universal physical categories. These categories are matter proper, space, time. The existence of matter in space and time is the movement of matter.

Indeed, any occurring phenomenon can be judged only in connection with the fact that this phenomenon occurs with matter, and not independently of it (all phenomena are material), in space (nothing happens outside space) and in time (all processes take place in time), which in itself already means the movement of matter. As rightly observed by F. Engels, there is nothing in the world but moving matter.

The categories of matter, space and time and their aggregate - motion - are the basis for the entire universe. These categories should always be considered as initial when considering any structures of organization of matter, any processes and any physical phenomena of nature.

Since the categories of matter, space and time and their totality - motion - are true for all levels of organization of matter, starting from the Universe as a whole and ending with elementary particles.

particles of matter, there is no reason to believe that at a level of organization of matter deeper than the "elementary" particles of matter, these categories would be unjust.

As universal categories for all levels of organization of matter, matter proper, space, time and motion thus act as universal physical invariants, independent of any particular forms of organization, particular types of motion or particular phenomena. Consequently, the universal physical invariants are not postulated, but are determined on the basis of generalization of all experimental data known to natural science, as it should be at materialistic approach to the study of nature.

To use invariants in real dependencies, we need appropriate measures - units of measurement. The units of corresponding physical quantities can be taken as units of measurement. For example, the unit of time - second, earlier defined as 1/24-60-60-60 fraction of a day, and later tied to the atomic standard of frequency, acts as a measure of time. The measure of space is the unit of length and its derivatives (measures of area and volume). Various standards have been taken as the unit of length, but the unit currently taken as the meter is 1/40,000,000 fraction of the length of the Paris meridian, later also tied to the atomic standard. The fairness of the choice of these quantities as measures of time and space has been confirmed by the whole experience of natural science. As for the measures of the quantity of matter and motion, additional reservations are necessary.

No direct measure of the quantity of matter has been found so far. Mass was considered an indirect but strictly proportional measure of the quantity of matter in classical physics. The theory of relativity, introducing the concept of variability of mass with velocity, thereby questioned the possibility of using mass as a measure of the quantity of matter.

In principle, mass can only be an indirect measure of the quantity of matter and can be related to the quantity of matter not directly, but by a functional dependence, which will include other quantities. However, the probability that the inert mass is an invariant measure of the quantity of matter, i.e. strictly proportional to the quantity of matter, is much higher than the probability that a moving particle has invariant interactions of charge with electric and magnetic fields used in the experiment.

Indeed, the speed of light is the speed of propagation of the electromagnetic field. Charge has an electrical nature.

Approaching the velocity of a charged particle to the velocity of propagation of the forces acting on it (and the strengths of the magnetic and electric fields are the forces acting on the charge) will inevitably lead to a change in the magnitude of the interaction. If the particle had a velocity equal to the speed of light, the electric field, at least directed along the trajectory of the particle, could not affect it at all. Consequently, the interaction of charge and intensity as the particle moves must be nonlinear. As for the effect on mass, no direct effect of the electromagnetic field on mass has been found so far. In addition, a strict proportionality between gravitational and inert mass is known and experimentally confirmed. But gravitational interactions differ in magnitude from electromagnetic interactions by many orders of magnitude. This means that the gravitational interaction and, consequently, the mass have a different physical basis.

Thus, to expect that the mass of the particle changes as the velocity of the particle approaches to the velocity of light, i.e. to the velocity of propagation of the electromagnetic field, generally speaking, there are no grounds. If such a change takes place (which does not follow from the experience described above, but can be checked in another way, for example, by determining the kinetic energy of the stopped particle), it is only due to the addition to the particle of matter of the mass of the medium surrounding it. There is a certain analogy to the latter circumstance: a compacted air cushion is formed in front of a flying airplane, which creates for it some attached mass affecting its aerodynamics.

Since the inert mass is an indirect measure of the quantity of matter, it can be assumed, at least in principle, that conditions are possible under which the same quantity of matter will have different inert (much less gravitational) mass under unequal conditions.

As for the measure of motion, we know such traditional measures as the quantity of motion (incorrectly called impulse) and energy, repeatedly confirmed experimentally and valid for all manifestations and interactions, taking into account, of course, the phenomena occurring at all levels of organization of matter. The application of one or another measure to a particular phenomenon depends on the nature of the phenomenon. Here it is necessary to recall Engels' analysis, from which it follows that the quantity of motion is a measure of motion of one hierarchical level, and energy is a measure of motion,

irreversibly passing to the deep level of matter organization, for example, at collision of inelastic bodies into heat [7, p. 67-81].

One important property of invariant quantities should be noted. Being initial, these quantities strictly obey the rules of additivity. One cannot speak about these quantities as nonlinear ones, since it is relative to them that all other quantities should be measured and evaluated. Consequently, one cannot consider the curvature of the light beam near gravitational masses as a result of the "curvature" of space, but must consider the physical process of curvature of the trajectory of light photons under the influence of gravitation or as a result of other processes.

One cannot speak about the closedness of space, referring to the optical and gravitational paradoxes, but must look for unaccounted physical factors in the reasoning that led to the appearance of paradoxes and which have an abstract-mathematical idealized character. These phenomena have so far been considered at the most primitive level, although the nature of any phenomenon is considerably more complex.

We cannot speak about discreteness of space and time at the level of microcosm, because discreteness of any quantity can be defined only in relation to another analogous quantity, and for a general invariant quantity, which is initial for all others, such a concept as discreteness cannot exist in principle.

Space and time appear along with matter as objective categories, independent of any conditions and phenomena occurring in them, they reflect the totality of the motion of matter in the entire Universe at all hierarchical levels of the organization of matter and do not depend on any particularities. Everywhere, in any formulaic dependencies, these quantities can only act as arguments and can never be functions of anything. Consequently, the use of the principles of dialectical materialism at all levels of physical cognition inevitably leads to Euclidean space and unidirectional uninterrupted time.

In all cases of seeming "nonlinearities" of space and time one should look for unaccounted for deep processes, including at levels of matter organization deeper than the organization of matter in "elementary" particles of matter.

The existence of universal physical invariants for all levels of organization of matter and the existence of a continuous chain of cause-and-effect relationships.

of corollary relations between private phenomena, also covering all levels of the organization of matter, make us believe that there are no preferred scales of space and time in nature, and therefore the same physical laws are valid at all levels of the organization of matter and there are no "special" laws for the phenomena of the microcosm. Hence the special epistemological significance of analogies between macro- and microcosm phenomena.

The English physicist J. Ray (1842-1919), attaching special importance to the issues of analogy and similarity in physical phenomena, said on this occasion: "I am often surprised at the little attention paid to the great principle of "similarity" even by major scientists. It often happens that the results of painstaking research are presented as newly discovered 'laws' which, nevertheless, can be obtained a priori within a few minutes." Lord Rayleigh is right in principle, but it is necessary to know which analogy can be used in which case and which cannot.

The validity of the findings is usually ascertained after the research has been conducted, not before.

The four universal invariants: motion and its three components, matter, space and time, have seven basic properties:

- presence in all structures and phenomena;
- preserving it during any transformations;
- of infinite divisibility;
- additivity;
- linearity;
- unrestricted;
- absence of any preferred scales or preferred cutoffs.

From these properties of invariants, properties of our real world follow with necessity:

- 1) the indestructibility and uncreateability of matter, space, time and motion;
- 2) euclidean space;
- 3) the evenness of the passage of time;
- 4) the infinite divisibility of matter, space, time and motion;
- 5) the presence of matter and motion in any, the smallest volume of space;

- 6) continuity of material spatial structures (including field structures) and processes in time (the end of some processes gives rise to other processes);
- 7) hierarchical organization of matter in space and processes in time;
- 8) the sameness of physical laws at all levels of organization of matter;
- 9) the sameness of physical laws in all points of space and at any interval of time;
- 10) Reducing all processes (including all so-called fundamental interactions) to mechanics - the movement of masses of matter in space;
- 11) The infinity and limitlessness of the universe in space;
- 12) The infinity and limitlessness of the universe in time;
- 13) A constant (on average) view of the universe at all times.

In principle, for the formulation of general physical invariants and the conclusions arising from them, the material was sufficient at any stage of the development of natural science. But for the stage up to the beginning of the XIX century it was not relevant, in the XIX century the materialistic methodology was already largely lost, and in the XX century all physics turned to idealism. One way or another, this was not done.

General physical invariants create a basis for building models of material structures and processes at any stage of development of natural science. It is all the more actual now, during the next crisis experienced by natural science, and this opportunity should be used.

The following fundamental position follows from the above. Since there is nothing in the world but moving matter, all physical interactions have an internal mechanism and can be reduced to mechanics, i.e. to the movement of masses of matter in space and time. The well-known position of modern theoretical physics that there are four fundamental interactions - strong and weak nuclear, electromagnetic and gravitational - which are not reducible to each other, is true only in the sense that they are really not reducible to each other. But just as J. Fourier was mistaken in his time, believing that heat belongs to a special kind of motion of matter, not reducible to mechanics (1822), and 50 years later L. Boltzmann showed that heat is a kind of kinetic motion of molecules, so also the modern physical theory is mistaken, believing that these fundamental interactions can not be reduced to a special kind of motion of matter.

can be reduced to mechanics. From the general physical invariants considered above, their reducibility to mechanics directly follows, but at a level deeper than these fundamental interactions themselves.

3.2.2. Model (qualitative) representations of structures and processes

Identification of the internal mechanism of any phenomena is possible only if the principle of causality is recognized for the links and interactions of material entities involved in them. Since physical phenomena are the consequence of internal processes, often insensible at the achieved level of physics development, the recognition of the fact of causality is of fundamental importance, because in advance at all stages of cognition asserts the existence of the internal mechanism of phenomena and the fundamental possibility of its disclosure.

It is reasonable in this connection to recall the following statement of Engels: "...but where on the surface there is a play of chance, this chance itself turns out to be subject to internal hidden laws. It is all a matter of discovering these laws" [4, p. 174-175; 5, p. 361].

At present, however, the opposite point of view is much more widespread, believing the structure of the world to be indeterministic and thus imposing fundamental limitations on the possibility of its study and cognition.

The rejection of ideas about the existence in nature of the ether - the world medium, which is the building material of matter, led physics to the rejection of the intra-atomic medium. Quantum mechanics, which appeared in the 20's immediately after the formation of the theory of relativity, began to operate with mathematical abstractions, relying, however, on the planetary model of Rutherford, put forward in 1911, quite clear, but possessing many shortcomings. These shortcomings led to numerous paradoxes, which were treated not by improving the obviously unsatisfactory model, but by introducing postulates and "principles" - free statements like axioms, the justification of which was that some corollaries of them were confirmed. However, the limitless spread of postulates and principles led to new paradoxes, which were treated in the same way. The mechanism of the phenomena itself was not considered. The position expressed at the beginning of the twentieth century in the address of physics by V.I.Lenin was confirmed: "Matter has disappeared, there remained the

only equations" [11, p. 326]. [11, p. 326], i.e. exactly physical ideas about the structure of the world were thrown out of physics. But thereby the road to a dead end was paved.

The well-known Heisenberg's uncertainty principle ("indeterminacy principle", according to Bohm's expression) led physicists to the conclusion that in investigations carried out at the quantum-mechanical level, more precisely, at the level of matter division into "elementary" particles of matter, the exact causal laws of detailed behavior of such individual systems cannot be found in principle and that, thus, it is necessary to refuse causality as such in the atomic field. This actually put a barrier in the possibility of cognition of matter and regularities of the real world.

Therefore, some leading physicists do not agree with the principle of indeterminism, they consider randomness as a consequence of not taking into account objectively existing factors. Thus, Bohm in [12] points out that in experiments there are always irrelevant unaccounted factors that distort the results, which manifests itself as randomness. However, it should be noted that Bohm pointed out only one, subjective, side of the manifestation of randomness. No less important is the second, objective, side related to the fact that for the effect to manifest itself at the macro-process level, it is necessary to accumulate sufficient changes at the micro-process level. This circumstance is connected with all kinds of quantum and discrete processes, with all kinds of nonlinearities, zones of insensitivity and feedbacks of internal regulators of phenomena, etc. As an example we can cite an ordinary dry friction: an object lying on some hard surface will not move from a place until the force applied to it reaches a certain value, after which it will move with a jerk, because the value of friction will fall as soon as the object moves from a place. But similar processes can take place in the microcosm. A good example is also the formation of vortices in a fluid flow at a certain ratio between velocity, body size and viscosity of the medium, called the Reynolds number: at small values of the number no vortices are formed, but if the velocity increases and the Reynolds number increases, from a certain point turbulence and then stable vortices begin to appear.

It should also be noted that the occurrence of all processes at the level of the microcosm does not objectively depend on the fact of observability, although many physicists assert a certain solipsism: a phenomenon exists insofar as we observe it, and therefore the distortion of the microcosm does not depend on the fact of observability.

the results of measuring instruments are fundamental and do not allow us to draw unambiguous conclusions about the nature of the phenomena. In fact, the measuring technique due to its imperfection can, of course, distort the results of the experiment, if appropriate measures are not taken, but it is necessary to choose or create such measuring instruments that would introduce distortions within acceptable limits, or to apply compensatory methods in which the measured value is not distorted.

From the stated position follows the fundamental possibility of studying the internal mechanisms of phenomena at any level of organization of matter.

Recognizing the fact of causality allows us to reveal the mechanism of the phenomenon and raises the question of elementary interactions within the phenomenon. These elementary interactions can occur between interacting elements only through direct contact in a common point of space, whether it is a direct collision of particles or interaction of particles with a field. The principle

The principle of "action at a distance" (actio in distance), which implies the interaction of two elements through empty space, fundamentally cannot reveal the mechanism of phenomena precisely because it means the existence of empty space between the interacting elements. This principle was condemned by physicists back in the 19th century, and there is no need to return to it, although such attempts are still ongoing.

Each elementary interaction is a consequence of another elementary interaction and, in its turn, is the cause of the subsequent interaction of other elements. Thus, there is a continuous chain of causes and effects.

Recognition of the continuity of causal chains of events implies, generally speaking, a single internal mechanism for all elementary phenomena and interactions, at least it does not exclude such a mechanism. It is interesting to note that history shows how, despite the increasing number of diverse phenomena and the seemingly increasing possibility of multiplication of variants of the mechanisms of phenomena, in fact, in the process of development of natural science there was a process of reducing the number of these variants.

In 1922, Fourier concluded [13] that "... however comprehensive mechanical theories may be, they are in no way applicable to thermal effects. Heat belongs to a special category of phenomena that cannot be explained by the laws of motion and equilibrium". And already in 1868, i.e. 46 years after the statement of

Fourier, Boltzmann showed [14, 15] that thermal motion is a kind of mechanical motion.

This process of reducing the number of varieties of interactions continues. At present it is reduced to four: nuclear strong, nuclear weak, electromagnetic and gravitational. However, the recognition of the closed causal chains of all events leads to the conclusion that there must be a single process at the heart of these four interactions. From the fact that there is nothing in the world but moving matter, it follows with necessity that this single process must be the movement of material masses in space, and, consequently, all the so called "fundamental" interactions must be reduced to the mechanical movement of material masses in space.

The principal possibility of uncovering the internal mechanism of phenomena can be realized in various ways. One of them is the method of proposing random hypotheses, the consequences of which are tested and compared with real events. These hypotheses can be of abstract-mathematical character, or they can be of qualitative nature. A positive example is the Schrödinger equation, which was composed rather abstractly, but gave a range of solutions suitable for considering the phenomena of the microcosm, quite satisfactorily coinciding with practical observations. Another example is the same theory of relativity, which allowed not only to describe some known phenomena, but also to predict some new ones.

However, despite the external attractiveness of this method, in many cases it leads away from reality, because it does not reveal the inner essence of phenomena.

Indeed, an arbitrary hypothesis put in the basis of the study of phenomena will yield an equally arbitrary system of corollaries, which just as casually may coincide with some known phenomena, giving the impression of plausibility. There is no certainty, however, that these corollaries will coincide with other facts of reality not yet discovered. And the discovery of new facts will be hindered to the extent that the hypothesis that has gained acceptance proves unsuccessful in predicting them.

Since each private phenomenon can be explained in many, not one, ways, a group of private phenomena can be satisfactorily accommodated in any number of hypotheses and theories generalizing them. Consequently, the way of comparing the consequences arising from hypotheses is quite insufficient.

Consideration of the essential aspects of the mechanisms of phenomena can arise only from the notion of their generality, which requires simultaneous consideration of all known phenomena and identification of their common features. However, even in this case any number of theories is possible. Including mutually excluding each other. A good example here is Einstein's Special Theory of Relativity, which categorically denies the presence of the ether in nature, but uses as a mathematical basis the Lorentz transformations, which derived them from his theory of the immobile ether. Consequently, in order to construct a generalizing theory, the provisions of dialectical materialism must be taken into account in addition to the phenomena, which must be treated as experimentally verified facts reflecting the most general aspects of the real world. In addition, the theory should outline its boundaries and the possibilities of subsequent clarification. The contradiction of the theory to the real fact should be used to clarify the theory, if necessary, its change, not discarding the fact, as did the Special Theory of Relativity with experiments on the ether wind. Finally, the theory should proceed from qualitative representations supported by quantitative-functional descriptions, thus qualitative representations should allow to find borders and admissible simplifications of functional-quantitative descriptions at the decision of concrete problems.

It should be remembered that every object and every phenomenon has innumerable sides and qualities and therefore can only be fully described by an infinite number of equations with an infinite number of terms.

Thus, any real mathematical description of a subject or phenomenon is partial, approximate, covering only some aspects of the subject or the studied phenomenon, at that, even not always essential for the set research goal. Hence, it follows that ideas about any subject or phenomenon, i.e. their models, can and should be continuously refined, respectively, mathematical dependencies describing these models can and should be refined. The number of such approximations and refinements is infinite.

The method proposed below, proceeding from the objective materiality of phenomena, from their causality at all levels of the organization of matter, from the notion of the unity of all natural phenomena and the need for consistent approximation of models and descriptions to the real reality, does not represent something

is particularly new: it is the usual method of materialistic theory of cognition. It is this method that can allow us to construct a generalizing theory of matter, interactions and physical phenomena.

3.2.3. Ways to uncover the internal mechanisms of phenomena

When determining ways to uncover the internal mechanisms of phenomena, there arises a certain fundamental difficulty associated with the fact that the number of properties of each phenomenon and each of its elements is, in principle, infinitely large. Therefore, it becomes especially important to select from the totality of properties those that are essential for the task at hand. At the same time, it is necessary to determine the attitude to the discarded properties, since their failure to take them into account leads to epistemological simplification of the forms of matter and phenomena.

The issues of methodology of simplification of research subjects have been repeatedly considered in the literature. The criterion of "simplicity" has often been used by researchers as one of the main arguments in choosing one or another theory. Therefore, it is reasonable to dwell on this aspect in more detail.

In some works, for example, in [16], it is proposed to use "inductive simplicity" as a criterion of truth when choosing one or another theoretical system, i.e., to prefer that system of representations "...whose premises remain invariant with respect to a wider group of transformations". It should be objected, however, that since the groups of transformations themselves reflect the level of knowledge attained and are necessarily one-sided in this sense, such an approach is subjective.

The preference for a simpler path may eventually lead the researcher to stray from the original goal of seeking truth. For example, it is much easier to abstract from the internal mechanisms of phenomena, to give the mathematical description an independent meaning, which will lead, in the end, to the fact that the true primary ideas will be those that are the most convenient in mathematical terms. Unfortunately, this is exactly what happens quite often. An example of this is the whole quantum mechanics, which completely ignored the existence of the intraatomic mechanism, replacing it with probabilistic concepts.

The so-called "simplicity principle" is often found to ignore the real physical picture of the world.

What distant consequences such an approach can lead to is shown by the example of E. Mach's statement. Rejecting the concept of quantity

Mach recognizes "the notion of mass as a mathematical quantity satisfying some equations of theoretical physics, which is very convenient for science" [10, 17], i.e. mass here appears not as an objective reality, but as some "convenient" coefficient in the equations for the researcher. [10, 17], i.e. mass here is not an objective reality, but a certain "convenient" for the researcher coefficient in the equations.

Einstein writes [18]: "...Concepts and relations, especially the existence of real objects and, in general, the existence of the
The "real world" is justified only insofar as it is related to sense perceptions, between which it forms a mental connection... One of Kant's great merits is that he showed the meaninglessness of asserting the reality of the external world without this cognizability. ...The aim of science is, on the one hand, to cognize as fully as possible the relation between sense perceptions in their totality and, on the other hand, to achieve this aim by applying the minimum of primary concepts and relations (achieving, as far as possible, logical unity in the picture of the world, i.e. striving for the minimum of logical elements)".

It should be noted that for Einstein the criterion of simplicity was a direct guide to action. As mentioned above, in [19] Einstein noted that in order to resolve the contradictions in the conclusions of the results of the experiments of Fizeau and Michelson, he sees two possibilities: 1) the ether is completely motionless; 2) the ether is carried away by moving matter, but it moves at a speed different from the speed of motion of matter. He further writes: "...The development of the second hypothesis requires the introduction of some assumptions concerning the relation between the ether and moving matter. The first possibility is *very simple* (italics mine, - V.A.) and for its development on the basis of Maxwell's theory does not require any additional hypothesis that could complicate the foundations of the theory". This position led Einstein to r e j e c t t h e ether.

Now we can only wonder what conclusions would have come to Einstein, if he had not been seduced by the "simplicity" of the first position, and would have investigated the second, "more complex". In any case, it is clear that no rejection of the ether here in principle could not be discussed, but also the Special Theory of Relativity would not have been born. Following the first position forced Einstein to spend a lot of time on fruitless attempts to build a unified field theory on this path.

It is clear from these examples that arbitrariness in the application of the of the "principle of simplicity" can have far-reaching consequences. On the other hand, considering matter and phenomena in their entirety

of their properties is impossible, since the number of properties of any material object is infinitely large. Hence the methodological importance of the raised problem becomes obvious.

In order to determine how the essential aspects of objects and phenomena can be distinguished, it is useful to consider this issue from a historical perspective.

In philosophical literature it is considered that the requirements for analyzing the essence of natural phenomena were first put forward by Thales of Miletus. If before him nature was considered as something unified, Thales saw in this unity the presence of many differences having a common primary basis, and thus pointed out the complexity of nature and the principal direction of the analysis of natural phenomena on the way of finding some common primary basis. He considered such a primordial basis to be "wet nature," in modern terms, hydromechanics.

Later Empedocles (490-430 B.C.) proposed the four "elements" - earth, water, air, and fire - as such a primordial basis, indicating that every object and every phenomenon consists of a combination of these four elements.

Empedocles thought is much deeper than it is usually presented to historians. In fact, if we understand the concepts of elements used by Empedocles in a somewhat broader way, for example, "earth" - solid (solid state), "water" - liquid, "air" - gas, and "fire" - energy, then we actually encounter a reference to the three basic states of matter - solid, liquid and gaseous - and the energy inherent in it. It should be noted at the same time that not giving each of these states any additional properties means that the "elements" introduced by Empedocles were meant to be elementary in their basis, endowed with a single quality.

The development of alchemy in the Middle Ages raised the question of another system of elements of which all bodies are composed. The "substances", in particular metals, sulfur and some others, each of which was endowed with a limited group of qualities, were singled out. The idea of the genesis of substances expressed by R. Bacon (1214-1292) is actually an attempt to synthesize the complex from the simple. Thus, even at this stage of development of ideas about the structure of matter, complex substances are implied to consist of simple ones possessing a minimum of qualities [19].

The development of chemistry led to the idea of the smallest particle of matter possessing all the chemical properties of a given substance. Although the official term "molecule" was legitimized by the International Congress in Karlsruhe only in 1860, the term and the

its actual meaning had been known to Lavoisier (1743-1794) long before. It is true that Lavoisier made the following admission: "...If by the name of *element* we want to designate *simple* bodies and *indivisible molecules* of which bodies are composed, it is very likely that we do not know them" [21, 22]. [21, 22].

Nevertheless, the logic is preserved here as well: a complex object - a body is assumed to consist of simpler ones - molecules. Moreover, the substances that could not be decomposed, Lavoisier called simple, thus confirming the generality of the method.

Further penetration into the depth of matter is associated with the name of J. Dalton (1766-1844). In [23] Dalton notes: "...I have chosen the word *atom* to designate these primary particles, preferring it to the words 'particle', 'molecule' or any other diminutive names because this word seems to me considerably more expressive: it includes the idea of indivisibility, which other designations do not." Dalton suggests:

"...All atoms of the same kind, indifferently simple or complex, must necessarily be regarded as identical with each other in form, appearance, and all other features."

And although later studies showed that it was not so, the idea of the sameness of atoms, i.e. metaphysical limitation of properties, giving simplicity to the element-brick of which more complex formations - molecules, substances, bodies - are composed, was an absolutely necessary condition for the possibility of analyzing and synthesizing matter at this stage of development of natural science.

The fact of the diversity of atoms, the presence of radiation emanating from some of them, the transformation of atoms of some substances into atoms of other substances, established at the beginning of the twentieth century, showed that atoms are not the simplest and indivisible formations of matter. The planetary model of the atom proposed by Rutherford in 1911 made it possible to formulate the concept of "elementary particles" that make up atoms. Elementary particles were ascribed several limited properties, among which one of the main ones was their indivisibility. Thus, at this stage of development, atoms were recognized as complex entities, and all their diversity was explained by simple combinations of elementary particles. It wasn't until we penetrated deeper into the atomic nucleus that we discovered that the atoms themselves

"elementary particles" are not elementary at all.

Summarizing the above, we can note a common methodological approach to the analysis of the structure of matter at all stages of the development of natural science. This methodology consists in the following:

The accumulation of facts about the diversity of properties, forms and motion of matter raises the question about the complexity of already studied forms of matter and about the presence of common forms and properties of matter at a level deeper than the already mastered level. These forms and properties: a) are simple in the sense of a small number of essential qualities attributed to them; b) arise from the forms and peculiarities of the motion of matter at the previous (older) level of the organization of matter; c) are only a part of all the properties of matter at the considered (younger) level of the organization of matter, which at the initial stage of mastering this level of the organization of matter has to be temporarily neglected, at least until the accumulation of the necessary data.

In the future, with the accumulation of new data, material formations of this level will again appear to be complex, and again it will be necessary to introduce ideas about an even deeper level of organization of matter, the "bricks" of which will again be temporarily considered simple.

It should be noted that the properties of matter found at a new level of organization can only be essential, for only such of them as explain the variety of forms and properties of matter at the previous level of organization are distinguished. Thus, in contrast to the subjective notion of the "simplicity" of a phenomenon described above, when studying the properties of matter at different levels of organization, we deal with the dialectical notion of simplicity.

The found general methodological principle should be applied at the present time, since enough data have been accumulated on the complexity of "elementary" particles of matter, on their diversity, as well as on their mutual transformations, indicating the presence of their common building material.

It follows from the above that it is necessary to analyze the interaction behavior of "elementary particles" of matter, to single out characteristics common to all kinds of interactions on the basis of this analysis, to give the properties of *elementarity* to new, smaller formations of matter, which are the building material for "elementary particles" of matter, to deduce from their properties various forms of their motion, to build on the basis of these forms all kinds of interactions of senior forms, starting from "elementary particles" of matter to the Universe as a whole, as well as to predict

The methodological principle outlined above has been repeatedly used by various researchers in relation to private

problems of the kinetic theory of matter, for example, by Boltzmann [14] and also by A.K. Timiryazev [24], and quite successfully.

Conclusions

1. The main goal of natural science should be to reveal the nature of phenomena, i.e. to reveal the internal mechanism of phenomena, cause-and-effect relations between the material entities involved in them, and on the basis of their generalization to find general laws of the structure of nature. The existence of internal mechanisms of phenomena presupposes the existence of causal relations, i.e. determinism.

2. Recognition of the fact of causality raises the question about the nature of elementary interactions within phenomena, these interactions between elements can occur only through direct contact in a common point of space, thereby fundamentally rejecting the "principle of long-range action", assuming the interaction of bodies through the void, and asserting the principle of close action at any level of organization of matter.

3. Every object and every phenomenon has countless sides and qualities, so every concrete description (model, mathematical formula, verbal and graphical description, etc.) is an approximation. This means that representations of objects and phenomena must be continuously refined by improving physical models and their mathematical description. It also means that the improvement of fundamental dependences of physics, reflecting only a part of general regularities of nature, should be one of the most important tasks of theoretical physics.

4. Any mathematical (logical, functional, quantitative) description should be preceded by a qualitative description - construction of models of objects and phenomena. Models should reflect the qualitative sides of objects and phenomena, explain them from the qualitative side, i.e. reduce them to a set of parts, each of which can be considered already understandable in its basic properties, and their interaction. Hence the fundamental importance of applying analogies to known objects and phenomena and justifying the legitimacy of applying certain analogies in specific cases.

5. When constructing general physical theories, the fundamental importance is the definition of universal physical invariants - categories that do not change their properties under any transformations and interactions of physical bodies. General physical invariants should not be postulated, but defined on the basis of a generalized analysis of all known physical interactions and phenomena. The criterion of selection of universal physical invariants is correspondence to the fact of presence of these categories in all material entities and phenomena of nature without exception.

6. Categories that do not satisfy the principle of universality cannot be universal physical invariants. Thus, such categories as the four-dimensional interval or the speed of light are proclaimed by Einstein's theory of relativity as universal invariants inappropriately. It is even more inappropriate to extend electromagnetic concepts (speed of light) to gravitational phenomena in the General Theory of Relativity, claiming to be a "theory of gravitation", since gravitational phenomena have no relation to electromagnetism.

7. The carried out generalized analysis shows that matter, space and time, which means the motion of matter, are the categories present everywhere, therefore these categories everywhere act as universal physical invariants - primary concepts, in relation to which all other physical laws should be considered.

As universal physical invariants, matter, space and time and their aggregate - motion have the properties of presence in all structures and phenomena, primordially, preservation under any transformations, infinite divisibility, additivity, linearity, unlimitedness.

This means, in particular, Euclidean real physical space, uniformity and unidirectionality of time, eternity and indestructibility of matter, space, time and motion, preservation of the Universe in the average form and absence of any "beginning" or "end". The Universe as a whole is stationary and dynamic, there is a continuous series of processes in it, which are all without exception connected with the movement of matter in space and thus are mechanical processes.

8. It follows from the properties of universal physical invariants for macro- and microcosm that there are no preferred scales for motion, matter, space and time and, therefore, at all levels of organization of matter in macro- and

The same physical laws apply in the microcosm and there are no "special" physical laws in the microcosm. This allows us to use analogies of the macrocosm when analyzing phenomena and developing models of the structures of material objects.

9. The main direction of the development of natural science has always been the development in the depth of the hierarchical organization of matter. The next stage of development was marked by the introduction of ideas about new material entities, smaller in mass and size. These material formations were temporarily attributed to the simplest in terms of form and form interaction.

10. The structural organization of matter extends infinitely deep and upward through hierarchical levels. The total number of levels is infinite, the total amount of matter, space, time and motion in the Universe is infinite. However, each specific process encompasses a limited amount of matter, space, time and motion. The latter, in particular, means the limit of propagation in space and time of any fields and interactions.

11. All provisions of the methodology of ether-dynamics fully correspond to the provisions of dialectical materialism.

Chapter 4. The Structure of Ether .

Experience has shown that new discoveries have been arrived at almost exclusively by means of specific mechanical conceptions. ...Could it not be that the currently fashionable trend, which is negative to any special conceptions, as well as the recognition of qualitatively different kinds of energy, could be a step backwards?

L. Boltzmann [1]

The recognition of an ether in which mechanical motions can take place, i.e., spatial displacements of elementary volumes of this "prime matter" that continuously fills our entire three-dimensional space, is not in itself a sign of a mechanistic point of view.

V.F.Mitkevich [2].

4.1. Structure of ether

The methodology outlined above allows us to approach the definition of the properties of the ether.

The basic properties of the ether as a world medium, which is the basis of the structure of all kinds of matter and responsible for all kinds of interactions, should be deduced only on the basis of analyzing the general properties of the real world. Considering also that the ether is supposed to be a world medium, i.e. a medium filling the whole world space, it is necessary to analyze the most characteristic properties of the vacuum of outer space to determine its properties. And, taking into account that the ether elements should be considered simultaneously as a building material of all material formations, including the smallest of the studied - elementary particles of matter, to determine the properties of the ether elements it is necessary to analyze the most general sides of the interaction of elementary particles of matter.

When determining the properties of the ether from the general properties of the real world, it should be taken into account that matter, space and time are invariants, hence, neither matter, space nor time have any special properties at the level of the microcosm and at the level of the ether. This means that the ether obeys the same physical laws as the macro- and microcosm. Hence it immediately follows that the ether must represent one of the usual media - solid, liquid or gas, for there are no other media in the macrocosm. At the same time, of all the infinite variety of properties of the real world, the first and foremost

It is necessary to take into account the properties related to the energy transfer of interactions and to the structural transformations of matter. Let us consider the characteristic phenomena of the macrocosm and the resulting requirements for the ether as a medium filling the entire world space.

It is known from the practice of natural science that outer space is isotropic with respect to the propagation of any energy fields and perturbations. From this property of cosmic space immediately follows the isotropy of the medium filling it, as well as the property of this medium to fill naturally this space without voids and dislocations.

In fact, light, radio waves and gravitational fields propagate uniformly in all directions on average in outer space. Electric, magnetic and nuclear fields also do not favor any direction in space. Thus, there is no reason to attribute any anisotropy to space, and consequently to the medium filling it in the absence of matter.

The absence of anisotropy in the medium filling the outer space means that this medium can be neither a liquid nor a solid, as it was assumed by many authors earlier. Under the conditions of weightlessness, the liquid under the action of surface tension forces should gather into balls, which would lead to the formation of voids between the balls. Any real physical solid is characterized by dislocations of one kind or another. Both of them would lead to non-uniform distribution of fields in vacuum.

However, ether can be a gas-like body, since such a body has the property of naturally filling all the space given to it without voids or dislocations, and even averaging its distribution if it is disturbed for some reason.

From the fact of small resistance of the ether to the motion of bodies, in particular, it follows that the ether must have a relatively small density and low viscosity. If the ether possessed large forces of adhesion between its parts, this would affect the motion of the planets, but this is not observed. A gas-like medium also satisfies this requirement well, unlike, for example, a solid.

The known large velocities of propagation of perturbations in space make us believe that the ether has a large elasticity, which was the reason why some authors considered the ether as a solid body. However, a large elasticity is characteristic not only for a solid body, but also for any body provided that the energy of interactions

between its particles is reactive and is not converted into heat, i.e. the medium has low losses. Both solids, liquids and gases meet the requirements of high elasticity.

Thus, according to the totality of all requirements, only a gas-like medium satisfies the properties of the macrocosm.

Let us consider some characteristic phenomena of the microcosm and the resulting requirements for an element of the medium.

As is known, the so-called elementary particles of matter possess the property of mutual transformation. It is even known the expression that any elementary particle consists of all others, i.e. as a result of interaction between two or more particles a very wide spectrum of particles of another kind can be obtained. Thus there are no such elementary particles which could not be decomposed into other particles or would not be obtained as a result of fission of other particles. Nor are there separate groups of particles that do not pass into each other. All this means that all elementary particles of matter consist of the same parts, of the same building material, and the well-known experimental fact of "birth" of particles in vacuum at a certain ratio of fields can be considered as a fact of organization of the same building material contained in vacuum into elementary particles of matter. If there were no such material in vacuum, there would be nothing for them to form from. Hence, there is a unity of matter of physical vacuum and matter of elementary particles of matter.

Consideration of interactions of matter particles with each other, as a result of which there is a transformation of their forms and species, shows that these interactions are the result of mechanical movement of particles in space. At these interactions all mechanical parameters - energy and momentum - are conserved. If we consider matter to be indestructible, then the defect of masses occurring in a number of collisions can be attributed to the transition of a part of matter from the composition of particles to the environment surrounding them. Consequently, the interaction of elementary particles of matter is based on the laws of mechanics.

Parts of elementary particles of matter also move in space as part of these elementary particles themselves. This ordered motion is observable by modern measuring instruments. After that as a result of interaction and transformation of "elementary particles" of matter a part of matter has passed from the composition of particles into the environment, which is manifested as a defect of masses, this part of matter at the modern level of measuring means is observed by the modern measuring means.

of technology becomes unobservable by modern instruments. This does not mean, however, that it does not exist, and the fact of non-observability should be regarded as temporary: it may happen that sooner or later the appropriate instruments will be created and what cannot be observed today will become observable in the future.

In his time, the famous physicist Pontecorvo, faced with a mass defect, decided that the missing mass was carried away by a small particle that had no charge. By analogy with the neutron, he called it "neutrino", which means "small neutron". In principle, there should be no objection to this interpretation of the mass defect. However, attention should also be paid to another possibility - the dispersion of the liberated ether in the surrounding space without the formation of new particles. This possibility has not been taken into account by physics up to now.

Thus, the idea of the ether as a gas-like medium can also be accepted on the basis of the analysis of the behavior of elementary particles at their interactions.

The question arises, how the particles of ether can be held in the composition of elementary particles of matter, if ether is a gas? The answer to this question is not difficult if we take into account that elementary particles of matter are toroidal vortex formations of compacted gas-like aether. The basis for this statement is the fact that toroidal vortices are the only form of motion capable of holding a compacted gas in a closed volume.

The difference in the specific mass of elementary particles of matter requires the assumption of compressibility of the medium within wide limits, a property possessed only by gas-like medium. Significant forces and energies of interactions between bodies can be easily explained by large pressures and elastic forces, which gas is able to possess due to the high speed of movement of its particles in space.

The joint consideration of all the listed properties of the real world allows us to come to the unambiguous conclusion that the ether, the world medium filling all world space, forming all kinds of matter and responsible for all kinds of interactions, is a real, i.e. viscous and compressible, gas. This gas consists of substantially smaller particles than the elementary particles of matter, which it is reasonable to call as they were called in ancient times by Democritus - *atomes*, i.e. physically indivisible parts of matter. Of course, they have the property of indivisibility

are endowed conditionally, temporarily, until the accumulation of data on the diversity of amers and their mutual transformations and transformations.

Table 4.1.

Qualitative determination of the basic properties of ether

Properties of the real world	Properties of ether
<i>Macromir</i>	
The invariants of all matter, phenomena -matter, space, motion	physicalInvariants of the ether are spacetime, time, motion time,
Isotropy of characteristics of matter and fields in space	The natural filling by ether of space without voids and dislocations
Low resistance to movement	Low density and viscosity
High velocities of propagation-interactions	Great resilience
<i>Micromir</i>	
Mutual transformation of all elementary particles of matter of	Possibility offormation of different structures
The condition of mutual transformations of stable "elementary particles" - mutual collisions with preservation of mechanical parameters of motion - energy and momentum	Elements of the ether should provide possibility of mutual collisions with preservation of mechanical parameters of motion - energy and momentum
Holding matter within stable "elementary particles" of matter	Existence of the forms of motion that ensure the retention of the ether in the composition of the material Entities
Difference in specific densities "elementary particles" of matter	The compressibility of the ether in wide within

Conclusion: aether **is a** gas-like body with the properties of a real gas.

Movements of amers in space and their mutual collisions make us believe that parts of amers are also characterized by the laws of mechanics and that parts of amers also form a medium filling the world space. This medium is also gas-like, its elements are smaller than amers, and the velocities of movement in space are essentially higher than the velocities of movement of amers. The aggregate of these particles in space constitutes aether-2, which is finer than aether-1 formed by amers. However, the same logic applied to aether-2 makes us consider its elements to consist of ether-3 and so on to infinity.

The insufficiency of data on the properties of ether-1, which in the following we will call simply ether, forces us to limit ourselves to the definition of the properties of this ether only (Table 4.1).

All laws of ordinary gas mechanics apply to the ether, since the same laws apply at all levels of organization of matter. Gas mechanics has passed a certain way of development in other fields of natural science and now can be successfully used for calculations of parameters of the ether itself, as well as of all material formations, the building material for which it is, and of all kinds of interactions, which it causes by its movements.

4.2. Determination of numerical values of the parameters of ether

The numerical values of the parameters of the ether in the near-Earth space as a real viscous compressible gas can be determined on the basis of experimental data characterizing some or other physical processes taking into account the ether-dynamic ideas about the essence of these processes. Since physical phenomena are mostly investigated in terrestrial conditions, it is possible to speak about the values of the ether parameters only in the space directly surrounding the Earth, extending them to other regions of the Universe only as the conditions of the ether in these regions are clarified. Parameters of the ether, such as density, pressure, temperature, etc., can differ essentially in other regions of the Universe from parameters of the ether in the near-Earth space. These differences can in principle be judged on the basis of extraterrestrial studies, astronomical observations, etc. Parameters of the aether inside a substance also essentially differ from parameters of the aether in vacuum. In this

The paragraph calculates only the parameters of the aether in the matter-free near-Earth space. The calculations are made on the basis of the ideas about the ether dynamical essence of the electric field around the proton and about the internal structure of the proton itself. The first gives the basis for determining the mass density of the aether, the second for determining the lower boundary of the pressure in the aether. All other parameters are obtained by simple calculations using gas dynamics relations [3-12].

Aether density in free space. As will be shown in § 6.1 and 8.6, the dielectric permittivity of the vacuum ϵ_0 is the density of the aether ρ_a in matter-free space. This follows directly from the comparison of the energy of the electric field of the proton w_{ep} and the energy of the circular motion of the aether w_k around the proton, identified with the electric field of the proton (in the presence of toroidal motion of the aether around the proton), since.

$$w_{ep} = \int_{r_p}^{\infty} \frac{\epsilon_0 E^2}{2} dV; \quad (4.1)$$

$$w_k = \int_{r_p}^{\infty} \frac{\rho_a v_k^2}{2} dV, \quad (4.2)$$

where E is the electric field strength, v_k is the velocity of the circular motion of the aether around the proton, dV is the elementary volume of space around the proton, r_p is the radius of the proton.

From here we see at once that since the exponents of powers ϵ_0 and ρ_a equal to 1, then

$$\epsilon_0 = 8.85 \cdot 10^{-12} \text{ F} \cdot \text{m}^{-1} = \rho_a = 8.85 \cdot 10^{-12} \text{ kg} \cdot \text{m}^{-3}, \quad (4.3)$$

which is quite consistent with the views of O. Fresnel (1823) with respect to the theory of the stationary ether.

Thus, the aether density in near-Earth space appears to be known with high accuracy. For the other parameters we can speak only about orders of magnitudes.

Density of amer (element of ether). The proton is a maximally compressed vortex of ether, in which there is a rarefied volume of ether inside, and the ether in the walls of the proton is compacted, but remains a gas. In the walls of the proton the amers must have a free run, so the density of the amer must be at least two orders of magnitude higher than the density of the proton, which should be considered as the lower limit of the amer density.

The radius of the proton can be determined from the known expression for the effective radius of the atomic nucleus, equal to [3, p.457]

$$R = aA^{1/3}, \quad (4.4)$$

where A is the number of nucleons in the atomic nucleus, a is the radius of the nucleon. For the hydrogen atom nucleus, $a = r_p = 1.12 \text{ f} = 1.12 \cdot 10^{-15} \text{ m}$.

The volume of the proton will be

$$V_p = \frac{4}{3} \pi r_p^3 = \frac{4}{3} \pi \cdot 1.12^3 \cdot 10^{-45} = 5.88 \cdot 10^{-45} \text{ m}^3, \quad (4.5)$$

and, consequently, the average nucleon density ρ_p can be determined by the ratio of the mass of a nucleon (proton, neutron) to its volume. Considering that the proton mass $m_p = 1.6725 \cdot 10^{-27} \text{ kg}$ and its radius $r_p = 1.12 \cdot 10^{-15} \text{ m}$, we get

$$\rho_p = \frac{m_p}{V_p} = \frac{1.6725 \cdot 10^{-27}}{5.88 \cdot 10^{-45}} = 2.8 \cdot 10^{17} \text{ kg} \cdot \text{m}^{-3}. \quad (4.6)$$

Adding two orders of magnitude, we have the lower value of the amer density

$$\rho_a = 3 \cdot 10^{19} \text{ kg} \cdot \text{m}^{-3}. \quad (4.7)$$

The ratio of the diameter of an amer to the average length of its free passage. The density of ether ρ_e in free space can be expressed through the mass of amer m_a and the number of amers in unit volume n_a as follows

$$\rho_e = m_a n_a. \quad (4.8)$$

The number of amers in a unit volume of free ether is determined by the mean free path length λ_a and $\sigma_a = \pi d_a^2/4$ - its cross-sectional area, where d_a is the diameter of the amer [4, p. 209]:

$$n_a = \frac{1}{\sqrt{2} \lambda_a \sigma_a} \quad (4.9)$$

mass of an amer is

equal to

$$m_a = \rho_a V_a, \quad (4.10)$$

where the volume of amer V_a will be

$$V_a = \frac{\pi d_a^3}{6} \quad (4.11)$$

Hence.

$$\rho_a = \rho_a V_a n_a = \rho_a \frac{\pi d_a^3 - 4 \sqrt{2} d_a}{6 \sqrt{2} \lambda_a \sigma_a 3 \lambda_a} = \rho_a, \quad (4.12)$$

whence the ratio of the free path length of the amer to its diameter will be:

$$k_\lambda = \frac{\lambda_a}{d_a} = \frac{\sqrt{2} \rho_a}{3 \rho_a} = \frac{\sqrt{2} \cdot 3 \cdot 10^{19}}{3 \cdot 8,85 \cdot 10^{-12}} = 1,6 \cdot 10^{30} \quad (4.13)$$

Let us determine the *pressure of the aether in free space* P_a from the idea that the momentum in the transverse relative to its direction of motion an amer can transfer to another amer located in the neighboring layer only at touching. Then

$$P_a = P_\mu \lambda_a / d_a. \quad (4.14)$$

Here P_μ is the value inverse to the magnetic permeability of vacuum, i.e.

$$P_\mu = 1/\mu = 1/4 \pi \cdot 10^{-7} = 8 \cdot 10^5 \text{ N} \cdot \text{m}^{-2}. \quad (4.15)$$

The physical meaning of this pressure is the transfer of energy to the transverse to the amer's motion. Hence

$$P_{\vartheta} = P_{\mu} \lambda_a / d_a = 8 \cdot 10^5 \cdot 1.6 \cdot 10^{30} = 1.3 \cdot 10^{36} \text{ N}\cdot\text{m}^{-2}. \quad (4.16)$$

Energy content unit volume of ether (heat content energy) is equal, as for any gas, to its pressure, i.e.

$$w_3 = Re = 1.3 \cdot 10^{36} \text{ J} \cdot \text{m}^{-3}. \quad (4.17)$$

For comparison it is expedient to remind that one megaton hydrogen bomb at explosion releases energy in $5 \cdot 10^{15}$ J and, consequently, 1 cubiccentimeter of freeether contains energy corresponding to explosion, approximately, 200 thousand billion megaton bombs, and 1 cubic meter of free ether - 1 million times more.

The average speed of thermal motion of an amer in free space will be determined from the energy content of a unit volume of ether as

$$u_a = \left(\frac{2w_{3/2}}{\rho_3} \right)^{2-1} = \left(\frac{3 \cdot 10^{36/2}}{8.85 \cdot 10^{-12}} \right)^{2-1} = 5.4 \cdot 10^{23} \text{ m/s} \quad (4.18)$$

The velocity of the first sound (propagation velocity of the longitudinal disturbance) is equal to

$$v_1 = \frac{u_a}{1,24} = \frac{5.4 \cdot 10^{23}}{1,24} = 4.34 \cdot 10^{23} \text{ m} \cdot \text{s}^{-1}. \quad (4.19)$$

The speed of the second sound (the speed of propagation of temperature waves in the ether, aka the speed of light) is equal to

$$v_2 = 3 \cdot 10^8 \text{ m} \cdot \text{s}^{-1}. \quad (4.20)$$

The dynamic viscosity (internal friction coefficient) η can be determined from the equation for the transverse pressure in the boundary layer of a viscous gas (analog of Newton's equation for the motion of a viscous fluid [4, p. 210]):

$$dFu = \eta dS dv/dx, \quad (4.21)$$

from
where

$$\eta = \frac{dF}{dS} \cdot \frac{dx}{dv} = \text{Re} \frac{\Delta x}{\Delta v} = \text{Re} \cdot \text{---}. \quad (4.22)$$

With the proton radius $r_p = 1.12 \cdot 10^{-15}$ m and the effective radius of interaction of nucleons in the deuterium nucleus $r_n = 1.2 \cdot 10^{-15}$ m, we define the boundary layer thickness as

$$\delta = r_n - r_p = 8 \cdot 10^{-17} \text{ m.} \quad (4.23)$$

As will be shown in Chap. 6, the relative velocity of the aether on the proton and neutron wall surfaces facing each other is

$$\Delta v = 3 \cdot 10^{21} \text{ m} \cdot \text{s}^{-1} \quad (4.24)$$

and dynamic viscosity can be defined as

$$\eta = P_{\text{a}} \frac{\Delta x}{\Delta v} = 1.3 \cdot 10^{36} \frac{8 \cdot 10^{-17}}{3 \cdot 10^{21}} \approx 3.5 \cdot 10^{-2} \text{ kg} \cdot \text{m}^{-1} \cdot \text{s}^{-1}. \quad (4.25)$$

Kinematic viscosity is equal to the ratio of viscosity to density

$$\chi = \eta / \rho, \quad (4.26)$$

and, therefore,

$$\chi = \frac{3.5 \cdot 10^{-2}}{8.85 \cdot 10^{-12}} \approx 4 \cdot 10^9 \text{ m}^2 \cdot \text{s}^{-1} \quad (4.27)$$

The diffusivity for a normal viscous compressible gas is the same in magnitude as the kinematic viscosity:

$$a = \chi \approx 4 \cdot 10^9 \text{ m}^2 \cdot \text{s}^{-1}. \quad (4.28)$$

The average free path length of amers outside the substance can be determined from the expression [4, p. 211; 5, 6] as

$$\lambda_a = 3\chi / u \approx 4 \cdot 10^9 / 5.4 \cdot 10^{23} = 7.4 \cdot 10^{-15} \text{ m.} \quad (4.29)$$

The diameter of the amer will be determined from a simple relation

$$d_a = \lambda_a / k\lambda = 7.4 \cdot 10^{-15} / 1.6 \cdot 10^{-30} = 4.6 \cdot 10^{-45} \text{ m.} \quad (4.30)$$

The cross-sectional area of the amer will be as follows

$$\sigma_a = \pi d_a^2 / 4 = \pi (4.6 \cdot 10^{-45})^2 / 4 = 1.66 \cdot 10^{-89} \text{ m}^2. \quad (4.31)$$

The volume of the amer is

$$V_a = \pi d_a^3 / 6 = \pi (4.6 \cdot 10^{-45})^3 / 6 = 5.1 \cdot 10^{-134} \text{ m}^3. \quad (4.32)$$

The number of amers in a unit volume of free ether would be

$$n_a = 1 / \sqrt{2} \cdot \lambda_a \sigma_a = 1 / 1.41 \cdot 7.4 \cdot 10^{-15} \cdot 1.66 \cdot 10^{-89} = 5.8 \cdot 10^{102} \text{ m}^{-3}. \quad (4.33)$$

The mass of the amer can be determined from the density of the ether:

$$m_a = \rho_s / n_a = 8.85 \cdot 10^{-12} / 5.8 \cdot 10^{102} = 1.5 \cdot 10^{-114} \text{ kg}. \quad (4.34)$$

The density of the amer body is thus equal to

$$\rho_a = m_a / V_a = 1.5 \cdot 10^{-114} / 5.1 \cdot 10^{-134} = 3 \cdot 10^{19} \text{ kg} \cdot \text{m}^{-3}. \quad (4.35)$$

The temperature of the ether, as of any gas, is determined by the expression:

$$T = m u_a^2 / 3k = 1.5 \cdot 10^{-114} \cdot (5.4 \cdot 10^{23})^2 / 3 \cdot 1.38 \cdot 10^{-23} = 10^{-44} \text{ K}. \quad (4.36)$$

The specific heat capacity of ether at $P = \text{const}$ is found from the expression

$$c_p = 3k / 2m_a = 3 \cdot 1.38 \cdot 10^{-23} / 2 \cdot 1.5 \cdot 10^{-114} = 1.4 \cdot 10^{91} \text{ m}^2 \cdot \text{s}^{-2} \cdot \text{K}^{-1} \quad (4.37)$$

where $k = 1.38 \cdot 10^{-23} \text{ J} \cdot \text{K}^{-1}$ is Boltzmann's constant.

The specific heat capacity of ether at $V = \text{const}$ is found from the expression

$$c_v = c_p / (1 + 2/N) = 1.4 \cdot 10^{91} / (1 + 2/5) = 10^{91} \text{ m}^2 \cdot \text{s}^{-2} \cdot \text{K}^{-1}, \quad (4.38)$$

where N is the number of degrees of freedom of the amer (presumably $N = 5$).

The heat transfer coefficient of free ether, as for any gas, is found from the expression

$$\begin{aligned} k_T &= u \lambda \rho_s \text{ with } \nu / 3 = 5.4 \cdot 10^{23} \cdot 7.4 \cdot 10^{-15} \cdot 8.85 \cdot 10^{-12} \cdot 10^{91} / 3 = \\ &= 1.2 \cdot 10^{89} \text{ kg} \cdot \text{m} \cdot \text{s}^{-3} \cdot \text{K}^{-1}. \end{aligned} \quad (4.39)$$

Table 3.2.

Parameters of the ether in near-Earth space

Parameter	magnitude	Unit of measurement
<i>The ether as a whole</i>		
Density	$\rho_9 = 8.85 \cdot 10^{-12}$	kg·m ⁻³
Pressure	$P > 1,3 \cdot 10^{36}$	N·m ⁻²
Specific energy content	$w > 1,3 \cdot 10^{36}$	J·m ⁻³
Temperature	$T < 10^{-44}$	K
The speed of the first sound	$V_1 > 4.3 \cdot 10^{23}$	ms ⁻¹
The velocity of the second sound	$v_2 = c = 3 \cdot 10^8$	ms ⁻¹
Coefficient of thermal conductivity	$a \approx 4 \cdot 10^9$	m ² ·s ⁻¹
Coefficient of thermal conductivities	$kt \approx 1.2 \cdot 10^{89}$	kg·m·s ⁻³ ·K ⁻¹
Kinematic viscosity	$\chi \approx 4 \cdot 10^9$	m ² ·s
Dynamic viscosity	$H \approx 3,5 \cdot 10^{-2}$	kg·m ⁻¹ ·s ⁻¹
Adiabatic index	1 - 1,4	-
Heat capacity at constant pressure	$c_p > 1.4 \cdot 10^{91}$	m ² ·s ⁻² ·K ⁻¹
Heat capacity at constant volume	$c_v > 10^{91}$	m ² ·s ⁻² ·K ⁻¹
<i>Amer (element of ether)</i>		
Weight	$m_a < 1.5 \cdot 10^{-114}$	kg
Diameter	$d_a < 4.6 \cdot 10^{-45}$	m
Quantity per unit volumes	$n_a > 5,8 \cdot 10^{102}$	m ⁻³
Average length free run	$\lambda_a < 7.4 \cdot 10^{-15}$	m
Average speed thermal motion	$u_a \approx 5.4 \cdot 10^{23}$	ms ⁻¹

The number of collisions of each amer in the free ether is determined from the expression

$$\gamma_a = u/\lambda = 5.4 \cdot 10^{23} / 7.4 \cdot 10^{-15} = 7.3 \cdot 10^{37} \text{ with}^{-1} \quad (4.40)$$

Number of collisions of amers in a unit volume of free ether amount to

$$\gamma_a = \gamma_a n_a = 7.3 \cdot 10^{37} \cdot 5.8 \cdot 10^{102} = 4.2 \cdot 10^{140} \text{ s}^{-1}. \quad (4.41)$$

Taking into account the essential difference in the diameter of the amer and the length of its free passage, the ether as a gas by its properties should approach the classical ideal gas, at least in the space free from the matter formed by the compacted ether vortices. It is possible to suppose that for this gas the Boltzmann statistics for coordinates and impulses of the amer is close enough, and the distribution of velocities, apparently, is closely described by the Maxwell distribution, though the presence of viscosity still speaks about some differences in the distribution of parameters of the ether from the specified ones.

All performed calculations and obtained values are indicative (Table 4.2). The parameters of the ether both in near-Earth space and in other regions of the Universe should be specified and rechecked.

4.3. Forms of motion ether

The aether element - amer - has the only form of motion - *uniform translational motion* in space. The interaction of amers with each other is realized in the only way - by elastic collision and, thus, by exchange of the quantity of motion (impulses). This collision with a high degree of approximation can be considered absolutely elastic, i.e. occurring without loss of the quantity of motion.

The aggregate of amers - the elementary volume of the aether - possesses three forms of motion: diffusive, translational and rotational (Fig. 4.1) [7].

The diffusive form of motion of amers in the ether is always there, even when the ether is completely balanced and there is no external motion in it. Therefore, this form of motion is basic, initial for consideration of any other forms of motions.

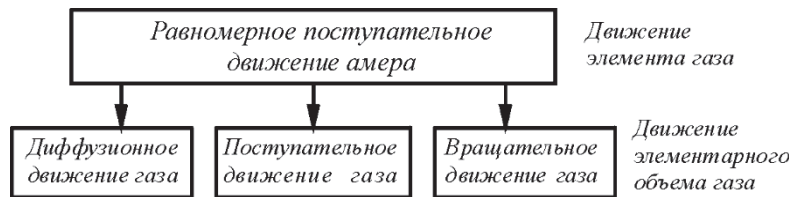

Figure 4.1. Amer motion, forms and types of aether motion

The diffusive form of motion of the ether, like any gas, provides three types of motion: density transfer, transfer of quantity of motion (momentum), and transfer of energy.

The progressive form of ether motion provides two types of motion: laminar flow (like wind) and longitudinal oscillatory (like sound, within the elastic modulus).

The rotational form of aether motion provides two types of motion: open-ended rotational (tornado type) and closed-ended rotational (toroid type).

There are a total of seven major types of movement.

The listed types of motion can give a wide range of combined types of motion corresponding to those or other physical interactions, physical fields and phenomena. Besides, taking into account the interaction of ether flows possessing different forms and kinds of motions, the number of interaction variants can be rather large. However, in all these forms and kinds of ether motions there is a single kind of motion - movement of amers in space and a single kind of their interaction - elastic collision, which is a common basis for all forms of ether motion and for all kinds of organization of matter, starting from elementary particles of matter and ending with the Universe as a whole. From here we can see at once the principal possibility of reducing all kinds of interactions to mechanics - to this or that kind of movement of ether masses in space.

Diffusion form of ether motion (Fig. 4.2)

1. *Density transfer.* Transfer diffusion motion occurs in any gas at both uniformly distributed and non-uniformly distributed densities. Transfer motion tends to equalize the density concentration as well as the concentration of the

masses (self-diffusion), if there is no restoring unequal state cause.

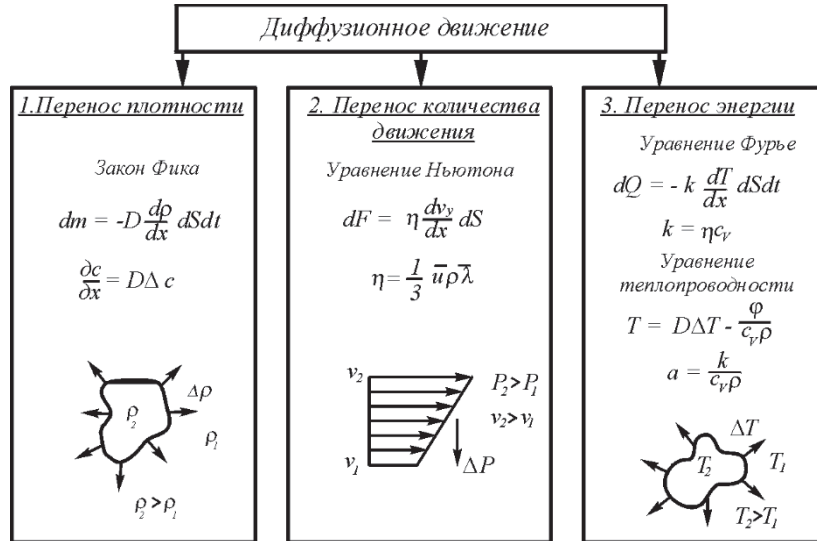

Figure 4.2. Diffusion form of ether motion.

The transport diffusion motion is characterized by some peculiarities connected with the fact that in a one-component medium, which is the ether, the processes of self-diffusion are superimposed on the process of thermodiffusion. Besides, there is no reason to assert that the ether is a one-component system and that the amers are identical among themselves. Rather, on the contrary, amers as vortex formations of ether-2 must inevitably differ and even form complex structures like molecules. However, at present there are also no grounds for such a statement, so the question about the fine structure of the ether, about the real form of amers, types of velocity distributions, peculiarities of interactions of amers among themselves, etc. should be postponed to the future.

The phenomenon of density diffusion in the one-dimensional case is described by Fick's first law [4, p. 212-213]:

$$dM = -D dSdt \frac{d\rho}{dx}, \quad (4.46)$$

where dM is the mass carried for the time dt through the elementary area dS in the direction to the normal x to the considered area in the direction of decreasing density; D is the self-diffusion coefficient; $d\rho_s/dx$ is the density gradient.

In the case of three-dimensional diffusion, the change of concentration c with time at constant temperature and absence of external forces is described by the differential equation of self-diffusion:

$$\frac{\partial c}{\partial t} = \frac{\partial}{\partial x} \left(D \frac{\partial c}{\partial x} \right) + \frac{\partial}{\partial y} \left(D \frac{\partial c}{\partial y} \right) + \frac{\partial}{\partial z} \left(D \frac{\partial c}{\partial z} \right). \quad (4.47)$$

If D does not depend on the concentration, the equation is reduced to the form

$$\partial c/\partial t = D\Delta c \quad (4.48)$$

(Fick's second law), where Δ is the Laplace differential operator; c - concentration of gas particles.

2. *Transfer of quantity of motion (impulse)*. Transfer of the quantity of motion, incorrectly called now in physics as impulse (physically impulse - product of force by time of action - is absent in a separately moving particle, which is characterized by mass and velocity of motion relative to the average velocity of motion of all other particles), is realized in layers of medium moving relative to each other with some velocity. Transfer of the quantity of motion from one layer to another is the cause of viscous friction or gas viscosity.

The transfer of the quantity of motion is determined by Newton's equation for the motion of a viscous fluid [4, p. 210]:

$$dF_x = \eta dS dv_y/dx, \quad (4.49)$$

where dF is the internal friction force acting on the area dS of the layer surface along the surface plane; dv_y/dx is the velocity gradient of the layers in the y direction perpendicular to the layer surface; η is the internal friction coefficient, numerically equal to the friction force between two layers with area equal to unity at a velocity gradient equal to unity.

According to the elementary kinetic theory

$$\eta = u\lambda\rho_s/3. \quad (4.50)$$

A more accurate theory leads to the replacement of the multiplier $1/3$ by a coefficient ϕ depending on the nature of the interaction between molecules. Thus, for molecules colliding as smooth solid balls, $\phi = 0.499$. More accurate models of the interaction forces cause the coefficient ϕ to appear as an increasing function of temperature. For etherrodynamics at the present stage of its development it is too early to raise such questions.

The transport coefficients k and η are independent of the gas density, since the product $\lambda\rho$ is independent of ρ . The viscosity of the gas increases with increasing of temperature is proportional to \sqrt{T} .

3. *Energy transfer.* If there are regions in a gas with different mean statistical velocities of the gas constituent particles - different temperatures - thermodiffusion occurs, as a result of which temperatures can equalize, if heat is not continuously dissipated in space and if no heat is supplied to these regions from outside. Otherwise, some temperature gradient is established.

Heat transfer through a unit of surface is determined by the Fourier equation [4, p. 210]:

$$dQ = -k dS dt dx, \quad (4.51)$$

where $k = \eta c_v$ is the heat transfer coefficient, numerically equal to the amount of heat transferred through a unit surface per unit time at a temperature gradient equal to one; dT/dx is the temperature gradient.

The difference of boundary layer layers is determined by the expression [8, p. 285, 315]

$$\Delta T = (\Delta u)^2 / 2c_p, \quad (4.52)$$

where Δu - velocity difference of layers; c_p - heat capacity of gas at constant pressure.

The relationship between dynamic viscosity and temperature in the boundary layer is defined by the expression

$$\eta / \eta_0 = (T/T_0)^\xi, \quad 0.5 \leq \xi \leq 1. \quad (4.53)$$

Thus, in the boundary layer, in which there is a significant velocity gradient, the gas temperature is lowered and its viscosity is correspondingly lowered. This is of great importance for the stability of vortex formations of the aether.

The equation of heat propagation in the ether, as in any gas, is determined by the expression [9, p. 447-455]:

$$T_t = a\Delta T - f/c_V \rho, \quad a = k_r/c_V \rho_s, \quad (4.54)$$

where $T(M, t)$ is the temperature of the point $M(x, y, z)$ at time t ; $k_r = \text{const}$ is the coefficient of thermal conductivity, a is the coefficient of thermal conductivity; f is the density of heat sources.

Progressive form of the ether motion (Fig. 4.3)

1. *Laminar flow.* Laminar flow of a gas occurs in the presence of pressure difference in two regions of space. At translational motion of gas the diffusive motion is preserved, but the chaotic motion of molecules is superimposed on the ordered motion of molecules in the general direction. The rotational motion of gas volumes is absent in this case. At translational motion, deformation of gas volumes can occur.

The mathematical expressions describing the translational motion of the aether in laminar flow are the well-known hydromechanics equations for a compressible viscous gas, including:

Bernoulli's equation reflecting the conservation of energy in a gas jet (the sum of kinetic and potential energies in a gas jet is conserved in any cross-section of the jet):

$$v^2/2 + \int dP/\rho = \text{const}; \quad (4.55)$$

equation of state:

$$P = \frac{RT}{V} \left[1 + \frac{NB(T)}{V} + \frac{N^2C(T)}{V^2} + \dots \right]; \quad (4.56)$$

the Navier-Stokes equation:

$$\frac{dv}{dt} = - \frac{1}{\rho} \text{grad}P + \nabla^2 v, \quad (4.57)$$

as well as equations describing gas motions in boundary layers, e.g., Karman integral relations and some others.

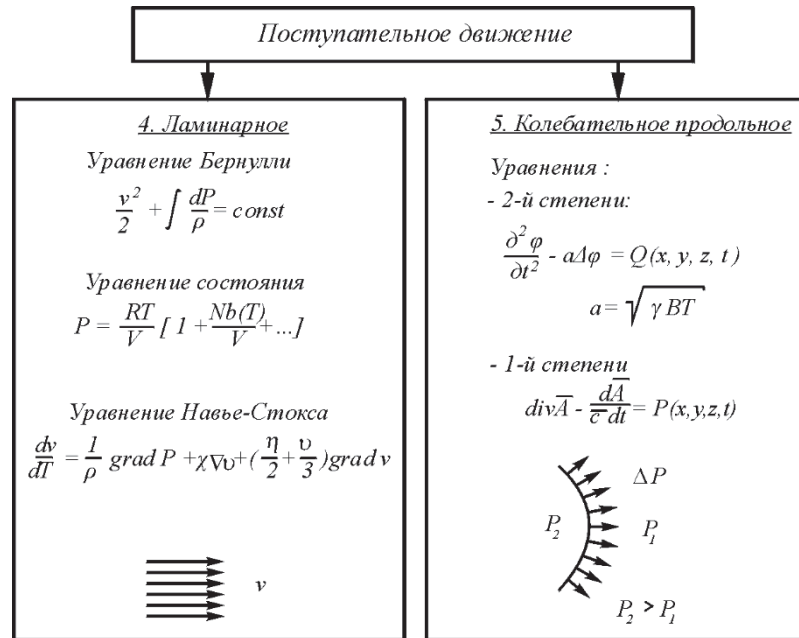

Fig. 4.3. Progressive form of the ether motion.

The peculiarity of the use of the hydromechanical equations with respect to the ether is the absence of volume forces, at least for the initial stage of research, when the fact of the existence of ether-2 is neglected. In all particular cases, when it follows from specific models, it is possible to simplify the equations, for example, to use the Euler equations instead of the Navier-Stokes equation.

A significant simplification is the possibility to neglect viscosity and compressibility in most cases, but only as long as this does not violate the original model of the phenomenon.

For some directions, such as, for example, electrodynamics, the derivation of the equations of which was based on the notion of incompressibility of the ether and its lack of viscosity, at present it is no longer possible to neglect these parameters, since studies have shown their essentiality for many private phenomena.

2. *Longitudinal oscillatory motion in gas (1st sound)* occurs at appearance of small overpressure. The propagation velocity of this excess pressure within the elastic modulus is the sound propagation velocity [5, 6].

The mathematical expression describing longitudinal oscillations in a medium can be a second order wave equation:

$$\frac{\partial^2 \varphi}{\partial t^2} - \text{with } \Delta \varphi = Q(x, y, z, t), \quad (4.58)$$

where $Q(x, y, z, t)$ is the perturbing influence; φ is the scalar potential; c is the propagation velocity of the longitudinal perturbation (the speed of sound), which for a gas is determined by the expression [4, p. 535]:

$$c = \sqrt{\gamma P / \rho} \quad (4.59)$$

Here γ is the adiabatic exponent; P is the pressure; ρ is the density of the gas.

In principle, there are wave equations of the first order, favorably differing from wave equations of the second order by their simplicity and the fact that they do not have to take artificial tricks to destroy one of the solutions giving a divergent expression. Such an equation for a one-dimensional oscillation is the expression

$$\frac{dA}{dx} - \frac{dA_x}{c \, dx \, dt} = P(x, t), \quad (4.60)$$

and for the three-dimensional

$$\operatorname{div} \mathbf{A} - \frac{d\mathbf{A}}{cdt} = P(x, y, z, t); \quad (4.61)$$

the operation of division by vector c is admissible because the direction of this vector exactly coincides with the direction of vector \mathbf{A} in the numerator.

Rotational form of ether motion (Fig. 4.4.)

1. *Open rotational motion* is manifested in turbulence and formed vortices. In open-ended rotational motion, the vortex axis goes to infinity and the rotational velocity decreases with distance from the axis.

In those cases when the compressibility of the ether can be neglected, which takes place, for example, in a substance-free space, the equations of rotational motion correspond to the equations of vortex motion of a viscous incompressible fluid:

$$\frac{d\mathbf{v}}{dt} + \boldsymbol{\Omega} \times \mathbf{v} = -\operatorname{grad} \mathbf{H} - \chi \operatorname{rot} \boldsymbol{\Omega}; \quad (4.62)$$

$$\operatorname{div} \mathbf{v} = 0; \quad (4.63)$$

$$H = \frac{P}{\rho} + \frac{v^2}{2}; \quad (4.64)$$

$$\boldsymbol{\Omega} = \operatorname{rot} \mathbf{v} = \mathbf{G}/\sigma; \quad (4.65)$$

$$G = \int v dl, \quad (4.66)$$

where v is the average translational velocity of particles in the considered point of space; G is the vortex intensity; σ is the vortex area.

However, when considering the structure of matter by the compressibility of the vortex cannot be neglected, since the fact of such compressibility becomes decisive in explaining the behavior of the ether. In this case the equations can become essentially complicated. Of special importance is the selection of those factors from the totality of factors,

which are essential in each particular case, such as viscosity and temperature when considering boundary layer processes.

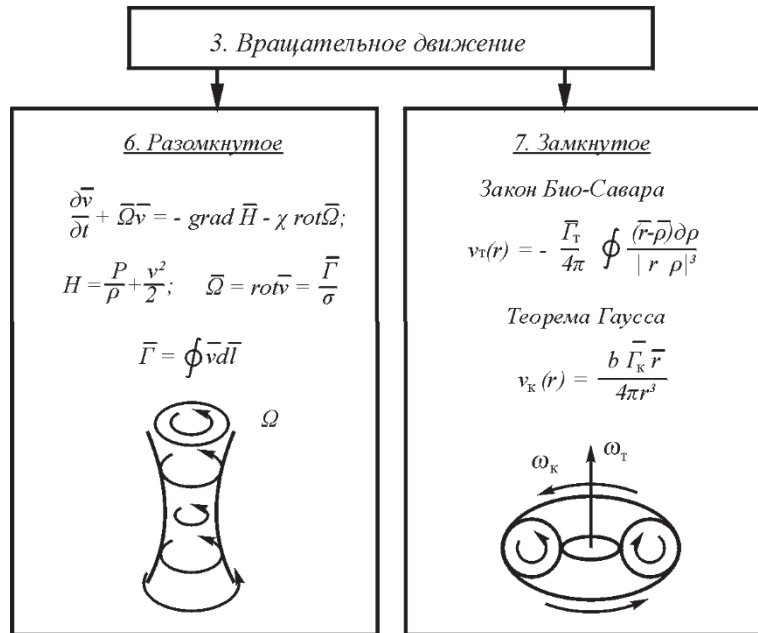

Figure 4.4. Rotational form of the ether motion

2. The closed rotational motion is the toroidal motion of the gas. In addition to the above relations, the Bio-Savar law can be used to describe toroidal motion in the case when the compressibility and viscosity of the gas can be neglected:

$$v(r) = - \frac{\Gamma}{4\pi} \int \frac{(r-\rho) d\rho}{|r-\rho|^3}, \quad (4.67)$$

where ρ is the radius-vector.

Closed rotational motion of the ether is the basis for the structures of various material formations at the level of organization of matter such as elementary particles.

Conclusions

1. Comparison of the general properties of the macro- and microcosm showed that the world space is filled with a material medium having the properties of a real, i.e. viscous and compressible, gas. This medium, as before, should be called aether, the element of the medium should be called a'mer (according to Democritus).

2. Ether is the building material for all kinds of material formations, from elementary particles to stars and galaxies. Force physical fields are the consequence of various forms of ether motion.

3. When determining numerical values of the ether parameters, it is possible and reasonable to use the apparatus of ordinary gas mechanics. The calculations made allowed us to tentatively determine the main parameters of ether in near-Earth space - its density, pressure, specific energy content, temperature, velocity of the first and second sounds, thermal diffusivity and thermal conductivity coefficients, kinematic and dynamic viscosity, adiabatic index, heat capacity at constant volume and constant pressure, as well as the parameters of amer - its mass, dimensions, quantity per unit volume, mean free path length, mean thermal motion velocity.

4. The analysis of the forms of motion of the ether as a gas-like body has shown that the elementary element of the ether - amer - possesses a single form of motion - uniform translational motion in space; the elementary volume of the ether possesses three forms of motion - diffusive, translational and rotational, thus:

diffusion form provides three types of motion - density transfer, motion quantity transfer and energy transfer;

progressive form - two types of motion - laminar flow and longitudinal oscillatory motion;

rotational form - two types of motion - open (tornado type) and closed (toroid type). There are seven types of ether motion in total.

All the above forms and types of motion are described by the known mathematical dependencies of ordinary gas mechanics.

5. Neglecting the internal peculiarities of amer structure and internal forms of matter motion at the level of matter motion deeper than ether-1 is a temporary, epistemological technique. Amer is a complex formation, but the study of the next levels of matter organization is the task of the next stages of development of ether-dynamics.

Chapter 5. Structure of gas vortices

Matter, as an objective reality existing independently of our consciousness, has a wide variety of forms.

T. Erdei-Gruz [1].

5.1. A brief history of the theory of vortex motion

A brief history of the theory of vortex motion is given in [2].

The beginning of the modern theory of vortex motion was laid by G. Helmholtz, who published in 1858 his memoir "On the integral of hydrodynamic equations corresponding to vortex motion" [3, 4], in which he first formulated the vortex conservation theorem [3, 4], in which he first formulated the vortex conservation theorem. According to this theorem, with forces satisfying the law of conservation of energy, it is impossible to create or destroy an already existing vortex and, moreover, it is impossible even to change the tension of the latter. The origin and extinction of vortices observed in nature are entirely determined by passive friction forces. Only due to these forces the vortex is realized, and they also force the born vortex to extinguish.

The integrals of the hydrodynamic equations, from which the vortex conservation theorem follows as a consequence, were derived as early as 1815. by Cauchy. But Cauchy was interested only in the analytical side of the matter. The geometrical interpretation of his results belongs to Helmholtz. Only after that the group of questions and problems which now constitute the subject of the doctrine of vortices arose.

However, we must not fail to mention that special cases of the vortex conservation theorem were already known to Lagrange. In his "Analytical Mechanics", published in 1788. [5], he proves that the motion of an ideal fluid, having a velocity potential at any moment of time, remains so for the whole time of motion. Further, Cauchy and Stokes proved that any particle of an ideal fluid never receives rotation from the environment if it did not possess it at the initial moment of time.

In 1839 the Swedish scientist Svenberg proved the following theorem: angular velocities of rotation of particles in different positions of its trajectory are always inversely proportional to the squares of its distance from the trajectory of motion. Hence the conclusion: a particle of liquid, having received at any moment an angular velocity, will never stop

rotate and, conversely, a fluid particle will not rotate if at the beginning of its motion its angular velocity was equal to zero.

In the above-mentioned Helmholtz's memoir, the principle of vortex conservation was justified in its entirety. Moreover, the rule for determining the velocities of vortex cords in an ideal incompressible liquid and those parts of the liquid mass where there are no vortices is also stated there. The analogy between the velocities of motion of fluid particles and the forces of action of galvanic currents on a magnetic pole is also indicated by him.

All subsequent works appearing after 1853 are essentially extensions and generalizations of the main results obtained by Helmholtz .

The Italian scientist Beltrami, using the theorems derived by Helmholtz, gave a rule for determining the velocities of particles of a compressible fluid in vortex motion and closed by a finite volume. This rule, which establishes electrodynamic analogies, is known as Beltrami's theorem [6].

A major step forward after Helmholtz was made by Kirchhoff. In his "Lectures on mathematical physics" [7] he gave differential equations of motion of rectilinear and parallel vortex cords in an unbounded mass of incompressible fluid. He also indicated four integrals of these equations.

Based on Kirchhoff's equations, Grebl in 1877 solved several problems on the plane motion of three, four and $2n$ vortices. In the problem on the motion of four vortices Grebl limits the existence of a plane of symmetry in the arrangement of vortices; he limits the motion of $2n$ vortices by assuming the existence of n planes of orthogonal symmetry in the arrangement of vortices.

Two years after the work of Greble, the work of Cootes appeared, in which he considered the motion of a vortex ring and showed that the ring-shaped vortex is a stable form. J. Thomson also studied the motion of vortex rings extensively.

Vortex motions in a compressible fluid are devoted to the works of Gretz and Schré. The motion of vortices bounded by walls was studied by Helmholtz himself.

Considering the motion of two rectilinear parallel vortices in an ideally incompressible fluid, Helmholtz showed that the plane dividing the distance between two vortices with equal strengths but different signs can be taken as a wall if it is perpendicular to this distance. The vortex will be

move parallel to this wall, and the whole effect of the wall is thus reduced to the effect of the image of the vortex, if the wall is considered as a mirror.

Greenhill in 1877-1878 considered problems on the motion of vortices in a fluid bounded by cylindrical surfaces. Using the method of images, he solved problems on the plane motion of one and two vortices inside and outside the surface of a circular cylinder, as well as in the space bounded by the surface of a rectangular quadrilateral prism.

In 1876-1883, the English physicist O. Reynolds [8] experimentally established a criterion for the transition of laminar flow in cylindrical tubes into turbulent flow and introduced a criterion characterizing the critical ratio between inertial forces and viscous forces, at a certain value of which laminar flow transitions into turbulent flow and further into vortex flow. This ratio $Re = \rho v l / \eta$, called "Reynolds number", relates ρ - density of liquid, v - flow velocity, l - characteristic linear dimension, η - dynamic viscosity coefficient and allows to determine the conditions of turbulence and vortex formation in specific cases of liquid flows near different surfaces and shapes.

At this time, a number of scientists solved numerous partial problems of vortex motion. A very special problem was set for himself in 1894 by N.E. Zhukovsky, who, using the conformal image method, solved the problem of vortex motion near the tip of a wedge immersed in a liquid. By considering the trajectories of the vortex, he showed that the vortex cord always evades the blade brought to it. Subsequently, Zhukovsky developed the theory of the so-called "attached" vortices, which is of fundamental importance for many applications [9].

W.Thomson, based on the vortex conservation theorem, put forward a special atomistic hypothesis [10-11]. He assumed that the entire space of the Universe is filled with ether, an ideal fluid in which the atoms of matter are infinitesimal closed vortices originated in this fluid. W.Thomson explained the diversity in the properties of atoms by the variety of motions in which the particles of one simple substance are located. The vortex theory of atoms, created by W.Thomson, was not recognized and developed. Only in the 20s of the twentieth century German hydrodynamicist A.Korn tried to resurrect again the ideas of V.Thomson, but in relation not to the atoms of matter, but to the interpretation of the nature of the electron.

A little later, N.P.Kasterin made an attempt to construct a vortex theory of elementary particles. However, the ideas of A.Korn and N.P.Kasterin were met with great distrust by the general scientific community, so they were isolated and unclaimed, although the works of these scientists contain a considerable number of interesting considerations.

With the development of aviation, scientists encountered the need to study vortex formations in the streamline of solid bodies. In this respect, the works of Karman and N.E. Zhukovsky deserve special attention. The former studied in great detail the behavior of the so-called vortex path of Karman [9, 12, 13]. There are remarkable works of A.A.Friedman in Russian "Experience of hydromechanics of compressible fluid", as well as "On vortices in a fluid with changing temperature" [14, 15], in which the behavior of vortices in a fluid with changing temperature is studied in detail [14, 15] [14, 15], in which the formulation of problems on the motion of vortices in a compressible fluid is given.

Finally, we should mention the studies of Oseen [16], who for the first time posed and solved a number of problems on the motion of vortices in a viscous fluid. The ideas of Oseen and Friedman are still waiting for their continuation.

At a later time, a number of Soviet and foreign researchers continued their theoretical investigations in the field of vortex motion [see supplementary litt.].

It should be noted that the complexity of turbulent and vortex gas dynamics problems often forces researchers to use simplified models of phenomena that are not always correct. For example, in liquid vortices, the idea that the central part of a linear vortex rotates according to the law of a solid body is used, although there are no physical prerequisites for this [17]. In many cases, models that do not correspond to the physics of the phenomena are used, gas compressibility is neglected where it cannot be neglected, viscosity, temperature and other effects are not studied.

Many problems of vortex motion of media, especially gases, have not been solved so far. These include, first of all, the problem of formation, structures and energetics of gas vortices. The boundary layer theory is far from being in a satisfactory state, although much has been done here [18]. Solutions in the field of interaction of helical gas flows are almost completely absent. Problems related to the interpenetration of vortex flows in rarefied gases, to the interaction of superdense helical gas structures such as helical vortex toroidal rings, or to the interaction of complex helical vortex structures consisting of many vortices have never been considered.

Nevertheless, in this field a solid foundation has been created, which should be used in the development of etherdynamic bases of the structure of matter. The urgency of solving the problems of vortex and helical motion of gases increases with the emergence of etherdynamics, for which these problems are of special importance.

5.2. Formation and structure of a linear gas vortex

When gas masses move relative to each other, turbulence arises in the gas medium and transforms into vortex formations.

Fundamentally a vortex formation is any motion of a liquid or gas for which the

$$\text{rot } \mathbf{v} = \lim_{\Delta S \rightarrow 0} \frac{\oint \mathbf{v} d\mathbf{l}}{\Delta S} \neq 0, \quad (5.1)$$

i.e., that for which the velocity circulation along the closed contour is not equal to zero. However, not every motion for which the above relation is satisfied is a vortex in the full sense of the word.

Indeed, the flow of gas along a fixed wall is unequal at different distances from it. For such a layered flow

$$\text{rot}_z \mathbf{v} = \frac{1}{2} \left(\frac{\partial v_x}{\partial y} - \frac{\partial v_y}{\partial x} - \frac{1}{2} \frac{\partial v_x}{\partial y} \right) = \frac{1}{4} \frac{\partial v_x}{\partial y} \neq 0, \quad (5.2)$$

since the longitudinal (in the x -axis direction) velocity v_x changes with distance from the wall, i.e., with increasing z value. Nevertheless, there may be no vortex as such in such a flow, although the prerequisites for the appearance of turbulence are created precisely due to the differences in flow velocities at different distances from the wall (Fig. 5.1).

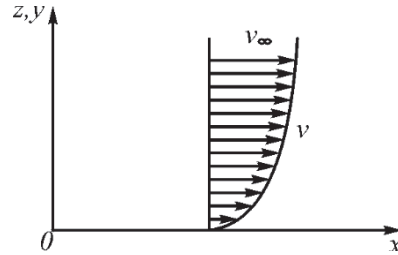

Fig. 5.1. Velocity distribution in the boundary layer of a flat plate.

In hydromechanics, as it is known, it is accepted to distinguish between laminar, turbulent and vortex motion, the transition from one of them to another is determined by the Reynolds number Re :

$$Re = vl/\chi, \quad (5.3)$$

where v is the flow velocity of the medium; l is the characteristic linear dimension; χ - kinematic viscosity of the medium.

As shown in [8, 18-21, etc.], the transition from laminar motion to turbulent motion starts from values of Reynolds numbers of the order of 2000 (according to the studies of Reynolds from 2300), but the emerging turbulence is not necessarily accompanied by rotation (rotation) of the medium particles. At higher values of Reynolds number the turbulence becomes stable. If at such values of Reynolds numbers there is rotation of medium particles, the motion becomes vortex.

Stable and continuous vortex formation can occur only at involving in the process some minimal volume of ether and providing some minimal velocity gradient at collision of jets.

When gas flows move relative to other flows or resting masses, a boundary layer appears at the boundaries of the flows, in which a velocity gradient occurs [22]. In the boundary layer there is a decrease in temperature, since

$$T = T_{\infty} - \sqrt{Pr} u^2/2c_p, \quad (5.4)$$

where Pr is the Prandtl number, equal to

$$\text{Pr} = \eta c_p / k_t; \quad (5.5)$$

u - boundary layer boundary velocity; c_p - heat capacity of the medium at constant pressure; η - dynamic viscosity; k_t - heat conduction coefficient.

The presence of a velocity gradient is equivalent to the presence of two oppositely directed flows at each point of the medium.

A decrease in temperature leads to a decrease in the dynamic viscosity coefficient in the boundary layer [18, p. 285, 316-318; 22], since the

$$\frac{\eta}{\eta_0} = \left(\frac{T - T_0}{T_0} \right)^{\zeta}; \quad 0,5 \leq \zeta \leq 1 \quad (5.6)$$

which, in turn, increases the stability of the vortex formation, since the energy transferred by it to the neighboring layers of the external medium decreases (Fig. 5.2).

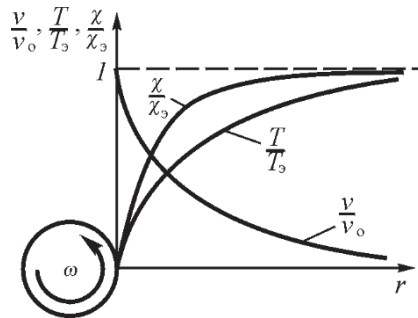

Fig. 5.2. Dependences of flow velocity, temperature and kinematic viscosity on the distance to the wall of the gas vortex

Experimental confirmation of the temperature decrease in the boundary layer is the well-known fact of icing of the surfaces of the wings of a flying airplane.

The drop of dynamic viscosity in the boundary layer has been emphasized by some authors. This fact was also confirmed experimentally (see, for example, [22]). Some authors considered that the decrease of the dynamic coefficient of the

viscosity occurs due to the so-called "velocity gap" [19- 20].

There is a pressure drop in the boundary layer of the vortex, which is a consequence of the fact that the centrifugal force tending to push back the gas located in the boundary layer must be balanced in steady-state motion by a force that arises from the pressure difference between the external medium and the layers in the region closer to the center of rotation (Fig. 5.3).

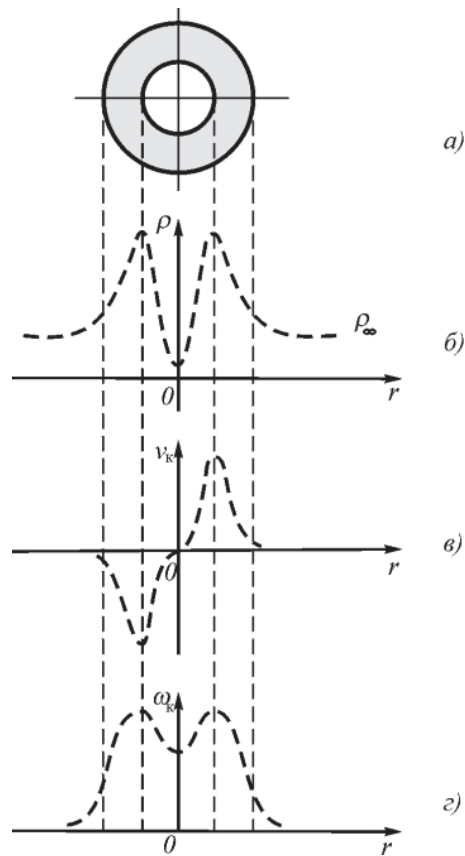

Fig. 5.3. Cylindrical gas vortex: cross section of the vortex (a); gas density distribution (b); tangential velocity diagram (c); dependence of the angular velocity of gas rotation in the vortex on the radius (d)

The viscosity drop in the vortex boundary layer, on the one hand, and the throwing away of gas from the central region of the vortex to the periphery by the centrifugal force, on the other hand, contribute to the fact that the gas vortex is formed as a rotating tube, in the walls of which the main mass of the vortex is placed.



Figure 5.4. Compression of a gas vortex at the air intake of an airplane jet engine (at parking)

The works on studying the conditions of vortices appearance at the inlet of air intakes of jet airplanes were carried out on a specially created stand.

aircraft at engine startup, showed that the linear gas vortex is indeed a tube-type formation with compacted walls.

Fig. 5.4, it is clearly seen that the diameter of the vortex established at the turbine air inlet is significantly, tens of times in diameter and hundreds of times in cross-sectional area, smaller than the corresponding dimensions of the air inlet and that the vortex itself has a tubular structure.

The gas element on the outside of the pipe tends to break away under the action of internal pressure and centrifugal force, but is prevented from doing so by external pressure. If the internal forces are greater than the external forces, the gas element will break away from the pipe, as there is no obstacle for the gas. The sum of the internal forces of the gas remaining in the walls is less than or equal to the external forces - the latter state is unstable. Compression of the vortex body by external forces - the pressure of the environment - causes an increase in the rotational velocity, and the internal pressure decreases, so that the equilibrium remains unstable and the vortex continues to contract.

The centrifugal force and the difference of external and internal pressures act on the element of such a pipe, so that

$$dF = adm = (P_e - P_i) dS - \omega^2 r dm, \quad (5.7)$$

where

$$dS = r h_0 d\alpha;$$

a is the acceleration along the radius acquired by the mass dm ; r is the radius at which this mass is located from the center of the pipe; h_0 is the length of the pipe segment, $d\alpha$ is the angle occupied by the element of mass dm .

As can be seen from expression 5.7, at some value of radius

$$r > r_0 = \frac{P_e - P_i}{\omega^2} \frac{dS}{dm} \quad (5.8)$$

we have

$$\omega^2 r dm > (P_e - P_i) dS, \quad (5.9)$$

i.e. the acceleration will be positive and the mass dm will be thrown away from the vortex. The remaining part has $r \leq r_0$.

At $r < r_0$ the value of a has a negative sign, and the vortex starts to be compressed by the external pressure. The difference of forces will be:

$$dF = (P_e - P_i)dS = \omega^2 r dm. \quad (5.10)$$

Considering that

$$P = \rho RT \quad (5.11)$$

and that in the inner region the density ρ decreases due to the centrifugal force throwing the gas to the walls, we have:

$$P_i = \rho_i R \left(T_\infty - \frac{u^2}{2c_p} \right) = P_e - (\rho_o - \rho_i) RT_\infty - \frac{u^2}{2c_p}. \quad (5.12)$$

Hence,

$$P_e - P_i = (\rho_o - \rho_i) RT_\infty + \frac{u^2}{2c_p}. \quad (5.13)$$

The further process will be determined by the requirements of conservation of momentum:

$$L = rmu = \text{const.} \quad (5.14)$$

Hence,

$$\begin{aligned} dF &= \left[(\rho_o - \rho_i) RT_\infty + \frac{u^2}{2c_p} \right] dS - dm = 2c_p \frac{u^2}{2c_p} dS - dm = 2c_p \frac{u^2}{2c_p} dS - dm \\ &= (\rho_o - \rho_i) RT_\infty r d\alpha + \frac{u^2}{2c_p} \frac{L dL}{r^3 dm} - dm = (\rho_o - \rho_i) RT_\infty r d\alpha + \frac{u^2}{2c_p} \frac{L dL}{r^3 dm} - dm. \end{aligned} \quad (5.15)$$

Thus, there is a complex dependence of the change of forces in the vortex walls on the radius. If the first term decreases with decreasing radius, the second and third terms increase. The reduction of the radius will continue until the third term compensates the first two terms.

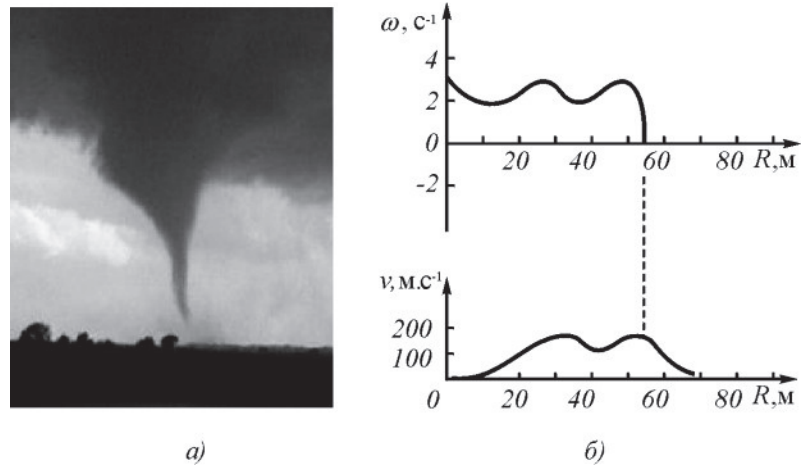

Fig. 5.5. Appearance of a tornado (a) and its structure according to observations (b)

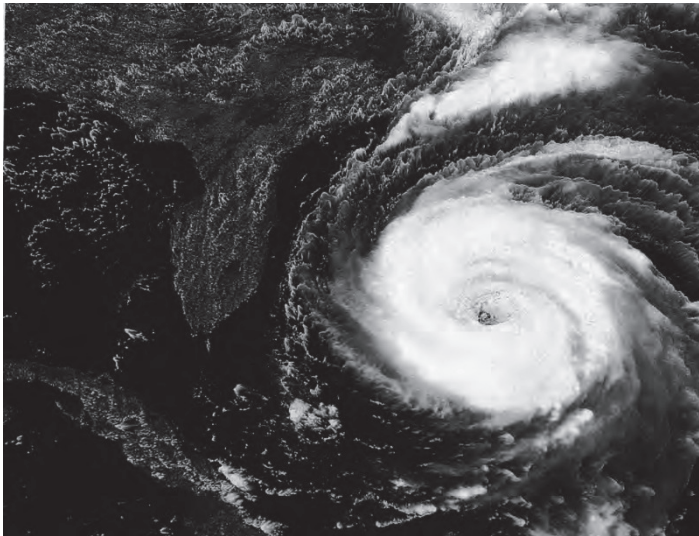

Figure 5.6. Cyclone formation in the Florida area (image from space)

At some critical value of the radius gkr , when $dF = 0$, the process will stop, and the vortex will be characterized by a significantly increased gas density in the walls and a significantly

lower temperature than the surrounding medium. In the center of the vortex, the pressure will be lowered compared to the gas surrounding the vortex. This decrease is due not only and not so much to a decrease in the density of the gas inside the vortex, but also to a decrease in temperature.

The data presented in [23-25] confirm the above statement (Figs. 5.5, 5.6).

5.3. Energetics of gas vortices

As seen in the previous section, the body of a gas vortex is compressed by the environment during the vortex formation process. This is confirmed by the fact that the tornado body is thinner than its base, where friction against the ground does not allow it to develop a high rotational speed. Another confirmation of the compression of the vortex body by the atmosphere is the fact that a vortex is often formed in the parking lot when starting turbojet engines of airplanes in front of the air intakes, and the only one. The cross-sectional area of this vortex is hundreds of times smaller than the area of the air intake itself, and if outside the vortex there is practically no air flow into the air intake, the velocity of the longitudinal air flow in the vortex itself is very high; practically all air to the turbine goes through this vortex formed spontaneously at the compressor inlet.

Thus, the fact of spontaneous reduction of the vortex cross-sectional area in the process of its formation actually takes place. The vortex cross-sectional area reduction is, of course, the result of its radius reduction. Thus, vortex formation is accompanied by a decrease of its radius with simultaneous compaction of the vortex body.

There are two types of rotational motion of a body with a variable radius, unfortunately, in the courses of mechanics considered in insufficient detail.

The first type of motion - spontaneous, without energy input, is shown in Figs. 5.7,*a*, 5.8,*a*. *The* motion of the body occurs around a cylinder on which a thread holding the body is wound. In this case, the body, moving by inertia around the cylinder, rotates around the instantaneous center of rotation, located on the cylinder's formative (point O in the figure). The instantaneous center of rotation moves after the body. The thread is taut, the trajectory of the body at each moment of time is strictly perpendicular to the thread, so the projection of the thread tension force on the trajectory is zero.

Although in this case the radius changes (decreases), there is no tangential acceleration, so the body moves with constant linear velocity (in the absence of losses). Hence, although $r = \text{var}$, the linear velocity, the amount of motion and energy remain constant:

$$v = \text{const}; p = mv = \text{const}; w = mv^2/2 = \text{const}, \tag{5.16}$$

as it should be if there are no losses and no energy input.

The second type of motion of a body with a variable radius - motion around a stationary center when the radius changes due to energy input from outside - is shown in Figs. 5.7, *b*, 5.8, *b*. Here, in order to reduce the radius of the trajectory, it is necessary to do additional work to overcome the centrifugal force. Then the mass will start to move along the spiral, and at that the angle between the thread and the trajectory will be less than the right angle. The projection of centrifugal force on the trajectory appears. The general motion of the body is along the curve, the instantaneous center of rotation for which is the point O' , moved away from the point O , to which the thread is attached and to which the force F_c is directed, in this case the projection of the force F_c on the direction of motion is not equal to zero, and the body acquires acceleration along the trajectory.

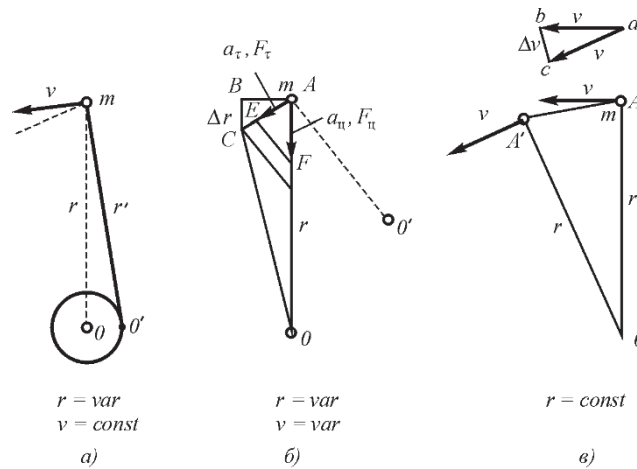

Fig. 5.7. Motion of a body along a trajectory with a variable radius: without energy supply (a); with energy supply (b); to the calculation of centripetal acceleration (c).

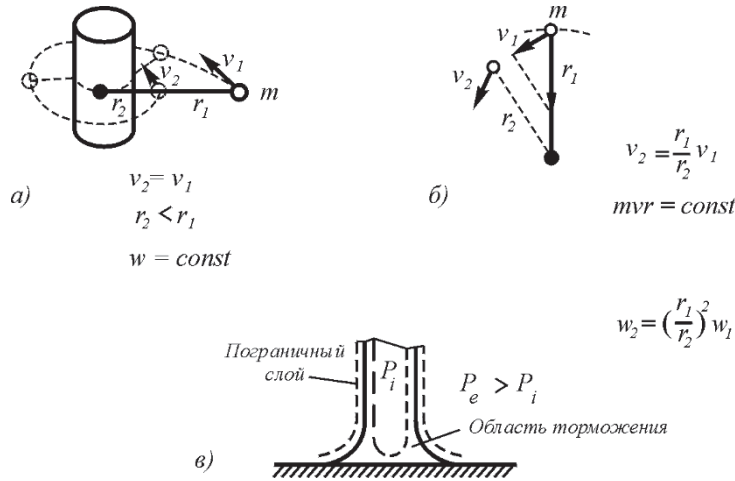

Fig. 5.8. Rotation of a body: around a cylinder (a); around the center at change of rotation radius (b); structure of the lower part of a tornado in which gas moves with change of rotation radius (c)

For the usual rotational motion (Fig. 5.7,c) it follows from the similarity of triangles $AA'O$ and abc :

$$\Delta v/v = S/r = v\Delta t/r \tag{5.17}$$

or

$$\Delta v/\Delta t = a_{\parallel} = v^2/r; \tag{5.18}$$

and from the similarity of triangles ABC and AEF (Fig. 5.9b) it follows that

$$a_{\tau}/a_{\parallel} = v/v_{\tau} \tag{5.19}$$

or

$$a_{\tau} = -a_{\parallel} \frac{v v_{\tau}}{v_{\tau}^2} = -\frac{v^2 v_{\tau}}{r v_{\tau}^2} = -\frac{v}{r} \frac{v_{\tau}}{v_{\tau}^2} = -\frac{v}{r} \frac{1}{v_{\tau}} = -\frac{v}{r v_{\tau}} \tag{5.20}$$

from where

$$a_{\tau} = -\omega v_r, \tag{5.21}$$

i.e. the mass acceleration in this case has the nature of Coriolis acceleration.

Multiplying both terms of the expression by the radius r , we have

$$a_{\tau} r + v_{\tau} v_r = 0; \quad (5.22)$$

integrating over time, we obtain

$$\int (a_{\tau} r + v_{\tau} v_r) dt = \int \left(r \frac{\partial v_{\tau}}{\partial t} + v_{\tau} \frac{\partial r}{\partial t} \right) dt = \text{const.} \quad (5.23)$$

Since the total differential is in parentheses, we have

$$vr = \text{const.} \quad (5.24)$$

For constant mass we obtain

$$mvr = \text{const}, \quad (5.25)$$

whence it follows that at $r_2 < r_1$

$$p_2 = mv_2 > p_1 = mv_1; \quad w_2 = \frac{mv_2^2}{2} > w_1 = \frac{mv_1^2}{2}. \quad (5.26)$$

Thus, the law of constancy of the angular momentum is valid if in the system due to external sources the energy directed to the corresponding change (increase or decrease) of the radius of rotation of the body changes. The considered case differs fundamentally from the previous one in that the rotational energy of the body changes. In this case, all other characteristics of the accelerating body, such as temperature, etc., do not change.

The tangential velocity of the body at decreasing the radius of rotation will be substantially greater than the initial one and will be determined by the expression obtained from the condition of constancy of the momentum of motion:

$$u_k = u_0 \frac{r_0}{r_k}. \quad (5.27)$$

The same should be the case of formation of vortex motion of gas ("compressible liquid"): the more compressed the vortex is, the greater will be the velocity of flows. This should also be the case for

in the structure of the formed vortex; the inner layers must move with a velocity greater than the outer layers.

The energy of tangential motion acquired by the mass per unit time is equal to

$$w_{\tau} = \frac{F_{\tau} \Delta S v_{\tau}^2 v_r}{\Delta t} = m a v_{\tau} = m \frac{v_{\tau}^2 v_r}{r} = m \omega v_{\tau} v_r = m \omega^2 v_r r. \quad (5.28)$$

The energy invested in the radial displacement of the body for the same unit of time is

$$w_{\text{II}} = \frac{F_{\text{II}} \Delta S v_{\text{II}}}{\Delta t} = m a v_{\text{II}} = m \frac{v_{\tau}^2 v_r}{r}, \quad (5.29)$$

and therefore,

$$w_{\tau} = w_{\text{II}}, \quad (5.30)$$

which confirms the fact that the energy acquired by the mass is of purely external origin.

The force accelerating the mass is equal to

$$F_{\tau} = \frac{v_{\tau} v_r}{r} = m \omega v_r \quad (5.31)$$

and is proportional to the angular velocity and the rate of change of radius.

The force to be applied to the mass in the radial direction is:

$$F_r = \frac{v_{\tau}^2}{r} = m \omega^2 r. \quad (5.32)$$

Thus, F_r is the total force, and the energy to overcome this force while moving the body at velocity v_r , is all the energy that must be put into the system to ensure that the radius is reduced and the mass acquires additional rotational energy.

The considered mechanism of energy accumulation by a rotating body allows us to understand the origin of energy of gas vortices, which are known to be very energy-consuming formations.

The above conclusion is valid for the case of rotation not only of a solid body, but also of an incompressible liquid, when the energy of radial motion is spent only on the change of the radius of rotation and, accordingly, on the change of the energy of tangential motion. In the case of a compressible gas, the energy of radial motion is also spent to change the internal energy of the gas due to its compression.

Here, however, the overall picture becomes considerably more complex.

If some volume of gas during vortex formation is compressed without changing the structure, the gas pressure would inevitably increase in this volume due to the known law

$$P = RT/V, \quad (5.33)$$

where R is the universal gas constant; T is the absolute temperature; V is the volume. But then the formation of the vortex itself would be impossible. However, in the forming vortex different layers are at different distances from the center, which leads to the fact that they move with different velocities - the inner ones are faster than the outer ones. Hence, there is a velocity gradient at each point of the vortex, which significantly changes the whole picture.

According to the differential form of the Bernoulli equation

$$\rho v dv + dP = 0 \quad (5.34)$$

as the flow rate increases, the pressure should decrease.

A decrease in pressure in the gas flow will mean a decrease in temperature and will be compensated by the addition of gas mass from the outside. Consequently, there will be increased density and decreased temperature in the walls of the vortex body, which is actually the case.

It should be noted that the above considerations are not strict, since the compression of the vortex body occurs due to the work of the pressure of the gas external to the vortex body. This pressure accelerates the gas flow, thus, the acceleration of the flow is due to the addition of energy to the jets, not just redistribution of energies, as it follows from Bernoulli's equation. Nevertheless, the very fact that the body of the gas vortex is compressed indicates that both the density of the vortex walls is increased and the wall temperature is lowered. This means that to the translational velocity of the inner layers of the vortex, caused by compression of the vortex by external pressure, is added the velocity associated with the

by redistribution of heat energy into the energy of translational motion. Thus, the tangential velocity of motion of the inner layers of the vortex will be larger than it follows from formula (5.27).

It should be stated with regret that the mechanism of participation of thermal energy of chaotic motion of gas molecules in the forward motion of vortex flows is not sufficiently considered in gas dynamics. Due to the complexity of the problem here, we can speak about it only presumably, based on the undoubted fact that the gas in the vortex walls is compacted and has a reduced temperature relative to the external environment.

In principle, the transfer of thermal energy by the internal layers of gas can occur in two directions - to the external medium and to the accelerating flows of the vortex body itself.

Heat transfer to the external environment can occur due to the ejection by centrifugal force of molecules with the highest velocity from the inner layers to the outer layers (similar to evaporation of liquid from the surface). The remaining molecules redistribute their velocities, and the temperature of the layer is lowered.

The transfer of thermal energy to progressively moving layers can occur due to the fact that the average path length of molecules in the tangential direction increases. If the specific energy of the gas is conserved, there is a redistribution between the tangential and normal velocities: an increase in the ordered part of the tangential component of the motion leads to a decrease in the tangential part of the chaotic motion, resulting in a decrease in the velocity of the entire thermal motion. The temperature drops:

$$T_2 = \frac{m\bar{u}^2}{3k} = \frac{m(\bar{u}_\tau^2 - v_\tau^2 + \bar{u}_r^2 + \bar{u}_l^2)}{3k}$$

$$< T_1 = \frac{m(\bar{u}_\tau^2 + \bar{u}_r^2 + \bar{u}_l^2)}{3k}. \quad (5.35)$$

Here m is the mass of a gas molecule; τ is the coordinate of the tangential component of motion; r is the radial coordinate; l is the axial coordinate; \bar{u} is the average velocity of chaotic (thermal) motion of molecules; v_τ is the velocity of ordered tangential motion (velocity of a gas jet); k is Boltzmann's constant.

But in this case the velocity of internal gas flows will be greater than the velocity obtained only by accelerating the gas by the external pressure of the surrounding vortex medium, which essentially distinguishes this process from the motion of a solid body with a variable radius.

Thus, at least at the qualitative level, the mechanism of thermal energy loss by the inner layers of the vortex becomes clear, although in the future more substantial attention should be paid to this problem.

At compression of the vortex body by external pressure we have on the vortex surface an equality of pressures

$$P_e = P_u + P_i, \quad (5.36)$$

where P_e - pressure of aether in free space; P_u - pressure created by centrifugal force on the surface of the vortex; P_i - pressure in the inner region of the vortex. Thus

$$P_e = \rho_0 \frac{u_e^2}{2}, \quad (5.37)$$

where ρ_0 is the density of the gas in free space, u_e is the average velocity of chaotic motion of molecules,

$$P_u = \frac{v^2 \delta \rho}{r}, \quad (5.38)$$

where v is the translational (tangential) velocity of the vortex wall; δ is the wall thickness; ρ is the gas density in the vortex wall; r is the radius of the vortex wall.

The internal pressure in the vortex central region P_i and the gas density in the vortex wall are related to the temperature by the relations:

$$P_i = P_e \frac{T_i}{T_e}; \quad (5.39)$$

$$\rho = \rho_0 \frac{T_i}{T_e}. \quad (5.40)$$

Denoting $T_i/T_e = k_T$, we obtain from (4.36) the equation

$$\frac{u^2}{2} = \frac{v^2 \delta}{r} = \rho_o \frac{v^2 \delta}{r} + \rho_o \frac{v^2 \delta}{2r}$$

or

$$k_T^2 - k_T + 2 = 0. \quad (5.41)$$

The solution of this equation is the expression

$$t_{oT} = \frac{1}{2} + \frac{1}{2} \left(1 - 8 \frac{v^2 \delta}{u^2 r} \right)^{1/2} \approx 1 - 2 \frac{v^2 \delta}{u^2 r}. \quad (5.42)$$

And, thus, the temperature inside the vortex and in its wall is defined as

$$T_i = T_c \left(1 - 2 \frac{v^2 \delta}{u^2 r} \right), \quad (5.43)$$

and the wall density will be equal to

$$\rho = \frac{\rho_o}{1 - 2 \frac{v^2 \delta}{u^2 r}}. \quad (5.44)$$

From this we can see that as the rotational speed of the vortex increases, the temperature inside the vortex decreases and the wall density increases.

Let us determine the velocity of the vortex wall at its compression.

The increment of the wall velocity is due to the decrease of the thermal content of gas inside the vortex, therefore

$$\frac{\Delta v^2}{v^2} = \frac{\Delta T T_c - T_i}{T T_c} = 1 - t_{oT} \quad (5.45)$$

and, therefore,

$$\Delta v^2 = \Delta v^2 (1 - \frac{\delta}{r}) = 2v_0^2 \frac{\delta}{r}, \quad (5.46)$$

resulting in

$$v \approx \frac{v_0 R_0}{r (1 - \sqrt{2} \frac{\delta}{r})} \quad (5.47)$$

Here R_0 and v_0 are the initial radius of vortex formation and the initial velocity of forward gas motion at the moment of vortex formation, respectively.

Thus, the compressible gas flow velocity in the vortex body can significantly exceed the liquid flow velocity at the same external vortex parameters.

Inside the vortex in the rarefied zone, the tangential velocity to the center will smoothly decrease, which resembles the velocity decrease in a rotating solid body, although the nature of this decrease is different (Fig. 5.3,c). Unlike liquid vortices, whose center is filled with liquid of the same density as their periphery and which, as some authors claim, rotates according to the law of a solid body [17], which is certainly incorrect, the gas vortex has a tubular structure. In the central part of the gas vortex, the gas pressure is reduced due to the scattering of particles from the center by the centrifugal force, and the vortex itself is bounded from the outside by a boundary layer with reduced values of temperature and viscosity and with a density value smoothly passing from the high density of the vortex wall to the density of gas in the surrounding medium.

It follows from the above that a gas vortex at its formation concentrates the energy of the environment, and this process is fundamentally different from any other processes accompanied by energy dissipation in the surrounding space.

5.4. Movement gas around linear vortex Energy paradox

In accordance with the known provisions of hydrodynamics for an incompressible fluid around the vortex filament, a circular motion of the fluid obeying the law is established

$$G = \oint v dl = \text{const}, \quad (5.48)$$

where G is the circulation magnitude; v is the velocity of the fluid around the vortex center at distance r from the center; dl is the element of the flow length.

Hence the flow velocity is

$$v = G / 2\pi r, \quad (5.49)$$

i.e., the flow velocity is inversely proportional to the distance from the vortex center and decreases according to the hyperbolic law.

This position, first formulated by Helmholtz and since then stated in practically all systematic courses on hydrodynamics, is actually very inaccurate, as it leads to the energy paradox, according to which the energy of fluid motion around a unit length of a linear vortex is equal to infinity at any value of circulation.

Indeed, the energy value of the fluid moving around the vortex center will be determined by the expression

$$W = \int_V \rho v^2 / 2 dV = \int_l \int_{R_1}^{R_2} \rho G^2 \frac{2\pi r dr}{4\pi^2 r^2} = \frac{\Delta l \rho G^2}{2\pi} \int_{R_1}^{R_2} \frac{dr}{r} = \frac{\Delta l \rho G^2}{2\pi} \ln \left| \frac{R_2}{R_1} \right|, \quad (5.50)$$

or per unit vortex length we have

$$w = \frac{W}{\Delta l} = \frac{\rho G^2}{2\pi} \ln \left| \frac{R_2}{R_1} \right| = \infty, \quad (5.51)$$

which, of course, cannot be for purely physical reasons.

The vortex energy paradox is actually just an illustration of the insufficiency of the model used, in this case, the model of the medium as an incompressible and non-viscous fluid.

We should not forget that according to Helmholtz's theorems vortices cannot be created or destroyed, although in fact they both arise and are destroyed, which once again shows the insufficiency of the used model of vortex as a circular motion of incompressible and non-viscous fluid. Taking into account only compressibility will lead to violation of the law of velocity distribution by the hyperbolic law, and taking into account also viscosity will lead to the need to take into account energy losses, which will further reduce the distance at which the vortex filament sets in motion the surrounding fluid.

Besides, all the above mathematical conclusions do not take into account the process of vortex formation itself, considering the vortex filament and the motion of the surrounding fluid as a kind of vortex statics, which has no prehistory at all. Here, the filament is not the cause that sets in motion the surrounding fluid, the filament and the surrounding fluid are simply in dynamic equilibrium.

In fact, in real physical conditions all this is not so, the vortex is the reason why the surrounding liquid moves, for this movement the vortex must spend energy, as a result of which the energy of the vortex itself decreases. The motion in the liquid spreads gradually, respectively gradually decreases and energy of the vortex, which leads to a decrease in the speed of its rotation and an increase in its diameter (vortex diffusion). And the presence of viscosity makes this process irreversible.

Energy transfer of the compressible fluid is inevitably accompanied by its compression, which will be the stronger, the closer the fluid to the vortex body, this will violate the law of hyperbolic reduction of the fluid velocity in the vicinity of the vortex (Fig. 5.9).

Thus, in real situations there is no "energy paradox", as well as nature does not know any "paradoxes" at all. All "paradoxes" without exception are the result of our incomplete, often the most superficial knowledge about the subject in question.

Something similar exists in the notions of fluid motions inside a vortex.

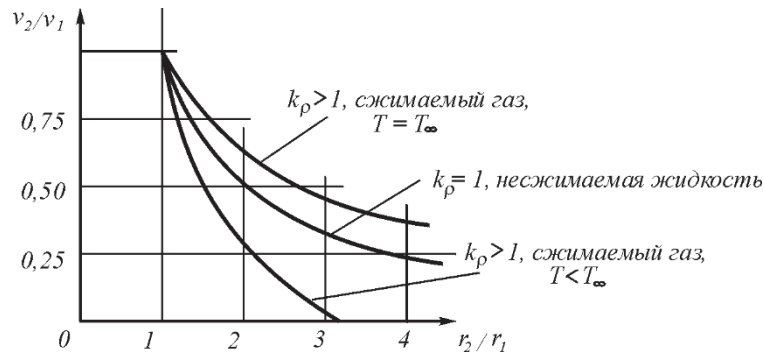

Fig. 5.9. Velocity distribution around a cylindrical vortex for an ideal (incompressible) liquid and gas

Since in accordance with the constancy of circulation as the radius decreases, the velocity of the fluid increases and becomes infinitely large at an infinitesimal radius, hydrodynamicists have introduced a postulate according to which there must exist a certain core in the center of the vortex, rotating according to the law of a solid body, in which the velocity to the center of the vortex linearly decreases. No physical considerations are given, but only the fact of impossibility of infinitely large velocities.

It's really not like that.

An increase in the velocity of the medium inside the vortex body undoubtedly takes place, since it follows directly from the mechanism of vortex formation and since otherwise the dynamic equilibrium of the fluid will be disturbed. But in a compressible liquid in a vortex, as it was shown above, the vortex walls are inevitably formed, in which this liquid (in fact - gas, because the very concept of "compressible fluid" contradicts the physical nature of the fluid) is compressible. These walls are separated from the rest of the fluid mass by a boundary layer in which there is a smooth transition from the wall velocity to the ambient velocity, as well as a smooth transition of density, temperature and viscosity. Inside the vortex body the same transition should take place with the peculiarity that the temperature (possibly, and density) of the medium inside the vortex is less than outside. And then not in the compacted core, which does not exist in the vortex at all, but in this rarefied inner space there is a smooth transition from the velocity of the inner surface of the vortex walls to its center. In the first

In the approximation, we can probably operate here by adding two hyperbolas, as shown in Fig. 5.3, b.

5.5. Formation and structure of toroidal gas vortices.

Formation of helical motion

As shown by Rosenhead [26], the boundary layer surface of a flat jet tends to curl into a series of double spirals (Fig. 5.10), forming vortices whose axes are perpendicular to the jet direction and velocity gradient. The resulting vortices will begin to spontaneously contract, decreasing the radius and increasing the circumferential velocity.

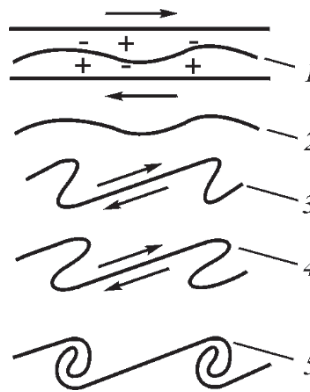

Fig. 5.10. Boundary layer instability between gas flows: arrows indicate flow directions; areas of increased pressure are marked with + signs, figures correspond to the stages of process development

An experimental confirmation of spontaneous vortex compression is the formation of vortices at the air intake inlets of airplanes: at the air intake inlet opening of about 1 m^2 the vortex formed at its inlet has a diameter of about 4-6 cm (see Fig. 5.4).

Let us consider this process. A thin vortex filament or the whole gradient layer in a compressible gas are unstable formations, only a vortex ring is stable, and the most stable is a helical toroidal vortex, since the velocity gradient on its

of the surface is maximal and, hence, the viscosity of the boundary layer is minimal. The formation of such rings from linear vortices or from the gradient layer should be facilitated by deformations of vortex filaments caused both by the velocity field of the medium near the curved vortex bundles themselves and by turbulent fluctuations inside the bundles, as well as by ambient turbulence. In addition, oscillations develop along the axes of the vortex bundles, resulting in the formation of standing waves of different lengths along the vortex body, which contribute to the separation of the vortex bundles into separate sections, which are further connected in pairs to form loops [27] (Fig. 5.11).

Vortex loops form a gas flow that tends to expand the loop, resulting in the formation of a vortex ring. This ring is unstable with respect to shape if the diameter of the ring exceeds significantly the diameter of its body (according to Lichtenstein $D/d \geq 86$ [28]).

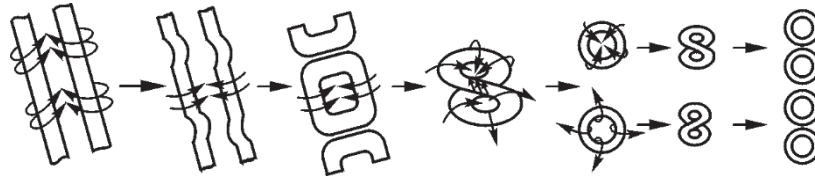

Fig. 5.11. Sequence of stages of vortex ring formation

As it is known [21, 29], a vortex ring induces gas flows in the environment, while the ring itself, if it is not compacted, moves in space with a velocity of

$$v = \frac{\Gamma}{4\pi D} \left(\ln \frac{8D}{d} - \frac{1}{4} \right). \quad (5.52)$$

A compacted vortex ring will slowly accelerate. However, when the shape of the ring is distorted, the direction of gas flows changes, and if parts of the ring create a common flow, loops will form, which will immediately spread out.

The minimum energy of such a system corresponds to the minimum ratio

$$l/S = \min. \quad (5.53)$$

Here l is the average length and S is the cross-sectional area of the gas flow common to the two loops.

The tendency of the system to minimize energy creates forces directed to the expansion of the loop area and to the convergence of the intersecting parts of the loops. Since in the intersecting parts of the loops the direction of rotation is the same, these parts will merge, but immediately the loops will form into independent vortex rings, which will separate from each other. The obtained rings will undergo further division. Such fission will continue until the diameter of the toroid body becomes commensurate with the radius of the toroid itself. As a result, the shape of the toroid body will be close to a ball shape (Hill vortex), while the walls of the toroid will be compacted.

The considered mechanism of formation and division of vortex rings is not the only one. The division of vortex rings after their formation can be easily seen on a simple experiment, if a drop of ink is dropped into a jar with calm water from a height of 2-3 cm. In Fig. 5.12 you can see how the toroidal ring initially formed as a result of a drop of ink in water starts to split into smaller toroidal rings, which in turn split into even smaller ones, etc.

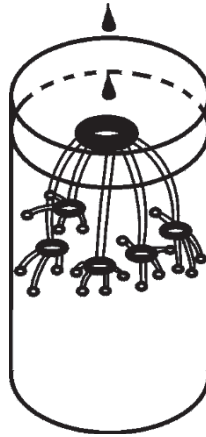

Fig. 5.12. Formation and fission of toroidal vortex rings in liquid at dropping of a drop

Thus, chaotic displacement of fluid flows is also capable of generating fissile toroidal rings.

A helical vortex toroid of gas is a formation of a coiled tube type, in the cavity of which the gas pressure and density are lower than in the free medium, but the gas is significantly compacted in the walls. The walls of the tube near the central axis provide in this place the highest gas density (excluding the axial central hole itself); this region can be called the core of the helical toroidal vortex.

As experiments with an ordinary smoke toroid have shown, such a tube has an ellipsoidal shape, as a result of which the toroid diameter D is less than two but more than one torus diameter d and is about $1.7d$, the torus inner hole diameter δ is about $0.25d$, and the ratio of the axial dimensions of the ellipse is about 0.7:1 (the data are borrowed from [30] and refer to the structure of air smoke toroids) (Figs. 5.13, 5.14). For etheric helical vortex toroids, the size and shape ratios will probably be somewhat different, but this is hardly significant.

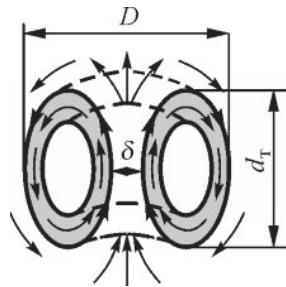

Fig. 5.13. Toroidal gas vortex in section

In a vortex gas toroid, the structure of which is close to a closed pipe with compacted walls, the core - the central part having an axial hole, the shell formed by the outer walls of the same pipe, and the boundary surface layer holding the gas in a compacted form in the walls are clearly distinguished. The current lines of gas in toroidal motion in the walls of the tube pass in the inner part of the toroid through an area substantially smaller than the outside. Therefore, the velocity of toroidal gas motion in the central part of the toroid is much greater than in the outer walls. However, the total flow velocity cannot change because the energy of the dense gas flow motion has nowhere to go, so the gas current line changes direction: a circular direction is added to the toroidal direction. By

The toroidal component of velocity decreases as it moves away from the torus axis, while the annular component increases. The gas motion in the pipe walls becomes helical.

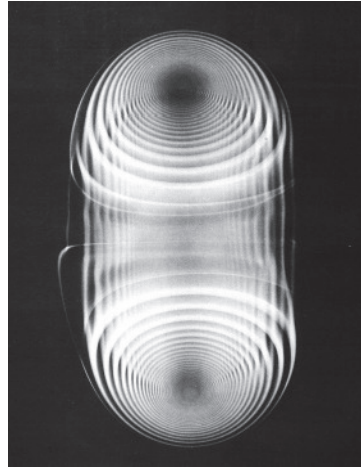

Fig. 5.14. Structure of a smoke ring. Releasing smoke into the air through the end of the chimney, one can see that it is a tightly coiled toroidal spiral. However, this is only a transient structure that further forms a laminar toroidal vortex

The sign of the helical motion in the toroid is determined by what sign of the helical motion the gas flow in the surrounding space had by that time. If there already existed in it the motion of gas jets of a certain sign, the newly formed toroidal vortices will also have a helical motion of the same sign. This means that if at least one helical vortex toroid has already been created in some region of space, then all other toroids formed will have the same sign of helical motion.

A toroidal vortex is a closed vortex formation in the form of a toroid (of the bagel type). If the radius of the toroid body r is many times smaller than the toroid radius R , the internal structure of the vortex does not differ from the structure of the linear vortex described above. However, if the values of the radii are commensurable, the picture changes significantly. When the radii of the toroid body and the toroid itself are commensurable, different parts of the pipe walls - the gas compacted in them are not in equal position. The part of the walls that

is closer to the center axis, has a total cross-sectional area substantially smaller than the portion of the walls away from the axis.

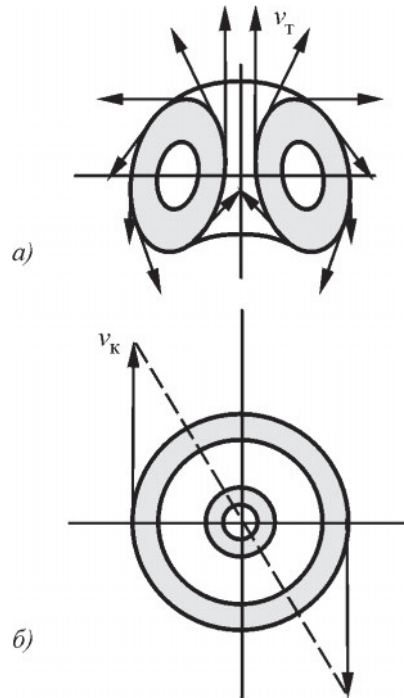

Fig. 5.15. Distribution of velocities of toroidal vortex wall motions: *a* - toroidal; *b* - ring vortex

The wall-forming gas flow (toroidal flow) must completely pass through both one and the second cross-section. Therefore, the gas flow rate through both cross-sections must be the same. However, since the area of the second cross-section is much larger than the area of the first cross-section, the toroidal velocity of the gas in the outer cross-section must be much smaller than in the inner cross-section. Since the toroidal velocity in the central part of the toroid is large, the jet will be carried along the axis by inertia and the entire toroid will take the shape of a bulb.

For the toroidal velocity of the gas flow to decrease, it must either be extinguished by something or change direction.

There is nothing to dampen the velocity in this case, because the gas in the toroid walls is compacted and it is impossible to give energy to the outside or take it from there. Consequently, the gas flow velocity will remain constant, but it will be forced to change its direction perpendicular to the original direction. As a result, there is a circular motion of the entire toroid, and at each point of its surface there is a combination of toroidal and circular motion, which together give a helical motion of the toroid walls. Fig. 5.15 shows the velocity distribution of toroidal and annular motions of the toroidal vortex walls at commensurate radii of the toroid body and the toroid itself.

A vortex helical toroid can be characterized by toroidal intensity, annular intensity and internal energy.

For a thin ring, where the radius of the ring body r is much smaller than R_k - the radius of the ring itself, the intensity of toroidal motion (along the circular axis) will be:

$$G_T = v_T S = 4\pi^2 r R v_{kT}, \quad (5.54)$$

where v_T is the velocity of tangential motion and the intensity of annular motion

$$G_K = v_K S = 4\pi^2 r R v_{kK}, \quad (5.55)$$

where v_K is the speed of the circular motion.

For a spherical toroid the expression is more accurate

$$G_T = v S_{TT} = 4\pi R_T^2 v_T; \quad (5.56)$$

$$G_K = v S_{KT} = 4\pi R_T^2 v_K; \quad (5.57)$$

where S_T is the surface area of the toroid; R_T is the outer radius of the toroid body; v_T and v_K are, respectively, the toroidal and annular velocities at the equator of the globular toroid.

The toroid surface temperature T_n will be determined by the expression

$$T_n = T_\infty - \sqrt{\text{Pr}} v_n^2 / 2c_p, \quad (5.58)$$

where T_∞ is the gas temperature in free space; Pr is the Prandtl number (for $\chi = 1.4\text{Pr} = 0.723$); v_n is the gas velocity at the toroid surface; c_p is the heat capacity of the gas at constant pressure.

The total internal energy of the toroid will be:

$$w_T = mv^2/2 = m(vt^2 + v_k^2)/2, \quad (5.59)$$

where v is the velocity of the aether flow in the toroid body. For a globular shape this velocity is approximately equal to the annular velocity at the equator of the toroid, for a thin vortex ring the flow velocity is 1.41 times greater.

Spiral vortex rings of a gaseous medium, the aether, which is essentially compacted, can be regarded as stable elementary particles that form matter.

Consider the internal energy of a toroidal vortex of compressible gas. The mass of an elementary gas jet in the vortex is equal to:

$$\Delta m = 2\pi r \Delta r b \rho. \quad (5.60)$$

Since

$$\Delta r / \Delta r_0 = r / r_0; \quad \rho / \rho_0 = r_0^2 / r^2, \quad (5.61)$$

the
n

$$\Delta m = 2\pi r \Delta r b \rho = 2\pi r_0 \Delta r b \rho_0. \quad (5.62)$$

Since

$$G = 2\pi r v_{00} = 2\pi r v = \text{const}; \quad (5.63)$$

$$v = \omega r = 2\pi r \nu; \quad (5.64)$$

$$r^2 = r_0^2 v_0 / \nu; \quad (5.65)$$

then the energy of an elementary gas jet in the vortex is equal to

$$\begin{aligned} \Delta E &= \frac{\Delta m v^2}{2} = \pi r_0 \Delta r b \rho_0 - 4\pi^2 v^2 r^2 = 4\pi^3 r_0^3 \Delta r b v_{00} \rho_0 v \\ &= \Delta h v = 2\pi \hbar \nu, \end{aligned} \quad (5.66)$$

wh
ere

$$\Delta h = 4\pi^3 r_0^3 \Delta r b v_{00} \rho_0. \quad (5.67)$$

Hence, for the whole vortex the internal energy is equal to

$$E = h\nu = 2\pi\hbar\nu = 2\pi\hbar r\omega, \quad (5.68)$$

whence it follows that the stronger the vortex will be compressed by the external pressure, the higher will be its angular velocity of rotation.

Correspondingly for a thin vortex toroidal ring we will have

$$E_k = \frac{J\omega^2}{2} = \frac{Mr^2\omega^2}{2}. \quad (5.69)$$

Considering that

$$G_k = 2\pi r v_{\text{circ}} = 2\pi r v = \text{const}; \quad v = r \omega, \quad (5.70)$$

we get

$$G_k = 2\pi r^2 \omega, \quad (5.71)$$

and, hence, the annular rotation energy is

$$E_k = \frac{MG_k \omega}{2} = \pi MG_k f = hf = 2\pi\hbar f. \quad (5.72)$$

Thus, Planck's constant \hbar acquires a simple physical meaning:

$$\hbar = MG / 2_k \quad (5.73)$$

i.e., half of the product of the toroidal helical vortex mass by the circumferential (circular) velocity circulation. In physics it is usually accepted to denote the frequency not by the sign "f", but by the sign "ν".

Accordingly, the momentum (spin) of the toroidal helical vortex will be as follows

$$L = Mrv = Mr^2\omega = MG_k = p \quad (5.74)$$

5.6. Gas motion in the vicinity of a toroidal vortex

5.6.1. Toroidal and circular motions of gas in neighborhoods of a helical toroidal vortex

For a linear vortex of infinite length, the velocity of medium motion decreases in proportion to the first degree of distance. If two vortex filaments of infinite length rotate in opposite directions near each other, then in each point of space there is a vector subtraction of velocities and the decrease of the total velocity of medium motion is proportional to the second degree of distance.

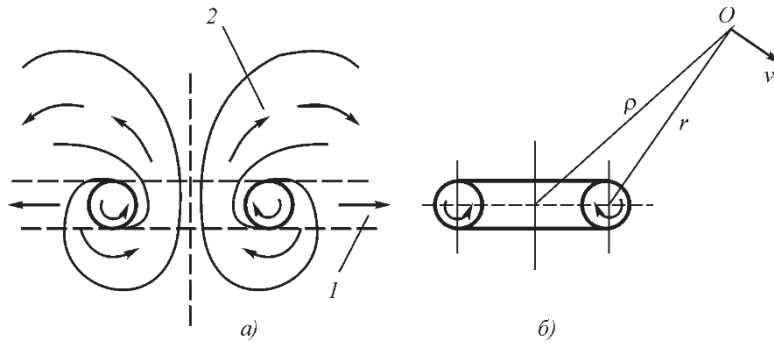

Fig. 5.16. To derive the law of velocity distribution around a toroidal annular vortex: (a) for toroidal motion and (b) for annular motion; 1 - propagation of annular motion by a spinner in the absence of toroidal motion; 2 - propagation of annular motion by toroidal motion

But if the filaments are not infinite, but represent a toroidal ring, then the decrease in the velocity of the medium occurs in the first approximation proportional to the third degree of distance and is described by the Bio-Savar law (Fig. 5.16):

$$v(r) = \int \frac{D_T (r - \rho) \times d\rho}{4\pi L |r - \rho|^3}, \quad (5.75)$$

where G_t is the value of the tangential velocity circulation at the vortex surface; r is the radius-vector of the vortex filament L ; ρ is the radius-vector of the point at which the velocity is considered.

The velocity components along the coordinate axes are as follows:

$$\begin{aligned}
 v_x &\sim -G_T \frac{3 \sin \varphi \cos \varphi}{4 r^3} \cos \theta; \\
 v_y &\sim -G_T \frac{3 \sin \varphi \cos \varphi}{4 r^3} \sin \theta; \\
 v_z &\sim -\frac{3}{2} \frac{G_T}{r^3}.
 \end{aligned} \tag{5.76}$$

If a toroidal vortex has, in addition to the toroidal vortex, an annular rotation around its axis, it captures the surrounding gas by its motion and throws it away from the vortex. If the motion were to occur in the vicinity of a cylindrical vortex with gas suction at its ends, the velocity of the incoming gas motion would change according to the hyperbolic law:

$$v = G / 2\pi r, \tag{5.77}$$

where G is the circulation of the annular motion. In this case, the sprawl of the annular motion would occur only in the thickness of the cylinder in the form of a flat "pancake".

However, in a toroidal vortex, the presence of toroidal motion around it blurs the layer in which the annular motion occurs. As a result, the annular motion of the medium covers first one half of the sphere and then the other half. Since the volume circulation is bGk (b is the thickness of the ring, Gk is the circulation of the annular motion), and the erosion of the layer occurs within the surface of the sphere equal to $4\pi r^2$, the annular velocity in the space surrounding the toroidal vortex is determined by the expression

$$v_k = \frac{bGk}{4\pi r^2}, \tag{5.78}$$

and, hence, for annular motion in the neighborhood of a helical toroidal *vortex* $v_k \sim 1/r^2$.

The annular velocity flow is defined by some analog of the Ostrogradsky-Gauss theorem:

$$\int_S v_k dS = bG_k. \quad (5.79)$$

It should be noted that the above expressions are purely kinematic in nature, not taking into account the compressibility of the medium, which is especially manifested near the toroidal vortex body, and also not taking into account the inertia of the gas mass flowing out of the central hole of the toroid. Accounting for inertial forces leads to the fact that the flow is asymmetric with respect to the plane of the ring. This asymmetry affects the annular motion as well.

It should be noted that, unlike the toroidal one, in the velocity distribution of the annular motion in the vicinity of a helical toroidal vortex, the case when the annular motion is closed in the vicinity of the vortex body is possible. This is due to the difference in the causes of formation of these motions.

Unlike toroidal gas motion, which is transmitted due to pressure from the colliding gas elements, annular motion is transmitted from layer to layer mainly due to gas viscosity. If the velocity gradient is relatively small, there is no significant decrease in viscosity, since viscosity is related to temperature by the relation (5.6), and temperature itself is related to the velocity difference by the expression:

$$\Delta T = \sqrt{\text{Pr}} \frac{(\Delta v)^2}{c_p \rho}, \quad (5.80)$$

where Pr is the Prandtl number (for gases $0.72 < \text{Pr} < 1$), c_p is the heat capacity at constant pressure, ρ is the density of the gas.

If the velocity difference is large, as it can be in the boundary layer, the temperature difference is correspondingly large and the viscosity is significantly reduced. In this case, the annular motion will not be transmitted to the outer layers, such a position of the vortex will be stable, and the toroid will rotate in this boundary layer, as in a sliding bearing, without further transmitting its motion.

Thus, the toroidal vortex itself, possessing a circular motion, appears to be a helical vortex, and its vicinity is covered by a helical motion with a variable helical factor, since the ratio of velocities of the toroidal and circular motions varies differently depending on the distance from the vortex: the toroidal motion decreases in proportion to the cube, and the circular motion decreases in proportion to the square of the distance from the vortex center.

5.6.2. Temperature field near the vortex and absorption of the surrounding gas by the vortex

As was shown above, any vortex, including a toroidal vortex, has a reduced temperature relative to the external medium. As is known [18, 22, 30, 31, p. 447-455], the temperature distribution in gas is determined by the heat conduction equation

$$\frac{dT}{dt} = a \left(\frac{dT^2}{d^2x} + \frac{dT^2}{d^2u} + \frac{dT^2}{d^2z} \right), \quad (5.81)$$

or abbreviated

$$T(M, t) = a \Delta T - \frac{f}{\rho c_p}, \quad (5.82)$$

where $T(M, t)$ - temperature of the medium at point M with coordinates x, y, z at time t ; a - heat conductivity coefficient of the medium, characterizing the speed of temperature equalization in a non-uniformly heated body; f - density of heat sources; c_p - specific heat capacity of the medium; ρ - density of the medium

$$\Delta = \left(\frac{d^2}{d^2x} + \frac{d^2}{d^2u} + \frac{d^2}{d^2z} \right). \quad (5.83)$$

A compacted toroidal vortex is close to a ball in its shape, and at distances of only a few radii, the difference between the temperature field of the toroid and that of the ball becomes absolutely

insignificant. Therefore, to simplify the whole problem of temperature distribution in the medium surrounding the toroid, a ball is taken as its model.

In spherical coordinates for spherical heat source of power q the solution of equation (5.83) has the form:

$$T(r,t) = \frac{q}{4\pi a c_p \rho r} \int_0^\infty e^{-\alpha^2 r^2 / 4at} d\alpha, \quad (5.84)$$

where r is the distance from the center of the heat source.

The temperature gradient proportional to the heat flux is defined by the expression:

$$\text{grad } T = - \frac{dT}{dr} = - \frac{q}{2\pi^{3/2} a c_p \rho r} \frac{\partial}{\partial r} \int_0^\infty e^{-\alpha^2 r^2 / 4at} d\alpha. \quad (5.85)$$

The temperature gradient at small distances from the heat source is defined as

$$\begin{aligned} \text{grad } T &= k_q q \frac{\partial}{\partial r} \left(\frac{1}{r} \int_0^\infty e^{-\alpha^2 r^2 / 4at} d\alpha \right) = \\ &= k_q q \frac{\partial}{\partial r} \left(\frac{1}{r} \int_0^\infty e^{-\alpha^2 r^2 / 4at} d\alpha + \frac{1}{r} \int_0^\infty e^{-\alpha^2 r^2 / 4at} d\alpha \right) = \\ &= \frac{k_q q \sqrt{2\pi}}{r^2} - k_q q \dots \end{aligned} \quad (5.86)$$

The last term tends to zero at $r \rightarrow 0$. At large distances the expression

$$\frac{1}{r} \int_0^\infty e^{-\alpha^2 r^2 / 4at} d\alpha \quad (5.87)$$

decays significantly faster than $1/r$, since the maximum of the integral occurs at $r = 0$. Consequently, the temperature gradient decreases at large radii significantly faster than r^{-2} .

The temperature gradient in three-dimensional space can be represented in the following form:

$$\text{grad } T = - \frac{k q_q}{r^2} F(r,t) \tag{5.88}$$

$$F(r,t) = \frac{1}{\sqrt{2\pi}} \int_{-\infty}^{\infty} e^{-\alpha^2 (r/r_0)^2} d\alpha; r_0 = 2 \sqrt{at} \tag{5.89}$$

In doing so,

$$\lim_{r \rightarrow 0} F(r,t) = 1. \tag{5.90}$$

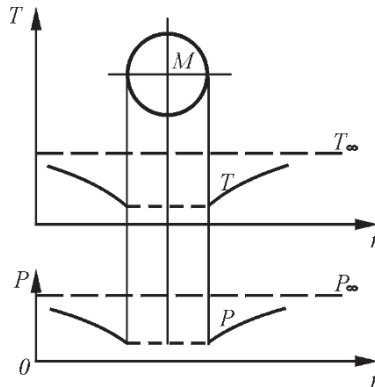

Fig. 5.17. Temperature and pressure distribution around a set of toroidal vortices in free space

Thus, the temperature gradient at small distances decreases proportionally to the square of the distance, and at large distances it decreases much faster (Fig. 5.17).

It is of interest to determine the propagation velocity of the temperature gradient. Since pressure in a gas is related to temperature by a proportional relationship

$$T = \frac{2Pm_a}{3\rho k}, \quad (5.91)$$

where P is the pressure; m_a is the mass of the molecule; ρ is the density; k is Boltzmann's constant, then

$$\text{grad}T = \frac{2m_a}{3\rho k} \text{grad}P \quad (5.92)$$

and, hence, the propagation velocity of the temperature gradient is the propagation velocity of the pressure gradient, and this is the velocity of the first sound, defined as

$$a = \sqrt{\gamma P/\rho}. \quad (5.93)$$

Under the influence of the pressure gradient, all gas begins to shift toward the toroidal vortex and to be absorbed by it, due to which the mass of the vortex and its volume continuously increase. Since the momentum of both toroidal and annular motions is conserved, the gas velocity on the toroid surface decreases, the velocity gradient decreases accordingly, and the temperature of the toroid surface increases. This leads to the fact that the viscosity of gas on the toroid surface increases, and the surface area also increases, so the energy release of gas jets motion into the external environment increases. The vortex increases its size and energy output. Its stability decreases, and over time the vortex diffuses and ceases to exist.

5.7. Diffusion vortex

A gas vortex at its creation builds up energy due to compression of the body by the pressure of the gas surrounding the vortex, and then begins to waste it due to the viscosity of this gas. Such a process is well illustrated by annular vortices formed with a smoke-filled so-called "Wood's box" - a box with a hole, the opposite side of which is covered with an elastic membrane. When the membrane is struck, a ring vortex - toroid - bursts out of the hole and moves rectilinearly, changing its dimensions (Fig. 5.18).

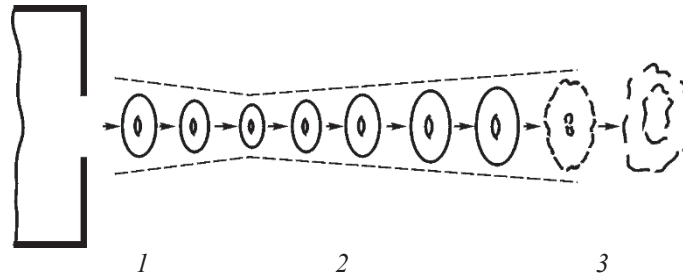

Fig. 5.18. Movement and transformation of a gas toroid: 1 - stage of toroid compression; 2 - stage of toroid expansion (diffusion); 3 - stage of toroid collapse.

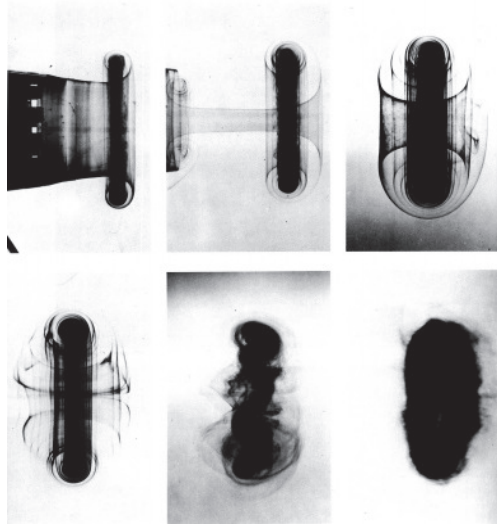

Fig. 5.19. Instability of a laminar vortex ring. The upper row of images shows the flow of water with injected paint through a five-centimeter hole, resulting in an axisymmetric vortex ring. The bottom row of images shows the successive collapse of the ring due to instability. Further the ring diffuses completely [54]

In the first stage, lasting a fraction of a second, the diameter of the toroid decreases; in this stage, the toroid increases its energy due to compression by external gas pressure. In the next, second, stage, the toroid enlarges. Now it loses energy due to viscosity (vortex diffusion). This second stage lasts longer than the first stage. Then comes the third stage, in which the toroidal ring begins to slow down and swell, and then collapse. The toroid ceases to exist. Modeling of a vortex ring in water (Fig. 5.19) confirmed the above.

However, as the density of the vortex body increases, the fraction of the released energy decreases proportionally to the density ratio and the relaxation time increases accordingly. Considering that an increase in the density of the vortex body occurs due to a reduction in its size and a corresponding increase in its rotational velocity, and hence an increase in the velocity gradient and viscosity drop in the boundary layer, it should be assumed that the time increases approximately proportionally to the square of the ratio of the densities of the vortex body and the medium.

Hence, for the compacted vortex the relaxation time is

$$\tau = 0,36 \frac{d^2}{\chi} \frac{\rho_t}{\rho_{cp}} \quad (5.94)$$

The diffusion of the vortex will be affected not only by the viscosity of the medium, but also by the fact that it absorbs the surrounding gas. The pressure gradient in the gas caused by the temperature gradient will lead to displacement of particles of the gas surrounding the vortex towards the vortex, continuous absorption of the surrounding gas into the vortex body by the vortex and increase of the vortex mass. Since the toroidal and annular momenta are conserved and the mass increases, this will lead to a gradual increase in the vortex volume, a decrease in the velocity of the flows in the vortex body, a decrease in the velocity gradient in the boundary layer, and a corresponding increase in viscosity. The increase in vortex volume and surface area, together with the increase in viscosity, will lead to an acceleration of the energy loss of both types of motion. The loss of energy will lead to a loss of stability, and at a certain stage the vortex will cease to exist.

5.8. Force interactions of gas and vortices

5.8.1. Essence of force effects of gas medium on bodies

The main influence of the gas medium on vortices occurs during vortex formation, when the external pressure compresses the vortex body, bringing its density to some limiting value. This process is considered above. As it was shown, in the process of vortex formation there is an acceleration of ether flows forming the vortex body, as well as a decrease in the temperature of the whole vortex body and, accordingly, of its surface. As a result, flows are created in the environment by the already formed vortex and the temperature decreases, which creates corresponding velocity and temperature gradients. This leads to the appearance of ether pressure gradients in the vortex environment. Another vortex caught in the field of these pressure gradients experiences force influences from the ether side. The same applies to vortex systems, i.e. to all material bodies, since all of them are certain aggregates of ether vortices.

In this way, bodies interact through an intermediate medium, the ether, in which the transfer of impulses from one amer to another occurs by elastic collision. This is how the concept of close action is realized in nature.

It was shown above what kinds of motions are created by vortices in the ether medium, in fact there are only two such motions - they are either jet flows of predominantly helical structure with different helical factor or thermodiffusion. The first ones are created in the medium either by motions of surfaces of vortex helical toroids, i.e. in a tangential way, here viscosity plays an important role, or due to pressure difference, i.e. in a normal way. The pressure difference can occur, for example, as a result of vortices disintegration and release of aether previously compressed in its body. The second ones are created in the medium as a result of its cooling by the vortex body, in which the temperature is always lowered relative to the environment.

The basis of all kinds of interactions in the ether is its internal energy, which is the result of thermal displacement of amers in space and is realized in the form of pressure. This pressure is very high and amounts to $1.3 \cdot 10^{36}$ Pa (lower limit). Due to this pressure, all vortices formed in the aether are compressed, and the main ones - protons - are compressed to the limit density. However, this pressure does not directly affect the interaction of vortex structures,

because everything here is balanced and each vortex is pressurized from all sides. It is not felt, just as the pressure of the atmosphere on objects is not felt, although the atmosphere presses on each square centimeter with the force of one kilogram. Force interaction of ether with vortices is realized when the vortex falls into a pressure gradient and different pressures act on different sides of the vortex. This pressure difference, connected with the presence of pressure gradient in the medium, affects the vortex as an integral structure, forcing it to shift or deform. According to the nature of their influence, they can be divided into:

frontal impact of gas flow on the body; lateral impacts of gas flow on the body; thermodynamic impact of the medium on the body.

5.8.2. Frontal impact of gas flow on body

A body in a flow of gas experiences a frontal pressure from the side of the flow. This dynamic pressure arises due to flow braking on the side of the body facing the flow. On the back side of the body a rarefaction can be formed, and in some cases - and the attached vortex, at the boundaries of which the pressure will be reduced, than the additional influence of the medium on the vortex will be exerted (Fig. 5.20).

On the contrary, when a body is moving in a stationary medium, all the mentioned influences remain in the same form, but in this case it is accepted to speak about the drag experienced by the body.

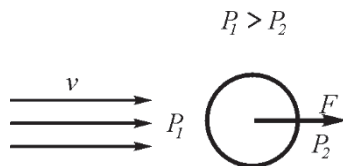

Fig. 5.20. Frontal impact exerted on the body by the gas flow

The force acting on the body in both cases is described by the expression

$$F = c_w \rho S v^2, \quad (5.95)$$

where ρ is the density of the medium; S is the cross-sectional area of the body; v is the velocity of the impinging flow; c_w is a dimensionless coefficient that is a function of the dimensionless Reynolds number:

$$\text{Re} = \frac{vd}{\chi} \quad (5.96)$$

Here d is the so-called "characteristic size" (for a ball - its diameter), χ is the kinematic viscosity of the medium [18, pp. 29-31, 40-42].

Both the Reynolds number and the dimensionless drag coefficient can vary over a wide range, the latter from a few hundredths (at small Reynolds numbers of the order of tenths) to a few tenths (at large Reynolds numbers of the order of hundreds of thousands and millions), with the drag coefficient decreasing as the Reynolds number increases.

5.8.3. Lateral effects of gas flow on body

A jet stream washing a body from one side of it has two effects on it - longitudinal and transverse (Fig. 5.21).

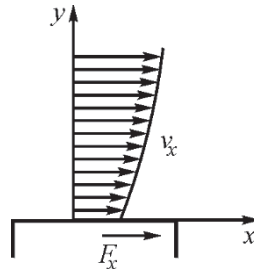

Fig. 5.21. Origin of the longitudinal force acting on the body from the side of the washing flow

Longitudinal jet lateral action is the result of flow braking by the side of the body due to the viscosity of the medium, the value of the resulting force lying in the direction of the flow is determined by Newton's equation [33, p. 210]:

$$dF_x = -\eta dS \frac{dv}{dy}, \quad (5.97)$$

where η is the dynamic viscosity of the medium; dS is the element of the washed surface area; dv/dy is the velocity gradient in the direction perpendicular to the surface. However, Newton's equation describes the process only in the first approximation; in fact, the picture is quite complex and is related to changes in viscosity from temperature, to the influence of changes in gas density, etc.

When the plate is washed by the flow of gas on its surface, the pressure decreases. In the first approximation this force can be determined from the Bernoulli equation:

$$\frac{v^2}{2} + \int \frac{dP}{\rho} = \text{const.} \quad (5.98)$$

Assuming for the first approximation $\rho = \text{const}$ (i.e., neglecting density changes), we obtain the expressions for the total energy of the flow

$$\frac{\rho v^2}{2} + P = w = \text{const.} \quad (5.99)$$

where w is the total energy of a unit volume of the flow.

Taking the first derivative in the direction perpendicular to the plane of the washed area, we obtain

$$\rho v \frac{dv}{dy} = - \frac{dP}{dy}. \quad (5.100)$$

Taking the integral from the value of y_1 , at which $v = v_1$ to the value of y_2 , at which $v = v_2$, so that $v_2 - v_1 = \Delta v$, we obtain:

$$\frac{\rho(\Delta v)^2}{2} = - \Delta P. \quad (5.101)$$

Thus, on the side of the plate washed by the gas flow, the pressure will be less than on the opposite side, and the formation of a

resultant force in the direction perpendicular to the flow direction (Fig. 5.22).

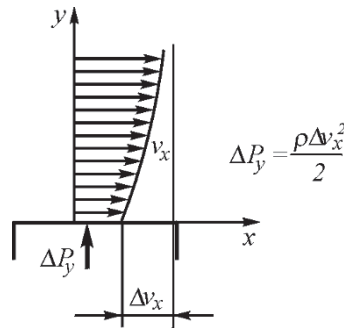

Fig. 5.22. Origin of the transverse force acting on the body surface from the side of the washing flow

If a rotating cylinder or cylindrical gas vortex is washed by a gas flow, a velocity gradient will occur on it. On the side where the flow directions are opposite, the velocity gradient will be greater than on the opposite side where the cylinder wall and flow directions coincide, here the gradient will be smaller. Accordingly, the pressure drop on the first side will be greater and the pressure itself will be less than on the second side.

The pressure difference will create a force on the surface of the cylinder directed perpendicularly to the onrushing flow in the direction of the lower pressure, i.e., in the direction of the highest velocity difference. The phenomenon was discovered in 1852 by the German scientist G.G. Magnus and was called the Magnus effect (Fig. 5.23) [34, 35]. N.E. Zhukovsky proved a theorem according to which the lifting force Y acting on an object washed by the flow is defined as the product of the medium density ρ by the flow velocity v_n and by the circulation of the same velocity along any closed contour G :

$$Y = \rho v_n G, \quad (5.102)$$

Zhukovsky's theorem has an integral character. To understand the physical nature of this force it is of interest to define its differential expression.

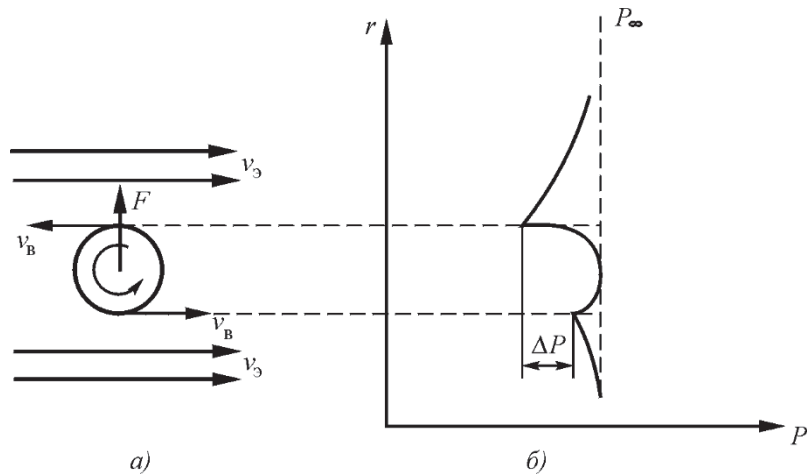

Fig. 5.23. Origin of the transverse force acting on a rotating cylinder from the side of the washing flow: *a* - streamline of the cylinder by the gas flow: *b* - epule of gas pressures on the cylinder.

A pressure difference will act on the body of the rotating cylinder

$$\Delta P = \Delta P_2 - \Delta P_1 = -\frac{\rho}{2} (\Delta v_2^2 - \Delta v_1^2). \quad (5.103)$$

Here Δv_2 and Δv_1 are, respectively, the velocity differences between the cylinder surface and the impinging flow on both sides of the cylinder.

Thus, in the direction perpendicular to the flow direction, the force associated with a decrease in ambient pressure will act on the surface. The physical basis for the change in flow velocity at the washed surface is the viscosity of the medium. As will be shown below, this force is the physical basis of strong nuclear and electromagnetic interactions.

5.8.4. Thermodynamic effect of the medium on body

When a body is in the gradient temperature field of the ether, it is affected by the force due to the fact that the pressure of the gas

in proportion to its temperature and related to temperature by the relation [38, 39]:

$$\text{Re} = \frac{3 \rho_3}{2 m_a k T_3}, \quad (5.104)$$

where $k = 1.38 \cdot 10^{-23}$ - J-K is the Boltzmann constant; $\rho_3 = 8.85 \cdot 10^{-12}$ kg-m⁻³ - density of ether; $m_a = 1.5 \cdot 10^{-14}$ kg is the mass of amer.

Consequently, to analyze the distribution of pressures in the ether it is necessary to consider the distribution of gas density and temperatures. The absolute value of the pressure of the ether itself has no influence on the appearance of a force tending to move a body from one point to another. The cause of the appearance of such a force can only be the difference of pressures acting on the body from opposite sides. This difference can appear only if there is a pressure gradient in space. In this case, the ratio of temperature to pressure, as well as the ratio of their gradients, in the ether will be as follows

$$\frac{T_3}{\text{grad} T_3} = \frac{2m_a}{3K\rho_3} = \frac{2 \cdot 1,5 \cdot 10^{-14}}{3 \cdot 1,38 \cdot 10^{-23} \cdot 8,85 \cdot 10^{-12}} = 8,2 \cdot 10^{-81} \text{ K} \cdot \text{Pa}^{-1}. \quad (5.105)$$

The resulting force acting from the medium on a body, for example, on a closed toroidal vortex, will be proportional to the pressure gradient and the size of the vortex (provided that the size of the vortex is small compared to the distance from the body that created the temperature field). This force will be

$$F = S L_{\text{ЭКВ}} \text{grad} P = V_{\text{ЭКВ}} \text{grad} P. \quad (5.106)$$

Here $S_{\text{ЭКВ}}$ is the equivalent cross-sectional area of the body; $L_{\text{ЭКВ}}$ is the distance equivalent to the length of a parallelepiped experiencing the same force as the vortex under consideration, on which the force acts; $V_{\text{ЭКВ}}$ is the equivalent volume of the body.

It can be shown that at a constant pressure gradient in the medium, the force acting on the body does not depend on the orientation of the body in space. Thus, for a parallelepiped with sides equal to a , b , c , respectively, at orientation of side a along the axis along which the pressure gradient acts, we obtain (Fig. 5.24) the difference of pressure on the faces

$$\Delta P = P_2 - P_1 = a \text{ grad} P. \quad (5.107)$$

The cross-sectional area of the body will be

$$S = bc. \quad (5.108)$$

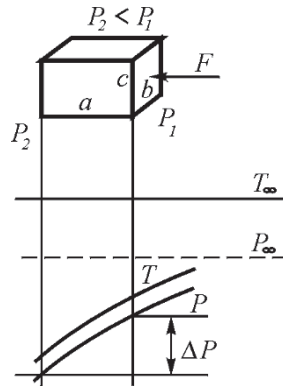

Fig. 5.24 Origin of force thermodynamic influence on the body from the side of non-uniformly heated medium

The total force will be

$$F = S\Delta P = abc \text{ grad}P = V \text{ grad}P. \quad (5.109)$$

If the force is oriented along the side b , we have

$$\Delta P = P_2 - P_1 = b \text{ grad}P, \quad (5.110)$$

and the cross-sectional area of the body will be

$$S = as. \quad (5.111)$$

The total force in this case, too.

$$F = S\Delta P = abc \text{ grad}P = V \text{ grad}P. \quad (5.112)$$

Since

$$\text{grad}P_3 = -\frac{3\rho_3}{2m_a} k \text{ grad}T_3, \quad (5.113)$$

then the problem of finding the forces acting on the second body from the first one is reduced to finding the dependence of the temperature gradient in the medium on the distance from the first body creating the heat flow in space.

At calculation of the first approximation we can put $\rho_e = \text{const}$, since the acting forces are small and do not essentially change the aether density. This assumption simplifies considerably the conclusions of dependences.

As it will be shown further, thermodynamic influences of the ether on bodies are the basis of gravitational interactions of bodies.

Conclusions .

1. All material material entities are compacted vortices of gas-like ether, and therefore the vortex (rotational) motion of gas plays a special role in the structure of matter. Much attention has been paid to the study of vortex motion and related phenomena by various researchers, who have obtained important results. However, many problems of the theory of vortex motion of gas, related to the formation and diffusion of vortices, their energetics, interaction of helical flows, boundary layer theory, etc., have not yet been properly developed.

2. The condition for the emergence of vortex motion is a gradient flow resulting, for example, from the collision of two gas jets. In the process of formation, toroidal vortices are able to divide and compact, forming increasingly smaller and increasingly dense toroidal vortices. The temperature of the vortex body decreases with compaction, and the tangential motion velocity increases, not only due to compression of the vortex body by external pressure, but also due to redistribution of the thermal motion velocity of molecules into the increment of the tangential rotation velocity of the vortex. The tangential motion velocity of the inner layers of the vortex is higher than that of the outer layers.

3. During the formation of a gas vortex, the potential energy of the pressure of the gas surrounding the vortex is spontaneously transformed into the kinetic energy of the vortex rotation. In this case, the law of constancy of the momentum of motion is observed, and the more strongly the vortex body is compressed, the more energy from the surrounding gas is pumped into it.

of the medium. Thus, the formation of a gas vortex is a natural process of converting the potential energy of gas pressure into the kinetic energy of vortex rotation.

4. The compacted gas in the local volume is able to hold only in the vortex of a toroidal structure like a self-enclosed tube. In the inner cavity of the toroid, the gas density and pressure are reduced, and the walls and core are significantly compacted. The toroidal vortex is surrounded by a boundary layer of gas in which the temperature and viscosity are reduced compared to the temperature and viscosity of the surrounding medium. This ensures the stability of the vortex toroid and the duration of its existence.

5. In a toroidal vortex, spontaneous helical motion, a combination of toroidal motion and annular motion, spontaneously arises around its central axis. The helical motion arises due to the difference in the cross-sectional area of the gas flow in toroidal motion in the inner and outer regions of the toroid. In this case, the velocity of toroidal motion decreases from the center to the periphery, while the velocity of annular motion increases. The helical toroidal vortex has increased stability.

6. A spiral toroidal vortex of gas in the process of formation concentrates the energy of the environment and is thus a natural mechanism for converting the potential energy of the gas medium into the kinetic energy of the vortex rotation.

7. Various forms of motion appear in the vicinity of a helical toroidal vortex: toroidal motion described by the Biot-Savart law; annular motion described by the Ostrogradsky-Gauss theorem; and thermodiffusion motion described by the heat conduction equation.

8. As a result of the temperature gradient in the vortex surrounding space, the gas moves towards the vortex, the vortex body absorbs the gas of the external medium, thus increasing the size and decreasing the rotation velocity, which reduces the vortex stability, leads to increasing losses of rotation energy to the external medium and, finally, to the vortex diffusion and its disintegration.

9. All interactions between gas vortices in a common gas medium occur according to the principle of close action through this medium. Each vortex formation creates by its motions corresponding motions in the surrounding gas, which in its turn influences other vortex formations.

10. There are only four types of impacts of gas medium motions on bodies: frontal along the flow direction, lateral along the

flow direction, lateral across the flow direction, and temperature. All of them are related to pressure gradients arising in the gas medium either due to velocity or temperature gradients of the gas.

Chapter 6. Nucleons and atomic nuclei

To seek a model and deterministic mechanics of individual microobjects that admits ordinary quantum mechanics as objective statistical mechanics

Jean Paul Vigiér [1]

6.1. A brief history of research on the atomic nucleus

The existence of the atomic nucleus was discovered by the English researcher E. Rutherford in 1911. [2]. While conducting experiments on the transmission of alpha particles emitted by a natural radioactive source through a thin foil of various substances, he found that alpha particles are more often than expected scattered at large angles. Rutherford correctly interpreted this fact as the presence in the atom of a positively charged nucleus of substantially smaller dimensions than the atom itself. Prior to Rutherford, atomistics was dominated by the ideas of J. Thomson, according to which the positive charge of the atom was considered to be uniformly distributed throughout the volume of the atom, and electrons were embedded more or less uniformly in this volume, like raisins in dough. In 1919, Rutherford discovered among the particles knocked out of atomic nuclei, protons - particles with a single positive charge and a mass 1840 times greater than that of the electron.

At the time of the discovery of the atomic nucleus, only two elementary particles, the electron and the proton, were known. Accordingly, it was considered probable that the atomic nucleus consisted of them. The idea of the proton emerged in the early twentieth century in the form of the hypothesis that all nuclei consist of the nuclei of hydrogen atoms. In 1919-1920. Rutherford experimentally observed hydrogen nuclei knocked out of other elements by alpha particles, and in the early 1920s he also introduced the term

"proton" [2]. However, at the end of the 20s, the proton-electron hypothesis encountered a serious difficulty called the "nitrogen catastrophe": the spin of the nitrogen nucleus, which had in its composition, as it was assumed, 21 particles - 14 protons and 7 electrons, each of which had spin $\frac{1}{2}$, in the aggregate should have spin $\frac{1}{2}$, and according to the data on the measurement of optical molecular spectra spin turned out to be equal to 1.

The composition of the atomic nucleus was clarified after the discovery by Rutherford's student J. Chadwick (1932) of the neutron [3], whose mass was close to that of the proton, with no electric charge and spin

was equal to $\frac{1}{2}$. Chadwick found that the penetrating radiation detected by the German physicists Bothe and Becker, arising from the bombardment of atomic nuclei, particularly beryllium, by α -particles, consisted of uncharged particles with a mass close to that of the proton.

The idea that the atomic nucleus consists of protons and neutrons was first expressed in print by D.D. Ivanenko (1932) [4] and immediately followed by W.Heisenberg [5]. Protons and neutrons were united by the common name of nucleons. The theory of the proton and neutron, as well as of the atomic nucleus consisting of protons and neutrons, is the subject of a large number of papers [6-26].

Later on, the theory of the atomic nucleus became more complicated. New particles were discovered, heavier than nucleons, which presumably should also be part of atomic nuclei. These particles were found in nuclear reactions when nuclei were bombarded by high-energy particles.

In accordance with the theory of relativity and quantum mechanics, it was decided that to study atomic nuclei it was necessary to bombard them with high-energy particles, for which high-energy gas pedals were built. In the 1970s, the energies of particles accelerated at gas pedals amounted to tens and hundreds of billions of electron volts (GeV). It is still believed that high energies open up the possibility of studying the structure of matter at smaller distances, the higher the energy of the colliding particles. Gas pedals have greatly increased the rate at which more and more "elementary particles" have been produced. Heavy antiparticles were produced - antiproton (1955), antineutron (1956), antisigma-hyperons (1960). In 1964, the heaviest hyperon was discovered with a mass of about two proton masses. In the 60s, a large number of extremely unstable particles, called "resonances", were discovered at gas pedals; the masses of most of them exceed the mass of a proton. In the 70s, the number of newly discovered particles with the most unexpected properties increased dramatically. To describe these new properties it was necessary to introduce a number of new concepts such as "strangeness", "charm", etc.

The quark theory [23], according to which heavy particles are constructed from various combinations of the "truly elementary" particles - three quarks and three antiquarks, each of which has a mass of the order of five proton masses. Combining quarks among themselves leads to the transformation of quark masses into binding energy, as a result, combining, for example, into a proton, three quarks, each having 5 proton masses, and a total of 15 proton masses, retain as a mass only one proton masses

mass, the remaining 14 proton masses are converted into the binding energy of quarks. True, in experiments quarks have never been found....

Along with the consideration of the atomic nucleus as consisting of elementary particles, a number of nuclear models were put forward, i.e., approximate methods of description based on the identification of the nucleus with some system whose properties are either well studied or amenable to a relatively simple theoretical analysis. These are, for example, the nuclear models of degenerate fermi-gas, liquid droplet, rotator (wave), shell model and others.

Various models have also been used to explain the nuclear forces that bind nucleons in nuclei (strong nuclear interaction). In 1935, the Japanese physicist H. Yukawa proposed a hypothesis according to which nucleons exchange with each other some particle possessing mass and being a carrier of nuclear forces [24]. A similar hypothesis was independently proposed by I.E. Tamm and D.D. Ivanenko. Such a particle was discovered in 1947 and named π -meson. But in the future it became clear that it is necessary to attract a number of other particles to explain the strong interaction. It is believed that nucleons themselves also make a certain contribution to the strong interaction. Particles participating in the strong interaction (hadrons) are surrounded by clouds of mesons. R. Feynman put forward the model of "partrons," which assumes that hadrons in inelastic collisions behave as a collection of point particles - the "partrons", distributed in some way by momenta. Quarks can be considered as partrons, considering that hadrons, in addition to three quarks, also contain a cloud of antiquark quarks.

In connection with the above, it is useful to recall additionally the history of the discovery of the neutrino, an electrically neutral elementary particle with a rest mass much smaller than that of the electron. The discovery of the neutrino, according to physicists, belongs to the most striking and at the same time difficult pages in the physics of the twentieth century.

The neutrino first appeared in experimental physics in 1914, when the English physicist J. Chadwick discovered that electrons emitted during the β -decay of atomic nuclei have a continuous energy spectrum. This phenomenon was in clear contradiction with the theory of quanta and led to a violation of the law of conservation of energy.

In 1930, the Swiss physicist W. Pauli, in a letter to the participants of the Thuringem seminar, reported his "desperate attempt" to save the law of conservation of energy. Pauli hypothesized that there was

a new electrically neutral strongly penetrating particle with a small mass, due to which the impression of non-observance of the law of conservation of energy is created. After the discovery of the neutron in 1932, the Italian physicist E. Fermi proposed to call such a particle "neutrino" (small neutron). Subsequently, the neutrino was discovered, and neutrino radiation was used as a tool to study intra-stellar processes.

In the various and numerous experiments conducted at high-energy gas pedals, various and diverse data on strong particle interactions have been obtained, as well as on the production of a wide variety of "elementary particles" of matter, the total number of which ranges from 200 to 2000, depending on how one counts and what one considers. However, all these experimental results do not match each other very well, so theorists have to complicate their models and theories all the time, which, as they believe, is explained by the complexity of the subject of research.

It is regrettable to state that the philosophical basis and methodological shadow of Einstein's theory of relativity and quantum mechanics hangs over all research in the field of the atomic nucleus. The theory of relativity, by throwing away the ether, has deprived the "elementary" particles of building material matter and thus structure. Particles have not only no mechanism explaining their properties - magnetic moment, spin, electric charge, etc., but even their size. All their properties came from nowhere, they are innate. Nuclear interactions have lost their physical basis. And since there is no medium through which particles could interact, the whole logic of researchers was directed to search for particles that could somehow explain the results of research, of which there were many. However, it did not occur to anyone that all this variety of particles, discovered with the help of high-energy gas pedals, are not contained in matter, but are obtained in the experiment itself, that all these are fragments or combinations of fragments of matter created by bombarding targets, and these fragments can be obtained countless. Practice confirms this.

It is also necessary to state that the models and theories of the atomic nucleus and strong interactions clearly demonstrate the philosophical helplessness of most theories and the lack of scientific methodology. The great disadvantage of the existing theories "elementary particles" is the lack of any understanding of the structure and structure of particles, as well as the nature of the fields surrounding the

them, and nobody cares. The physical reasons why all these numerous particles have all their properties and why they are able to transform into each other are not considered at all. The lack of understanding of the inner mechanism has led to many attempts to obtain information about the microcosm by increasing the capacity of plants in the blind hope of chance. But the installations, on which enormous funds have been spent, have been created, and there is little clarity in the structure of matter.

All this is regrettable. It should not be surprising, therefore, that programs of similar research at high-energy gas pedals were closed in 1999 almost all over the world, probably because of their uselessness. The path followed by all these studies turned out to be a dead end.

6.2. Determination etherodynamic proton parameters

From the very beginning, ether dynamics assumes the existence of a building material from which all elementary particles of matter are composed. This immediately allows us to raise the question about their structure and about the internal motion of matter, the result of which are all the external properties of microparticles.

Observations of the Byurakan Observatory (Hambardzumian) on the activity of the nucleus of the spiral galaxy have revealed the outflow of proton-hydrogen gas from its nucleus, as well as the presence of a cluster of young stars around the nucleus. This allows us to express a certain confidence that it is in the core of the spiral galaxy that protons are born, from which stars are formed in the future, and then in the process of evolution all other elements are created in them.

The proton is the basic microparticle of the entire universe at the level of matter. This follows from the fact that the proton is the basis of the hydrogen atom, it is part of the nuclei of all substances, and, as it turned out, the neutron is the same proton in one of its states. Therefore, we can assume that more than 99% of the mass of all visible matter in our Galaxy, and probably in the Universe, consists of protons.

Since the only kind of ether motion capable of collecting compacted ether in a closed volume are toroidal vortices, the structure of the proton must be identified with just such a structure.

Despite the not very clear classification of vortex and turbulent flows existing nowadays in hydromechanics, it is possible to note a significant dependence of the character of flows of liquid and gaseous media on the values of the Reynolds number. In this connection, it is of interest to determine the values of the motion parameters of ether flows in our Galaxy.

As shown below, the Ether streams move along the two arms of the spiral Galaxy towards each other, meeting in the central part - its core. As a result of collision and mixing of ether streams, closed toroidal vortices are formed. As Zhukovsky's experience with a drop falling into water shows, a toroidal ring vortex is formed immediately after the drop comes into contact with water. The formed toroid begins to emit jets, divide and form several smaller toroidal rings, and so several times (see Fig. 5.12). Unlike vortex formation in a liquid, when forming in the ether, the vortex ring is compressed by the pressure of the ether surrounding them, and then divides again into ever smaller toroids. This process of compaction and fission occurs repeatedly, until the walls of the formed proton are compacted to some critical value at which fission ceases. The toroidal helical vortices of compacted ether formed at the last stage are protons.

Since the Reynolds number for stable vortex formation should be not less than 2000, the boundary layer thickness will be equal to just

$$d = Re\chi/v = 2000 \cdot 3.5 \cdot 10^{-2} / 10^7 = 2 \cdot 10^{-8} \text{ m.} \quad (6.1)$$

Thus, within the jets of the aether, the width of which is counted by light-years, the mass formation of vortices is possible, which is observed.

In terms of ether density in the near-Earth space, one proton will consume ether corresponding to a cube with a side of $8 \cdot 10^{-6}$ m, but in the Galaxy nucleus, where the ether density is higher by at least 3-5 orders of magnitude, this cube can have a side of no more than 10^{-7} m. Thus, the conditions for the formation of protons are present. Thus, there are conditions for the formation of protons in the Galaxy nucleus.

In accordance with the ideas of ether dynamics, the proton is a toroidal helical vortex with compacted walls, the structure of which corresponds to some semblance of a tube, closed in the

ring. A vortex motion, once created in the medium, will promote the appearance of vortices in other regions of the medium of the same direction as the already created vortex. The same applies to helical motion. The vortices of one and some sign of helical motion created in the Galaxy nucleus will contribute to the fact that helical toroids of the same helical sign will be created in the whole space of the nucleus - either only right-handed or only left-handed, which sign is to be found out in the future. But the same applies to the whole Universe. Therefore, within the Universe there can hardly exist regions based on the so-called "antimatter", i.e., based on antiprotons. Such antiprotons can be created only artificially.

Although the general shape of the proton is close to the globular shape, it is not. Therefore, the proton cannot have complete symmetry of either electric or magnetic fields; their symmetry is possible only with respect to the axis passing through the center of the proton.

Fig. 6.1 presents the proton structure and gives the density and toroidal and annular velocity profiles.

From such a representation immediately follows the presence in the proton of a core - the walls of the tube located in the center of the proton, and also a small axial hole inside the proton. Inside the tube, as a result of the action of centrifugal force, the pressure of the ether must be lowered in comparison with the external pressure of the ether, although the density of the ether may be higher if the temperature of the ether inside the proton is lower than the temperature of the external medium. This assumption is led by the consideration that the external walls of the proton should also have a decreased temperature relative to the external aether due to the presence of a gradient current on its surface.

Since the flow cross section in the center of the proton body has for toroidal flow a substantially smaller area than the flow cross section in the outer walls of the proton, the flow velocity in the center will be substantially greater than in the outer walls. Inertial forces will force the proton body to stretch in the center along the axis, and a vortex must form on the opposite side due to the increasing velocity. In general, this will lead to the fact that the shape of the proton will resemble the shape of the dome ("popplet") of an Orthodox church.

The transition of the aether flow from the inner part of the toroid to the outer walls is accompanied by a decrease of the flow velocity in the toroidal direction. But the flow has nowhere to give up its energy of motion, because the external aether surrounding the proton has a low density. This means that the aether flow as it leaves the central part is forced to

change its direction of motion while keeping the total velocity value: the toroidal direction is transformed into a circular direction around the main axis of the proton. As a result, a helical motion is formed in the outer walls of the proton - simultaneous existence of toroidal and circular (around the main axis of the toroid) motions.

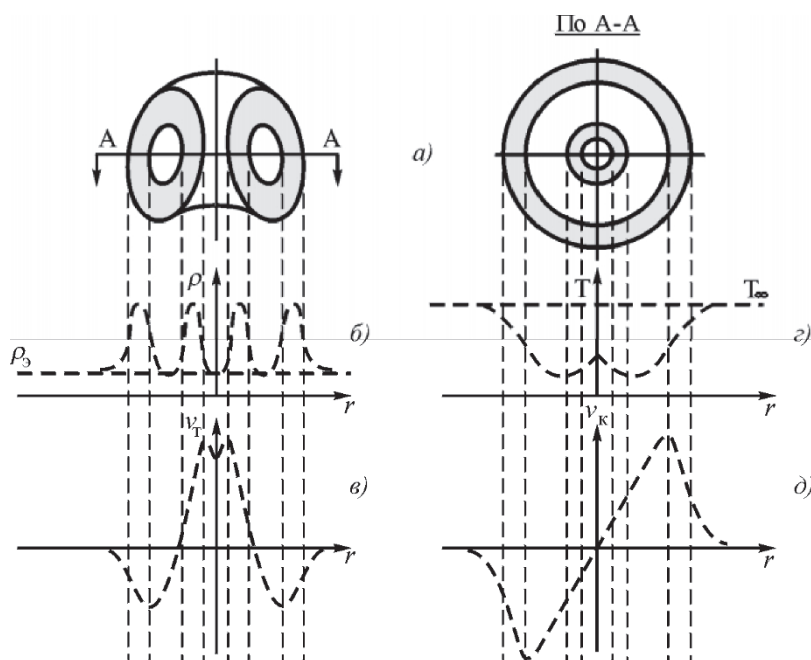

Fig. 6.1. Proton structure: (a) cross section; (b) density epuray; (c) temperature epuray; (d) tangential flow velocity epuray; (e) annular flow velocity epuray

A toroidal helical vortex blows a helical aether flow out of its middle - the central channel. In the center of the proton the aether flow has practically no velocity gradient, but it is compressed, and this means that the temperature of the aether in this place and viscosity are increased, they have a good adhesion with the body of the proton itself, and therefore the proton works as an engine, distilling through itself the surrounding aether. The translational motion of this flow is transformed into a toroidal motion of the aether around the body of the proton. This motion in the space external to the proton is subject to the law of Bio-

Savar, i.e. by the same law as the magnetic field of the proton, its velocity decreases inversely proportional to the cube of the distance.

Decreasing speed of the circular motion of the aether flows eroded by toroidal motion is proportional to the square of the distance.

In toroidal motion, one volume of gas engages another due to the pressure directly on it, while in annular motion neighboring layers are captured due to the viscosity of the aether. This leads to the fact that toroidal motion will cover the entire surrounding space, while annular motion can have two states - covering the surrounding space or localized within some boundary layer in which viscosity and temperature are significantly reduced due to the large value of the velocity gradient.

Since, as it will be shown below, the toroidal motion of the ether is perceived as a magnetic field, this explains the fact that both the proton and the neutron, as well as all other elementary particles of matter possess a magnetic field and, consequently, a magnetic moment. The circular motion of the ether is perceived as an electric field. When the circular motion is localized within the boundary layer, the particle is perceived as electrically neutral.

Let us define some parameters of the proton.

The proton body radius can be found from the value of the effective radius of the nucleus determined by the relation [27]:

$$R = aA^{1/3}, a = 1.12 \text{ f.} \quad (6.2)$$

The effective radius is determined from the processes of interaction of hadrons (nucleons, mesons, alpha particles, etc.) with the nuclei and can be somewhat larger, from 1.2 f to 1.4 f. For further calculations, $r_p = a = 1.12 \text{ f} = 1.12 \cdot 10^{-15} \text{ m}$, since the difference can be attributed in complex nuclei due to the thickness of the inter-nucleon layer.

The volume of the proton body in the first approximation can be defined as the volume of a ball having a radius of 1.12 f:

$$V_p = \frac{4}{3} \pi r_p^3 = 5.9 \cdot 10^{-45} \text{ m}^3 \quad (6.3)$$

The mass of the proton is known to be [Jaworski] $m_p = 1.67 \cdot 10^{-27}$ kg.

The average proton density will be determined from the relation:

$$\rho_p = m_p / V_p = 1.67 \cdot 10^{-27} / 5.9 \cdot 10^{-45} = 2.8 \cdot 10^{17} \text{ kg/m}^3 \quad (6.4)$$

Since the walls of the proton must be compacted to a critical value, it can be argued that this density is the same both at the center of the toroid and at its surface. In all cross sections of the proton, the ratio must be observed:

$$v S_{\text{tr}} = \text{const}, \quad (6.5)$$

where v_t is the velocity of the toroidal flow; S_t is the total cross-sectional area of the toroidal flow of the aether in the proton, and it is not defined with respect to each of the coefficients. However, near the center, the cross-sectional area for the flow is much smaller than near the surface, so the velocity of the aether jets near the center must be substantially greater than near its edges. A rigorous calculation here is difficult.

The proton's proximity to a spherical shape allows us to make an estimated calculation of the aetheric velocity on the proton's surface.

The value of the toroidal velocity at the proton surface can be attempted to be found from the value of the proton's magnetic moment.

The physical essence of the proton's magnetic moment is defined as the maximum value of the real mechanical moment acting on a particle caught in an external strong magnetic field, i.e., in the aether flux (Fig. 6.2).

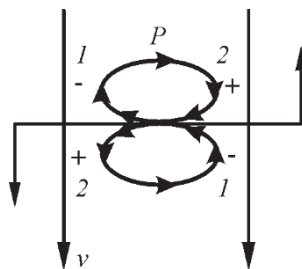

Fig. 6.2. Occurrence of rotational momentum when a proton enters the laminar flow of ether: 1 - low-pressure zone; 2 - high-pressure zone

On the section of the proton surface where the directions of the external flow and the flow on the proton surface coincide, the pressure drop will be:

$$\Delta P_1 = \rho_3 (v_{\text{n}} - v_{\text{T}})^2 \cos^2 \alpha / 2 \quad (6.6)$$

Here α is the angle between the direction of the external flux and the direction of toroidal motion of the aether on the proton surface.

At the same section located on the opposite side of the proton, the pressure drop will be:

$$\Delta P_2 = \rho_3 (v_{\text{n}} + v_{\text{T}})^2 \cos^2 \alpha / 2. \quad (6.7)$$

And the proton will be acted upon by the momentum determined by the difference of these pressure drops:

$$\Delta P = \Delta P_2 - \Delta P_1 = 2\rho_3 v_{\text{n}} v_{\text{T}} \cos^2 \alpha. \quad (6.8)$$

This pressure difference over the entire surface of the proton will create a mechanical torque that unfolds the proton so that the ether flows on the outer sides of the proton are antiparallel to the direction of the external flow.

Keeping in mind that the interaction of toroidal motion with the external flow occurs in the transverse direction due to viscosity at the speed of light, $v_{\text{n}} = c = 3 \cdot 10^8$ m/s should be substituted into the expression as the velocity of the impinging flow. Then for the magnetic moment the following expression is valid

$$\mu_p = k\pi\rho_3 sv S r_{\text{Tpp}} = k\rho_3 sv V_{\text{Tp}}, \quad (6.9)$$

where k' is a coefficient that takes into account the shape of the proton and the directions of angles of surface areas relative to the colliding aether flow; ρ is the density of the aether in free space, c is the speed of light; v_{T} is the velocity of the aether flow on the surface of the proton near its equator; S_p , r_p , V_p are the surface area, radius, and volume of the proton, respectively.

Thus, the *physical essence of the proton's magnetic moment is the mechanical moment that will be experienced by a proton whose axis is located perpendicular to the direction of an incoming stream of aether traveling at the speed of light.*

The velocity of toroidal motion of the ether on the surface of the proton is easiest to find from the concepts of the equivalent circular current.

The magnetic moment of the proton is $2.79\mu_N$, where μ_N is the nuclear magneton equal to $5.05 \cdot 10^{-27} \text{ J} \cdot \text{T}^{-1}$, i.e. $\mu_p = 1.41 \cdot 10^{-26} \text{ J} \cdot \text{T}^{-1}$.

As is known, the magnetic moment of a proton can be defined as the magnetic moment of some circular current i flowing in a closed loop whose area is equal to S :

$$M = iS. \quad (6.10)$$

From the ether-dynamic model of the proton, it is clear that the diameter of such a loop is approximately equal to the radius of the proton. From the total current law, it follows that the magnetic field strength is the value

$$H = \frac{i}{2\pi r}, \quad (6.11)$$

where $r = r_p/2$. Thus, we obtain for the proton

$$H = \frac{\mu_p}{2\pi r_p S} = \frac{1.41 \cdot 10^{-26}}{\pi^2 \cdot 1.12^3 \cdot 10^{-45}} = \dots = \dots$$

As will be shown in Chapter 8, the magnetic field is physically an ether flux, and the magnetic field strength corresponds to the ether flux velocity in the magnetic force line structure. A value of 1 A/m corresponds to a flux velocity of 376.65 m/s. Consequently, the velocity of the ether flux on the proton surface will be equal to

$$v_T = 376.65 \cdot 10^{18} = 3.76 \cdot 10^{20} \text{ m/s.}$$

Of course, the whole calculation is very approximate.

Physical essence of the electric charge of the proton. **The** proton is a rotating toroid of spherical shape with radius r_p creates a rotational field in the vicinity. Toroidal motion blurs the rotating layer, so the velocity of the circular motion of the medium at a distance r from the center of the ball will be

$$v_k = v_{ko} (r_p/r)^2. \quad (6.13)$$

The energy of the velocity field at constant aether density is

$$w_k = \int_{V_p} \frac{\rho v_{\text{эк}}^2}{2} dV = \int_{r_p}^{\infty} \frac{\rho v_{\text{эко}}^2 r_p}{2} 4\pi r^2 dr = 2\pi\rho v_{\text{эко}}^2 r_p^3, \quad (6.14)$$

where ρ_3 is the density of the medium, $\text{kg}\cdot\text{m}^{-3}$; v_k is the velocity of the medium at the proton's equator, m/s ; r_p is the proton's radius, m ; w_k is the energy, J .

For the electric charge q of a proton, the energy is

$$w_q = \int_{V_p} \frac{\epsilon_0 \epsilon E^2}{2} dV; E = \frac{q}{4\pi\epsilon_0 \epsilon r^2}; \quad (6.15)$$

And, thus,

$$w_q = \frac{\epsilon_0 \epsilon}{2} \int_{r_p}^{\infty} \frac{q^2 4\pi r^2 dr}{16\pi \epsilon_0 \epsilon r^4} = \frac{q^2}{8\pi \epsilon_0 \epsilon r_p} \quad (6.16)$$

Here q - charge, C ; ϵ_0 - electric constant of vacuum, F/m ; ϵ - relative permittivity.

Comparing the expressions for the mechanical energy of the annular velocity field of the medium and the electric energy of the electric charge field of the proton, we have

$$w_k = w_q; \quad (6.17)$$

$$2\pi\rho v_{\text{эко}}^2 r_p^3 = \frac{q^2}{8\pi \epsilon_0 \epsilon r_p}, \quad (6.18)$$

whence we find

$$\rho_3 (v_{ko} S_p)^2 = \epsilon_0 \epsilon \left(\frac{q}{\epsilon_0 \epsilon} \right)^2, \quad (6.19)$$

where S_p is the surface area of the ball having a velocity on the circumference v_{ko} .

Thus, the quantities $\epsilon_0 \epsilon$ and q acquire a simple interpretation:

$$\epsilon_0 \epsilon, F/m = \rho_3, kg/m^3; q, Cl = \rho v_{ko} S_p, kg/s. \quad (6.20)$$

The dielectric permittivity is the density of the ether, with the unit [F/m] corresponding to the unit [kg/m³]. It follows from this that the mass density of the ether in vacuum is equal to $8.85 \cdot 10^{-12} kg/m^3$.

Physical essence electric charge proton - surface circulation of the aether density.

Since for the proton $r_p = 1.12 \cdot 10^{-15} m$, $q = 1.6 \cdot 10^{-19} Cl$, we obtain that the circumferential (circular) velocity of the proton boundary layer surface is equal to

$$v_{ko} = \frac{1.6 \cdot 10^{-19}}{4\pi \cdot 1.12^2 \cdot 10^{-30} \cdot 8.85 \cdot 10^{-12}} = 1.15 \cdot 10^{21} m \cdot s^{-1}. \quad (6.21)$$

The change in the direction of motion of the aether flow from toroidal to circular increases as the distance from the toroid axis increases, so in the first approximation the whole toroid rotates around its main axis almost like a solid body, i.e., the tangential velocity in the center of rotation is zero and further increases linearly proportional to the radius. In toroidal motion, however, there is the opposite situation: in the center of the proton, the velocity of the aether is much greater than at its periphery.

Taking into account the approximity of the calculation of the toroidal and annular velocities on the proton surface, it is reasonable to consider them equal for purely logical reasons, and the reliability of the calculation of the annular velocity is higher. Since the directions of the toroidal and annular velocities are perpendicular to each other, we can define the modulus of the aether flow velocity on the toroid surface as

$$v_p = \sqrt{2} \cdot 1.15 \cdot 10^{21} = 1.6 \cdot 10^{21} m/s.$$

Considering that on the inner walls of the proton the velocity of motion should be two orders of magnitude higher than on the outer side of the boundary layer, it should be considered close to the velocity of the first sound, i.e., of the order of 10^{23} m·s⁻¹ (the velocity of the first sound in the ether is $4.3 \cdot 10^{23}$ m·s⁻¹). The same order should be the velocity of the ether flow blown by the proton from the central hole.

Thus, within the thickness of the proton wall and its surface boundary layer, there is a velocity difference of the ether flows from $4.3 \cdot 10^{23}$ m/s inside the proton to $1.6 \cdot 10^{21}$ m/s at the surface of the boundary layer, i.e., almost 300 times. This velocity difference occurs at a distance not exceeding $2.51 \cdot 10^{-16}$ m, so the velocity gradient here is of the order of $1.3 \cdot 10^{39}$ m/s/m.

Such a large gradient leads to a sharp drop in the already small viscosity of the ether, which is an additional factor in ensuring high proton stability.

The relaxation time (spontaneous decay) of the proton as well as of any vortex is determined by the expression:

$$\tau = 0,36 \frac{r_p}{\chi_e} \left(\frac{\rho_p^k}{\rho_e} \right), \quad (6.22)$$

where ρ_p is the density of the ether on the proton surface; ρ_e is the density of the free ether. Presumably $k = 2$, but the validity of this assumption should be further substantiated additionally. If, nevertheless, the above statement is valid (taking into account the reduction of energy recoil at low density of the ambient ether compared to the density of the boundary layer on the proton surface, the temperature decrease in the boundary layer and the resulting viscosity decrease, as well as the factor of increasing the stability of the body at rapid displacement of the boundary relative to the environment), then

$$\tau = 0.36 \frac{1,12^2 \cdot 10^{-30}}{4 \cdot 10^9} \left(\frac{2,8 \cdot 10^{17}}{8,85 \cdot 10^{-12}} \right)^2 = 2,5 \cdot 10^{18} \text{ s} = 10^{14} \text{ years.}$$

The real value of the relaxation time, apparently, is smaller, since the relaxation process is a nonlinear process and the vortex energy loss increases with time due to the increase of its size, decrease of the boundary layer density, etc. Proceeding from

of the ideas about the formation and decay of protons in the spiral Galaxy - this time, apparently, can be estimated as 10 - 20 billion years. This coincides with the proton decay time established experimentally by known techniques, but it should be noted at once that these techniques are based on incorrect ideas and therefore cannot be taken into account.

The number of amers in a unit volume of a proton will be

$$n_p = n_a \rho_p / \rho_e = 5.8 \cdot 10^{102} - 2.8 \cdot 10^{17} / 8.85 \cdot 10^{-12} = 1.8 \cdot 10^{131}, \quad (6.23)$$

where n_a is the number of amers in a unit volume of free ether in near-Earth space, ρ_p is the average proton density equal to $2.8 \cdot 10 \text{ kg/m}^3$, ρ_e is the density of ether in near-Earth space.

Average free path length of an amer in the proton body

$$\lambda_p = \frac{\sqrt{2}}{1} n_h \sigma_a = \frac{\sqrt{2}}{1} - 1.8 \cdot 10^{131} 1.66 \cdot 10^{-89} = 2.3 \cdot 10^{-41} \text{ m}. \quad (6.24)$$

The temperature of the nucleon body can be found from the approximate equality of pressures on its surface (with neglecting centrifugal pressure):

$$T_H = T_3 \rho_3 / \rho_H = 10^{-46} - 8.85 \cdot 10^{-12} / 2.8 \cdot 10^{17} = 3.1 \cdot 10^{-75} \text{ K}. \quad (6.25)$$

Average velocity of thermal motion of an amer in the nucleon body will be:

$$u_H = u_3 \sqrt{\rho_3 / \rho_H} = 5.4 \cdot 10^{23} \sqrt{8.85 \cdot 10^{-12} / 2.8 \cdot 10^{17}} = 3 \cdot 10^9 \text{ m} \cdot \text{s}^{-1}. \quad (6.26)$$

Number of collisions of each amer in the nucleon body

$$\nu_p = u_p / \lambda_p = 3 \cdot 10^9 / 2.3 \cdot 10^{-41} = 1.3 \cdot 10^{50} \text{ s}^{-1}. \quad (6.27)$$

6.3. Physical essence strong nuclear and electromagnetic interactions of protons

Interaction of any material structures - particles of matter and force fields can be realized only if they create pressure gradients in the ether. Then the body, caught in

a non-uniformly distributed pressure field created by another body begins to be affected by that body through this pressure gradient.

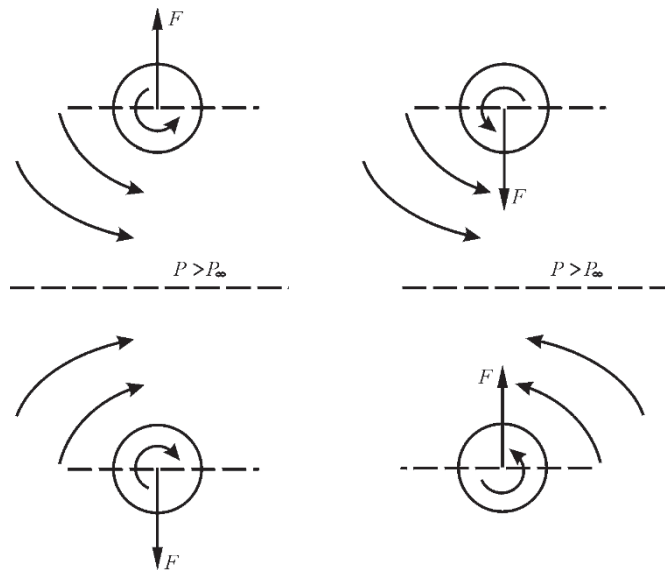

Figure 6.3. Interaction of two cylindrical gas vortices:
a - rotating in opposite directions; *b* - rotating in the same direction

If two parallel rotating cylinders are located close to each other, the interaction of the cylinders will be determined by their directions of rotation relative to each other (Fig. 6.3.) If a plane of symmetry is drawn between the cylinders, it is easy to see that the cylinders by their rotation should drive gas from free space into the region between the cylinder surface and this plane. Given that the gas has density and therefore inertia, in order for it to move accelerated in this gap, it must be compressed. This will cause the density of the gas in the gap between the cylinder and the plane of symmetry to be higher than the density of the gas in free space, this will increase its temperature and pressure, since it follows from the equation of state of the gas that

$$P = \frac{RT}{V}, \quad (6.28)$$

where R is the universal gas constant; T is the absolute temperature; V is the molar volume. As the volume decreases and the temperature increases, the pressure of the gas in the gap between the cylinder and the plane of symmetry will increase. The relative increment of pressure will be:

$$\Delta P_1 = P \left(\frac{\Delta T}{T} + \frac{\Delta V}{V} \right). \quad (6.29)$$

However, due to the velocity gradient, the pressure in the same gap will decrease by the value of

$$\Delta P_2 = -\frac{\rho v^2}{2}, \quad (6.30)$$

where v is the velocity of the cylinder wall. Consequently, in the gap between the cylinder and the plane of symmetry, the pressure change will be determined by the difference

$$\Delta P = \Delta P_1 - \Delta P_2. \quad (6.31)$$

The value of ΔP in this case will be negative, especially since in gradient flow the temperature always decreases. Consequently, the cylinders rotating in the same direction will tend to each other.

These cylinders or cylindrical gas vortices, in addition, are subject to drag forces due to the external gas flows they themselves create in the environment. This will cause them to rotate around each other. The acceleration they will acquire depends on the velocity of the flows, area and mass.

If the cylinders rotate in opposite directions, there will be no gradient flow in the gap between them, but simply accelerated gas flow. In this case $\Delta P_2 = 0$ and only the pressure increment ΔP_1 remains, the cylinders will be repelled from each other.

The attraction or repulsion of the cylinders will also be promoted by velocity gradients on the sides opposite to the plane

of symmetry. However, due to the fact that the flow velocities and, hence, velocity gradients are weaker here than on the side of the symmetry plane, the effect of pressure changes in this region will be significantly weaker than in the region between the cylinder and the symmetry plane.

It is of interest to consider the case of three cylinders rotating in one direction, of which two are close to each other and the third is a little away (Fig. 6.4). Since the two first cylinders create a common flow in the external space, the third cylinder will be attracted to them, but then it will run around them until it is in the recess between the cylinders, which is the real potential pit for it. If the forces associated with viscosity are insufficient to get out of this recess, the third cylinder will remain here.

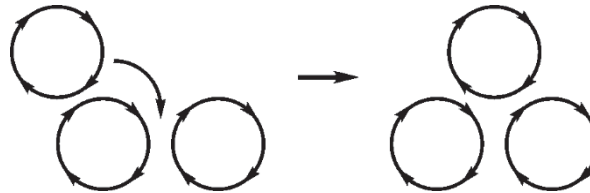

Figure 6.4. Interaction of three rotating cylinders.

In all cases, the source of energy for the motion of gas flows is the vortices themselves. The plane under consideration is the plane of symmetry located between the vortices. In both cases, each vortex drives gas from the external space into the gap between the vortices, compressing it and giving the flow additional energy. But in the first case the flow velocity gradient between vortices is large, while in the second case it is small, and therefore the interaction of vortices with gas flows and thus with each other is significantly different.

Based on the above, the mechanism of action of the strong nuclear (Figs. 6.5 and 6.6) and electromagnetic interaction can be considered.

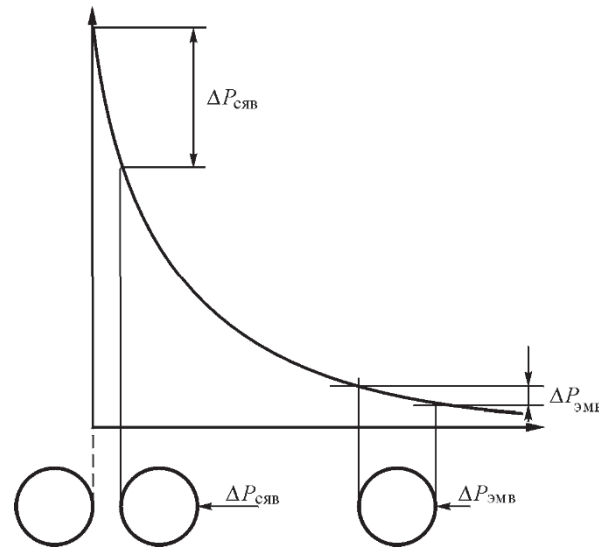

Figure 6.5. Interaction of matter particles through pressure gradients:
a - in case of close contact (strong nuclear interaction); *b* - in case of remote
 (electromagnetic) interaction.

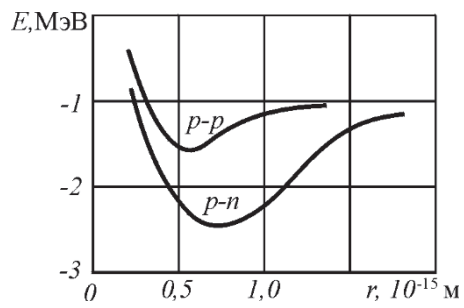

Fig. 6.6. Dependence of the interaction energy between nucleons (proton-proton and proton-neutron interactions) on the distance between them at antiparallel spins

The Bernoulli equations are usually used for such calculations. However, they assume only a mutual exchange of pressure energy and forward energy of the gas at the constancy of their sum. Therefore, these equations are unsuitable for

calculation of the above cases. The general gasdynamic problem of calculating vortex interactions taking into account changes in temperature, viscosity, and pressure is quite complicated. Nevertheless, certain considerations can be given here.

In the first case, in the absence of a velocity gradient, the gas pressure between the vortices increases due to gas compression as gas from free space is forced into the relatively narrow gap between the cylinders. The pressure increase will cause the vortices to repel each other.

In the second case, the gas is exactly the same way driven from free space into the same gap, which is clearly seen from the figure, but here there is a large velocity gradient, as a result of which the pressure in the gas falls significantly more than it rises due to gas compression. This occurs, in particular, because in the gradient gas flow the temperature decreases according to the law

$$\Delta T = - \Delta u^2 / 2c_p \quad (6.32)$$

where Δu is the velocity difference, c_p is the heat capacity of gas at constant pressure.

If vortices are at very close distance, for example, within the boundary layer, the main pressure difference will be created by the velocity difference in the intervortex zone, which will be $2v_b$ and then the pressure drop will be equal to

$$\Delta P \approx - 2\rho v_b^2, \quad (6.33)$$

and the pressing force of vortices against each other will be

$$\Delta F = S \Delta P. \quad (6.34)$$

Vortex interaction energy

$$W = \Delta P V, \quad (6.35)$$

where V is the volume of intervortex space.

Based on the above, we can determine the decrease of the aether pressure in the inter-nucleon space of atomic nuclei (strong nuclear interaction).

In accordance with expression (5.101) for the interaction of vortices located at a close distance from each other, i.e., in the zone of a large value of the velocity gradient, we have

$$\Delta P_{\text{я}} \approx -0.5\rho v_p^2. \quad (6.36)$$

Here v_p is the velocity of ether motion on the proton surface.

If we do not take into account the aether compression in the inter-nucleon space, then, substituting the numerical values, we obtain:

$$\Delta P_{\text{я}} \approx -0.5 \cdot 8.85 \cdot 10^{-12} \cdot 1.6^2 \cdot 10^{42} = 1.13 \cdot 10^{31} \text{ Pa.}$$

Taking into account the compression of the ether, this value should be somewhat larger.

As is known, the binding energy of nucleons in the deuterium nucleus is 2.27 MeV or, the same thing, $3.6 \cdot 10^{-13}$ J. In the alpha particle, the binding energy per nucleon is 7.6 MeV, but there is only 3.8 MeV, or $6 \cdot 10^{-13}$ J, per conjugation surface.

Fig. 6.6 shows the dependence of the energy and, respectively, the forces between the nucleons.

Taking into account that the radius of the nucleon in the nucleus is somewhat larger than the previously accepted value due to the deformation of the nucleon due to the pressing of nucleons against each other, we assume a radius of $1.2 \cdot 10^{-15}$ m and a cross-sectional area of $4.5 \cdot 10^{-30}$ m² with the value of the inter-nucleon gap $\delta = 0.1f = 10^{-16}$ m we have the pressure drop in the inter-nucleon gap for the first case

$$\Delta P_{\text{я}} = \frac{w_{\text{CB}}}{S_{\text{H}} \delta} = \frac{3,6 \cdot 10^{-13}}{4,5 \cdot 10^{-30} \cdot 10^{-16}} = 8 \cdot 10^{32} \text{ Pa}, \quad (6.37)$$

and in the second case

$$\Delta P_{\text{я}} = \frac{w_{\text{CB}}}{S_{\text{H}} \delta} = \frac{3,8 \cdot 10^{-13}}{4,5 \cdot 10^{-30} \cdot 10^{-16}} = 8,4 \cdot 10^{32} \text{ Pa}. \quad (6.38)$$

Thus, the calculations carried out by formula (6.38) are in good agreement with the experimental data and in good agreement with the value of pressure in free ether, which is $1.3 \cdot 10^{36}$ Pa.

This decrease of pressure in the inter-nucleon gap is compensated by the increase of density of ether in the inter-nucleon layer and makes only a small fraction of pressure of ether in free space, namely for the first case

$$\delta P_{\text{я}} = 8 \cdot 10^{32} / 1.3 \cdot 10^{36} = 6.15 \cdot 10^{-4} = 0.0615\%.$$

For the second case

$$\delta P_{\text{я}} = 8.4 \cdot 10^{32} / 1.3 \cdot 10^{36} = 6.46 \cdot 10^{-4} = 0.0646\%.$$

As a result of the interaction of two identical vortices through a common gas medium, the external pressure will press them against each other, and this will happen the more strongly, the smaller is the size of the gap between them, since the velocity gradient will increase. Convergence will occur until the secondary factors preventing further pressure reduction, such as the gap commensurability with the free path length of molecules, etc., come into effect.

If the protons are at a distance exceeding at least a few proton radii, they fall into the zone of a reduced velocity gradient (electromagnetic interactions). In this case, the pressure differences generating the forces on the surface of protons will be determined by expression (5.110)

$$\Delta P_{\text{эм}} = - 2\rho_{\text{э}} e v v_{p1p2}. \quad (6.39)$$

According to the Bio-Savar law, the toroidal motion created by one of the protons in the free ether decreases proportionally to the cube of the distance. If the second proton has got into this velocity field, the moment of forces acting on it from the side of the aether flow starts to act on it, turning it in the direction antiparallel to the flow of forces (Fig. 6.7). This happens due to the fact that only such a position is stable, since the maximum of the velocity gradient and, consequently, the minimum of the aether pressure are established along the entire periphery of the second proton.

However, if the flow washing the second proton is not purely laminar but helical, i.e., in addition to the toroidal flow, there is also a circular motion of the ether created by the same proton, then after turning, a gradient of the circular velocity is established on the surface of the second proton, decreased on the side of the first proton and increased on the opposite side. The protons will repel, which is the essence of the electromagnetic interaction. If one of them had the orientation of helical motion, i.e., the orientation of annular motion relative to toroidal motion is opposite, an increased flow velocity gradient would be created between the toroids, the pressure of the Ether between them would be reduced, and they would become attracted (Fig. 6.7).

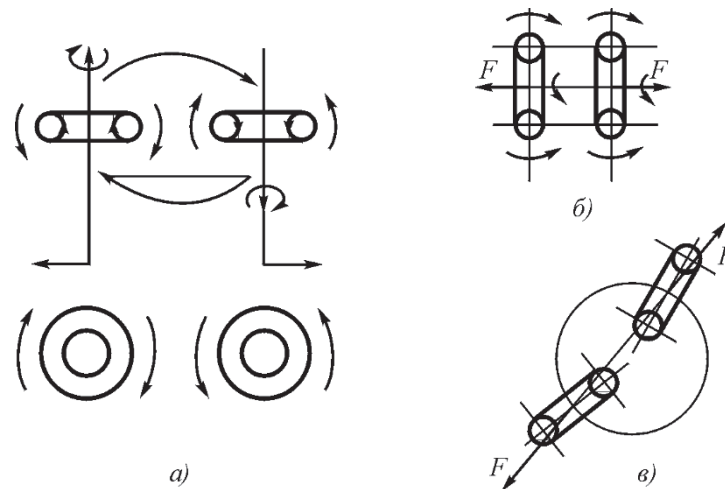

Fig. 6.7. Remote (electromagnetic) interaction of toroidal helical vortices: *a* - when they are in a common plane; *b* - at coaxial position; *c* - in general case

Since the annular velocity decreases in proportion to the square of the distance:

$$v_k = \frac{bH_k}{4\pi r^2}, \quad (6.40)$$

where b is the thickness of the toroid; G_k is the circulation of circular motion along the equator of the toroid, then the force acting on attraction and repulsion of the toroids will be proportional to the product of thicknesses and circulations of both toroids and inversely proportional to the square of distances between their centers:

$$F_k = \frac{b_1 G_{k1} b_2 G_{k2}}{4\pi r^2}, \quad (6.41)$$

which corresponds to Coulomb's law.

Comparing the interaction of toroidal vortex helical rings with the behavior of charged particles, the following conclusions can be drawn.

1. Since orientation of particles is determined by toroidal motion, then magnetic momentum of the particles is identified with the toroidal motion of the ether on its surface and is defined as the product of the values of the density of the ether in the surrounding space ρ_e , the speed of light c , the speed of toroidal motion at the equator of the proton surface v_t and the volume of the proton V_p :

$$\mu_p = k\pi\rho_e v_t S r_{pp} = k\rho_e v_t V_p,$$

2. The electric charge is a manifestation of the circular motion of ether flows on the surface of the proton. The value of the electric charge of the particle represents the circulation of the ether density on the surface of the boundary layer and is as follows

$$q, \text{ Cl} = \rho_e \tilde{a} v_{\kappa_0} S_p, \text{ kg/s}, \quad (6.42)$$

3. Since the fact of attraction or repulsion is determined by the orientation of the annular rotation relative to the toroidal one, the polarity of the charge should be identified with the orientation of the annular motion relative to the toroidal one (i.e. with the sign of the helical motion).

4. Since the strong nuclear interaction in the atomic nucleus occurs between nucleons touching their boundary layers, the physical essence of the strong nuclear interaction should be considered to be the pressing of nucleons against each other by the external pressure of the ether due to a drop of the ether pressure in the inter-nucleon boundary layer as a result of a significant velocity gradient within this boundary layer.

5. The essence of the electromagnetic interaction of protons is the mutual change of aether pressures on the surfaces of nucleons, produced by them remotely.

6. The strong nuclear and electromagnetic interactions are based on a common ether-dynamic mechanism and differ only in the magnitude of the ether pressure decreases arising on the surfaces of nucleons due to differences in the velocity gradients of ether flows in the space between nucleons.

6.4. Formation and structure neutron

C in view of stated may may be considered the mechanism of neutron formation in the nucleus (Fig. 6.8).

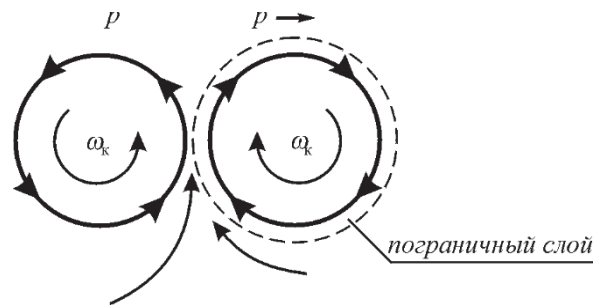

Figure 6.8. Interaction of protons and mechanism of neutron formation

If the proton convergence velocities in the gas are such that they are able to overcome the electric repulsion forces, the two protons will unfold antiparallel, since an extremely high ring velocity gradient is formed at their periphery. The stability of the toroidal flow on the surface of the proton will be exceptionally high, because the toroidal flow of the aether is created not so much by the surface as by the inner aperture of the proton, where the coupling of the aether flow with the body of the proton is high because of the high density and high temperature of the blown aether. The stability of the annular flow is not high because the annular flow on the proton surface is created only by its surface due to viscosity in the aether layers. The temperature of the ether here is low, the velocity gradient is relatively high, hence, the viscosity is low.

If two protons contact each other within the boundary layer, the toroidal fluxes will weakly influence each other. The annular flux of one proton within this boundary layer will be in a competitive situation with respect to the annular flux of the second proton. The situation will be unstable, one of the flows will be slowed down. This will lead to the fact that the velocity gradient of the annular motion at the braked flow will start to increase and the viscosity will fall. As a result, the entire annular motion

will be confined within this boundary layer. The proton will turn into a neutron.

The fact that neutrons can be formed only inside the nucleus is confirmed by the fact that in the free state neutrons cannot exist for any length of time: they spontaneously transform into a proton. It is believed that in this case an electron is also formed, but in fact this is not necessarily the case, since it is more likely that the neutron boundary layer is simply transformed into a proton boundary layer without any electron being born. This happens because in the neutron freed from the atomic nucleus nothing more prevents the restoration of its usual circular motion, but it takes some time (up to 16 min.).

In the boundary layer formed at the neutron, the annular motion is completely closed, so the neutron is perceived as an electrically neutral particle. But due to this boundary layer, in which the viscosity is reduced, the toroidal motion is redistributed and weakened in the outer space. Practice confirms this, since the proton has a magnetic moment of 2.79 nuclear magnetons, while the neutron has only 1.91 nuclear magnetons.

The neutron's mass of $1.67482 \cdot 10^{-27}$ kg is greater than the proton's mass of $1.67252 \cdot 10^{-27}$ kg by an amount of $0.0023 \cdot 10^{-27}$ kg. This can be easily explained by the fact that the ether included in the boundary layer of the neutron is taken into account in its mass, while the ether moving around the proton, whose motion is perceived as the electromagnetic field of the proton, is not taken into account in the mass of the proton.

6.5. Models of atomic nuclei

6.5.1. Basic etherodynamic principles of structural organization of atomic nuclei

There are various models of atomic nuclei [9-23] that describe more or less precisely the parameters of nuclei, including the interaction energies of nucleons, magnetic moment values, etc. The disadvantages of these models are their phenomenological character, the actual absence of structural representations, and the lack of ideas about the nature of intranuclear interactions.

Aether dynamical representations allow us to find the structure of atomic nuclei and to understand the nature of nuclear forces. In this case, the known values of the interaction energy of nucleons E , the values of spin I^π ,

magnetic moment, parity, and deformation coefficient [25-27] allow us to find simple principles for constructing the structures of atomic nuclei of the basic elements and their isotopes. The detailed development of the structures of nuclei can also be performed on this basis.

A group of hydrogen-helium nuclei.

The simplest composite nucleus is the deuteron, the nucleus of a heavy hydrogen atom with atomic weight 2, which consists of a proton and a neutron. The addition of another neutron to the deuteron gives the triton, the nucleus of tritium, a heavy hydrogen atom with atomic weight 3; the addition of a second proton to the deuteron gives the nucleus of the isotope helium-3; the union of two deuterons gives the nucleus of helium-4, otherwise known as the alpha particle. Table 6.1 gives some parameters of the listed nuclei; Fig. 6.9 shows their structures. 6.9 shows their structures.

Table 6.1.

Canticle, core	Composit ion		μ/μ_n	E , MeV
p	p	1/2	$2,792743 \pm 0$	-
n	n	1/2	$-1,913139 \pm 45$	-
^2_1D	$p + n$	1	$0,8574073 \pm 2$	2,27463
^3_1T	$p + 2n$	1/2	$2,97884 \pm 1$	8,48212
^3_2He	$2p + n$	1/2	$2,127544 \pm 7$	7,71828
^4_2He	$2p + 2n$	0	0,000	28,29624

The stable state of a vortex system takes place under the condition of the minimum of the internal energy of the system or the maximum of the interaction energy, for which it is necessary to close the toroidal (central) flows of the ether in such a way that this flow has the least resistance in the medium. The latter is possible only if the nucleons form a common flow, and, as has been shown above, in the deuteron the nucleons will be connected with each other by side surfaces. Since the central flux of the proton is larger than that of the neutron, the resulting part of the toroidal flux escapes into the external medium, which is perceived by the

as a magnetic field of the deuteron, and the annular motion of the proton goes to the external space entirely, which is perceived as an electric field of both the proton itself and the deuteron as a whole.

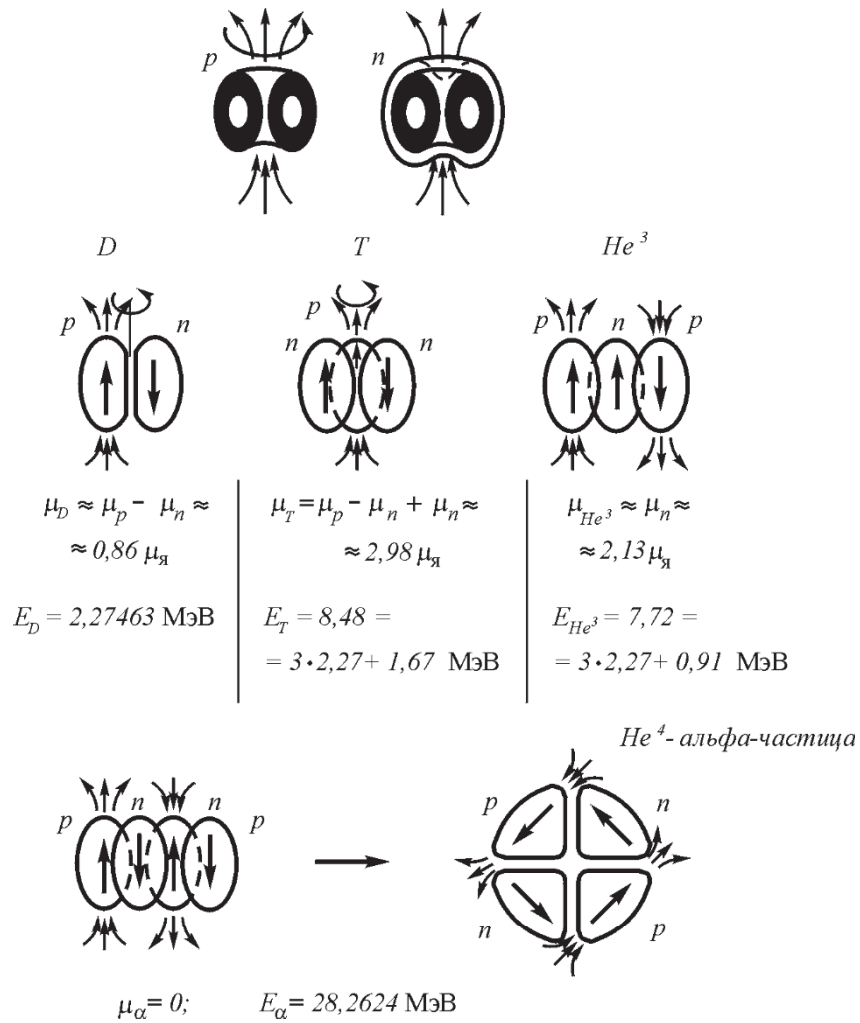

Fig. 6.9. Structure of proton (a), neutron (b), deuteron (c), triton (d), helium-3 nuclei (e) and helium-4 nuclei - alpha particle (f)

The connection of nucleons with each other by their lateral surfaces in the presence of a common central flux makes them oriented antiparallel to each other. In this case, the directions of toroidal motion along the constituents of both nucleons are mutually opposite, i.e., the velocity gradient of toroidal motion is maximal, and the presence of annular motion in the proton further increases this gradient. All this leads to a pressure decrease in the zone intermediate between the nucleons. The external pressure of the ether presses the nucleons against each other.

It is easy to see that at antiparallel orientation of two nucleons, the sum of their eigenspins (angular momenta) is zero. But the annular motion of the proton leads to the rotation of the whole system around a common axis passing through the intermediate zone parallel to the principal axes of both toroids. Since the nucleon has a tubular structure, the centers of mass of the nucleons are located at the same distance from the axis of rotation as the main mass of a single nucleon, and since the total mass in the deuteron is doubled, the total amount of motion is also doubled, i.e., the spin of the deuteron is equal to

$$I = 2 I_H = 1, \quad (6.43)$$

The magnetic moment of the deuteron is known to be equal to

$$\mu_D = 0.86\mu_n \approx \mu_p + \mu_n = 2.792743 \mu_n - 1.913139 \mu_n = 0.879604 \mu_n, \quad (6.44)$$

where μ_n is the nuclear magneton. The 2% difference can be attributed to the absorption of a part of the toroidal motion in the inter-nucleon zone.

When a second neutron is attached to the deuteron, a triton, a tritium nucleus, is formed. Its magnetic moment is approximately equal to the magnetic moment of the proton, since the two neutrons are oriented antiparallel in the nucleus and their magnetic moments are mutually compensated:

$$\mu_T = 2.9797 \mu_n \approx \mu_p = 2.792743 \mu_n. \quad (6.45)$$

Here, some excess of the magnetic moment (about 8%) can be attributed to the incomplete subtraction of the magnetic moments of the two neutrons included in the triton nucleus. The internal spin of the triton is equal to

$\frac{1}{2}$, which is natural, since at antiparallel orientation of neutrons their internal spins are compensated and only the spin of the proton remains.

The interaction energy of the triton is about 8.48 MeV, the number of interaction surfaces of nucleons with each other is 3. The excess of the interaction energy, if compared with the interaction energy of three deuterons of 2.27463 MeV each, is as follows

$$\Delta E = 8.48212 - 3 \cdot 2.27463 = 1.65823 \text{ MeV.} \quad (6.46)$$

The additional energy of bonds can be explained by additional deformation of vortices and increase of interaction areas, since here each nucleon interacts with its neighbors not on one surface, as in the deuteron, but on two, and the reduced pressure in the inter-nucleon space leads to deformation of nucleons.

The magnetic moment of helium-3 is $2.1275 \mu_n$, which approximately corresponds to the magnetic moment of the proton ($2.79 \mu_n$). The 23% difference can be attributed to the damping of the toroidal motion of protons in the inter-nucleon layer. The binding energy of the nucleons in the helium-3 nucleus is 7.72 MeV, and the excess of the interaction energy in comparison with three deuterium nuclei is 7.72 MeV

$$\Delta E = 7.72 - 3 \cdot 2.27463 = 0.91 \text{ MeV.} \quad (6.47)$$

This excess is smaller than in the case of the triton, but it is easily explained by the fact that at antiparallel coupling of two protons in the gap between them the flows of the ring motion of the aether appear parallel, so the binding energy in this interproton gap is smaller.

The addition of a fourth nucleon could cause an increase in the total interaction energy of nucleons in the nucleus by 3 MeV. Instead, however, the energy jumps to 28.29614 MeV, i.e., almost 18 MeV more than expected. Such a jump can be explained only by a rearrangement of the structure of the entire system of nucleons forming the alpha particle.

It is easy to see that such a rearrangement is in fact really necessary, since the presence of four nucleons creates all possibilities for the least resistance to the passage of the central flows, since now a single flow for all four nucleons can be formed, passing along the common ring formed by the vortices of the nucleons. In addition, a counter flow of aether is formed across the surface of the four nucleons, further binding the nucleons together. Inside the alpha particle, another flow should be formed, but due to its small diameter, its contribution to the binding energy is small (Fig. 6.10, e)

The spin directions in the system are all pairwise balanced and the total momentum of the alpha particle is zero.

Thus, the increased stability of the even-even system, which is the alpha particle, is easily explained. Taking into account the special stability of alpha-particles, further consideration of the structures of all nuclei, and especially stable nuclei possessing the so-called "magic" number of neutrons, it is reasonable to consider on the basis of alpha particles. The resulting model of atomic nuclei can be called the alpha-particle model.

6.5.2. Some general properties of composite nuclei

The analysis of nucleon interaction energies for nuclei [25-27] shows that it is possible to identify several general properties for all types of isotopes, which can be used in the construction of alpha partial models of these nuclei. Let us consider some of these properties (Tables 6.2, 6.3).

Table 6.2.

number neutrons	Isotope	I^π	E , MeV	ΔE , MeV
3	${}^8_5\text{B}$	2	37,74	-
4	${}^9_5\text{B}$	-	56,315	18,6
5	${}^{10}_5\text{B}$	3+	64,75	8,44
6	${}^{11}_5\text{B}$	3/2-	76,21	11,45
7	${}^{12}_5\text{B}$	1+	79,58	3,37
8	${}^{13}_5\text{B}$	3/2-	84,46	4,9

Table 6.3.

number neutrons	Isotope	I^π	E , MeV	ΔE , MeV
3	${}^9_6\text{C}$	-	39,04	-
4	${}^{10}_6\text{C}$	0+	60,32	21,3
5	${}^{11}_6\text{C}$	3/2-	73,44	13,12
6	${}^{12}_6\text{C}$	0+	92,16	18,72
7	${}^{13}_6\text{C}$	1/2	97,11	4,96
8	${}^{14}_6\text{C}$	0+	105,29	8,18

First, for the whole set of isotopes, the addition of an even neutron to the bonding energy is characterized by a larger value than the addition of an odd neutron. This is characteristic of elements with both even and odd numbers of protons. In Table.

6.2 and 6.3 give data on the energies of boron and carbon isotopes for example. The isotopes are arranged in the order of increasing number of neutrons contained in them. This property is characteristic of all isotopes of all elements without exception.

Second, in all even-even nuclei up to ${}^{60}_{30}\text{Zn}$ can be carried out

a clear boundary in the binding energy values between relatively large energy increments by the addition of new neutrons with energies around 13 MeV and relatively small binding energy increments of the order of 6-7 MeV or less. This energy jump always separates even-even nuclei, i.e., nuclei that can be envisioned as consisting of only alpha particles, from the rest of the nuclei:

4 8 12 16 20 24 28 32 36 40 44 48 52 56 60
 He, Be, C, O, Ne, Mg, Si, S, Ar, Ca, Ti, Cr, Cr, Fe, Ni, Zn
 2 4 6 8 10 12 14 16 18 20 22 24 26 28 30

In odd-even nuclei such boundary can also be drawn, but in them the energy jump is smaller.

This distribution of binding energy means that all the structures of nuclei can be viewed on the basis of alpha particles, with even-even nuclei as consisting of alpha particles alone and the rest as consisting of alpha particles and other nucleons forming compounds with each other.

The spin value, known practically for the nuclei of all isotopes, is always zero for even-even structures, which confirms the above assumption. The spin value for the other structures allows us to visualize in each case the structure of the nucleus, in which the alpha structure is still the basis.

In the comparative table of energies (Table 6.4) the energies of even-even nuclei and the results of their comparison with the internal binding energy of the corresponding number of alpha particles are given. In the same table are given the first and second differences of energy increments and ordinal numbers (k) of even-even nuclei in the series of their isotopes, counting from the isotope with the lowest A value. *The* last column contains the number of neutrons Δn , which distinguishes the isotope listed in the table from the most common isotope in nature, i.e., the most stable one. The changes in the second increment of the bonding energy indicate the reorganization of the structure of nuclei during the transition to a new value of the Z number. As can be seen, the nuclei with magic numbers 2, 8, 20, and 28 complete the structure of the nuclei.

a series of identical structures. The structure is also completed by the Be nucleus,

which is unstable, since its binding energy is less than the corresponding energy of the two particles. This case can be explained by the fact that at all positions of two alpha particles relative to each other the resistance to the ether flow leaving the centers of the alpha particles is sufficiently large, while the surfaces of the nucleons included in the alpha particles are convex and do not provide a sufficient basis for a high-energy coupling. However, the addition of one more nucleon - proton or neutron - immediately makes the isotope stable (Fig. 6.10), since this nucleon turns out to be a bridge connecting the two alpha particles.

Vv

Table 6.4.

NaEa	$\begin{matrix} A \\ X \\ Z \end{matrix}$	k	Ea, MeV	ΔE , MeV	$\Delta^2 E$, MeV	Δn
28,29624	$\begin{matrix} 4 \\ \text{He} \\ 2 \end{matrix}$	2	28,29624	0	-	-
56,59248	$\begin{matrix} 8 \\ \text{Be}^* \\ 4 \end{matrix}$	2	56,5006	-0,0914	-0,0914	0
84,88872	$\begin{matrix} 12 \\ \text{C}^* \\ 6 \end{matrix}$	4	92,1635	+7,2748	8,3662	0
113,18496	$\begin{matrix} 16 \\ \text{O} \\ 8 \end{matrix}$	4	127,6212	14,4362	7,1614	0
141,4812	$\begin{matrix} 20 \\ \text{Ne}^* \\ 10 \end{matrix}$	4	160,6473	18,1661	4,7299	0
169,77744	$\begin{matrix} 24 \\ \text{Mg} \\ 12 \end{matrix}$	4	198,2573	28,4802	10,3141	0
198,07368	$\begin{matrix} 28 \\ \text{Si} \\ 14 \end{matrix}$	4	236,5386	38,4549	9,9747	0
226,36992	$\begin{matrix} 32 \\ \text{S} \\ 16 \end{matrix}$	4	271,7820	45,4121	6,9572	0
254,66616	$\begin{matrix} 36 \\ \text{Ar} \\ 18 \end{matrix}$	4	306,7198	52,0536	6,6415	0
282,96240	$\begin{matrix} 40 \\ \text{Ca} \\ 20 \end{matrix}$	4	342,0555	59,0926	7,0380	0
311,25864	$\begin{matrix} 44 \\ \text{Ti}^* \\ 22 \end{matrix}$	4	375,477	64,2184	5,1258	4
339,55488	$\begin{matrix} 48 \\ \text{Cr} \\ 24 \end{matrix}$	3	411,468	71,9131	5,6947	4
367,85112	$\begin{matrix} 52 \\ \text{Fe} \\ 26 \end{matrix}$	1	447,707	79,8559	7,9428	4
396,12736	$\begin{matrix} 56 \\ \text{Ni} \\ 28 \end{matrix}$	1	484,004	87,8566	8,0007	2 4
424,44360	$\begin{matrix} 60 \\ \text{Zn}^* \\ 30 \end{matrix}$	4	515,009	90,5654	2,7088	4 6

Note: A * indicates a restructuring of the structure.

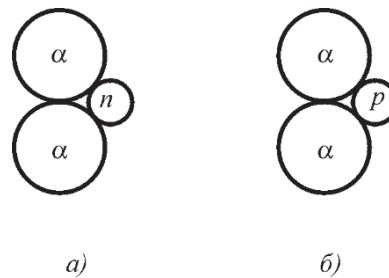
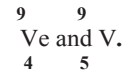

Fig. 6.10. Ensuring the isotope stability of the beryllium atom



Thus, the basis for the construction of nuclear structures should be magic nuclei, i.e., nuclei in which the number of neutrons is the so-called magic number - 2, 8, 20, 28, 50, 82, 126. The structure of each such nucleus can be visualized as consisting of a certain number of alpha particles, free pairs of neutrons and a proton (the latter - for odd-numbered nuclei). In the general case, a magic nucleus can be represented as

$$A = 4m_{\alpha} + N + i_p, \quad (6.48)$$

where m_{α} is the number of alpha particles in the nucleus; N is the number of non-alpha neutrons ($N = 0; 2; 4; \dots$); i_p is the number of free protons ($i_p = 0; 1$).

Taking into account that in magic nuclei the number of free neutrons is always even, and spin is equal to zero, one can assume that in these nuclei neutrons, not included in alpha-particles, are united in pairs and directed antiparallel to each other, but such their union, apparently, is possible only in the presence of protons or alpha-particles, creating an additional velocity gradient due to the annular rotation of vortices.

Tables 6.5 through 6.11 summarize the energies of magic nuclei and energy increments. The tables show that not all nuclei with magic neutron number have a real increased energy level.

Nuclei with neutron magic number 2

Table 6.5

0	A_x	$m\alpha + N + 1p$	$E, \text{ MeV}$	I^π	$\Delta E, \text{ MeV}$
1	${}^3\text{T}$	$3n + p$	8,4812	1/2-	-
2	${}^4\text{Don't}$	A	28,26924	0+	19,78712
3	${}^5\text{Li}$	$\alpha + p$	26,330	3/2-	-1,9324

Nuclei with neutron magic number 8

Table 6.6

Z	A_x	$m\alpha + N + 1p$	$E, \text{ MeV}$	I^π	$\Delta E, \text{ MeV}$	$\Sigma E\alpha, \text{ MeV}$	$\Delta E\alpha, \text{ MeV}$
5	${}^{13}\text{B}$	$2\alpha + 4n + p$	84,456	3/2-	-	56,593	27,864
6	${}^{14}\text{C}$	$3\alpha + 4n$	105,2867	0+	10,8307	84,8887	24,3980
7	${}^{15}\text{N}$	$3\alpha + 4n + p$	115,4939	1/2+	10,2072	84,8887	30,6062
8	${}^{16}\text{O}$	4α	127,6212	0+	12,1273	113,1849	14,4363
9	${}^{17}\text{F}$	$4\alpha + p$	128,221	5/2-	0,7998	-	-
10	${}^{18}\text{Ne}$	$2\alpha + 2p$	132,1433	+	3,9223	-	-

Nuclei with neutron magic number 20

Table 6.7

Z	A_x	$m\alpha + N + 1p$	$E, \text{ MeV}$	I^π	$\Delta E, \text{ MeV}$	$\Sigma E\alpha, \text{ MeV}$	$\Delta E\alpha, \text{ MeV}$
16	${}^{36}\text{S}$	$8\alpha + 4n$	308,7198	0+	-	226,370	84,350
17	${}^{37}\text{Cl}$	$8\alpha + 4n + p$	317,105	3/2+	88,3852	226,370	90,736
18	${}^{38}\text{Ar}$	$9\alpha + 2n$	327,3475	0+	10,2425	254,666	72,681
19	${}^{39}\text{K}$	$9\alpha + 2n + p$	333,726	3/2+	6,3785	254,666	79,060
20	${}^{40}\text{Ca}$	10α	342,0555	0+	8,3295	282,962	59,093
21	${}^{41}\text{Sc}$	$10\alpha + p$	343,140	7/2-	1,0845	-	-
22	${}^{42}\text{Ti}$	$10\alpha + 2p$	346,909	0+	3769	-	-

Nuclei with neutron magic number 28

Table 6.8.

Z	A_x	$m\alpha + N + 1p$	$E, \text{ MeV}$	I^π	$\Delta E, \text{ MeV}$	$\Sigma E\alpha, \text{ MeV}$	$\Delta E\alpha, \text{ MeV}$
19	^{47}K	$9\alpha + 10n + p$	400,197	3/2+	-	254,666	145,531
20	^{48}Ca	$10\alpha + 8n$	416,004	0+	15,807	282,962	133,042
21	^{49}Sc	$10\alpha + 8n + p$	425,623	7/2-	9,619	282,962	142,661
22	^{50}Ti	$11\alpha + 6n$	437,797	0+	12,174	311,259	126,538
23	^{51}V	$11\alpha + 6n + p$	445,8463	7/2-	8,0493	311,259	134,587
24	^{52}Cr	$12\alpha + 4n$	456,3537	0+	10,5074	339,555	116,799
25	^{53}Mn	$12\alpha + 4n + p$	462,912	7/2-	6,554	339,555	123,357
26	^{54}Fe	$13\alpha + 2n$	471,770	0+	8,858	367,851	103,912
27	^{55}Co	$13\alpha + 2n + p$	476,820	7/2-	5,050	367,851	108,969
28	^{56}Ni	14α	484,004	0+	7,184	396,147	86,857

Nuclei with neutron magic number 50

Table 6.9

Z	A_x	$m\alpha + N + 1p$	$E, \text{ MeV}$	I^π	$\Delta E, \text{ MeV}$	$\Sigma E\alpha, \text{ MeV}$	$\Delta E\alpha, \text{ MeV}$
34	^{84}Sc	$17\alpha + 16n$	727,330	0+	-	481,036	346,294
35	^{85}Br	$17\alpha + 16n + p$	737,380	3/2	10,050	481,036	256,344
36	^{86}Kr	$18\alpha + 14n$	749,239	0+	11,059	509,332	239,907
37	^{87}Rb	$18\alpha + 14n + p$	757,858	3/2-	8,619	509,332	248,526
38	^{88}Sr	$19\alpha + 12n$	768,462	0+	10,604	573,629	230,833
39	^{89}Y	$19\alpha + 12n + p$	775,534	1/2-	7,072	537,629	237,905
40	^{90}Zr	$20\alpha + 10n$	783,904	0+	8,370	565,924	227,980
41	^{91}Nb	$20\alpha + 10n + p$	789,050	9/2+	5,146	565,924	223,126
42	^{92}Mo	$21\alpha + 8n$	796,519	0+	7,469	594,221	202,298
43	^{93}Tc	$21\alpha + 8n + p$	800,623	9/2+	4,104	594,221	186,402
44	^{94}Ru	$22\alpha + 6n$	807,040	0+	6,417	622,517	184,523

Nuclei with neutron magic number **28**

Table 6.8.

Z	A_x	$M\alpha + N + 1p$	E , MeV	I^π	ΔE , MeV	$\Sigma E\alpha$, MeV	$\Delta E\alpha$, MeV
54	¹³⁶ Xe	$27\alpha + 28n$	1141,891	0+	-	763,270	378,621
55	¹³⁷ Cs	$27\alpha + 28n + p$	1149,320	7/2+	7,429	763,270	386,050
56	¹³⁸ Ba	$28\alpha + 26n$	1158,322	0+	9,002	791,539	366,783
57	¹³⁹ La	$28\alpha + 26n + p$	1164,520	7/2+	6,198	791,539	372,981
58	¹⁴⁰ Ce	$29\alpha + 24n$	1172,891	0+	8,144	819,808	352,355
59	¹⁴¹ Pr	$29\alpha + 24n + p$	1177,891	5/2+	5,227	819,808	358,083
60	¹⁴² Nd	$30\alpha + 22n$	1185,116	0+	7,225	848,077	337,039
61	¹⁴³ Pm	$30\alpha + 22n + p$	1195,910		10,794	848,077	347,833
62	¹⁴⁴ Sm	$31\alpha + 20n$	1195,682	0+	0,228	876,346	319,336
63	¹⁴⁵ Eu	$31\alpha + 20n + p$	1198,944	-	-	876,346	322,599
64	¹⁴⁶ Gd	$32\alpha + 18n$		-	-	-	-

Nuclei with neutron magic number **126**

Table 6.11

Z	A_x	$M\alpha + N + 1p$	E , MeV	I^π	ΔE , MeV	$\Sigma E\alpha$, MeV	$\Delta E\alpha$, MeV
80	²⁰⁶ Hg	$40\alpha + 46n$	1621,068	0+	-	1130,77	490,298
81	²⁰⁷ Tl	$40\alpha + 46n + p$	1628,434	1/2-	7,366	1130,77	497,664
82	²⁰⁸ Pb	$41\alpha + 44n$	1636,452	0+	8,018	1159,04	477,413
83	²⁰⁹ Bi	$41\alpha + 44n + p$	1640,255	9/2-	3,803	1159,04	481,216
84	²¹⁰ Po	$42\alpha + 42n$	1645,232	0+	4,977	1187,31	457,924
85	²¹¹ At	$42\alpha + 42n + p$	1648,213	9/2-	2,981	1187,31	460,905
86	²¹² Rn	$43\alpha + 40n$	1652,511	0+	4,298	1215,58	436,934
87	²¹³ Fr	$43\alpha + 40n + p$	1654,708	-	2,197	1215,58	439,131
88	²¹⁴ Ra	$44\alpha + 38n$	1658,470	0+	3,762	1243,85	414,623
89	²¹⁵ Ac	$44\alpha + 38n + p$	1659,770	-	1,300	1243,85	415,923

As follows from the values of energies and their differences, the regularities for magic numbers in some places undergo jumps: for number 8 fluorine and neon do not fit into the general regularity; for number 20 - scandium and titanium; for number 82 - promethium, samarium and europium. Thus, only nuclei with the number of alpha particles 1, 4, 10, 14, 22, 30, and 44 are complete structures of nuclei.

As can be seen from Table 6.2, there is a periodicity of recessions and rises of bond energies with increasing neutron number, which is true for all nuclei. This can be explained both by a change in the number of interacting surfaces and by a change in the deformation of nucleons. Thus, when one nucleon is placed on the surface of the nucleus, there is only one interaction surface between it and the rest of the nucleus mass; when the second nucleon is placed on the surface of the nucleus, there are two, but one side of the previously placed nucleon is convex; when the third nucleon is added, there are also two, but one side is even more convex, which reduces the interaction energy compared to the binding energy of the previous nucleon; when the fourth nucleon is added, there are three surfaces, but two of them are convex (Fig. 6.11).

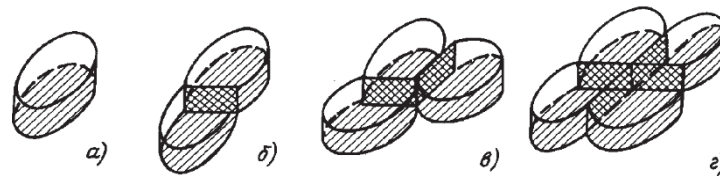

Fig. 6.11. Explanation of the periodicity of the increment of the nucleon bonding energy with increasing number of nucleons in the nucleus: installation of one (a), two (b), three (c), and four (d) nucleons on the surface of the nucleus.

From the above, the following conclusions can be drawn.

The addition of two neutrons in nuclear isotopes in most cases does not change the spin value. Consequently, these neutrons are joined antiparallel, but this is possible only in the presence of alpha particles. The same confirms the invariance of the magnetic moment. Why this happens is easily seen from the structure of vortices: in this case, the main toroidal flow of these neutrons follows a closed path, which causes their antiparallelism, but one or both neutrons with their side walls lean to one of the alpha particles also antiparallel.

The value of the spin of the nuclei, in which it is not equal to zero, allows us to judge the number of nucleons that are not part of the alpha particles and oriented parallel to each other. In the simplest case, this number is determined by the expression

$$k = \frac{|I|}{1/2} \quad (6.49)$$

here $1/2$ is the spin number in units of \hbar , and in nuclei with odd Z this number includes one of the protons, the remaining protons being part of the alpha particles forming the main mass of the nucleus.

Consideration of the general pattern of energy change has an effect, that prior to Ni the total bond energy level attributable to each added neutron, increases with increasing relative atomic mass.

For example, the transition from ${}_{28}^{61}\text{Ni}$ to ${}_{28}^{62}\text{Ni}$ gives 10.59 MeV, and the transition from ${}_{29}^{62}\text{Cu}$ to ${}_{29}^{63}\text{Cu}$ is already 10.85 MeV, i.e., in the presence of an additional proton

addition by a neutron for the same number of neutrons gives a larger increment of binding energy.

The explanation may lie in the fact that at a total larger number of nucleons their packing is somewhat more dense, the vortices are more tightly pressed to each other, due to which the contact area of nucleons in the boundary layers increases, and the energy of the interaction bonds between nucleons increases.

So, nuclei can be thought of as:

- 1) including alpha particles, the number of which is determined by the number nearest to the atomic number divided by 4, but not greater than the even number nearest to Z ;
- 2) which include parallel oriented nucleons, the number of which is equal to k ;
- 3) including neutron pairs oriented mutually antiparallel, the number of which is equal to the difference

$$n = A - N - k \quad (6.50)$$

For example, ${}_{15}^{29}\text{P}$ with $E = 239.286$ MeV and $I^\pi = 1/2$ consists of seven alpha particles ($m_\alpha = 7$), which requires 28 nucleons and one proton with spin 1/2. The energy increment ${}_{15}^{29}\text{P}$ compared to ${}_{14}^{28}\text{P}$ is 17.87 MeV, which means that in the composition of ${}_{15}^{29}\text{P}$ was present only 6

alpha particles. The seventh alpha particle was formed at the addition of the 14th neutron (29th nucleon), which gave such a large increase in the interaction energy (Table 6.12).

In the composition of ${}^{30}\text{P}$ ($E = 250.6119$ MeV, $I^\pi = 1$) there are still seven alpha particles, a proton and a neutron form a deuteron-type compound with spin equal to 1. Another interpretation is possible here: the proton and neutron have parallel spins, and their axial fluxes in this nucleus are not closed.

There are also seven alpha particles in ${}^{31}\text{P}$ ($E = 262.918$ MeV, $I^\pi = 1/2$), with the added neutron attached antiparallel to the neutron.

There are still seven alpha particles in ${}^{32}\text{P}$ ($E = 270.865$ MeV, $I^\pi = 1$), the added neutron is attached antiparallel to the proton to form a deuteron with spin equal to 1, with magnetic moments subtracted ($\mu = -0.2523\mu_n$).

Table 6.12.

A_x	E , MeV	ΔE , MeV	I^π	μ / μ_n
${}_{15}^{28}\text{P}$	224,419	-	-	-
${}_{15}^{29}\text{P}$	239,286	17,87	1/2+	-
${}^{30}\text{P}$	250,6119	11,33	1+	-
${}^{31}\text{P}$	262,918	12,30	1/2+	+1,1317
${}^{32}\text{P}$	270,855	7,94	1+	-0,2523
${}^{33}\text{P}$	280,9594	10,1	1/2+	
${}^{34}\text{P}$	287,520	6,57	1+	

Based on the above, we can consider the probable structure of complex nuclei.

6.5.3. Structure of complex nuclei

Lithium-oxygen nucleus group.

Lithium. Table 6.13 summarizes the energies and some other characteristics of lithium isotopes.

Table 6.13.

A_x	E , MeV	ΔE , MeV	I^π	μ / μ_n	Q
^5_3Li	26,330	-	-	-	-
^6_3Li	31,9948	5,6648	1	+0,822	-0,0008
^7_3Li	39,2455	7,2507	3/2	+3,2564	-0,040
^8_3Li	41,2782	2,0327	2	+1,6532	-
^9_3Li	45,330	4,1518	3/2	-	-

The binding energy of the lithium isotope ^5_3Li is 26.33 MeV, i.e. less than energies of interactions of nucleons in the alpha-particle, hence, in the composition of this isotope the alpha-particle is not formed, although there are enough protons and neutrons for it. Consequently, the isotope is unstable and must decay, which actually happens with half-life $T = 10^{-21}$ with the release of energy, at that



For this isotope, the most realistic variants of structures are two - a bulk structure in which two neutrons are placed coaxially and protons symmetrically on the sides, and a planar structure in which one proton is shifted to the side; the planar structure is formed from the bulk structure by reorientation of spins (Fig. 6.12 *a, b*), the expected value of spins in both cases is 1/2.

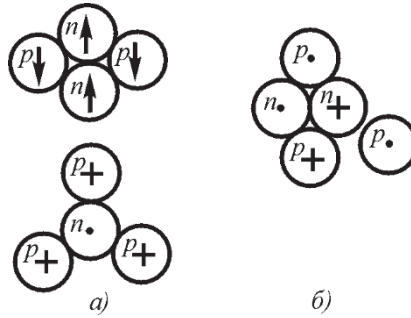
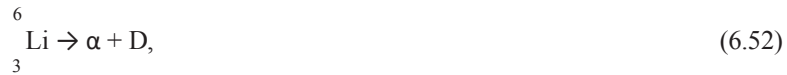

Fig. 6.12. Structure of the ${}^5_3\text{Li}$ nucleus: *a* - lower layer; *b* - upper layer

The ${}^6_3\text{Li}$ isotope has a nucleon binding energy $E = 31.9948$ MeV and thus $E > E_\alpha$, spin is equal to 1. Therefore, it can be assumed that



i.e., a deuteron is connected to the alpha particle. Both bulk (*a*) and planar (*b*) structures are possible (Fig. 6.13).

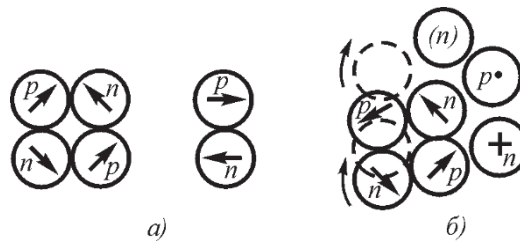

Fig. 6.13. Structure of the ${}^6_3\text{Li}$ nucleus

Addition of the seventh nucleon in isotope ${}^7_3\text{Li}$ (flat structure)

well explains the relatively large energy increase (7.25 MeV) by filling the empty space in the nucleus. Spin 3/2 indicates the orientation of the seventh nucleon parallel to spin D.

The attachment of the eighth and ninth nucleons (fifth and sixth neutrons) is most likely from one of the outer sides of the system between the protons, with the neutron with low binding energy to be located between the protons of the alpha particle, and the last neutron between the fifth neutron and the third proton.

Beryllium. Table 6.14 summarizes the characteristics of beryllium isotopes.

Table 6.14.

A_x	E , MeV	ΔE , MeV	I^π	μ / μ_n	Q	B
${}^7_4\text{Ve}$	37,6012	-	3/2-	-	-	-
${}^8_4\text{Ve}$	56,5006	18,9	0+	-	-	-
${}^9_4\text{Ve}$	58,1657	1,66	3/2-	-1,1776	0,03	-
${}^{10}_4\text{Ve}$	64,9777	6,83	0+	-	-	1,22
${}^{11}_4\text{Ve}$	65,478	0,5	1/2+	-	-	-
${}^{12}_4\text{Ve}$	-	-	-	-	-	-

Since the binding energy of nucleons of the ${}^7_4\text{Ve}$ isotope is 37.6012

MeV, it can be assumed that one alpha particle is formed in the nucleus system. The remaining $2p + n$ do not form, judging from the spin, nuclei of the Ne type, but are independently attached to the alpha particle, most probably by the second layer, with one proton and one neutron forming the deuteron structure with spin equal to 1 (Fig. 6.14).

The isotope ${}^9_4\text{Ve}$ is formed from the isotope ${}^7_4\text{Ve}$ by the addition of two neutrons. It can be considered that these two neutrons are oriented antiparallel to each other, as a result of which the spin values are conserved (Fig. 6.15).

The isotope ${}^{10}_4\text{Ve}$, judging by the spin equal to zero, is two alpha particles bound together by two neutrons whose spins are antiparallel. A variant of the three-layer structure is possible, in which the deformation coefficient of the nucleus, taking into account the deformation of the

of the vortices will be $1.22 (e - a = 2.5 r_p)$, where r_p is the radius of the proton vortex) (Fig. 6.16).

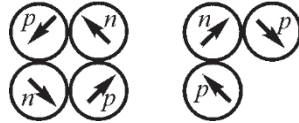

Fig. 6.14. Structure of the ${}^7\text{Ve}$ nucleus

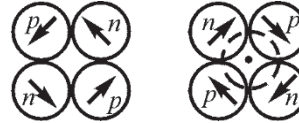

Fig. 6.15. Structure of the ${}^9\text{Ve}$ nucleus

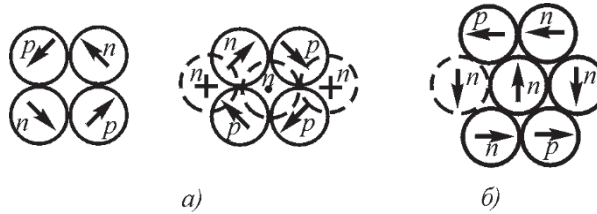

Fig. 6.16. Structure of nuclei of ${}^{10}\text{Ve}$ (a) and ${}^{11}\text{Ve}$ (b)

The isotope⁸ Ve is formed by the attachment of a fourth neutron to a free space. The rearrangement of the second layer occurs, the central flow of proton and neutron vortices is closed, as evidenced by the attachment energy of 18.9 MeV. Two alpha particles are produced. However, since the binding energy of the isotope is only $56.5006 \text{ MeV} < 2E_\alpha = 56.59248 \text{ MeV}$, the isotope cannot persist for long, which is what actually happens: the half-life for⁸ Ve is $T = 3 \cdot 10^{-16} \text{ s}$. As mentioned above, knowing the vortex structure of the particles, this result was not difficult to predict. Thus, the energy gain of 18.9 MeV indicates the rearrangement of the layer structure into an alpha particle.

The isotope¹¹ Be is formed by attaching a neutron, whose spin determines the total spin of the nucleus.

In beryllium, as in all nuclei with even Z at an even number of neutrons, the spin becomes zero. On this basis, one can assume that these nuclei for $A = 2Z$ consist of alpha particles, as evidenced by the jump of the interaction energy of nucleons, which causes the rearrangement of the structure of the vortex system into alpha particles.

Boron. Table 6.15 summarizes the main characteristics of boron isotope nuclei.

Table 6.15.

A_x	$E, \text{ MeV}$	$\Delta E, \text{ MeV}$	I^π	μ / μ_n	Q
^8_5B	37,7382	-	2+	-	-
^9_5B	56,315	18,6	-	-	-
$^{10}_5\text{B}$	64,7509	8,44	3+	1,8007	+0,074
$^{11}_5\text{B}$	76,5760	11,45	3/2-	2,6825	+0,0355
$^{12}_5\text{B}$	79,5760	3,37	1+	1,002	-
$^{13}_5\text{B}$	84,456	4,9	3/2		

The boron isotope ^8_5B is known to have a binding energy of 37.7382 MeV, and the
with spin 2+, it follows that

$$^8_5\text{B} = \alpha + 3p + n, \quad (6.53)$$

with proton and neutron oriented in parallel. A variant of the two-layer structure of such a nucleus is shown in Fig. 6.17.

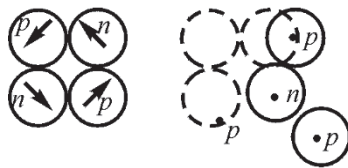

Fig. 6.17. Structure of core ^8_5B

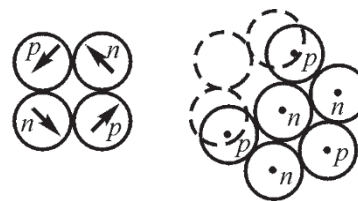

Fig. 6.18. Structure of core $^{10}_5\text{B}$

The isotope ^9_5B has a binding energy of 56.315 MeV $< 2E_\alpha = 56.59248$ MeV, hence this isotope is unstable:

$$^9_5\text{B} \rightarrow 2\alpha + p. \quad (6.54)$$

The isotope¹⁰B has a binding energy of 64.7509 MeV and a spin of 3+. Although in this case $E > 2E_\alpha$, the spin value indicates that this isotope contains no more than one alpha particle. The remaining nucleons all have parallel spins (Fig. 6.18).

The isotope¹¹B is the most abundant. It has a spin of 3/2. Hence, eight nucleons together give a spin equal to zero, i.e. they make two alpha particles. In addition, the addition of a sixth neutron gives a relatively large addition of energy. Thus



A possible variant of the structure is shown in Fig. 6.19.

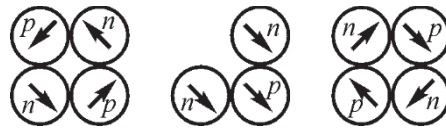

Fig. 6.19. Structure of the core ${}_{5}^{11}\text{B}$

Carbon. Table 6.16 summarizes the main characteristics of carbon isotope nuclei.

Table 6.16.

A_x	E, MeV	$\Delta E, \text{MeV}$	I^π	μ / μ_n	Q
⁹ ₆ C	59,037	-	-	-	-
¹⁰ ₆ C	60,318	21,28	0+	-	-
¹¹ ₆ C	73,4418	13,12	3/2+	10,3	+0,031
¹² ₆ C	92,1635	18,72	0+	-	-
¹³ ₆ C	97,1099	4,95	1/2-	0,7024	-
¹⁴ ₆ C	105,2867	8,14	0+	-	-
¹⁵ ₆ C	106,5048	1,22	1/2-	-	-
¹⁶ ₆ C	110,757	4,25	0+	-	-

The isotope⁹ C, judging by the binding energy, contains only one alpha particle. But the addition of a fourth neutron is accompanied by an energy increase equal to 21.3 MeV. Hence,

$${}^9_6\text{C} = 2\alpha + p\uparrow + p\downarrow. \quad (6.56)$$

A possible variant of the structure is a three-layer structure (Fig. 6.20). Two alpha particles are oriented antiparallel, two protons are attached to neutrons. Further buildup by neutrons fills the third alpha particle, so that

$${}^{12}_6\text{C} = 3\alpha.$$

This compound is stable because the binding energy is much higher than the internal binding energy of the three alpha particles (by 7 Mev) (Fig. 6.21). The new neutrons attach to the external protons, the number of which is four, so the last isotope of carbon is a ¹⁶C.

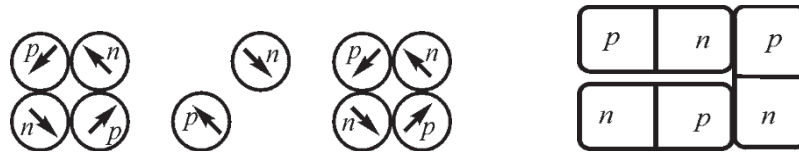

Figure 6.20. Structure of the ${}^{10}_6\text{C}$ nucleus Fig. 6.21. Structure of the ${}^{12}_6\text{C}$ kernel

Nitrogen. Table 6.17 summarizes the main characteristics of nitrogen isotope nuclei.

The isotope¹² N, which has a binding energy of 74.038 MeV, contains no more than two alpha particles. Since the spin is +1, it can be assumed that from the remaining nucleons the proton and neutron have formed a deuteron with spin 1, and the two neutrons are coupled antiparallel.

Table 6.17.

A_x	$E, \text{ MeV}$	$\Delta E, \text{ MeV}$	I^π	μ / μ_n	Q
$^{12}_7\text{N}$	74,038	-	1+	0,46	-
$^{13}_7\text{N}$	94,1069	20,7	1/2-	0,3221	-
$^{14}_7\text{N}$	104,6603	10,55	1+	+0,4036	+0,01
$^{15}_7\text{N}$	115,4939	10,83	1/2-	-0,2831	-
$^{16}_7\text{N}$	117,9838	2,5	2-	-	-
$^{17}_7\text{N}$	123,868	5,88	1/2-	-	-
$^{18}_7\text{N}$	126,536	2,67	-	-	-

The addition of the sixth neutron is accompanied by an increase in the binding energy by 20.7 MeV, hence a third alpha particle has been formed. The spin is 1/2, hence,

$$^{13}_7\text{N} = 3\alpha + p. \quad (6.57)$$

Further addition of a neutron increases the spin by 1/2, spin becomes equal to 1. The addition of the next neutron decreases the spin again, hence the two neutrons have formed an antiparallel pair.

Nitrogen is a transitional element to oxygen.

Oxygen. *The* most complete structure of the nucleus in the considered series of atomic nuclei is the structure of the oxygen nucleus

$^{16}_8\text{O}$. This, in particular, can be seen from the table of bond energies for isotopes oxygen (see Table 6.18).

The structure of $^{16}_8\text{O}$ can be represented, if we take into account the necessity of closing the central flows of ether in alpha-particles along the path of least resistance, then

$$^{16}_8\text{O} = 4\alpha. \quad (6.58)$$

Table 6.18.

A_x	E , MeV	ΔE , MeV	I^π	μ / μ_n	Q	B
$^{13}_8\text{O}$	75,560	-	-	-	-	-
$^{14}_8\text{O}$	94,1069	23,17	0+	0,7189	-	-
$^{15}_8\text{O}$	111,9522	13,22	$\frac{1}{2}-$	-	-	0,084
$^{16}_8\text{O}$	127,6212	15,67	0+	-1,8937	-0,0265	-
$^{17}_8\text{O}$	131,7635	4,14	$\frac{5}{2}+$	-	-	0,30
$^{18}_8\text{O}$	139,810	8,05	0+	-	-	-
$^{19}_8\text{O}$	143,7671	3,95	$\frac{5}{2}+$	-	-	-
$^{20}_8\text{O}$	151,371	7,61	0+	-	-	-

In this structure, alpha particles are connected in a ring with each one rotated by 90° in two planes, each subsequent one relative to the previous one (Fig. 6.22). All the previous structures of oxygen and nitrogen can be built on this basis, taking into account the techniques described above.

To the four outer protons of oxygen¹⁶ O, four more neutrons can be attached respectively, giving the isotope²⁰ O.

Since the addition of the first and third of them changes the spin to $\frac{5}{2}+$, the alpha particles nearest to these neutrons are rearranged. The addition of even neutrons leads to the restoration of the alpha-particle structure, and two neutrons are coupled antiparallel to each other.

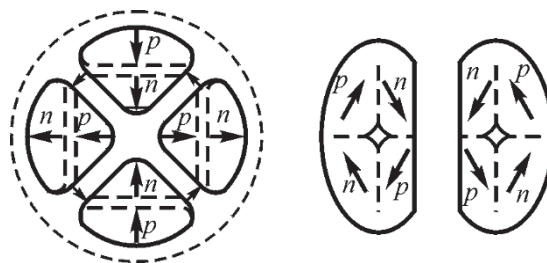

16
Fig. 6.22. Structure of the O nucleus
8

The completeness of the structure of the isotope ^{16}O explains its high stability (twice the magic number).

Calcium-fluoride nuclei group.

Further beyond oxygen, the build-up of nuclei is accomplished by the attachment of alpha particles, individual protons, and individual neutrons along the surface of the oxygen nucleus.

The completed structure is the Ca nucleus, which was formed by connecting to O six more alpha particles: two at the poles and four along the equator (Fig. 6.23).

Transition forms of nuclei from F to Ca are formed by attaching nucleons in place of future alpha particles on the surface of the structure. The new nucleon is attached in such a way as to its interaction energy was maximized.

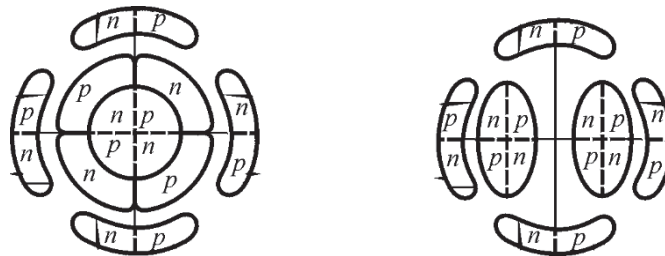
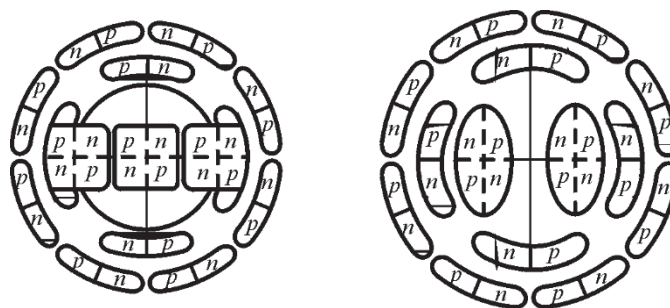

Fig. 6.23. Structure of Ca nucleus

Group of scandium-ruthenium nuclei. The next completed structure is a structure containing 22 alpha particles; the maximum possible number of alpha particles in nuclei with the magic neutron number is 50. This structure can be formed by adding to

6 alpha particles to each hemisphere Ca (Fig. 6.24).



94
Fig. 6.24. Structure of the core Ru
44

The maximum number of nucleons in ruthenium is 108, i.e. the nucleus includes 20 neutrons in addition to 22 alpha particles. As can be seen from Fig. 6.26,

12 neutrons can be placed along the 12 outer alpha particles of the upper layer, and 9 neutrons can be placed between the alpha particles of the previous layer, with 4 neutrons in each hemisphere. It should be noted that other variants of neutron placement are probably possible, so this question is subject to clarification.

Intermediate nuclei are formed as partial structures of the ruthenium nucleus. When only near-pole alpha particles are attached to ^{40}Ca , a complete structure with the magic number 28 is formed,

culminating in $^{56}_{28}\text{Ni}$.

A group of rhodium-gadolinium nuclei.

Joining to poles crosswise another 5 alpha-particles on each pole gives the following magic nuclei, the last of which is $^{64}_{64}\text{Gd}$. To the magic number of neutrons 82 corresponds the isotope

$$^{146}_{64}\text{Gd} = 32 \alpha + 18, \quad (6.59)$$

the structure of which is shown in Fig. 6.25.

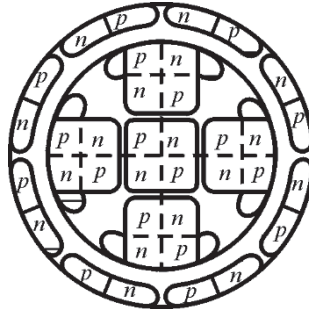

Fig. 6.25. Structure of the nucleus ${}_{64}^{146}\text{Gd}$.

A group of terbium actiniae nuclei.

Adding 12 more alpha particles to the completed structure of gadolinium gives the next completed structure with the magic number of neutrons 126. However, the specific arrangement of nucleons here is already difficult to trace. It is noteworthy that there is no

of the thorium isotope ${}_{90}^{216}\text{Th}$. This can be explained by the increasing convex-

The instability of the nuclei of the elements following thorium is also noteworthy. The instability of element nuclei following thorium should also be noted.

6.6. Excited states of vortex toroids - weak nuclear interactions

Due to the fact that the surface of a helical vortex toroid is separated from the environment by a boundary layer, and the toroid itself is compacted, surface (transverse) (Fig. 6.26) and deep (longitudinal) waves must propagate along it during shock pulse excitation.

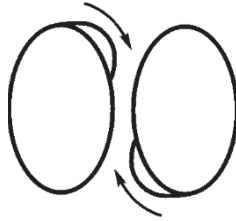

Fig. 6.26. Passage of surface waves along the nucleon body

Given the difference in the density of the toroid body at different distances from the surface and the fact that the propagation velocity of longitudinal waves is always significantly higher than the propagation velocity of transverse waves, it should be assumed that the generated waves may have many components moving in the toroid body independently and asynchronously relative to each other.

In a nucleus in which the individual nucleons are bound together through common boundary layers, the energy of transverse waves traveling along the surface of one of the nucleons will be transmitted to the other nucleons and excite transverse and longitudinal waves in them.

Transverse waves traveling along the surface of nucleons will create oscillations in the surrounding ether, which will propagate in it and be perceived as high-frequency electromagnetic radiation. Due to the exceptionally high elasticity of the nucleon bodies, these oscillations have a very high frequency - from 10^{18} to 10^{23} Hz (gamma radiation). Taking into account the density difference between the nucleon bodies and the free ether, it should be stated that the energy transfer of oscillations by excited nuclei to the external space will be rather slow and last for a long time, sometimes many years, which is what happens in reality.

When asynchronous waves travel in the body of the nucleus, the crests and troughs of the individual components may occasionally sum up. In those cases when the crests sum up within the boundary layer separating the nucleons, they will change the distance between them.

If wave crests pass along the surface of two nucleons facing each other, the thickness of the boundary layer at this moment will be reduced, and since the equilibrium of the forces of attraction and repulsion of the nucleons exists only at a certain thickness of the boundary layer, in this case there will be a repulsive force. If the momentum of this force is sufficient to move the nucleons apart by an amount essentially exceeding the boundary layer thickness, then after passing the crest of the waves the nucleons

will be separated, and the electric repulsion forces (interaction forces due to annular rotation) will force the nucleons further away from each other.

If, on the contrary, troughs of waves pass simultaneously along the surface of the nucleons, the nucleons will be attracted, but then after passing the troughs it will appear that the boundary layer thickness is reduced in comparison with the boundary layer thickness in the steady state, and the nucleons will also receive a repulsion impulse.

Thus, the simultaneous appearance of the surface wave crests of two nucleons in the inter-nucleon space can lead to the decay of the system of vortex toroids - nucleons, i.e., to nuclear decay.

Keeping in mind that the binding energy of the two surfaces of the proton-neutron interaction is about 6 MeV, and the binding energy of the alpha particle is 28.3 MeV, we should expect that as a result of such decay it is not the individual nucleons included in the alpha particles that are separated, but the whole alpha particles. This is alpha decay.

Fission of nuclei into larger parts is also possible, but this fission will mainly take place not along the body of alpha particles, but along their boundaries, i.e. in both parts the alpha particles will be preserved entirely. Of course, if besides alpha-particles the nucleus includes also separate nucleons, the separation of such nucleons is also probable.

The passage of waves through the nucleus can also lead to the appearance of depressions in individual neutrons, which will break the integrity of its body and, most importantly, the integrity of its boundary layer. Being broken, this boundary layer will not be preserved and will not necessarily recover. It may break off, close, and collapse into an independent particle. Since in it the direction of helical motion is opposite to that in the proton, the formed particle will be perceived as a particle with negative charge - an electron. This is a possible variant of the β -decay mechanism.

At decay of nuclei or transformation of neutron boundary layers or inter-nucleon boundary layers a part of the ether will pass into a free state, it is perceived as a defect of masses and is treated today at the expense of neutrino formation. Without denying the possibility of formation of such a particle having a mass close to the electron mass, but having no annular rotation or having annular rotation shielded already by its boundary layer, one should nevertheless pay attention also to the possibility of simple dissolution of the boundary layer excess in the free aether without

formation of any particle. This direction has not been practically considered at all up to the present time.

In accordance with the presented concept in the process of transformation of nuclei of any elements unstable vortex helical structures of various forms and masses can be formed. Most of them will not be stable and will continue transformation - fission (disintegration), compaction, fission again and simply dissolution in the Ether until the remaining vortex mass will not come to several stable forms. Such processes, when the same initial conditions are established, will occur in relatively the same way, giving the impression of stability of the intermediate forms. Nevertheless, all these intermediate forms are fragments of stable forms of particles - nucleons and their boundary layers, and not at all

"elementary particles" of the microcosm of which matter is supposedly composed. Matter does not consist of them, and they are formed as a result of particles hitting each other, as a result of bombardment of element nuclei by neutrons or other particles, or as a result of other similar operations. Since there can be any number of transitional forms, there can be any number of so-called "elementary particles".

The stated ideas about the decay of complex vortex toroidal systems, which are atomic nuclei, correspond to the model of weak nuclear interaction.

Modern ideas about the forces of weak nuclear interaction have led to the idea of the stability of the decay of radioactive nuclei. For most unstable isotopes, the half-life of the elements has been determined, i.e., the time during which half of the mass of the isotope should remain from the initial mass of the isotope, while the other half of the mass is transformed into the corresponding isotopes of other elements.

However, according to some researchers, the half-life of radioactive elements actually varies within wide limits, which casts doubt on the validity of some statements of the modern theory of weak nuclear interactions. Thus, G. Lebon in [28] notes that if Becquerel determined the duration of existence of 1 g of radium in 1 billion years, Curie - in 1 million years. Rutherford limited the existence of this gram of substance to one millennium, and Crookes - several centuries. Heidweiler determined by direct weighing that 5 g of radium loses about 0.02 mg in 24 h. With uniform loss, these 5 g would lose 1 g of their mass over 137 years. Lebon's own experiments have shown that the radioactivity of the same body increases considerably when the body is

extends over a large surface area. This is accomplished by drying paper through which a solution of the test body is filtered. These experiments led Lebon to the conclusion that 5 g of radium loses 1 g of its mass in 20 years.

Even taking into account the data given in [24], showing that the longest-lived is the alpha-radioactive

²²⁶Ra with a half-life of 1600 years, and taking into account the existence of so-called radioactive series, it is not difficult to show that if bodies possessing rapid gratuitous radioactivity existed in remote geologic epochs, they would have ceased to exist long ago....

This circumstance can also be interpreted as a confirmation of Lebon's statement that radioactivity appears only after bodies form certain chemical compounds, and, therefore, the state of the electron shell may influence the stability of some nuclei.

In connection with the above, the following assumption about the onset of radioactivity of unstable nuclei can be made. The matter of nuclei, possessing high elasticity and relatively small friction losses, thus has high goodness of fit. Since vortices have the ability to perceive energy from the external environment and, thus, the source of vortex energy increase is always present, the complex nuclear system turns out to be sensitive even to relatively insignificant external excitations. As a result, a mechanism of rocking of the system appears, which leads to the appearance of waves. The electron shell (attached ether vortices) serves as a damper, but for dissociated matter this damper weakens and the process accelerates. Thus, we can expect that at the level of nuclei and surrounding shells there is a process of automatic regulation prone to self-excitation, which always takes place in unstable systems. Therefore, in the future it makes sense to investigate the processes of weak nuclear interactions from the standpoint of the theory of automatic regulation.

6.7. Nuclear isomerism

In nuclei formed by a large number of alpha particles, there are many depressions on the surface of the nuclei into which neutrons can insert themselves. That's why atoms with high atomic weights

the number of isotopes is larger than for atoms with small atomic weight. The number of isotopes with a smaller number of neutrons relative to the integer number of alpha particles as well as with a larger number of neutrons becomes large.

With increasing atomic weight and number of alpha-particles forming atomic nuclei, the convexity of external alpha-particles becomes more and more, so for new neutrons joining neutrons the surface of their connection with neighboring nucleons becomes less and less, respectively, the energy of their bonds becomes less. At the same time, the bonds of neutrons that hit different parts of the surface of nuclei can be different, although the total atomic weight and the number of protons and neutrons will be the same. This will manifest the phenomenon of nuclear isomerism, i.e., the difference in the shapes of nuclei with the same composition of nucleons. The number of possible nuclear isomers will grow with increasing atomic weight of the nucleus, but starting from a certain number of both isotopes and isomers will decrease, because the increasing convexity of the nuclei will lead to an unacceptable reduction of the surface area of the nucleon junction. This will make the next isotope unstable, it will not be able to persist.

The specific binding energy of the nucleons in the deuteron is 1.1123 MeV/nucleon, the minimum number, and each nucleon has only one bonding surface. In an alpha particle, each nucleon has two bonding surfaces, and, in addition, all nucleons are bound by three common ether flows, the first passing through the central channels of all nucleons, the second inside the alpha particles, and the third outside.

The specific energy of alpha-particle bonds is 7.074 MeV/nucleon. In composite nuclei the maximum specific energy is possessed by the nucleus of the iron isotope with atomic weight 56, which has only 13 alpha particles and four neutrons, here the specific binding energy is 8.79 MeV/nucleon. In this nucleus, to the binding energy of the nucleons in the alpha particles, which is $28.29624 \times 13 = 368.85$ MeV, is added the binding energy of the alpha particles to each other and the binding energy of the neutrons not included in the alpha particles to the alpha particles. In iron, this added energy is $492.27 - 368.96 = 123.3$ MeV, or 2.2 MeV/nucleon. This added energy is due to the increase in the number of nucleon surfaces facing each other on the surfaces of neighboring alpha particles and the addition of four neutrons not included in the alpha particles. But this added energy is not uniformly distributed, it falls only on the surfaces of the

of nucleons inside the nucleus, the external surfaces of nucleons do not give an increment of the binding energy.

Simultaneously with the increase in the number of nucleons in the nuclei, the convexity of the external surfaces increases, which reduces the contact area of the newly added nucleons. The number of depressions on the nucleon surface into which new nucleons can be inserted also increases. This is why the number of new isotopes increases as the atomic weight of atomic nuclei increases. The number of isotopes in helium and lithium reaches 5, in heavy nuclei - 16-18, but in nuclei with atomic weights of 180 and more the number of isotopes begins to decrease. The latter is explained by the fact that increasing the convexity of the nuclei surfaces reduces the surface area of the nucleon junction and does not allow to create a stable structure of the nucleus.

An increase in the number of depressions on the surface of the nucleus should lead to the so-called nuclear isomerism, in which the same composition of nucleons can form different forms of nuclei due to the fact that new nucleons are installed on the surface of the nucleus in different places. The binding energies of such nucleons will differ from each other, albeit slightly. The nuclei themselves will also differ, probably not too significantly, by the shape of the aether streams leaving the nuclei and still, as a result, by somewhat different physical and chemical properties.

As an example, we can take the nucleus of silicon, which has an atomic weight of 28 and consists of 7 alpha particles. Here three structures are possible: 1) when three alpha particles are attached to the oxygen nucleus, which consists of four alpha particles; 2) when only two alpha particles are attached to the equator of the oxygen nucleus, and the third is located at one of the poles; 3) when only one alpha particle is located at the equator, and it can be rotated differently on different parts of the surface of the oxygen nucleus, the other two are located at both poles. It is likely that the physical properties of all these structural variants will be somewhat different. Taking into account the attachment of neutrons in different places of the nucleus surface, the number of variants of nuclear isomers of silicon alone will number in the tens.

It can be assumed that nuclear isomers will have different stability, especially to external influences, and that they can be transformed into each other without changing the overall composition of the nucleus. The general tendency of rearrangement of nuclear isomers should go in the direction of increased specific energy of nucleon bonds.

Conclusions .

1. A comparison of the properties of the gas helical toroidal vortex with those of the proton shows the possibility of interpreting the proton as a helical toroidal vortex of the aether, and the neutron as the same vortex, but surrounded by an additional boundary layer of the order of 0.1 Fermi thickness, in which the toroidal motion is weakened and the annular motion is almost completely extinguished. The velocity of the translational motion of the aether on the surface of the proton significantly exceeds the speed of light and is of the order of $1.15 \cdot 10^{21}$ m/s; the velocity of the aether fluxes on the inner surface of its walls is 400 times greater.

2. The magnetic field of a proton can be interpreted as the progressive velocity of toroidal flows of the aether created by the proton in the surrounding space. The electric field can be interpreted as a circular motion of the aether in the vicinity of the same proton. The polarity of the electric field is the orientation of the circular motion of the aether relative to the toroidal one, i.e. as a sign of the helical motion of the aether.

The magnetic moment of the toroidal vortex is defined as the product of the square of the toroidal vortex velocity by the surface area, by the proton radius, and by the density of the aether surrounding the proton. The electric charge is defined as the product of the circular motion circulation of the medium density by the surface area of the torus.

3. The strong nuclear interaction can be interpreted as a result of the pressure decrease in the boundary layer between neighboring nucleons and the pressure of the aether on the outer sides of the atomic nucleus pressing the nucleons against each other. The difference of these pressures is $2 \cdot 10^{32}$ Pa, which considerably exceeds any known pressures, including the pressures inside stars, but is a small value relative to the pressure of the aether in free space, the value of which is $1.3 \cdot 10^{36}$ Pa.

4. The currently existing models of nuclei describe some properties of nuclei and are actually abstracted mathematical models that do not give any idea either about the structure of nuclei or about the physical essence of intranuclear interactions. The developed ether-dynamic models of the proton, neutron, and atomic nuclei allow us to elucidate the structure of nucleons themselves, the structure of atomic nuclei, and the physical essence of intranuclear interactions.

5. Atomic nuclei can be regarded as a set of only nucleons - protons and neutrons, connecting through boundary layers. The basis for the structure of complex nuclei are α -particles, the bonding energy in which is increased due to the central ether flux common to the four nucleons. The developed α -particle model of nuclei takes into account the structural peculiarities of the coupling of nucleons and allows us to explain the main features of the structure of nuclei - structure, magic numbers of neutrons, spin, etc.

6. Periodic (through one nucleon) changes in the increment of the nucleon bonding energy in atomic nuclei are the result of changes in the number of nucleon bonding surfaces and changes in the shape (curvature) of their surfaces.

7. Weak nuclear interaction can be interpreted as a result of asynchronous surface waves in the bodies of nucleons, creating wave disturbances in the surrounding ether, which are perceived as electromagnetic radiation. The decay of complex nuclei can be interpreted as the result of the displacement of parts of the nucleus at the coincidence of waves in the inter-nucleon layer.

8. Complex nuclei of the same isotope can have the property of nuclear isomerism, because at the same composition of nucleons they can have different structure.

Chapter 7: Atoms, Molecules, Matter

...Helmholtz's remarkable discovery of the law of vortex motion in a perfect fluid, i.e., a fluid completely devoid of viscosity (or liquid friction), inevitably inspires the idea that Helmholtz's rings are the only true atoms.

W. Thomson Kelvin [1]

7.1. A brief history of the development of atomic physics and quantum mechanics

Attempts to solve the problem of the structure of the world and the structure of matter were made in ancient times, but we have almost no information about them. And although traditionally we attribute the first attempts to create atomism to ancient Greece [2-5], in fact they were realized many millennia before that.

Atomistic conceptions in the ancient world correlated with the conceptions of the ether, but if the ether was ascribed only general abstract properties, atoms were ascribed already some specific characteristics peculiar to bodies.

Empedocles of Agrigenta in Sicily (490-430 BC) attempted to explain the world around him on the basis of a generalized theoretical system. Very important was Empedocles' notion that the four then known elements - "earth" (solid), "water" (liquid), "air" (gas) and "fire" (energy) - formed the smallest of the four elements

"shards." These "fragments" can be combined and thus different substances can be obtained. Empedocles put forward ideas about "pores", "symmetry", "selective affinity" - theoretical models of the supposed structure of various "fragments" reflecting their ability to combine. In fact, Empedocles first introduced the notion of energy dissolved everywhere. This notion was later used by the authors of the idea of

The ancient Greek philosopher Anaxagoras (500-428 B.C.) developed Empedocles's ideas and put forward the doctrine of homeomeria - "the seeds of things", which he called "the seeds of things". Ancient Greek philosopher Anaxagoras (500-428 B.C.) developed Empedocles' provisions and put forward the doctrine of homeomeria - "seeds of things", which he thought infinite in quality and quantity. Each of the elements also consists of an infinite number of smaller particles.

For the development of natural scientific knowledge it was especially important to concretize the ideas about the existence of unusually small particles of substances. This was done by Leucippus and Democritus, who formulated the

the concept of atoms. Their doctrine raised the idea of the structure of matter to a new stage of development.

Leucippus (c. 500-440 BC) and Democritus (c. 460-370 BC) created the atomistic doctrine based on the views of their predecessors. According to them, atoms can have different shapes and sizes. This determines the possibility of their various compounds. The order and arrangement of atoms in substances, i.e. the structures of substances, can vary considerably. Due to various combinations of diverse atoms, an infinite variety of substances is formed. Unlike Anaxagoras, Leucippus and Democritus believed that the motion of atoms is inherent in them from the beginning as a way of their existence.

Democritus' atoms are *uncut* (not indivisible! - *V.A.*), existing eternally material entities. Atoms differ in shape, order and position in empty space, as well as in size, depending on their gravity. They have depressions and convexities. From their "vortices" by natural convergence the whole world is formed. But atoms themselves consist of *a'mers*, truly indivisible particles. Lenin highly valued the materialism of Democritus, designating by his name the materialist tradition in the history of philosophy ("the line of Democritus").

The most important events in science, from which atomic physics originates, were the discovery of the electron and radioactivity [6]. In 1897, the English physicist J.J. Thomson measured the charge ratio of negative particles contained in cathode rays, and on this basis, as well as on the fact that metals emit electrons when strongly heated or illuminated, concluded that electrons are part of any atoms. The results of the study of the properties of the electron and radioactivity made it possible to construct specific models of the atom. In the model proposed by J.J. Thomson in 1903. [7-9], the atom was represented as a positively charged sphere with negatively charged electrons embedded in it. Thomson's model explained a number of phenomena - emission, absorption, and scattering of light by an atom, but was unable to explain the results of E. Rutherford's experiments on the scattering of alpha particles by atoms [10].

Rutherford's experiments showed that when a beam of alpha particles was passed through thin layers of matter, a small fraction was deflected by an angle greater than 90° . In 1911. Rutherford proposed a planetary model of the atom, which exists in physics up to the present time [11]. In the center of the atom, according to this model, there is a very small positively charged nucleus with a diameter of 10^{-13} - 10^{-12} cm,

around which electrons orbit like planets around the Sun, so that the total size of the atom is of the order of 10^{-8} cm. The model developed by Rutherford allowed to solve a number of problems, but soon encountered fundamental difficulties associated with the fact that according to the so-called classical theory of the atom, the electrons, orbiting the orbit, experience acceleration and should have radiated energy and, having lost it, fall on the nucleus. However, this did not happen.

It is worth noting that in the mechanical planetary model of the atom there were actually no contradictions to which the so-called "classical" theory of electrodynamics led. If the electron really rotates in a circular orbit, it experiences not a longitudinal but a transverse acceleration, in which energy is neither given nor gained, and therefore is not obliged to emit anything at all. The resulting contradiction was merely evidence of the insufficiency of the "classical" theory of electrodynamics. Nevertheless, no attention was paid to it.

A way out of the situation was proposed by the Danish physicist N. Bohr [12-14], who *postulated the* existence of stationary ("allowed") orbits, and also that the atom radiates when the electron transitions from one stationary orbit to another, and the frequency of radiation is proportional to the difference of electron energies in these orbits. Bohr's theory allowed to resolve the main contradictions of Rutherford's planetary model.

The success of Bohr's theory, as well as previous successes of quantum theory, was achieved at the expense of breaking the logical integrity of the theory: on the one hand, Newtonian mechanics was used, on the other hand, artificial rules of quantization alien to it were used, moreover, contradicting classical electrodynamics. However, not everything in the behavior of the atom was explained by Bohr's theory.

The proof of the corpuscular character of light was obtained in 1922 by A. Compton [15], who showed experimentally that the scattering of light occurs according to the law of elastic collision of photons with electrons. The kinematics of such a collision is determined by the laws of conservation, as well as of momentum, and the photon should be attributed momentum (amount of motion) along with energy:

$$p = h\nu/c,$$

where ν is the frequency of the light wave and c is the speed of light.

The energy and momentum of a photon are related by the relation $E = cp$, which is true in ordinary mechanics.

Thus, it was proved experimentally that along with the known wave properties - interference and diffraction - light has corpuscular properties: it consists of particles - photons. In this manifests the dualism of light, its complex corpuscular-wave nature. The dualism is contained in the formula $E = h\nu$, because on the left side is the energy of the particle, and on the right side is the frequency of the wave. A formal contradiction arose: to explain some phenomena it was necessary to consider that light has a wave nature, and to explain others - corpuscular. In essence, the resolution of this contradiction led to the creation of the foundations of quantum mechanics.

In 1924 Louis de Broglie, trying to find an explanation for the conditions of quantization of atomic orbits postulated in 1913 by N.Bohr. In 1924, Louis de Broglie, trying to find an explanation for the quantization conditions of atomic orbits postulated by N.Bohr in 1913, put forward a hypothesis about the universality of the corpuscular-wave dualism [16]. According to de Broglie, each particle, regardless of its nature, should correspond to a wave, the length of which λ is related to the particle momentum p by the relation

$$\lambda = h/p.$$

According to this hypothesis, not only photons, but also all "ordinary particles" (electrons, protons, etc.) have wave properties, which, in particular, should be manifested in the phenomenon of diffraction. In 1927, C. Davisson and L. Germer first observed the diffraction of electrons [17, 18]. Later, wave properties were found in other particles, and the validity of de Broglie's formula was confirmed experimentally. However, it should be noted that another property of waves - interference - was not obtained for elementary particles of matter, so that the comparison of particles with waves turned out to be rather conditional.

In 1925. Heisenberg managed to construct such a formal scheme in which instead of coordinates and velocities of the electron there were abstract algebraic quantities - matrices, whose relation to observable quantities - energy levels and intensities of quantum transitions - was given by simple rules [19].

Quantum mechanics was supplemented in the form of Pauli's principle (1925), according to which there can be only one electron in each electronic state in an atom [20-23].

In 1926, M. Born gave a probabilistic interpretation of de Broglie waves [24]. He proposed to consider de Broglie waves as "probability waves", i.e., to give them a purely mathematical interpretation. In

n 1926 E. Schrödinger [25, 26] proposed an equation describing the behavior of such "waves" in external force fields:

$$\Delta\psi + \frac{8\pi^2m}{h^2}(E - U)\psi = 0.$$

This equation reflects the behavior of a point mass in a force field, but the motion of this mass is expressed not in coordinates, as it was usually accepted earlier, but in changes of total and potential energies. The ensemble of such masses expressed by the function ψ , according to the idea of the authors of quantum mechanics, no longer reflects the mass characteristics of a set of such elementary masses in space, i.e. the density of the medium, but represents "the probability density of finding a particle in a given point of space". Thus arose "wave mechanics", which was soon identified with quantum mechanics. The Schrödinger wave equation is the basic equation of non-relativistic quantum mechanics.

Atomic physics was developed by the methods of quantum mechanics, whose authors were W. Heisenberg and M. Born (Germany), E. Schrödinger (Austria) and P. Dirac (England). The ideas of quantum mechanics about the motion of microparticles are fundamentally different from the classical ones. Microcosm phenomena, as followers of quantum mechanics believe, fundamentally differ from macrocosm phenomena by the fact that they are quantized, discrete, i.e. discontinuous, while macrocosm phenomena are not quantized but continuous.

According to quantum mechanics, the electron does not move along a trajectory like a solid ball, it is spread throughout space, although it acts as a single unit. It is spread in space like a plane wave having a certain frequency and a certain wavelength. Its energy as a particle is related to its frequency and is defined by the expression $E = h\nu$.

The stable motions of the electron in the atom, as Schrödinger (1926) showed, correspond to standing waves whose amplitudes are different at different points. In this case, in the atom, as in an oscillatory system, only some "selected" motions with certain values of energy, momentum and projection of the magnetic moment of the electron in the atom are possible. Each stationary state of the atom is described by a wave ψ -function characterizing the distribution of the electron charge density in the atom. To this wave function was assigned the value of the probability density of occurrence

electron in a given point of space without designating any mechanism that ensures this process.

In the future these ideas were developed, supplemented, but did not change in essence, having survived to this day.

The final formation of quantum mechanics as a consistent theory with a coherent mathematical apparatus occurred after the publication in 1927 of Heisenberg's paper [19], in which the uncertainty relation was formulated. According to this relation, the coordinates and momentum of an electron cannot in principle be simultaneously determined with absolute accuracy.

In 1928, P. Dirac formulated a relativistic equation describing the motion of an electron in an external force field; this equation became one of the basic equations of relativistic quantum mechanics [27]. The main difference between the Dirac equation and the Schrödinger equation is that it takes into account the internal energy of matter (in accordance with the ideas of the theory of relativity) and the ψ -function itself is represented in a complex form of conjugate functions. The Dirac equation allowed to theoretically justify the formulas obtained empirically by spectroscopists, as well as to solve some questions of quantum mechanics with respect to systems containing only one electron. Dirac's equation made it possible to predict the existence of the positron, though with the involvement of new hypotheses leading to additional difficulties. After the discovery of the positron, Dirac developed a theory, although containing a number of poorly acceptable assumptions, but, nevertheless, perfectly explaining (in fact - describing) many experimental facts.

It is interesting to note that the main provisions of Dirac's theory are in sharp contradiction with those principles of construction of theoretical physics, which he himself defended together with other representatives of the Copenhagen school of physicists (Bohr, Heisenberg, Pauli, etc.), since Dirac closely connects his theory with a certain physical picture, the very fact of the possibility of obtaining this school was denied. But without this physical picture Dirac could not build his theory.

Dirac proposed the model of "electron-positron vacuum", in which in each point of space there exist in a "virtual" state electrons and positrons, which can appear and disappear only in pairs. The birth of a pair can take place under the action of photon energy, and can take place *virtually*, when after the

of vapor birth is immediately annihilated, having existed for a short time. And the vacuum itself is defined as photon vacuum, as the lowest energy state of the electromagnetic field.

One of the main difficulties of this representation of the vacuum is that the "electron jelly", as, according to Dirac, the vacuum is arranged, should densely fill the geometric space, and this to some extent resurrects the hypothesis of the ether, which is in contradiction with the provisions of Einstein's Special Theory of Relativity.

Within a short time quantum mechanics was successfully applied to a wide range of phenomena. Theories of atomic spectra, molecular structure, chemical bonding, Mendeleev's Periodic System, metallic conductivity and ferromagnetism were created. These and many other phenomena became qualitatively understandable, although no physical model representation was obtained.

However, further development of non-relativistic quantum mechanics was connected with replacement of a clear deterministic view of the nature of physical phenomena by probabilistic views. In contrast to classical mechanics the purpose of solving problems by methods of quantum mechanics became the establishment of probability of this or that event, than the very possibility of revealing their physical essence was completely excluded.

7.2. On some features of the philosophy of quantum mechanics

At all successes and universal recognition of methods of quantum mechanics it should be stated that all quantum mechanics is based on misunderstandings. Some authors, for example Prof. T.A. Lebedev [28], have drawn attention to it.

First of all, the statement that quantization of physical quantities is a property only of the microcosm is incorrect. In fact there are many quantum phenomena in the macrocosm, as well as phenomena, simultaneously manifesting corpuscular-wave properties.

An ordinary sea wave will affect the ship in different ways: as a wave, if the ship has a length smaller than the wave, and as a particle, if larger. In the first case, the ship will be rocked by the wave, in the second case it will be hit.

The trail of a moving ship is a so-called "Karman's path" - vortex formations arranged in a staggered order. Distance between the centers of vortices of one row

can be interpreted as a wavelength, but every vortex has mass, so it can be interpreted as a particle.

Ordinary waves can, of course, as quantum mechanics does, be considered from the standpoint of probabilistic relations, but this is not done in engineering practice because it is not necessary. And when statistical evaluations based on the probabilistic approach are applied, it is done out of convenience of material handling, not out of the condition of probabilistic arrangement of nature itself.

Planck's relation $E = h\nu$ does not apply only to the photon, the same relation is characteristic for gas vortices, as well as for a system of gas vortices, the total energy of which is inversely proportional to their diameter and distance between them.

Bohr's postulate states that there are stationary orbits of electrons corresponding to "allowed" energy levels. The frequency of radiation is found to be proportional to the difference of electron energies in the corresponding "allowed" orbits. According to quantum mechanics, such orbits are only those for which the momentum of the electron is equal to an integer multiple of $h/2\pi$. These postulates were subsequently confirmed experimentally. However, it is asked why such orbits exist at all and by whom are these or those energy levels allowed?

Therefore, it can be argued that the abstract-mathematical approach in quantum mechanics is not its advantage, but its disadvantage. Rutherford's planetary model is said to have encountered difficulties because, moving around the nucleus, i.e., with acceleration, the e l e c t r o n , according to classical theory, should continuously emit electromagnetic energy and fall on the nucleus, and this does not happen. The second difficulty is that the light emitted by the electron should increase its frequency as the electron approaches the nucleus, and in fact the electron emits electromagnetic oscillations of a perfectly definite frequency. The emission spectra were found to be linear, i.e., of strictly defined frequencies, and a number of regularities were established in them which contradicted the planetary model. However, it seems that this is also based on misunderstandings, although it is generally recognized.

First of all, the first conclusion shows only that the so-called "classical theory" is wrong, if it really predicts that an electron orbiting the nucleus must emit something. Of course, the electron, moving in orbit, has an acceleration, but this acceleration is not longitudinal, but transverse, centripetal. At

longitudinal acceleration changes the velocity, the energy for this must be either put into the accelerated object or taken away if the object is decelerating. This can be done by the environment in which the waves will propagate, contributing or taking away energy. If there is no environment, there is no reason for the electron to accelerate or decelerate. This would immediately imply that the model is incomplete. But with centripetal acceleration, the velocity and energy of the electron remain unchanged, and there is no reason for the absorption or emission of electromagnetic waves. The contradiction turns out to be far-fetched; it should not have been put forward as a sign of the incompleteness of the planetary model.

As for the second drawback, it does exist, but an abstract-mathematical approach is not sufficient to resolve it, as quantum mechanics did by introducing the relevant postulates, since they did not put forward any mechanism for what they denote.

First of all, it should be noted that the absence of any physical ideas about the internal phenomena of the microcosm makes them practically hardly predictable. Quantum mechanics owes its successes to "ingenious guesses", invented "principles" and numerous postulates, the substantiation of which leaves much to be desired.

Since quantum mechanics has existed for more than 70 years, one would expect that such its standard mechanism as the calculation of ψ -functions on the basis of the Schrödinger equations has long been mastered, and ψ -functions for all atoms and most molecules have already been worked out. It turns out that there is still nothing like this: *ψ -functions are* calculated only for relatively simple cases, and then there are numerous complaints about the complexity of their calculations!

Not all predictions of quantum mechanics have come true, for example, not all microobjects follow the "universal" principle of corpuscular-wave dualism. There is a complete absence of ideas about the nature of nuclear forces, about the nature of weak interactions and many other things. All this indicates that the methods of quantum mechanics to a large extent exhausted themselves and on this path is hardly possible further progress into the depths of matter. And all this is connected with the fact that quantum mechanics rejected the very possibility of existence of any physical mechanisms inside the phenomena of the microcosm, replacing the physical essence with abstract mathematics.

The ominous shadow of Einstein's special theory of relativity loomed over quantum mechanics, as well as over the whole of modern natural science, depriving it of the ability to operate

ether - the building material of microparticles and all kinds of force fields and interactions. For the absence of the building material deprived the researchers of the microcosm of possibilities to investigate the internal structures and mechanisms of interactions.

Despite the fact that the provisions of quantum mechanics are considered to be experimentally confirmed, it is unable to answer the question *why* all this happens, what is the mechanism of quantization of energy. Nor can it answer simpler questions, such as why in each atom the sum of the negative charges of the electrons is exactly equal to the value of the positive charge of the nucleus, or why a completely ionized gas soon becomes electrically neutral again, where do electrons reappear in each atom?

The authors of quantum mechanics and their followers excluded from consideration the internal mechanics, replacing intraatomic mechanism with probabilistic representations and never raised the question of the insufficiency of the planetary Rutherford-Bohr model itself. The shortcomings of the planetary model using one way or another the ideas of classical mechanics of that time, led to the fact that the theory of the atom began to develop an abstract-mathematical direction, which was presented by the authors as "revolutionary" and "revolutionary". which led to the creation of quantum mechanics.

The notion of physical vacuum, i. e. not empty void, because the word "vacuum" means void, raises questions to which quantum mechanics and its continuation - quantum field theory - are not able to give an answer. What is in general a "virtual" state of particles in vacuum at which they, having appeared, immediately annihilate? What is "immediately", how many microseconds and how many times per second does all this happen? What is the mechanism of such "virtuality"? What is the mechanism of vacuum participation in physical processes?

But the main question remains the question about the structures of material formations - from electron to atom, the question about the structure of vacuum and about all those atomic phenomena with which physicists somehow cope on the basis of mathematical abstractions, completely ignoring the physical essence of structures and processes.

By means of methods of quantum mechanics it is not possible to solve a lot of arisen problems of atomic and molecular physics. And though quantum mechanics as a tool of cognition of phenomena of the microcosm at first had certain successes, it should be stated that methods of quantum mechanics practically exhausted themselves, and there are no grounds to consider the situation in the science of the microcosm satisfactory.

Quantum mechanics preaches structurelessness of particles and absence of any reasons why particles have their properties - presence of magnetic moment, charge, spin, etc. Particles are point-like, i.e. they are dimensionless. And although this circumstance leads to the energy paradox, for some reason nobody is embarrassed by it. Nobody questions the initial planetary model of the atom, developed by Rutherford back in 1911 and due to its limitations led to a huge number of contradictions, although its successes at first were indisputable. Instead of studying specific structures and mechanisms of interactions, in the end everything was reduced to a purely external, very superficial description, which led to the consideration of only probabilistic assessments of processes. The matter came to the point that the very fact of the possibility of the presence of any mechanism in the phenomena of the microcosm began to be denied, the causal relations in the phenomena of the microcosm are also denied, thus imposing fundamental limitations on the cognitive capabilities of man.

Quantum mechanics can be retained in physics as a useful methodology as applied to calculations of specific intra-atomic processes, but the whole philosophy of quantum mechanics must be subjected to revision.

7.3. Hydromechanical interpretation equations of quantum mechanics

If we limit ourselves to the elucidation of the behavior of atoms and molecules as a whole in various conditions and environments, it is usually sufficient to know the laws and formulas of ordinary quantum mechanics, and the concepts of energy states of dynamical systems are introduced, which are described by the Schrödinger wave equation [25, 26].

As it is known, the Schrödinger dynamical systems differ from the Newton, Lagrangian and Hamiltonian dynamical systems in their aims and way of description. Newton's equations allow us to calculate the exact value of the coordinate and velocity of particles in systems with a given initial state. Lagrange, in order to calculate complex systems with many variables, proposed to make equations of motion of systems using the method of generalized coordinates. Hamilton developed the variational method, according to which an optimal trajectory can be found out of all variants of motion trajectories. Schrödinger proposed another way: to calculate for the system some function

coordinates and time (not the amount of motion or velocity), which is applicable for determining the coordinates of the system and finding possible dynamical quantities of quantum objects of the microcosm. It is considered that the mathematical formalism developed by Schrödinger and the wave function introduced by him are the most adequate mathematical apparatus of quantum mechanics and its applications. In Born's interpretation, this function is applicable for determining the coordinates of a system and finding possible dynamical quantities. However, it was later accepted that when using a dynamical equation of this type, one cannot hope to accurately describe the classical behavior of systems. In other words, the degree of accuracy that can be achieved in the description of the system behavior by methods of quantum mechanics is limited by the Heisenberg uncertainty principle [19, 29-31].

By applying the Schrödinger wave equation and some additional hypotheses, one can define a function of coordinates and time called the wave function, Schrödinger function or probability amplitude function. The square of the modulus of the wave function is interpreted as the probability density of the probability distribution of the coordinates of a given system. The equation is called the wave equation because it is a second order differential equation that has similarities to the wave equation of classical mechanics. It is considered that this similarity has only a formal meaning and therefore is not taken into account.

However, some researchers have found that some other interpretations of the provisions of quantum mechanics are possible. Thus, Eddington developed the definition of the mass of a particle represented by a wave or a wave packet as the result of integration over the whole three-dimensional space of the density attributed directly to the wave function with splitting along a nominally infinite wave front. Thus, in this case the wave function is treated as an ordinary physical density of some medium [32-34].

It should be noted that the Schrödinger equation describes ordinary oscillations of a particle of mass m . Indeed, the Schrödinger equation has the form:

$$\Delta \psi - \frac{8\pi^2 m}{h^2} (W - U) \psi = 0; \psi = \psi_0 \text{ e}^{i 2\pi W t / h}, \quad (7.1)$$

where W is the energy of the system; U is the potential energy of the system as a function of the location of the particle; m is the mass of the particle.

For one axis, the wave equation takes the form:

$$\frac{d^2\psi}{dx^2} + \frac{8\pi^2m}{h^2} [W - U(x)]\psi = 0, \quad (7.2)$$

reflecting the amplitude of oscillations of the function.

For an oscillator the potential energy is defined by the expression

$$U(x) = \frac{1}{2} k x^2 = 2\pi^2 m \nu^2 x^2. \quad (7.3)$$

Here ν is the frequency of oscillation; $k = 4\pi^2 m \nu$ is the elasticity coefficient of the system. Denoting

$$\lambda = 8\pi^2 m W / h^2; \quad a = 4\pi^2 m \nu / h, \quad (7.4)$$

we get

$$\frac{d^2\psi}{dx^2} + (\lambda - a^2 x^2) \psi = 0. \quad (7.5)$$

Solving (6.5), we obtain:

$$\lambda = \left(n + \frac{1}{2}\right) a^2; \quad U = \left(n + \frac{1}{2}\right) h\nu; \quad n = 0, 1, 2, \dots, \quad (7.6)$$

which physically means the spectrum of some stable oscillations in space and time.

It should be noted that the spectrum of stable oscillations is characteristic not only for the wave equation in the form (7.2). For example, for a string fixed at the ends, we have [35]:

$$\frac{\partial^2 u}{\partial t^2} + c^2 \frac{\partial^2 u}{\partial x^2} = 0; \quad u = 0 \text{ at } x = 0; x = 1. \quad (7.7)$$

The solution of this equation is as follows:

$$u = \sum_{k=1}^n a_k \sin \frac{k\pi x}{l} \cos \frac{k\pi ct}{l} \quad (7.8)$$

where

$$a_k = \frac{2}{l} \int_0^l f(z) \sin \frac{k\pi z}{l} dz \quad (7.9)$$

Here l is the length of the string; $f(x)$ is the distribution of initial perturbations along the string.

Thus, physically close systems are described by differently shaped expressions giving practically the same solutions.

Some authors have paid attention to the possibility of a hydromechanical treatment of the equations of quantum mechanics. Besides the above treatment of the ψ -function as a mass density of the medium proposed by Eddington [33, 34], investigations of this question were also performed by Madelung [36] and Bohm [37].

Madelung, after substituting the time factor into the Schrödinger equation, obtained:

$$\psi \left(\frac{8\pi^2 m}{h^2} U \psi - U \psi - i \frac{4\pi m}{h} \frac{\partial \psi}{\partial t} \right) = 0 \quad (7.10)$$

Assuming further

$$\psi = a e^{i\beta} \quad (7.11)$$

he found

$$\Delta a - a(\text{grad} \beta)^2 + \frac{8\pi^2 m U}{h^2} a - \frac{4\pi m}{h} a \frac{\partial \beta}{\partial t} = 0; \quad (7.12)$$

$$a \Delta \beta + 2(\text{grad} a \text{grad} \beta) - \frac{4\pi m}{h} \frac{\partial a}{\partial t} = 0. \quad (7.13)$$

At

$$\varphi = -\frac{\beta h}{2\pi m} \tag{7.14}$$

Madelung derived the equation

$$\operatorname{div} (a^2 \operatorname{grad} \varphi) + \frac{\partial a^2}{\partial t} = 0, \tag{7.15}$$

which has the character of a hydrodynamic continuity equation:

$$\operatorname{div}(\rho v) + \frac{\partial \rho}{\partial t} = 0, \tag{7.16}$$

in which a^2 acts as the mass density ρ and v acts as the $\operatorname{grad} \varphi$ with velocity potential φ .

In addition, Madelung derived the equation

$$\frac{\partial \varphi}{\partial t} + \frac{1}{2} (\operatorname{grad} \varphi)^2 - \frac{U}{m} - \frac{\Delta a h^2}{a 8\pi^2 m^2} = 0, \tag{7.17}$$

which exactly corresponds to the hydrodynamics equation for free vortex flow under the influence of conservative forces.

Forming the gradient and assuming $\operatorname{rot} U = 0$, we have:

$$\frac{\partial U}{\partial t} + \frac{1}{2} \operatorname{grad} U^2 = \frac{dU}{dt} + \operatorname{grad} \frac{U^2}{2} - \frac{\Delta a h^2}{a 8\pi^2 m^2}. \tag{7.18}$$

Here $\frac{\operatorname{grad} U}{m}$ corresponds to the ratio of f/ρ (force density κ

mass density); $\frac{\Delta a h^2}{a 8\pi^2 m^2}$ corresponds $\int \frac{\Delta P}{\rho}$ --as a function of the "internal" forces of the continuum.

Madelung draws attention to the fact that, in spite of the time factor, the eigenvalue solution of the Schrödinger equation is a picture of a stationary flow. Quantum states are thus interpreted as stationary flows in the case $\text{grad}\beta = 0$ or as some static formations.

In the case of stationary flow we have

$$W = -\frac{m}{2} (\text{grad } \varphi)^2 + U - \frac{\Delta a \hbar^2}{8\pi^2 m^2} \quad (7.19)$$

Let's

$$a^2 = \sigma; \sigma m = \rho, \quad (7.20)$$

then, pronormalizing

$$\int \sigma dV = 1, \quad (7.21)$$

we get

$$W = \int dV \left\{ \frac{\rho}{2} + \sigma U - \frac{\hbar^2}{8\pi^2 m^2} \sqrt{\sigma} \Delta \sqrt{\sigma} \right\} \quad (7.22)$$

The expression for energy (7.22) is the volume integral of the kinetic and potential energy densities.

Thus, it can be stated that the basic equation of quantum mechanics reflects stationary currents in the medium and, therefore, there is a fundamental possibility to construct a vortex model of electron shells of atoms as some stationary vortex currents. The construction of such vortex models, in turn, can raise the question about clarification of ideas about the structure of atoms and molecules and the necessity to clarify the equations of quantum mechanics.

Consider the emission of light by a hydrogen atom [38-41].

In 1885, Balmer concluded that the wavelengths of all lines in the visible part of the hydrogen spectrum can be described by a single formula

$$\frac{1}{\lambda} = R \left(\frac{1}{n_1^2} - \frac{1}{n_2^2} \right),$$

where n_1 and n_2 are integers; R is Rydberg's constant:

$$R = \frac{2\pi^2 m_e e^4}{ch^3} = 109737.3 \text{ cm}^{-1}; \quad (7.24)$$

where m_e and e are the mass and charge of the electron; c is the speed of light; h is Planck's constant. Taking into account the motion of the nucleus, $R = 109677.6 \text{ cm}^{-1}$. Bohr [12-14] showed that if the stationary orbit of the electron is taken as the one for which the value of the orbital quantity of motion is

$$L = \frac{nh}{2\pi} = \hbar n, \quad (7.25)$$

where n is an integer, the energy of such an electron is equal to

$$E = R'/n^2. \quad (7.26)$$

Hence, if an electron moves from one orbit to another, its energy changes by the value of

$$\Delta E = R' \left(\frac{1}{n_1^2} - \frac{1}{n_2^2} \right), \quad (7.27)$$

where n_1^2 and n_2^2 are integers.

If

$$R' = Rch, \quad (7.28)$$

then the formulas for the energy difference of different orbits in the Bohr model of the hydrogen atom and for the wavelengths of the experimentally observed hydrogen spectrum will be identical.

It can be shown that the same expressions are valid for vortex models of electron shells of atoms.

Independent propagation of waves in mutually perpendicular planes is possible along the surface of a vortex shell of spherical shape. Since the movement of waves in space is associated with energy loss, only standing waves will be stable, which means an integer number of waves along the circumference of the sphere.

A standing wave propagating at length l is described by the expression [35, 42-44]:

$$y = 2A_0 \cos\left(\frac{\pi nx}{l}\right) \sin \omega_n \left(t - \frac{l}{c}\right), \quad (7.29)$$

at each point where $nx = kl$ ($k = 0, 1, 2, \dots$), the amplitude of the standing wave reaches a maximum equal to $2A_0$, and at the points where $nx = (k + 1/2)l$, the amplitude drops to zero. For the hydrogen atom, the length l is the circumference length of the atom, i.e., πD_{30} , where D_{30} is the diameter of the electron shell.

If the modulus of the deviation of the vortex surface from its unperturbed surface is $2A_0$, then the modulus of the velocity of this deviation is $2A_0 \omega_n$, the acceleration is $2A_0 \omega_n^2$, the modulus of the inertial force is $2mA_0 \omega_n^2$. For all harmonic components of oscillations the inertial forces are equal to each other, i.e.

$$F = 2mA_0 \omega_n^2 = C_1 = \text{const} \quad (7.30)$$

or

$$A_0 = \frac{C_1}{2m\omega_n^2}. \quad (7.31)$$

Then at impulse

$$P = mv = 2mA_0 \omega_n = nC_2, \quad (7.32)$$

from
where

$$\omega_n = \frac{nC_2}{2mA_0}, \quad (7.33)$$

oscillation energy is described by the relation

$$\begin{aligned}
 E &= \frac{mv^2}{2} = \frac{4m A_0^2 \omega_n^2}{2} = \frac{m C_1^2 \omega_n^2}{2m\omega_n^4} = \frac{C_1^2}{2\omega_n^2} \\
 &= \frac{C_1^2 m^2 4A_0^2}{2 n^2 C_2} = \frac{R'}{n^2}.
 \end{aligned} \tag{7.34}$$

In this case, the difference of vortex surface vibration energies at changing the number of standing waves will be as follows:

$$\Delta E = R' \left(\frac{1}{n_1^2} - \frac{1}{n_2^2} \right), \tag{7.35}$$

which is exactly the same as Balmer's formula when $R' = hcR$.

Thus, the vortex model of the atom is consistent with the functional dependencies of quantum mechanics.

Planck's constant h is a coefficient of proportionality between the rotation frequency of vortex formation of the ether and its energy and is not a value peculiar only to the microcosm. The physical meaning of Planck's constant is that it is the portion of energy that must be communicated to an electron or other vortex particle to increase the rotation frequency by 1 s^{-1} :

$$h = \Delta E / \Delta v, \tag{7.36}$$

and to the value $\hbar = h/2\pi$ corresponds the increment of energy at increase of rotation speed by 1 rad/s.

Let us consider the principle of Pauli's prohibition. As is known, in 1925. Pauli introduced his prohibition principle, which is that two electrons are forbidden to be in the same state [20-22], or, in other words, one atom cannot contain two electrons having the same set of quantum numbers. This is largely a rule of classical mechanics, which states that two bodies cannot occupy the same place in space at the same time. When describing atomic systems, however, not only the eigen-coordinates of the body, but also the three momentum coordinates must be taken into account.

The peculiarities of the momentum coordinates account are largely clarified if we consider the interaction of electron shells and the individual electrons composing these shells with each other.

If from the probabilistic model it follows that point electrons can be in the same point of space but move in different directions, then from the ether-dynamic model it follows that in such common points neighboring vortices touch, and no contradictions arise at all.

Similar is the case with the so-called conservation laws. First of all, it should be noted that some conservation laws used in quantum mechanics coincide directly with the general laws of mechanics of the macrocosm, which, generally speaking, directly follows from the ideas about general physical invariants. Such laws are:

the law of conservation of energy:

$$W = \sum_{k=1}^n \frac{m v_{kk}^2}{2} + U(\mathbf{r}_1, \mathbf{r}_2, \dots, \mathbf{r}_n), \quad (7.37)$$

where U is the potential energy;

the law of conservation of quantity of motion (momentum):

$$P = \sum_{k=1}^n \frac{\partial L}{\partial v_k} = \sum_{k=1}^n m v_{kk} = \text{const}, \quad (7.38)$$

where function Lagrangian for closed system is defined by the expression

$$L = \sum_{k=1}^n \frac{m v_{kk}^2}{2} - U(\mathbf{r}_1, \mathbf{r}_2, \dots, \mathbf{r}_n); \quad \mathbf{v}_k = \frac{d\mathbf{r}_k}{dt}; \quad (7.39)$$

the law of conservation of momentum:

$$M = \sum_{k=1}^n [\mathbf{r}_k \mathbf{p}_k] = \sum_{k=1}^n [\mathbf{r}_k m \mathbf{v}_{kk}] = \text{const}. \quad (7.40)$$

The last expression for the vortex motion of the gas can be transformed as follows:

$$M = - \sum_{k=1}^n \frac{1}{4\pi} G m_{kk}, \quad (7.41)$$

where the vortex intensity

$$G_k = \int \mathbf{v} d\mathbf{l}. \quad (7.42)$$

Thus, all laws of quantum mechanics are fulfilled at all levels of organization of matter, and are not peculiar only to the microcosm.

The law of conservation of charge is also the law of conservation of momentum, but in a helical vortex.

A number of features that have always been considered inherent only to the phenomena of the microcosm, such as the corpuscular-wave dualism of microparticles, the Heisenberg uncertainty principle, and the probabilistic nature of the laws of the microcosm relatively, are not difficult to consider from the standpoint of the gas dynamics of the aether.

The corpuscular-wave dualism, underlying quantum mechanics, is the position that the behavior of microobjects exhibits both corpuscular and wave features. As it will be shown further at the analysis of concrete effects, vortex formations possess in their majority characteristic features of both particles and waves. Properties of particles are caused, first of all, by the fact that vortex formations are stable and localized in space, since they are separated from the rest of the medium by a boundary layer. The wave properties of weakly compressed vortices are due to the possibility of adding flows in vortices, as well as the wave properties of vortices in their interaction with other bodies, including vortices. For strongly compressed vortices some wave properties disappear, which is reflected in physical phenomena. Thus, for some particles the diffraction phenomenon is possible, but the interference phenomenon, characteristic for particles formed by vortices of weakly compressed ether, is impossible.

The *uncertainty principle* put forward by Heisenberg in 1927. [19], states the impossibility of simultaneous exact determination of the

coordinates of the center of inertia of the particle and its momentum. This position is based on the idea of the wave function (ψ -function) of the equation of quantum mechanics as the probability density of finding a particle in a given region of space. However, some researchers, as already mentioned, have shown that the ψ -function can be interpreted as the mass density of the medium in a given point of space, with integration over the entire volume giving the value of the mass of the particle. Such interpretation of the ψ -function is quite consistent with ether dynamics, since each particle is a vortex formation. In this case there is no place for the uncertainty relation and one can use the usual relations of mechanics taking into account, of course, the fact that the vortex formation has no clear boundaries. In many cases, however, vortex formations are separated from the medium by a boundary layer, allowing to define more clearly the boundary of vortex propagation.

The Heisenberg uncertainty principle in this case acquires not a principal, but a purely methodological meaning connected with the availability of the experimenter's specific measuring instruments. In the future, due to the appearance of new measuring instruments based not on the ideas of electromagnetic quanta, but on other ideas, this principle may lose its methodological significance.

Concerning the probabilistic character of the laws of the microcosm, we can note the following. In their basis such representations assume absence of internal mechanisms of phenomena and internal structure of particles, and also representations about invariability of particles in all time of their existence. Ignoring the peculiarities of particle structure leads to the idea of intensity as a probability of particles appearance in a given point of space. Meanwhile, weakly compressed vortices are characterized by the possibility of summation of intensities of elementary jets of gas (ether), which formed these vortices, i.e. a very specific mechanism is traced, in which the increase of intensities is connected with the growth of intensity of the total vortex. As a result, there are no grounds for the ideas about the probabilistic character of the vortices' behavior. And the analysis of interactions of vortices with each other allows us to create a completely deterministic representation of almost all phenomena of the microcosm.

Thus, all basic features of the microworld and equations of quantum mechanics describing the phenomena of the microworld can be considered from the positions of macroscopic gas mechanics underlying the dynamics of the aether.

7.4. structure electronic shells of atoms and molecules

As was shown above (see Ch. 6), the proton - a toroidal helical vortex of aether - forms around itself toroidal helical flows of weakly compressed aether, which are perceived as magnetic and electric fields of the proton. Such a system is stable and can exist for quite a long time.

If an additional boundary layer has formed around the proton, localizing the annular motion, such a system, the neutron, is also stable in the nucleus. However, a neutron torn out of the nucleus and left to itself is less stable and decays into a proton and an electron with a half-life of 11.7 ± 0.3 min [45]. The material for the creation of the electron is the boundary layer ether, which collapses into a particle being detached from the proton. However, the variant in which the boundary layer dissolves in the ether without forming an electron is also very probable.

There is also a third stable state of the proton, in which a secondary vortex is organized around the proton - the so-called "attached vortex" (a term introduced into aerodynamics by N.E. Zhukovsky). Such a vortex is obtained if the external flows of ether, previously closed through the central hole of the proton, are closed outward. In such a vortex, the circular motion will have the same direction as the circular motion of the proton, and the toroidal motion will have the opposite direction, so the sign of the helical motion and the attached vortex will be opposite to the sign of the helical motion of the proton, which will be perceived as the negative polarity of the electric charge of the entire attached vortex - the electron shell of the atom. Since the circular motion is entirely confined within this outer shell and does not penetrate into the outer region, the whole system is electrically neutral. This is how the hydrogen atom was formed (Fig. 7.1).

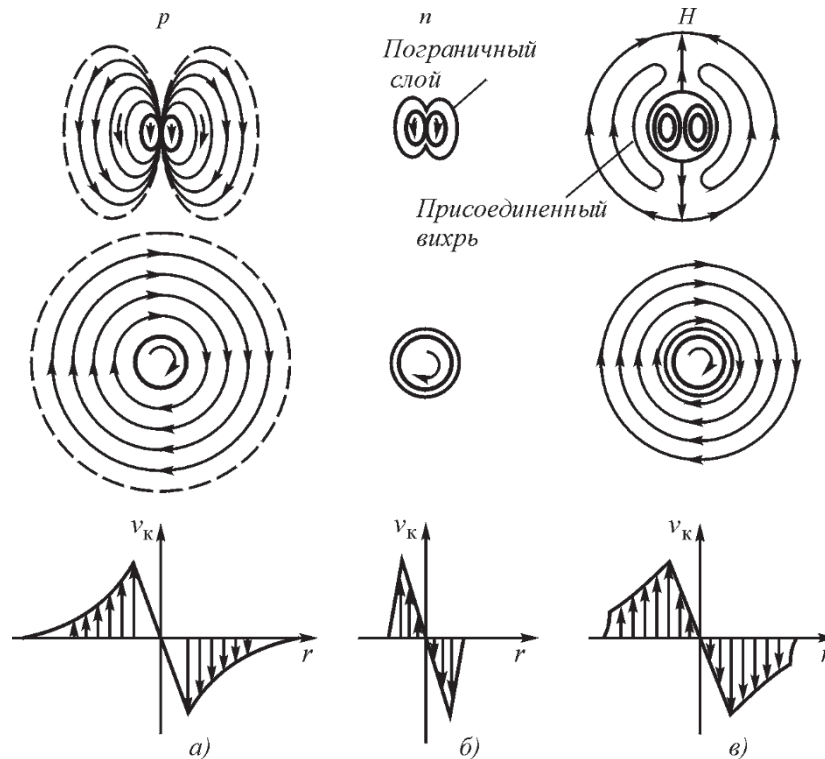

Fig. 7.1. Three stable states of the proton: *a* - the proton proper; *b* - neutron; *c* - hydrogen atom

In the attached vortex created in the hydrogen atom, the ether motion is maintained at the expense of the energy of the ether flows flowing from the proton, i.e. at the expense of the energy of the electromagnetic field of the proton. The energy of this field is drawn from the proton. Thus, the energy of the attached vortex - the electron shell - is drawn from the energy of the nucleus, and the whole system - the nucleus of the atom and its electron shell - is one whole, and it is only from such positions that it is reasonable to consider the atom further.

In principle, the secondary layers of ether can be involved in motion in two ways - by entrainment of adjacent layers of medium in the same direction as the primary flows, which is easily explained by the viscosity of gas, and by rotation of medium particles located on the surface of the vortex. In the first case mutually adjacent layers of ether move in the

in the same direction, in the second - in opposite directions. When one vortex is divided into two, the motion of the secondary vortex is maintained in the second way.

The flows of the medium in which the toroidal vortex is located, such as the spherical Hill vortex (Fig. 7.2) [46], can be similarly involved in the motion. The figure shows the formation of spherical attached vortices external to the Hill vortex, the first for the case of a smaller and the second for the case of a larger circumferential gas velocity; respectively, in the first case, the attached flows are directed in the same direction as the gas flow forming the spherical Hill vortex, while in the second case, they are directed in the opposite direction to this flow.

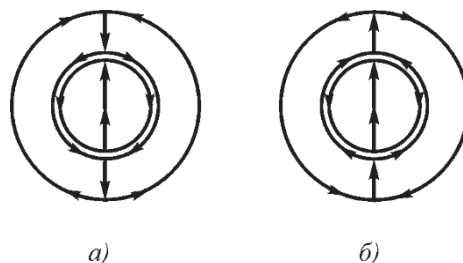

Fig. 7.2. Formation of the attached vortex: *a* - at entrainment of gas layers adjoining to the main vortex; *b* - at division of the main vortex

The case of multilayer toroidal motion of the medium for the first variant of the involvement of adjacent layers of the medium was considered by Taylor [47-49]. The shape of toroidal attached vortices is also close to spherical (Fig. 7.3).

There are many works devoted to the theory of rotating fluid and the appearance of closed vortices of various shapes, for example [47-52]. Of some interest is the approach to vortex formation from the point of view of the negative viscosity mechanism [52], which takes into account that vortices receive energy from a source external to the vortex. For secondary vortices, which are formed in atoms and which are perceived as the electron shell of atoms, such a source of energy is the atomic nucleus itself, more precisely, the protons that are part of the nucleus. The kinetic energy of protons is transferred first to the primary flows and then through them to the secondary vortices - the electron shell of atoms.



Figure 7.3. Taylor vortex

Considering the atom as a complete system, it has to be stated that the independent construction of the tables of filling of energy levels in nuclei and in electron shells, used nowadays [53-60], is not quite legitimate. And although among the numerous works on the construction of periodic systems of elements there are quite interesting and original constructions [61-63], based on the quantum approach, still these works are of formal, not physical character and, most importantly, do not take into account the unity of the nucleus-electron shell system. In this sense, attempts to take this unity into account are interesting [64, 65].

In the light of the above it is expedient to trace the connection of the structure of the attached vortices - electron shells of atoms with the mathematical apparatus of quantum mechanics. The problem is considerably simplified if we take into account Eddington's remark about the possibility of attributing to the ψ -function directly the value of the physical density [33, 34]. In this case, the extrema of the ψ -function will correspond to the rotation centers of the attached vortices, and the zero values will correspond either to the contact points or to the vortex boundaries. It should be taken into account that the internal density of vortices does not necessarily correspond exactly to the character of the vortices ψ -function, which is no more than a rough approximation of the density dependence on coordinates.

In view of the above, we can propose a simple interpretation of quantum numbers in the atom: n - principal quantum number; l - orbital quantum number; m - magnetic quantum number in the wave function in polar coordinates

$$\psi_{nlm} = R_{nl}(r)\theta_{lm}(\theta)F_n(\varphi) = R_{nl}(r)Y_{lm}(\theta, \varphi); \quad (7.43)$$

these numbers determine the position of attached vortices (electron orbitals) in the atom. The fourth quantum number s - spin determines, probably, the orientation of the attached vortex (direction of the momentum vector) relative to other attached vortices.

If the unexcited state of atoms is maintained by energy coming from the nucleus, the excited state arises due to energy entering the electron shell from outside, for example, as a result of collision of atoms, absorption of photon energy, etc. Absorption of external energy leads to the reconfiguration of secondary vortices and even to the appearance of new secondary vortices or destruction of part of the existing ones, as a result of which the internal flows coming directly from the nucleus break through to the outside, which creates the effect of ionization of the atom.

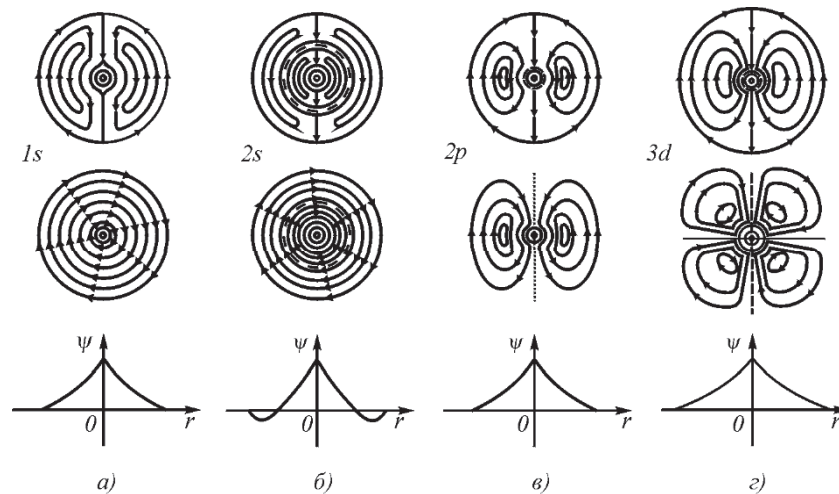

Figure 7.4. Hydrogen atom in different states

Fig. 7.4 shows the different states of the hydrogen atom, and the constructions are made on the basis of consideration of the corresponding ψ -functions.

The closure of the toroidal helical flow outside the proton leads to the appearance of a spherical vortex external to the nucleus, which corresponds to the hydrogen atom in the 1s state (Fig. 7.4, a). State 2s

(Fig. 7.4, *b*) is formed by enlarging the outer layer and dividing it into two. Here two variants are possible - a simple division of the vortex into two with formation of an increased velocity gradient between the vortices and formation of a second vortex in such a way that at the points of contact of these external vortices the flows are directed in one direction. It is reasonable to pay attention to the complete antiparallelism of the contacting vortices.

The states $2p$ and $3d$ (Fig. 7.4, *c* and *d*) are obtained as a result of the formation of loops in the circular motion: at two loops, the state $2p$ is obtained, and at four loops, the state $3d$ is obtained. The figures show the directions of ether flows in all states of the hydrogen atom.

In the nucleus of a helium atom there are two antiparallel oriented protons, which corresponds to two hydromechanical helical doublets. Fig. 7.5 shows the ether flows encompassing the helium nucleus and the electron shell vortices attached to them. As can be seen from the figure, both primary and secondary vortices are in antiparallel orientation relative to each other. Consequently, the magnetic moment and spin of the helium atom should be zero, which is actually the case.

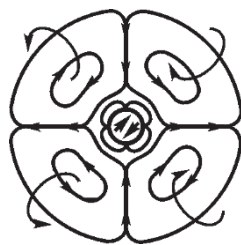

Figure 7.5. Structure of the helium atom

It should be noted that an increase in the number of doublets (sources of vortex currents) does not necessarily increase the volume of the atom. In the case of a helium atom, this volume will be reduced compared to the volume of a single hydrogen atom. This is explained by the fact that a proton in a hydrogen atom blows out a flow within a solid angle of 4π , while in a helium atom each proton blows out a flow into a solid angle half as large, i.e., an angle of 2π . This means that the velocities of ether flows in the helium nucleus are greater and according to Bernoulli's equation the pressure of ether in these flows will be less, the external pressure will compress the whole vortex, and the volume of the atom will decrease by a factor of 2.

The addition of a proton to the helium nucleus (lithium) breaks the symmetry of the shell, which leads to an increase in its volume. From the point of view of the shell structure, various variants are possible. One of them, in which a third asymmetric lobe is formed in the electron shell, is shown in Fig. 7.6.

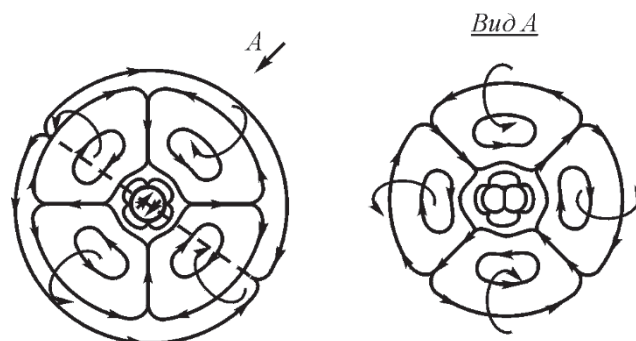

Figure 7.6. Structure of the lithium atom

Proton attachment to the lithium nucleus causes the protons to reorient into a quadrupole system. Filling goes by joining to the alpha-particle of the outer layer, thus a system of four doublets arises. Taking into account the proximity of the exit of the ether flux from the center of the external protons to the entrance of the flux into the internal protons, it can be assumed that these fluxes are switched on sequentially, resulting in only two exit fluxes, the power of each of which is doubled. This doubling of the flux power leads to an increase in the power of the attached vortices. As a result, the most probable structure of the electron shell is a two-layer structure with antiparallel vortices of the outer layer with respect to the inner layer (Fig. 7.7).

If we consider the structure of the nucleus of the oxygen atom, it is easy to see that according to the filling levels of the nucleus two internal protons in two opposite alpha-particles appear to be shielded by external layers, since the central helical fluxes of these protons are blown inside the nucleus. However two internal protons of two other alpha-particles blow out their fluxes outside, and, since the helical factor of all these fluxes is the same, it is possible to redistribute the fluxes inside the nucleus and to summarize the powers of two fluxes. Thus, in total, there are six outflows from the oxygen nucleus

helical flows, two of which have double power. As a result, four attached vortices of single and two of double power are formed (Fig. 7.8).

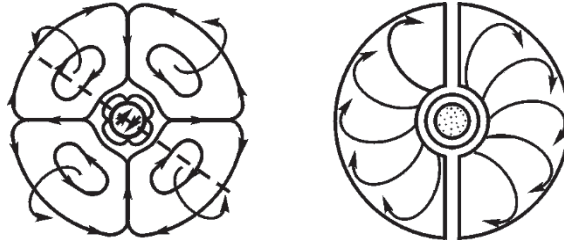

Figure 7.7. Structure of beryllium atom

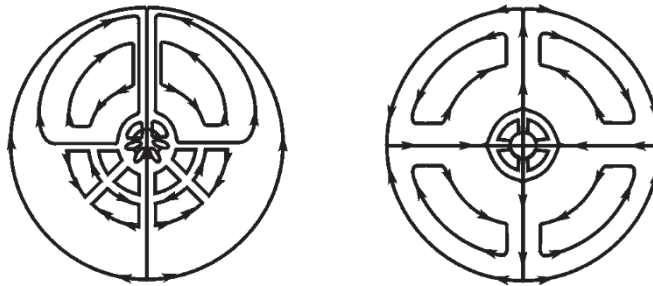

Figure 7.8. Structure of the oxygen atom

The stated representations lead to the fact that the number of output streams of ether from the nucleus can be less than the number of protons, but the total power of all streams is proportional to the number of protons. Further increase of the number of protons in the nucleus should lead not only to an increase in the number of helical jets coming from the nucleus, but due to shielding of some protons by others and to an increase in the power of some jets. This is accompanied in the outer shell either by an increase in the power of the corresponding attached vortex or by an increase in the number of attached vortices to the corresponding jet, which corresponds to an increase in the number of electrons in the electron shell of the atom.

Thus, an increase in the atomic number of the nucleus leads to a rearrangement of the electron shells of all levels, not only the outer shell. The construction of the whole shell system and the determination of the relationship between the structure of nuclear and electronic shells of the atom are the subject of a special study.

The vortex models allow us to suggest the reasons for the periodization of atomic volumes with the increase of their order number.

As is known, the volume of the helium atom is half the volume of the hydrogen atom. This is usually explained by the fact that the double charge of the nucleus pulls each electron closer to the nucleus than the single charge of the hydrogen atom nucleus. From the point of view of gas dynamics, the reason may be that the solid angle occupied by the ether flow of each proton is $\pi/2$ in helium, while in the hydrogen atom it is π . This means that the velocities of the ether streams in the electron shell of the helium atom will be greater, hence the pressure in them will be less, and the external pressure will compress the atom exactly twice its volume. In the next atom - lithium the third proton is located so that the symmetry of the atom is broken and the volume increases. But already in the fourth element - beryllium symmetry is restored, and the volume again decreases. Presumably, in the following elements the volume of atoms should depend on the degree of symmetry breaking: with increasing asymmetry the volume of atom increases, with approaching to the volume symmetry the volume of atom decreases.

7.5. Formation of molecules

Let us consider the nature of chemical bonds of atoms in a molecule [66-68]. The attached vortices of different atoms can be connected in only two ways (Fig. 7.9).

In the first case (Fig. 7.9, *a*), the vortices are held relative to each other in a common boundary layer formed due to oppositely directed ether flows. As shown above, due to the velocity gradient between the vortices, the pressure decreases and the external pressure of the aether presses the vortices against each other. Any transformation of vortices, except for the change of their shape, does not occur here. This case corresponds to ionic chemical bonding.

In the second case, the connection of two vortices gives a single vortex (Fig. 7.9, *b*). In helical flows, this is possible only when their helical factors coincide. This means that in the connected vortices both toroidal and annular motions must have the same motion

direction in the joining plane. Then a single attached vortex is formed, covering both joined atoms. In this common attached vortex, the pressure is less than in the environment, and the flux length is less than the sum of the flux lengths in both attached vortices of the individual atoms. This case corresponds to a covalent bond.

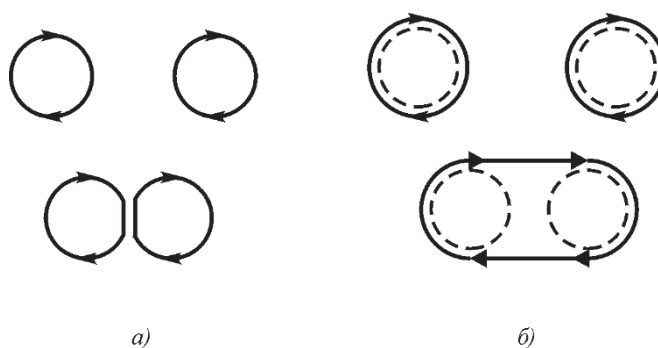
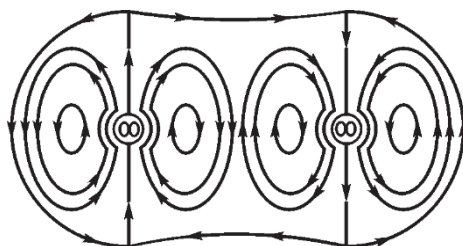
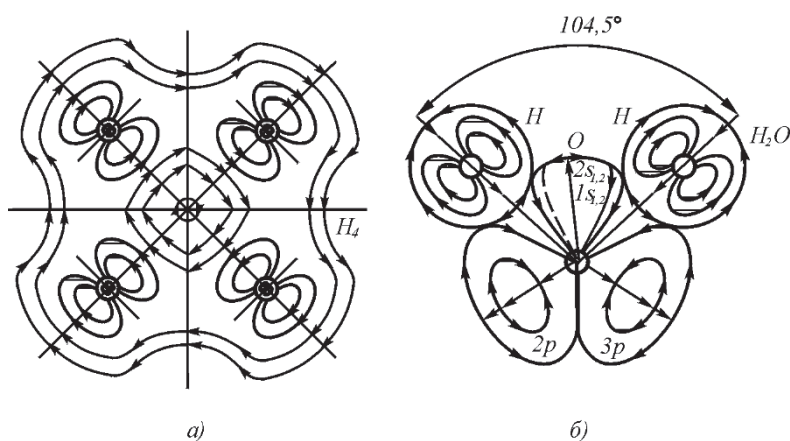

Fig. 7.9. Connection of vortices: *a* - by sticking to each other (corresponds to ionic bonding); *b* - by formation of common flows (corresponds to covalent bonding)

The above suggests the possibility of ionic bond formation at any helical factors in the attached vortices, if the reacting molecules have ether streams on their surfaces oriented antiparallel on a sufficient area. For the covalent reaction the same helical factor is obligatory.

The principle of molecule construction is best illustrated by the example of the molecule H_2 (Fig. 7.10). Different variants of construction of the molecule H_2 are possible - with parallel and antiparallel spins of protons, perpendicular and coaxial to the axis passing through the centers of protons.

As can be seen from Fig. 7.10, the external fluxes have the same direction in both toroidal and annular motion. It is this case that should be considered as the main case of the formation of the molecule H_2 . The formation of a common external flux indicates the covalence of the chemical bond, which is what actually takes place. The structures of other molecules can be obtained in a similar way (Fig. 7.11).

Fig. 7.10. Formation of H molecule₂Fig. 7.11. Structure of hydrogen molecules H₄ (a) and water H₂ O (b). electron shells - attached vortices 1p and 4p lie outside the plane of the figure and therefore are not shown.

A detailed study of the forms of bonding in molecules in the ether-dynamic model is the subject of a special study, but some additional considerations can already be made.

Since at the formation of a covalent bond the total current line of the common attached vortex turns out to be shorter than the sum of the lengths of the current lines of the separate atoms, at the moment of formation of a covalent chemical bond a part of the compacted screwed ether turns out to be thrown out of the molecule. Such a piece of vortex cannot exist in the same form, and it will either be absorbed elsewhere,

where the decomposition reaction of molecules takes place, or is transformed into a toroidal vortex of weakly compressed ether, which can be conditionally called a lepton, since its mass is less than that of an electron. The calculation shows that the mass of such a toroid is of the order of 0.0001 electron mass, but its diameter is of the order of 0.01 mm. To verify this fact, a laboratory experiment was organized (Fig. 7.12).

Special torsion scales were built, on one of the arms of which was fixed an aluminum plate (sail), connected to the metal body of the scales through a 10-meg resistance to avoid possible influence of electrostatics. The body of the scales was grounded to the steam heating battery.

A plastic cylinder was placed against the sail at a distance of 10 cm. Dry alkali KOH and concentrated sulfuric or hydrochloric acid reacted.

During the reaction, the sail was first attracted to the reaction and then, after the reaction was over, moved away from it to the maximum distance (up to the stop) and after 1.5-2 h. returned back.

The same result was obtained if the reaction was carried out in the same beaker placed on a wooden or foam cube away from the scales. Bringing then this cube to the scales gave the same result. Everything was recorded by an automatic recorder.

The explanation of the experimental results is that during the chemical reaction and the formation of lepton foam the leptons touch the sail. Since the ether motion on the surface of leptons at any orientation is always parallel to the plane of the sail, a gradient of ether velocities with reduced pressure is formed. The sail begins to be attracted to the reacting substances.

After the end of the reaction the lepton foam begins to diffuse, and first of all the leptons in the upper layer of the foam are destroyed, since the velocity gradient on their surface is smaller than that of the internal leptons, hence the viscosity is higher and the time of existence of surface leptons is shorter. But leptons, as well as any vortices, had the density of the ether higher than the density of the ether in free space. Therefore, the pressure of the aether increases and the sail moves away. After all the leptons have diffused, the pressure in the aether equalizes, and the spring returns the balance arm to its original state. Different substances give different deviation, but the character of behavior of the scales is conserved.

Experiments with "lepton foam" were continued by Y.D. Lobarev, a student of the Moscow State University Chemistry Department. He discovered that

"lepton foam" leads to a decrease in the sensitivity of photographic paper, as well as the fact that the capacitors located near the beaker in which the chemical reaction was carried out, in the first seconds after the reaction starts, increase their capacitance by almost 1%, and then, after the end of the reaction, there is a slow, within tens of minutes, return of the capacitance value to the original value.

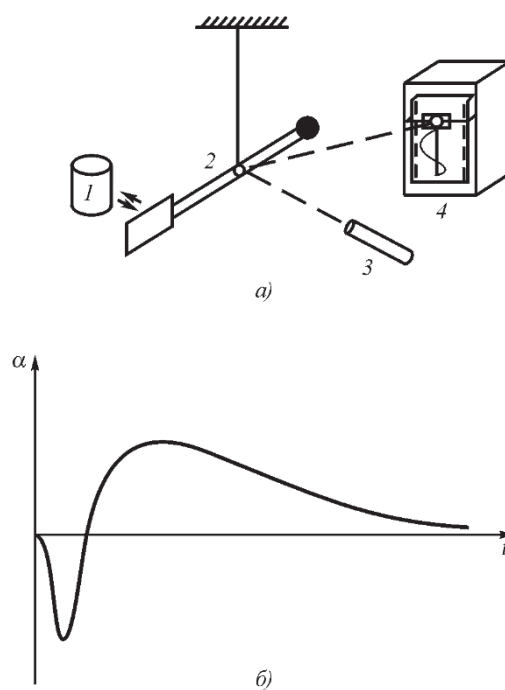

Fig. 7.12. Schematic diagram of the laboratory experiment to detect lepton foam during the formation of a covalent chemical bond (a) and a graph of the deflection of a pair of scales during a chemical reaction (b):

1 - beaker with chemical reagents; 2 - torsion scales; 3 - laser;
4 - Self-described.

7.6. Formation of intermolecular bonds

Although all molecules are electrically neutral, in matter they interact with each other. The extent of this

interaction is different: in a solid it is maximal, in a liquid it is average, and in a gas it is minimal.

Intermolecular interaction is the interaction between electrically neutral molecules or atoms, which determines the existence of liquids and molecular crystals, the difference between real gases and ideal gases and is manifested in a variety of physical phenomena. Intermolecular interaction depends on the distance between molecules and is described by the potential energy of interaction $U(r)$ (intermolecular interaction potential). It is the average potential interaction energy that determines the state and many properties of a substance.

The Dutch physicist J.D. van der Waals first took intermolecular interaction into account in 1873 to explain the properties of real gases and liquids [69-71]. He assumed that at small distances repulsive forces act between molecules, which are replaced by attractive forces with increasing distance. On this basis, he obtained the equation of state of a real gas.

It is currently accepted that intermolecular interactions are electrical in nature and consist of attraction forces (orientational, induction and dispersion forces) and repulsion forces. Orientational forces act between polar molecules, i.e., possessing dipole electric moments. These forces arise due to the fact that the distances between charges with different charges are much smaller than those with the same charges. Induction forces act between polar and non-polar molecules due to the fact that the polar molecule polarizes the non-polar molecule. Dispersion forces act between non-polar molecules and arise from the fact that although on average the molecules are not polar, at every instant they are still polar. That, on average, creates a corresponding attraction effect. All three types of attraction forces decrease with distance in proportion to the 6th power of the distance between the molecules.

Repulsive forces occur at very small distances when the filled electron shells of the atoms that make up molecules come into contact. These forces decrease with distance in proportion to the 13th power of the distance.

However, all this is a model, mainly a mathematical dependence of the intermolecular interaction forces on distance, which sheds little light on the true nature of these forces. Hence the difficulties with the calculation of these forces and with experimental measurements of intermolecular forces.

On the basis of the above etherodynamic concepts, assumptions can be made about the nature of the van der Waals forces, i.e., the forces responsible for intermolecular interactions.

From the point of view of ether dynamics, the forces of intermolecular interaction are due to the fact that the electron shells - the first ether vortices attached to the nuclei - are joined by the second attached vortices, which will be justly called van der Waals shells, since they are responsible for the creation of the forces of intermolecular interaction (Fig. 7.13).

Just as the helical velocity field of the ether created by the proton leads to the appearance of the attached vortex - the electron shell, in the same way the helical flows of the ether on the surface of the electron shell cause helical movements of the ether in the surrounding space. As a result, a second attached vortex is formed, the size of which is 4-5 orders of magnitude larger than the size of the electron shell. If nucleons, having critical density, cannot penetrate into each other, but only join in the nucleus, adjoining each other by side surfaces, then already ether vortices of electron shells are able to interact by unification, however, not penetrating into each other. The second attached vortices have small density and are able to penetrate into each other. As a result, a variety of helical flows are formed in the vicinity of the electron shells, once in which atoms and molecules are kept in them due to velocity gradients. Thus, the nature of intermolecular forces - van der Waals forces - consists in the reduction of pressure in the ether due to velocity gradients of flows in the second attached vortices - van der Waals shells.

If the diameter of the atomic nucleus is about $5 \cdot 10^{-15}$ m and the diameter of the electron shell is about 10^{-10} m, then the diameter of the van der Waals shell must be on the order of 10^{-5} m or about 10 μm .

Inside such a shell of each atom can fit about 10^{15} of other atoms. Consequently, all van der Waals shells will be repeatedly mixed with each other and form a single system.

Let us consider the distribution of velocities of ether flows and the distribution of ether density in these flows for one van der Waals shell. It should be taken into account that the drive belt for this shell is the aether fluxes of the surface of the first attached vortex - the electron shell of the atom.

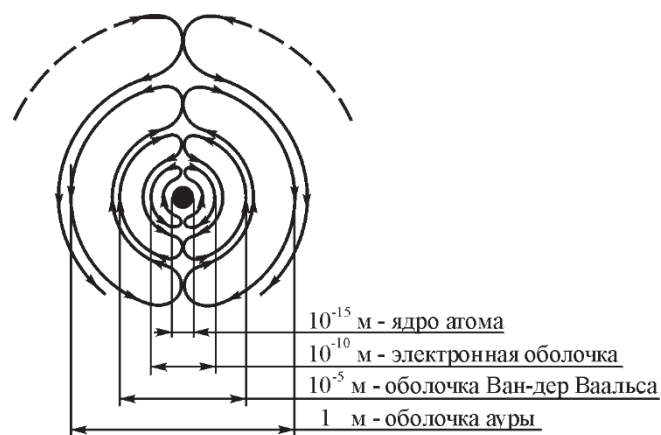

Fig. 7.13. Formation of the **2nd** attached vortex - van der Waals shell and subsequent attached vortices - aura of the **1st** kind

After the first attached vortex has excited the ether motion in the neighboring region by its flows due to the viscosity of the surrounding ether, this motion will close on itself, forming the second attached vortex. Since the diameter of the inner hole of the second attached vortex is five orders of magnitude smaller than the outer one, the velocity and density of the ether in the inner layers should be many times higher in this region than in the outer part. Correspondingly higher will be the gradient of the velocity of the ether flows.

This would not be the case if the vortex existed by itself, then the maximum flow velocity would be in the same area but in the interior of the vortex. However, the motion here is transmitted externally, so as the vortex moves away from the wall, the flow velocity will fall in proportion to the second degree of distance, since the vortex is toroidal, and the cross-sectional area increases in proportion to the square of the radius, and the velocity gradient will decrease in proportion to the cube of the radius. The aether density in this flow will also decrease in proportion to the square of the radius. Another degree of decrease will be added by the drop of the ether pressure to the center of the same vortex. If a second molecule or atom enters the second attached vortex, the distribution of pressures inside this vortex will shift them to the inner boundary of the van der Waals vortex, since the total pressure of the aether flows is less on this side. The force of attraction, i.e. the force,

directed from the center of the molecule to the boundary layer will be determined by the expression

$$F_y = \chi \rho S dv/du, \quad (7.44)$$

where χ is the dynamic viscosity coefficient of the ether; ρ is the density of the ether in the wall of the second attached vortex; S is the interaction area of molecules; dv/du is the velocity gradient in the near zone of the second attached vortex.

It turns out that the decreasing of the attraction force is proportional to approximately the 6th degree of the distance between the molecules, which is what happens in reality. Thus forces of interaction with ether flows on opposite sides of the interacting molecules will be small due to the high degree of decrease and will not essentially affect the total force of attraction of the interacting molecules.

Interacting molecules are set at some equilibrium distance from each other. Attempts to bring them closer together and move them to the boundary layer between the vortices cause repulsive forces. These forces are caused, firstly, by the same reasons as above, with the difference, however, that in the boundary layer the distribution of the velocity of flows, gradient and density of ether flows have the opposite sign and are directed to the centers of molecules, and secondly, by increasing pressure in the boundary layer, in which the first attached vortex - the electron shell of an atom - drives the ether external to it. Reduction of the flow cross-section causes, on the one hand, an increase in the pressure of the ether due to its compression, and, on the other hand, its heating for the same reason, which also leads to an increase in the pressure in this region. At the same time the forces of attraction will fall, as the interacting molecules will leave the vortex zone and get into the boundary layer, in which the velocity distribution will also contribute to their repulsion. Therefore, the degree of dependence of the repulsive force on distance here will be higher than the degree of dependence of the attractive force in the body of the second attached vortex.

Of undoubted interest is the formation of bonds that can be conventionally called aggregate bonds, a type of bonds that provide the connection of molecules into some aggregate set. The structure of this type of bonds can be traced on the example of joining water molecules into aggregates (Fig. 7.14).

Aether currents excited by the surfaces of two protons coupled to an oxygen molecule are directed into the external

relative to the water molecule, the space at some angle to each other. As a result, conditions are created for the formation of a double-stranded vortex - two helical vortices wrapped around each other. At some distance, the vortices forming the double-stranded vortex diverge and further return to the protons. At the places where the vortices turn, they form "pockets" - regions of reduced ether pressure, which probably accounts for the properties of water as an almost universal solvent (Fig. 7.14, a).

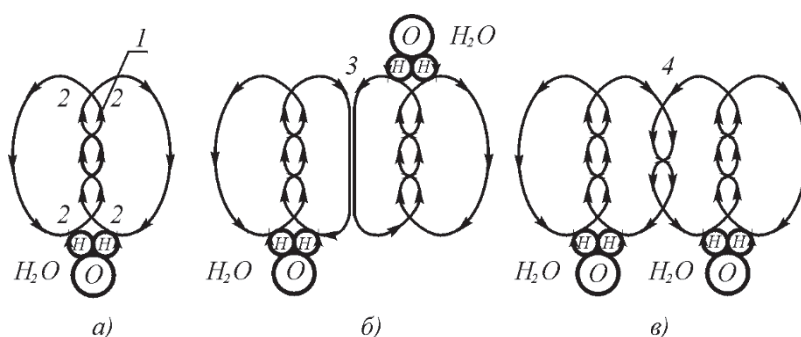

Fig. 7.14. Joining of water molecules into aggregates: *a* - formation of ether streams by protons of a water molecule; *b* - "quasi-ionic" joining of water molecules; *c* - "double-stranded" joining of water molecules. *1* - zone of double-stranded connection of external ether streams created by surfaces of hydrogen atoms; *2* - "pockets" of reduced pressure; *3* - adhesion of surfaces of attached ether streams in "quasi-ionic" connection of water molecules; *4* - double-stranded connection of attached ether streams of water molecules.

The formation of a birefringence in the intermolecular space leads to the fact that the outer sides of the ether flows acquire a convex shape. To these external streams can join the same external streams of other molecules, and such connections can be different. One type is similar in its character to the type of ionic bonds, which are formed by adhesion of the surfaces of the streams to each other, in this case the direction of the streams and, accordingly, the orientation of the molecules will be antiparallel - "quasi-ionic" connection (Fig. 7.14, *b*). The second type is the type of bonding in which the side streams form a common stream, this type will be similar to covalent bonding (Fig. 7.14, *c*) - "quasicovalent" bonding. The third type, in which the side streams of parallel molecules oriented in space also form birefringence,

which makes the bonds between molecules the most stable, - "double-stranded" connection (Fig. 7.14, *c*). All these types of bonds can be formed not only along the lateral, but also along the end portions of the streams, and in a very different combination. The limitation in the number of molecules forming an aggregate is due to the fact that as the number of molecules combining into an aggregate increases, the shape of the ether streams of the outer molecules of the aggregate becomes more and more convex, and the binding energy of these streams with other molecules becomes less and less, and new molecular attachments become more and more unstable. As the temperature increases, such bonds become less and less stable until finally only single molecules remain. At that point, a vapor is formed.

7.7. Heat and aggregate states matter

The nature of heat in gas, liquid and solid can be readily ascertained by considering that liquid and solid bodies placed in a gas medium acquire the same temperature as the gas.

As is known, the temperature of a gas is the kinetic energy of one gas molecule expressed through the average speed of thermal motion [72, p. 32]:

$$T = \frac{mv^2}{3K}, \quad (7.45)$$

where m is the mass of one molecule; v is the average velocity of its thermal motion, i.e., the average velocity of translational motion in space; $k = 1.38 \cdot 10^{-23} \text{ J.K}^{-1}$ is the Boltzmann constant, a value that is actually the inverse of the coefficient of proportionality between the adopted temperature scale and the kinetic energy of a gas molecule.

The interaction of gas molecules with each other will be different depending on the degree of ionization of the gas. If the gas is neutral, each molecule has the first attached vortex, the electron shell. Since this vortex is closed, centrifugal forces will drive the amers to the periphery of the vortex and a compacted wall will form across its surface; the outer side of the wall forms the surface of the molecule. At collision the molecules will collide

by these very walls, which will elastically deform and then straighten, throwing molecules away from each other with the same speed with which they came into contact.

If ionized molecules collide, they will no longer have an attached vortex. The ions will have to overcome mutual electric repulsion. At a temperature of $+ 20^{\circ} \text{C}$ such repulsion will occur at a distance of $3.6 \cdot 10^{-8} \text{ m}$, at a temperature of 1000°C - at a distance of $8.5 \cdot 10^{-9} \text{ m}$.

A gas molecule hitting a solid body actually hits the surface of the electron shell - the wall of the first attached vortex. The wall of the first attached vortex has essentially higher density than the rest of the vortex body and is actually a solid and elastic body, something like the shell of an elastically inflated balloon. The impact on the surface deforms the whole shell and transfers the perturbation to the nucleus, as well as to the opposite edge of the shell and further through the van der Waals shells to other molecules.

Since the elasticity of intermolecular bonds is much smaller than the elasticity of the electron shell, in the first approximation we can consider that the main elasticity of the vibrating system is the elasticity of intermolecular bonds, and the main oscillating mass is the whole mass of the molecule.

As follows from the modern theory of heat, the temperature of a solid body is determined by the oscillations of a molecule of this body relative to other molecules. The elastic bonds involved in these oscillations are considered to be the bonds between molecules. The etherodynamic ideas of the essence of heat do not diverge in their basis from the generally accepted ones, but somewhat clarify this process itself.

The diameter of the first attached vortex is more than 4 orders of magnitude larger than the diameter of the nucleus, hence its volume is at least 12-13 orders of magnitude larger than the volume of the atomic nucleus. Its mass is 3700 times less. Consequently, the density of the shell is on average not less than on

16 orders of magnitude less than the density of the atomic nucleus. It should be added that the main mass of the electron shell itself is concentrated near the nucleus, not on its surface. Therefore, the density of surface layers is at least 20 orders of magnitude less than the density of the atomic nucleus. The shock of a gas molecule is distributed over its cross-sectional area; with a diameter of about 10^{-10} m , this area is about 10^{-20} m^2 , while the area of the atomic nucleus is about 10^{-30} m^2 , or a value 10^{10} times smaller. Despite the fact that the density is so small, it appears to be sufficient to

to provide the necessary elasticity of the walls. At the same time, vibrations must also occur in the electron shell itself, the energy of which, in principle, is a small fraction of the vibrational energy of the entire molecule at intermolecular bonds (Fig. 7.15).

Based on the above, it is possible to determine the mechanism of transition of substances from one aggregate state to another.

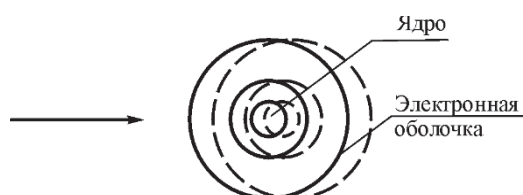

Fig. 7.15. To the mechanism of heat propagation.

The increase in the amplitude of molecule vibrations leads to an increase in the distances between them and their shift in the van der Waals shell to the region of smaller gradients of ether fluxes and lower density. The forces of intermolecular interaction weaken and become insufficient for rigid holding of molecules in the former position. Molecules can now slide relatively freely relative to each other, but to break out of the general system of ether flows molecules can not yet, their energy is still insufficient. But with further increase of temperature the amplitude of oscillations of molecules increases, and they repel each other more and more intensively, overcoming the force of residual interaction. Those of them, at which the amplitude of surface waves is large enough, are able to escape from the secondary attached vortices of other molecules. A vapor or gas is formed.

It is not difficult to see that both for rearrangement of ether flows in Van der Waals shells at transition of substance from solid to liquid state, and for rearrangement of the same at transition of substance to vaporous or gaseous state additional energy is needed, which received the name of heat of melting in the first case and heat of vaporization in the second.

It is interesting to trace the mechanism of heat generation in the so-called endothermic reactions, i.e. chemical interaction of two substances occurring with the release of heat.

In principle, the forces of interaction between two bodies, including the forces of attraction of two molecules with their adhesion to each other (ionic bonding) or with the formation of a single electron shell (covalent bonding), are internal forces of the system of these two molecules and should have no effect on the other bodies around them. However, in fact, as a result of joining, two molecules colliding excite each other's surface waves on the electron shells, which is perceived as an increase in temperature. That is, the energy of interaction of molecules is transformed into the energy of surface waves of electron shells of these molecules with all the ensuing consequences. But, besides, in covalent reactions the length of ether flows in a new molecule common for two atoms is less than the sum of lengths of ether flows in the electronic shells of atoms before their joining. This superfluous compacted and screwed ether bursts out of the molecule, causing additionally oscillations in the electronic shells of surrounding atoms and molecules. A specially designed experiment confirmed the fact of ether release during covalent reactions in the form of creation of the so-called "lepton foam" of weakly compacted vortex toroids ("leptons"), the presence of which causes displacement of the metal sail of torsion scales and loss of sensitivity to light of photographic paper.

As the experiment shows, leptons in this "foam" do not have high stability. Those of them, which are on the top, begin to diffuse already in the first seconds after formation. But those that find themselves inside the "foam", exist much longer, here the count goes already on tens of minutes and even on hours. This is easily explained by the fact that the leptons inside the "foam", on their surface have gradient currents of the ether, connected with the ether currents on the surfaces of neighboring leptons.

7.8. Physical essence of electrical and thermal conductivity of metals

The physical essence of electrical and thermal conductivity is well explained by the electron theory developed by German physicist P. Drude [73, 74] and Dutch physicist G.A. Lorentz [75-76].

In metals, atoms are connected to each other by electron shells, forming within a single domain a continuous system like a large molecule, such bonds are called metallic and by the type of

are closest to the covalent type of bonds [77]. This leads to the fact that when atoms are joined, the length of the ether flux in a molecule consisting of only two atoms is less than the sum of the lengths of the paths of the ether fluxes in the atoms before joining. Therefore, when atoms join to form a molecule, part of the compacted screwed ether is ejected from the resulting molecule. In contrast to the usual covalent bond, in the formation of which the ejected part of the ether flow closes on itself, in metals this flow stimulates the organization of the electron at the expense of the ether flows that appeared between the atoms (Fig. 7.16).

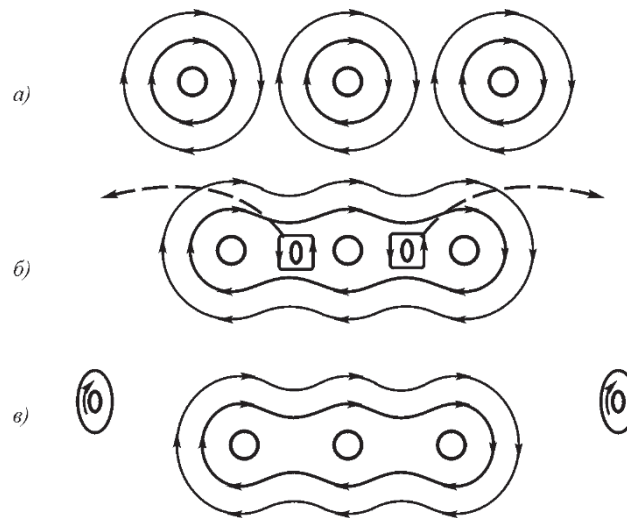

Figure 7.16: Metallic bonding in atoms and formation of free electrons in a metal

The formed free electron begins to move chaotically in the intermolecular space within the Van der Waals shell, colliding with the electron shells of molecules and exchanging energy with them. In this case, part of the electrons go to the surface of the metal and, being set in a staggered order antiparallel to each other, forms the so-called "Fermi surface" (Fig. 7.17).

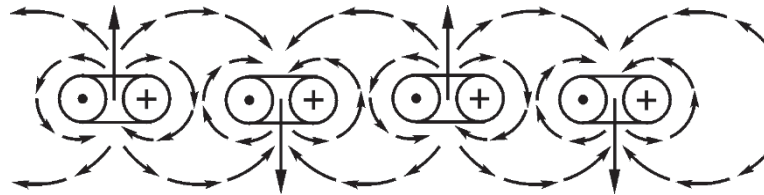

Fig. 7.17. Structure of the "Fermi surface"

According to the electron theory, free electrons in metallic conductors form an electron gas. Moving chaotically in the interatomic space of the conductor body, the electrons collide with the surfaces of atoms and molecules, exchanging impulses with them and thus maintaining a common temperature for the whole body. It is the presence and mobility of the electron gas that ensures the high thermal conductivity of metallic conductors. However, this raises questions about what is the heat of a solid body, what is the mechanism of the temperature of a solid body, what is the carrier of heat in a solid body, and how physically the heat of a solid body differs from the heat of a gas.

According to the electron theory, free electrons, moving chaotically between the molecules of the body, continuously exchange impulses with them, than contribute to the equalization of temperature in the metal at a high rate, which is what distinguishes metals from nonmetals - a high value of the coefficient of thermal conductivity.

Thermal velocity of electrons moving in the metal will be determined by the expression

$$v_e^2 = \frac{3kT}{m_e}, \quad (7.46)$$

where $m_e = 0.9108 \cdot 10^{-30}$ kg is the mass of the electron, from which we find that at a temperature of 20°C (293.3°K) the average speed of thermal motion of the electron will be 115.45 km/s.

Keeping in mind that the number of electrons in a metal must be equal to the number of atoms, their number in a unit volume, like atoms, is of the order of $n = 10^{28} - 10^{29} \text{ m}^{-3}$. If the electron gas

existed by itself, then the average free path length of the electron would be equal to

$$\lambda = \frac{1}{\sqrt{2} n \sigma_e} \quad , \quad (7.47)$$

where σ_e is the cross-sectional area of the electron, which is about 10^{-30} m^2 . Consequently, the free path length would have to be of the order of units of meters, while the distance between the centers of the molecules is of the order of 10^{-10} m . This means that the electrons in the metal do not interact with each other in any way, but each continuously collides with the surfaces of the molecules near which it is located and moves between the molecules.

In accordance with the same electronic theory already in its modern presentation, the heat transfer coefficient of metals and alloys can be estimated using the Wiedemann-Franz law [78]

$$k_\tau = L_o \sigma T, \quad (7.48)$$

where $L_o = 2.445 \cdot 10^{-8} \text{ W.Ohm/K}^2$ is the Lorentz number; σ is the electrical conductivity, Ohm-m^{-1} ; T is the absolute temperature.

This relationship, which states that the thermal conductivity and conductivity of metals and their alloys are proportional, has been confirmed by widespread practice and has been included in reference books as a basis, although not always accurate. Since there are other factors affecting this ratio. Nevertheless, it can be said that the electron theory of metals has been confirmed. According to this theory, the electrical conductivity is equal to

$$\sigma = \frac{ne^2\tau}{m_e} \quad , \quad (7.49)$$

or for resistivity

$$\rho = \frac{m_e}{ne^2\tau} \quad , \quad (7.50)$$

where n is the concentration of electrons in a unit volume; e is the electron charge; τ is the free path time, m_e is the electron mass. As the temperature increases, the frequency of electron collisions with the surfaces of molecules increases and the free path time decreases accordingly. Hence the decrease in conductivity and the corresponding increase in the resistivity of metals.

Thus, the joint representations of electron theory and ether dynamics allow us to understand the mechanism of electrical conductivity of metals and its connection with thermal conductivity. This basic process, as well as everywhere, is superimposed by additional processes leading to deviations from the basic law, which should be considered separately.

7.9. Aura

The first vortex attached to the atomic nucleus - the electron shell - due to the viscosity of the ether by its surface helical flows stimulates the appearance of ether flows in the surrounding space, thus creating the second attached vortex - the van der Waals shell. But in the same way the second attached vortex stimulates the appearance of external relative to it helical flows, which also close outward and create the third attached vortex, the third creates the fourth, etc. The total number of attached vortices can be infinitely large. All these vortices, starting from the third one, are an aura, a field of helical flows of ether, the density of which in them differs practically little from the density of ether in free space (see Fig. 7.13).

The diameter of each subsequent attached vortex of a separate atom is 4-5 orders of magnitude larger than the previous one, so that if the diameter of the nucleus is of the order of 10^{-15} m, and the diameter of the first attached vortex - the electron shell - is 10^{-10} m, the diameter of the second attached vortex will be of the order of 10^{-5} m, and each subsequent vortex will be 4-5 orders of magnitude larger. The velocities of the ether flows on their surfaces will be reduced not by 4-5 orders of magnitude, but in square, i.e. by 8-10 orders of magnitude: if on the surface of the proton the velocity of the ether flow is about 10^{21} m/s, on the surface of the electron shell it is about 10^{11} - 10^{12} m/s, then on the surface of the second attached vortex it is about 10^3 - 10^4 m/s, and further, respectively, even less.

The position essentially changes if we consider not a single atom, but a real physical body. For each attached vortex

the solid angle correspondingly decreases and the velocities of etheric flows increase. Therefore, on the surface of any body the velocity of etheric flows remains the same as that of electronic shells, and further the velocities of flows decrease inversely proportional to the square of distance.

Thus, at a distance of 100 km from a ball of radius 1m the speed of etheric flows in the aura will be only 4 orders of magnitude less than the speed on the surface of the electron shell, i.e. of the order of $10^7 - 10^8$ m/s, at a distance of 10 km - $10^3 - 10^4$ m/s, at a distance of 1000 km of the order of units and tens of meters per second.

Thus, although weakening with distance, the static aura from any object extends for thousands of kilometers, and its structure reflects the structure of the body that produced it. And, consequently, at every point in space there is an aura from any body in the Universe, but of varying intensity, and they are all intermingled with each other, so that it is very difficult to isolate any one.

On the static aura (aura of the 1st kind), living bodies superimpose a dynamic aura (aura of the 2nd kind), which is a reflection of chemical reactions taking place in living organisms, which are accompanied by the release and absorption of ether. This aura was experimentally discovered by Kirlian's spouses in their time (Kirlian's luminescence). The presence of this aura is confirmed experimentally by experiments with deviation from the equilibrium position of a metal plate suspended on an elastic thread during covalent chemical reactions (Atsyukovsky, Pavlenko), as well as by experiments with loss of sensitivity of photographic paper and increase in capacitance of a capacitor near such reactions (Lobarev).

It is also possible the existence of aura detached from the substance as an independent vortex etheric structure (aura of the 3rd kind), the stability of such aura will be less than the stability of the substance due to its low density, but its existence can last for more than one year. This Aura can be absorbed by any objects, except metals, penetration into which for etheric flows is difficult due to the presence of the Fermi surface in them. Aura of the 4th kind can be considered as aura of the 3rd kind, forcibly transferred from one living being to another either for the purpose of curing or for the purpose of causing harm. On the same basis the contactless communication between living beings (telepathy) is provided.

7.10. Mechanism of catalysis

As is known, catalysis is a change in the rate of chemical reactions in the presence of substances (catalysts) that enter into intermediate chemical interaction with the reacting substances, but restore their chemical composition after each cycle of intermediate interactions. A distinction is made between homogeneous and heterogeneous catalysis. In the former, there are no boundaries between the catalyst and reacting substances, while in the latter there is an interface between them. The choice of catalyst composition for a particular reaction is a very complex problem, solved mainly empirically. There are several theories of catalysis - multiplet theory, electronic theory, theory of active centers, etc., but they are semiempirical in nature and consider mainly special cases [79].

Without in any way questioning the usefulness of these theories, attention should be drawn to some additional possibilities provided by ether dynamics for solving the problem of catalysis.

As it was shown above, the electron shell is a toroidal vortex of ether attached to the atomic nucleus, to the surface of which is attached a second toroidal vortex, the van der Waals shell.

The molecules of reacting substances, which have got into the region of the Van der Waals shell of the catalyst, are affected by the moments of forces created by different ether pressures at different points of their surface, which is connected with the difference of velocity gradients, the difference of ether density and temperature in different regions of the Van der Waals shell. As a result of the reversal, the molecules of reacting substances take a certain position relative to each other. If on the surfaces of these molecules facing each other, the ether flows are directed antiparallel, then the pressure of ether in these areas decreases and the molecules are pulled up to each other, then entering into a chemical reaction either ionic or covalent. If the streams of ether on their surfaces are directed parallel, the pressure of ether between the molecules is higher than in the opposite regions, the molecules will be repelled from each other and the reaction rate will even slow down, which takes place in a number of cases. Thus, the essence of catalysis consists in the fact that the catalyst molecule with its attached vortices orients the molecules of reacting substances in space in such a way as to create the most favorable conditions for their reaction.

All flows of the attached vortices, both the first - electron shell and the second - van der Waals shell, are rigidly determined by the structure of the nucleus. Therefore there appears a tempting possibility not only to establish the structure of any atom and any molecule taking into account their shape and ether flows at any distance from the nucleus, but also to determine the position of atoms and molecules caught in the velocity field of ether flows. Thus the mutual position of atoms and molecules of different substances, which have got into this field, will be determined. Modern computational technique in principle allows to perform such work and thus to create a ground for directed selection of catalysts for various reactions.

Consideration of the structures of molecules also allows us to make some suggestions about the mechanism of catalysis.

As is known, catalysts significantly accelerate the course of reactions, and only a very specific type of catalyst is suitable for each type of reactant. The activity of the catalyst is directly proportional to the surface area of the catalyst, therefore, usually strive for the maximum possible crushing of the catalyst substance.

Without in any way questioning all those considerations on the mechanism of action of catalysts which are now known, it is advisable to note some additional points arising from the ether-dynamic conceptions.

In addition to the first attached vortices - electron shells, each atom and each molecule has a consecutive set of attached vortices - second, third, etc. Each subsequent attached vortex has its origin in the previous vortex, the energy of which it feeds on. Thus, there is a vortex aura around each molecule, the structure of which is determined by the structure of this molecule.

Aether streams of auras of different molecules interact with each other, at that, if they are located parallel, there is an overpressure between them, if antiparallel - a reduced pressure. On the whole surface of all attached vortices there appear areas of excessive or insufficient pressure of the ether, creating in aggregate rotational moments and through the attached vortices communicating them to the molecules of substances. This leads to a certain orientation of the molecules in space relative to each other (spatial resonance). The task of the catalyst, therefore, is not only and not so much the entry into the intermediate reaction, as it is commonly interpreted, as the orientation of the reacting molecules

molecules relative to each other and ensuring their mutual orientation in such a way that they are most favorably located in space for closing the corresponding bonds.

It is obvious that both each of the substances involved in the reaction and the catalyst have on their surface streams of ether of absolutely definite shape. If two molecules meet in space, they will tend to turn around so that a maximum velocity gradient is formed between the surface streams, since such a position corresponds to the lowest value of the energy of the system. However, the new position of the molecules will be stable only if the shape of the set of surface fluxes of one molecule corresponds to the shape of the set of surface fluxes of the second molecule. If such a correspondence takes place, the efficiency of interaction between molecules will be maximized.

If the shape of surface streams of molecules is such that two molecules of reacting substances in a favorable orientation relative to each other can be arranged on its surface, these molecules will already pull themselves up to each other. However, the joining of these molecules will inevitably displace them both relative to each other and relative to the catalyst molecule. The newly formed molecule will no longer correspond to the fluxes of the catalyst molecule and will fall away, making room for a new pair of reacting molecules.

The proposed formulation of the solution of the catalysis problem can be accomplished with the help of modern computational techniques by first determining the shapes and directions of ether fluxes on the surface of molecules, and then by calculating the spatial orientation of ether fluxes of various combinations of molecules. It is possible that this way will prove effective in the selection of catalysts for specific reactions.

Conclusions.

1. All quantum-mechanical effects and phenomena can be interpreted from the positions of mechanics of a real viscous compressible gas.
2. The electron shells of atoms can be interpreted as attached vortices of the aether, in which the direction of helical motion (orientation of circular motion relative to toroidal motion) is opposite to that created by protons in the

in the near-nuclear space. The analog of multilayer electron shells in gas mechanics is the multilayer Taylor vortex.

3. The wave function of the Schrödinger equation (ψ -function) can be interpreted as the mass density of the aether in the attached vortices, not as the probability density of the electron's appearance in a given point of space, as it is interpreted by quantum mechanics; it should be noted that the ψ -function reflects the real distribution of the aether density in the attached vortices.

4. When constructing models of atoms on the basis of ψ -function epuries, one should be guided by the rules:

- to extrema of ψ -functions correspond to the centers of attached vortices;
- the zero values of ψ -functions correspond to the boundaries between neighboring attached vortices;
- quantum numbers correspond to the locations of the attached vortices and their orientation.

5. Chemical bonds in molecules can be formed either as a result of combining the attached vortices of atoms into a common molecular vortex, which corresponds to a covalent bond, or as a result of adhesion of the attached vortices of two molecules to each other at antiparallel orientation of the surface flows of ether due to a decrease in ether pressure between them, which corresponds to an ionic bond. Van der Waals forces - attraction of molecules to each other - can be explained as a result of formation of a gradient flow between molecules in which the ether pressure is reduced.

6. When a covalent bond is formed, part of the compacted helical flow of ether is ejected from the molecule and forms an independent light particle, conventionally called a "lepton". Leptons form a "foam", their stability in the "foam" is from units of seconds on the surface to units of hours in the depth of the "foam".

7. During the formation of a metallic bond, the ejected part of the ether flow stimulates the creation of free electrons from the parts of the first attached vortices - the electron shells of atoms. These free electrons are ejected into the region of the second attached vortices - the van der Waals shell, where they behave like gas molecules.

8. Part of the formed electrons goes to the surface of a piece of metal, where they form the so-called "Fermi surface", consisting of electrons arranged in a staggered order, whose spins are oriented in opposite directions at neighboring electrons

sides. This system is stable and can exist indefinitely.

9. Presumably, the mechanism of heterogeneous catalysis is related to the formation of gradient flow between individual parts of molecules and their auras, which leads to the rotation of molecules relative to each other and creates a mutual spatial orientation that facilitates the entry of molecules into chemical bonding.

Chapter 8: Electromagnetic Phenomena

The ether theory ... gives hope of finding out *what* is the actual substratum of electrical motion, *what is* the actual thing that causes electrical phenomena by its motions

F. Engels [1]

8.1. Brief history of the formation of the theory of electromagnetism

As is known, the development of the theory of electromagnetism has gone through stages:

- a spontaneous accumulation of facts;
- an experiential accumulation of facts;
- attempts to create physical theories to explain electromagnetism;
- attempts to create physical and mathematical theories describing electromagnetic phenomena and allowing to create methods of their calculation;
- generalization of physical and mathematical theories of electromagnetism and creation of a unified mathematical theory;
- experimental research aimed at verifying and confirming the provisions of the general theory;
- implementation of the results obtained in wide practice.

On the basis of numerous experimental data, calculation methods were developed, which made it possible to accurately calculate power and low-current devices and units, transmission lines and electric circuits. In the twentieth century, the most important branches of modern industry - electro-mechanical engineering, radio engineering and electronics, without which the existence of modern mankind is unthinkable, were created on the basis of the knowledge obtained by that time. The statement that "there is nothing more applied than good theory" has fully justified itself in practice.

The modern theory of electromagnetism was preceded by a long period of accumulation of knowledge about electricity and magnetism. In the 17th and 18th centuries, the works of M.V. Lomonosov, G.V. Richman, B. Franklin, S.O. Coulomb, P. Divish and other scientists were devoted to the study of the nature of electricity. The creation of the first source of continuous current by A.Volt was of decisive importance. In the first third of the 19th century, numerous studies of chemical, thermal, light and magnetic phenomena caused by electric current were carried out (works by V.V.Petrov, H.K.Ersted, D.F.Arago,

M. Faraday, J. Henry, A. M. Ampere, H. S. Ohm and others). In the second half of the XIX century, these works received numerous practical implementations in many developments that found wide application in industry [2-4]. And with all this, almost no one knows what the essence of electricity and magnetism is, what they are, what their physical nature is.

It should be said that in the 19th century some attempts were made to understand the question of what electricity and magnetism are physically, what they consist of and how they are organized. In one way or another, all of them were forced to involve in consideration the notion of the ether, whose movements, in their opinion, were the basis of electromagnetism.

M. Faraday suggested the existence of force tubes of electricity ("Faraday force lines") [5, 6]. The ideas about electromagnetic phenomena as vortex motions of ether fluid were formulated by H. Helmholtz [7, 8], W. Thomson [9-13], Chellis [14], Maxwell [15-17], and some other authors - Heaviside [18, 19], Campbell [20], Larmor [21], Langevin [22], Abraham [23], etc. The significant contribution to the understanding of the processes associated with the passage of electricity was made by M. Faraday. A significant contribution to the understanding of the processes associated with the passage of electric current through wires was made by German physicist P. Drude [24-26], who created the electronic theory of conductivity of metals, and Dutch physicist G. Lorentz [27, 28], who significantly developed and supplemented this theory. In the twentieth century, similar ideas were expressed by J. Thomson [29, 30], N.K. Kasterin [31], V.F. Mitkevich [32-37].

The mathematical theory of electricity and magnetism was created and practically completed in the second half of the XIX century. Its apotheosis was the famous "Treatise on Electricity and Magnetism" [38] written by Maxwell in 1873 [38], written by Maxwell in 1873. In it Maxwell managed to generalize the results of the works of a number of scientists such as V. Thomson, M. Faraday, G. Helmholtz, K. Kirsten and others. Helmholtz, Kirchhoff, Rankin, Coulomb, Ampere, Riemann, Neumann, Ersted, Lenz and many others (Stokes, Weber, Chellis, Fizeau, Verde, Reeve, Beer, Beer, Hall, Quinke, Green, Jenkin, Lagrange, Felici, Foucault, Knoblauch, Pulier) and to supplement the achievements of researchers of electromagnetic phenomena of that time with the theory of the electromagnetic field. In the "Treatise" Maxwell finalized the famous equations of electrodynamics, which received his name. In this form, the theory of electromagnetism has survived to this day virtually unchanged. Maxwell's treatise was the basis for all subsequent textbooks on electrical engineering and electrodynamics.

Perhaps of no less importance was the work of H. Lorentz "Theory of electrons and its application to the phenomena of light and thermal radiation", written by him in 1909. [28].

Maxwell's work and, in particular, his electro-magnetic field equations had a decisive influence on the development, already in the twentieth century, of such fields of science as electrical engineering, electrodynamics, radio engineering, electronics and even optics. From these famous equations it was deduced that there could be electromagnetic waves propagating in space at the speed of light. This prediction was made by Maxwell in his paper "On Physical Force Lines" (1861-1862) [16]. In this work Maxwell, using a model of some vortex mechanism in the ether, for the first time comes to his famous equations and introduces the concept of displacement current. Maxwell quite definitely becomes on Faraday's positions related to the recognition of the reality of the physical state of the medium represented by force lines. The concept of close action was finally formed by him, and his further task was to reflect the structure of the field in models and equations, which he accomplished in 1873 in his "Treatise on Electricity and Magnetism".

Based on Maxwell's equations, based on the ideas of vortex motions of the ether, the German physicist Heinrich Hertz in 1886-1889 with the help of a vibrator invented by him experimentally proved the existence of electromagnetic waves and investigated their properties (reflection from mirrors, refraction in prisms, etc.). Hertz confirmed all the main conclusions of Maxwell's theory about the properties of electromagnetic waves.

After the publication of Hertz's works on electrodynamics in 1888, the Russian physicist and inventor A.S.Popov in 1895 created the necessary equipment for the transmission and reception of electromagnetic waves, which laid the foundation for radio engineering.

Thus, the equations of electromagnetic processes, derived by J.K.Maxwell on the basis of ideas about vortex motions of the ether, not only have theoretical justification, but also have been comprehensively verified by practice.

It is useful to recall that the equations of electrodynamics were derived by Maxwell on the basis of models of the motion of the ether, in the existence of which Maxwell was convinced.

"Indeed," writes Maxwell, "if, in general, energy is transferred from one body to another not instantaneously, but in a finite time, there must be a medium in which it temporarily resides, having left the first body and not reached the second. So these theories

must lead to the existence of an environment in which this propagation takes place."

The level of knowledge of the properties of the ether at that time was insufficient, probably for this reason it was not possible to create any satisfactory qualitative theory of electromagnetic phenomena, and the attention of researchers was turned to the quantitative study of electric and magnetic phenomena, to the identification of regularities and the creation of calculation methods on their basis. On this path were obtained outstanding results that allowed to create a modern mathematical theory of electromagnetism. But not a physical one.

Due to the difficulties in creating a physical theory of electromagnetism, as well as due to the success of quantitative methods, many theorists and practitioners have the impression that there is no need to understand the essence of electric and magnetic phenomena. However, this view is deeply mistaken. Misunderstanding of the physical essence of the phenomena leads to the fact that the created quantitative methods begin to be applied without any restrictions, which sometimes leads to large errors in calculations. Moreover, many essential circumstances are not taken into account. And even more - new problems appear, which cannot be solved by the created methods, and they remain unsolved. There are many examples of this in electrical engineering, in radio engineering, and in other fields somehow related to electromagnetic phenomena, even in optics.

If a qualitative theory of electromagnetic phenomena were created, it is likely that most of the functional descriptions and the quantitative methods of calculations arising from them would remain unchanged, but in some cases they would undergo significant refinements. And this would allow to create not only new methods of calculations, more accurate, but even new directions.

One way or another, but, making wide use of mathematical dependencies of the theory of electromagnetism and making sometimes even general philosophical conclusions from them, theorists and practitioners still do not have the slightest idea about the essence of electricity. The overwhelming majority are accustomed to it and do not consider it necessary to raise this question. But we should not forget that sooner or later the imperfection of theory will inevitably lead to a collision with the interests of practitioners, when it turns out that the created theoretical groundwork is not enough to solve applied problems. This will require

further development of the theory, but it is impossible to develop a theory that has no ideas about the essence of the phenomena it considers.

The necessity of an essential approach to the study of electromagnetic phenomena has been emphasized by many scientists. Even F. Engels wrote in 1882 [1]:

"Exceptional empiricism, which allows itself to think at best only in the form of mathematical calculations, imagines that it operates only with indisputable facts. In reality, it operates mainly on traditional ideas, mostly outdated products of its predecessors' thinking. The latter serve as a basis for endless mathematical calculations, in which the hypothetical nature of the assumptions is easily forgotten because of the rigor of mathematical formulas. This empiricism is no longer able to represent the facts correctly, for it is the traditional interpretation of these facts that is embedded in its representation.

In 1906, in his famous work "The Theory of Electrons", G. Lorenz notes:

"Although the equations (of the electromagnetic field - *V.A.*) are useful in the consideration of many problems, they cannot be applied in all cases without exception. Even if this were the case, our theory would cease to satisfy us when we attempt to look deeper into the nature of phenomena: indeed, for in this general theory we express the special properties of various weighty bodies by simply assigning to each of them special values of dielectric constant, conductivity, and magnetic permeability. If we want to understand *how* (italics mine - *V.A.*) electric and magnetic properties depend on temperature, density, chemical structure or crystalline state of a substance, we cannot be satisfied with the simple introduction for each substance of these coefficients, the values of which must be determined from experience: we will be forced to turn to some hypothesis concerning the mechanism underlying all these phenomena".

It is regrettable to state that the successes of applied sciences have given the present theory of electromagnetic phenomena and, in particular, Maxwell's theory a halo of absolute truthfulness, and modern theoretical physics has excluded the notion of the existence of the ether in nature, the vortex motions of which were considered by Maxwell as the basis of electromagnetic phenomena. This eliminated any possibility of the existence of an aether

further deepening of the understanding of the essence of electromagnetic phenomena. As a direct consequence, the mathematical dependencies of electrodynamics, created by Maxwell more than a hundred years ago, were practically not developed in any way.

Attempts of some researchers to change something in these equations always ended in failure. This gave a reason to L. Boltzmann in his notes to the translation of Maxwell's work "On Physical Force Lines" in 1898 to write [16, p.194]:

"I could say that Maxwell's followers have perhaps changed nothing but the letters in these equations. However, that would be too much. Certainly it is not that we should be surprised that anything at all could have been added to these equations, but much more how little has been added to them."

Today, more than a hundred years later, Boltzmann's surprise remains valid: practically nothing has been added to Maxwell's equations, although hundreds of textbooks on the theoretical foundations of electrical engineering, electrodynamics and radio engineering have been written, thousands of applied problems have been solved, and the most diverse devices have been created. It would seem that there is no reason to return to this question. However, it is not so.

Firstly, idealized notions about motions of ether fluid led to paradoxes in models of electromagnetism similar to those in hydrodynamics of ideal fluid, for example, energy of a unit length of a vortex is equal to infinity irrespective of its intensity. In electrodynamics there appeared a paradox similar to the considered one: the energy of a unit length of a conductor with current is equal to infinity irrespective of the magnitude of the current. However, since a single conductor does not exist in nature, there is a possibility of resolving this paradox by considering the whole structure, including the return conductor, then this paradox is resolved. Nevertheless, the paradoxical position should not exist for any system, including the conventional single conductor.

There are some other disadvantages of the existing models: most of them do not consider the interactions of matter and electromagnetic fields, thus separating them from each other, some expressions do not reflect the interaction between the sources of fields and the bodies they affect, etc.

Secondly, it was found out that many calculations based on Maxwell's equations give very approximate results, differing from those found empirically, by tens of

percent, sometimes by several times. This applies, for example, to the mutual induction of large circuits. It is true that application engineers are used to this and attribute the discrepancies to the failure to take into account the associated factors and make the necessary corrections in the process of device debugging. But the analysis shows that deviations in calculations cannot be explained by unaccounted factors alone.

Thirdly, it was found that there is a series of problems of electrodynamics which cannot be solved on the basis of the existing representations. This is due, first of all, to the fact that the authors of the models considered only the first approximations to electromagnetic phenomena, and such approximations, as new data are accumulated, can be any number of, led to the fact that some applied problems of electrodynamics appear unsolved, and there are problems that fundamentally cannot be solved on the basis of Maxwell's equations.

Such problems include, for example, the joint motion of two identical charges stationary relative to each other: as long as they are both stationary, they repel each other according to Coulomb's law, but if they move together in space without moving one relative to the other, they now become currents attracted to each other. Why?

Such a problem, for example, is the problem of electromagnetic wave propagation by a Hertz dipole placed in a semiconducting medium. A Hertz dipole, i.e., a dipole with concentrated parameters that are known, placed in a semiconducting medium whose parameters are also known, emits a current of known magnitude, the frequency of which is also known. It is necessary to determine the current density in the medium at a given point of space. This problem is completely physically defined. In spite of the triviality of the formulation and the tempting possibility of obtaining from the general solution of this problem as a limiting case many particular results - radiation in an ideal medium in the absence of active conduction, attenuation of a plane wave in a semiconductor at infinite distances from the dipole and some others - the problem of radiation of the Hertz dipole in a semiconducting medium has never been solved by anyone, and attempts to solve it invariably ended in failure. There are, however, attempts to form a ready solution by multiplication of two partial solutions - the solution of the problem of field propagation by a Hertz dipole in an ideal medium and the solution of the plane wave problem, but this approach is absolutely incorrect. In fact, this problem is not

can be solved on the basis of Maxwell's equations, since it leads to a system of equations having no general solution.

The limit problems about the electric field in a pulsating homogeneous electric field and many others have not been solved. There are even whole classes of electrodynamic problems, physically completely defined, which, nevertheless, cannot be solved by means of Maxwell's equations.

Fourth, it should be noted that not all concepts used in theoretical electrical engineering have a clear physical meaning. What is "vector potential A "? It is such a quantity whose vortex is the vector of magnetic induction B :

$$B = \text{rot } A.$$

There is no physical meaning of this value.

Fifth, there are some inconsistencies in the logic of electromagnetism. For example, Maxwell's static postulate

$$\int_S \mathbf{D} d\mathbf{S} = q,$$

placed in textbooks of theoretical foundations of electrodynamics in the sections of statics, after its representation in differential form

$$\text{div} \mathbf{D} = \rho$$

is placed already in the dynamics section, although the latter form of representation does not differ from the previous one in physical essence. As a result, the delay in the values of electric induction D at moving of charges q inside the space covered by the surface S is ignored.

And sixth, it is necessary to remind that no phenomenon can be described completely, that any description is approximate, and if an equation reflecting a certain process is written, the very fact of writing this equation with a finite number of terms means that this equation describes the process partially, approximated. This means that sooner or later there will be a need to refine it. This applies to all concrete processes and physical phenomena, and electromagnetic phenomena are no exception.

These points, as well as some other considerations, do not allow us to consider the development of the theory of electromagnetism as fully completed. However, its further evolution is possible only on the basis of a detailed qualitative consideration of processes,

occurring in electromagnetic phenomena, which makes us return again to the development of models of these phenomena taking into account those drawbacks that were inherent in the early hydromechanical models.

Therefore, attempts to refine the equations of electrodynamics should not cause protest. It is only necessary to make sure that the problem is correct.

However, any refinement of the equations should be based on the idea of the essence of the phenomenon, on its qualitative model. J.K. Maxwell followed the dynamic method of electromagnetism research. He represented electric and magnetic phenomena as certain vortex processes occurring in the ether, a medium that fills the entire world space. And since he believed that the ether is something like an ideal liquid, he widely used the ideas of hydromechanists of his time about the properties and forms of motion of such a liquid, in particular the ideas of Helmholtz, Rankin and other researchers. Taking into account that Maxwell's ideas about electromagnetic phenomena, expressed by his equations, have received good confirmation, although not absolute, it would be logical to return to his model with correction for modern ideas about the ether.

At present, there is every reason to return to the models of electricity and magnetism developed by J.C. Maxwell and his predecessors, to try to understand their shortcomings from the standpoint of today's ideas about the ether and the physical essence of electricity, magnetism and electromagnetic phenomena, for which it is necessary to refine the physical model of electromagnetism and on this basis to make appropriate refinements of the equations of electromagnetic phenomena. It should be remembered that both the refined model and the equations derived from it cannot be complete, and further refinements of the model and equations of electrodynamics are inevitable in the future.

The foregoing provides the basis for an attempt to fulfill the instruction of F. Engels, expressed by him in 1882 in "Dialectics of Nature" [1, c. 452]: "Electricity is a motion of ether particles and molecules of bodies take part in this motion. ...Different theories depict the character of this motion in different ways, ...relying on the latest researches about vortex motions, see in it - each in its own way - also a vortex motion. ...The ether theory..... gives hope to find out *what* is actually the material substratum of electric motion, *what* actually causes electric phenomena by its motion".

There can be no doubt that the attempt made below to present the essence of electromagnetic phenomena, like any such attempt, is partial. It is more a statement of the problem than its solution. Nevertheless, the author is sure that such attempts are useful because they help to better understand the essence of electromagnetic phenomena, to define new directions of research, and in some cases to clarify already known mathematical dependences.

The models of electromagnetism presented below, apparently, have their own shortcomings, therefore in the future they also should be clarified and supplemented, as well as any other models.

Today, the desire to understand the physical essence of electromagnetic phenomena is more than timely. It can be considered that attention should have been paid to this problem much earlier, because all the materials for this were available. A number of authors have made such attempts. Among them we should note the works of V.F.Mitkevich (Leningrad, 20-30s) [32 - 37], the modern work of G.N.Nikolaev (Tomsk) [39], in which an extensive list of paradoxical phenomena from the point of view of modern electrodynamics is given, as well as some others. Their disadvantage should still be considered as incompleteness of physical ideas about the essence of electromagnetism, which did not allow the authors to create a unified and consistent physical picture of electromagnetic phenomena. Below is an attempt to fill this gap to some extent.

It should be noted that in realizing this attempt, certain difficulties arose due to the lack of elaboration of some provisions of gas mechanics and some provisions of even such a section of mathematics as vector analysis. The former include the clearly insufficient level of the theory of the boundary layer in compressible media, the theory of interaction of helical jets, the theory of interaction of helical vortex toroids, and some others. The latter include some notions rooted in vector analysis but insufficiently justified physically, for example, the prohibition of dividing collinear (coinciding in direction) vectors by each other. Although the physical meaning of such an operation is obvious, the prohibition of representing such a quantity as the gradient of a vector, although even here the physical meaning is clear (e.g., the gradient of the velocity of water flow in a river). Some of these difficulties have been circumvented, but detailed elaboration of all such issues is ahead.

8.2. Physical essence of electromagnetism

8.2.1. Units of electric and magnetic quantities in the ISS system

Until recently, the absolute electrical system of units GHSE, the absolute electromagnetic system of units GHSM, and the absolute Gaussian system of units, in which the basic units were centimeter, gram, and second, were used in electrical engineering, but in the GHSE system the absolute permittivity is considered dimensionless and equal to one for vacuum:

$$\varepsilon_0 = 1;$$

in the GHSM system the absolute magnetic permeability is considered dimensionless and equal to unity for vacuum:

$$\mu_0 = 1;$$

and in the Gaussian system of units the absolute dielectric and magnetic permeabilities are considered dimensionless and are taken simultaneously equal to unity for vacuum:

$$\varepsilon_0 = \mu_0 = 1;$$

As a result, one and the same electric or magnetic quantity appears to have different dimensions. For example, the quantity of electricity (electric charge) has dimensionality: in the GHSE and Gaussian systems of units - $\text{sec}^{3/2} \cdot \text{g}^{1/2} \cdot \text{s}^{-1}$; and in the GHSM system of units - $\text{sec}^{1/2} \cdot \text{g}^{1/2}$; magnetic flux in the GHSE system of units has dimensionality - $\text{sec}^{3/2} \cdot \text{g}^{-1}$, in the GHSM and Gaussian systems of units - $\text{sec} \cdot \text{g}^{-3/2} \cdot \text{s}^{-1}$.

Presence of three almost simultaneously operating systems electric and magnetic units have always caused great difficulties in calculations, but the main difficulty was the absence of any physical meaning in these units: how to understand, for example, the square root of the gram, or the centimeter raised to the degree of 3/2 !

The International System of Electric and Magnetic Units (ISSA), based on the same ideas as the ISS system about the units of mass - kilogram, length - meter and time - second, added to them a new basic unit - the unit of current Ampere. In it, the above quantities have integer degrees:

quantity of electricity - A-c; magnetic flux - $m^3 \cdot kg \cdot A^{-1} \cdot s^{-2}$, as well as all other electric and magnetic quantities. However, the disadvantage of the ICCA system is still the lack of physical content in the concept of "current force" and, in this connection, in its unit as well

"Ampere", and further in all electrical and magnetic quantities.

The physical content of the concept has been established above "electric charge" as circulation of aether density over the surface of a particle

$$q, Cl = \rho v_k S_p, \text{ kg/s}, \quad (6.20)$$

and through that, the concept of "amperage."

$$I = dq/dt, \text{ kg/s}^2. \quad (8.1)$$

This creates the possibility of extending the ISS system of units to all electric and magnetic quantities by substituting the value of the current measurement unit. Table 8.1 shows the units of measurement of basic electric and magnetic quantities in the ISS system of units.

Table 8.1.

magnitude	Unit name	Designation	Unit of measurement in the ICCA	Unit of measurement in the ISS
Work and energy	Joule	J. J. Bennett, Jr.	$m^2 \cdot kg \cdot s^{-2}$	$kg \cdot m^2 \cdot s^{-2}$
Power	Watt	W	$m^2 \cdot kg \cdot s^{-3}$	$kg \cdot m^2 \cdot s^{-3}$
Quantity of electricity (electrical charge)	Pendant	Cl	A-s.	$kg \cdot s^{-1}$
Current strength	Ampere	A	A	$kg \cdot s^{-2}$
The flow of electricity displacement	Pendant	Cl	A-s.	$kg \cdot \text{with}^{-1}$
Electrical displacement (induction)	The pendant on the quad-meter	$Cl \cdot m^2$	$A \cdot s \cdot m^{-2}$	$kg \cdot m^2 \cdot s^{-2}$
Voltage, potential difference, electromotive force	Bolt	B	$m^2 \cdot kg \cdot A^{-1} \cdot c^{-3}$	$m^2 \cdot s^{-1}$
Electrical capacity	Farada	Φ	$A \cdot c^4 \cdot m^{-2} \cdot kg^{-1}$	$kg \cdot m^{-2}$

Electric moment	-	C1 -m	A-c-m.	kg-m-s ⁻¹
-----------------	---	-------	--------	----------------------

Polarization vector (polarization)	-	$Cl-M \square^2$	$A-sm^{-2}$	$kg-m^{-2}-c^{-1}$
Electrical Permeability	Farada per meter	$F-M \square^1$	$A-c^4-m^{-3}-\kappa \Gamma \square^1$	$kg-m^{-3}$
Tension electric field	Bolt per meter	$B-M \square^1$	$m-kg-A \square^1-c \square^3$	$m-c \square^1$
Electrical resistance	Ohm	Ohm	$m^2-kg-A \square^2-c \square^3$	$kg \square^1-m^2-s$
Specific electrical-resistance	-	Ohm-m	$m^3-kg-A \square^2-c \square^3$	$kg-m^3-c^{-2}$
Specific electrical conductivity	-	$Ohm \square^1-M \square^1$	$A^2-c^3-M \square^3-\kappa \Gamma \square^1$	$\kappa \Gamma \square^1-m^{-3}-c^2$
Ion mobility	-	$m^2-B \square^1-c \square^1$	$A-c^2-\kappa \Gamma \square^1$	-
Magnetic flux	Weber	Wb	$m^3-kg-A \square^1-c \square^2$	M^2
Magnetic induction	Tesla	Tl	$kg-A \square^1-c \square^2$	$m_{yy}-m_z \square^1$
Magnetic torque	-	$A-m^2$	$A-m^2$	$kg-m^2-c^{-2}$
Magnetization intensity vector (magnetization)	-	$A.M \square^1$	$A-M \square^1$	$kg-M \square^1-c^{-2}$
Inductance and mutual inductance	Henry	Hn	$m^2-kg-A \square^1-c \square^2$	$\kappa \Gamma \square^1-m^2-c^2$
Magnetic permeability	Henry's on meter	$Gn-M \square^1$	$m-kg-A \square^2-c \square^2$	$\kappa \Gamma \square^1-m-s^2$
Tension magnetic field	Amps per meter	$A-M \square^1$	$A-M \square^1$	$kg-m \square^1-s^{-2}$
Magnetomotive force	Ampere or Am-primary current	A or Av.	A	$kg-c^{-2}$
Magnetic resistance	-	$A-B \delta \square^1$ or $Av-B \delta \square^1$	$A^2-c^2-M \square^2-kg$	$kg-m^{-2}-c^{-2}$

*Based on the data of the Handbook on Physics for Engineers and Students of Higher Education Institutions. Moscow, Nauka, 1971.

8.2.2. The structure of a free electron

As has been shown above, when the streams of ether constituting the electronic shells of metal atoms are joined together in a common structure, a part of the screwed and compacted ether in the structure of these shells turns out to be superfluous and is thrown out into external space. A helical jet cannot be kept in this form, for one end moving forward is the origin of the gas, and its opposite end is the sink. The forward end of the jet must necessarily close on the back end, resulting in the formation of a new helical toroid of ether of small mass, the free electron. In principle, the number of such electrons in a metal should be equal to the number of atoms, i.e. about 10^{29} m^{-3} , since each atom ejects an ether jet forming a free electron when it joins the common structure.

The surface element of the newly formed toroidal helical vortex - the electron - is affected by a difference of forces: the pressure of free ether acts from the outer side, and from the inner side - the sum of forces of internal pressure, which is essentially less than the external pressure, since the rotation throws the gas from the central region to the periphery of the vortex, and the centrifugal force. Such a system is unstable and begins to spontaneously contract, because in the interatomic region the velocities of the ether flow are smaller than in the electronic shells of the atom, the velocity gradients are smaller, hence the ether pressure is higher here.

For a free vortex, the momentum of momentum of both toroidal and annular rotations must be preserved, which at compression will lead to a spontaneous increase of both linear and angular velocity of both motions, and the linear velocity is proportional to the first degree of compression, and the angular velocity is squared. The process of spontaneous compression of a gas vortex and energy relations of this process have been considered above.

The vortex compression and increasing rotation velocity will continue until the vortex density increases to some critical value, presumably the same as that of the proton, i.e., to a value of the order of $10^{17} - 10^{18} \text{ kg/m}^3$. As a result, the resulting vortex helical ring will acquire dimensions substantially smaller than those of the original vortex. This will be the free electron.

The described mechanism of formation of free electrons in a metal crystal is caused by the rearrangement of the outer shell of metal atoms due to the formation of a common crystal lattice.

The unification of external attached vortices of atoms into a single structure should lead to the release of free vortices - electrons, which begin to wander around the crystal in the form of the so-called "electron gas". Something analogous was discovered by the author and confirmed experimentally in covalent reactions, in which each pair of interacting molecules releases a part of the screwed compacted ether, which immediately forms a toroidal ether vortex.

Thus, the free electron is a helical vortex ring of compressed ether, in which the sign of the helical motion, i.e., the orientation of the ring motion relative to the toroidal motion, is opposite to the sign of the helical motion of the ether in the body of the proton, but the amount of the ring motion is the same. Consequently, it carries a charge of the same magnitude as the proton, but the sign of the charge is not positive, as in the proton, but negative.

The presence of circular motion in the electron is confirmed by the fact that the electron has spin, the momentum of rotational motion equal to $\frac{1}{2}$ in units of \hbar . The main axis of the electron is the axis of circular spin (Fig. 8.1).



Fig. 8.1. Structure of a free electron: *a* - in metal; *b* - in free space

If the electron in the free ether has the same density as the proton, then the radii of the electron and proton relate to each other as the cube root of the ratio of their masses, i.e.

$$r_e / r_p = (m_e / m_p)^{1/3} = (9.1 \cdot 10^{-31} / 1.67 \cdot 10^{-27})^{1/3} = 0.082 \quad (8.2)$$

and hence the radius of the electron will be:

$$r_e = 0.082 r_p = 0.082 \cdot 1.12 \cdot 10^{-15} = 9.10 \cdot 10^{-17} \text{ m.} \quad (8.3)$$

The surface area of the electron will be

$$S_{\text{сноб}} = 4\pi r_e^2 = 4\pi (9.10)^{-172} = 1.1 \cdot 10^{-31} \text{ m}^2, \quad (8.4)$$

and the value of the annular velocity will be determined from the value of the charge

$$e = \rho v S_{\text{кв}} = 1.6 \cdot 10^{-19} \text{ Cl} \quad (8.5)$$

from where

$$v_{\text{к}} = e / \rho S_{\text{е}} = 1.6 \cdot 10^{-19} / 8.85 \cdot 10^{-12} \cdot 1.1 \cdot 10^{-31} = 1.64 \cdot 10^{24} \text{ m.s}^{-1}. \quad (8.6)$$

The value of annular velocity circulation will be defined as

$$(\text{circ})_{\text{е}} = 2\pi r v_{\text{к}} = 2\pi \cdot 9.10^{-17} \cdot 1.64 \cdot 10^{24} = 9, 27 \cdot 10^8 \text{ m}^2 \cdot \text{s}^{-1} \quad (8.7)$$

The cross-sectional area of the electron is

$$S_{\text{сеч}} = \pi r_e^2 = \pi (9.10)^{-172} = 2.75 \cdot 10^{-32} \text{ m}^2 \quad (8.8)$$

It should be noted that inside metals electrons are not in the atmosphere of free ether. There exist other attached vortices, which can be conditionally called van der Waals shells and which provide interatomic bonds of non-chemical (not electronic) nature. An electron inside such vortices will experience pressure less than in the free ether and its size will be essentially larger. Not only that, moving in the space between metal atoms, the electron all the time passes from one region of the van der Waals shell to another, the velocities of ether flows and velocity gradients in them are different, hence the pressures in them are different, so the electron cannot keep its dimensions unchanged, they are always changing, the radius of the electron ring is not constant and varies depending on external factors.

The concept of the electron as a vortex ring with a variable radius was introduced by V.F. Mitkevich [36, 37]. The main objection to Mitkevich's model was the statement that the charge and magnetic moment of the electron are spherically symmetric. However, subsequent works of Wu and some other physicists showed that the electron behaves like a rotating vortex ring, spin

which is directed along the axis of its motion. This fact removes the mentioned objections.

As is known, an electron has an intrinsic energy equal to

$$E = h\nu = m_e c^2, \quad (8.9)$$

and spin - mechanical momentum of rotation

$$s = \frac{1}{2} h = m r v_{ek} = m r_{ek} \omega_k = J_k \omega_k \quad (8.10)$$

Spin reflects only the mechanical momentum of the ring motion, while energy reflects the total internal energy of the electron, accounting for both ring and toroidal motion. For circular motion.

$$E_k = J_k \omega_k / 2. \quad (8.11)$$

If, according to Maxwell's principle, the energies are uniformly distributed over the degrees of freedom, then

$$E_k = E_t \quad (8.12)$$

and, at least for the first case - the existence of the electron in the free ether - it can be stated that the linear velocities of the circular and toroidal motions of the ether on the surface of the electron are equal and, consequently, the particles of the ether in the body of the electron move along a helical line with a helical inclination of about 45° .

If an electron enters a region where there are any flows of the aether, then, as the velocity gradient increases, the pressure on the surface of the electron falls and the vortex ring increases in size.

8.2.3. Physical essence of the electric field

From the comparison of expressions for the energy density of the electric field in vacuum

$$w_e = \frac{\epsilon_0 E^2}{2}, \text{ J/m}^3, \quad (8.13)$$

where ϵ_0 is dielectric permittivity of vacuum, Φ/m ; E -

is the electric field strength, V/m, and the corresponding expression of the aether ring motion energy

$$w_k = \frac{\rho v_{\text{эк}}^2}{2}, \text{ J/m}^3 \quad (8.14)$$

where ρ , is the density of the medium, $\text{kg}\cdot\text{m}^{-3}$; v_k is the velocity of the medium at the equator of the proton, m/s, it follows directly that the electric field strength has the dimension of velocity. By definition, the electric field strength is the force acting on a unit electric charge, so that

$$E = \frac{F}{q} . \quad (8.15)$$

However, any force can arise as a result of the pressure gradient, which, in its turn, can arise as a result of the velocity gradient of the ether flows in the electric field and on the surface of the particle interacting with it. Taking into account the transverse character of propagation of the electric tension vector, it should be assumed that the interaction between the electric field and the particle involves the aether flow directed not in the direction of the particle, but in the perpendicular direction. In this case there is an interaction due to velocity gradients, which vector is directed towards the particle. Such interaction is possible if there is not only a longitudinal but also a transverse flow of the aether in the electric field structure itself.

When an electric charge appears on the surface of the electrode, i.e. when electrons come to its surface, an electric field is established in the vicinity of the electrode.

Fig. 8.2 shows that when helical vortex toroids - electrons or protons - enter the electrode surface, they create helical vortex tubes of moving aether in the space outside the electrodes. In a vortex tube formed in the medium by a helical toroidal ring, flows of aether move not only along the ring in the plane perpendicular to the axis of the tube, but also parallel to this axis. At that, in the central part of the vortex tube, the ether moves from the helical toroid, and in the periphery - to the helical toroid, so that the total amount of translational motion of the ether along the tube in the

is equal to zero on average. This translational motion is of great importance because, being different in magnitude and direction at different distances from the tube axis, this motion creates different values of the helical factor, with the helical motion having one sign along the tube axis and the opposite sign at the periphery (Fig. 8.2).

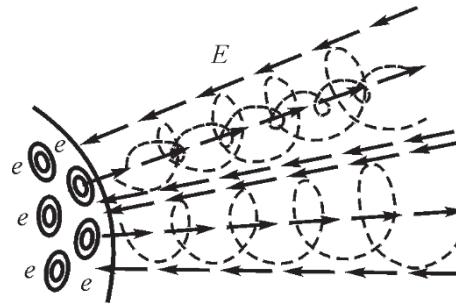

Fig. 8.2. Vortex field created by helical vortex toroids (electric field)

As shown in [40, 41], only helical flows, in which the helical factor is constant and the same along the entire length of the vortex, can summarize. Such a helical motion must satisfy Eq.

$$\text{rot } \mathbf{v} = \lambda \mathbf{v}; \tag{8.16}$$

$$\frac{\omega_x}{v} = \frac{\omega_y}{v r_x} = \frac{\omega_z}{z} = \lambda,$$

herewith

$$v \text{grad } \lambda / r = \text{const.} \tag{8.17}$$

There is nothing similar for vortex tubes of electric induction, hence, the fluxes of these vortex tubes cannot sum up, but can only develop longitudinally, sliding on the surface of each other, and shift transversely under the pressure of neighboring vortex tubes.

Thus, the force lines of the electric field - electric induction - exist as separate vortex tubes ("Faraday tubes"), but electric induction corresponds not to all this motion, but only to its circular component.

The electric field is a set of helical vortex tubes of ether ("Faraday tubes") with a helical factor variable in cross-section.

The intensity of the electric field is determined by its strength, i.e. by the number of tubes per unit area of the conductor cross-section, and accordingly by the cross-section of each tube: the higher the strength of the electric field, the greater the number of tubes per unit area and the smaller will be the cross-section of each tube, which is in full accordance with the theory of gas vortices. For a gas vortex, when the gas circulation along the vortex is constant, the strength and linear velocity of rotation are greater the smaller its cross-section.

For a single charge, the total angle occupied by the annular motion is 4π , hence, for n tubes, the angle occupied by each tube is

$$\theta = 4\pi/n, \quad (8.18)$$

at the same time for each tube in accordance with Helmholtz theorems for each elementary jet the circulation and the momentum of the quantity of motion are conserved along its entire length:

$$G = 2\pi r v; L = mvr = \text{const}. \quad (8.19)$$

As it was shown above, the magnitude of the single charge is determined by the as

$$e = \rho v_{\text{эК}} S_p.$$

Since toroidal motion blurs the annular motion over the entire sphere of space, the mass flux of annular motion through the sphere will be determined from the expression

$$\int \rho v_{\text{эК}} dS = n\rho v S_{\text{эКр}}, \quad (8.20)$$

or

$$\int D dS = q, \quad (8.21)$$

where q is the total charge inside the sphere; $D = \rho v_{\text{ок}}$ is the aether density annular velocity flux, or, otherwise, the electric induction flux. The obtained expression corresponds to Gauss's theorem.

The process of electric field emergence at the appearance of ordered charges on the electrode surface is that the vortex motion of each tube begins to propagate along the tube axis. At the end of the tube the motion of the ether lies in the plane perpendicular to the tube axis, and therefore the speed of propagation of the electric field in vacuum is equal to the speed of the second sound in the ether – the speed of propagation of the transverse motion provided by the viscosity of the ether, this is the speed of light. The propagation speed of electric field in any material is smaller by k_p times,

$$k_p = \sqrt{\rho_m / \rho_s} \quad (8.22)$$

ρ_m is the density of the aether involved in the motion of the electric field in the material; ρ_s is the density of the aether in free space.

In optical media $k_p = n$, i.e. equal to the refractive index. Usually the refractive index is in the range of 1.4-1.6, so the density of ether involved in motion in the electric field is greater than the density of free ether only 2-2.5 times, i.e. it is about $2 \cdot 10^{-11} \text{ kg} \cdot \text{m}^{-3}$.

Comparing it with the mass density of the same optical glasses, which is of the order of $(2.65-3) \cdot 10^3 \text{ kg} \cdot \text{m}^{-3}$, we see that a very small part of ether is involved in the motion in the electric field, of the order of 10^{-14} of the total mass of ether forming the material. In metals, perhaps, this fraction is larger.

8.2.4. Capacitor (capacitance)

Consider a charged capacitor with a charge q on one of its plates and q on the other. The presence of equal and opposite in sign charges means that there is a concentration of elementary charges on the inner surface of one of the plates

$$n = q/e, \quad (8.23)$$

creating a field of n vortex tubes, the ends of which all enter the second plate, i.e. the number of tubes leaving one plate is equal to the number of the same tubes entering the second plate. If the charges

were not equal or had the same sign, there would be no such equality.

The cross-sectional area of one tube will be (on average)

$$S_o = S_k/n, \quad (8.24)$$

where S_k is the area of the condenser plate, and the annular velocity at the tube periphery is equal to

$$v_o = G/2\pi r_o, \quad (8.25)$$

where G is the intensity of ether circulation in the tube.

If the area of the tube is changed by increasing the number of these tubes - increasing the charge on the plates - the density of ether in the tubes ρ will change compared to the density of ether in the free medium ρ_3 :

$$\rho/\rho_3 = S_o/S = r_o^2/r^2. \quad (8.26)$$

As shown in [42-44], the Bernoulli equation is applicable to the helical flow as a whole. The pressure difference in the elementary jet at the vortex periphery and in the free ether is

$$\Delta P = \rho_3 v^2/2, \quad (8.27)$$

and for a vortex tube of circular cross-section the average pressure drop along the tube is [16, p. 115]

$$\Delta P = \rho_3 v^2/4, \quad (8.28)$$

for non-circular tubes

$$\Delta P = k\rho_3 \frac{G^2}{4\pi^2 r^2} = \dots \quad (8.29)$$

Here k is coefficient of proportionality, taking into account the shape of the tube cross-section.

Since the gas flow rate in each tube

$$v_o \rho_o = v\rho = \text{const}, \quad (8.30)$$

we get

$$\Delta P = k\rho v^2 = k \frac{v_0 2\rho_0 2}{\rho} = k \frac{G^2 \rho_0 2}{4\pi^2 r^4 \varepsilon}, \quad (8.31)$$

where ε is the relative density of the ether in the vortex tube in dielectric.
The total force acting on the plate of the capacitor is equal to

$$F = \Delta PS = k \frac{G^2 \rho_0 2S}{4\pi r^2 \varepsilon^4} = k' \frac{G^2 \rho_0 2S}{4S \varepsilon^2} = k \frac{G^2 \rho_0 n^2}{2\varepsilon_0 \varepsilon S} q^2. \quad (8.32)$$

Thus, the physical meaning of the relative dielectric permittivity ε is the ratio of the aether density in vortex tubes in medium (dielectric) to the aether density in a vortex tube in vacuum (in substance-free aether).

The following essential circumstance for the passage of electric field vortex tubes through a dielectric should be noted. The ether flows in these vortex tubes represent a stationary ether motion, which can lead only to a permanent displacement of the ether vortices, of which the dielectric substance itself consists, by some value, and some energy will be spent on the transition process, i.e. on the elastic displacement of molecules. Otherwise, the presence of a stationary vortex flow of ether in the dielectric cannot lead to any oscillations of matter particles. This means that the vortex energy is not consumed and has a reactive character (energy is not transferred into heat - energy of atoms vibrations).

8.2.5. A free electron in an electric field

Let us consider the motion of an electron - a helical vortex ring of compacted ether in a helical field of ether - an electric field. Having got into the vortex field, created also by helical toroidal formations of the aether, the electron is forced to unfold so that the plane of its circular motion coincides with the plane of circular motion of the aether in the tubes. Since in vacuum there is no collision with molecules of matter, the orientation of the electron unfolded along the field will be preserved indefinitely long. After that, under the action of the pressure difference acting on the electron, the latter must start its motion along the axis of the vortex tube.

When the directions of annular motion of the vortex field v_n and electron v_k coincide on the side of the particle that faces the field-forming vortices, the gradient of the annular motion velocity will be smaller than on the opposite side, and therefore the pressure of the aether on the side facing the field source will be larger than on the opposite side (Fig. 8.3).

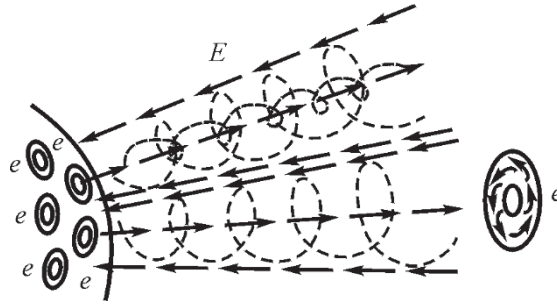

Figure 8.3. Electron in an electric field tube.

In accordance with the Bernoulli equation these pressures are defined by the expressions:

in the area of a :

$$P_a = P_0 - \rho_3 (v_e - v_n)^2/2; \quad (8.33)$$

in area b :

$$P_b = P_0 - \rho_3 (v_e + v_n)^2/2; \quad (8.34)$$

in the area of c :

$$P_c = P_0 - \rho_3 [v_e - (v_n - b dv_n/dg)]^2/2; \quad (8.35)$$

in area d :

$$P_d = P_0 - \rho_3 [v_e + (v_n - b dv_n/dg)]^2/2. \quad (8.36)$$

Here b is the thickness of the electron body; v_e is the annular velocity of the electron body; v_n is the annular velocity of the electric field; dv_n/dg is the gradient of the annular velocity of the field.

Having made corresponding calculations and neglecting small terms, we obtain the values of the pressure difference, which create a turning moment for the electron, and always in the direction of coincidence of the conductor axis and the vector of toroidal motion of the electron:

$$\Delta P = v_e \rho_3 b dv_n/dg = v_e \rho_3 E. \quad (8.37)$$

where $E = b dv_n/dr$

The force acting on the electron area element will be

$$dF = \Delta P E \sin \alpha = \rho v v_{en} \sin \alpha dS_r, \quad (8.38)$$

where S_r is the annular cross-sectional area of the electron, α is the angle between the principal axis of the electron and the axis of the electric field tube; E is the electric intensity.

Over the whole area of the electron the constant component of the annular velocity of the field does not create any force, because the increase of pressure in those parts where the directions of the flows of the annular velocities of the electron and the field coincide are balanced by the decrease of pressure in those parts where they have the opposite direction. Therefore, the additional pressure on the electron is created not by the velocity of the ether flow v_n itself, but by the circulation of velocity around the loop, and, consequently, the force acting on the electron from the side of the electric field is defined as

$$F = \rho v_{3e} \iint (dv_n/dg) \sin \alpha dr dS_e = q E \sin \alpha, \quad (8.39)$$

where

$$E = \int_0^b (dv_n/dr) dr. \quad (8.40)$$

Thus, the electric field strength, i.e. the force exerted by the electric field on the unit charge

$$E = F/q, \quad (8.41)$$

has its origin in the gradient of the circular velocity of the ether multiplied by the size of the electron. Hence the physical meaning of the electric induction D as the amount of ring motion of the ether in a unit volume can also be determined:

$$D = \varepsilon_0 E = \rho_0 \int_0^b (dv_{\text{in}}/dg) dr. \quad (8.42)$$

For an electron moving in free space in the direction of the force E , $\sin\alpha = 1$ (the principal axis of the electron coincides in direction with the direction of the axis of the electric field tube). Since the pressure is potential energy proportional to the square of the velocity of molecules, the force acting on the electron element will decrease by an amount proportional to the square of the relative velocity of electron motion v_q to the speed of propagation of circular motion in free medium - the speed of light c , i.e. by the amount $(v_q/c)^2$, hence,

$$E = E_0 [1 - (v_q/c)^2] \quad (8.43)$$

and at the velocity of motion of the particle equal to the speed of light, i.e. at $v_q = c$, $E = 0$, no matter how the value of E changes.

The latter means that as the velocity of the particle approaches the speed of light, the force acting on the particle decreases. Similarly, as the slip of the rotating magnetic field relative to the rotor in an induction machine decreases, the torque developed by the rotor decreases. This can explain the fact of impossibility of acceleration of a charged particle by an electric field of any, the largest intensity up to the speed of light, and not the fact that the speed of light is fundamentally insurmountable.

Thus, an expression for the electric field strength as a force acting on a unit charge is obtained. Assuming that the rotation speed of vortex toroidal rings - electrons - is constant, we obtain that the electric field strength is proportional to the vortex field strength, which is proportional to the number of vortex field tubes per unit area of the field.

If in free space the electron is left to itself, the electron, like any gas toroidal vortex, will start to accelerate in the direction of the flow coming from its central hole. However, in contrast to ordinary gas vortices, due to the special

the rarefaction of the ether and its small viscosity coefficient, and also by virtue of the fact that in the body of the electron the density of the ether exceeds the density of the ether in free space by tens of orders of magnitude, the time constant of the acceleration of the electron turns out to be very large and amounts to tens and hundreds of years. This explains the nature of cosmic rays, but in the conditions of an ordinary experiment the electron practically remains stationary, since its surface area is small, and the viscosity of the ether is also small, so the repulsive force of the electron from its environment is small, and the acceleration time is correspondingly long.

8.2.6. Physical essence of electric current in metal

In the absence of an electric field, electrons in a metal make chaotic thermal motion and have a chaotic, i.e. uniformly distributed orientation in space.

Under the action of an electric field, the chaotic motion of electrons in a conductor becomes somewhat ordered. This ordering manifests itself in two ways: firstly, electrons during the free run begin to orient themselves along the field, i.e., the direction of their axes acquires a common component along the direction of the electric field; secondly, electrons acquire some acceleration in the general direction along the field, increasing their speed and thus their kinetic energy. Therefore, despite the fact that collisions of electrons with the electron shells of the conductor atoms disorient them again, in general, a flow of electrons is formed that already have some common orientation along the direction of the electric field (Fig. 8.4).

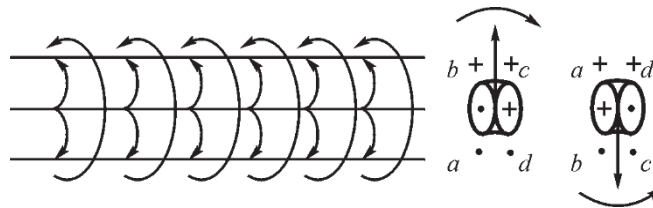

Fig. 8.4. Orientation of electron spins along the electric field.

This orientation by electrons is lost after each collision with the surfaces of metal molecules, but then partially restored

during the travel time between collisions. As a result, on average, the entire set of electrons in the metal is displaced along the axis of the conductor and, in addition, turns out to be deployed at a certain general angle relative to the plane perpendicular to the axis of the conductor. The value of this angle can be determined on the basis of the structure of the magnetic field arising around the conductor when an electric current passes through it.

The magnitude of the current flowing through the conductor is as follows

$$I = eNSv_q = edn/dt = dq/dt, \quad (8.44)$$

where e is the charge of an electron equal to $1.6 \cdot 10^{-19}$ Cl; N is the number of electrons in a unit volume of the conductor; S is the cross-section of the conductor; v_q is the velocity of displacement of electrons along the axis of the conductor; n is the number of electrons in charge q flowing through the cross-section of the conductor.

The velocity of electrons moving v_{np} along the wire with cross section S_{np} will be defined by the expression

$$v_{np} = \frac{I}{eNS_{np}}. \quad (8.45)$$

If we assume that the number of electrons N in the conductor is equal to the number of metal atoms, then the unit volume contains about 10^{30} m^{-3} electrons, hence, the average distance between electrons is $d = 10^{-10} \text{ m}$ and at the conductor cross-section of $S_{np} = 1 \text{ mm}^2$ we obtain that its cross-section contains $n_s = 10^{14}$ electrons, which corresponds to the charge

$$q_n = n_s \cdot e = 10^{14} \cdot 1.6 \cdot 10^{-19} = 1.6 \cdot 10^{-5} \text{ Cl}.$$

At a current of 1A, a charge of 1 Cl must pass through the conductor cross section in 1s, hence, $6.25 \cdot 10^4$ charges qn must pass. Taking into account that the average distance between electrons is 10^{-10} m , we obtain the average velocity of electrons moving along the conductor

$$v_{enp} = d q_n = 10^{-10} \cdot 6.25 \cdot 10^4 = 6.25 \cdot 10^{-6} \text{ m/s} = 6.25 \text{ } \mu\text{m/s}.$$

The electric field strength E is the force acting on a unit electric charge. The force acting on an electron,

is defined as the product of H , where e is the charge of the electron. Under the action of this force, the electron, having mass m , will acquire an acceleration equal to

$$a = He/m \quad (8.46)$$

and during the time Δt between collisions with the surfaces of atoms it will acquire an additional velocity Δv . If λ is the distance traveled by the electron between two collisions and v_{tcp} is the velocity of the electron, then the value of this time interval will be equal to

$$\Delta t = \lambda / v_{\text{tcp}}; \quad (8.47)$$

The conductivity of a conductor σ is the greater the higher the concentration of charges in a unit volume of metal, the greater the magnitude of the charge and the greater the mobility of the charge m , i.e., the increment of velocity referred to the force acting on the charge, i.e.

$$\sigma = Nem; \quad m = \Delta v_q / E; \quad \Delta v_q = a\Delta t = \frac{Its\lambda}{mu} \quad (8.48)$$

and, therefore,

$$\sigma = \frac{Ne^2\lambda}{mu} \quad (8.49)$$

The above formula for calculating the conductivity of metals was first derived by Drude in 1900. [26]. However, it should be noted that the very mobility of electrons depends on the density and viscosity of the ether in the van der Waals shells, within which the free electron moves.

Calculation of the electron free path length in various metals on the basis of reference data gives good agreement in orders of magnitude with those expected by theory. Thus at a temperature of zero degrees Celsius for copper $\lambda = 2.65 \cdot 10^{-10}$ m; for aluminum $1.64 \cdot 10^{-10}$ m; for tungsten $0.84 \cdot 10^{-10}$ m; for bismuth $3.7 \cdot 10^{-13}$ m. The latter circumstance indicates a very small value of the interatomic space in bismuth, in which free electrons can move.

Having acquired additional kinetic energy, electrons collide with greater force with the electron shell of atoms of the conductor, which explains the increase in the temperature of the conductor when the electric current passes through it. And since the amplitude of vibrations of the surface of the electron shell of atoms increases, the number of collisions of electrons with atoms increases, which is the reason for the increase in the electrical resistance of the conductor when heated.

When a conductor heats up, its resistance increases due to the increase in the amplitude of vibrations of the electron shells of atoms and the resulting reduction in the free path length of electrons. For copper, the relative reduction of the path length is $4.33 \cdot 10^{-3} \text{ K}^{-1}$, for aluminum - $4.6 \cdot 10^{-3} \text{ K}^{-1}$, and for a temperature change of 10 deg. the electron free path lengths will be $2.54 \cdot 10^{-10} \text{ m}$ and $1.56 \cdot 10^{-10} \text{ m}$, respectively.

The current density flowing through the conductor is determined from the expression

$$j = Ne\Delta v, \quad (8.50)$$

since it is proportional to the volume density of electrons in the metal, the value of the elementary charge and the average velocity of electrons along the conductor axis. Substituting the corresponding values of the quantities, we obtain:

$$j = \frac{Ne^2 \lambda}{mu} E = \sigma E, \quad (8.51)$$

which expresses Ohm's law in differential form.

Multiplying the left and right parts of the expression by the volume of the conductor $V = SL$, where S is the cross-sectional area of the conductor and L is its length, we obtain

$$jSL = \sigma ESL. \quad (8.52)$$

Since the value of the current in the conductor is

$$I = jS, \quad (8.53)$$

and the voltage drop across the conductor is

$$U = EL, \quad (8.54)$$

we get

$$I = \sigma \frac{US}{L} = \frac{U}{R}, \quad (8.55)$$

where

$$R = \frac{1}{\sigma} \frac{L}{S} = \frac{\rho L}{S} \quad (8.56)$$

is the active resistance of the whole conductor, and $\rho = 1/\sigma$ is its specific resistance.

The power used to create a current in the conductor will be:

$$P = F\Delta v V, \quad (8.57)$$

where $F = EeN$ is the force acting on electrons; Δv is the increment of electron velocity; $V = SL$ is the volume of the conductor. Substituting the corresponding values, we obtain

$$P = EeN \Delta v SL = E \Delta v \sigma SL = EL - E\sigma S = UI = I^2 R = U^2/R, \quad (8.58)$$

where U is the voltage drop across the conductor, I is the current in the conductor.

The expression reflects the value of the active power that must be expended in a conductor having resistance R for current I to flow in it. This power is spent to heat up the conductor and is not returned to the circuit.

The mechanism of superconductivity can also be considered from the above positions.

As the temperature decreases, not only the thermal velocity of the electrons themselves decreases, but also the amplitude of waves on the surfaces of the electron shells of molecules. Starting from a certain value, the metal electrons trapped in tubes of electric tension cannot overcome the holding force of the gradient currents of the tubes and cease to interact with the electron shells of atoms. The resistance disappears.

All the foregoing does not explain why, when electrons move along the conductor, there appears around it the

a magnetic field. But for this we must first visualize the essence of the magnetic field itself.

8.2.7. Physical essence of the magnetic field

The specific energy of the magnetic field is equal to

$$w_m = \frac{\mu_0 H^2}{2} = \frac{B^2}{2\mu_0} = \frac{\epsilon_0 c^2 B^2}{2} = \frac{\rho_e (Bc)^2}{2}, \text{ J/m}^3, \quad (8.59)$$

where μ_0 - magnetic permeability of vacuum; H - magnetic field strength; B - magnetic induction; ϵ_0 - dielectric permittivity of vacuum, ρ_e - aether density in vacuum, c - speed of light. From here it is immediately obvious that the magnetic induction B must formally be dimensionless. In fact, the magnetic induction is not dimensionless at all, but is the ratio of the velocity of the aether flow v_m , in the structure of the magnetic field lying in the plane hu , to the speed of light, i.e. to the speed of the second sound in the aether in the direction z . These two velocities are perpendicular to each other, and they cannot be reduced in dimensionality:

$$B = \frac{v_m}{c}, \text{ m/m}_{xyz}. \quad (8.60)$$

Thus, the *physical essence of magnetic induction is the velocity of the aether flow in the magnetic field structure, expressed in fractions of the speed of light.*

Since the magnetic field strength

$$H = V/\mu_0, \quad (8.61)$$

then

$$H = v_m/\mu_0 c = \rho_e v c_{2M} \quad (8.62)$$

Hence, we can see that *physical essence tension of the magnetic field is the progressive velocity of the aether density in the magnetic field structure, i.e. the specific quantity of the aether motion.*

From the obtained expression, the aether flux velocity in the magnetic field structure corresponding to the value of the magnetic field strength of 1 A/m can be directly determined:

$$v_M = H / \rho_3 c = 1 / 8.85 \cdot 10^{-12} \cdot 3 \cdot 10^8 = 376.65 \text{ m.s}^{-1}. \quad (8.63)$$

To the value of magnetic induction with the value of 1 Tesla corresponds the ratio of the velocity of the etheric flux to the speed of light in

$$B = \mu_0 H = 4 \pi 10^{-7} = 1.256 \cdot 10^{-6} \text{ m/m}_{xyz} \quad (8.64)$$

A conductor with a cross section of 1 mm² has a radius of $r_{np} = 0.564 \text{ mm}$ and a surface area of $3.54 \cdot 10^{-3} \text{ m}^2$. The conductor has a surface area per electron of $3.54 \cdot 10^{-27} \text{ m}^2$, which is greater than the conductor's surface area of $3.54 \cdot 10^{-10} \text{ m}^2$.

$$\frac{3.54 \cdot 10^{-27}}{3.54 \cdot 10^{-10}} = 1.4 \cdot 10^5 \text{ times. } 2.75 \cdot 10^{-32}$$

If the electron were oriented with its plane parallel to the plane of one of the sections of the conductor surface, this would correspond to a velocity of c

$$v_{\text{ноб}} = v_e / 1.4 \cdot 10^5 = 1.64 \cdot 10^{24} / 1.4 \cdot 10^5 = 1.17 \cdot 10^{19} \text{ m.s}^{-1}.$$

If a current of 1 A flows through a conductor, a magnetic field will appear on its surface, the strength of which is

$$H = \frac{i}{2\pi r_{np}} = \frac{1}{2\pi \cdot 0.564} = 282 \text{ A/m}, \quad (8.65)$$

which corresponds to a velocity of $1.06215 \cdot 10^5 \text{ m/s}$.

And that means that the electrons are only rotated by an angle of α

$$\alpha = \frac{2 \cdot 1.06215 \cdot 10^5}{1.17 \cdot 10^{19}} = 1.8 \cdot 10^{-14} \text{ rad.}$$

As shown in the preceding paragraph, under the influence of an electric field, all electrons, in whatever position they are

are found, turn their axes so that some common component of the projections of their spins on the axis of the conductor is formed. In relation to any part of the surface of the conductor, half of the electrons are turned to this surface, half to the opposite one, so that the circulation from each pair of electrons will give a total circulation, the axis of which will be oriented along the conductor (Fig. 8.5).

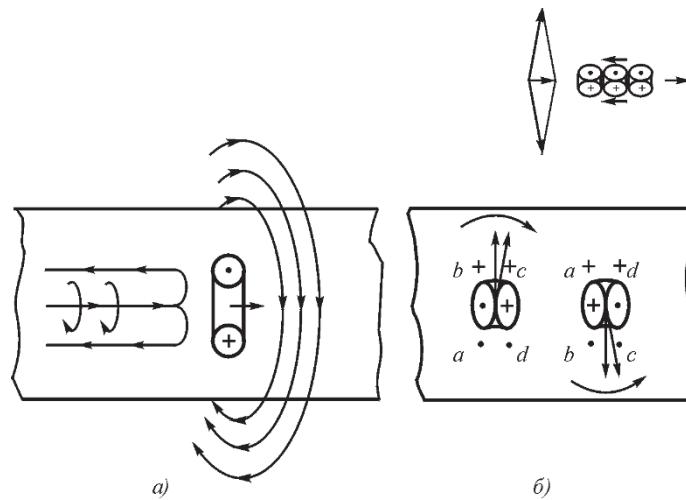

Fig. 8.5. Formation of a magnetic field around a conductor: *a* - orientation of the electron spin vector parallel to the conductor axis; *b* - summation of helical fluxes outside the conductor.

Proceeding from the fact that no additional magnetic fields are detected when moving in space, which is confirmed by specially set experiments, and also taking into account the experience of Ersted, who showed that the magnetic arrow is set perpendicular to the current conductor, we can see practically the only possible structure of the magnetic force line as a certain tube, in which the ether flows along the surface in one direction, and returns inside the tube in the opposite direction, and the tube itself rotates, so that along its surface the magnetic force line is formed by electrons, which themselves are helical toroids. Since the formation of the magnetic force line is performed by electrons, which are helical toroids themselves, the most probable structure of the magnetic force line is a set of

of helical toroids. The interaction of helical ether flows is shown in Fig. 8.6.

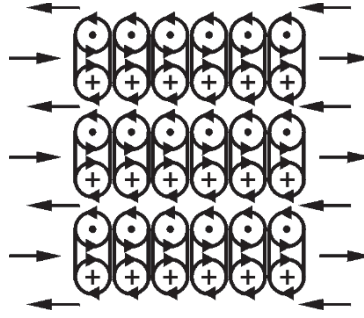

Fig. 8.6. Structure of magnetic force lines

Thus, the force line structures of the magnetic field and electric field are largely identical, but they also have differences. The electric field has a source of helical motion at the end, while the magnetic field has a source of helical motion from the surface of the whole tube, so the magnetic tube can be structured into a set of helical toroids, while the electric tube cannot. However, all this requires clarification.

From the expression

$$H = v_M / \mu_0 s \quad (8.66)$$

and the law of total current

$$i = \int H dl; H = i / 2\pi R \quad (8.67)$$

ensues

$$v_M = \frac{i\mu_0}{2\pi R}, \quad (8.68)$$

and if the helical flow velocity is higher in the material, then

$$v_M = \frac{i\mu_0 \mu}{2\pi R}, \quad (8.69)$$

where μ is the relative velocity of the ether flux in the material in comparison with the density of the same flux in vacuum.

The change in the velocity of the ether flow in the material is provided by the change in the orientation of the domains, which, by flows located at their periphery, either increase the total flow velocity (paramagnetics and ferromagnetics) or decrease it (diamagnetics).

Let us compare with the obtained dependence Ampere's law for the force interaction of conductors:

$$dF = \frac{\mu_0 \mu i i_2}{2\pi R} dl \quad (8.70)$$

and represent it in the form

$$\frac{dF}{dli_2} = \frac{i_1 \mu_0 \mu}{2\pi R}, \quad (8.71)$$

whence we see the complete identity of expressions for the velocity of the helical flow of the aether and Ampere's law for the force interaction of conductors.

As follows from the full current law, the decrease of the magnetic field strength around a rectilinear conductor with current should be hyperbolic and, therefore, the ratio of strengths should correspond to the expression

$$N_1 / N_2 = R_2 / R_1, \quad (8.72)$$

where R_2 and R_1 are, respectively, the distance from the center of the conductor to the points of measurement of magnetic field strengths. However, the ether is compressible, hence, for the magnetic field this circumstance should affect essentially. The given relation is valid only for small values of magnetic field strengths, for which its compression can be neglected. As the strength increases, deviations from this law must be observed. This circumstance was the subject of experimental studies, which confirmed this assumption.

If the magnetic field has the property of compressibility, the above relation must be violated, and the more so the greater the strength or current flowing in the conductor. By

analogy with a compressible liquid, this can be explained as follows: the liquid leaving the spinner (Fig. 2.5 in the upper part) is under greater tension than the liquid at some distance from the spinner. This means that with distance from the spinner the liquid will expand and add its energy to the motion, i.e. the velocity of the compressible liquid far from the center will be greater than the velocity of the incompressible liquid.

Fig. 8.7 shows the experimental dependences of H/H_0 ratios on the relative distance to the conductor center at different current values.

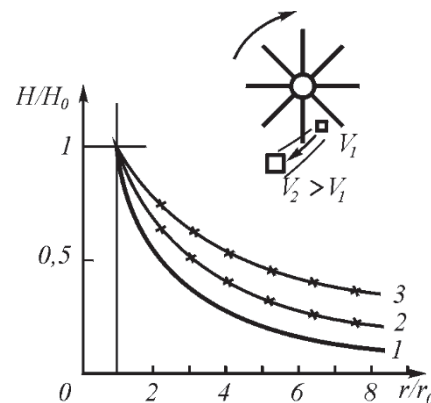

Figure 8.7. Experimental studies of the law of total current: *a* - mechanical analogy - change in the velocity of the compressible liquid flow driven by a spinner with blades; *b* - change in the magnetic field strength depending on the distance from the conductor axis; *1* - theoretical curve calculated from the condition of constancy of the magnetic field circulation; *2* - experimental results at current $I = 1$ A; *3* - experimental results at current $I = 10$ A. The measurements were carried out at frequencies of 50, 400 and 1000 Hz

As can be seen from the results of measurements, with increasing current in the primary conductor, the deviation of the magnetic field strength from the value determined by the law of total current becomes larger. With increasing distance from the conductor, i.e., with decreasing absolute value of the magnetic field strength, the dependence of the decreasing magnetic strength approaches the hyperbolic dependence defined by the full current law, and to a greater extent, the smaller this strength is. In this case, it would seem that the role of the boundary ones

effects should increase, but in fact it turned out that the edge effects are leveled out.

The interpretation of the magnetic field strength as the velocity of the laminar flow of the aether may raise certain objections.

First, as is known, Maxwell preferred to treat the magnetic field not as a translational, but as a rotational motion in connection with Faraday's discovery of the property of the magnetic field to rotate the plane of polarization of light in some crystals. However, Maxwell did not take into account that the gradient of the translational velocity of the ether can have the same effect.

Secondly, the magnetic field is not necessarily a purely translational motion of the ether. It can have a rotational component, and in different physical phenomena the ratio between the speeds of translational and rotational motions can be different. This possibility requires a separate consideration, but this variant will not contradict neither the above ideas about the electric field as a set of helical tubes with a helical factor variable in cross-section, nor the above ideas about the magnetic field strength as the speed of translational motion of the ether. Nevertheless, such modeling will make it possible to clarify the ideas about the physical essence of the magnetic field and its manifestations in different phenomena.

8.2.8. A free electron in a magnetic field

Let us consider the behavior of the electron in a magnetic field. The magnetic field itself cannot affect the orientation of the electron due to the mutual equilibrium of all forces acting on the electron from the field, regardless of the structure of the magnetic field itself and the predominance of the circular or translational component of the ether motion in it.

In fact (Fig. 8.8), in region 1 there is an attraction of vortices due to the ether flows in the plane of the figure, but repulsion due to the gas rotation, since the direction of the conjugate gas flows is the same - in the direction perpendicular to the plane of the figure. In region 2, everything is the opposite - repulsion of vortices occurs due to the rotation of aether flows in the plane of the figure, and attraction - due to the opposite direction of gas movements in the plane perpendicular to the plane of the figure. In this case, the components of the forces caused by the translational motion of the ether are balanced between

as well as the components of forces caused by the rotational motion of the ether are also balanced with each other.

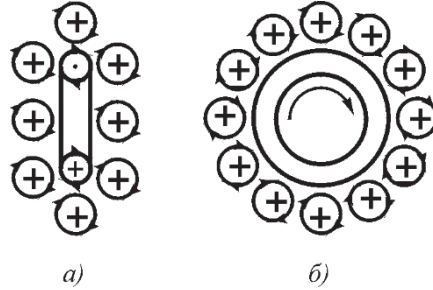

Figure 8.8. Equilibration of pressures acting on an electron in a magnetic field

The position changes essentially if an external force, for example, an electric field, gives to the electron a translational motion with velocity v . In this case, the velocity of translational motion of the electron is added to the velocity of the aether flow in the electric field v_n over the surface of the ring. The difference of the velocities lying in the plane of the drawing in region 1 will amount to

$$\Delta v_1 = v_e + v_n + v, \quad (8.73)$$

and in region 2, respectively

$$\Delta v_2 = v_e - v_n + v. \quad (8.74)$$

Their squares are respectively equal to

$$(\Delta v_1)^2 = v_e^2 + v_n^2 + 2v v_{en} + v^2 + 2v_e v + 2v_n v; \quad (8.75)$$

$$(\Delta v_2)^2 = v_e^2 + v_n^2 - 2v v_{en} + v^2 + 2v_e v - 2v_n v. \quad (8.76)$$

The difference of velocity squares in the direction perpendicular to the plane of the figure is respectively equal to:

$$\Delta v'_1 = v_e - v_n; \quad \Delta v'_2 = v_e + v_n. \quad (8.77)$$

Here the squares of velocity differences are

$$(\Delta v'_1)^2 = v_e^2 - 2v_e v_{en} + v_{en}^2; \quad (8.78)$$

$$(\Delta v'_2)^2 = v_e^2 + 2v_e v_{en} + v_{en}^2; \quad (8.79)$$

The sum of squares of velocities in each region will be equal to

$$(\Delta v_1)^2 + (\Delta v'_1)^2 = 2v_e^2 + 2v_{en}^2 + v^2 + 2v_e v + 2v_{en} v; \quad (8.80)$$

$$(\Delta v_2)^2 + (\Delta v'_2)^2 = 2v_e^2 + 2v_{en}^2 + v^2 + 2v_e v - 2v_{en} v; \quad (8.81)$$

and their difference is

$$[(\Delta v_1)^2 + (\Delta v'_1)^2] - [(\Delta v_2)^2 + (\Delta v'_2)^2] = 4 v_{en} v. \quad (8.82)$$

According to Bernoulli's equation we have

$$P = \rho_3 C - \rho_3 v^2/2 \quad (8.83)$$

and, therefore,

$$\Delta P = 2\rho v_{en} v. \quad (8.84)$$

The force acting on the equivalent surface area of an electron $S_{\text{эKB}}$, will be defined as

$$F = \Delta P S_{\text{эKB}} = 2\rho S_{\text{эKB}} v_{en} v = [\mathbf{B}\mathbf{v}], \quad (8.85)$$

which corresponds to Lorentz's law for an electron moving in a magnetic field. In this case, as can be seen from Fig. 8.9, the direction of the force is perpendicular to the direction of motion of the electron.

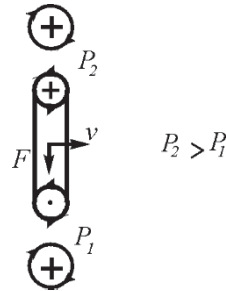

Fig. 8.9. Appearance of the deflecting force during the motion of an electron in a magnetic field

8.2.9. Inductance. Mechanism of self-induction phenomenon

The connected etheric flows are likened to a compressed spring, which has stored potential energy and tends to move electrons away from each other. In this case the pressure increment will be proportional to the value of the current flowing through the conductor.

For a solenoid, this pressure will be proportional to the number of ampere turns iw per unit of its length l :

$$p = \frac{iw}{l} \quad (8.86)$$

In the ISS system, the unit of current i is $[\text{kg} \cdot \text{c}^2]$, of length l is $[\text{m}]$ and hence the unit of pressure of the attached jets will be $[\text{kg} \cdot \text{m}^{-1} \cdot \text{c}^2]$ or $[\text{H}]$ (Newton), i.e. the same as for normal pressure.

The work done in compressing the attached ether streams is determined in the same way as the work done in compressing an ordinary spring. If for an ordinary spring the force of compression is proportional to the deformation, i.e.

$$F = kx, \quad (8.87)$$

where k is the elasticity coefficient, and the work done is defined by the expression

$$W = \int_0^x kx_0 dx = \frac{kx_0^2}{2} = \frac{F_0^2}{2k}, \quad (8.88)$$

where F_0 is the spring compression force, then for compressed ether flows we will have per unit length of solenoid

$$w = \frac{p^2 k (iw)^2}{2k l^2} \quad (8.89)$$

Comparing the obtained expression with the known expression for the solenoid energy

$$w = \frac{\mu (iw)^2}{2 l^2}, \quad (8.90)$$

we find that the physical meaning of the magnetic permeability of vacuum corresponds to the elasticity coefficient of the ether.

In the presence of iron in the choke core, *the* magnetic field created by the solenoid windings - ordered flows of aether - spends its energy on the reversal of domains - conglomerates of iron molecules. Such conglomerates are in the core in a non-ordered position, oriented relatively uniformly in space in all possible directions. But under the influence of a magnetic field - ordered circular flows of ether, which are the result of the ordered orientation of electrons in a current-carrying wire - the domains also unfold and form the magnetic field of the core. Here the magnetic field is already a set of helical vortex tubes, and its structure is thus different from the magnetic field produced by the current.

Thus, there is a sequential chain of events: the electric field in the conductor of the solenoid winding forces the electrons of the conductor to unfold with their principal axes in the direction of the conductor axis, thereby creating flows of circular motion of the aether around the conductor. The aether streams penetrate the iron core and force the domains to unfold accordingly in the general direction so that the axes of the helical tubes of the magnetic field,

created by the domains are oriented partially in the general direction, perpendicular to the direction of the external flow acting on them.

Since each such helical tube is connected to a corresponding domain in bond with the rest of the core material, these bonds are tense like a spring, and if the external flux disappears, they will return the domain to its original position. The magnetic field created by the core will disappear. This is the case with a magnetically soft material.

For a magnetically hard material the case is different. If the resistance of domain bonds in the material can be overcome by the external flux, they may not return the domain to the initial state. Then the magnetic field will remain even after the current is switched off from the solenoid winding.

But the simplest way to weaken the bonds of domains with the material is, as it is known, heating of magnetically hard material up to its melting. Then the external magnetic field easily orientates the domains in the desired direction, and then, after the material cools down, intermolecular bonds fix the domain in this position. The material becomes a permanent magnet.

With iron in the choke, the total stored energy of the magnetic field will be proportional to the volume of iron:

$$W = \frac{\mu \mu_0 (iW)^2}{2 l_{жк}^2} V_{жк}. \quad (8.91)$$

Since the iron volume of the choke is $V_{жк} = S l_{жк}$, where $S_{жк}$ is the cross section of the core and $l_{жк}$ is the length of the magnetic force line in the core, we get

$$W = \frac{\mu \mu_0 (iW)^2}{2 l_{жк}^2} S l_{жк}, \quad (8.92)$$

where μ is the relative magnetic permeability of iron. After abbreviations we have:

$$W = \frac{\mu \mu_0 (iW)^2}{2 l_{жк}} S = \frac{\mu \mu_0 (iW)^2}{2} S l_{жк} = L \frac{i^2}{2}, \quad (8.93)$$

where

$$L = \mu \mu \mu_0 \frac{S w^2}{l R_{\text{ж}}} = \frac{w^2}{M} ; R_{\text{M}} = \frac{l_{\text{ж}}}{\mu \mu \mu_0 S_{\text{ж}}} \quad (8.94)$$

Here R_{M} is the magnetic resistance of the core.

Thus the usual formula for the inductance of a coil with an iron core is obtained.

It can be seen from the above that the role of the iron core in inductance is reduced to the fact that the reactive energy of the magnetic field is stored in it. But in order to create this energy in it, it is necessary to do work, i.e. to rotate the domains of the iron core and to overcome the elastic resistance of their bonds. This work is done by increasing the pressure in the space between the conductor and the iron. This pressure itself is created by the electric current flowing through the conductor. Therefore, the total energy stored is proportional to the square of the current.

The circular motion of the ether around the conductor is perceived as a magnetic field. The energy of the translational velocity of the ether around a conductor without an iron core is the energy of this field. If there is an iron core, the potential energy of elastic rotation of the core domains is added here. This whole system is tense and is held in a tense state by electrons rotated in the general direction - along the axis of the conductor. The electrons themselves are held in this state by the electric field strength.

If the electromotive force in the conductor disappears, the cause holding the electrons in a common oriented direction also disappears, and the pressure holding the fluxes in a tense state also disappears. The equilibrium is broken, and the whole process reverses itself. Now the outer streams of ether press on the inner ones, and the circular current lines of ether, contracting, enter the conductor. Their energy is spent on increasing the thermal velocity of the electrons of the conductor. This is the mechanism of self-induction.

The reverse course of the process leads to the fact that the EMF on the conductor, created by the ether currents moving inside the conductor, acquires the opposite sign, this EMF will be proportional to the energy stored by the inductance, i.e. to the magnitude of the inductance, if the current is not cut off at once, the electrons of the still preserved current continue to hold a part of the pressure. Thus, at

the known formula of self-induction EMF can be justified at the qualitative level:

$$e = - L \, di/dt. \quad (8.95)$$

8.3. Electromagnetic interactions

8.3.1. Force interaction of conductors with current.

As is known, when currents flow through two parallel conductors, the conductors experience mutual attraction, if the currents flow in the same direction, or repulsion, if the currents flow in opposite directions. According to Ampere's law, the force of interaction of parallel conductors with current in vacuum is determined by the expression

$$F = - \mu_0 \frac{I_1 I_2 l}{4\pi d}, \quad (8.96)$$

where $\mu_0 = 4\pi \cdot 10^{-7} \text{ Gn}\cdot\text{m}^{-1}$ - magnetic permeability of vacuum; I_1 and I_2 - values of currents in the first and second conductors; l - length of conductors; d - distance between their axes.

The given known expression corresponds to the experimental data, however, does not express the physical essence of the interaction of wires with current. To understand the physical essence, let us consider the interaction of two electrons - compacted toroidal vortex vortex helical rings of ball shape, located each in one of two wires located parallel to each other.

The electron located in the first wire under the influence of the toroidal component of the electric field motion turns around so that the main axis of the electron is at an angle to the longitudinal axis of the wire smaller than $\pi/2$. For simplicity of the conclusion, we assume that the principal axes of the electrons and the axes of the wires coincide in direction; the real angle of rotation will be taken into account later.

According to the Bio-Savar's law, the toroidal component of the helical velocity of the aetheric flow decreases proportionally to the cube of the distance, and the annular component according to Gauss' theorem is -

is proportional to the square of the distance. Therefore, the toroidal component of the velocity is not taken into account in the following, and it can be considered that the interaction of electrons is carried out only under the influence of the circular component of the ether flows around the electrons.

The velocity of electrons moving along the wire at constant current I , A, wire cross-section S_{np} , free electrons content in the metal N , m^{-3} , charge of one electron e is:

$$v_{enp} = \frac{I}{eNS_{np}}. \quad (8.97)$$

Physically, the interaction between conductors is carried out due to the fact that electrons oriented in space create helical flows of aether around conductors, which are perceived as a magnetic field of currents (Fig. 8.10).

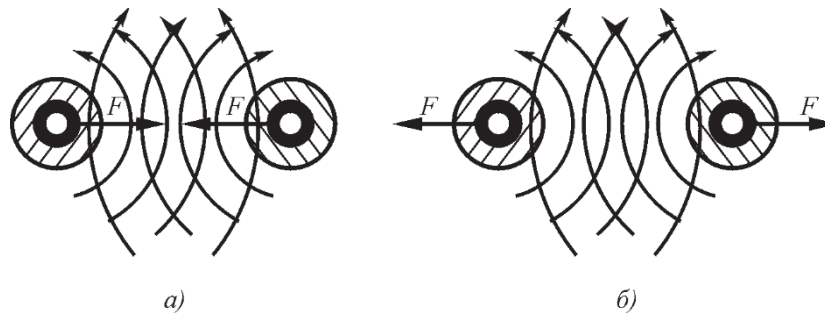

Fig. 8.10. Interaction of electrons in parallel conductors: *a* - when currents flow in one direction; *b* when currents flow in opposite directions.

At parallel orientation of electrons in both wires, the directions of annular motion of the vortex field v_n and electron v_k on the side of the particle that faces the field-forming vortices are opposite, the velocity gradient of the annular motion will be greater than on the opposite side, and therefore the pressure of the aether on the sides of the wires facing each other will be less than on the opposite sides.

In accordance with the Bernoulli equation these pressures are defined by the expressions:

in the area of a :

$$P = P_0 - \rho_0 (v_e - v_n)^2/2; \quad (8.98)$$

in area b :

$$P = P_0 - \rho_0 [v_e - (v_n - b dv_n/dr)]^2/2; \quad (8.99)$$

Neglecting the small terms, we obtain the pressure difference acting on the electron:

$$\Delta P = 2\rho v v_{en}, \quad (8.100)$$

where v_e is the velocity of the aether flow on the surface of the electron; v_n is the velocity of the aether flow created by the electron in the first wire on the surface of the electron in the second wire.

If the electron in the second wire were rotated so that the direction of its principal axis coincided with the direction of the axis of the conductor, the force acting on a single electron in the second wire would be an amount equal to:

$$F = 2\rho v v_{en} S \cdot \text{Sec} = 2\rho v v_{en} \pi r_e^2. \quad (8.101)$$

When the real angle α_2 of rotation of the electrons in the second wire is taken into account, the force on all electrons in the second wire will be:

$$F_2 = \rho v_{e2} 4\pi r_e^2 v_n \alpha_2 / 2 = en v \alpha_2 / 2, 2n_2 \quad (8.102)$$

where e is the electron charge; n_2 is the number of electrons in the second wire.

Let's transform the expression for Ampere's law

$$\frac{F}{l} = \mu_0 \frac{I I_2}{4\pi d} \quad (8.103)$$

For the current the following relation is true

$$I = v_{np} e S_{pr.sect} N, \quad (8.104)$$

where v_{pr} is the velocity of electrons traveling along the conductor; e is the electron charge; $S_{pr.sect.}$ is the cross-sectional area of the conductor; N is the number of electrons in the unit volume of metal, and

$$e = \rho v S_{\text{e}} = 4\pi\rho v r_{\text{e}}^2, \quad (8.105)$$

here ρ_3 is the density of the aether; v_e is the velocity of the ring flow of the aether on the surface of the electron, S_e is the surface area of the electron; r_e is the radius of the electron.

Substituting the expression for the current into Ampere's law and taking into account that

$$\mu_0 = 1 / \rho_3 c^2, \quad (8.106)$$

we get

$$\begin{aligned} & \frac{F_{v_{pr1} e_{Spr1N1} v_{pr2} e_{Spr2N2} \alpha_1 e_{Spr1N1} \alpha_2 e_{Spr2N2}}}{l} = \frac{4\pi\rho_3 c^2 d}{4\pi\rho d_3} \\ & \frac{\alpha_1 4\pi 4\pi \rho v r_{\text{e}}^2 S N_{np11} \quad \alpha_2 4\pi \rho v r_{\text{e}}^2 S N_{np22}}{4\pi\rho d_3} = \\ & = \frac{v r_{\text{e}}^2 N_2 \alpha_1}{d} \cdot 4\pi\rho v r_{\text{e}}^2 S N_{np22} \alpha_2 = \rho v_{\text{en}} \text{ (cirs)}. \end{aligned} \quad (8.107)$$

Here v_n is the velocity of the aether flows caused by the rotation of electrons in the first conductor; (cirs) is the total circulation of electrons in the second conductor:

$$v_n = \frac{v r_{\text{e}}^2 N_2 \alpha_1}{d}; \quad (8.108)$$

$$\text{(cirs)} = 4\pi v r_{\text{e}}^2 S N_{np22} \alpha_2; \quad (8.109)$$

e is the electron charge; v_{np1} and v_{np2} are the velocities of electrons traveling along the first and second conductors; S_{np1} and S_{np2} are the cross-sectional areas of the first and second conductors; N_1 and N_2 are the number of electrons per unit volume of the conductors; α_1 and α_2 are the angle of rotation of the ether flows in the conductors, so that

$$\alpha_1 = v_{np1} / s; \alpha_2 = v_{np2} / s. \quad (8.110)$$

Now the same formula of Ampere's law has acquired a clear physical meaning of interaction of electrons in wires: gradients of velocities of ether flows on the surface of electrons create additional pressure difference, electrons acquire additional velocity in the direction of the second conductor and give the received increment of momentum to molecules of their conductor. This leads to the appearance of the interaction forces of the conductors. It should be noted here that the obtained expressions for the rotation angles of the ether flows α_1 and α_2 are not the rotation angles of the electrons, which are substantially larger. The average rotation angles of the electron axes β can presumably be determined through the ratio of the electron velocity along the conductor v_{np} to the average velocity of thermal motion v_T :

$$\beta \approx \text{tg } \alpha = v_{np} / v_T. \quad (8.111)$$

It is of interest to give a numerical evaluation of some parameters involved in the force interaction of conductors.

If a direct current of strength 1 A flows in two conductors in one direction, then the force of attraction of the conductors having length 1 m and located in axes at a distance of 1 cm from each other is

$$F = 4\pi \cdot 10^{-7} / 4\pi \cdot 10^{-2} = 10^{-5} \text{ N.}$$

In this case, each conductor contains 10^{24} electrons located relative to each other at a distance of 10^{-10} m, i.e., each electron is located within one metal molecule, the velocity of electrons along the axis is $6.25 \cdot 10^{-6}$ m/s, and the rotation angles of the aether streams caused by the rotation of electrons are only $6.25 \cdot 10^{-6} / 3.10^8 = 2.08 \cdot 10^{-14}$ rad. Such a small angle of rotation of the ether flows does not mean the same value of the angle of rotation of the electrons themselves, which is much larger and in this case for temperature $+20^\circ \text{ C}$ is

$$\beta = 6.25 \cdot 10^{-6} / 1.15 \cdot 10^5 = 4 \cdot 10^{-11} \quad \text{rad.}$$

Thus, the force interaction of conductors is not due to the movement of electrons relative to the conductor, but due to the joint orientation of their spins relative to the axis of the conductor, which leads to the ordering of ether flows outside the conductor, which are perceived as a magnetic field formed by the current. These flows influence electrons, giving them an additional impulse in the transverse direction, which leads to the force interaction of conductors.

8.3.2. Conductor mutual induction

As is known, in electrical engineering there is no concept of "mutual induction of conductors", although there is a concept of "mutual induction of circuits". From the concept of mutual induction of circuits it is impossible to deduce the mutual induction of individual conductors, since the formulaic expressions of mutual induction of circuits include the area of the circuit. On the contrary, it would be possible to deduce the laws of mutual induction of circuits of any shape from the notion of mutual induction of individual conductors. Therefore, it is reasonable to find the laws of mutual induction of conductors.

According to the usual concepts of electrodynamics, when the current in the first circuit changes, an electromotive force is induced in the second circuit

$$e_{2M} = - M_{21} di_1 / dt, \quad (8.112)$$

where M_{21} is the mutual induction coefficient of the circuits.

The concept of mutual induction of circuits can be derived from Faraday's law

$$e_{2M} = - \frac{S dB}{2\pi dt}, \quad (8.113)$$

where S is the area of the contour; B is the magnetic induction.

Despite the fact that Faraday's law itself and Maxwell's equations leading to the same law are derived on the basis of the concept of the ether, which assumes direct interaction of electrom-

In fact, the concept of long-range action is clearly expressed here, since the process of changing the magnetic field occurs in one place (inside the circuit), the electromotive force appears in another place - at its periphery, and the mechanism of interaction of the field with the conductor is not provided.

However, in another law, the law of electromagnetic induction.

$$e = - Blv, \quad (8.114)$$

where B is the magnetic induction; l is the length of the conductor crossing the field; v is the velocity of movement of the conductor relative to the magnetic lines (Fig. 8.11), the law of close action is reflected, since there is a direct connection between the magnetic field and the conductor - the velocity of crossing the magnetic field by the conductor, although the mechanism of EMF generation is not disclosed here either.

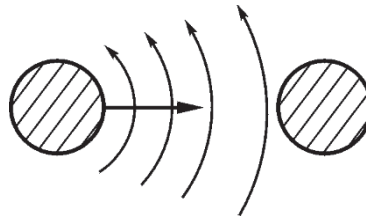

Fig. 8.11. EMF induction when a conductor crosses a permanent magnetic field - electromagnetic induction

To determine the EMF of mutual induction of two rectangular circuits it is necessary to use the full current law

$$i = \int Hdl, \quad (8.115)$$

from where

$$H = i / 2\pi R, \quad (8.116)$$

where R is the distance from of the current-carrying wire to the point of measurement of magnetic intensity H .

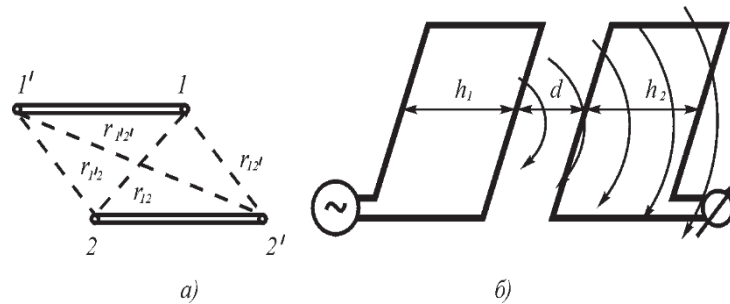

Fig. 8.12. To derive the coefficient of mutual induction of circuits

In accordance with Faraday's law, the coefficient of mutual induction between two wire lines is determined by the expression [45, p. 406]:

$$M_{12} = \frac{\mu_0 \mu}{2\pi} \ln \frac{r_{1'2} r_{12}}{r_{12'} r_{1'2'}} \quad (8.117)$$

Here r_{12} , $r_{12'}$, $r_{1'2}$, $r_{1'2'}$ are the distances between the conductors (Fig. 8.12, a). If the contours are in the same plane, then

$$r_{1'2} = d; r_{12'} = d + h_1; r_{12} = d + h_2; r_{1'2'} = d + h_1 + h_2. \quad (8.118)$$

Here d is the distance between the nearby conductors of the two circuits; h_1 and h_2 are the distances between the conductors in each circuit.

The mutual influence of the side conductors in the circuits can be neglected (verified experimentally). In this case, the magnetic field coming out of the wires of the first circuit enters the area of the second circuit, weakening as it moves away from the current-carrying wires of the first circuit according to the full current law (Fig. 8.10, b).

According to Faraday's law, the electromotive force in the second loop at $h_1 = h_2 = h$ will be determined by the expression

$$e_{2m} = - \frac{\mu_0 \mu}{2\pi} \frac{dI_1}{dt} \left[\int \frac{dR}{d} - \int \frac{dR}{d+h} \right] =$$

$$= - \frac{\mu_0 \mu l di_1}{2\pi dt} \ln \frac{(1+h/d)^2}{1+2h/d} = - M_1, \quad (8.119)$$

wh

$$\text{ere} \quad M_1 = - \frac{\mu_0 \mu (1+h/d)^2}{2\pi(1+2h/d)} = - f_1, \quad (8.120)$$

where

$$f_1 = \ln \frac{(1+h/d)^2}{1+2h/d}.$$

As can be seen from the obtained expression, the EMF in the second circuit increases indefinitely according to the logarithmic law as the area of the circuit increases. At $h \gg d$ we have:

$$M_1 = - \frac{\mu_0 \mu}{2\pi} \ln \frac{h}{2d}, \quad (8.121)$$

and when the value h rushes to infinity, the coefficient of mutual induction per unit length of the circuit also rushes to infinity, although according to the logarithmic law.

The approach to the same problem based on the concept of close action fundamentally changes its formulation. The magnetic field emanating from the conductors of the first circuit crosses first the near conductor of the second circuit and then, weakening as it moves away from the source, its far conductor. In this case, in the far conductor is induced EMF of opposite sign compared to the near conductor, and this emf decreases in accordance with the law of total current as the far conductor is removed from the first circuit. If, for example, the near conductor is at a distance in axes from the nearest conductor of the first circuit at a distance of 3 mm, and the far conductor - at a distance of 3 cm, then the EMF arising on the far conductor will be only 10% of the EMF arising on its near conductor, and if at a distance of 30 cm, then only 1%. Thus, there is a saturated dependence here, and there can be no infinite increase of the emf on the second circuit.

The total electromotive force occurring in the second circuit under the same conditions and taking into account the law of total current, will be determined by the expression

$$e_{2m} = - \frac{\mu_0 \mu l R_{np} di_1}{2\pi d dt} \left(1 - \frac{1}{1+h/d} + \frac{1}{1+2h/d} \right) = - M_2 \frac{di_1}{dt} \quad (8.122)$$

where the mutual induction coefficient M_2 is

$$M_2 = \frac{\mu_0 \mu R_{np}}{2\pi d} \left(1 - \frac{1}{1+h/d} + \frac{1}{1+2h/d} \right) = f_2 \frac{\mu_0 \mu R_{np}}{2\pi d} \quad (8.123)$$

where

$$f_2 = 1 - \frac{2}{1+h/d} + \frac{1}{1+2h/d}$$

Here, when h goes to infinity, the coefficient of mutual induction tends to a constant value

$$M_2 = \frac{\mu_0 \mu R_{np}}{2\pi d} \quad (8.124)$$

There is an essential difference between the expressions for M_1 and M_2 : while the first function tends to infinity with increasing h/d ratio, the second function is limited. When the return conductors of the circuits are removed to infinity, only the mutual induction coefficient of the nearby conductors remains in the expression. This is of particular importance for practice, since often the location of the return conductors is not known at all (e.g., when grounding the source and receiver of signals).

In those cases when $h \ll d$, we have

$$e_{21} = - \frac{\mu_0 \mu l di_1}{2\pi dt} \ln \left(1 + \frac{h}{d} \right) = \frac{\mu_0 \mu lh di_1}{2\pi d dt}; \quad (8.125)$$

$$e_{22} = - \frac{\mu_0 \mu l h^2 R_{np} di}{2\pi d^3 dt}; \quad (8.126)$$

where d is the distance between the axes of the conductor of the first circuit nearest to the second circuit; h is the distance between the conductors of the second circuit; l is the length of the circuits.

Here it is already possible to determine the mutual induction coefficient of the conductor segments.

Thus, the coefficient of mutual induction of conductors depends on which conductor is primary and which is secondary, and the coefficients of mutual induction of the first wire with the second and the second wire with the first are different, depend on the radii of conductors and are in the relation

$$\frac{M_{12}}{M_{21}} = \frac{R_{pr1}}{R_{pr2}}, \quad (8.127)$$

which is similar to the transformation ratio in a transformer.

Thus, the EMF induced in the second wire from the side of the first wire will be the value of

$$e_2 = - M_2 \frac{di}{dt} = - \frac{\mu_0 \mu R_0 l di}{2\pi d dt}; \quad (8.128)$$

whence the induced tension

$$E_2 = \frac{e_2}{l} = - M_2 \frac{di}{dt} = - \frac{\mu_0 \mu R_0 di}{2\pi d dt}, \quad (8.129)$$

or

$$E_2 = \frac{e_2}{l} = - M_2 \frac{di}{dt} = - \frac{\mu_0 \mu R_0 di}{2\pi d dt}; \quad (8.130)$$

and for sinusoidal alternating current the induced EMF will be equal to

$$e_2 = - \frac{\mu_0 \mu R_0 I \omega l}{2\pi d}. \quad (8.131)$$

Experimental studies of conductor mutual induction were carried out using two single-wire rectangular circuits with the length of adjacent sides being 1 m. The wire type BPVL-0.35 was used, the outer diameter of insulation of which was 1.5 mm. An alternating current of different frequencies was passed into the first wire, and the induced EMF was measured in the second wire. The distances h_1 and h_2 between the conductors of the circuits were changed equally. The measurements were carried out at a current value in the first circuit equal to 1 A in the frequency range from 50 Hz to 10 kHz.

Both dependences in relative form are shown in Fig. 8.13. The dependences f_1 and f_2 , calculated respectively on the basis of Maxwell's and ether dynamical ideas about the mechanism of eds guidance in the circuits, are also shown there. The crosses indicate the values obtained as a result of measurements.

As can be seen from the graphs, the obtained results fully satisfy the function f_2 , obtained on the basis of etherdynamic ideas about the EMF induction in conductors, and differ from the Maxwell dependence f_1 already at values $h/d = 10$ more than 4 times in the smaller side. The results presented by relative values do not depend on the values of frequency and current in the primary circuit. Thus, the conducted studies of the dependences of eds guidance in large circuits (area more than 1 m²) have shown their essentially better coincidence with the given expressions than with the Maxwell's ones.

The obtained results confirmed the independence of the induced eds from the circuit area at a sufficiently large distance of the return conductors. Consequently, in the future it is reasonable to use the notion of mutual induction of conductors.

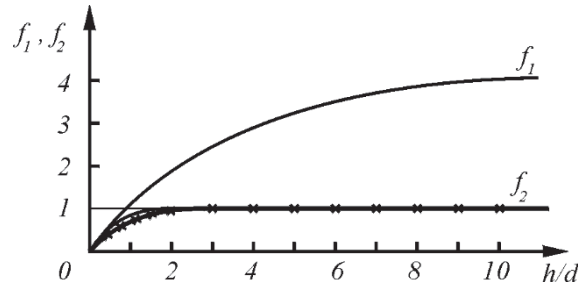

Fig. 8.13. Results of measurement of induced emf in a flat loop: dependence $f_1(h/d) \sim M_1$ and dependence $f_2(h/d) \sim M_2$.

Let us show the relationship between the force interaction dependence of conductors and the mutual induction of conductors. Let's transform the expression of Ampere's law

$$F = - \mu_0 \frac{I_1 I_2}{4\pi d} \quad (8.132)$$

into a slightly different form:

$$k(F) = \frac{F}{I_1 I_2} = - \mu_0 \frac{1}{4\pi d} \quad (8.133)$$

When $I_1 = 1$ A and $d = 1$ m, $k(F) = 10^{-7}$ N/m-A = 10^{-7} (unscaled).

Let's write out the expression for the induced voltage for alternating sinusoidal current

$$E_2 = - \frac{e_2}{l} M_{21} \frac{d}{dt} = - \frac{\mu_0 \mu R_{np1} I \omega}{2R_0} = k(F) 2R_0 \omega; \quad (8.134)$$

here R_{np1} is the radius of the current-carrying wire; ω is the circular frequency of the current flowing in it. From here we immediately see the connection between Ampere's law for force interaction of two wires with current and mutual induction between them.

In spite of the fact that the obtained dependences of the conductor mutual induction coefficient better reflect the real relations, the physical essence of the process is also not reflected in them.

From the expression for the electric intensity for alternating current it follows that

$$E_2 = \frac{e_2}{l} \dot{\epsilon} = \frac{\mu_0 \mu R_{np} \dot{\epsilon}}{2\pi d} = \frac{\mu_0 \mu R_{np} I \omega}{2\pi d} = \frac{v q n_{pe2} \omega R_{np}}{2\pi \rho_s c^2 d}$$

$$= \frac{2v v r_{pee}^2 n_2 \omega R_{np}}{c^2} = 2a v r_{1ee}^2 n_2 \frac{\omega R_{np}}{c \lambda d} \quad (8.135)$$

Let us compare the obtained expression with the expression for a wave propagating around a conductor in which an alternating current flows:

$$E_2 = \frac{dv_n}{dg} 2r_e \quad (8.136)$$

Here dv_n/dg is the velocity gradient of the circular aether flows in the secondary conductor caused by the rotation of electrons in the primary conductor; r_e is the radius of electrons in the secondary conductor.

The magnetic field excited in the space surrounding a current-carrying conductor propagates as a wave:

$$H = H(r) \sin \omega(t - r/c), \quad (8.137)$$

и, hence, annular velocity flows of the ether will propagate in the same way:

$$v_n = v_{no}(r) \sin \omega(t - r/c), \quad (8.138)$$

from where

$$E_2 = \frac{dv_n}{dg} 2r_e = \frac{v_n(r)\omega}{c} 2r_e \quad (8.139)$$

Comparing this expression with expression (3.63), we can see that

$$v_n(r) = v r_{ee} n_2 a_1 \cdot \frac{R_{pr}}{d}, \quad (8.140)$$

and, thus, the process of inducing EMF in the secondary conductor by the primary current-carrying conductor acquires a simple physical meaning: the electromotive force in the secondary conductor is created as a result of passing the gradient of the wave of transverse velocity of the ether excited in space by the electrons of the primary conductor, whose principal axes are partially oriented along its axis.

Let's determine the order of magnitude of electromagnetic induction in the cable at the following parameters:

wire cross-section 0.35 mm^2 ($R_{np} = 0.334 \text{ mm}$), current in the current-carrying wire $I = 1 \text{ A}$; wire length $l = 1 \text{ m}$;

distance in axes between wires $R = 2 \text{ mm}$; frequency of alternating current $f = 10 \text{ kHz}$. The EMF in the return wire can be neglected due to its remoteness. In this case, the induced EMF in the second wire will be:

$$e_{21} = \frac{\mu_0 I \omega R_1}{2\pi d} = \frac{4\pi \cdot 10^{-7} \cdot 1 \cdot 1 \cdot 2\pi \cdot 10^4 \cdot 0.3344}{2\pi \cdot 2} = 2.1 \text{ mV}. \quad (8.141)$$

Thus, the dependence obtained on the basis of the concept of close action not only better reflects the essence of the phenomenon, but also gives a significantly more accurate result.

Some considerations should be added to the above.

In [46, p. 166], the inductions on parallel wires of the BPVL type were measured at center-to-center distances of about 2 mm. A linear dependence on frequency was obtained, and at a current in the current-carrying wire of 1A at a frequency of 10 kHz, 20 mV/m was obtained on the second wire. However, it should be taken into account here that the electrodynamic component, which exceeds the value of the electromagnetic component, plays a significant role. This is due to the fact that there is a capacitive coupling between the wires, and the wires themselves have an inductance of the order of $1.6 - 2 \text{ } \mu\text{Gn/m}$. The electrodynamic component can be eliminated only partially by

shielding of the wires, because the shields also have a distributed inductive resistance.

The fact of dependence of the mutual induction coefficient on the ratio of wire diameters was also verified experimentally. As it was shown above, the mutual induction coefficient of conductors depends on the ratio of their diameters. Eds induced in the second wire from the side of the first wire will be the value of

$$e_2 = - M_2 \frac{dI}{dt} = - \frac{\mu_0 \mu R_0 l d i}{2\pi d dt}; \quad (8.142)$$

For an alternating current with frequency f this value is $\mu_0 \mu$

$$e_2 = \frac{R_0 l f I}{d}, \quad (8.143)$$

and if the secondary conductor lies directly on the surface of the primary conductor, so that the distance between the axes of the conductors does not differ significantly from the radius of the current-carrying conductor, then

$$e_2 = \mu_0 \mu l f I. \quad (8.144)$$

For a current of 1 A and a frequency of 1 Hz with a conductor length of 1 m, the EMF is as follows

$$e_2 = 4 \pi 10^{-7} \text{ V} = 1.25 \mu\text{V}.$$

As shown above, the mutual induction coefficient of the conductors depends on which conductor is the primary conductor and which is the secondary conductor, and the mutual induction coefficients of the first conductor with the second conductor and the second conductor with the first conductor are different, depend on the radii of the conductors, and are in the ratio of

$$\frac{M_{12}}{M_{21}} = f\left(\frac{R_{pr1}}{R_{pr2}}\right). \quad (8.145)$$

The measurement of the EMF induced by the magnetic field is complicated by the fact that simultaneously through the distributed capacitance the EMF of electrodynamic origin is induced, which has

approximately on the

order of magnitude greater than EMF of electromagnetic origin, and both values depend equally on the same parameters - current, frequency, location. And even shielding does not sufficiently reduce the electrodynamic component due to the presence of distributed inductance at the screen. This masks the whole process, but the qualitative side can still be revealed by using wires of significantly different diameters, using one or the other wire at the same value of current and frequency and measuring the induced EMF on the second wire.

To verify the dependence of the mutual induction coefficient on the diameters of the interacting conductors, an experiment was performed to determine the EMF induced from one conductor to another. The diameters of the conductors were essentially different (0.5 mm and 5 mm), and one of them was covered with chlorvinyl and cloth insulation (the outer diameter of the conductor with insulation was 6.5 mm), the second - with lacquer insulation. The center-to-center distance was 3.5 mm. The conductors were tightly adhered to each other. The load on the second (measuring) conductor varied from 10 to $1/3$ ohms. Such a small load resistance was necessary to remove the capacitive component of the flooding, which could not be done completely. Then the conductors were changed places according to the scheme.

A current of 3 A was passed, frequencies from 500 to 4000 Hz were used, and all measurements were made using magnetoelectric devices with thermocouples. The measurement results are summarized in Tables 8.2 and 8.3.

As can be seen from the tables, the coefficient of mutual induction of conductors really depends on which of them is the primary and which is the secondary. For 1000 Hz, the calculated value of the EMF induced from the primary conductor of smaller diameter to the secondary conductor of larger diameter at simple proportionality should be only 0.09 mV, and at their rearrangement of conductors - 1.16 mV. And although the ratios are obtained differently, which can be explained, for example, by the fact that at such proximity of conductors it is no longer possible to consider the entire current concentrated in their axial line, as well as the presence of capacitive (electrodynamic) coupling between the conductors, the dependence of the coefficient of mutual induction on the ratio of wire diameters at the qualitative level can be considered confirmed.

EMF on the secondary wire at current in the primary wire **3 A**, length of conductors **1.7 m**

Table 8.2.

Diameter primary wires, mm	Diameter secondary wires, mm	Frequency, Hz				
		500	1000	2000	3000	4000
0,5	6,5	10 mV	19	44	83	122
6,5	0,5	15	32	64	99	125
k _{2tr} /k _{1tr}		1,5	1,68	1,45	1,08	1,025

Recalculation of EMF on the secondary wire at a current in the primary wire of **1 A**, length of conductors **1 m**.

Table 8.3.

Diameter primary wires, mm	Diameter secondary wires, mm	Frequency, Hz				
		500	1000	2000	3000	4000
0,5	6,5	2 mV	3,8	8,8	16,6	24,4
6,5	0,5	3	6,4	12,8	19,8	25
k _{2tr} /k _{1tr}		1,5	1,68	1,45	1,08	1,025

Thus, it is experimentally confirmed the possibility and expediency of introducing into electrical engineering the concepts of mutual induction of conductors, on the basis of which it is already possible to determine the mutual induction of circuits by carrying out the corresponding integration.

8.3.3. Electrical transformer

As is known, an electrical transformer is a static device designed to convert the magnitude of alternating EMFs and currents. A transformer consists of several electrically unconnected and stationary windings connected by electromagnetic induction. One of the windings is primary, it is connected to an external source of EMF, the other windings are secondary, the EMF in them arises as a result of crossing their force lines of the magnetic field created by the current of the primary winding. From the secondary windings the voltage transformed by value is transmitted to the energy consumers.

Transformer with iron core due to the significant increase of coupling coefficient between windings allows at

significantly smaller dimensions than a coreless transformer to convert significantly higher powers.

The transformer calculation is based on Faraday's law

$$e = - \mu\mu_0 S dV/dt, \quad (8.146)$$

where e is the eds arising on a winding wound on an iron core whose cross-sectional area is S and whose material has a relative permeability μ ; dV/dt is the rate of change of magnetic induction in the core. Usually, transformer windings are calculated using another formula derived from Faraday's law:

$$e = - 2\pi\mu\mu_0 w^2 f I S / l, \quad (8.147)$$

where e - EMF on the winding, μ - relative magnetic permeability of iron core, μ_0 - magnetic permeability of vacuum, w - number of winding turns, f - frequency of supply voltage or current, I - amplitude of alternating current, S - cross-sectional area of the core, l - average length of the magnetic flux force line in the core.

The transformation ratio k for an unsaturated core is defined as the ratio of the number of turns of the secondary winding w_1 to the number of turns of the primary winding w_2 (in some reference books it is defined as the inverse of this value):

$$k = w_1 / w_2 = U_1 / U_2. \quad (8.148)$$

Here U_1 and U_2 are the voltages on the primary and secondary windings respectively when there is no load on the secondary winding of the transformer (no-load mode).

When analyzing the principle of transformer operation, a series of questions arise:

1. How is energy transferred by the magnetic field from the primary winding to the secondary winding?
2. What role does the iron core play in increasing the coupling coefficient between the primary and secondary windings?
3. Why at decrease of load resistance in the secondary winding and increase of current in it as a consequence, the current in the primary winding grows accordingly, i.e. what is the mechanism of influence of current in the secondary winding on the value of current in the primary winding?

The answer to the first question is fundamentally addressed above in the analysis of the electromagnetic coupling of conductors. Electrons in

primary conductor under the influence of the external EMF orient their axes of circular rotation (spin) along the conductor, resulting in circular flows of aether magnetic field around the conductor. These flows propagate into external space. If the aether flow directed perpendicular to the conductor axis is static, all pressures on the surface of the electron are balanced (Fig. 8.14, *a*) and it is not subject to any forced orientation. If the ether flux is not stationary, then there is a gradient of velocities of ether fluxes in the conductor, this leads to unbalanced pressures on the surface of the electron and a moment of forces is created, orienting the electron in such a way that its main axis (spin) is oriented along the axis of the secondary conductor (Fig. 8.14, *b*). Thus, there is a process of EMF transfer from the primary conductor to the secondary conductor.

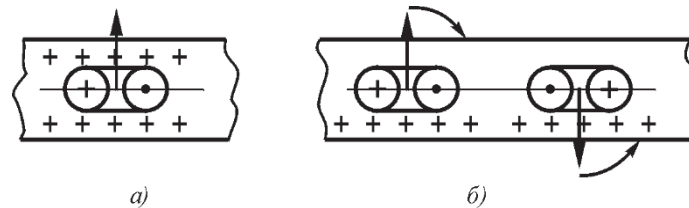

Fig. 8.14. The effect of aether flow on an electron in a conductor:
a - electron in stationary ether flow; *b* - electron in gradient ether flow.

If the secondary conductor is open, the induced EMF concentrates the electrons at one end of the conductor. Toroidal flows of electrons, already at the end of the conductor, create a force moment on the other electrons of the conductor, balancing the force moment created by the induced emf, the displacement of electrons along the conductor and their forced rotation stop.

If the secondary conductor is connected to the load, the electrons are displaced, the opposing orienting moment is weakened, all electrons of the conductor are oriented due to the difference of momenta of the influencing forces. A current appears in the secondary conductor.

The qualitative picture of the interaction between the magnetic field and electrons is rather conditional and should be further clarified.

If the transformer does not have an iron core, the magnetic field in space is distributed unstressed, this process is described by the

above with respect to the interaction of conductors and circuits. However, if the transformer has an iron core, the picture changes significantly. If the secondary winding of the transformer is open and there is no current in it, the transformer is the usual choke, iron-core inductance discussed above. The magnetic field is trapped in the space inside the iron core and therefore tenses like a compressible spring as the current in the primary conductor increases. This compression of the magnetic field prevents the electrons from turning around in the primary conductor, and there the current becomes less than it would be in the absence of the iron core. Then the following chain of interactions is formed: The EMF of the network creates an electrical tension in the primary winding, under the influence of which the electrons of the primary network orient themselves in space, creating circular flows of ether around them. These flows penetrate the iron core and unfold the domains, than the bonds of the domains with the rest of the core substance are strained. The larger the cross-section of the iron, the more domains need to be turned. This force is transmitted through the field to the electrons of the primary winding, and as a result the angle of rotation of the electrons is smaller than if the iron core were not present.

The presence of the iron core prevents the magnetic field from spreading beyond its limits. As a result, the pressure energy of the magnetic field is more fully utilized by the secondary winding and it is possible to maintain the same EMF value there with a lower load resistance.

The closest mechanical analogy here is a tube filled with gas, pressurized by a piston. In the tube there is a turbine capable of doing work. As long as it is stationary, the gas pressure is high, it is equalized, the piston is stationary and does not do work. However, if the turbine begins to rotate, doing work, the gas passes through the blades of the turbine to the outlet of the tube, begins to flow out, a pressure gradient is established in the vessel from the piston to the hole, and a certain rate of gas flow is established. The piston, moving, does work (Fig. 8.15).

If the pipe walls are not elastic enough, the gas expands the pipe walls when the pressure rises, a parallel gas outlet to the turbine is formed, and the turbine efficiency drops. In this analogy, the role of the pipe walls is played by an iron core. When the core becomes saturated, it ceases to shield the magnetic field, the elasticity of the field decreases, and the fraction of the field decreases

of energy entering the secondary winding. All this corresponds well to the known equivalent circuit of the transformer.

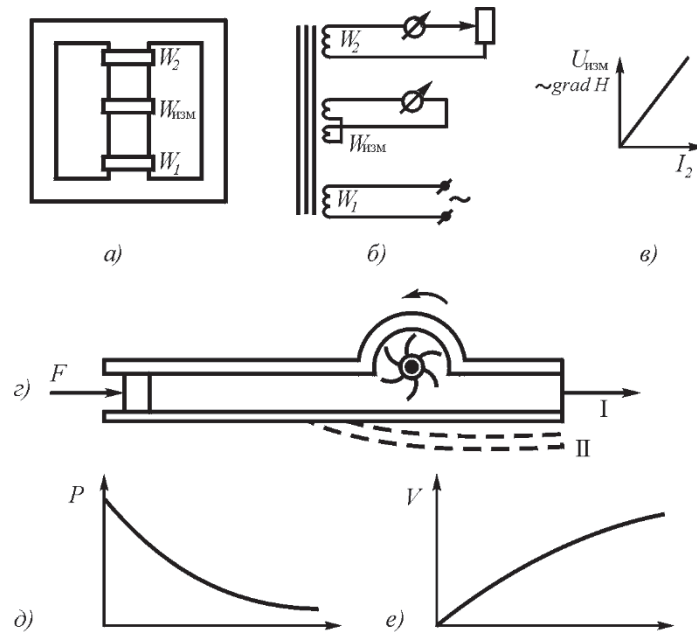

Fig. 8.15. Variation of the magnetic field intensity gradient in the transformer with changing the load on the secondary winding: *a* - scheme of winding placement in the experiment; *b* - electrical scheme of the experiment; *c* - change of eds on the measuring winding at change of load on the secondary winding; *d* - equivalent mechanical scheme of energy transfer in the gas pipeline; *I* - position of the elastic wall at low pressure; *II* - position of the elastic wall at high pressure; *e* - pressure diagram in the gas pipeline; *f* - velocity diagram in the gas pipeline

The presence of an open secondary winding does not change the situation in any way. However, if the secondary winding is connected to the load, then part of the energy of the ether flows created by the primary winding is transferred to the electrons of the secondary winding, the velocity of the ether flows decreases and the velocity gradient increases, respectively, the gradient of the magnetic field strength increases proportionally to the increase of the current in the secondary winding.

This can be verified quite simply. It is necessary to place the primary and secondary windings of the transformer at opposite ends of the iron core, and in the middle place a third winding consisting of two identical counter windings. It will show an EMF which will increase as the load resistance decreases and the current in the secondary winding increases. This EMF indicates a change in the magnetic field gradient when the current in the secondary winding changes. The supplied experiment has fully confirmed this. However, it does not follow in any way from the existing transformer theory.

In conventional transformer calculation formulas, the dependence of the EMF on how the windings are arranged on the transformer core is not foreseen, because in conventional transformers the primary and secondary windings are placed directly on top of each other. However, even in this case there are some discrepancies with the calculations, but they are explained by the so-called magnetic dissipation fields. In fact, the discrepancy with the calculations must be explained by the difference in the arrangement of the primary and secondary windings. As already pointed out above, the coefficient k_{tr} The mutual induction coefficient of the conductors depends directly on the distance between them. Therefore, as the windings on the transformer get farther apart, their mutual induction coefficient should also decrease. To verify this fact, the following experiment was performed

(Fig. 8.14).

On a ferrite ring having an outer diameter of 98 mm, an inner diameter of 60 mm and a thickness of 15 mm, there were two windings of 10 turns each, one of which could be moved along the ring (Fig. 8.16, *a*). The primary winding was powered from a sound generator, and the secondary winding was used to measure the eds in the idle mode. The measurements were carried out at frequencies of 20 and 200 kHz. The measurement results are summarized in the table and shown in the form of a graph in Fig. 8.16, *b*.

Table 8.4.

Frequency	Voltage on the second exchange, trans. coefficient.	Angle of winding separation on the core, deg (distance between winding centers, mm)			
		0° (0)	45° (30,6)	90° (55,9)	180° (79)
20 kHz	U_2 , mV	149	141	136	134
	k_{tr}	1	0,949	0,913	0,899
200 kHz	U_2 , mV	1534	1459	1401	1364
	k_{tr}	1	0,951	0,913	0,899

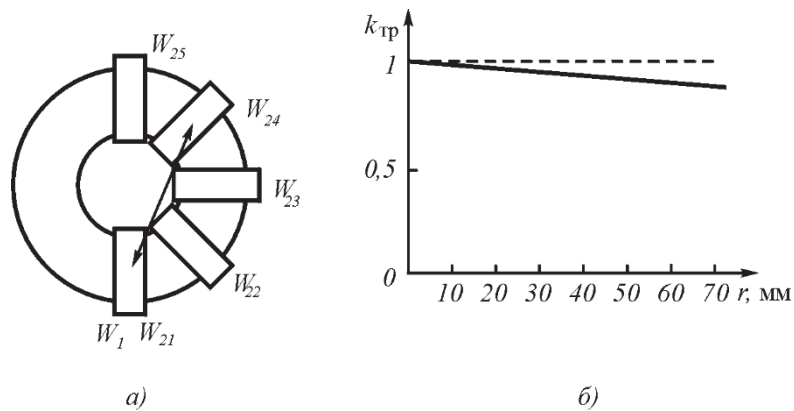

Fig. 8.16. Dependence of the relative value of the transformation coefficient on the interposition of the windings: *a* - scheme of winding arrangement on the ring core during the experiment; *b* - change of the transformation coefficient when the distance between the windings is changed.

Some of the variation in the readings can be attributed to the inaccuracy of the winding arrangement during the experiment. However, the final result of more than 10% reduction of the transformer ratio due to the windings moving apart on a common core cannot be attributed to this, just as it cannot be attributed to the traditional explanation of the effect due to magnetic dissipation fields.

8.3.4. Electromagnetic induction.

As we know, the law of electromagnetic induction

$$e = - Blv \quad (8.149)$$

reflects the process of inducing the electromotive force e in a conductor of length l when moving it with velocity v in a magnetic field whose induction is equal to B . This is the law of close action, directly reflecting the interaction between the magnetic field and a conductor moving in it.

Let us consider the physical nature of this process.

As it was shown above, the main type of motion of the ether in the magnetic field is still not rotational, but translational motion of the ether, which can be combined with rotational motion, but can also not be combined.

In the absence of a magnetic field, i.e., in the absence of external ether flows, the electrons in the conductor are in thermal motion, the average position of their principal axes being uniformly distributed in space. The position does not change if ether currents penetrate through the conductor, because whatever position the electron is in, all the pressure moments around it will be balanced.

The external flows of ether - the external magnetic field - on each electron create a braking pressure on the side of the electron that faces the flow. In accordance with the laws of gas mechanics, a gas seal is formed on this side, but the excess of this pressure, which creates a moment of force trying to turn the electron, is balanced by the same moment of pressure force on the other side of the same electron.

If the conductor starts to move relative to the ether flows, the symmetry of moments is broken.

To the circular rotation of the aether is added the velocity of the conductor, and at one side of the electron the electron's circular velocity is added to the velocity of the conductor, at the opposite end it is subtracted. (Figure 8.17).

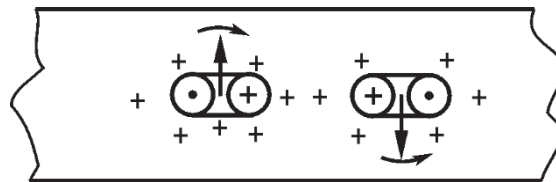

Fig. 8.17. Reorientation of electrons in a conductor when it moves in a magnetic field

A change in pressure on the side of the electron facing the flow causes an increase in the aether density on that side of the electron, so that

$$\rho_{\text{II}} = k_{\rho} \rho_{\text{I}} ; k_{\rho} = k v_{\text{VM}} > 1. \quad (8.150)$$

Here k_ρ is the coefficient of increase of the aether density; k_v is the coefficient of proportionality between the coefficient of increase of the aether density and the velocity of the external aether flux v_M , proportional to the value of the magnetic induction B .

The change in pressure on that section of the electron, ring motion in which coincides with the conductor motion, is

$$\Delta P_1 = k_\rho \rho_a (v_e + v_n)^2, \quad (8.151)$$

and at the section where the annular motion has opposite direction to the conductor motion, the pressure change will amount to

$$\Delta P_2 = k_\rho \rho_a (v_e - v_n)^2, \quad (8.152)$$

where v_k is the ring velocity at the surface of the electron; v_n is the velocity of the conductor. The difference of these pressures is

$$\Delta P = \Delta P_1 - \Delta P_2 = 4k_\rho \rho_a v_e v_n = 4k v v_{v_{eMn}} v, \quad (8.153)$$

and the magnitude of the moment that unfolds the principal axis of the electron in the direction of the conductor axis,

$$M = \Delta P S r_{ee} = 4k v v v S_{v_{eMn}ee} r, \quad (8.154)$$

where S_e is the equivalent part of the electron surface experiencing overpressure from the colliding flow; r_e is the radius of the electron.

Rotating all the electrons will create an electromotive force of the conductor, proportional to this rotation angle, and the electron rotation angle α_e will be proportional to the unfolding torque

$$E \sim \alpha_e \sim M \sim v v_{Mn} \sim B v_n, \quad (8.155)$$

voltage along the entire length of the conductor l will be equal to

$$e = El = B l v_n. \quad (8.156)$$

8.3.5. DC-magnet interaction

The interaction of a permanent magnet with the Earth's magnetic field has been known since ancient times. The interaction of a magnetic arrow with a

magnetic field created by a direct current flowing along a conductor was discovered by the Danish physicist H.K. Ersted only in 1820. [2, 3]. It was this discovery that triggered a large number of studies that eventually led to the creation of electrodynamics and electrical engineering. Ersted's experiment showed that a magnetized arrow placed over a conductor with current is deflected and set across the conductor (Fig. 8.18, *a*).

Mechanism of interaction of the laminar flow of ether created by the current flowing through the conductor and the axial component of the magnetic flux created by the compass arrow can be seen from (Fig. 8.16, *b*). In parallel flows, the velocity gradient is significantly smaller than in antiparallel flows, hence the nature of the interaction. It is possible that the vortex component also participates in the interaction of the magnetic arrow with the magnetic field of the conductor, but this component should play an auxiliary role.

From the position of ether-dynamic representations, the explanation of this phenomenon is that it shows the interaction between the ether flows created around the conductor with current by electrons oriented in space, whose main axis is partially deployed in the direction of the conductor axis, and the surface of iron domains oriented along the arrow axis.

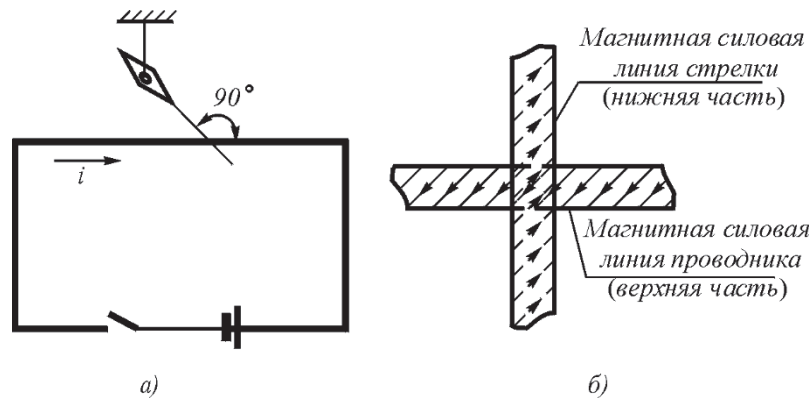

Fig. 8.18. Effect of direct current on the magnetic arrow (Ersted's experiment): *a* - scheme of the experiment; *b* - interaction of the field of magnetic domains of the arrow and the magnetic field of the conductor with current.

As can be seen from the figure, each domain will experience, from the side of the ether flow created by the electrons of the conductor, a moment of forces determined by the density of the ether near the surface of the domain, the velocity of the ether flow on the surface of the domain, the gradient of the flow velocity near the surface of the domain, and the angle between the directions of the external ether flow and the direction of the flow on the surface of the domain.

The ether pressure in the region of the intersection of the flows will be determined by the expression:

$$P = P_{\text{од}} + \rho v v_{\text{эод}} \cos \alpha, \quad (8.157)$$

where $P_{\text{од}}$ - pressure of aether on the domain surface at absence of magnetic field; $\rho_{\text{эод}}$ - density of aether on the domain surface; $v_{\text{н}}$ - velocity of magnetic field aether flux on the domain surface; $v_{\text{д}}$ - velocity of aether flux of the domain surface itself; α - angle between the fluxes.

From here it is immediately seen that the pressure minimum will take place at opposite directions of ether flows in the magnetic field and on the domain surface, i.e. at the maximum gradient of the ether flow velocity.

Since the velocity of the ether flux in the magnetic field is directly proportional to the magnitude of the current flowing in the conductor and inversely proportional to the distance D to it, and also proportional to the magnetic moment of the arrow $p_{\text{м}}$, the total moment $M_{\text{с}}$, acting on the arrow from the side of the conductor, will be determined by the expression

$$M_{\text{с}} = k \frac{I p_{\text{м}} \cos \alpha}{D}, \quad (8.158)$$

where k is the proportionality factor; α is the angle between the arrow and the conductor.

8.3.6. Interaction of permanent magnets

The magnetic force lines of permanent magnets are, in principle, helical flows of the aether. Most likely, the magnetic field is a system of vortex tubes in which the aether moves along the tube axis in one direction at the periphery and in the center in the opposite direction. The tube may be structured into a set of helical toroids. In this respect.

the structure of magnetic field vortex tubes has a certain similarity with the structure of electric induction vortex tubes with the essential difference that electric induction tubes have a circular motion of microparticles as their source, while magnetic tubes have toroidal motion. An electron caught in an electric induction tube experiences a turning moment and additional pressure of the ether from the source. An electron caught in a tube of magnetic tension experiences only rotation, and the pressure difference occurs only when it moves.

If the magnetic field represented only laminar flows of the ether, then at investigations of the ether wind by Michelson and subsequent researchers it would have been inevitably detected as a manifestation of the ether wind on the surface of the Earth, since at the magnetic field strength of the Earth from 33.4 A/m at the equator to 55.7 A/m at the pole the velocities of the ether flows would be from 12.580 km/s to 20.98 km/s, respectively. However, this component of the ether wind was not detected, hence it was less than 3 km/s, i.e., that value of the ether wind that was detected by Morley and Miller at Euclidean heights in 1905.

Thus, we have to state that the axial component of the flux along the axis of the magnetic force line, at least for the Earth's magnetic field, is small compared to the vortex (rotational) component. This is confirmed by the fact that the Earth's magnetic field decreases with distance from the Earth's center in proportion to the cube of the radius, i.e., according to the Bio-Savar law. However, this does not mean that this is true in all cases of magnetic field manifestation.

The mechanism of interaction of two permanent magnets differs from the one given above. At interaction of opposite poles (Fig. 8.19, *a*) in the air gap the directions of rotation of the tubes are the same, as well as the directions of axial displacement of the ether, the tubes unite, the velocities of the flows increase, the pressure in them falls, and by the external pressure of the ether the poles of the magnet are pushed to each other. At interaction of the poles of the same name (Fig. 8.19, *b*) the rotation of vortex tubes in the air gap between the poles is opposite, as well as the directions of axial flows. This causes the tubes to bend, which creates internal tension in them. The pressure of ether increases, the poles repel.

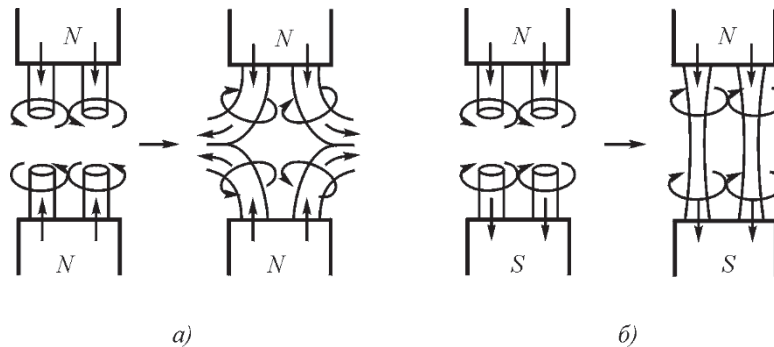

Fig. 8.19. Interaction of permanent magnets: for opposite poles (a); for opposite poles (b)

In the case of permanent magnets, the main role is played by the rotational component of the aether motion in the vortex tubes of the magnetic field.

It should also be noted that a simple helical motion of the aether combining translational motion with rotational motion without structuring into a set of helical toroids can also be perceived as a magnetic field. All the above statements for this variant remain valid.

To make a final judgment about the structure of the magnetic field, it is necessary to carry out special studies. The above ideas about the structure of the magnetic field are very preliminary and should be clarified.

8.4. Electromagnetic field

8.4.1. Maxwell's equations and their limitations

The development of hydromechanical models of electric and magnetic phenomena in the XIX century and now still faces great difficulties, because these phenomena are very diverse in form, and the models themselves can be based only on the concepts of turbulent and vortex motions of liquid or gas, so far studied far from being complete. Nevertheless, the development of such models in the past has been of great benefit; it was these models that formed the basis of the whole theory of electromagnetism and allowed the creation of its entire mathematical basis.

Practically all hydrodynamic models of electromagnetic phenomena can be divided into two groups. In the first group of models, the magnetic field is considered as a manifestation of the translational motion of the ether, and the electric field as a manifestation of the rotational (vortex) motion of the ether. This point of view was adhered to, in particular, by G. Helmholtz, W. Thomson, J. Thomson, and N. P. Kasterin. In the second group of models, the magnetic field was considered as a manifestation of the vortex motion of the ether, and the electric field as a manifestation of the translational motion. This point of view was adhered to, in particular, by J. Maxwell and V.F. Mitkevich.

Let α, β, γ be the components of the aether velocity, u, v, w be the angular velocities of vortices, and ρ_e be the aether density. Taking into account these notations, let us write the following equations for the first group of models:

$$\frac{d\alpha}{du} + \frac{d\beta}{du} + \frac{d\gamma}{dz} = \rho_e;$$

$$\frac{d\gamma}{du} - \frac{d\beta}{dz} = u;$$

$$\frac{d\alpha}{dz} - \frac{d\gamma}{dh} = v;$$

$$\frac{d\beta}{du} - \frac{d\alpha}{du} = w,$$

and determine the following correspondences:

$\rho_e \rightarrow \mu_0$ is the magnetic permeability of the vacuum;
 $\alpha, \beta, \gamma \rightarrow H_x, H_y, H_z$ - components of the magnetic field;
 $u, v, w \rightarrow E_x, E_y, E_z$ - components of the electric field.

For the second group of models we have the following correspondences:

$\rho_e \rightarrow \epsilon_0$ is the dielectric constant of the vacuum;
 $\alpha, \beta, \gamma \rightarrow E_x, E_y, E_z$ are components of the electric field;
 $u, v, w \rightarrow H_x, H_y, H_z$ - components of the magnetic field.

The phenomenon of rotation of the plane of polarization of light in a magnetic field discovered by Faraday testified in favor of the latter ideas.

In the models of the first group the representation of the magnetic field as a translational motion of the ether leads to the conclusion about the emergence of the magnetic field at any motion through the ether, which in fact does not exist and which caused fair criticism from the authors of the second group of models. However, in the models of the second group the representation of the electric field as a progressive motion of the ether leads to similar conclusions about the appearance of the electric field at any motion through the ether. This phenomenon is also not detected. Thus, the disadvantage of both groups of models was their apparent inconsistency with the experimental data.

An important disadvantage of the existing models of electromagnetism was the idealization and unlimited extension of the motions of the ether fluid and, as a consequence, of electromagnetic phenomena to the entire space surrounding the actual field of electromagnetic interactions and phenomena. This idealization was a consequence of Helmholtz's ideas about the motions of an ideal medium, according to which vortices could neither appear nor be annihilated, but could only move and change in cross-section while preserving circulation. Thus, the question of appearance and annihilation of vortex motions did not arise. Meanwhile, vortices can both appear and annihilate. This is all the more understandable when considering the phenomena associated with the passage of alternating current through conductors: in the absence of current, there is no magnetic field in the space surrounding the conductor, and when it appears, a magnetic field is formed in it, i.e. vortex movements of the ether. There is a contradiction of the model with reality.

As is known, the equations of electrodynamics according to Maxwell in the modern image have the form [47, p. 501]:

$$1. \operatorname{rot} \mathbf{E} = - \frac{d\mathbf{B}}{dt}; \quad (8.159)$$

$$2. \operatorname{rot} \mathbf{H} = \mathbf{j} + \frac{d\mathbf{D}}{dt}; \quad (8.160)$$

$$3. \operatorname{div} \mathbf{D} = \rho; \quad (8.161)$$

$$4. \operatorname{div} \mathbf{B} = 0; \quad (8.162)$$

Here: E and H , respectively tensions electrical and
magnetic fields; $\mathbf{D} = \epsilon E$ and $B = \mu N$ - respectively electric and

magnetic induction; ε and μ - electric and magnetic permeabilities of the medium; $\mathbf{j} = \sigma \mathbf{E}$ - conduction current density; σ - specific electrical conductivity of the medium; ρ - electric charge density in the medium.

In doing so.

$$\operatorname{rot} \mathbf{E} = \lim_{\Delta S \rightarrow 0} \frac{\int \mathbf{E} d\mathbf{l}}{\Delta S}; \quad (8.163)$$

$$\operatorname{rot} \mathbf{H} = \lim_{\Delta S \rightarrow 0} \frac{\int \mathbf{H} d\mathbf{l}}{\Delta S}. \quad (8.164)$$

To solve the system of Maxwell's equations, the scalar electric φ and vector magnetic \mathbf{A} potentials are introduced, so that

$$\mathbf{B} = \operatorname{rot} \mathbf{A}; \quad \mathbf{E} = - \operatorname{grad} \varphi - d\mathbf{A}/dt. \quad (8.165)$$

In this case, if the scalar potential φ has the physical meaning of the work that must be done to move a unit charge from infinity to a given point of the electric field, then the vector potential has only a purely mathematical meaning as some auxiliary function, the use of which has only methodological significance.

The above Maxwell's equations have differential form. They correspond to the equations of electrodynamics in integral form

1. Faraday's law of electromagnetic induction

$$e = \int \mathbf{E} d\mathbf{l} = - d\mathbf{F}_m/dt. \quad (8.166)$$

2. Law of total current

$$i = \int \mathbf{H} d\mathbf{l} = dq/dt. \quad (8.167)$$

3. Ostrogradsky-Gauss theorem for the electric field

$$\Phi_e = \int \mathbf{D} d\mathbf{S} = q \quad (8.168)$$

4. Ostrogradsky-Gauss theorem for the magnetic field

$$\Phi_m = \int \mathbf{B} d\mathbf{S} = 0. \quad (8.169)$$

Here F_e and F_m are, respectively, the fluxes of electric displacement \mathbf{D} and magnetic induction \mathbf{B} through the closed surface $d\mathbf{S}$ encompassing the free charge q .

Let's analyze the physical meaning of the equations one by one.

1. Maxwell's first differential equation

$$\text{rot } \mathbf{E} = - \, dB/dt \quad (8.170)$$

and its corresponding integral equation

$$e = \int E dl = - \, dFm/dt \quad (8.171)$$

express the fact that if the magnetic flux changes in a closed loop, the EMF e is excited in the loop itself, the magnitude of which will be determined by the above equations. In particular, if the contour lies in the plane hu , the magnetic induction has the direction of the z -axis perpendicular to the plane hu . Then we have:

$$e_{xy} = - \, \mu S dH_z / dt, \quad (8.172)$$

where S is the area of the contour.

1) The above equation assumes the possibility of changing the magnetic intensity along the z -axis without any transverse displacement of the magnetic field in space. However, it should be noted that such a process does not really exist in nature. In fact, the change of the magnetic field strength can be achieved only by densifying the lines of force and adding them to the loop *from the sides of the loop* (Fig. 8.20). In this case, the EMF in the circuit arises not due to a change in the magnetic field strength *inside the circuit*, but due to the *crossing of the conductors of the circuit by magnetic lines of force* added to those already present inside the circuit. Thus

Thus, the mechanism of EMF appearance in the circuit is different from that provided by Maxwell's first equation, and, accordingly, the equation describing this process must be somewhat different as well. The main thing is that in the first Maxwell's equation there is no description of the process of crossing of the conductor of the circuit by the magnetic field lines.

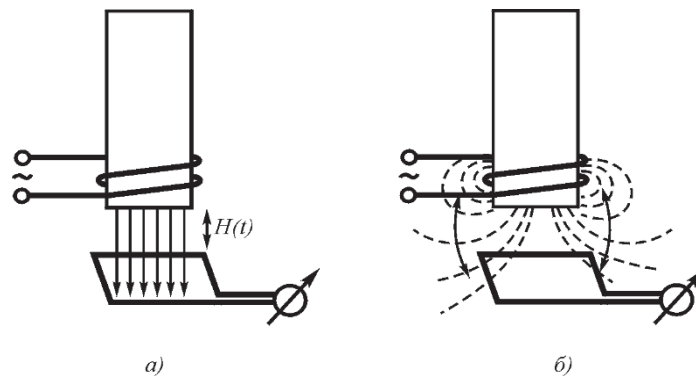

Fig. 8.20. EMF in a circuit: *a* - according to Maxwell; *b* - in reality

2) The first Maxwell equation describes the process in the plane, but not in the volume. The change of the intensity H_z along the z -axis is absent in it. The rotation of the plane in the coordinate axes, when all three Cartesian coordinates fall into the right and left parts of the equation, does not change the essence.

Why do Maxwell's first equation and the resulting Faraday integral law of magnetic induction allow good calculations of, for example, transformers and many other magnetic systems? The answer is simple. The change of the magnetic field inside the circuit is a consequence of the addition of magnetic force lines from the sides of the circuit, numerically they almost coincide, and this allows, ignoring the essence of the process, to perform in most cases the necessary calculations with satisfactory accuracy. But not in all cases, sometimes the deviations in calculations exceed the permissible errors, and quite significantly.

3) In the equation, the right and left parts are not equivalent. The right side of the equation is the cause and the left side is the effect. If by changing the magnetic induction at a constant rate a constant EMF can be created on a circuit, then the reverse action cannot

can be realized, because by creating a constant EMF on the loop no constant change of magnetic induction can be obtained. Therefore, it would be correct to put not an equal sign between the right and left parts of the equation, but the sign " \Leftarrow ", indicating that the left part is a consequence of the right part:

$$\operatorname{rot} \mathbf{E} \Leftarrow - \, dB/dt; \quad (8.173)$$

the same applies to the integral form:

$$e = \int \mathbf{E} d\mathbf{l} \Leftarrow - \, dF_M/dt. \quad (8.174)$$

It should be noted that there are no ways to swap the cause and effect in nature, i. e. if by changing the magnetic flux in time it is possible to create EMF in a circuit, then the reverse operation is impossible: it is impossible, by creating a constant EMF in a circuit, to get a time-varying magnetic field in it.

2. Maxwell's second differential equation

$$\operatorname{rot} \mathbf{H} = \mathbf{j} + dD/dt \quad (8.175)$$

and the corresponding integral equation (the law of total current)

$$i = \int \mathbf{H} d\mathbf{l} = dq/dt \quad (8.176)$$

express the fact that if a current flows in a conductor, a magnetic field appears around the conductor, the magnitude of which can be determined.

In principle, Maxwell's second equation can be divided into two parts:

$$\operatorname{rot} \mathbf{H}' = \mathbf{j}; \quad (8.177)$$

$$\operatorname{rot} \mathbf{H}'' = dD/dt. \quad (8.178)$$

The integral form - the law of total current - reflects only the first part, for the second part there is no analogous form, although it can be easily written, for example, in the form

$$\int \mathbf{H} d\mathbf{l} = S dD/dt. \quad (8.179)$$

In contrast to the first equation, Maxwell's second equation and the law of total current reflect the real process of the origin of the magnetic field around a conductor. However, some remarks can be made here as well.

1) The law of total current is an analog of the law of constancy of circulation for the vortex motion of a non-viscous and incompressible fluid:

$$\int \mathbf{v} d\mathbf{l} = G,$$

where \mathbf{v} is the velocity of the fluid flow around the vortex center, and G is the vortex tension. This law reflects vortex statics, i.e. the motion of the fluid in a steady vortex. Accordingly, both the total current law and Maxwell's second equation reflect the statics of the magnetic field, but not the dynamics at all.

2) Both in the second Maxwell's equation and in the law of total current there are no changes of processes in time, so, for example, if the value of current has changed, then according to the equation of the law of total current the value of intensity

$$H = i / 2\pi r$$

must change instantaneously regardless of the distance of the magnetic force line from the current conductor itself. The equation does not provide any lag of the process, which contradicts the meaning, because the lag of the effect (magnetic field strength) in relation to the cause that caused it (current) must be.

3) The second Maxwell equation, as well as the first one, describes the process in the plane, but not in the volume. Actually the change of the intensity E along its direction is absent in it. And just as in the first equation, the rotation of the plane in the coordinate axes, when the equation falls into both the right and left parts of the equation all three Cartesian coordinates, does not change the essence.

4) In Maxwell's second equation, as in the first, the right and left parts are not really equivalent. Here, too, the right-hand side of the equation is the cause and the left-hand side is the effect. If by varying the electric induction at a constant rate or by passing a direct current through a conductor, it is possible to create in the

magnetic field in the vicinity of the conductor, then the reverse action cannot be realized, since by creating a constant magnetic field in the vicinity of the conductor, no permanent change in the electric induction or the appearance of a direct current in the conductor can not be obtained. Therefore here too it would be correct to put not an equal sign between the right and left parts of the equation, but the sign " \Leftarrow ", indicating that the left part is a consequence of the right part:

$$\text{rot } \mathbf{H} \Leftarrow \mathbf{j} + d\mathbf{D}/dt \quad (8.180)$$

and the corresponding integral equation (the law of total current)

$$i = dq/dt \rightarrow \int \mathbf{H} d\mathbf{l}. \quad (8.181)$$

3. Maxwell's third differential equation

$$\text{div } \mathbf{D} = \rho; \quad (8.182)$$

and the corresponding integral equation - the Ostrogradsky-Gauss theorem for the electric field

$$F_e = \int \mathbf{D} d\mathbf{S} = q \quad (8.183)$$

have the same sin: there is no time factor in them, hence, they are static equations. True, if the Ostrogradsky-Gauss theorem in textbooks is usually placed in the electrostatics section, then the differential expression of the same - the third Maxwell equation - is placed in the same textbooks in the dynamics section, which is not justified in any way. The fact that the integral form is a static form can be easily seen from the fact that the electric displacement defined from this expression is

$$D = q/4\pi r^2 \quad (8.184)$$

must change instantaneously at change of charge q . The usual objection to this is that a single charge cannot be changed, and the introduction of an additional charge is an additional process, which is described in a completely different way. Nevertheless, the mathematical description must still provide for the presence of a delayed potential, and this is not present in the equation.

In addition, the equation should have also defined cause and effect relationships in the form of their corresponding spelling:

$$F_e = \int \mathbf{D} d\mathbf{S} \Leftarrow q, \quad (8.185)$$

as well as

$$D \Leftarrow q/4\pi r^2. \quad (8.186)$$

4. Maxwell's fourth differential equation

$$\text{div } \mathbf{B} = 0 \quad (8.187)$$

and the corresponding integral equation - the Ostrogradsky-Gauss theorem for the magnetic field

$$F_m = \int \mathbf{B} d\mathbf{S} = 0 \quad (8.188)$$

do not cause any special objections, except for their insufficiency, since they also fix some statics, besides, they also lack the time factor. Maxwell's fourth differential equation is also placed in textbooks in the dynamics section without any justification.

The integral form, placed in the section of statics, expresses the obvious fact that magnetic lines of force are always closed and, therefore, as many of them have left a closed surface as must enter it. It does not reflect any temporal processes.

Thus, the dynamic processes occurring in the electromagnetic field are reflected not by all four Maxwell's equations, but only by the first and half of the second equation, and the first equation does not reflect the real process of EMF generation in a conductor when the magnetic field changes in time. The first half of the second Maxwell's equation, as well as the third and fourth equations are equations of vortex statics and, in principle, have no relation to electrodynamics.

Both the first and the second Maxwell's equations ignore the fields outside the contours. However, neighboring unidirectional vortices, having on their periphery in adjacent regions flows of medium - aether of opposite direction, create mutual compensation of fields (Fig. 8.21). This circumstance was not taken into account by the first

by the two equations. If this were taken into account, both electric and magnetic strengths would not always be the same for the first and second equations.

Finally, all Maxwell's equations are derived from the assumption that the ether is ideal and, therefore, imply that it has no viscosity and compressibility. In such an ether, vortices can neither form nor disappear, which is completely inconsistent with experimental data: tensions and magnetic fields arise and disappear, but this is not embedded in the physics of the equations. The physics of Maxwell's equations also does not include the compressibility of fields, which directly follows from the compressibility of the aether.

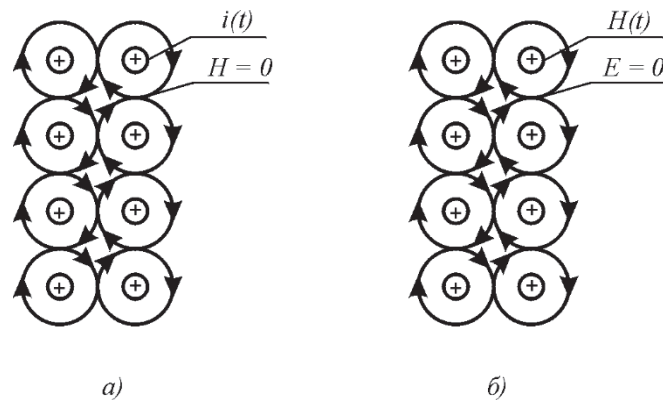

Fig. 8.21. Field compensations: *a*- magnetic field in a distributed system of currents; *b*- electric field in a distributed system of magnetic fluxes

The electromagnetic field equations obtained by Maxwell on the basis of hydromechanical representations of electromagnetic phenomena and their comprehensive testing in many practical applications confirm the validity of the method of analogies used by Maxwell, and, it would seem, from this does not follow the need for any clarification of the electrodynamic equations. However, these equations, in accordance with Helmholtz's ideas about the behavior of vortices in a liquid, reflect only the process of moving vortices in space and do not reflect the process of formation of these vortices. In order to consider the process as a whole, it is necessary to carry out additional constructions.

Thus, Maxwell's equations of electrodynamics are not perfect, just as nothing in the world is perfect. And that's why we need to keep working on them.

8.4.2. Some refinements of the equations of electrodynamics

Consider an elementary volume of a medium under the influence of the applied EMF and external magnetic fields (Fig. 8.22).

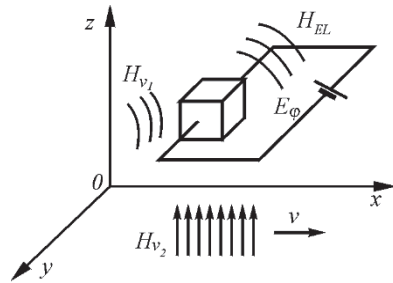

Fig. 8.22. Formation of **electric**-current in the medium.

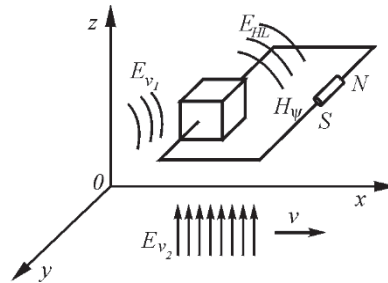

Fig. 8.23. Formation of **magnetic** flux in the medium.

Taking into account the electric field model, it follows that the current is a consequence of the electric tension acting in the circuit, and the magnetic field around the conductor is a consequence of the ordered orientation of electric charges in the conductor. For a medium element in a given circuit it is necessary to take into account four electric tensions summing up with each other and creating electric current: E_{ϕ} - tension from an external source of EMF; $E_{H_{v_1}}$ - tension induced by other currents changing in time, external to the considered volume; it should be remembered that the magnetic field creating this *EMF itself has a wave character*; $E_{H_{v_2}}$ - tension induced by the moving relative to the considered volume; $E_{H_{v_1}}$ - tension induced by the magnetic field induced by the magnetic field; $E_{H_{v_2}}$ - tension induced by the moving relative to the considered volume.

The current density δ_e , arising in the circuit, is determined by these strengths and the conductivity of the medium. In turn, the current will induce a magnetic field whose strength is equal to E_{HL} , so that

$$\operatorname{rot} \mathbf{H}_{EL} \Leftarrow \delta_e = (\sigma + \varepsilon -) \frac{\partial E_{\Sigma}}{\partial t} \quad (8.189)$$

where

$$E_{\Sigma} = E_{\varphi} + E_{Hv1} + E_{Hv2}$$

Similarly, when considering the elementary volume of the medium under the influence of the applied external MDS (magneto-motive force), as well as under the influence of external magnetic fields (Fig. 8.23), we obtain:

$$\operatorname{rot} \mathbf{E}_{HL} \Leftarrow \delta_m = - \frac{\partial \mu - H_{\Sigma}}{\partial t}, \quad (8.190)$$

where

$$H_{\Sigma} = H_{\psi} + H_{Ev1} + H_{Ev2}$$

Here H_i - magnetic field strength created by an external source of MDS; H_{Ev1} - magnetic field strength induced in the volume by electric currents external to the volume; H_{Ev2} - magnetic field strength induced from the side of the electric field source. field, moving relative to the volume under consideration (introduced by analogy with the phenomenon of electromagnetic induction); δ_m - magnetic current density.

It should be noted at once that the analogy used here is not a strictly correct and should be further experimentally confirmed.

In the absence of sources of magnetic and electric fields moving relative to the volume, the equations are transformed into the form

$$\operatorname{rot} \mathbf{H}_{\psi} \Leftarrow \delta_e = (\sigma + \varepsilon -) \frac{\partial (E_{\varphi} + E_{Hv1})}{\partial t} \quad (8.191)$$

$$\operatorname{rot} \mathbf{E}_{\varphi} \Leftarrow \delta_m = - \frac{\partial \mu - (\mathbf{H}_{\psi} + \mathbf{H}_{Ev1})}{\partial t} \quad (8.192)$$

The above expressions are modified Maxwell's Second and First Equations, differing from the latter in that the "third-party current" usually used in Maxwell's equations is expressed in terms of strengths, and also taking into account the sources of electric and magnetic fields external to the volume under consideration. The electromagnetic field equations presented in this form allow us to draw some different conclusions from the usual ones.

Indeed, in the general case, the magnetic and electric field strengths used in both equations are different, not the same, as is the case in Maxwell's equations. The magnetic field strength H_ψ , standing on the left side of the first equation (the modernized Maxwell's First Equation), is part of the whole electric strength on the right side of the second equation (the modernized Maxwell's Second Equation); the electric field strength E_φ , standing on the left side of the Second Equation, is part of the whole magnetic strength on the right side of the First Equation.

To show that the obtained result is not as trivial as it may seem at first sight, consider a special case in which $\delta_e \neq 0$, while $H_\Sigma = 0$, i.e., the current flows and varies in time, and there is no magnetic field.

Indeed, if the electric field is directed along the z -axis and in the plane h is uniformly distributed, then

$$\frac{eE_{\varphi x}}{du} = 0; \quad \frac{eE_{\varphi y}}{duh} = 0$$

hence

$$\text{rot } E_{\varphi z} = \frac{eE_{\varphi x}}{du} - \frac{eE_{\varphi y}}{duh} = 0, \text{ whence}$$

$$H_\psi + H_{E\psi} = 0,$$

i.e. there is a complete compensation of the magnetic field. In fact, all the second equation turns to zero, and the first equation remains in the same form.

Similarly, if the magnetic field is directed along the z -axis and is uniformly distributed in the h plane, then

$$\frac{dN_{\psi x}}{du} = 0; \quad \frac{dN_{\psi y}}{duh} = 0$$

then

$$\text{rot } H_{\psi z} = \frac{dN_{\psi x}}{du} - \frac{dN_{\psi y}}{duh} = 0, \text{ whence}$$

$$E_{\varphi} + E_{H_{\psi 1}} = 0,$$

i.e., the electric field is fully compensated. Then the first equation turns to zero, and the second equation remains in the same form.

In each point of space there is a complete compensation of the fields, internal and external in relation to any volume under consideration, although at first sight a paradoxical situation is formed: in the presence of time-variable electric current the magnetic field is completely absent. In fact, this field is fully compensated in each point of space, and if some volume of the conductor is removed, the corresponding magnetic field will immediately appear along the boundaries of this removed volume and in the volume itself. It is well seen in Fig. 8.19.

Experimental verification of the above statements confirmed them. In the experiment, a plane was used on which a number of wire circuits were placed in series, through which an alternating current was passed. The circuits created an alternating magnetic field in the surrounding space. A measuring frame was placed above the circuits, to which a measuring instrument was connected. The circuits were switched in such a way that the corresponding circuit of wire loops could be connected in turn (Fig. 8.24).

The experiment has shown that as the internal circuits are connected to the measuring frame, the EMF on it grows, and as the external circuits are connected to the frame, the EMF starts to decrease. This proved to be true for

of all frame sizes. Thus, the above statements were confirmed.

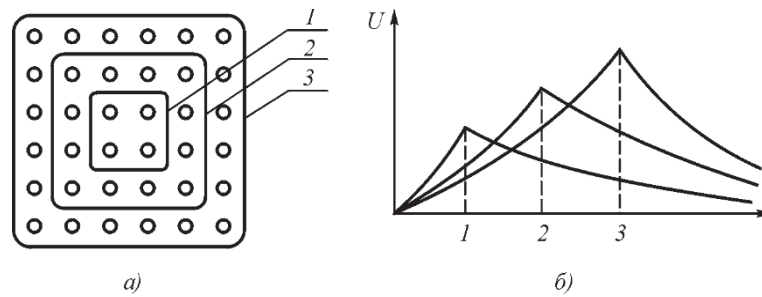

Fig. 8.24. Change of EMF on measuring circuits as the number of connected current-carrying circuits increases: *a* - arrangement of measuring circuits on a plate with current-carrying coils that create a magnetic field; *b* - EMF on a measuring circuit as current-carrying coils are connected.

It should be noted that the analyzed problem with uniform fields pulsating in time cannot be solved directly with the help of Maxwell's equations, since in them electric and magnetic strengths in both equations are equal to each other, and there are no "external currents" here either. It is difficult to trace the fact of mutual compensation of the constituent fields by these equations. The zero result as a solution of the problem on the basis of Maxwell's equations is possible only if all components of fields and currents are equal to zero, which contradicts the initial conditions of the problem.

The modernized equations of electrodynamics coincide almost completely with the first two Maxwell equations if we consider the boundary of a field propagating in space, provided that there are no field sources beyond this boundary (in the direction of propagation). Then the equations take the form of Maxwell's equations:

$$\operatorname{rot} \mathbf{H}_{\psi} \leftarrow \delta_e = (\sigma + \varepsilon -) E_{\varphi} \frac{\partial}{\partial t} \quad (8.193)$$

$$\operatorname{rot} E_{\varphi} \leftarrow \delta_M = - \mu - \mathbf{H}_{\psi} \frac{\partial}{\partial t} \quad (8.194)$$

Accordingly, Faraday's law can also be specified

$$e = \int E dl = - S dB_M / dt. \quad (8.195)$$

In the refined form, it will take the following form

$$e = \int E dl = - S d(B_i - B_e) / dt, \quad (8.196)$$

and at $B_i = B_e$ $e = 0$.

The indices "i" and "e" stand for "internal" and "external". By analogy with Faraday's law of electromagnetic induction on the basis of the electromagnetic field equation, we can propose an expression for magnetoelectric induction

$$(Hl) = S (\sigma + \epsilon -) \frac{\partial}{\partial t} (E_i - E)_e; \quad (8.197)$$

where S is the area of the contour covering the current flowing in the medium.

The difference from the full current law here also lies in the consideration of the fields external to the circuit.

Let us consider the process of propagation of the electric induction field in space. The fact of propagation of the vortex motion of the liquid along the vortex axis allows us to formulate the position that the flux of the vortex vector, and accordingly the flux of induction entering some volume, are not equal to the flux of the vector, and accordingly the flux of electric induction leaving this volume, and the difference will be due to the lag of the vortex flux along the axis.

If the flux of the electric induction vector D from the charge q passes through the surface of a parallelepiped with sides dx , dy , dz (Fig. 8.25), then the fluxes of the vector D passed through the faces are equal, respectively:

through the nearest fringe

$$- D_x dy dz; \quad (8.198)$$

through the far side

$$(D_x + \frac{dD_x}{dh} dx + \frac{dD_x}{dht} dt) dy dz; \quad (8.199)$$

through the left edge

$$-Dydx dz; \quad (8.200)$$

through the right edge

$$(Dy + \frac{dDy}{du} dy + \frac{dDy}{dt} dt) dx dz; \quad (8.201)$$

through the bottom edge

$$-Dz dx dy; \quad (8.202)$$

through the top

$$(Dz + \frac{dDz}{dz} dz + \frac{dDz}{dt} dt) dx dy; \quad (8.203)$$

Summing up the fluxes through all faces and dividing their sum by the volume of the parallelepiped, we find:

$$\frac{eD_x}{dh} + \frac{eD_x}{c_x dt} + \frac{eD_y}{dts_y dt} + \frac{eD_y}{dz} + \frac{eD_z}{c_z dt} + \frac{eD_z}{dz} = \rho, \quad (8.204)$$

where

$$with_x = dx/dt; with_y = dy/dt; with_z = dz/dt; \quad (8.205)$$

and thus,

$$\text{div } D + \frac{eD_x}{c_x} + \frac{eD_y}{dts_y dt} + \frac{eD_z}{c_z dt} = \rho, \quad (8.206)$$

$$\frac{1}{c^2} = \frac{1}{c_x^2} + \frac{1}{c_y^2} + \frac{1}{c_z^2} \quad (8.207)$$

or

$$\operatorname{div} \mathbf{D} + \frac{e\mathbf{D}}{c} = \rho, \quad (8.208)$$

which differs from Maxwell's third equation by the presence of the term $d\mathbf{D}/dt$.

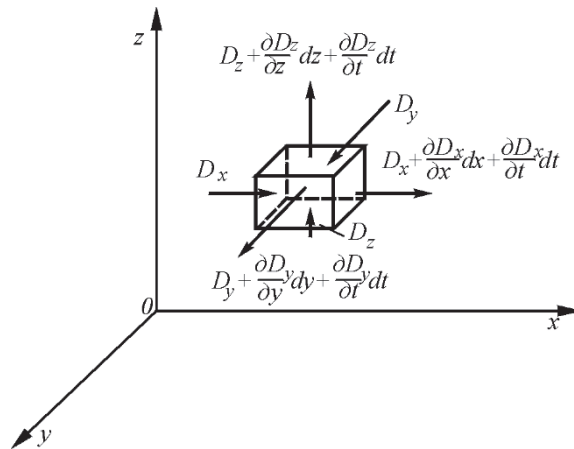

Fig. 8.25. To derive the equations of electric propagation inductions

The division of vector \mathbf{D} by vector c should not be disconcerting, since both of these vectors - the electric displacement and the velocity of its longitudinal propagation are collinear, i.e. directed strictly in the same direction, their ratio is a scalar.

The obtained first degree differential equation at $\rho = 0$ has a solution

$$\mathbf{D} = \mathbf{D} (t - r/c), \quad (8.209)$$

i.e., it is a wave, and the equation itself is a wave equation of the first degree and reflects the longitudinal propagation of the wave.

Gauss' theorem is slightly modified and acquires the following form:

$$F_e = \int_S \mathbf{D}(t - r/c) d\mathbf{S} = q(t). \quad (8.210)$$

Fig. 8.26 shows the longitudinal propagation of the electric field in the case of a pulsating charge.

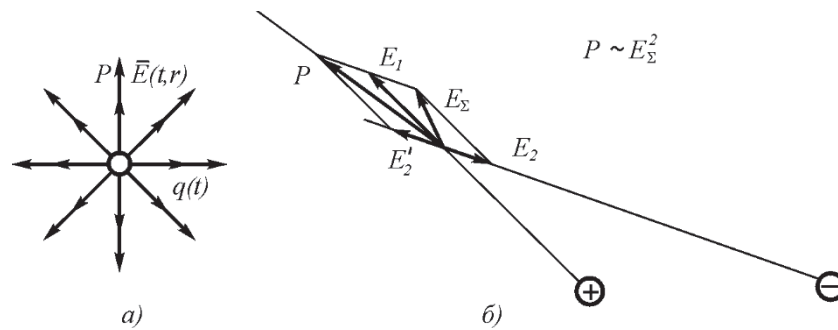

Fig. 8.26. Construction of the power density flux vector for longitudinal propagation of the electric field: *a* - for a pulsating charge; *b* - for a dipole

Since the current in the medium propagates along the flux \mathbf{D} and its density δ is proportional to \mathbf{D} , the following relation is valid for the current density

$$\text{div } \delta + \frac{d\delta}{c dt} = 0, \quad (8.211)$$

whence it follows that

$$\delta = \delta(t - r/c), \quad (8.212)$$

i.e. current propagation in the medium is of wave character.

This position contradicts the well-known static Kirchhoff's law that the sum of all currents for any point of the electric circuit at any time is equal to zero, i.e. that

$$\sum_{i=1}^n I_i = 0. \quad (8.213)$$

It follows from equation 8.211 that Kirchhoff's law is valid only in the average, but at each moment of time

$$\sum_{i=1}^n I_i \neq 0. \quad (8.214)$$

since the wave process implies compressibility of the current.

To verify this position, an experiment was carried out according to the scheme of Fig. 8.27.

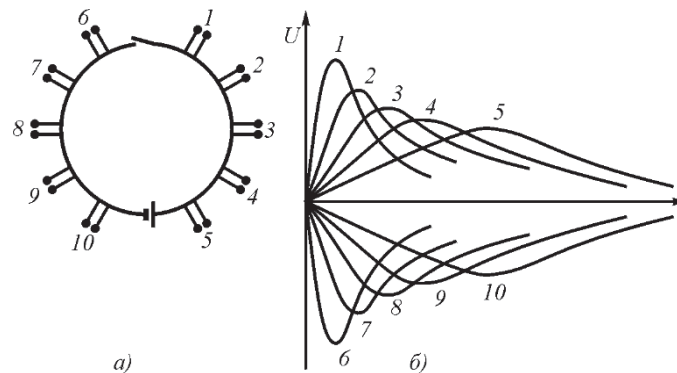

Fig. 8.27. Experiment to determine the fact of current compressibility: *a* - scheme of taps from the conductor; *b* - pulses arising on the taps

Two wires, each several meters long, were connected to a constant voltage source (an ordinary battery). From each of the wires were made branches after 1 meter. The wires were periodically closed by a contact. The leads were connected to a high-frequency electronic oscilloscope. The idea of the experiment was to determine how the current flows along the wire when the circuit is closed, at the open ends of which there is a full potential difference.

As a result of the experiment, it was found out that when the contact is closed, a sharp pulse with an amplitude almost equal to the full voltage of the source appears on the leads nearest to it, on the next leads this pulse is smaller in amplitude but wider in time, on the next leads it is even smaller in amplitude and wider in time.

Thus, the fact of current compressibility was confirmed.

If there are several charges in the medium from each of them in each point of the medium, there will be a summation of vectors of electric field strengths:

$$E_{\Sigma} = \sum_{k=1}^n E_k. \quad (8.215)$$

If each of the charges changes its value in time according to a sinusoidal law, then

$$E_{\Sigma} = \sum_{k=1}^n E_k e^{i[\omega(t - r_k/c)]} \quad (8.216)$$

where $i = \sqrt{-1}$, r_k is the distance from the point of the medium to the center of the charge.

Since the current density radiated into the medium is related to the voltage by the expression

$$\delta = (\sigma + \omega \varepsilon_0 \varepsilon) E, \quad (8.217)$$

where σ is the specific conductivity of the medium, $\omega = 2\pi f$, f is the frequency, ε_0 is the dielectric permittivity of vacuum, ε is the relative permittivity of the medium, then we have

$$\delta_{\Sigma} = \sum_{k=1}^n \delta_k e^{i[\omega(t - r_k/c)]} \quad (8.218)$$

In the case of two charges (radiating electrodes), pulsating with the same amplitude and frequency, radiating into the medium the same magnitude of current, but in antiphase (dipole), we have:

$$\delta\Sigma = \delta_1 e^{i[\omega(t - r_1/c)]} - \delta_2 e^{i[\omega(t - r_2/c)]} \quad (8.219)$$

Along the symmetry axis of the dipole we have

$$|\delta_1| = |\delta_2|; r_1 = r_2. \quad (8.220)$$

In this case, the total vector of current density is perpendicular to the direction of propagation along the dipole symmetry axis. Along the dipole axis we have at the distance between the charges (electrodes) $d = \lambda/2$, where λ is the wavelength in the medium, defined as

$$\lambda = c_r / f; c_r = c/\sqrt{\epsilon} \quad (8.221)$$

Here c_r is the velocity of current propagation in the medium, ϵ is the relative dielectric constant of the medium.

The current density at the radiating electrode having the radiating area S is

$$\delta_o = i_o / S, \quad (8.222)$$

and in an infinite medium at distance r from the electrode is defined as

$$\delta_r = \delta_o \frac{S}{4\pi r^2} \quad (8.223)$$

Along the dipole axis the current density will be

$$\delta_r = \frac{I}{4\pi r_1^2} \left[1 + \frac{1}{1 + \lambda/2r_1} \right] \quad (8.224)$$

Here r_1 is the distance along the dipole axis from the nearest electrode.

The current flowing from each electrode of a dipole with concentrated parameters propagates radially in all directions. And if the value of this current is known, the density of this current at each point of the medium is determined by a simple relation

$$\delta_e = \frac{i}{4\pi r^2} \quad (8.225)$$

It should be noted that the current density, at least in the near zone from the source, appears to be independent of neither the properties of the medium, nor of the time parameters of the current itself. The usual objection here is the presence of losses in the medium. However, it should be recalled that the current flowing through an ordinary resistor has exactly the same value at its output as at its input, despite the energy losses in this resistor, which are expressed by some value of the voltage drop across the resistor.

The speed of current propagation will be the same as the speed of propagation of electric induction, i.e.

$$cpr = c/\sqrt{\epsilon} \quad (8.226)$$

where c is the speed of light in vacuum and ϵ is the relative permittivity of the medium.

For a dipole with concentrated parameters consisting of two electrodes, the current density in the near zone is determined by geometric summation of two currents, respectively, taking into account their signs and delay. The summation of the currents shows that the propagation goes from the dipole in all directions, while along the axis of symmetry of the dipole the electric tension wave propagates in the transverse direction, and along the axis of the dipole - in the longitudinal direction. The latter circumstance is due to the fact that each point along the dipole axis is located at different distances from the electrodes and, therefore, the field strength from the near electrode in it will be greater than that from the far electrode. This voltage difference for a symmetric dipole with a distance between the electrodes d will be as follows for a direct current

$$\delta_e = \delta_{e1} + \delta_{e2} = \frac{i}{4\pi r^2} - \frac{i(2rd + d^2)}{4\pi (r + d)^2} = \frac{i}{4\pi r^2} \quad (8.227)$$

where r is the distance from the point to the near electrode.

If $d \ll r$, then

$$\delta_e = \frac{id}{2\pi r^3} \quad (8.228)$$

Of special interest is the case of AC dipole radiation, in which $d = \lambda/2$, where λ is the wavelength of the electric field in the medium. In this case, by the moment when the wave from the far electrode reaches the near electrode, the voltage at the near electrode will change polarity to the opposite one, and not the difference of electric voltages, but their sum will propagate further:

$$\delta_e = \delta_{e1} + \delta_{e2} = \frac{i}{4\pi r^2} + \frac{ii(2r^2 + 2rd + d^2)}{4\pi(r+d)^2} = \frac{i}{4\pi r^2} + \frac{i(2r^2 + 2rd + d^2)}{4\pi(r+d)^2} \quad (8.229)$$

that at $d \ll r$ will lead to the relation

$$\delta_e = \frac{i}{4\pi r^2} \quad (8.230)$$

i.e. not to cubic, but only to quadratic attenuation of tension with distance.

The conducted experiments confirmed, under the above conditions, the presence of an electromagnetic wave whose propagation direction and the direction of the vector of current density and electric intensity coincide. Maxwell's equations do not provide such a variant.

It should be noted that by selecting the distance between the electrodes it is possible to achieve that the main power propagates not in the transverse but in the longitudinal direction, and that the current density in the medium depends neither on the medium parameters, nor on the area of the electrodes, nor on the current frequency, but only on the magnitude of the radiated current.

For example, Fig. 8.28 shows an electric dipole with concentrated parameters, for which the necessary constructions of power density flux vectors have been made. From the constructions follows a not trivial conclusion that a dipole with concentrated parameters is able to radiate energy along its axis, which, of course, contradicts the conclusions following from the equations

Maxwell's dipole. The figure shows that along the dipole axis the vectors of power, propagation velocity and electric tension coincide in direction with the direction of the dipole axis, and across the dipole axis the vector of power and the vector of propagation direction lie in the dipole symmetry plane, and the vector of electric tension is parallel to the dipole axis and perpendicular to the direction of power propagation.

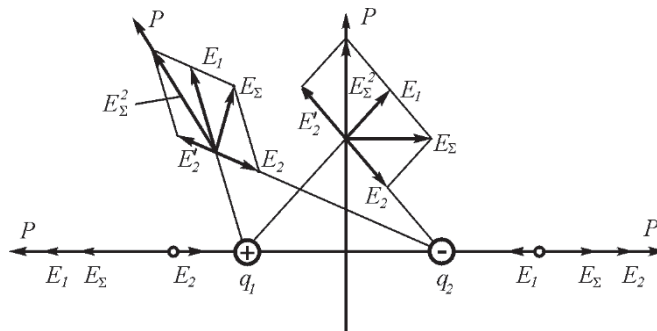

Fig. 8.28. Radiation of energy by a dipole with concentrated parameters

As was shown in Fig. 8.2, during the development of an elementary tube of electric field in the longitudinal direction at its end, the ether flux moves in the direction perpendicular to its axis. Consequently, the development of the electric field in space in all directions will occur with a velocity equal to the velocity of light propagation in this medium, regardless of the value of the power density flux vector.

Magnetic induction in a medium propagates differently than electric induction, namely perpendicular to the direction of the vector. Therefore, the following relations are valid for vector B :

$$\operatorname{div} B = 0; \quad (8.231)$$

$$\operatorname{div} \operatorname{grad} B + \frac{d \operatorname{grad} B}{c dt} = 0. \quad (8.232)$$

The total current law for small magnetic field strengths should be converted to the form:

$$i(t) = \int \mathbf{H}(t - r/c) d\mathbf{l} = dq(t)/dt. \quad (8.233)$$

In formulating the law of total current, we should take into account the fact of compressibility of the ether, hence the compressibility of the magnetic field itself and the change of the law of hyperbolic decrease of the magnetic field strength near the conductor.

In view of the above, the equations of the electromagnetic field take the form:

$$1) \operatorname{rot} \mathbf{H}_\psi \Leftarrow \delta_e = (\sigma + \varepsilon - \frac{\partial}{\partial t})(E_\phi + E_{Hv1} + E_{Hv2}) \quad (8.234)$$

$$2) \operatorname{rot} E_\phi \Leftarrow \delta_m = - \mu - \frac{\partial}{\partial t} (\mathbf{H}_\psi + \mathbf{H}_{Ev1} + \mathbf{H}_{Ev2}) \quad (8.235)$$

$$3) \operatorname{div} \mathbf{D} + dD/dt = \rho; \quad (8.236)$$

$$4) \operatorname{div} \delta_e + d\delta_e/dt = 0. \quad (8.237)$$

$$5) \operatorname{div} \mathbf{B} = 0; \quad (8.238)$$

$$6) \operatorname{divgrad} \mathbf{B} + e(\operatorname{grad} \mathbf{B})/dt = 0; \quad (8.239)$$

The integral expressions will acquire in Id:

$$1) e = \int \mathbf{E}(t - r/c) d\mathbf{l} = - dF_m(t)/dt; \quad (8.240)$$

$$2) e_m = \int \mathbf{H}(t - r/c) d\mathbf{l} = \mathbf{i}(t) = d\mathbf{q}(t)/dt; \quad (8.241)$$

$$3) \Phi_e = \int \mathbf{D}(t - r/c) dS = q(t); \quad (8.242)$$

$$4) F_m = \int \mathbf{B} dS = 0. \quad (8.243)$$

Here e and e_m are electric and magnetic potential difference; Φ_e and Φ_m - electric and magnetic fluxes; \mathbf{i} - electric current in the conductor; \mathbf{q} - charge moving in the direction of electric current (directed movement gives it the form of a vector).

The first expression is Faraday's law of electromagnetic induction and

second, the full current law differs from the usual ones by the presence of a lag in them.

The above equations of the electromagnetic field have Maxwell's equations as a partial solution, which are valid for the electromagnetic wave front, but in some cases they allow to solve some problems which cannot be solved on the basis of Maxwell's equations, for example, the problem of radiation of a dipole with concentrated parameters in a semiconducting medium. If a number of conditions are fulfilled in such a dipole, the main part of the energy will propagate not in the transverse direction with respect to vectors E and H , but in the direction of vector E and perpendicular to vector H . This longitudinal propagation of the electromagnetic field has not been practically studied yet, although it has been confirmed experimentally.

It should be noted that the above does not end the refinement of the electromagnetic field equations. This process should continue as long as there is a need for more and more complete solution of applied problems.

Thus, the ether dynamical representations allow to specify the formulations of electromagnetism in some cases essentially. These clarifications are by no means complete. The description of the electromagnetic field, as well as of any physical phenomenon, can be specified indefinitely as the number of sides and properties of the fields covered by the models increases, since the total number of sides and properties of any phenomenon is infinitely large.

8.4.3. Types of electromagnetic radiation

Let us quote from the article "Electromagnetic Waves" placed by the Big Soviet Encyclopedia (ed. 3rd, vol. 30, p. 67). The reference to this source is necessary to demonstrate the official view of modern science on the nature of electromagnetic radiation.

"Electromagnetic waves, electromagnetic oscillations propagating in space at a finite speed. The existence of E. w. was predicted by M. Faraday in 1832. J. Maxwell in 1865 theoretically showed that electromagnetic oscillations do not remain localized in space, but propagate in vacuum at the speed of light *with in* all directions from the source. From the fact that the speed of propagation of E. v. in vacuum is equal to the speed of l i g h t , Maxwell concluded that the light

represents the E.V. In 1888, Maxwell's theory of E.v. was confirmed by Hertz's experiments, which played a decisive role for its approval.

Maxwell's theory allowed a unified approach to the description of radio waves, light, X-rays and gamma rays. It turned out that these are not radiations of different nature, but E.v. with different wavelengths.

...The features of E. v. and the laws of their excitation and propagation are described by Maxwell's equations".

Thus, the main sign that all the listed types of radiation have a "single nature" was the fact that they all propagate with the same speed - the speed of light, and this gave the basis for their uniform description on the basis of Maxwell's equations.

It should be noted that such justification is not sufficient for the listed types of radiations to be attributed to a common nature. The common propagation velocity can be a consequence of some *common property* of different kinds of radiations. Such a property can be, for example, the property of the medium - viscosity of the ether, which provides transmission of the transverse motion of the ether flow to the neighboring layers. If this kind of motion is present in the structure of different kinds of radiation, then, although these kinds are different, their propagation speed will be the same.

The main characteristic by which one can generalize certain types of radiation should be their internal structure. Only the sameness of the structure can be the basis for assigning radiation to one class of phenomena.

The error into which one can fall is directly evidenced by the attribution of electromagnetic and optical radiation to a common class of phenomena.

At present, there are many scientific works that use Maxwell's equations of the electromagnetic field to describe optical phenomena. However, practice has not confirmed the validity of this approach. It turned out that the penetrating ability of light in a semiconducting medium - sea water, which has a sufficiently high conductivity, at least by five (!) orders of magnitude does not correspond to the calculations made on the basis of Maxwell's equations: light in sea and ocean water penetrates 100-150 m deep, while, based on the parameters of the medium and Maxwell's equations, it should penetrate into sea water no further than a fraction of a millimeter.

For conjugation of theory and practical results various artificial methods were invented, for example, it was suggested that at high frequencies the conductivity of water decreases, and this explains the obtained results. But even here calculations are not confirmed by the physical mechanism of the phenomenon.

Thus, the questions about the propagation of electromagnetic radiation are still not clear enough. However, the ether-dynamic approach makes it possible, at least in a first approximation, to understand the structure of various types of radiation, and to draw various conclusions from this. It turned out, in particular, that it is necessary to distinguish at least five types of radiation of energy by matter into external space:

- quasi-static field of scattering currents;
- a longitudinal electromagnetic wave;
- a transverse electromagnetic wave;
- photon radiation;
- auric radiation.

The first three are related to each other and indeed can be considered as different extreme cases of the same kind of radiation - electromagnetic radiation. The quasistatic field of scattering currents, longitudinal and transverse electromagnetic waves can be considered as special cases of electromagnetic radiation of a dipole with concentrated parameters in a semiconducting medium.

Photon and auric radiation have other structures and do not fall under the type of electromagnetic radiation.

The structures of the first three radiations are discussed below, auric radiation was discussed above in Chapter 6, photon radiation is discussed in Ch. 9.

8.4.4. Quasi-static field of stray currents

A quasi-static field of propagation currents is the case when the electromagnetic wave length is commensurate with the distance from the receiver to the source or exceeds it. From the point of view of ether-dynamics, this is the zone in which the electromagnetic wave continues to be energized from the source. Therefore, the attenuation of amplitude with increasing distance here depends only on the geometry and depends little on the properties of the medium and the current frequency.

It is obvious that the main power of radiation is spent on the near zone. In a semiconducting medium, this zone can be artificially excluded by placing an insulating plate between the electrodes.

material and thus redistribute the current (Fig. 8.29), significantly increasing the propagation range of scattering currents.

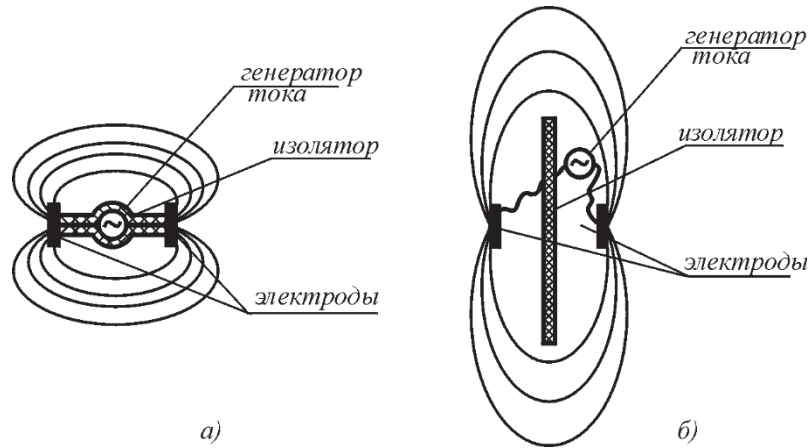

Fig. 8.29. Quasi-static current radiation by a dipole with concentrated parameters: *a* - without an insulating partition; *b* - with an insulating partition between the electrodes of the dipole; in this case the power is redistributed to the distant zone

It should also be taken into account that the energy losses in the near zone depend directly on the electrode area, since the resistance of the medium layer near the electrode and, accordingly, the heat power released in its vicinity are proportional to the area, as it follows from the ordinary Ohm's law (Fig. 8.30). Therefore, in order to reduce losses in the near zone, it is advisable to maximize the electrode area as much as possible.

In addition it is useful to recall that for seawater, which is a typically semiconducting medium, the conductivity is in the range of 1-10 ohms⁻¹ · m⁻¹. This means that at all frequencies lower than 800 mHz, the predominant component will be active rather than reactive, i.e. at all lower frequencies the medium is an ordinary resistor conductor, with virtually no reactive (capacitive) component.

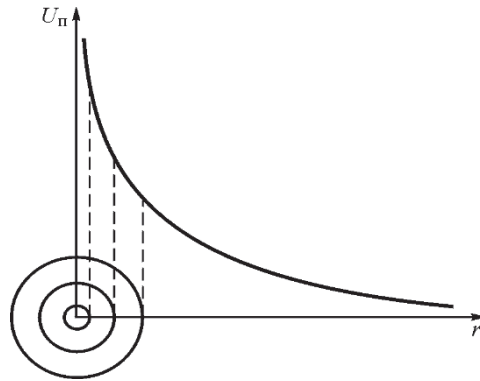

Fig. 8.30. Dependence of voltage drop near the electrode on the surface area of the electrode when current is radiated into a semiconducting medium. The graph corresponds to the electric voltage losses near the ball-shaped electrode

In the considered case, the propagation of the electric component occurs without the participation of the magnetic field even for alternating current, since the magnetic field turns out to be fully compensated at each point of the medium. To obtain it, it is necessary to replace a part of the medium with a medium with a different conductivity, for example, with an insulator. Then the magnetic field will appear in this space (Fig. 8.31).

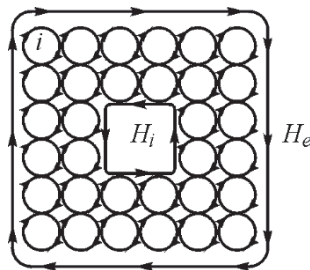

Fig. 8.31. Occurrence of magnetic field at the boundary of the medium and inside the medium when an insulating volume is placed in it

8.4.5. Structure of a transverse electromagnetic wave

A transverse electromagnetic wave propagates in the direction perpendicular to the dipole axis, in such a wave the vectors of electric and magnetic strengths are located in space perpendicular to each other, lie in the plane of the wave front and are perpendicular to the direction of motion - the direction of wave propagation - the vector of energy propagation or, as it is called, the Umov-Pointing vector. The electric tension in the wave is expressed by the same vortex fluxes, the same as in an ordinary electrostatic field, the magnetic tension by the gradient of the vortex velocity. From here, an idea of the structure of the transverse wave can be obtained (Fig. 8.32).

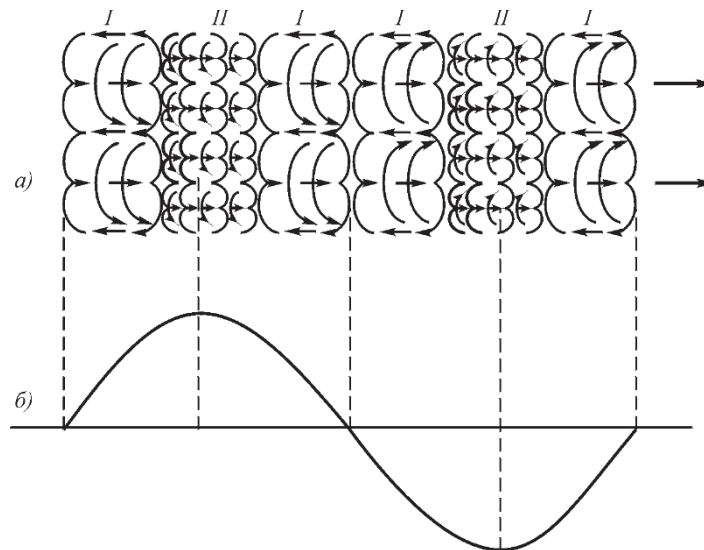

Fig. 8.32. Structure of a transverse electromagnetic wave

A transverse electromagnetic wave consists of a set of electric induction vortices whose axes are located along the wave front. These vortices are tense and tend to expand, which leads to the fact that the whole system of vortices tends to occupy a larger area. But this can only be done by moving the entire wave forward, further away from the wave front

from the source. Thus, the cause of the transverse electromagnetic wave traveling in space is the internal energy of the electric induction vortices. This means that when this energy is exhausted, the vortices will disintegrate and the electromagnetic wave will cease to exist.

The speed of transverse wave traveling in space is determined by the speed of transverse motion transmission from one layer of ether to another. This is the velocity of the second sound, which is essentially less than the velocity of the first sound - the velocity of small pressure transmission within the elastic modulus. The velocity of the second sound is determined by the relation

$$v_2/v_1 = c/v_{3B} = \sqrt{d_a/2\lambda}, \quad (8.244)$$

where c is the speed of light, v_{zv} is the speed of the first sound (the speed of gravity propagation); d_a is the diameter of an amer, an aether molecule; λ is the average free path length of an amer.

The velocity of the first sound is determined by the known relation

$$v_{3B} = \sqrt{\gamma P/\rho}, \quad (8.245)$$

where γ is the adiabatic exponent of ether ($1 \leq \gamma \leq 1.4$), P is the pressure of ether, ρ - its density at a given point in space.

The propagation speed of an electromagnetic wave in a medium with increased dielectric permittivity will be determined by the relation

$$s_{cp} = s/\sqrt{\rho_B} = s/\sqrt{\varepsilon}, \quad (8.246)$$

where ρ_B is the density of the aether involved in the motion of the electric induction vortex in the medium (not the entire density of the aether in the medium!), ε is the relative dielectric constant of the medium.

From these expressions it is immediately seen that the speed of propagation of gravitation and the speed of propagation of light are not the same in different regions of space and are directly related to the parameters of the aether in these regions.

It also follows from the above that the transverse wave will cease to exist when the energy of electric induction vortices is exhausted. The same applies to any type of electromagnetic radiation and may well be the reason that light photons from distant stellar systems do not reach the Earth, and it is

testifies not to the finiteness of the Universe space, as it is often written about, but only to the exhaustion of instrumental possibilities of optical astronomy and radio astronomy.

8.4.6. Structure of a longitudinal electromagnetic wave

A longitudinal electromagnetic wave has a different structure than a transverse wave. In a longitudinal wave, vortex tubes of electric induction are located along the direction of motion (Fig. 8.33).

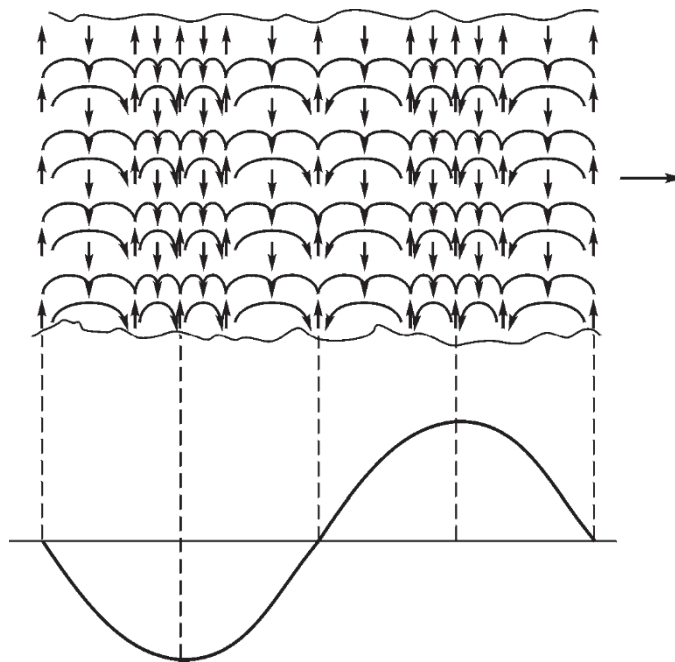

Fig. 8.33. Structure of a longitudinal electromagnetic wave: *I* - zone of low intensity; *II* - zone of high intensity

The cause of the longitudinal wave motion is the same as that of any gas vortex toroid: the opposite direction of tube motion

of ether along the outer surface of the tube. It should be noted that at the front end face of each tube the ether motion lies in a plane perpendicular to the direction of motion of the whole tube. This means that all restrictions on the propagation velocity of the longitudinal wave will be the same as for the transverse wave.

Regarding the laws of reflection and refraction of the longitudinal electromagnetic wave at the moment there is no data, although, most likely, they are the same as those of ordinary waves.

Since the strength of a longitudinal wave can vary within a single structure (e.g., with sinusoidal modulation), this means that within the overall structure of a longitudinal electromagnetic wave, the number of electric induction vortices in different cross sections can be different. This, in turn, requires recognizing the possibilities of rearrangement of the vortex system, when vortices can divide or combine with each other. In principle, this should not cause special objections, since the ether is not an ideal liquid, but a very rarefied structure.

The energy of each vortex of electric induction in a longitudinal wave consists only in itself. This means that the energy losses will most likely obey the same laws of damping as for an ordinary transverse wave, and the electric tension along the dipole axis will decrease with distance in accordance with the conclusion from Maxwell's equations:

$$E = E_0 e^{-\frac{\mu_0 \mu \sigma \omega}{2} r} \quad (8.247)$$

Here E_0 is the voltage at the electrode surface close to the point under consideration, μ is the relative magnetic permeability of the medium; σ is the conductivity of the medium; ω is the circular frequency of the radiated wave. However, this assumption should be subjected to experimental verification.

The directional pattern of a longitudinal electromagnetic wave is different from that of a transverse one and depends essentially on the ratio of the electrode sizes and the distance between them. The smaller the size of the electrodes in relation to the distance between them, the narrower the directivity diagram will be, the greater the proportion of energy will be radiated in the longitudinal direction of the dipole in relation to the radiation of the same dipole in the transverse direction.

Two experiments were conducted to verify the fact that the electric field and, consequently, the electric current propagate along the direction of their vectors. In the first experiment, a rubber hose filled with salted water and suspended on threads in the middle of the room was used. Two dipoles with concentrated parameters were placed in the hose - a radiating one connected through a coaxial cable to the generator of sinusoidal oscillations G , and a receiving one connected through a coaxial cable to the receiver P - a diode bridge with a microammeter (Fig. 8.34). The hose with water has a parasitic capacitance C_{nap} with the walls of the room.

Connecting the electrodes through coaxial cables eliminated the possibility of any parasitic circuits.

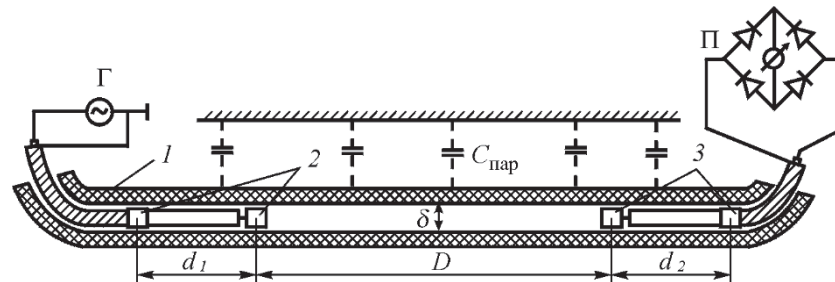

Fig. 8.34. Schematic diagram of the experiment to test the longitudinal propagation of radiation of a dipole with concentrated parameters:

1 - rubber hose filled with salted water; 2 - electrodes of the radiating dipole; 3 - electrodes of the receiving dipole

When changing the distance d between the dipoles due to the non-branching of the current, the signal in the receiver should not change, at least until the resistance of the channel is commensurate with the resistance of the parasitic capacitances. This occurs at some distance d , since the resistance of the water in the channel and the conductance of the parasitic capacitance S_{par} are proportional to the ratio d/δ . Fig. 8.35 shows the obtained dependencies. The result completely confirmed the expectations. It was found out that the increase of water salinity, i.e. the increase of its conductivity increases the useful signal and increases the zone of constant amplitude of the output signal. Further it is necessary to check the fact of growth of attenuation of longitudinal wave at different values of active conductivity

medium. It should be borne in mind that attenuation in a semiconducting medium of a longitudinal wave may also be a consequence of the fact that the energy of each half-wave is actually independent, so the cause of attenuation of a longitudinal wave in a semiconducting medium may be the same as that of transverse waves.

In the second experiment, a dipole with flat electrodes was used with fixation of tension and electric energy by the second dipole. The experiment was performed in a thin flat layer of semiconducting medium.

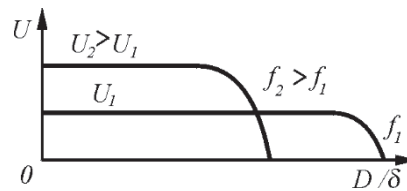

Fig. 8.35. Dependence of the receiver signal on the distance between dipoles at longitudinal energy emission

Fig. 8.36 shows the diagram of electric field propagation. As can be seen from the diagram, the main electric field strength is obtained along the axis of the dipole, not across it, as it follows from Maxwell's equations. The diagram will be most elongated if the distance between the transmitter electrodes is half of the wave in a semiconducting medium.

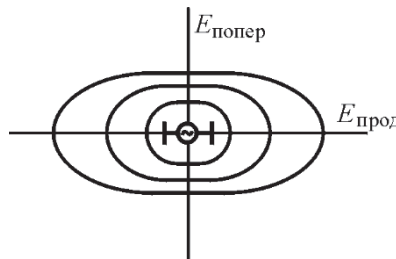

Fig. 8.36. Electric field propagation by a dipole with concentrated parameters in a thin layer of semiconducting medium. The longitudinal component is larger than the transverse component of the field

Thus, the fact of existence of longitudinal propagation of electric field in the far zone exceeding the zone of induction,

can be considered an established fact, but for a semiconducting medium this range will be limited by the exhaustion of the wave energy spent on heating the medium.

Conclusions

1. Paradoxes and difficulties in solving some problems of electrodynamics are related to the imperfection of the electromagnetic field equations based on the model of idealized (non-viscous and incompressible) ether. Improvement of the electromagnetic field equations and the laws of electromagnetism is possible only on the basis of refinement of the initial models, in particular, related to the consideration of the real characteristics of the ether, its viscosity and compressibility.

2. Due to the fact that the initial physical invariants are the components of motion - matter, space and time, which in mechanics corresponds to the system of units ISS (meter, kilogram, second), the system of units ISSA (meter, kilogram, second, Ampere), adopted in electrodynamics, is redundant and complicates the understanding of the physical essence of the processes of electromagnetism. On the basis of the developed models of electromagnetism, the MKSA system was transformed into the MKS system.

3. All known electromagnetic phenomena can be interpreted from the position of gas dynamics of the aether, with electric charge interpreted as circulation of the circular velocity of the aether density over the entire surface of a helical toroidal vortex - proton or electron; polarity - as a sign of helical motion of the aether around the charge; electric field can be interpreted as a set of open vortex tubes of the aether, in which the aether rotates around the axis of the tube and progressively moves along the axis of the tube from the charge, and along the periphery - to the charge; electric field can be interpreted as a set of open vortex tubes of the aether, in which the aether rotates around the axis of the tube and progressively moves along the axis of the tube from the charge, and along the periphery - to the charge; electrical

4. On the basis of refined models of electromagnetic phenomena, some laws of electromagnetism are clarified, electromagnetic field equations are developed, some regularities not following from the classical Maxwell's electromagnetic field equations, Faraday's law of electromagnetic induction, the law of total current, etc. are predicted and experimentally verified. The existence of an electric field propagating longitudinally outside the induction zone has been predicted and experimentally verified, the influence of an external magnetic field relative to the measuring circuit has been shown, the compaction of the magnetic field in space has been predicted and experimentally verified, and the dependences for the mutual induction of conductors have been determined, which have been confirmed experimentally and which differ significantly from the Maxwell dependences.

5. The developed models of electromagnetic phenomena involving the concepts of the ether allow us to get rid of the paradoxes of electrodynamics in a natural way. The experiments confirmed the expediency of specifying the functional dependences of electromagnetism and the existence of the predicted phenomena, including the dependence of the induced EMF in the frame not only on the internal but also on the magnetic field external to it, the existence of mutual induction of conductors, the existence of longitudinal electromagnetic radiation, and some others.

Chapter 9. Light

... Newton favored the corpuscular theory of light, considering it a flow of particles. ... Huygens believed that light excitation is the impulses of elastic vibrations of the ether.

A.M.Bonch-Bruyevich [1]

9.1. A brief history of optics

Optics is one of the oldest sciences, closely related to the needs of practice at all stages of its development. The rectilinearity of light propagation was known at least 5 thousand years B.C. and was used in Ancient Egypt for construction works. Aristotle, Plato, Euclid and Ptolemy pondered over the essence of optical phenomena. A significant contribution to the development of optics was made by the Arab scientist of the XI century Ibn al-Haysam [2, 3]. The exact laws of refraction were established in 1620. Spellius and Descartes [3, 4]; diffraction and interference of light were discovered by Grimaldi (published in 1665), and double refraction was discovered by Bartlin (1669). Further development of optics is associated with the names of Newton, Hooke and Huygens [5-7].

It is necessary to dwell on I.Newton's views in detail, because it was Newton who paid much attention to the problem of the ether structure and its role in optical phenomena [8]. I.Newton established the following independent "original" properties of light rays: straightness, subordination to the laws of reflection and refraction, speed, color invariability of simple light, its periodicity ("alternating attacks of light reflection and light refraction"), polarization and diffraction. This abundance of "principles" turned optics into a cumbersome, difficult to learn and incomprehensible science. There was no general principle from which all the found original properties of light would follow.

Newton allowed the possibility of wave interpretation of light phenomena, but favored the corpuscular concept, considering light as a stream of particles acting on the ether and causing it to oscillate. Difficulties arising in the wave theory in attempts to explain the rectilinear propagation of light and the phenomenon of polarization, seemed to Newton so serious that prompted him to develop the corpuscular theory (or theory of efflux), according to which light spreads from the emitting body in the form of tiny particles.

The concept of light polarization was first introduced into optics by Newton in 1704-1706, although the phenomena caused by it had been studied earlier (the discovery of double refraction in crystals by E. Bartolin in 1669 and its theoretical consideration by H. Huygens in 1678-1690). Polarization according to Newton is an "original" property of light explained by a certain orientation of light particles in relation to the ray formed by them.

The aether hypothesis appears to Newton for the first time in 1672 in response to Hooke's polemical remarks on Newton's Theory of Light and Colors. Comparing the emission and wave hypotheses of light, Newton writes:

"The vibrations of the ether are equally useful and necessary in both, for if we accept that light rays consist of small particles thrown out in all directions by a luminous body, these particles, falling on refracting or reflecting surfaces, must excite vibrations in the ether as inevitably as a stone thrown into water." This, however, required an explanation of the properties of the ether.

Newton writes (Memoirs 1675):

"It is supposed that there exists a certain etheric medium, in many respects having the same structure as air, but considerably more rarefied, thin and elastic. ...It cannot, however, be supposed that this medium is a uniform matter: it is composed partly of the basic, oblique body of ether, partly of other etheric spirituals, much in the same way as air is composed of the oblique body of air mixed with various vapors or exhalations. In favor of this heterogeneity, the elastic and magnetic effluxions and the origin of gravitation seem to speak in favor of it."

"I assume," Newton writes, "that, striking a rigid resisting etheric surface (at the boundary of media - *V.A.*), the rays... cause oscillations on the surface. These vibrations propagate in all directions in both rarefied and dense media. Like the vibrations of the air which produce sound, they are born by impact and continue most strongly where they began, alternately compressing and expanding the ether in said physical surface, for it is evident from the heat produced by light in bodies that light can set the particles of the body in motion and can all the more heat and set in motion the more delicate ether. It is more probable that light communicates motion to the gross particles of the body, not directly, but by means of the ether."

"If a ray strikes a medium during a great compression," Newton reasoned, "I suppose the surface is then too dense and rigid to let the ray pass through, it reflects it. But the rays,

striking the surface at other times, when it is expanded between two oscillations, or not too compressed and condensed, pass through and are refracted."

Newton attributes the colors of thin plates and interference rings to the fact that etheric vibrations propagate faster than the light that caused them. "On this supposition," he writes, "when light falls on a thin film or plate of some transparent body, the waves excited by the passage of light through the first surface overtake the rays one by one. When the ray reaches the second surface, the waves will cause it to be reflected or refracted there, accordingly to what part of the wave overtakes the ray there, whether condensed or rarefied...."

However, in the future Newton actually abandoned attempts to explain the description of optical phenomena with the help of ether. In the first edition of *Optics* (1704) the ether is simply silenced, in the 1706 edition it is sharply denied.

Huygens, following the ideas of Leonardo da Vinci and developing the work of Grimaldi and Hooke, proceeded from the analogy between many acoustic and optical phenomena. He believed that light excitation is the impulses of elastic vibrations of the ether.

The term "polarization of light" was proposed in 1808 by Malus. With his name and with the names of J. Bio, O. Fresnel, D. Arago, D. Brewster and others the beginning of a wide study of the effects based on the polarization of light is connected. Essential for understanding the polarization of light was its manifestation in the effect of interference of light. It was the fact that two light beams, linearly polarized, at right angles to each other do not interfere, was the decisive proof of the transversality of light waves. The works of Young, Fresnel and Arago (1816-1819) in this direction determined the victory of the wave theory.

Meanwhile, the corpuscular theory was further developed in the works of P.S. Laplace and J.B. Bio. Its supporters proposed to consider the explanation of the phenomenon of diffraction worthy of the prize established in 1818 by the Paris Academy of Sciences. But this prize was awarded to A.J. Fresnel, whose research was based on the wave theory.

In the same year, Fresnel tackled the very important problem of the influence of the Earth's motion on the propagation of light. Arago experimentally discovered that, apart from aberration, there is no difference between light from stars and light from terrestrial sources. On the basis of these observations, Fresnel created a theory of partial entrainment of the light ether

by moving bodies, which was confirmed in 1851 by direct measurements by A.I.L. Fizeau. Together with Arago, Fresnel investigated the interference of polarized light rays and found that rays polarized in mutually perpendicular planes never interfere. This fact could not be reconciled with the then generally accepted assumption of the longitudinality of light waves. Jung, who learned of this discovery from Arago, found a solution to the contradiction by assuming that light oscillations are transverse.

Polarization of light was explained in the works of J.Maxwell. Maxwell showed that light is not elastic oscillations but electromagnetic waves. Drude, Helmholtz and Lorentz combined ideas about oscillators and the electromagnetic theory of light in constructing the electronic theory of matter [9-11]. At the same time, a number of researchers made various and very numerous attempts to explain optical effects by constructing on the basis of assumptions about the existence in nature of a world medium - the ether, but these attempts were not successful on the average: explaining some phenomena, all theories, models and hypotheses of the ether encountered insurmountable contradictions in other phenomena.

Studies of optical phenomena continued in the future. A.G.Stoletov in 1888-1890 discovered the photoeffect [12], which was later explained by Einstein on the basis of photon concepts. P.N.Lebedev discovered the pressure of light in 1899 [13]. The development of optics in the twentieth century is closely related to quantum mechanics and quantum electrodynamics [14-17]. Although the physical essence of optical phenomena has not been satisfactorily explained, it was decided that the explanation of optical phenomena no longer needs the hypothesis of the existence of the ether, that mathematical laws describing these phenomena are sufficient.

Currently, optics is commonly categorized into geometric, physical, and physiological optics.

Geometrical optics leaves aside the question of the nature of light, proceeds from the empirical laws of its propagation and uses ideas about light rays refracted and reflected at the boundaries of media with different optical properties and straight in optically homogeneous media. Its task is to mathematically investigate the course of light rays in a medium with a known dependence of the refractive index of the medium on the coordinates or, on the contrary, to find the optical properties and shape of transparent and reflecting media, in which the rays pass along a given path.

Physical optics deals with problems related to the nature of light and light phenomena. It states that light is transverse electromagnetic waves, although the nature of these waves is not considered. Its section is wave optics, the mathematical basis of which are the general equations of classical electrodynamics - Maxwell's equations. The properties of the medium are characterized by macroscopic material constants - dielectric and magnetic permeabilities,

which define the refractive index of the medium $n = \sqrt{\epsilon\mu}$. Facti-

It's the same geometric optics.

Physiological optics, interfacing with biophysics and psychology, investigates the visual analyzer from the eye to the cerebral cortex and the mechanisms of vision.

All sections of optics have received wide practical application. Numerous lighting sources based on various achievements of physics have been created, the science of lighting engineering takes into account the laws of optics and physiology. Optical spectral studies have made it possible to understand the structure of matter in many ways. Numerous optical instruments have been created for a wide variety of purposes, ranging from the study of microscopic organisms and the structure of matter to the study of the universe. Thus, the achievements of optics as a science are enormous. And yet the essence of optical phenomena and the most elementary carrier of light, the photon, still remains unknown....

In spite of the fact that optics has a long history, and attempts to apply the mathematical apparatus of electrodynamics began immediately after Maxwell published his famous equations, some inconsistency of photon propagation with Maxwell's laws was quickly discovered. The point is that the attenuation of light in a semiconducting medium (sea water) turned out to be completely inconsistent with the law of attenuation of a plane electromagnetic wave in such a medium.

As is known, a plane electromagnetic wave attenuates in a semiconducting medium according to Maxwell's law as

$$H = H_0 e^{-\frac{\mu_0 \sigma \omega}{2} r} \quad (9.1)$$

Here H_0 is the magnetic field strength at the interface surface, for example at the surface of sea water; μ is the relative magnetic permeability of the medium; σ is the conductivity of the medium; $\omega = 2\pi f$, f is the frequency of the electromagnetic wave; r is the distance from the interface surface.

Practice reveals a complete confirmation of the above formula to the attenuation of a plane radio wave in the marine environment and its complete divergence from the attenuation of light in transparent sea water.

At a seawater conductivity of $1 \text{ Ohm}^{-1} \text{ m}^{-1}$ at 1 mHz, almost complete attenuation of the electromagnetic wave occurs at a depth of m. Considering that

$$r_1 / r_2 = \sqrt{(f_2 / f)_1} \quad (9.2)$$

and that for green light the wavelength is $5.6 \cdot 10^{-7} \text{ m}$, which corresponds to the frequency $5 \cdot 10^{14} \text{ Hz}$, we obtain for the Maxwell-calculated depth of light penetration into sea water as

$$r_2 = r_1 \sqrt{(10 / 10^{614})} = 10^{-4},$$

and thus light should penetrate to a depth of no more than $3 \cdot 10^{-4} \text{ m} = 0.3 \text{ mm}$. Instead, the light penetrates to a depth of about 150 m. Thus, the discrepancy between theory and practice here is 500 thousand times!

The theory explains it by the fact that sea water at such frequencies loses its conductivity, the reasons for which are not explained. In fact, it is elementary explained by the fact that the structure of a photon in no way corresponds to the structure of a plane radio wave and in these calculations two important moments are completely excluded - the proportionality of the photon energy to the total number of vortices forming the photon and the internal energy of each vortex of the photon.

9.2. The structure of a photon

In the process of researches carried out by various authors, the basic properties of light and its elementary component, the photon, were found out. These properties are as follows.

1. The smallest element of light, the photon, carries energy, which according to Planck's law is proportional to frequency:

$$E = h\nu, \quad (9.3)$$

where $h = 6.62 \cdot 10^{-34}$ J-s is Planck's constant; ν is frequency.

2. Light emitted by an atom is polarized. Light is not polarized in a normal beam (circular polarization) because different atoms emit light at different moments in time and individual portions of light are emitted independently of each other.

3. The photon as a particle has no electric charge.

4. A photon can have one of two spin values: either + 1, or - 1.

5. Light has pressure, hence photons have mass.

6. Photons are localized in space, propagate in vacuum in a straight line and have a constant velocity, which makes them similar to a stream of particles.

7. Light has the properties of interference and diffraction, which allowed photons to be considered waves.

8. Parallel oriented photons interfere, while mutually perpendicularly polarized photons do not interfere.

All previously developed by various authors models of a photon do not satisfy on the totality of the listed properties, the created theories are limited by not contradictory description of properties of a photon and light as a whole, but do not reveal structure of a photon and do not explain why light possesses such properties.

J. Thomson made an attempt to construct a vortex model of the photon [18]. However, his model did not meet even elementary requirements of the explanation of the polarization phenomenon, since a simple vortex ring, which Thomson proposed as a model of the photon, did not possess such properties.

All the above mentioned properties of light are easily explained on the ether-dynamic vortex basis.

The formation of a photon can be visualized as the result of vibrations in the ether of the excited electron shell of an atom.

The electron shell of an atom is an attached vortex of ether, quite elastic. If it is struck, humps and depressions appear on it, which make oscillations around the center of the atom. Performing oscillations, the excited helical vortex shell in the layers of ether adjacent to its surface excites helical jets, and the direction of the ether current in the jet coincides with the direction of the ether current in the surface layers of the shell. This is easily explained, since the pressure of the ether on the colliding side of the shell is greater than in the unperturbed medium. The helical aether jet creates in the surrounding aether a displacement in longitudinal relative to the jet

direction. Such a jet corresponds to an elementary helical duplet in hydromechanics. As in every gas, the duplet creates a vortex flow of the medium. However, since the aether jet has a helical character, the created elementary vortex will also have a helical structure.

At the return motion of the shell hump, the opposite side of the shell will become colliding, as a result of which a second gas jet will be created on the second side, which will form a second vortex, also having a helical structure. Both vortices are created alternately, and the motion of the shell hump repels alternately both vortices in the direction of their future motion, giving the initial momentum to the formed photon (Fig. 9.1)

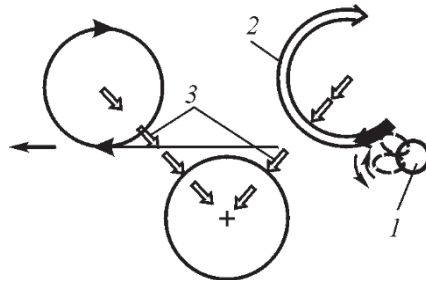

Fig. 9.1. Photon formation by the excited electron shell of an atom: 1 - excited atom; 2 - induced aether jet; 3 - aether flow between vortices.

The motion of the photon is directed towards the motion of the aether on the adjacent surfaces of its vortices, i.e. in the same way as it happens for ordinary ring vortices. Since the size of the atom is approximately 10^{-10} m, the size of the duplet should be of the same order. The closure of the formed vortex can occur in a substantially larger region, which is limited only by the appearance of the subsequent vortex. Thus, the sizes of vortices in a photon are limited by the oscillation frequency of the oscillator that created them - the excited electron shell.

The photon in the form of a vortex helical structure composed of linear divergent vortices of ether, located relative to each other in a staggered order is shown in Fig. 9.2. Such a formation has an analog in hydromechanics, the so-called vortex track

Karman structure (Fig. 9.3) [19-21]. In this structure, vortices of one row rotate in one direction, vortices of the second row rotate in the opposite direction. The wavelength of a photon is the distance between the centers of the vortices of one row. Since each vortex of the photon has a mass, it is easy to see that the photon is both a particle and a wave at the same time.

The vortices constituting the photon have a helical structure, hence, along the axes of these vortices there is an ether current, which is directed in one direction in the vortices of the first row, and in the vortices of the second row - in the opposite direction. In relation to this flow, the vortices also act as duplexes, so that the currents flowing along the axes of the vortices will pass from the vortices of one row to the vortices of the second row, and from the opposite ends, on the contrary, from the vortices of the second row to the vortices of the first row.

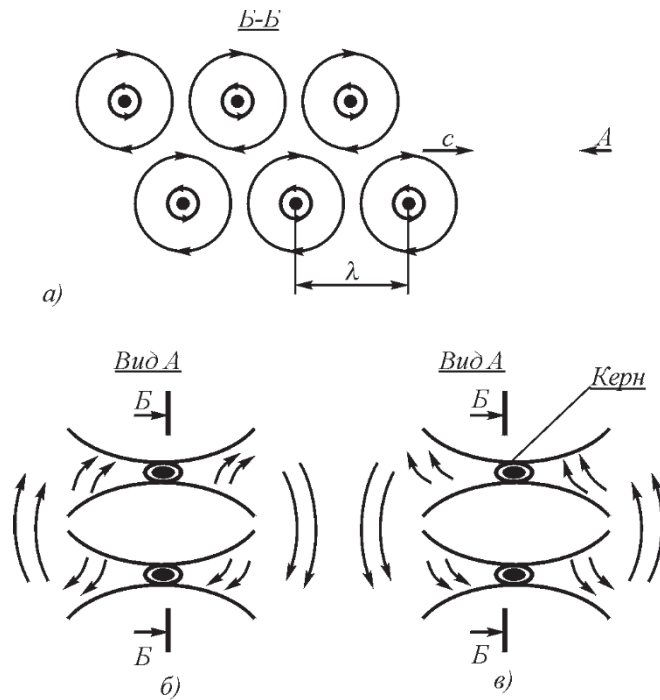

Fig. 9.2. Photon structure: longitudinal section (a), cross section at spin -1 (b), cross section at spin +1 (c)

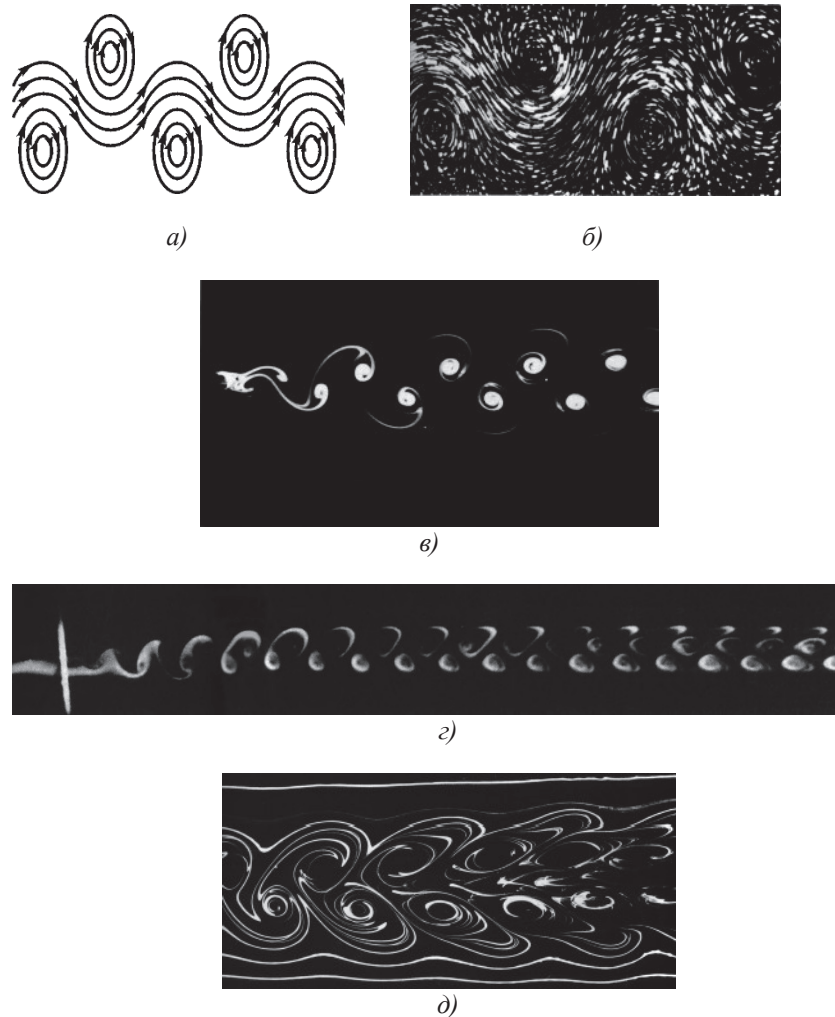

Fig. 9.3. Karman vortex track: *a)* - flow structure; *b)* - Karman vortices in water. The chamber moves together with the vortices; *c)* - Karman's path behind a circular cylinder at $Re = 105$; the initial stage of the path formation can be seen in the left part; *d)* modeling of the path in an air medium; *e)* - flow structure of the vortex path at the final stage of existence

The confinement of helical vortex flows at the vortex ends will result in vortex motion that does not propagate outward

of a narrow zone of space adjacent to the photon. The photon does not create any circular motion in the surrounding ether and, therefore, will be perceived as an electrically neutral particle.

Just like an ordinary vortex ring, a system of linear vortices will move in a rectilinear fashion because it has

$$\sum_{i=1}^n G_i = \sum_{i=1}^{n/2} G_{i_1} + \sum_{i=1}^{n/2} G_{2i} = 0, \quad (9.4)$$

i.e. the sum of circulations of annular velocities of all linear vortices is equal to zero, or, otherwise, the sums of circulations of both rows of linear vortices are equal and opposite to each other.

Since in principle there can be two directions of the axial flow in each vortex (left-handed and right-handed motion of the ether), the spin can take two values accordingly. The third value of spin, equal to zero, means that there is no axial flux and the linear vortices forming a photon are not bound by anything. For linear vortices such state is not stable, so the whole structure will break into separate rapidly diffusing rings.

At formation of a photon by the excited shell of an atom, the process lasts relatively long time, and a significant number of photon vortices are formed. From the classical theory of light it is known [22] that the time of light emission by a single atom is

$$\tau = \frac{3m_e c^3}{2 \omega_0^2 e^2} \quad (9.5)$$

where m_e and e are the mass and charge of the electron, respectively.

If instead of ω_0 we take the average frequency in the visible region ($\lambda = 5 \cdot 10^{-7}$

m, i.e. $\omega_0 = 4 \cdot 10^{15} \text{ with}^{-1}$), then substituting

$m_e = 9 \cdot 10^{-31} \text{ kg}$ and $e/m_e c = 1.76 \cdot 10^7$ we obtain $\tau \approx 10^{-8} \text{ s}$.

Since the oscillator oscillation frequency is approximately 10^{14} Hz , it is easy to see that during the radiation time, i.e., during the time during which the energy decreases by e times, the oscillator will make a number of oscillations of the order of 10^6 .

Consequently, the photon resulting from the emission of an atom must be a vortex formation of approximately square cross-section with a side of square equal to about 2λ and

with a length of the order of $10^6 \lambda$, i.e. a long thin filament. At a wavelength of $0.5 \mu\text{m}$ (green color), an elementary photon will have dimensions of $1 \mu\text{m} \times 1 \mu\text{m} \times 0.5 \text{ m}$. However, the length of a photon at the same wavelength can be very different. With the help of Kerr cells a photon can be chopped into pieces of any length.

The photon has a finite length, since the formation of each vortex is possible only at a certain value of the oscillation of the excited shell, and starting from some minimum value of the oscillation amplitude of the oscillator, the vortex in the medium is no longer formed. The same process can be considered as a detachment of a part of the shell mass of the excited atom at each half-period of its oscillation.

It is known that the distance between atoms of a solid is 10^{-10} m , while the width and thickness of a photon are of the order of 10^6 m . Consequently, 10^8 atoms are stacked on the cross-sectional area of one photon. This means that not one, but many atoms take part in the creation of each photon, giving it their energy. The radiation resistance for each atom will decrease, they will enter synchronism, and the radiation time will increase in proportion to the number of atoms participating in the creation of the photon. Thus, the photon length is not a constant value.

Forming together a common helical jet of ether in the adjacent regions, atoms expend the least energy if they oscillate synchronously and in-phase, because in all other cases there is an additional viscous friction between the excited oscillating shell and the jet and those atoms slow down, phase of which is ahead of the jet phase, and, on the contrary, the jet, which is ahead of the oscillator in phase, begins to give energy to this oscillator, as a result of which the lagging atoms are pulled up to the jet phase. Thus, mutual synchronization and synphasing of vibrations of excited shells of different atoms occur. In this case, the unidirectional vortices of photons created in neighboring regions of the emitter will be pulled toward each other, creating common flows (Fig. 9.4).

An increase in the number of atoms taking part in the creation of a photon leads not only to an increase in the length of the photon, but also to an increase in its transverse dimensions while maintaining the wavelength and to an increase in the density of the aether in the body of the photon, since the pressure in a jet formed by several duplets will be increased compared to the pressure in a jet formed by a single duplet, and in addition, at a fixed frequency, an increase in the intensity of the jets will lead to a

reorganization of the structure of each vortex, as it happens in gas vortices, - the walls will start to compact, the total mass and density of the gas will start to increase.

Real sources of coherent light are never point sources; their area is at least several square millimeters. Meanwhile, light from such a source, when split into two beams and then collected on a common screen, is capable of creating an interference pattern. This means that the photons in both beams not only have the same frequency but also the same phase, for otherwise no interference pattern would result. Figure 9.4 shows that photons of the same frequency are capable of producing a single system in which they would all be in-phase. It also means that at each moment of time all atoms of the coherent light source are also synchronized with each other.

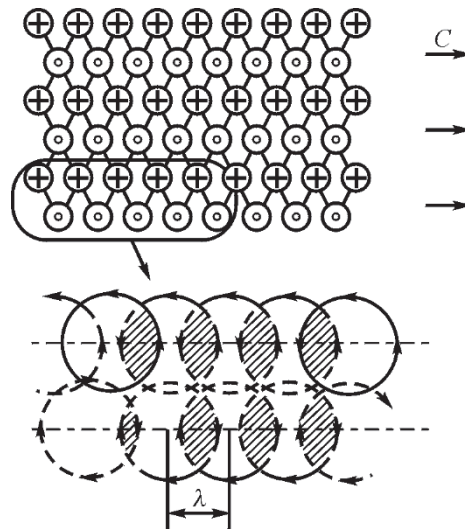

Figure 9.4. Coupling of photons formed by different atoms into a common vortex system

The formation of photons at the collision of an electron and a positron should be essentially different from the one considered above, since there is a single interaction of helical toroids. Colliding, the electron and positron must collapse and form other structures. One variant of such rearrangement is shown in Fig. 9.5.

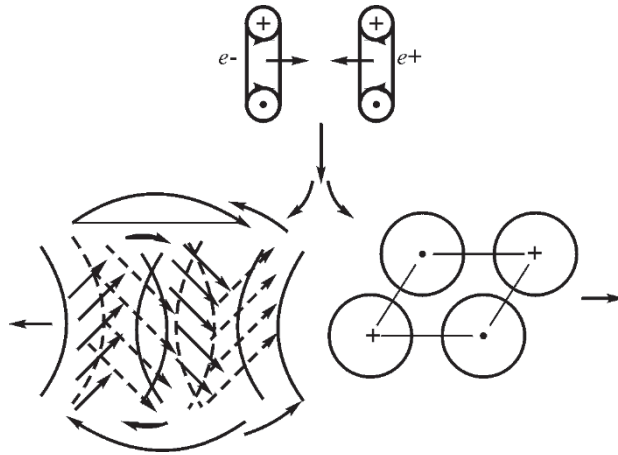

Figure 9.5. Photon formation at annihilation of electron and positron

Both electron and positron divide each into four parts, there is a rotation of these parts, as a result of which two photons are formed, the spin of each of which, apparently, is equal to zero, in spite of the presence of axial fluxes. The resulting photons don't form a tsunami of waves like the photons formed from the emission from the atoms. The flying photons will be mutually perpendicularly polarized. Thus, the photons formed as a result of annihilation of an electron and a positron should differ essentially from the photons formed as a result of radiation of atoms. Of course, all of the above should be subject to experimental verification.

The energy of the vortex system in a photon is determined by the expression [23, p. 273]:

$$E = - \frac{\rho}{4\pi} \sum_{i=1}^n G_{1i} G_{2i} \iint \frac{\cos \alpha}{r_i} dl_{1i} dl_{2i}, \quad (9.6)$$

where G_{1i} , G_{2i} are the intensities of a pair of vortices, r_i is the distance between their axes; dl_{1i} , dl_{2i} are the elements of the vortex lengths, α is the angle between the elements, with the double integral taken along the axes of the vortex filaments, and the summation includes all available pairs of filaments one at a time.

It can be seen that the energy of the vortex system is greater the smaller is the distance between the vortices. Since the distance between the vortices is in strict proportionality with the distance between the vortices in the same row, i.e. with the photon wavelength λ , then

$$E \sim \frac{1}{\lambda} v, \quad (9.7)$$

where v is the frequency of oscillation of the photon, which is in full agreement with Planck's law, which actually corresponds to the expression for the energy of the system of interacting vortices.

When comparing Planck's law with the above expression, one can conclude that all photon vortices created by atoms have the same internal energy. It is not obvious, but in external effects the internal energy of photons is not manifested, concerning external manifestations of photon energy Planck's law is strict enough. At creation of artificial electromagnetic radiation this circumstance becomes important, because there is a problem of accumulation of energy in each vortex at increase of power of the source spent on its creation.

Planck's law and Maxwell's equations completely ignore the internal energy of the photon, which consists of three components:

- the energy of each vortex;
- energetics of the whole set of vortices forming a photon;
- energetics of vortex connections.

The internal energy of rotation of ether jets in the composition of each ether vortex in the photonic structure determines its intensity and its shape. The more energy an ether vortex carries, the greater the linear velocity of the ether jets forming it, the greater their angular velocity, and at the same mass of the vortex the smaller its diameter. The last circumstance directly follows from the provisions of gas dynamics. Since the sizes of vortex ends are determined by the distance between their axes and depend, consequently, only on the frequency of vortex creation, the energy accumulation should take place in the central part of each vortex by reducing the diameter of this central part: the more energy pumped into each vortex at the same frequency, the smaller should be the diameter of its central part (core). Therefore, each ether vortex of a photon has a thinned and compacted part in the middle (Fig.

9.2), in which its main energy is accumulated. This part contains the main mass of the vortex.

The energy of the whole set of vortices of the photon is distributed over the whole body of the photon due to the end flows of the ether flowing from vortices of one row to vortices of another row. Therefore, the loss of energy by the head vortex of the photon at overcoming the resistance of the ether is compensated by the energy of all vortices forming the photon.

Here one should distinguish between the energy of a short photon consisting of a small number of vortices (their minimum number is three) and the energy of long photons consisting of millions of vortices. While their external properties - frequency and Planck energy - are identical, their penetrating power will be essentially different; short photons will decay in the semiconducting medium much faster than long photons.

Thus, the internal energy of the photon E_f as a whole vortex structure consists of three components:

- Planck energy, taking into account only the frequency properties of the photon;
- the internal energy of each vortex;
- energy of the whole set of vortices proportional to the number of vortices in the photon structure.

This energy can be described as

$$E_{\phi} = h' p E_b \nu, \quad (9.8)$$

where h' - the proportionality coefficient, some analog of Planck's constant; n - the number of vortices (oscillations) forming the photon body; E_b - the energy of each vortex; ν - the photon frequency, usually denoted in radio engineering by the letter f .

From these two circumstances - energy of the whole body of the photon, i.e. energy of the whole system of its vortices and accumulation of energy in the central part of each vortex - a very important consequence follows: the photon structure does not obey Maxwell's law of damping in a semiconducting medium.

For a photon, as well as for any material entity

$$E = E_e + E_i, \quad (9.9)$$

where E_e is the external energy (relative to other systems); E_i is the internal energy. The external energy for a photon moving progressively in space, as well as for any moving body, is equal to

$$E_e = mc^2/2. \quad (9.10)$$

The internal energy of a photon is the energy of helical rotation of aether flows. Proceeding from Maxwell's principle of energy distribution, we can assume that the energy of helical rotation is equal to the energy of displacement, i.e.

$$E_c = E_i. \quad (9.11)$$

Consequently, the total energy of the photon could be put, as it is accepted, equal to

$$E_\phi = mc^2 \quad (9.12)$$

This expression in the form

$$dE_\phi = c^2 dm \quad (9.13)$$

was obtained by Heaviside in 1912. [24] on the basis of consideration of Maxwell's equations and taking into account the assumptions about the presence of the ether in nature.

Equality of energies of magnetic and electric fields in a photon

$$W_H = \frac{\mu H^2}{4\pi} = W_E = \frac{\varepsilon E^2}{4\pi} \quad (9.14)$$

makes us consider that for each such field the energy of rotation and the energy of displacement of the accompanying flows of the Ether - toroidal and circular - are also equal to each other and are the same for both fields

However in the given expressions the core energy of the photon, in which, in fact, the main part of its mass and energy is concentrated, is not considered.

Let us determine the average photon density using the example of a photon with wavelength $\lambda = 5 \cdot 10^{-7}$ m.

If the mass of one vortex of a photon is determined from the known expressions

$$E_\phi = m_\phi c^2, \quad (9.15)$$

and also consider that

$$E_\phi = h\nu = hc/\lambda, \quad (9.16)$$

we get

$$m_{\phi} = \frac{h}{c\lambda}. \quad (9.17)$$

Here E_{ϕ} is the photon energy; h is Planck's constant; ν is the photon frequency; λ - is its wavelength; c is the speed of light.

The mass of one vortex will be

$$m_{\phi} = \frac{6,6256 \cdot 10^{-34}}{3 \cdot 10^8 \cdot 5 \cdot 10^{-7}} = 4.42 \cdot 10^{-36} \quad \text{kg}. \quad (9.18)$$

The volume of one photon vortex is approximately equal to the value of

$$V_{\phi} = 4 \cdot \lambda^3 \quad (9.19)$$

and in this case is the value

$$V_{\phi} = 4 (5 \cdot 10^{-7})^3 = 5 \cdot 10^{-19} \text{ m}^3. \quad (9.20)$$

Hence, the average density of a photon will be equal to

$$\rho_{\phi\text{cp.}} = m_{\phi} / V_{\phi} = 4.42 \cdot 10^{-36} / 5 \cdot 10^{-19} \approx 10^{-17} \text{ kg} \cdot \text{m}^{-3}, \quad (9.21)$$

i.e. substantially less than the density of free ether. Of course, such a vortex could not exist by itself: it owes its existence to the core - the central part, in which the density is significantly increased in comparison with the density of free ether. Assuming the volume of the core to be approximately

$$V_{\kappa} = 10 d_{\kappa}^3, \quad (9.22)$$

considering also that almost all mass of the vortex is in the core and, hence, its density

$$\rho_{\kappa} = m / V_{\kappa} \approx m / 10 d_{\phi\kappa}^3 \leq \rho_p \quad (9.23)$$

then if the core density were the same as the proton density ($\rho_p = 4 \cdot 10^{17} \text{ kg} \cdot \text{m}^{-3}$), then the photon core diameter would be

$$d_r = \left(\frac{m_\phi}{10 \rho_p} \right)^{1/3} \approx 10^{-18} \text{ m.} \quad (9.24)$$

However, if it were so, the penetrating power of light would be many times greater than the real one. Therefore, although the core diameter is much smaller than the photon vortex diameter, but not to such an extent. Tentatively, we can assume that the core diameter is only two or three orders of magnitude smaller than the photon vortex diameter.

From the calculation of the photon density follows also the fact that in any medium a negligibly small part of the ether participates in the photon. Of course, the given calculations are very approximate. However, it is already clear from the above, why photons of light do not interact with each other: the probability of collision of cores is vanishingly small, and even in case of direct collision photon cores will simply go around each other, avoiding direct collision, and photon bodies freely penetrate through each other.

Thus, the presence of a compacted core, on the one hand, in a different way forces to present the structure of a photon than it would be in an incompressible medium, and on the other hand, explain the fact of stability of photons and the absence of their interaction with each other.

The presence of a core in each vortex of a photon and a tsuga of vortices explains the increased permeability of light in the marine medium. If we proceed from the concepts of modern electrodynamics, then at light frequencies of 10^{14} - 10^{15} Hz, light attenuation in sea water having conductivity of the order of 1-10 Siemens/m should occur at a depth of several millimeters. The real penetration of light is 100-150 m, which is 5 orders of magnitude higher. Ordinary attempts to explain this fact by the reduction of water conductivity at these frequencies have no substantiation. Thus, there is another paradox.

However, if we take into account the above-mentioned about the structure of the photon and each of its vortices, the mechanism of penetration of the photon into water becomes more obvious: the energy of the photon does not consist in it at all, as in a plane electromagnetic wave, it is contained in the cores and in the whole body of the photon, consisting of a large number of vortices.

From the calculation of the photon density also follows the fact that in any medium a negligible part of the ether participates in the photon.

9.3. Moving photons in space

Let us consider the peculiarities of photon motion in space. The cause of photon motion as a system of linear vortices is, as well as for a usual vortex ring, creation of gas flows in the medium due to vortex motion of parts of the photon itself. In this sense the laws of motion of a photon should not essentially differ from the laws of motion of usual vortex rings.

At photon formation, as well as at vortex ring formation, the vortex is compressed by the pressure of the environment, which leads to an increase in the vortex energy and a decrease in its diameter. A distinctive feature of the photon is that at the moment of formation the central part of the linear vortex is mainly subjected to compression, resulting in the formation of a core. Further in the process of motion the photon energy is only consumed, mainly to overcome the viscous friction of the ether during vortex rotation.

In the translational motion of a photon, as well as in the motion of a vortex ring of a gas, three stages should be distinguished.

The first stage of motion is the motion of a photon immediately after its formation. As for any vortex ring, in the photon all the main transient processes related to the establishment of its structure and velocity must end during $(4-5)\lambda$ (for the ring - during 4-5 of its diameters), i.e. on the path of the order of $5 \cdot 10^{-6}$ m and time of the order of $2 \cdot 10^{-14}$ s.

The initial velocity of the photon is not equal to the speed of light - its steady-state velocity, because the mass of the ether, which formed the photon, rested relative to the atom. This mass of ether has inertia, therefore, the acceleration of the photon should occur according to the exponential law:

$$v_{\phi} = c - (c - c_0) e^{-\frac{t}{T_{f,prod}}} \quad (9.25)$$

Based on the above, we can assume that the time constant of the longitudinal motion of the photon lies in the range 10^{-15} - 10^{-14} s. Of course, for different wavelengths the time constant will be different.

Taking into account that the photon formed by the emitting atom is a tsug of vortices, one has to consider that in one and the same

The same photon during its formation undergoes different processes. In that part which after vortex formation has moved away from the emitting atom more than five wavelengths, all basic processes have already been completed, while in that part which is close to the atom these processes are still going on.

The time constant of the longitudinal motion of the photon should be distinguished from the time constant of the transverse displacement of the photon when it enters the ether jet transverse to the photon motion direction. This time constant is determined by the force of the transverse pressure of the ether stream on the photon core and the core mass, and it is many times larger than the time constant of the longitudinal motion of the photon.

The second stage of the photon's motion is its steady motion along its entire main path, enclosed in the interval 10^{24} - 10^{25} m and existence time of the order of 10^{17} - 10^{18} s (tens of billions of years).

The radius of photon vortices, as well as any gas vortices, and its wavelength grow with time according to the law [25]

$$\Delta R(t) = \alpha(\lambda)L(t), \quad (9.26)$$

where α is a small parameter. For air vortices this value is equal to 0.01-0.001, and for ether it is significantly less.

Taking into account that the photon at the moment of formation had some initial wavelength and size, it is more correct to write this expression in the form [26]:

$$R(t) = R_0 + \alpha_R L(t), \quad (9.27)$$

or

$$\lambda(t) = \lambda_0 + \alpha_\lambda L(t). \quad (9.28)$$

Comparing this expression with the Hubble's law of redshift of spectra

$$z = \frac{\lambda - \lambda_0}{\lambda_0} = H \frac{L(t)}{c_0}, \quad (9.29)$$

where $H = 3 \cdot 10^{-18} \text{ s}^{-1}$ is the Hubble constant, we obtain

$$\lambda = \lambda_0 + \frac{H}{c} - L(t), \quad (9.30)$$

i.e.

$$\alpha_\lambda = \lambda_0 - \frac{H}{c} = 10^{-26} \lambda_0. \quad (9.31)$$

For $\lambda_0 = 5 \cdot 10^{-7}$ m we have $\alpha_\lambda = 5 \cdot 10^{-33}$. The distance traveled by the vortex system is determined by the expression

$$L(t) = \frac{R_0}{\alpha} \left[(1 + 4 \frac{\alpha v_0}{R_0} t)^{1/4} - 1 \right], \quad (9.32)$$

which with respect to the photon will give, considering $\alpha v_0 / R_0 = 2H$,

$$L(t) = \frac{st}{2Ht} \left[(1 + 8Ht)^{1/4} - 1 \right]. \quad (9.33)$$

Accordingly, the speed of the photon will be

$$with_{\phi} = \frac{c}{(1 + 8Ht)^{3/4}} \quad (9.34)$$

Hence, the photon velocity cannot be considered constant. It decreases with time, although, if we take into account that the photon is a system of linear rather than circular vortices, this dependence should not be so strong, as it follows from expression (9.34), at exact fulfillment of which at $Ht = 1$ the photon velocity will be only 0.37s.

The difference of properties of a photon from properties of a circular vortex should be sought in a difference of densities of a photon body and a medium, in a difference of forms of medium flows created by a photon from forms of medium flows created by a circular vortex, in nonlinear phenomena on boundaries of vortices, in particular in a boundary layer, and the main thing, in presence in linear vortices of photons of compacted cores that in aggregate causes higher stability of a photon, than usual vortices.

Substitution of Planck's law expression into Hubble's law of "redshift" spectra of distant galaxies allows us to establish the law of photon energy loss during the second stage of its motion.

As is known, the spectra of stars in distant galaxies are characterized by the presence of the so-called "red shift" of the spectra toward longer wavelengths. The astronomer Hubble derived a law of the "red shift" that was named after him:

$$z = \frac{\lambda - \lambda_0}{\lambda_0} = H \frac{L}{c}, \quad (9.35)$$

where λ_0 is the wavelength of the light source; λ is the wavelength of light received by the observer; L is the distance from the light source to the observer; c is the speed of light; $H = 3 \cdot 10^{-18} \text{ s}^{-1}$ is the Hubble constant ($T = 1/H = 3.3 \cdot 10^{17} \text{ s} = 10^{10} \text{ years}$).

The energy of a photon is determined by Planck's law

$$E = h\nu. \quad (9.36)$$

Considering that

$$\lambda = c/\nu, \quad (9.37)$$

we get

$$z = \frac{E_0 - E}{E} = \frac{\Delta E}{E} = H \frac{\Delta L}{c}, \quad (9.38)$$

Or at the limit.

$$\frac{dE}{E} = -H \frac{dL}{c}. \quad (9.39)$$

Integrating and considering that at $L = 0$ $E = E_0$, we obtain:

$$E = E_0 e^{-\frac{H}{c} L} = E_0 e^{-10^{-26} L} = E_0 e^{-10^{-10} t}, \quad (9.40)$$

where distance L is measured in meters and time t is measured in years.

Thus, one obtains a natural exponential law of photon energy decrease, which can be considered as not the result of "the Universe scattering", as it is now accepted, but the result of the viscosity of the ether, in which the photon passes. The time for which the photon's wavelength doubles is determined from the relation

$$\frac{\lambda_2}{\lambda_0} = \frac{E_0}{E_2} = e^{\tau/3 \cdot 3^{-10^{17}}} = 2, \quad (9.41)$$

from where

$$\tau = 3.3 \cdot 10^{17} \ln 2 = 2.31 \cdot 10^{17} c = 7 \cdot 10^9 \text{ years}. \quad (9.42)$$

The third stage of photon motion occurs at the last stage of its existence after a time of about 10-20 billion years after its formation. During this time, the photon loses energy 2.7-7.3 times. The loss of energy of the photon should affect its stability. The structure of the photon is destroyed, the cores have already exhausted their energy and do not exist, photons split into fragments, collide with each other and form, if we can say so, "photon gas", in which they collide with each other and lose their original direction.

By analogy with the annular vortex, at this stage there should be a deceleration and further diffusion and transition of matter of the ether, forming a photon, to a free state not related to the vortex motion. It is probable that photons at the third stage of their existence are perceived as so-called relic radiation of cosmic space [27], and at least they are a part of it.

The given relations are in qualitative agreement with the known concepts of vortex diffusion in media [28].

Taking into account the stated above it is necessary to suppose that the nature of "redshift" is twofold: firstly, the loss of energy by photons due to viscosity of the ether, and secondly, slowing down of speed of moving of a photon in space.

9.4. Optical phenomena

9.4.1. Reflection of light

At reflection of a photon from the boundary of two media, a part of the ether of each elementary photon jet is reflected, a part is refracted and enters the second medium. If the second medium is metal, then its surface is covered by what's called the Fermi surface. - a shell of electrons oriented in pairs antiparallel and occupying the entire surface area (Fig. 6.14).

In the literature, the mechanism of light reflection is associated with the occurrence of secondary waves caused by fluctuations of the electrons of the Fermi surface under the influence of incident light. However, there are no grounds for such an assertion. In fact, a photon will be reflected from such a surface according to all the rules of an ordinary elastic shock [29], and not at all by re-radiation, as it is assumed now (see, for example, [30, p. 45]).

Indeed, as it is known [31-33], 1 cm³ of metal contains 10²² -10²³ free electrons. The depth of light penetration into metals is

$$d = \frac{1}{4\pi} \left(\frac{c \lambda_0}{\mu \sigma} \right)^{1/2}, \quad (9.43)$$

where σ is the conductivity of the metal.

For visible light, the penetration depth is 10⁻⁷ -10⁻⁵ m, this layer concentrates the

$$n = (2 \lambda)^2 (10^{22} - 10^{23}) = 5(10^9 - 10^{10}) \text{ electrons.} \quad (9.44)$$

The mass of each electron is approximately equal to the mass of one linear vortex of the photon. Taking into account that the photon collides with electrons, the total mass of which exceeds its mass by billions of times, we have to state that the electrons under the influence of the photon will be displaced by a negligible value, which in no way can provide the re-radiation of the photon.

It should be noted that the scattering of jets caused by the deviation of the shape of the "Fermi surface" or "free" electrons from the plane immediately ceases after reflection, since the reflected jets form a vortex common to these jets and common in this vortex

flow, in which all the reflected jets are reordered again. A part of the ether streams, which passed into the metal and did not come to the surface, will be dispersed in the metal and its energy will go to increase the temperature of the metal.

Thus, the reflection of an elementary jet of ether from the metal surface occurs according to the laws of a simple mechanical impact, and it automatically follows that the angle of incidence and the angle of reflection of elementary jets will be equal to each other. In the same way it is possible to consider the reflection of the whole photon from the metal surface.

When hitting a barrier (mirror) with the barrier, only one vortex reacts with the barrier at each moment of time, since the photon excitation moves with the speed of light in the photon body, but the photon itself moves with the same speed. If an elementary vortex having normal and tangential components of velocity relative to the reflection surface touches the reflection surface and continues its motion, then each of its elementary jets having the shape of a circle in the vortex, reflecting according to the law of elastic impact, will keep the shape of a circle, but the flow in it will be directed after the impact in the direction opposite to the direction before the impact (Fig. 9.6). As a result, in the reflected vortex the vortex velocity circulation (magnetic strength) will have the opposite sign compared to the sign of the velocity circulation in the incident vortex. Since the vortices of the first and second rows will change places with respect to the direction of motion, the sign of the circulation with respect to this direction will be preserved.

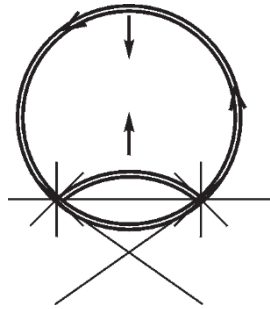

Figure 9.6. Reflection and refraction of an elementary vortex

Other is the case with the circulation of the longitudinal motion of the ether. At reflection from a surface the direction of longitudinal motion of the ether will remain, but the direction of motion of the reflected photon itself will change, the rows of vortices will change places, which will lead to a change of the sign of spin to the opposite, if the incident light had spin $+1$, the reflected one will have spin -1 and vice versa, which does not follow from the usual theories (Fig. 9.7).

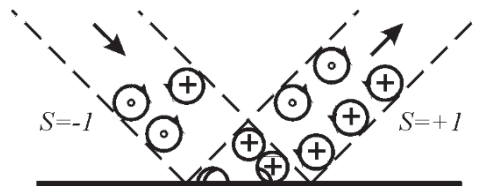

Fig. 9.7. Change of the sign of the photon spin at reflection

9.4.2. Light refraction

When light hits the surface of the medium interface, it is partially reflected and partially refracted. This phenomenon is based on reflection and refraction of an elementary gas jet (Fig. 9.8) passing from a medium of one ether density into a medium of another density. The difference of densities at preservation of equality of pressures at the boundary of two media can be caused, for example, by the difference of ether temperatures in these media, which, in its turn, is a consequence of the difference of vortex structures of these media.

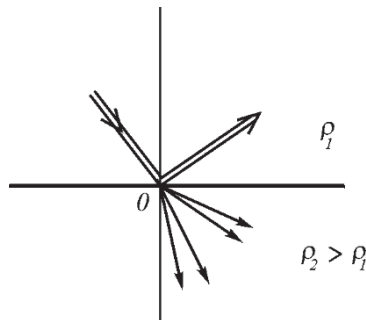

Figure 9.8. Refraction of a gas jet

Assuming that in each medium the aether density is constant on the average, and considering that the total energy of each gas jet at crossing the boundary of the mediums is conserved, the following relations are valid for each medium on the basis of Bernoulli's equation:

$$v_2^2 + P/\rho_1 = v_2^2 + P/\rho_2 = C, \quad (9.45)$$

from where

$$\rho_1 / \rho_2 = v_2^2 / v_1^2. \quad (9.46)$$

Considering that the ratio of propagation velocities of electromagnetic wave in vacuum and in medium is the index of refraction and that the relative magnetic permeability for all transparent media is practically equal to 1, we obtain.

$$\rho_{cp} / \rho_{bak} = v_{bak}^2 / v_{cp}^2 = n^2 = \mu \epsilon = \epsilon, \quad (9.47)$$

where n is the refractive index of the medium; μ is the relative magnetic permeability; ϵ is the relative dielectric permittivity. Hence, dielectric permittivity of the medium is the ratio of the density of the ether flux in the medium to the density of the ether in the same flux in vacuum.

When one edge of the photon reaches the boundary of two media due to the greater density of the ether in the optically denser medium, the velocity will decrease by n_2 / n_1 times, while the other edge of the photon continues to move with the velocity v_1 (Fig. 9.9).

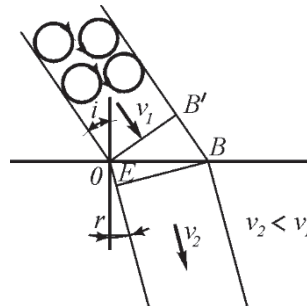

Figure 9.9. To the conclusion of the law of refraction of light

Consequently, when the second edge of the photon touches the surface of the optically denser medium, a time t_0 , during which the first edge in the second medium will have traveled a distance $v t_{20} = OE$, will elapse. For the second edge $v t_{10} = VV_1$. Further

$$\frac{VV_1}{OV_1} = \sin i = \frac{v t_{10}}{OV_1}; \quad \frac{OE}{OV_1} = \sin r = \frac{v_2 t_{20}}{OV_1}, \quad (9.48)$$

or

$$\frac{\sin i}{\sin r} = \frac{v n_1}{v n_2} = \frac{1}{2}. \quad (9.49)$$

It follows that

$$\lambda_2 = \lambda_1 \frac{n_1}{n_2} \quad (9.50)$$

and diameters of vortices in the medium with higher density are correspondingly smaller than diameters of vortices in the medium with higher aether density.

9.4.3. Interference

Interference is one of the main phenomena that confirm, as it is believed, the wave nature of light [15, p. 242-340]. However, it is easy to show that the similarity of light interference with wave interference is superficial, not revealing the essence of the phenomenon.

First of all, it should be noted that the addition of oscillations is not a prerogative of waves alone. Vortex structures behave in the same way as waves transverse to the direction of motion: their intensities can sum up at the same size and direction of motion and not interact with each other at different directions of motion or different sizes.

Since the density of ether in a photon is a small fraction of the density of the medium, and the mean path length exceeds the sizes of amers by many orders of magnitude, the photons appear capable to penetrate through each other without appreciable interaction. The kernels having high density but small sizes will simply envelop each other. At the same time on the obstacle, which is any

screen, there should be a mixing of jets and a corresponding increase or decrease in their intensity.

Without the in-phase of photons coming from different points of the light emitter, the phenomenon of interference would be impossible, because the photons in the interfering beams would be unrelated in phase, even if their frequencies were the same. The phases of individual photons would have a chaotic shift relative to each other, and no interference would be possible. Interference of light is a real phenomenon, which means that the emitting atoms must necessarily synchronize and synphase with each other. However, the wave theory cannot explain this.

The principle mechanism of mutual synchronization and synphasing of radiating atoms has been stated above. This mechanism, which is impossible in the wave model, makes it possible to ensure synchronous and in-phase emission of all photons emitted at the same moment. As a result, a single phase of radiation is established at each moment of time over the entire area of the emitter, which is many times larger than the cross-sectional area of a single photon. After splitting, the rays in the interferometer retain a stable phase of radiation relative to each other, which makes it possible to obtain an interference pattern after the addition of these rays.

Since the phase of radiation can change with time, if the lengths of the interfering rays are significantly different, the clarity of the interference pattern is impaired. Hence a practical recommendation: when designing interferometers, it is advisable to strive for equality of the lengths of both interfering rays.

In all other respects, the interference pattern of vortex photons is quite similar to the wave pattern, since the intensities of vortices can sum up in exactly the same way as the intensities of ordinary waves, and vortex photons are capable of producing an interference pattern in the same way as waves.

9.4.4. Diffraction

Diffraction along with interference is usually considered as a confirmation of the wave nature of light [15, p. 341-419]. However, like interference, diffraction can be considered from the viewpoint of the vortex structure of the photon.

As is known, diffraction of light - deviation of the direction of light propagation from the straight line near the edges of opaque objects - occurs as a result of interaction of light with these objects

edges, which was pointed out by Jung in 1800. In this case, the light behind the edge of an object is deflected toward that object, illuminating the shadow area.

The interpretation of diffraction taking into account the Huygens principle [15, pp. 341-345; 35], according to which the points of the edge of the object are taken as a new source of waves, is very artificial, since according to the same principle any point can be taken as a source of waves, and in this sense the edge of the object is not something special. Such explanation does not shed light on the physical essence of diffraction and is at best a calculating trick.

The essence of diffraction is easy to understand if we consider the passage of a vortex photon in the vicinity of an opaque object. As can be seen from Fig. 9.10, the surface of an opaque object, near which the photon flies, is the surface of an average stationary ether. This follows from the fact that interatomic distances are of the order of 10^{-10} m and the order of wavelen λ is 10^6 m. Therefore with respect to the photon the vortex motions of the surface of atoms are averaged.

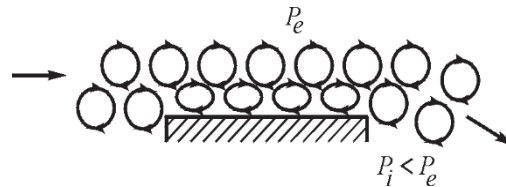

Fig. 9.10. Photon diffraction mechanism

In the gap between the photon and the object there is a large velocity gradient because the edge of the photon vortex moves with high velocity in the direction opposite to the photon's direction of motion and the gap is relatively small. There is no foreign object on the opposite side of the photon, hence the velocity gradient is small. It follows that the pressure of the ether on the side of the object is essentially smaller than on the side of the free ether, and the photon is pressed to the object.

After the photon passes the object, it enters the zone in which the pressure begins to equalize, since the object is no longer there. In this zone the pressure is already higher than in the gap, but still lower than in the free ether. Since the opaque object does not prevent the photon's displacement any more, and the pressure difference still exists, the photon is deflected towards the shadow of the object.

It follows from the above that the photon rotation angle should depend on the shape of the edge of the object. At increasing the radius of curvature of the edge of an opaque object the angle of rotation of the photon should slightly increase, which can be checked experimentally. It can be expected that the effect begins to appear noticeably at radii of rounding of the order of tens of centimeters or units of meters.

9.4.5. Aberration

Aberration of light in astronomy is a change in the apparent position of the luminary on the celestial sphere, due to the finiteness of the speed of light and the movement of the observer due to the rotation of the Earth (daily aberration of light), the Earth's rotation around the Sun (annual aberration of light) and the movement of the solar system in space (secular aberration of light) [15, pp. 420-450; 36].

The classical theory of light *aberration*, based on the idea of light propagation in a stationary ether (Fig. 9.11), leads to the following dependence between the aberration displacement of the luminary a on the great circle of the celestial sphere, passing through the luminary and the apex - the point to which the observer moves, towards the apex, the angle between the directions to the luminary and the apex ψ and the speed of the observer:

$$\operatorname{ctg}(\psi - a) = \operatorname{ctg} \psi + \frac{v}{c} \operatorname{cosec} \psi. \quad (9.51)$$

Here c is the speed of light.

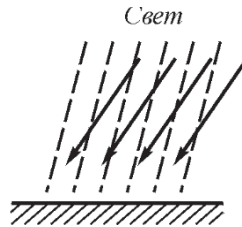

Fig. 9.11. To the mechanism of light aberration

The so-called relativistic correction, derived from the theory of relativity, is only 0.0005", so it is almost never used.

Equation (9.51) can be written in the form

$$\sin a = - \frac{v}{c} \sin \varphi, \quad (9.52)$$

where φ is the geographic latitude of the observation site. Since the angle a is small, then the equation is usually represented as:

$$a'' = \frac{v}{c} 206265'' - \sin \varphi = k \sin \varphi. \quad (9.53)$$

The k value for the annual aberration is currently thought to be 20.50", but this value is approximate, as a more accurate value can be determined by taking into account the Sun's parallax, the Earth's eccentricity, sidereal (sidereal) time, and equatorial radius.

As a result of the diurnal aberration of light, stars are shifted around the great circle of the celestial sphere toward the point east by the value $\cos \varphi' \sin(0.319'' \sigma)$, where φ' is the geocentric latitude of the place of observation, and σ is the angular distance of the luminary from the point east.

The secular aberration displacement of stars is almost undetectable because the direction of the solar system's motion in space changes extremely slowly.

It seems that the above explanation of the causes of aberration is incomplete. One should take into account the vector summation of the Earth's velocities relative to the Galaxy and relative to the Sun (orbital motion), as well as the daily rotation of the Earth (Fig. 9.12).

The displacement of a point on the Earth's surface in the world space is a vector sum of the following displacements (Fig. 9.12):

1. Earth around itself (daily rotation speed at the equator $v_{\text{ЭКВ}} = 463$ m/s). This speed decreases as we approach the poles 1.

$$v_{\varphi} = v_{\text{ЭКВ}} \cos \varphi, \quad (9.54)$$

where v_φ is the velocity of movement of the observation site located at the geographic latitude φ .

2. Earth around the Sun (30.27 km/s at perihelion, 29.27 km/s at aphelion).
3. of the Sun around the center of the Galaxy (180-200 km/s).
4. Galaxies relative to other galaxies (velocity unknown, presumably a few hundred km/s).

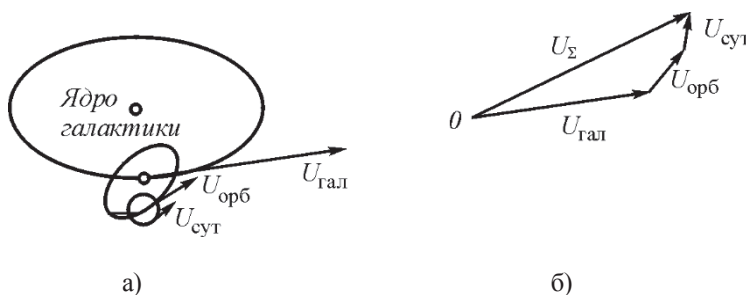

Fig. 9.12. Motion of a point located on the Earth's surface: a - galactic, orbital and daily velocities; b - vector summation of velocities

The classical point of view assuming the absolute immobility of the ether in space (Lorentz theory) would be perfectly valid if in fact the ether did not shift in space and if the Earth in its motion did not capture the ether, but it is not so. The ether wind blows around the Earth [37, 38], its relative speed decreases with decreasing height [39, p. 227-232; 40] and therefore it is reasonable to analyze the phenomenon of light aberration in the future taking into account this circumstance as well.

From the foregoing, it follows that:

- 1) the annual aberration of light in the 44.6-90°S belt will have a smaller value than in the northern latitudes;
- 2) annual aberration at low altitudes, and even more so in deep mines, should have a somewhat lower value than at high altitudes in the same latitudes;
- 3) during space flights it is necessary to carry out location correction taking into account the object's own velocity of motion relative to the ether flows, if this correction is carried out by astronomical means located on the object itself.

The blowing of the globe by etheric flows is not strictly uniform, since these flows themselves are subject to various changes associated, in particular, with solar activity. In addition, air currents of the atmosphere participate in the phenomenon of aberration. The details of the aether blowing around the Earth are outlined below. The classical ideas about the nature of aberration correspond to those presented in this paper, but with some corrections. These corrections are connected with the fact that the Earth not only moves in space, but also is blown by the ether flows, the direction and speed of which is not only stationary, but partly variable. Both stationary streams - ether wind, and non-stationary ones are currently detected experimentally and investigated. The relative velocity of the ether flow relative to the Earth's surface decreases with decreasing height above the Earth's surface, which was discovered by D.K. Miller in 1925, but which was not explained at that time. Today it is already clear that this decrease is due to the viscosity of the ether and corresponds to the theory of the boundary layer of the gas stream blowing the balloon.

The correspondence of the aberration values obtained experimentally to the calculated values indicate that photons do not change significantly the direction of velocity when passing the boundary layer of ether in the Earth's atmosphere, i.e., the interaction of the lateral ether flux with photons is small and the time constant of the transverse establishment of the light velocity relative to the transverse flux is sufficiently large, which has already been mentioned above. Some analogy can be seen in the propagation of smoke rings bursting out of chimneys in the presence of horizontal wind (Fig. 9.13).

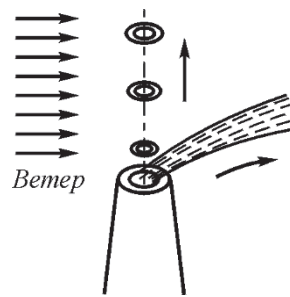

Fig. 9.13. Reduced wind drift of smoke rings compared to normal smoke.

If the wind visibly blows the smoke away, the smoke rings appear to be displaced only slightly. Nevertheless, the difference in experimental aberration data for different observatories located at different latitudes and altitudes should be further analyzed in terms of the ether boundary layer captured by the Earth as it moves.

Thus, taking into account some corrections, we can consider the classical theory of aberration, taking into account the presence of ether in space, as satisfactory in the first approximation. Space.

9.4.6. Interaction of light rays

It is believed that light rays do not interact with each other in any way. In most cases it is so, and it is explained by the fact that the photon body is a rather sparse structure except for the core. But the core is extremely small, and when photons meet, the cores will circle each other, while the photon bodies will pass through each other. Small changes, which may occur at that, will be restored immediately after the exit of photons into the free one.

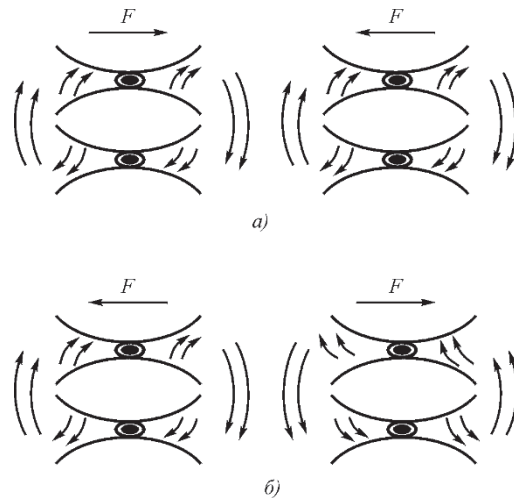

Fig. 9.14. Interaction of coherent polarized photons: a) - in the case of identical spins; b) - in the case of opposite spins.

However, the situation can change in the case of interaction of coherent polarized light rays. As can be seen from Fig. 9.14, if two photons having the same spin pass close to each other, a velocity gradient is formed between them due to the circular motion, in which the pressure of the ether decreases and the photons are attracted to each other. If photons have opposite signs of spins, they, on the contrary, will be repelled from each other. The directions of propagation of light streams will change accordingly. This phenomenon should probably be most noticeable in weakly scattering media, for example, in metal vapors.

Conclusions

1. Light is not an electromagnetic wave, its identification with an electromagnetic wave due to the equality of their propagation speeds cannot serve as a proof of their identity. This is confirmed by the complete divergence of the laws of attenuation of light and electromagnetic wave in a semiconducting medium - in sea water, where light penetrates to a depth 5-6 orders of magnitude greater than the electromagnetic wave.
2. The structure of a photon can be represented as a two-row chain of linear helical vortices of ether, in which vortices of one row rotate in one direction, vortices of the second row - in the opposite direction. Each vortex is compressed in its central part. This structure naturally explains the corpuscular-wave dualism, i.e. corpuscular and wave properties of light, explains polarization, spin, constancy of velocity relative to the ether in a given point of space and other properties of light.
3. All optical phenomena can be interpreted in terms of ether-dynamics. For the main optical phenomena - reflection and refraction of light, interference, diffraction and aberration - it was possible to construct the corresponding ether dynamical models, and the ideas about the essence of optical phenomena were significantly clarified, the change of the sign of the photon spin at each reflection from a metal mirror was predicted, as well as the interaction of polarized light rays.
4. The Hubble redshift law of light spectra indicates not the "expansion of the Universe", but the loss of energy by photons due to the viscosity of the aether. The loss of energy by photons follows an exponential law with a time constant of about 10 billion years.

5. Relict radiation is not a consequence of the Big Bang, it is the last stage of existence of photons emitted by distant stars. At this stage photons have lost their original structure and direction of propagation. The same circumstance can explain the boundary of the visible Universe: the Universe has no real boundary, but starting from a certain distance, photons do not reach the observer.

Chapter 10. Gravitational interactions

GRAVITATION EXISTS TO ALL BODIES IN GENERAL AND
IS PROPORTIONAL TO THE MASS OF EACH BODY.

E. Newton [1]

THE GRAVITY OF A RESTING BODY IS NOTHING BUT
DELAYED MOTION.

M.V.Lomonosov [2]

10.1. Brief history of the development of ideas about gravitation

Gravity (gravitation) has always been and still is considered the most mysterious of all the forces of nature. What distinguishes gravity from other forces is that it cannot be shielded or changed in any artificial way.

The properties of atoms to have gravity were mentioned by Democritus in the 4th century B.C. He mentioned in this connection that atoms consist of amers - true indivisible particles, which, although they are parts of atoms, do not possess gravity. For this Democritus was criticized by all subsequent natural scientists.

The first statements about gravitation as a universal property of bodies date back to antiquity. Thus, Plutarch wrote: "The Moon would fall to the Earth like a stone, as soon as the force of its flight would be destroyed".

In the 16th century, René Descartes returned to the problem of the origin of gravitation. The characteristic features of Descartes' doctrine - the banishment of hidden properties from the science of nature and the indication of the possibility of explaining physical phenomena by motion - caused its vitality, and the scientific trend guided by Descartes' principles is called Cartesian or kinetic. Later on, the Newtonian school entered the struggle with this direction.

According to Descartes' doctrine, the characteristic of matter is extension in length, width and depth, i.e. geometric form. For Descartes, there is no empty space that is not filled with matter. It follows from Descartes' doctrine that equal volumes contain equal amounts of matter. The material particles of absorbent cotton plus the matter that we cannot feel, which fills the gaps, give in sum, according to Descartes, the same amount of matter as the material particles of the same volume of lead. The notion of mass is not worked out by Descartes, and there are good historical reasons for this. But the main thing Descartes has is his belief that the interaction between bodies

is inconceivable without the presence of an intermediary medium. Action is not transmitted through the void, but only through matter. In this connection Descartes developed the idea of aether vortices moving the planets. He condemns Galileo for the fact that, according to him, bodies fall in the void: "everything that he (Galileo) says about the velocity of bodies falling in the void has no foundation; he would have to first define what gravity is, and if his definition were correct, he would know that it does not exist in the void." Descartes is right: in absolute emptiness there is no medium and therefore there is no connection between a body surrounded by emptiness and the Earth.

In the XVI and XVII centuries, evidence of mutual gravitation of bodies was revived in Europe. The founder of theoretical astronomy I. Kepler, analyzing the long-term results of observations of the Danish astronomer Tycho Brahe, derived his famous three laws of celestial mechanics. He believed that the motion of the planets is not at least ordered, but spontaneous wandering: it occurs under the action of some external agent, and this agent is the Sun. Its action weakens as the planet moves away from the Sun. Kepler said that

"gravity is the mutual striving of all bodies", but he made no attempt to understand the causes of this striving. Kepler tried to find a common cause to explain the behavior of the planets and realized that such a cause is the Sun, which is the "driving soul" of the entire planetary system. In the field of astronomical knowledge, Kepler with his empirical laws gave an eternal and unshakable foundation of dynamic astronomy, but the physical justification of planetary motions he is completely absent.

Newton set out to find a single law from which all the Keplerian laws of celestial mechanics would follow [1]. He found such a law and named it the Law of Universal Gravitation. Newton put a lot of effort to find the physical causes of gravitation and tried to attract for this purpose the ether - a medium that fills the entire world space. One of the options was to represent the ether as a gas similar to air, but thinner and more elastic.

In a letter to R. Boyle about the ether, written on February 28, 1679, Newton states five proposals that clarify his idea of the ether [3, p. 41-43].

1) It is assumed that there is an etheric substance scattered throughout space, capable of contraction and expansion and extremely elastic, "in a word," Newton writes, "similar in every respect to air, but only considerably finer.

2) The ether is supposed to penetrate all bodies, but it is rarer in the pores of bodies than in free space, and the rarer the thinner the pores.

3) It is assumed that the rarefied ether inside bodies and the denser one outside them pass into each other gradually and are not confined to sharp mathematical surfaces.

4) It is supposed that when two bodies approach each other, the ether between them becomes rarer than before, and a region of gradual rarefaction extends from the surface of one body to the surface of the other.

"The reason for this is," Newton writes, "that in the narrow space between bodies the ether can no longer move and travel back and forth so freely.

5) It follows from the fourth proposition that when the bodies are approaching each other and the ether between them is rarefied, resistance to this and the desire of the bodies to move away from each other must appear at close approach. Such resistance and desire to move apart will increase at further approaching due to more and more rarefaction of the intermediate ether, but, at last, when the bodies come so close together that the excess of pressure of the external ether surrounding the bodies over the rarefied ether between the bodies becomes so great that it will overcome the resistance of the bodies to approaching, the excess of pressure will force the bodies to approach with force and to adhere very closely to each other".

As can be seen from the above, Newton's ideas about the ether are purely qualitative and in many respects contradictory. This can be explained by the fact that, having correctly assumed the gas-like structure of the aether, Newton had no opportunity to develop this idea, since the properties of gases at that time were not studied. The result was a variety of contradictions, and in the end Newton abandoned the very idea of trying to find the physical basis of gravitation.

At the end of "Principia" Newton says: "Gravitation to the Sun is made up of gravitation to individual particles of it and at a distance from the Sun decreases in exact proportion to the squares of distances even to the orbit of Saturn, which follows from the rest of the aphelion of the planets, and even to the extreme aphelion of comets, if these aphelions are at rest. The cause of these properties of gravitation I have not been able to deduce from the phenomena so far, and *I do not invent hypotheses*. Everything that is not deduced from phenomena must be called a hypothesis. Hypotheses of metaphysical, physical, mechanical, hidden properties have no place in experimental philosophy".

However, this was said after Newton's attempts to discover the physical reason for the existence of gravitation had failed, and the

and as a result, such a statement was made, which looked as if there was no need to look for such reasons.

Since Newton's time, physics has been divided into two opposing schools - Cartesians and Newtonians. The Cartesians assumed the mandatory presence of the world medium - the carrier of interactions, the Newtonians denied it. Cartesians everywhere searched for the physical mechanism of phenomena, they were largely mistaken in specific constructions, but they knew firmly that any phenomenon has such a mechanism. Newtonians, on the other hand, assumed that material objects had some innate properties, which were sufficient to describe as some phenomenology. The Cartesians allowed bodies to interact only by direct contact, while the Newtonians allowed "actio in distance" - action at a distance without any intermediate agent.

This struggle continues even now. Proponents of the theory of relativity in philosophical terms are followers of Newtonians. The author of these lines is a consistent Cartesian.

For many years physicists investigated the problem of equivalence of inert and gravitational masses. The meaning of the problem was that it was not clear whether all bodies in a homogeneous gravitational field receive the same acceleration or not, which was considered as a problem of homogeneity of gravitation and acceleration of bodies. The difference in gravitation and inertia could also be due to the fact that the weight of bodies was created by weighty matter, while inertial forces were created by all matter limited by the volume of the body (according to Descartes). In the experiment it was necessary to use bodies with different specific weights and so that both gravitational and inertial forces were manifested simultaneously.

The statement of the problem seems to belong to Galileo, who suggested the use of a pendulum for this purpose. Newton made precise experiments with the swinging of pendulums made of different substances, which in principle allowed to determine the difference between inertial and gravitational masses. The point is that the forces of inertia and gravitation simultaneously participated in the swing of the pendulum. Taking substances of different densities (Newton had gold and wood) and placing them in identical boxes in the center of mass, Newton established their equivalence with high accuracy. Later, in 1828, Bessel by this method investigated gold, silver, lead, iron and a number of other materials, including the substance of meteorites, and could not notice any deviation from the proportionality of inert and heavy masses. This accuracy was improved in Atwesch's experiments with torsion weights. With the highest

It was proved with precision that the inertial mass manifested in accelerated motion and gravitational mass for substances of any chemical composition are absolutely equivalent. From this, Einstein later concluded that the forces of inertia arising from the accelerated motion of bodies and gravitational forces are of the same nature, which is certainly incorrect, although it is generally accepted. With the same success it is possible to speak about the same physical nature of the gravitational force and the force of a spring holding a weight on the grounds that they produce similar in their results of action, although in the opposite direction.

The numerical value of the gravitational constant G was first determined by the English physicist G. Cavendish (1798), who measured in the laboratory the forces of attraction between two lead balls - a small and a large one. On this basis he determined the average density of the Earth to be about 5 or 5.5. In Paris, the physicist Cornu measured the changes in the weight of a ball when another ball was brought under it and obtained an average Earth density of 5.5. Vernon Boyce about 1900 carefully measured the attraction of a golden ball by another, lead ball, and found the modern value of the Newtonian gravitation coefficient, and clarified the average density of the Earth 5.52 [4, p. 22].

In Newton's theory of gravitation, a system in a homogeneous gravitational field is mechanically equivalent to a uniformly accelerated reference frame. This fact, known for more than two centuries, and served later as a starting point for Einstein in generalizing the partial theory of relativity to the case of accelerated motion. The gravitational field can be "created" if you give accelerated motion to the frame of reference and vice versa,

"annihilate", if present, by another transformation.

Newton's law of universal gravitation was not at all immediately accepted by the world scientific community. After the publication of Newton's "Beginnings" the creativity of English science on the line of celestial mechanics for a long time dries up, the further development of the theory of gravitation passes to the continent and becomes the most important of the tasks set by French science. French scientist Alexie Claude Clerot discovered that Newton's law was insufficient to explain the motion of the lunar perigee. He proposed to supplement Newton's law with other small terms, decreasing in third and fourth powers with distance. This was strongly protested by the French academician Georges Buffon, who stated that "any physical law is a law only because its expression has a

uniqueness and simplicity." However, Clero soon found his error and agreed with Newton's law.

The final triumph of the Law of Universal Gravitation occurred when A. Clero in 1768 on the basis of calculations in accordance with this law predicted the day of appearance of Halley's comet in the sky - March 12, 1759 [5, p. 257]. The appearance of the comet exactly on the specified day was a brilliant confirmation of Newton's mechanics.

However, doubts in the absolute justice of the Law of Universal Gravitation were also connected with the speed of propagation of gravitational interaction. From the static formulas of the Law it follows that this speed is infinitely large.

In 1797, in the "Exposition of the World System", the French scientist Pierre Simon Laplace showed that, from calculations of the Moon's secular acceleration, it follows that the speed of gravity propagation is at least 50 million times higher than the speed of light [6]. These calculations have not been refuted by anyone. They are not refuted today either.

By the middle of the XIX century it became clear that the extension of Newton's law to the entire infinite Universe leads to the so-called gravitational paradox, discovered by German scientists C. Neumann and H. Zeliger. The essence of the paradox is that in each point of space the gravitational potential is infinitely large. At present it is considered that this paradox has been overcome in the framework of relativistic cosmology.

It was created by A. Einstein in 1916. The General Theory of Relativity or, as it is called, the "theory of gravitation" presents the whole problem of gravitation in a different way. Generalizing the conclusions of the Special Theory of Relativity to gravitation and arbitrarily putting the speed of gravitation equal to the speed of light, Einstein explained the attraction of bodies by the fact that masses placed in space create a gravitational potential in it, which curves space, and curved space makes the masses attract. Thus, the physical sense was once again replaced by a quasi-geometric one [7].

From the General Theory of Relativity follows the possibility of the existence of so-called gravitational waves - transverse waves emitted by accelerated moving masses (double stars) and propagating at the speed of light [8]. For their detection in the USA by J. Weber and in Russia by V.B. Braginsky special detectors were created in the form of cylindrical aluminum blocks with a mass of 1.5 t with sensors capable of capturing the oscillations of cylinders at the arrival of gravitational waves, if, of course, these

waves in space propagate at the speed of light, not at a higher speed. These waves have not been detected...

10.2. Thermodiffusion processes in the ether as a basis for gravitational interactions of bodies

As it is known, gravitational interactions are inherent to any bodies possessing mass, and, consequently, this kind of interaction has the most general character, accompanying any other phenomena and interactions, and therefore gravitational interactions should have as a physical basis not less general kind of ether motion. Such most general kind of ether motion is diffusive motion of ether molecules - amers.

It is the diffusive motion that accompanies any other motions and states of the gas medium, which is the ether. At the same time diffusive motion exists in the absence of other types of motion - translational, rotational or oscillatory. Consequently, we can assume that the most widespread motion of the ether - diffusive - is the basis of the most widespread type of interactions - gravitational.

Since the diffusive motion is the interaction by elastic collisions of a large number of particles, it can take place only for a large number of these particles and has no sense for a single particle, which is characterized in this case only by translational motion in space. Consequently, gravitation as a manifestation of diffusive motion is possible only at presence of a set of amers. This circumstance was not understood by some researchers of Democritus' work, in particular, Alexander of Aphrodisia and all subsequent ones up to the modern ones, who criticized Democritus for the statement that the atom (a set of amers) has gravity, and the amer - a part of the atom - has no gravity.

Since the gravitational interaction is related to matter, it is reasonable to consider its nature to begin with the analysis of the interaction of matter and ether on the basis of diffusive motion.

Gravitational interaction of bodies, occurring as a result of thermodiffusion process in the ether surrounding these bodies, should be considered, first of all, as a consequence of cooling of the ether by surface layers of nucleons forming atomic nuclei. To this is added the cooling of the ether also by all attached vortices - electron shells and van der Waals shells,

but their contribution to gravitation is insignificant due to the smallness of mass, and also due to the insignificance of their temperature decrease of the ether in comparison with nucleons.

As a result of cooling of the ether by the surfaces of nucleons, a temperature gradient and, as a consequence, a pressure gradient arise in the ether. A body caught in the field of pressure gradient begins to experience the difference of ether pressure: from the side of the body that formed the temperature gradient the ether pressure will be less than from the opposite side. The same will happen with the second body. The bodies will be pushed by the ether towards each other (Fig. 10.1).

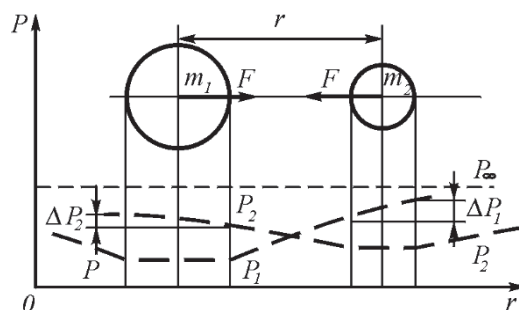

Fig. 10.1. Mechanism of gravitational interaction of bodies: CHANGE OF TEMPERATURE AND PRESSURE OF ETHER NEAR GRAVITATIONAL MASS AND GRAVITATIONAL INTERACTION OF TWO MASSES

It has been shown above that particles of matter are vortex formations of ether. In vortex gas formations, the gas temperature is always lower than the temperature of the environment surrounding the vortex. Due to the thermodiffusion process there is a heat exchange between the vortex and its surrounding medium. As a result of heat exchange, the temperature of the vortex should continuously increase due to the heat inflow from the vortex environment, and the temperature of the vortex environment should decrease. Thus, there is an unsteady thermodynamic process around each vortex of the ether. The time of its completion depends on many components, in particular, on the ratio of ether densities in the vortex and in free space, on the quality of thermal contact between the surface of the vortex and free ether, on the temperature difference between the vortex and free ether, on the heat conductivity coefficient of the medium and on some other factors.

The main actor in creation of gravitational forces are nucleons - protons and neutrons, as they are the maximally compacted vortices of the ether with minimal temperature, hence they are the main negative heat source cooling the surrounding ether, creating in it a temperature gradient and thus a pressure gradient.

Nucleons themselves, possessing the highest density and being whole bodies, are subject to the influence of the pressure gradient, other vortex formations - electron shells, van der Waals shells, ether jets, etc., are penetrating structures, moreover, having a small specific mass. - are penetrating structures having small specific mass, the influence of which on gravitational processes is not so essential.

Thus, to clarify the essence of the gravitational interaction at this stage it is reasonable to dwell on the gravitational interaction of nucleons only.

As shown in Sec. 5, around each proton the temperature decreases, and in the surrounding space there appears a temperature gradient of the ether. The consequence of the temperature gradient is the ether pressure gradient around the protons.

As shown in Chapter 5, the temperature gradient in three-dimensional space can be represented in the following form:

$$\text{grad } T = -\frac{k q_q}{r^2} F(r,t), \quad (5.88)$$

where q is the power of the heat source,

$$F(r,t) = \frac{1}{\sqrt{2\pi}} \int_0^{\infty} \frac{\partial}{\partial r} \left(\frac{1}{r} e^{-\alpha^2 r^2} \right) d\alpha; r_0 = 2 \sqrt{at} \quad (5.89)$$

In doing so.

$$\lim_{r \rightarrow 0} F(r,t) = 1. \quad (5.90)$$

But the temperature gradient is proportional to the total capacity of heat sources Q , so

$$\text{grad } T = - \frac{k Q_q}{r^2} F(r,t), \quad (10.1)$$

and the power of heat sources - protons, enclosed in the body, is proportional to the mass of the body, i.e.

$$Q \sim M, \quad (10.2)$$

so that in the surroundings of the body having mass M , the temperature gradient will be:

$$\text{grad } T = - \frac{k M_M}{r^2} F(r,t) \quad (10.3)$$

The resulting force acting on a proton trapped in the temperature gradient field of the first proton will be proportional to the pressure gradient and the vortex volume:

$$F = S L_{\text{эКБэКБ}} \text{grad} P = V_{\text{эКБ}} \text{grad} P. \quad (10.4)$$

This force is independent of the orientation of the body in space because it is determined by the volume of the body and the pressure gradient of the aether.

The ratio of temperature to pressure, as well as the ratio of their gradients in the aether in near-solar space is

$$\frac{T_3}{P_3} = \frac{\text{grad} T_3}{\text{grad} P_3} = \frac{2m_a}{3k\rho_3} = \frac{2 \cdot 1,5 \cdot 10^{-114}}{3 \cdot 1,38 \cdot 10^{-23} \cdot 8,85 \cdot 10^{-12}} \quad (10.5)$$

$$= 8,2 \cdot 10^{-81} \text{ K-Pa.}$$

The gravitational constant can be expressed through the parameters of the ether and the parameters of protons - the first p_1 , creating a temperature gradient in space, and the second p_2 , perceiving the pressure gradient created by this temperature gradient.

It follows from the expression of Newton's Law of Universal Gravitation that

$$F_{p_1 p_2} = G \frac{m_{p_1} m_{p_2}}{r^2} = V_2 \text{grad} P_1, \quad (10.6)$$

where G is the gravitational constant, m_{p_1} and m_{p_2} are the masses of the first and the second proton, respectively, V_2 is the volume of the second proton, and $\text{grad} P_1$ is the pressure gradient in the ether created by the first proton, r is the distance between the protons, and considering the relations

$$\text{grad} P_1 = \frac{3k \rho_3}{2} \text{grad} T_1 = \frac{3k n_a}{2} \text{grad} T_1; \quad (10.7)$$

$$\Delta T_1 = R_{p_1} \text{grad} T_1, \quad (10.8)$$

where $k = 1.38 \cdot 10^{-23} \text{ J} \cdot \text{K}^{-1}$ is the Boltzmann constant; $\rho_3 = 8.85 \cdot 10^{-12} \text{ kg} \cdot \text{m}^{-3}$ is the density of the ether; $m_a = 1.5 \cdot 10^{-12} \text{ kg}$ is the mass of an amer; $n_a = 5.8 \cdot 10^{102} \text{ m}^{-3}$ is the number of amers in a unit volume of the ether, we obtain

$$G = \frac{3k n_a R_{p_1} \Delta T_1}{m_{p_1} m_{p_2}}, \quad (10.9)$$

here R_{p_1} is the radius of the first proton; ρ_{p_2} is the density of the second proton.

Thus, the gravitational constant connects parameters of the ether, parameters of protons - creating temperature gradient in the ether and perceiving pressure gradient created by this temperature gradient, and temperature difference on the surface of the first proton due to which the temperature gradient is created in the ether.

Hence the gravitational force of interaction between protons can be expressed as

$$F_{p_1 p_2} = \frac{3k n_a R_{p_1} \Delta T_1 V_{p_2}}{2 r^2}. \quad (10.10)$$

The obtained expression shows the physical nature of gravitational forces: the proportionality of the number of amers in the unit volume of the ether, the radius of the first proton that creates the temperature gradient in the ether, the volume of the second proton that perceives the pressure gradient,

created by this temperature gradient, and inversely proportional to the square of the distance between them. Everything made simple physical sense.

The force with which a proton on the surface of a celestial body is attracted to this body is equal to

$$F_{pt} = f \frac{m_p M_T}{R_T^2} = V_p \text{grad} P_3, \quad (10.11)$$

where $m_p = 1.6725 \cdot 10^{-27}$ kg is the mass of the proton; M_T and R_T are the mass and radius of the body; $V_p = 5.88 \cdot 10^{-45}$ m³ is the volume of the proton.

From here we find the pressure gradient of the ether pressure on the surface of the celestial body:

$$\text{grad} P_{3T} = G \frac{m_p M_T}{R_T^2 V_p} = G \frac{\tau \rho_p}{R_T^2}, \quad (10.12)$$

where $\rho_p = 2.8 \cdot 10^{17}$ kg·m⁻³ is the proton density.

Accordingly, the temperature gradient will be equal to

$$\text{grad} T_3 = \frac{2m_a}{3k\rho_3} \text{grad} P_3 = 8.2 \cdot 10^{-81} \text{grad} P_3. \quad (10.13)$$

The reduction in pressure at the surface of the body will be:

$$\Delta P = \int_{R_T}^{\infty} \text{grad} P_3 dr = \int_{R_T}^{\infty} G \frac{M_T \rho_p}{r^2} dr = - \frac{M_T \rho_p}{r}, \quad (10.14)$$

and lowering the temperature

$$\Delta T = \frac{2m_a}{3k\rho_3} \Delta P = 8.2 \cdot 10^{-81} \Delta P \quad (10.15)$$

At the surface of the proton ($m_p = 1.6725 \cdot 10^{-27}$ kg, $R_p = 1.12 \cdot 10^{-15}$ m) we obtain

$$\text{grad}P_{\text{эп}} = f \frac{\rho_p m_p}{R_p^2} = \quad (10.16)$$

$$= \frac{6.67 \cdot 10^{-11} - 2.8 \cdot 10^{17} - 1.6725 \cdot 10^{-27}}{(1.12 \cdot 10^{-15})^2} = 2.32 \cdot 10^{10} \text{ Pa} \cdot \text{m}^{-1}$$

$$\text{grad}T_{\text{эп}} = 8.2 \cdot 10^{-81} \text{ grad}P_{\text{эп}} = \quad (10.17)$$

$$= 8.2 \cdot 10^{-81} \cdot 2.32 \cdot 10^{10} = 1.9 \cdot 10^{-70} \text{ K} \cdot \text{m}^{-1}.$$

The decrease of the ether pressure on the proton surface is:

$$\Delta P_{\text{эп}} = -f \frac{\rho_p m_p}{R_p} = \quad (10.18)$$

$$= - \frac{6.67 \cdot 10^{-11} - 2.8 \cdot 10^{17} - 1.6725 \cdot 10^{-27}}{1.12 \cdot 10^{-15}} = - 2.8 \cdot 10^{-5} \text{ Pa}, 1.12 \cdot 10^{-15}$$

and the temperature drop will be:

$$\Delta T_{\text{эс}} = - 8.2 \cdot 10^{-81} \Delta P = \quad (10.19)$$

$$= - 8.2 \cdot 10^{-81} \cdot 2.8 \cdot 10^{-5} = 2.3 \cdot 10^{-85} \text{ K},$$

which is a negligible value from the pressure and temperature of the ether in free space:

$$\frac{\Delta P_{\text{эс}}}{P_{\text{э}}}}{\frac{\Delta T_{\text{эс}}}{T_{\text{э}}}} = \frac{2.8 \cdot 10^{-6}}{1.3 \cdot 10^{36}} = 2.15 \cdot 10^{-42}. \quad (10.20)$$

At the surface of the Sun ($M_s = 1.99 \cdot 10^{30} \text{ kg}$; $R_c = 6.96 \cdot 10^8 \text{ m}$) we have:

$$\text{grad}P_{\text{эс}} = f \frac{\rho_p M_c}{R_c^2} = \quad (10.21)$$

$$= \frac{6.67 \cdot 10^{-11} - 2.8 \cdot 10^{17} - 1.99 \cdot 10^{30}}{(6.96 \cdot 10^8)^2} = 7.65 \cdot 10^{19} \text{ Pa} \cdot \text{m}^{-1} ;$$

$$\text{grad}T_{3C} = 8.2 \cdot 10^{-81} \text{ grad}P_{3C} = \quad (10.22)$$

$$= 8.2 \cdot 10^{-81} \cdot 7.65 \cdot 10^{19} = 6.3 \cdot 10^{-61} \text{ K} \cdot \text{m}^{-1} .$$

The decrease in the aether pressure at the surface of the Sun is equal to

$$\Delta P_{eS} = -f \frac{\rho_p M_C}{R_C} = \quad (10.23)$$

$$= - \frac{6.67 \cdot 10^{-11} - 2.8 \cdot 10^{17} - 1.99 \cdot 10^{30}}{6.96 \cdot 10^8} = - 5.34 \cdot 10^{28} \text{ Pa}, 6.96 \cdot 10^8$$

and the temperature decrease will be

$$\Delta T_{3C} = - 8.2 \cdot 10^{-81} \Delta P = - 8.2 \cdot 10^{-81} \cdot 5.34 \cdot 10^{28} = 4.4 \cdot 10^{-52} \text{ K}, \quad (10.24)$$

which is a small fraction of the pressure and temperature of the aether in free space:

$$\frac{\Delta P_{3C}}{P_3} = \frac{\Delta T_{3C}}{T_3} = 4.1 \cdot 10^{-8} . \quad (10.25)$$

At the Earth's surface ($M_3 = 5.97 \cdot 10^{24} \text{ kg}$; $R_3 = 6.3 \cdot 10^6 \text{ m}$) we have:

$$\text{grad}P_{33} = f \frac{\rho_p M_3}{R_3^2} = \quad (10.26)$$

$$= \frac{6.67 \cdot 10^{-11} - 2.8 \cdot 10^{17} - 5.97 \cdot 10^{24}}{(6.3 \cdot 10^6)^2} = 2.8 \cdot 10^{18} \text{ Pa} \cdot \text{m}^{-1} ;$$

$$\text{grad}T_{33} = 8.2 \cdot 10^{-8} \text{ grad}P_{33} = 8.2 \cdot 10^{-81} \cdot 2.8 \cdot 10^{18} = 2.3 \cdot 10^{62} \text{ K} \cdot \text{m}^{-1} \quad (10.27)$$

The decrease in the ether pressure at the Earth's surface is equal to

$$\Delta P_{33} = -f \frac{\rho_p M_3}{R_3} = \quad (10.28)$$

$$= - \frac{6.67 \cdot 10^{-11} - 2.8 \cdot 10^{17} - 5.97 \cdot 10^{24}}{1.77 \cdot 10^{25}} \text{ Pa}, 6.3 \cdot 10^6$$

and lowering the temperature

$$\Delta T_{33} = - 8.2 \cdot 10^{-81} \Delta P = \quad (10.29)$$

$$= - 8.2 \cdot 10^{-81} \cdot 1.77 \cdot 10^{25} = - 1.45 \cdot 10^{-55} \text{ K},$$

which is an even smaller fraction of the pressure and temperature of the aether in free space than for the Sun:

$$\frac{\Delta P_{33}}{P_3} = \frac{\Delta T_{33}}{T_3} = 1.1 \cdot 10^{-11}. \quad (10.30)$$

The temperature gradient in the aether is related to the heat flux by the Fourier equation:

$$dQ/dt = - K_T S \text{grad}T, \quad (10.31)$$

where dQ/dt , J/s is the heat flux Q per unit time, K_T is the heat transfer coefficient of the medium, equal to $1.2 \cdot 10^{89} \text{ m} \cdot \text{s}^{-3} \cdot \text{K}$ for the ether; S is the surface area normal to the direction of the heat flux through which the flux flows, in the case under consideration is the surface area of the proton, equal to $\sigma_p = 1.69 \cdot 10^{-29} \text{ m}^2$.

Substituting the parameters, we obtain

$$dQ/dt = -1.2 \cdot 10^{89} \cdot 1.69 \cdot 10^{29} \cdot 1.9 \cdot 10^{-70} = 3.85 \cdot 10^{-10} \text{ J} \cdot \text{s}^{-1}. \quad (10.32)$$

The negative heat reserve in the proton is equal to

$$\Delta Q = \frac{m_p (u_3^2 - u_p^2)}{2} = \quad (10.33)$$

$$= \frac{1.6725 \cdot 10^{-27} (5.4^2 \cdot 10^{46} - 3^2 \cdot 10^{18})}{2} = 2.44 \cdot 10^{20} \text{ J.}$$

Hence, the time constant of proton heating due to the heat of the surrounding ether will be:

$$T = \frac{\Delta Q}{dQ/dt} = \frac{2.44 \cdot 10^{20}}{3.85 \cdot 10^{-10}} = 6.3 \cdot 10^{29} \text{ s} = 2 \cdot 10^{22} \text{ years,} \quad (10.34)$$

i.e., during the proton's existence, which is 10-20 billion years, its heating due to the heat of the surrounding ether will be absolutely negligible.

Thus, the temperature gradient at small distances decreases proportionally to the square of the distance, and decreases much faster at large distances.

With the removal from the vortices of the ether - particles of matter - the temperature of the ether rises to some value T_∞ , characterizing the temperature of the ether in the space free from vortices.

Thus, the gravitational field is interpreted as a field of pressure gradient in the ether caused by the temperature gradient resulting from the cooling of the ether by the boundary layers of nucleons, which is confirmed by numerical calculations. The gravitational constant, which reflects the parameters of the nucleon creating the gravitational field (mass), the parameters of another nucleon perceiving the gravitational field (mass and volume or average density), the parameters of the medium containing the gravitational field (heat conduction coefficient of the free ether), and, finally, the energy content of the process (heat flux), is given a natural physical content.

It also follows from the above that for a free nucleon the temperature drop on it (and correspondingly the pressure) of the ether decreases by $0.9 \cdot 10^{-36}$, on the Sun's surface by $2.8 \cdot 10^{-4}$, on the Earth's surface by $2.5 \cdot 10^{-7}$ fraction of the full values.

Since the total energy of the nucleon is

$$W_p = m v_{pp}^2 / 2 = 1.673 \cdot 10^{-27} (10^{21})^2 / 2 = 8.4 \cdot 10^{14} \text{ J,} \quad (10.35)$$

then the relative heating of the proton due to the heat of the surrounding ether is

$$w_p = 6.67 \cdot 10^{-10} / 8.4 \cdot 10^{14} = 0.8 \cdot 10^{-24} \text{ s}^{-1} = 2.5 \cdot 10^{-17} \text{ year}^{-1} . \quad (10.36)$$

From here it is immediately seen that for the time of existence of a nucleon of the order of 10 billion years, the proton will be heated by a negligible amount.

At further refinement of the law of gravitational attraction of masses in the first approximation we can still consider the density of free ether $\rho_0 = \text{const}$, since the change of density is a consequence of the change of pressure in the medium, and in gravitational phenomena the interacting forces are essentially small in comparison with the forces of other interactions.

Substituting the value of $gradT$ and considering that the power of the heat source - of all protons is proportional to their number and, hence, to their mass, we obtain the value of the force acting on the mass from the side of the temperature field of the aether created by another mass, [11]:

$$F = f \frac{MM_{12}}{r^2} F(r, t), \quad (10.37)$$

where the value of $F(r, t)$ is calculated by formula (5.89).

Thus, it was possible for the first time to derive the static law of gravitational attraction of masses without resorting to approximation of experimental data, as it was done by Newton. The given expression practically assumes instantaneous propagation of gravitation, which in principle corresponds to the calculations of celestial mechanics.

The obtained expression differs from the well-known Newton's law by the presence in the right part of the damped function $F(r, t)$, which includes the Gauss integral, almost unchanged at relatively small distances and sharply decreasing starting from some distance. This is quite sufficient to resolve the well-known Zeliger paradox [9], since at large distances the forces decrease much faster than the square of the distance. This means that the gravitational forces of the Sun do not extend further than the limits of the Solar System and the stars at a considerable distance from each other are not attracted to each other.

However, it can be assumed that distances of the order of tens of astronomical units lie within the range of Newton's law. Deviations from Newton's law, if they were significant, would have to be reflected in errors in determining the masses of planets distant from the Sun and in errors in determining the

parameters of Pluto, the planet farthest from the Sun, because the eccentricity of Pluto's orbit is the largest and is 0.25 (for Jupiter - 0.05; for Saturn - 0.06; for Uranus - 0.05; for Neptune - 0.05 [10]). However, it is known that it is Pluto's orbit that does not fit into Kepler's law because the Sun is not at the focus of the ellipse of its orbit. Is it by chance?

The expected consequence of the deviation of the law of gravitation of bodies from Newton's law is that the shape of the comet trajectory deviates from the ellipsoidal one: the branches of the comet trajectory: at distant parts, the orbital branches should be more dilute than they would be in the case of exact conformity of the law of gravitation to Newton's law, and the same comet should appear somewhat later than is provided by Newton's exact law. The main consequence, however, is that stars and galaxies should be attracted among themselves by forces substantially less than Newton's law would imply.

All assumptions made about the nature of gravity assume Euclidean space.

It is reasonable in this connection to recall some experimental data allegedly testifying to the non-Euclidean nature of space. These include, in particular, the anomalous motion of Mercury's perihelion and the deviation of starlight near the Sun.

As shown in [11, pp. 41-43], when analyzing the results of measurements, many facts that significantly affect their interpretation should be taken into account, which has almost never been done. Taking into account these factors, the presence of which was pointed out by many scientists, does not allow us to consider the obtained results as confirmations of non-Euclidean space.

Thus, when interpreting the displacement of Mercury's perihelion, which according to different estimates ranges from 34 to 43 angular seconds per century (!), a number of facts, each of which separately is quite sufficient to explain this phenomenon, were not taken into account, namely:

- 1) nonsphericity of the Sun, a $1/1900$ (other estimates are $5 \cdot 10^{-5}$) flattening of the Sun's level surface (or a subsurface layer of higher density not observable from Earth) is enough to fully explain the effect;
- 2) rotation of the Sun, leading to the asymmetry of the gravitational field;
- 3) non-centrality of the Sun's mass and non-uniformity of its density;
- 4) non-centrality of the Sun's rotation, since both the Sun and its planets revolve around a common center of mass;

5) presence of mass ejections in the form of prominences, etc.

When interpreting the deviation of the starlight beam near the edge of the Sun by Einstein should be 1.75", by Newton - 0.84", the difference on the photographic plate was 0.01 mm) the following circumstances were not taken into account:

- 1) distortions in the position of stars in the optical part of the apparatus;
- 2) illumination of the photographic plate by the Sun's corona, which caused distortions in the gelatin;
- 3) abnormal refraction in the Earth's atmosphere due to the cold air inside the Moon's shadow cone;
- 4) Refraction in the solar atmosphere.
- 5) presence of vortex motion in the air in the Moon's shadow cone, etc.

In addition, of all possible ways of processing the measurement results, only the one that gave the closest Einsteinian readings was chosen.

Thus, no experimental data, allegedly confirming the non-Euclidean space, in fact does not exist, the real physical space is Euclidean, which directly follows from the conclusions about the general physical invariants.

10.3. The rate of propagation speed gravitational interaction

As shown above, the essence of the gravitational influence of some bodies on other bodies is to create a pressure gradient in the ether surrounding the bodies due to cooling of the ether by these bodies. Consequently, the velocity of gravitation propagation is the velocity of small pressure propagation, i.e. the velocity of sound propagation in the ether.

As it was shown above, when determining the parameters of the ether, the sound speed of the ether in near-Earth space is equal to $4.3 \cdot 10^{23}$ m/s, i.e. more than 10^{15} times the speed of light. Taking into account the lag, the law of gravitational interaction of bodies takes the form:

$$F(t - r/c_r) = f \frac{MM_{12}}{[r(t)]^2} \quad (10.38)$$

The above expression transforms into the known form of Newton's law when $F(r, t) = 1$ and $c_r = \infty$.

The lower limit of the velocity of gravity propagation was established by P.S. Laplace in 1787, i.e., when the speed of light propagation was already well known. Having investigated the causes of the secular acceleration of the Moon, Laplace concluded that the speed of gravity propagation is at least 50 million times greater than the speed of light [6]. Taking into account that the whole experience of calculations of the position of planets in celestial mechanics is based on Newton's static formula, which implies infinity of the gravitational propagation speed, we should consider both Laplace's estimate and our estimate more correct than the estimate of Einstein's General Theory of Relativity, which *postulates* that the gravitational propagation speed is equal to the speed of light...

It should be noted that the speed of gravitation propagation in the whole world space cannot be constant, since it depends on the temperature of the ether, and, therefore, near the gravitational masses, where the temperature of the ether is lower, the speed of sound, i.e. the speed of gravitation propagation, will also be lower.

In spite of the large value, the speed of propagation of gravitation - the speed of propagation of the first sound in the ether, as well as the speed of light - the speed of propagation of the second sound in the ether, is not fundamentally limiting. Taking into account that the motion of amers takes place not in the void but in the medium of ether-2, it should be assumed that the velocity of moving of particles of ether-2 essentially exceeds the velocity of moving of amers - particles of ether-1 or simply ether. Accordingly, the velocities of movement of ether particles of deeper levels of matter organization significantly exceed the velocities of ether particles of previous levels of matter organization.

10.4. Absorption of ether by gravitational masses

The presence in the space surrounding the gravitational mass of the ether pressure gradient leads to the fact that the ether itself begins to shift under its influence towards the gravitational mass and to be absorbed by it. Since all bodies are gravitational masses, they all absorb ether from the surrounding space, as a result of which their mass increases. This increase of mass occurs relatively slowly, imperceptibly, especially against the background of other processes, but for large bodies these changes are not only

noticed, but even measured. The assumption about the expansion of the Earth due to the absorption of the ether was made as early as by Yarkovsky [12].

It should be noted that the increase in the mass of the Earth with time is a real fact, and it cannot be explained, for example, by such processes as assimilation of ray, corpuscular and meteoric fluxes.

As shown by Gusarov [13], due to these factors within 5 billion years the Earth could increase its mass by no more than $3 \cdot 10^{-7}$ part of its present-day mass.

The absorbed mass of the cosmic ether can be assimilated by the Earth in three ways:

as the formation of a new substance, the mechanism of which is currently unclear;

as an increase in the mass of each nucleon and electron shells of atoms, which is more obvious;

as an accumulation of masses of aether that then move within the Earth's rocks.

The increase in the mass of the Earth should also affect the continuous increase in the day. It has been found that the day actually increases by 0.0024 s per century. At present, this increase in the day is attributed to the inhibition of the Earth's rotation by tidal currents, but this explanation does not seem complete.

As shown in [14-17], the fact of uniform expansion of the Earth can be considered as firmly established, and the result of it was the detachment of continents from each other. The expansion of the Earth's surface is currently taking place to the sides of the oceanic rift ridges - the North and South Atlantic, West Indian, as well as the Austral-Antarctic, South and East Pacific Rises (Fig. 10.2).

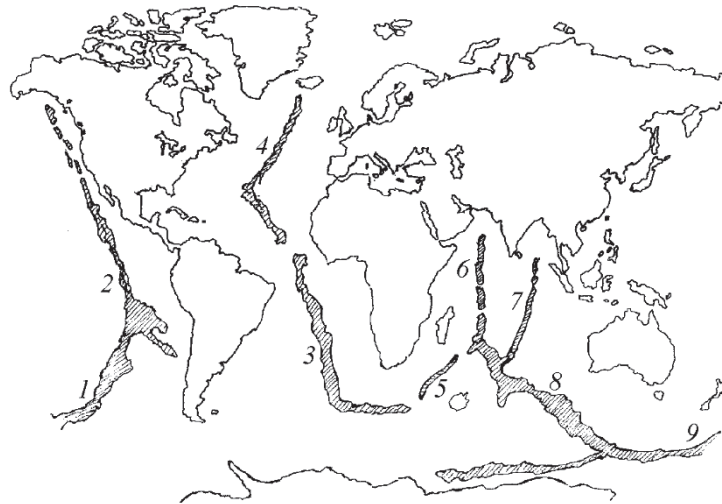

Fig. 10.2. System of oceanic rift ridges of the Earth: 1, 7 - East PACIFIC RISE; 2 - North ATLANTIC RIDGE; 3 - SOUTH ATLANTIC RIDGE; 4 - WEST INDIAN RIDGE; 5 - AUSTRAL-ANTARCTIC RISE; 6, 8 - SOUTH PACIFIC RISE.

Studies conducted by a number of scientists have shown that about 2-2.5 billion years ago, the Earth had a significantly smaller volume, the oceans were absent, and all modern continents were merged together and formed a common solid shell of the Earth - the Earth's crust. The movement of continents away from each other has also been established.

If there were no subduction, i.e., the oceanic crust creeping under the continents, then, in accordance with V.F. Blinov's calculations, we could assume that the change in the Earth's radius is currently approximately $\partial R/\partial t = 1.08$ cm/year. However, according to some studies [18, 19], there is no crust at the bottom of the oceans that is older than 200 Ma. Comparing this age with the age of the crust of the continents makes us recognize the fact of subduction. However, subduction cannot compensate for spreading - the spreading of continents completely.

Since the minimum age of the crust of the continents is estimated to be 2 billion years, it can be assumed that this is the time when the continents separated and, therefore, 2 billion years ago the Earth's surface was only 1/3 of the present surface

Earth's surface (the surface of the oceans now accounts for 2/3 of the Earth's total surface).

Assuming that the average density of the Earth remains constant (an arbitrary assumption, but not significantly affecting the final result), let us calculate the time constant of the mass change of the Earth and other planets of the Solar System.

Let us determine the velocity of the ether entering the celestial body (Fig. 10.3).

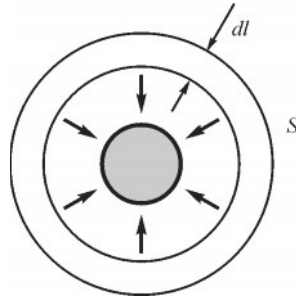

Fig. 10.3: Determination of the absorption rate of the ether by the gravitational mass

The increment of the length of the column length of the aether falling on the body from the world space can be realized only due to the difference of accelerations on the element of the length of the gas column measured in the radial with respect to the celestial body direction, i.e.

$$dl = - \frac{t^2}{2} dg. \quad (10.39)$$

Hence,

$$\Delta l = - \frac{\Delta t^2}{2} g; \Delta t = \text{const.} \quad (10.40)$$

Since

$$g = G \frac{M}{r^2}, \quad (10.41)$$

then

$$\Delta l = -\frac{GM}{2r^2} \Delta t^2. \quad (10.42)$$

The surface area of a ball of radius r is $S = 4\pi r^2$, and, hence, the volume of the gas layer with thickness Δl is equal:

$$\Delta V = S \Delta l = 4\pi r^2 \left(-\frac{GM}{2r^2} \Delta t^2 \right) = -2\pi GM \Delta t^2 = \text{const} \quad (10.43)$$

for any moment of time t . It follows that the ether falls on the celestial body without changing its volume, without undergoing any adiabatic change, i.e. as a solid body from infinity. This means that the ether enters the body with the second cosmic velocity equal to

$$v_{II} = \left(\frac{2GM}{R} \right)^{1/2}. \quad (10.44)$$

For the Earth, $v_{II} = 11.18$ km/s.

It is necessary to pay attention to the fact that for any celestial body the value of

$$\begin{aligned} \frac{S^2 v_{II}^2 \rho_T}{M^2} &= \frac{(4\pi r^2)^2 \frac{2GM}{R}}{M^2} = \frac{24\pi G}{RM^2} = \frac{3M}{4\pi r^3} \\ &= 75.4G = 5.029 \cdot 10^{-9} \text{ kg}^{-1} \cdot \text{m}^3 \cdot \text{s}^{-2} = \text{const}, \end{aligned} \quad (10.45)$$

and the specific mass gain in a celestial body is proportional to the magnitude of the

$$\frac{\Delta M}{M} = \frac{\rho_e S v_{II} \rho_e S}{M \Delta t} = \frac{24\pi G}{RM^2} \frac{1}{\rho_T} = 6.3 \cdot 10^{-16} / \sqrt{\rho_T}. \quad (10.46)$$

This means that as the average density of a celestial body ρ_T increases, the relative increase in its mass due to ether absorption decreases.

It follows from the above that the time constants of the celestial bodies are close to each other and are about 3-4 billion years. This means that within the framework of the initial assumptions - the constancy of the Earth's density and the constancy of the aether density in the near-Earth space, as well as the invariance of the gravitational constant (very conditionally) - we can assume that the Earth's mass increases by e times in 3.75 billion years.

So, the increase in mass of the Earth is

$$\begin{aligned} \frac{\Delta M_3}{\Delta t} &= 6.3 \cdot 10^{-16} M_3 / \sqrt{\rho_3} = & (10.47) \\ &= 6.3 \cdot 10^{-16} \cdot 5.975 \cdot 10^{24} / \sqrt{5.518 \cdot 10^3} = 5.07 \cdot 10^7 \text{ kg/s} = 1.6 \cdot 10^{15} \text{ kg/yr.} \end{aligned}$$

Assuming that the specific mass of the Earth (5518 kg/m^3) remains constant, we obtain

$$\begin{aligned} \frac{\Delta V_3}{\Delta t} &= 5.07 \cdot 10^7 / 5.518 \cdot 10^3 = 9.2 \cdot 10^3 \text{ m}^3 / \text{s} = 2.9 \cdot 10^{11} \text{ m}^3 / \text{year} & (10.48) \end{aligned}$$

Since the total length of rift ridges is 60 thousand km, the increment of mass and volume per unit length of a rift ridge is respectively

$$\begin{aligned} \frac{\Delta M_3}{\Delta l} &= \frac{5.07 \cdot 10^7}{6 \cdot 10^7} = 0.83 \text{ kg/m-s} = 2.7 \cdot 10^8 \text{ kg/year} & (10.49) \end{aligned}$$

$$\begin{aligned} \frac{\Delta V}{\Delta l} &= \frac{9.2 \cdot 10^3}{6 \cdot 10^7} = 1.5 \cdot 10^{-4} \text{ m}^3 / \text{s} = 4.7 \cdot 10^3 \text{ m}^3 / \text{year.} & (10.50) \end{aligned}$$

Based on the fact that the average distance from the axes of the rift ridges to the coasts of the continents is 3 thousand km, and the age of the seafloor rocks near the coasts is 200 million years (along the axes of the rift ridges the age of rocks does not exceed 10 million years, the age of rocks monotonically increases from the coasts of the rift ridges to the coasts of the continents).

of ridge axes to shores), we find the velocity of rock movement from ridge axes to shores

$$v_{\pi} = 3 \cdot 10^6 / 2 \cdot 10^8 = 1.5 \cdot 10^{-2} \text{ m/yr} = 4.75 \cdot 10^{-10} \text{ m/s.} \quad (10.51)$$

and the incremental area

$$\Delta S_{\pi} / \Delta t = 2 \cdot 6 \cdot 10^7 - 1.5 \cdot 10^{-2} = 1.8 \cdot 10^6 \text{ m}^2 / \text{year} = 1.8 \text{ km}^2 / \text{year} \quad (10.52)$$

However, Steiner [20] has shown that the average global rate of ocean area expansion over the last 5 million years is $3.19 \text{ km}^2/\text{year}$. Based on Steiner's data, we obtain that if the area of the oceans expanded only due to the expansion of the Earth's volume, the Earth would have to expand at a rate of 2 cm/year . However, the increment of the Earth's radius R_z due to the absorption of ether is only

$$\frac{\Delta R}{\Delta t} = \frac{R_3 \Delta V}{3V_3 \Delta t} = \frac{R_3 \Delta M_3}{3M_3 \Delta t} \quad (10.53)$$

$$= \frac{6.36 \cdot 10^6 - 5.07 \cdot 10^7}{3 \cdot 5,975 \cdot 10^{24}} = 1.8 \cdot 10^{-11} \text{ m/s} = 0.56 \text{ mm/yr.}$$

This discrepancy in the data can be attributed not so much to incorrect measurements as to the unevenness of the Earth's expansion process over time, such as the accumulation of stresses in rocks and then their relatively rapid release.

Thus, if the fact of continental splitting can be explained by the increase in the mass and volume of the Earth due to the absorption of the space ether, then both spreading and subduction should be attributed to a greater extent to the displacement of magmatic subcrustal rocks, which can also be a consequence of mass accumulation, and hence the build-up of stresses due to the same absorption of the space ether (Fig. 10.4, *a*) [21].

The considered mechanism of the Earth's expansion can, to some extent, shed light on the causes of mountain formation (Fig. 10.5, *b*). At the time of splitting, the continents had an inner radius corresponding to the radius of the Earth about 2 billion years ago. With the passage of time, the continents that retained this radius found themselves on the surface of the Earth of increased radius, which inevitably led to the emergence of the

stresses in the continental plates and further - to horizon formation. It can be assumed that the Pamir is composed of older rocks than the plain, so the general uplift was preserved there and more intensive horizon formation took place.

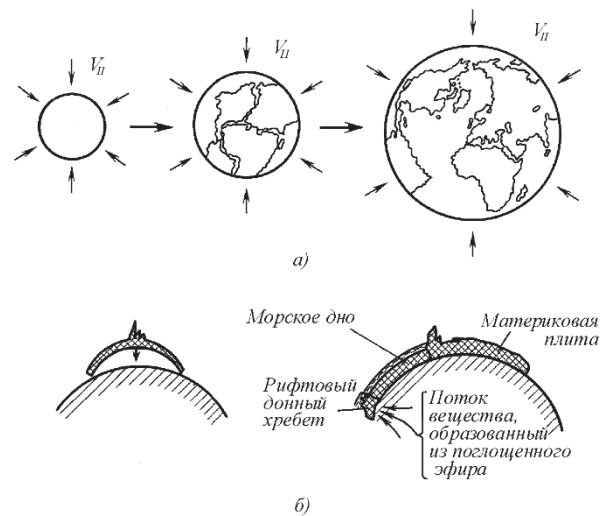

Fig. 10.4. Expansion of the Earth: *a* - ABSORPTION OF ETHER BY THE EARTH; *b* - ONE OF THE MECHANISMS OF CITY FORMATION

The outlined mechanism of mountain formation is not the only one. The Cordilleras, which stretch along the entire western coast of the Americas, were formed in a different way. Here there is not the ocean floor creeping under the continent, but its crawling on the shore. This explains the presence of the former ocean floor at elevations of several kilometers. This means that the rocks of the western slope of the Cordilleras must be younger than the rocks of the eastern slope, and the closer to the ocean, the younger the rocks must be. In principle, this is not so difficult to verify.

Absorption of ether is produced by all celestial bodies. In the table.

10.1. calculated data on the increase in the mass of celestial bodies due to their absorption of the ether of outer space are presented.

Table 10.1.

CELESTIAL BODY	WEIGHT, KG	Surface AREA m^2	V_{II} , M/S	$\Delta M/\Delta t$, KG/S	$\Delta M/M\Delta t$, c^{-1}
SUN	$1,99 \cdot 10^{30}$	$6,08 \cdot 10^{18}$	$6,18 \cdot 10^5$	$3,32 \cdot 10^{13}$	$1,67 \cdot 10^{-17}$
MERCURY	$3,24 \cdot 10^{23}$	$7,15 \cdot 10^{13}$	$4,3 \cdot 10^3$	$2,72 \cdot 10^6$	$8,4 \cdot 10^{-18}$
VENUS	$4,86 \cdot 10^{24}$	$4,8 \cdot 10^{14}$	$1,04 \cdot 10^4$	$4,45 \cdot 10^7$	$9,15 \cdot 10^{-18}$
EARTH	$5,97 \cdot 10^{24}$	$5,1 \cdot 10^{14}$	$1,12 \cdot 10^4$	$5,05 \cdot 10^7$	$8,45 \cdot 10^{-18}$
MARS	$6,39 \cdot 10^{23}$	$1,42 \cdot 10^{14}$	$5,1 \cdot 10^3$	$6,4 \cdot 10^6$	$1 \cdot 10^{-17}$
JUPITER	$1,9 \cdot 10^{27}$	$6,16 \cdot 10^{16}$	$6,08 \cdot 10^4$	$3,3 \cdot 10^{10}$	$1,75 \cdot 10^{-17}$
SATURN	$5,68 \cdot 10^{26}$	$4,19 \cdot 10^{16}$	$3,68 \cdot 10^4$	$1,36 \cdot 10^{10}$	$2,4 \cdot 10^{-17}$
URANUS	$8,73 \cdot 10^{25}$	$7,3 \cdot 10^{15}$	$2,22 \cdot 10^4$	$1,43 \cdot 10^9$	$1,65 \cdot 10^{-17}$
NEPTUNE	$1,03 \cdot 10^{26}$	$6,5 \cdot 10^{14}$	$2,48 \cdot 10^4$	$1,43 \cdot 10^9$	$1,38 \cdot 10^{-17}$
PLUTO	$5 \cdot 10^{24} ?$	$5,07 \cdot 10^{14} ?$	$3 \cdot 10^3 ?$	$1,35 \cdot 10^7 ?$	$2,7 \cdot 10^{-18} ?$

There are two more consequences of the Earth's absorption of ether: these are etheric emissions leading to the formation of comets, and the so-called geopathogenic zones - the outflow of etheric jets.

The formation of comets is carried out by all planets, as well as, probably, the formation of geopathogenic zones. But if the formation of small comets occurs relatively unnoticed, the formation of large comets is a planetary event accompanied by the ejection of large masses of matter into space. Fortunately, this happens very rarely, probably not more often than once every few million years.

As for geopathogenic zones, this phenomenon is ubiquitous. Two or three zones with a diameter of less than a meter can be found in almost every house and apartment. These zones are jets of twisted and swirled ether flowing out of the Earth's body. Such jets penetrate through multi-storey buildings and have a very negative effect on people's well-being, and sometimes lead to complete loss of health and even death. These zones are easily detected by biolocation operators with the help of wire frames

(vines). The usual recommendation in such cases is to rearrange the furniture so as not to be in these areas for a long time - remove all working and sleeping places from them, but, unfortunately, this is not always possible.

At present, a simple and effective way of destructuring such flows with the help of wire meshes has been found. The flows are destroyed, and although the source of these flows continues to exist in the Earth's body, it can no longer create an organized swirling flow.

10.5. Magnetism celestial bodies as a consequence of their absorption of ether

As is known, the Sun and some planets have their own magnetic field. A distinctive feature of the basic magnetic field of celestial bodies is the coincidence or close arrangement of magnetic poles with the poles of rotation of celestial bodies. This gave grounds for hypothesizing the existence of a fundamental law of nature, according to which every rotating body must have a magnetic moment. However, the conducted experiments did not confirm this: a rotating heavy metal ball did not change the surrounding magnetic field.

Attempts have been made to explain the Earth's main magnetic field by the presence of ferromagnetic materials in the Earth's crust, by the movement of electric charges that participate in the daily rotation of the Earth and thus create an electric current, by the presence in the Earth's core of currents caused by the thermomotive force at the boundary between the core and the mantle, and, finally, by the action of the so-called hydromagnetic dynamo in the Earth's metallic core. The latter hypothesis, which is now considered the most satisfactory, assumes self-excitation of the Earth's generator moving in the magnetic field it generates for itself. In the latter case, the authors apparently assume that excitation is possible in a field that itself moves with the body, but this is contrary to logic.

It seems possible on the basis of ether-dynamic representations to return to the first hypothesis that rotating bodies should possess a magnetic moment, however, not all, but only dielectrics.

As shown above, all bodies continuously absorb aether from the surrounding space and the aether falls on the surface of the body with the second cosmic velocity. If the body is not metallic, the flows

of ether penetrate the body, if the body is metallic, its penetration and advancement in the body is very slight, and the effect, if any, is insignificant.

At each point of the rotating body, the absorbed aether flow will be additionally affected by the force caused by the Coriolis acceleration (Fig. 10.5). This acceleration can be calculated by the formula

$$a_{\text{Kop}} = 2\omega v \sin \alpha. \quad (10.54)$$

Here ω is the angular velocity of rotation of the celestial body; v is the velocity of the aether flow; α is the angle between the flow direction and the angular velocity vector. The velocity v here is equal to the second cosmic velocity.

At constant density, the mass of the body

$$M = \rho V_{\text{T}} = \frac{4}{3} \rho_{\text{T}} \pi R^3, \quad (10.55)$$

where ρ_{T} is the average specific density of the body; V_{T} is the volume of the body, R is its radius. Hence,

$$v_{\text{II}} = r \sqrt{\frac{8}{3}} \pi \rho_{\text{T}}, \quad (10.56)$$

i.e. the velocity of the ether flow decreases as it penetrates deeper into the celestial body.

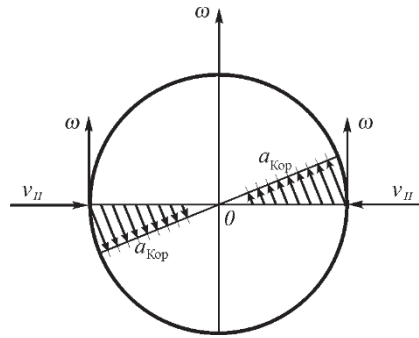

Fig. 10.5: Occurrence of a vortex field of ether in a rotating celestial body

It follows from the above that in the surface layer of the celestial body the vortex field of ether will be excited. If, moreover, there is an iron core in the center of the body, as it is supposed, for example, in the Earth, then the vortex field of the ether will be closed through it, since this core itself will not create a counteracting vortex flow, but, on the contrary, will contribute to the penetration of the vortex field of the ether. However, if there is no such nucleus, given the weakening of the field in the center of the celestial body, this central field will also be unable to counteract the general flow, which should still result in the vortex field closing through the center of the celestial body. As a result, the planet acquires an aether vortex field - a magnetic field (Fig. 10.6).

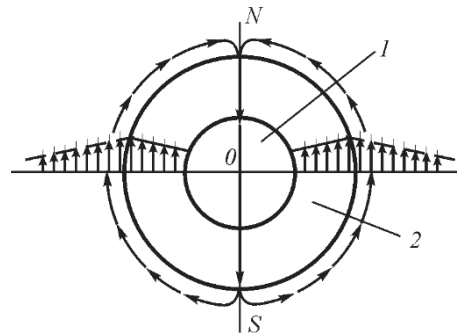

Fig. 10.6. Formation of the Earth's magnetic field. IRON CORE 1 DOES NOT CREATE MDS DIRECTLY, BUT IS A CONDUCTOR AND AMPLIFIER OF THE MAGNETIC FIELD CREATED IN THE SURFACE LAYER 2

Table 10.2 shows the calculated parameters of the magnetic field of celestial bodies in relative units, assuming that the magnetic field strength is proportional to the Coriolis acceleration on the surface of the bodies, with the magnetic field strength on the surface of the Sun taken as a unit:

$$H_r = H_C \frac{(\omega v_{II})_r}{(\omega v)_{IIc}} \quad (10.57)$$

As can be seen from the table, for those celestial bodies for which the magnetic field strength at the surface is known, the coincidence of the calculated values with the reference values is quite satisfactory. For those celestial bodies for which the magnetic field strength at the

of the surface are not known, only calculated values of the expected value of the tension are given.

Table 10.2.

CELESTIAL BODY	T	Ω, s^{-1}	ωv_{II} , m/s	$\frac{(\omega v)_{IIr}}{(\omega v_{II})s}$	$\frac{H_r}{H_c}$ (SP?)
SUN	25.38 DAYS	$2,85 \cdot 10^{-6}$	1,76	1	1
MERCURY	58.65 DAYS	$1,25 \cdot 10^{-6}$	$5,4 \cdot 10^{-3}$	$3,1 \cdot 10^{-3}$	0
VENUS	243 DAYS	$3 \cdot 10^{-7}$	$3,1 \cdot 10^{-3}$	$1,75 \cdot 10^{-3}$	0
EARTH	23 H 56 MIN 4 s	$7,27 \cdot 10^{-5}$	0,812	0,462	0,42-0,7
MARS	24 H 37 MIN 23 s	$7,2 \cdot 10^{-5}$	0,36	0,205	-
JUPITER	9 H 55 MIN 40 s	$1,74 \cdot 10^{-4}$	0,9	5,6	4
SATURN	10H 40 MIN.	$1,62 \cdot 10^{-4}$	6	3,3	-
URANUS	10,8 ч	$1,68 \cdot 10^{-4}$	3,52	2	-
NEPTUNE	15,8 ч	$1,1 \cdot 10^{-4}$	2,52	1,43	-
PLUTO	6,39 ч	$2,74 \cdot 10^{-4}$	1,37	0,78	-

It is reasonable to pay attention to the fact that the absorption of ether by the Earth can be perceived as a vertical component of the magnetic field.

Conclusions

1. Gravitational interactions can be interpreted as a result of the thermodiffusion process in the ether, based on the heat exchange of the mass of matter with the surrounding ether at the level of the ether energy. The solution of the heat conduction equation with respect to this case allowed us to derive a refined expression for the law of mutual attraction of masses and to determine the physical meaning of the gravitational constant. The restriction on the distance of gravitational interaction of bodies is shown that

allowed to solve naturally the known Neumann-Zeliger paradox within the framework of representations about Euclidean space.

2. The propagation speed of gravitational perturbation - the speed of sound propagation (small pressure increment) in the ether is $4.3 \cdot 10^{23}$ m/s. This corresponds to the calculations of Laplace, who showed that the propagation speed of gravity is at least 50 million times greater than the speed of light. The calculations are confirmed by the experience of celestial mechanics, operating exclusively with static formulas, in the derivation of which the assumption of infinitely large velocity of gravitation propagation is made.

3. Under the influence of the pressure gradient in the ether caused by the temperature gradient, the ether itself is continuously shifted towards gravitational masses and absorbed by them, due to which there is a continuous growth of the masses of these bodies. The velocity of the ether entering the bodies is equal to the second cosmic velocity. The time constant of mass build-up due to the absorption of ether is currently 3-4 billion years.

4. It follows from the calculation of the expansion of the Earth's surface due to the absorption of ether that the spreading - sliding of the continents and subduction - crawling of the oceanic crust under the continental plates on the Earth are caused not only by the expansion of the Earth, but also by the internal movements of magma, which, in turn, can be stimulated by the stresses arising in it when absorbing the ether of the world space.

5. The increasing mass of matter comes to the surface of the Earth in the form of rift ridges, the total length of which across the globe is 60 thousand kilometers.

6. The developed model of the origin of the magnetic field in rotating celestial bodies has shown the possibility of interpreting the causes of its appearance as a consequence of their absorption of ether and their own rotation. The arising Coriolis forces excite vortex motions of the ether, which may be the reason for the appearance of the magnetic field in rotating celestial bodies. The obtained calculated data on the magnetic field strength of celestial bodies gave a satisfactory coincidence with reference data.

Chapter 11: Aether and Cosmology

...The inquiry into the structure of the world is one of the greatest and noblest problems that exist in nature

Galileo Galilei [1]

11.1. Modern cosmology and cosmogony

Cosmology is the doctrine of the Universe as a whole and of the entire astronomically observed area of the Universe as part of the whole [2-10]. The conclusions of cosmology are based on the laws of physics and data of observational astronomy, as well as on the philosophical principles of their epoch. Cosmological theories of different epochs differ significantly depending on which physical principles and laws are accepted as universal. The conclusions from these theories must be confirmed, or at least not contradicted by observations, as well as predict new phenomena. It is believed that this requirement is best satisfied by the homogeneous isotropic models of a nonstationary hot Universe developed on the basis of Einstein's general theory of relativity.

The emergence of modern cosmology is associated with the creation of the relativistic theory of gravitation by A. Einstein in 1913-1917. [11]. At the first stage of relativistic cosmology development the main attention was paid to the geometry of the Universe - space-time curvature and space closure. At the second stage it was shown by A. Friedman [12] that curved space cannot be stationary, that it must expand or contract, which was recognized as true after the discovery in 1929 by E. Hubble of the "Red Shift" of the spectra of distant galaxies [13]. The third stage begins with the models of the "hot" Universe (2nd half of the 40s, G.Gamow) [2,3]. The main attention is now shifted to the physics of the Universe - the state of matter and physical processes going on at different stages of the Universe expansion, including the earliest stages, when the state was unusual.

The theory of a homogeneous isotropic Universe is based on two postulates: 1) the best known description of the gravitational field is Einstein's equations, from which the curvature of spacetime and the relationship between curvature and mass (energy) density follow; 2) in the Universe all points and all directions are equal. However, there is also a third postulate of the "hot" Universe, according to which

at very small values of the time interval from the "beginning" of the Universe not only molecules and atoms, but also atomic nuclei could not exist, there was only a mixture of different elementary particles. Thus at $t = 0$ the density of the Universe was infinitely great and all of it was concentrated in a dimensionless "singular" point of space, and 0.01 second after the "Big Bang" the density fell to 10^{11} g/cm³. The open universe and closed universe models are discussed. In the first model the expansion of the Universe can occur indefinitely, in the second model the expansion can be replaced by contraction. Modern cosmology says nothing about the causes of the Big Bang, nor about what happened before the Big Bang.

Modern *cosmogony* [14-19] considers various models of the origin and evolution of planets, stars, and galaxies. Here various hypotheses are put forward, the main ones being the concepts of the concentration of initially diffuse gas and dust, about the origin of which nothing is said, and also the concept of the decay of the gas and dust located in some regions of space of "superdense" matter, which serves as material for the formation of galaxies and stars, nothing is said about the origin of this matter either. For example, there are several hypotheses about the causes of gas emission by galaxy nuclei (see, for example, [15]). Their essence is basically reduced to the fact that galaxy nuclei contain a large number of stars or a large mass, the decay of which leads to the outflow of gas and radiation. There is also an assumption that there is a so-called black hole in the center of the nucleus, but this assumption does not fit in any way with the fact of outflow of gas and can at best justify the presence of electromagnetic radiation. The above hypotheses seem to be very artificial, since they imply some irreversible processes. Besides, the presence of superdense formations, clusters of stars or black holes in the nuclei of galaxies, in turn, requires an explanation of the reasons for their presence or appearance in these nuclei.

In modern cosmology, several typical explanations of observed phenomena are accepted. These include:

- "Redshift" spectra of distant galaxies, which is explained only as the result of the Doppler effect of galaxy expansion and the expansion of the universe; other possible explanations are ignored;
- explosions of galaxies or their nuclei as a reason for the appearance of broad bright bands of spectra;

- braking in the magnetic field of electrons as a cause of non-thermal radiation, as well as some others.

The main experimental confirmation of the alleged fact of the expansion of the Universe is the "Red Shift" spectra of distant galaxies. However, this overlooks the fact that each particular fact can be explained in countless ways, and the "Red Shift", broad radio emission spectra and non-thermal radiation are no exception. This means that all these phenomena do not confirm the theory, but only do not contradict it.

Modern cosmology is the result of free postulation and unjustified mathematical speculations, it contradicts the basic provisions of dialectical materialism and can in no way be recognized as scientific. In fact, modern cosmogony has also adopted the postulative method, and, although some of its provisions deserve attention, especially where it concerns experimental data, in general its condition cannot be recognized as satisfactory.

The main shortcomings of both cosmology and cosmogony are neglect of the provisions of dialectical materialism, postulative method and refusal to consider the internal mechanisms of phenomena at the pre-material level.

11.2. The circulation of ether in the Universe

The etherodynamic approach to cosmology and cosmogony is fundamentally different from the above.

As follows from the analysis of the properties of universal physical invariants, our space is Euclidean, time is linear, matter, space, time and their aggregate - motion exist eternally, have never been created by anyone, are infinitely fractional and infinitely great. Concrete material entities can transform from one form to another, as can motion. Any material structure has boundaries, but in general the boundaries of one structure mean the transition to other material structures without any break in space, and any concrete process has a beginning and an end, but the end of some processes means the immediate, without any break in time beginning of other processes. On the average, the whole Universe has had, has and will have the same form at all times,

and there never was and never will be any "beginnings", "Big Bangs" or "expansion of the universe".

Since the Universe exists eternally, there can be no "Heat Death" in it, and if entropy can grow in some specific processes, then, therefore, there must exist in the Universe other processes in which entropy decreases. Such a process has been found - it is the process of transformation of free ether into toroidal helical vortices of compacted ether - into protons, which occurs in the nuclei of galaxies and in new centers of vortex formation caused by collisions of ether jets.

As is known, the main accumulations of masses of matter in the Universe are concentrated in galaxies in the form of stars and interstellar medium. Many galaxies have nuclei, which are located in their centers. The nuclei of galaxies, as it follows from experimental studies, are sources of matter in the form of protons, hydrogen atoms, and all kinds of radiation [19, 20]. From the point of view of ether dynamics, galaxy nuclei are centers of vortex formation, and the formed ether vortices represent the matter emitted by galaxy nuclei. In this case, the gas (ether) pressure energy, i.e., the energy of thermal motion of molecules (for ether - amers) is transformed into the kinetic energy of ordered motion - rotation of the compacted gas (ether) vortex as a whole material entity [21-27].

Any gas vortex formation cannot exist forever, because its internal energy is consumed by viscous friction, as a result of which vortices lose energy and eventually lose stability and diffuse. An example of vortex diffusion is the behavior of smoke rings in the last stage of their existence. Consequently, the matter represented by the aether vortices must eventually cease to exist as matter, and its building material, the aether, must return to a free state. The matter formed in galaxy nuclei, as part of stars, goes to its periphery, where it decays and dissolves in the ether, and the freed ether returns back to the galaxy nucleus. Galaxies exchange ether masses among themselves, and the birth of new galaxies is inevitably accompanied by the disintegration of others, and this circulation of ether is eternal.

Thus, in ether-dynamics both the mechanism of ether circulation and the mechanism of entropy constancy are found.

It is around the nuclei that the bulk of young stars are concentrated, so it is logical to assume that stars are formed from the very gas that forms in the nuclei of galaxies.

In addition to the fact that at the moment of formation of vortices they are given some velocity due to the velocity of the collided ether flows, protons acquire some additional velocity due to their own self-deceleration in the ether. It should be noted that since the ratio of densities of the proton and free ether is rather large (several tens of orders of magnitude), the time constant of self-deceleration of protons is also rather large, probably billions of years. Nevertheless, it is enough for a part of protons and hydrogen atoms to accelerate to near-light speeds and form the main part of cosmic radiation. At the moment of formation, protons already have some chaotic velocity of only tens of kilometers per second. As a result of collisions of protons with each other, the proton gas tends to expand, due to which it begins to flow out of the galactic nucleus.

As it was shown above, vortex formations have a lower temperature relative to the medium, as a result of which the heat exchange between them and the free ether begins. This results in two consequences: the presence of temperature gradient in the ether surrounding vortices leads to the appearance of pressure gradient in it, which causes gravitation phenomena, and, moreover, the ether surrounding vortices shifts to them and is absorbed by vortices. The last circumstance should lead to the fact that vortices of ether - protons and hydrogen atoms

- must continuously increase their mass due to absorption of the surrounding ether. Such absorption continues all the time until the vortices lose their stability and the ether, forming them, diffuses back into free space.

The emergence of gravity should lead to the attraction of matter particles to each other, which ensures the collection of matter into stars. The formation of a star must have an avalanche character, because as the mass of the star increases, the force of attraction of new atoms increases.

Due to the viscosity of the aether, nucleons - compacted vortices of the aether - gradually lose their energy. The loss of energy by vortices leads to an increase in their diameters. In addition, the sizes of vortices increase due to absorption of ethers of the surrounding space, decrease of rotation speed due to conservation of momentum, thereby eroding the boundary layer, because of this - increase of the

viscosity and increasing energy losses. Consequently, the process of energy loss and increase of nucleon sizes will intensify with time.

If in hot stars the processes of radiation and absorption of the surrounding ether can be balanced for some time, then cold stars and planets radiating into space a relatively small fraction of their mass should increase their mass with time due to the increase of mass by protons. Since the momentum of quantity of motion in protons remains constant, the increase of their mass will lead to an increase in the size of protons and to a slowing down of the speed of motion of the jets of ether forming protons, and further to a decrease in the stability of protons.

Loss of energy by vortex formations, such as protons, cannot occur indefinitely long. The example of smoke rings shows that starting from some moment the vortex loses stability, stops and diffuses. From this moment the vortex formation ceases to exist, and the matter forming it returns to the initial state - to a gas unbound by the general ordered motion. The same happens with protons and neutrons in matter. Starting from some moment, they will decay, and the ether forming matter will return to the initial state of free gas.

As a result of decay of ether vortices - protons and neutrons - the density of ether in the region of matter decay must increase, because the vortex itself was essentially denser than the surrounding ether. Now this matter passes directly into the medium, hence, there will be a general increase in the density of ether in the region of matter decay.

The disintegration of matter also causes a local temperature rise, because all the energy of the ordered motion of the ether is transferred to the energy of the chaotic motion. The consequence of these two circumstances caused by the disintegration of matter is a local increase of pressure in the ether.

Thus, in two regions of the Galaxy separated in space - the core and the peripheral region - there is a pressure difference: in the core there is a lower pressure relative to the free medium, because the formation of vortices is accompanied by their compaction; in the periphery there is an increased pressure associated with the disintegration of the same vortices, i.e. with the disintegration of matter. This pressure difference creates a flow of ether from the periphery to the center. This flow is observed in the form of a magnetic field

of the spiral arms of the Galaxy, nature's only open magnetic field.

Most likely, the size of galaxies is determined by the time of the stable state of matter in the aether and the rate of displacement of stars from the center to the periphery. It has already been pointed out that at vortex formation there is a process of transformation of the potential energy of ether pressure into kinetic energy of vortex rotation. At the periphery, the reverse process of transformation of the kinetic energy of rotation of the decaying vortices into the potential energy of the aether pressure takes place.

The entropy of macrogas - nucleons and atoms forming stars, as well as of all other matter - continuously increases, but then the matter itself disintegrates; the entropy of the ether flowing from the periphery to the nucleus also increases, but in the nucleus in the process of matter formation there is a transformation of the pressure energy of the surrounding ether into the energy of the forward motion of the ether jets forming the matter. In general, in stable galaxies, in particular in spiral galaxies, entropy is kept at a constant level, and therefore spiral galaxies, in principle, can exist forever, and the number of such galaxies as stable systems makes up most of the galactic population of the Universe.

If for some reasons a new center of vortex formation appears in the vicinity of a spiral galaxy, it will start to suck the ether of the environment, the pressure in the ether will start to fall and the ether, which previously constituted the substance of the stable galaxy, will be directed not to the nucleus of the galaxy, but to a new center of vortex formation, around which a new galaxy will start to form, and the old galaxy, having used up its ether, will perish.

All observable star clusters and galaxies, as it is now found out, are gathered in groups having a common toroidal shape, but the shapes of these toroids are different - from almost globular to bagel-shaped. In them the majority of galaxies are gathered in the central part, which is easily explained: it is in the central part that the aether velocities and gradients are maximal, hence the aether pressures are the lowest, and galaxies will be sucked in the bulk of their mass here. Such toroids themselves are collected in the older toroids, and the whole visible Universe is also a toroid, beyond which nothing is visible....

K.E. Tsiolkovsky wrote about the possibility of such an arrangement of the Universe in his article "Ether Island" [28], and he was mistaken only in his mistake [28], and he was mistaken only in

that I thought the shape of this island was spherical; it turned out to be toroidal.

Does that mean that the entire universe is contained within this toroidal "island"? Absolutely not. The unobservability of what is done outside this "island" means only a limitation of our means, based on the study of optical and radio emissions. Photons and radio waves simply do not reach the Earth observer, partly decaying on the way to the free ether, and partly forming relic radiation, which will also decay in time. And besides, it is possible that the pressure of free ether between "ether islands" is so small that no vortex formation - neither material, nor photon, nor any other - can pass through it. But the Universe is infinite in time and limitless in space.

It is of interest to estimate the value of the hidden mass of galaxies.

As is well known, a number of researchers have discovered a discrepancy between the apparent mass of galaxies and their total mass calculated on the basis of calculating the motion of galaxies and analyzing the components of this motion. In spite of the fact that the methodology of such estimation is based on a certain physical model, which itself can be significantly corrected, it is nevertheless of interest to estimate the hidden mass from the standpoint of ether dynamics.

As is known, in the vicinity of the Solar System the distance between stars is on average about four light years, or $4 \cdot 10^{16}$ m. Thus, a cube of space with a side of $4 \cdot 10^{16}$ m contains one star like our Sun. In the neighborhood of the Sun, the specific mass of the ether is approximately the same and is $8.85 \cdot 10^{-12}$ kg-m⁻³, the mass of the ether in this cube is

$$M_e = \rho_e V_e = 8.85 \cdot 10^{-12} \cdot 4^3 \cdot 10^{48} = 5.7 \cdot 10^{38} \text{ kg.} \quad (11.1)$$

Considering that the Sun is a typical star and its mass is $1.99 \cdot 10^{30}$ kg, we obtain that the mass enclosed in the aether exceeds the mass of matter enclosed in stars in the

$$M_e / M_{zv} = 3 \cdot 10^8 = 300 \text{ million times!} \quad (11.2)$$

Near the galactic nucleus, the obtained ratio can be preserved, since in that region at higher density of stars the density of the ether is also higher. Thus, the hidden mass is hundreds of millions of times greater than the mass of matter. This relationship for

of the visible part of the Universe increases by another 1-2 orders of magnitude due to the ether of the intergalactic regions.

Thus, in the Universe there is a circulation of ether, and the Universe has always had, has and will have the same form as at present. The stated mechanism of the circulation of the ether completely fits into the concepts directly derived from the universal physical invariants and corresponds to the provisions of dialectical materialism. In the Universe there is a circulation of ether, and it is as eternal as matter itself is eternal and its motion in space and time is eternal.

11.3. The structure of a spiral galaxy

There is reason to believe that among all types of galaxies, the most stable star formations are galaxies of spiral structure, including our Galaxy. All other types of galaxies are transitional forms that are not dynamically stable. Therefore, it is reasonable to consider the structure of a spiral galaxy on the example of our Galaxy.

The data of long-term observations and their statistical processing allowed us to understand the formal structure of our Galaxy (Milky Way) [29]. At present, the main information about it is summarized as follows.

All components of the Galaxy are connected in a single dynamic system, rotating, as astronomers believe, around a small axis of symmetry. To an Earth observer, it appears as the Milky Way and all the many individual stars visible in the sky. The galaxy consists of many stars of various types, as well as star clusters and associations, gas and dust nebulae, and individual atoms and particles scattered in interstellar space.

There are about 10^{11} stars within the Galaxy, most of them occupying a lens-shaped volume with a cross-section of about 100 thousand and a thickness of about 12 thousand light-years (1 light-year = $9.463 \cdot 10^{12}$ km), i.e., 10^{21} m and 10^{20} m, respectively. The smaller part fills an almost spherical volume with a radius of about 50 light-years ($5 \cdot 10^{20}$ m). The surface of the globular cluster is old yellow stars.

Much of the young stars are concentrated around a small central region called the galactic nucleus; the density of stars here is the highest compared to other regions of the Galaxy.

Proton-hydrogen gas is emitted from the nucleus, the mass of which is approximately 1-1.5 solar masses per year, i.e., $(2-3) \cdot 10^{30}$ kg. The velocity of the gas emitted by the nucleus of our Galaxy in the radial direction is about 50 km/s, this velocity drops to 7 km/s in the vicinity of the Sun [19]. Two spirals emerge from the nucleus, in which stars are arranged as in the walls of tubes; farther from the nucleus there are more old stars, closer to the nucleus - more young stars, but in the spirals there are inclusions, in which there are also small clusters of young stars.

Spirals have a weak magnetic field that starts from the nucleus and ends at the periphery of the Galaxy without closing. This magnetic field was discovered in 1949 by Hall and Hiltner on the basis of observations of light polarization [19]. The magnetic field strength of the spiral arms of the Galaxy is 10-25 μ Gs [6, 7, 30]. The paper [7] points to the connection of star formation with the magnetic field of the Galaxy. There are various hypotheses about the origin of the magnetic field of the spiral arms, in particular, there are suggestions that the magnetic field is a consequence of the turbulization of interstellar gas.

The spirals are in a common plane, and in the same plane is a dark band of gas and dust on the outside of the spirals.

In view of the above, the following mechanism of ether exchange within the Galaxy is presented, which ensured the creation of the existing structure (Fig. 11.1).

The jets of aether moving along the spiral arms of the Galaxy from the periphery to the core, rushing in at high speeds of the order of tens of thousands of kilometers per second and mixing chaotically, form numerous toroidal helical vortices, which, as they compress, simultaneously fission and eventually form proton gas [23- 27].

Each proton forms around itself an attached vortex of ether - an electron shell, which is facilitated by collisions of protons with each other. As a result, a proton-hydrogen gas is formed, which, expanding, moves away from the galactic nucleus.

Proton-hydrogen gas, concentrated due to gravitational forces, gathers into clouds, which, compressing, form stars. Stars have a radial component of velocity, because the gas that formed them, such a speed has already had, and are moving away from the nucleus at the same speed as the gas, i.e., at a speed of about 50 km / sec. Some of these stars fall into the spiral arms, and some do not fall into them.

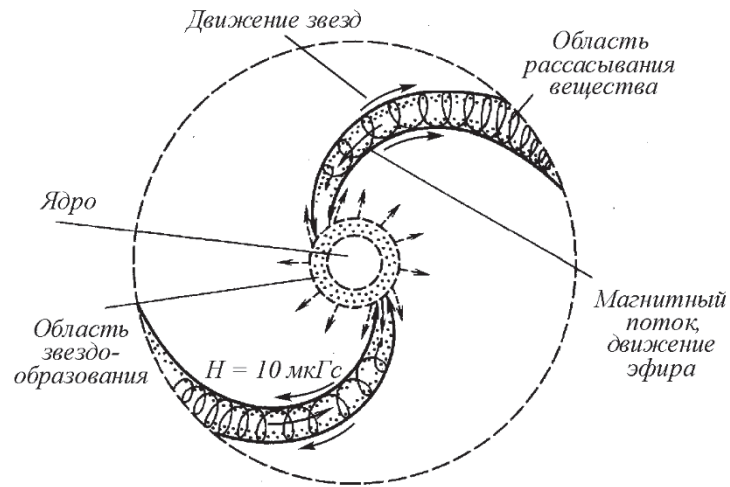

a)

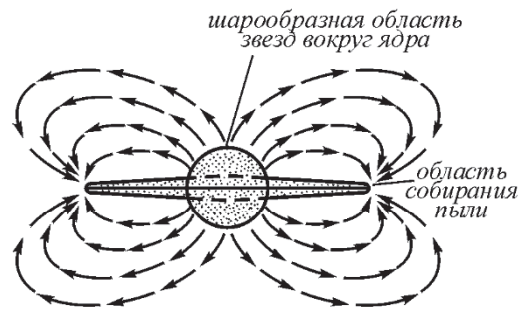

б)

Fig. 11.1. Ether-dynamic structure of a spiral galaxy: *a* - plane view; *b* - side view.

Those stars, which have fallen into the spiral arm, move towards the aether stream flowing into the nucleus from the periphery of the Galaxy. The formed, but not yet fully formed star experiences resistance to its motion, to overcome which it spends part of its kinetic energy, and, in addition, within the stream the velocities of the ether are not equal, and the star begins to be twisted by this stream. Due to the fact that the star continues to be compressed by gravitational forces, the accumulated momentum makes it self-twist, which leads to accelerated rotation. As a result, its surface becomes unstable and one or more tidal waves appear on it, breaking away from it. The mass of the detached matter already has internal rotation, and planets begin to form from it, whose orbits lie in the plane of the star's equator. In this case everywhere there will be a direct rotation, i.e. the rotation of orbits and formed planets will occur in the plane of the equator of the star and have the same direction of rotation as the star itself. All stars close to each other rotate in the same direction, stars on opposite sides of the spiral should rotate in opposite directions.

The ether flow moving along the spiral arm of the Galaxy forms a tube-like structure rotating around the spiral axis. When approaching the galactic nucleus, the Aether flow narrows, increases its speed and changes its direction from tangential to axial. In the outer region of the tube a boundary layer is formed, which does not allow the ether to leave the tube body, and the centrifugal force drives the ether out to the tube walls. Therefore, in the walls of the spiral arms the density of the aether is higher than outside or inside the spiral arms. It is in the walls that the velocity gradient of the aether is higher, so a star that touches even the edge of the wall will then be sucked into the wall of the tube. This explains the fact that the stars in the spiral arms are in their walls. To an external observer the twisted flow of ether in spiral arms should appear as a magnetic field.

The calculation shows that the axial displacement of the aether is only 10^{-5} - 10^{-6} m/s in the Solar System neighborhood. This means that for one revolution around the axis of the spiral arm the aether will be displaced to the nucleus by 10^6 - 10^5 km. In the region of the core, the spiral arms significantly reduce the cross-sectional area, which causes a significant (by several orders of magnitude) increase in the ether flow in the axial direction.

Thus, within the spiral arm, the aether flow moves in a spiral with variable pitch (Fig. 11.2, *a*), which resembles the pattern of water flow in a bathtub (Fig. 11.2, *b*).



Fig. 11.2. Spiral motion with variable pitch: *a* - aether motion in the spiral arm of the Galaxy; *b* - water motion when flowing into the hole

As in every gas jet, a boundary layer is formed along the surface of the flow, in which there is a velocity gradient (Fig. 11.3, *a*). A star formed in the central region will be drawn into this boundary layer because the pressure of the aether on the gradient flow side will be less. Any star in the boundary layer will be under the influence of the aether flow having a velocity gradient, which will force it to start a rotational motion, the axis of which is directed perpendicular to the velocity and gradient directions (Fig. 11.3, *b*).

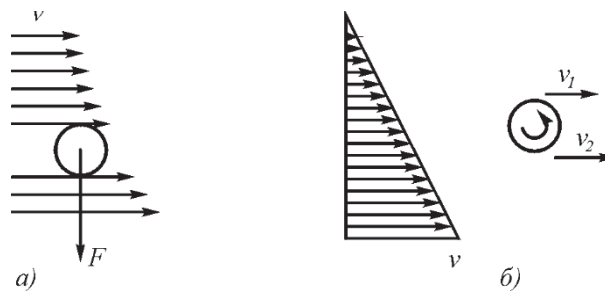

Fig. 11.3. Body in the gradient flow of ether: *a* - moving the body to the region of the largest velocity gradient of the gas jet; *b* - creating rotational motion of the body in the gradient gas jet

Photographs of spiral galaxies show that near the nucleus, the cross-sectional area of spirals shrinks by at least one order of magnitude. The thickness of the ether flow will be reduced by another order of magnitude. Taking into account the change in the direction of the ether wind near the nucleus, it should be assumed that the velocity of the ether wind in the nucleus itself will be at least 1 thousand km/s, and the density of the ether will increase by at least one order of magnitude and will be 10^{-10} kg/m³.

By the time the star, moving by inertia, will be at the edge of the Galaxy, the nucleons that form the substance of the star and its planets will lose much of their energy and decay, returning the ether that forms them to a free state.

Dissolution of a substance in the ether can occur calmly, or it can be explosive. The latter is due to the fact that the proton, which has lost energy, increases in size, and its inner hole increases accordingly. The state of the atom becomes unstable, at small perturbation the ether flow of the attached vortex can change the direction of closure and again, as it was at the first stage of proton creation, close through its center. The process here should also have an avalanche character. Then quickly enough the whole star will be composed of ionized gas, which is not held by anything. The star explodes, which could be the cause of the explosion of the so-called of "supernovae" (or, more precisely, super old) stars. However, the gradual dissolution of matter is apparently more frequent than the avalanche ionization of the entire substance of the star. At this point, the existence of stars trapped in the spiral arms of galaxies ceases.

The stars that are not in the spiral arms of the galaxy are more or less uniformly distributed in the solid angle and move at a radius from the nucleus, forming a globular cluster around the nucleus. They experience no counter-flow resistance on their way, they do not rotate and consequently cannot have planetary systems. Since at an early stage they were not washed by the etheric flow, their nucleons had no additional velocity gradient, so their stability is lower than that of protons trapped in the spiral arms. The lifetime of the nucleons of globular cluster stars must be shorter than that of stars in the spiral arms of galaxies. These stars age simultaneously and then dissolve at the periphery of the globular cluster. Therefore, all stars on the surface of the globular cluster are old.

Dissolution in the aether of the substance of the stars of the globular cluster creates on the surface of the globular cluster an excess pressure of the aether. At the same time

time in the galaxy plane, the spiral arms create a low pressure of the ether, so all the excess ether from the surface of the globular cluster rushes to the side surfaces of the spiral arms and further takes part in the general flow. The streams of ether coming from the globular cluster to the spiral arms of the galaxy capture in their motion the gas and dust of outer space and concentrate this mass in the plane of the galaxy, since it is here that the regions with minimum pressure and maximum gradients of ether velocities appear. This is probably the origin of the dark band along the arms of spiral galaxies.

In the Galaxy there is a coordinated motion of all its components - matter in the form of gas and stars formed by it, on the one hand, and ether flows, on the other. This motion is stable and can last for any length of time, until the collision of comets in it or in a neighboring galaxy will not lead to the creation of a new area of vortex formation, which at large enough sizes and large initial energy will not be stable, then this area will be the beginning of the birth of a new galaxy and possibly lead to the death of the existing one.

Thus, in our Galaxy, which is a typical galaxy of spiral structure, there is a circulation of ether: from the core of the Galaxy to the periphery - as a part of stars and interstellar gas, from the periphery to the core - as a flow of free ether, the very same one

"the "ether drift" about which so many battles have been fought.

It is necessary to pay attention to the fact that in the spiral galaxy there is a stable circulation of ether, which can last indefinitely long - hundreds and thousands of billions of years, and could last forever, if there were no other processes in the Universe, which will be discussed below.

The Solar System has existed for about 5.5 billion years [31, 52, 54, 55], and the distance at which the Solar System is separated from the galactic nucleus is about $2/3$ of the galactic radius, it is easy to calculate that at a uniform velocity of motion the total stability time of matter is 8-10 billion years.

If we take into account that the Galaxy includes about $8 \cdot 10^{10}$ stars with an average mass equal to that of the Sun [31], then the stability time of matter can be determined as 50 billion years. Such a difference in the stability time of matter can be explained by the non-uniform motion of stars from the core to the periphery, the slowing down of the velocity of stars from the core to the periphery.

of this motion, which can be seen already in the example of the gas emitted from the galactic nucleus.

The question arises, does our Galaxy rotate like other spiral galaxies?

As is known, researchers have so far judged the rotation of galaxies by the motion of stars around the center. However, if we judge by the movement of ether jets inside the spiral arms, the conclusion should be different: the Galaxy rotates, but in the opposite direction to the motion of stars. The correct conclusion is this: the arms of the Galaxy in space basically keep their position unchanged, the stars in them move from the core to the periphery, and the ether streams in the spiral arms move in the opposite direction. The same happens in all other spiral galaxies.

11.4. Ether-dynamic functional classification of galaxies and extragalactic astronomy

To date, the main types of galaxies and star formations in the observable Universe have been identified [29-51].

The morphological classification of galaxies, which was proposed in 1922 by the American astronomer E. Hubble, is formal in nature, since galaxies are classified by their external shape (spiral, elliptical, irregular, i.e., not regular, etc.). The second classification of Hubble differs from the first one by some additions, but not in substance [13]. Subsequent authors Van den Berg, Vaucouleur, Shepley, and others refined Hubble's classification, paying attention to certain details, but their classification was based on formal rather than substantive principles (Fig. 11.4).

According to these classifications, all types of galaxies are divided into the following:

1) *spiral* galaxies characterized by two relatively bright branches arranged spirally around the nucleus. The branches emerge either from the bright nucleus (such galaxies are denoted S) or from the ends of a bright junction crossing the nucleus (denoted SB);

2) *elliptical* galaxies (E), which are ellipsoid-shaped;

3) *Irregular (irregular)* galaxies (I), which have an irregular shape.

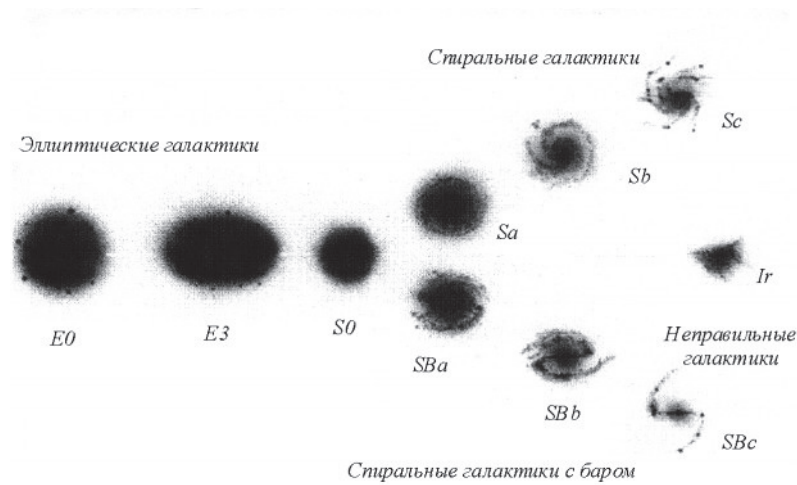

Figure 11.4: Hubble morphological classification of galaxies: the different types of galaxies are arranged on the diagram in such a way that their relative content of gas and young stars decreases from left to right.

Spiral galaxies are divided into subtypes according to the degree of branch wispieness: *a*, *b*, and *c*. In the first of these galaxies, the branches are amorphous, in the second galaxies they are somewhat wispy, in the third galaxies they are very wispy, and the nucleus is always faint and small. It is found that the wispieness of spiral branches and their blueness grow with the increase in them hot blue stars, their clusters and diffuse nebulae. The central globular part of spiral galaxies is yellower than the branches and contains old stars (type 2 population) and whereas flat spiral branches consist of young stars (type 1 population). The density of stars increases as they approach the equatorial plane. Spiral galaxies are thought to rotate around the center of the galaxy, with angular and linear velocities decreasing at the periphery. In spiral galaxies, the nuclei are either globular or bar (bar) shaped, from which the branches of spiral galaxies emanate.

Ring and disk-shaped galaxies with all gradations of abundance of hot stars and dust have now been discovered. Elliptical dwarf galaxies with low surface brightness have been discovered, as well as many distant compact galaxies with huge redshifts. But the most compact of them are bluish in color. Those that have powerful *non*

with thermal radio emission are called N galaxies. Star-shaped sources with such emission are called quasars (quasi-stellar radio sources), and galaxies with powerful radio emission and notable angular sizes are called radio galaxies. Those of them, which have especially powerful non-thermal radio emission, have predominantly elliptical shape, spiral ones are also found. Seyfert galaxies have powerful gas emissions and weak non-thermal radio emission.

Along with galaxies, there are point radio sources in outer space that are optically invisible. From time to time, so-called supernovae explode, and their radiation power is very high. There are also pulsars, which are assumed to be fast-rotating stars with a narrow beam of radiation. In outer space there are clouds of gas, dust, which also emit electromagnetic radiation. It is assumed that in space there are so-called "black holes" - objects into which matter can fall irretrievably, so says Einstein's General Theory of Relativity, but they have not yet (?) been discovered.

The distances from the Earth observer to stellar and galactic objects are judged by the "Red Shift" of their spectra. The modern point of view attributes the fact of "Redshift" to the expansion of the Universe, so that the speed of moving an object is directly proportional to its distance. It is assumed that for every million parsecs the speed of objects' removal increases by 100 km/s (Hubble's law).

It should be noted that the reasons for such arrangement of outer space, origin and interaction of objects are not actually established, the assumptions about the origin, evolution of objects and their interaction are mainly speculative.

The restoration of the ether concept creates a fundamental possibility to approach the classification of galaxies differently on the basis of their functioning. By no means pretending to the completeness of such a classification, it is quite timely and reasonable to make such an attempt.

The process of matter formation - proton gas in galaxy nuclei is related to the collision of aether jets at high velocities. At sufficient energy of jet collisions, vortex rings will be born, continuously dividing and compacting. The last stage of their formation is reaching a critical density and high

of stability, these are compacted helical toroidal vortices of ether - protons. Intermediate stages are vortices of various sizes, continuing fission and generating during these transformations around themselves the most diverse helical disturbances, which diverge in all directions and which are perceived as electromagnetic radiations of a wide range of waves.

The beginning of creation of the nucleus of a new galaxy can be given by the collision of comets born by planetary systems inside the existing galaxies. Comets, the number of which in each galaxy is hundreds of billions, are generated by planets as a result of ejection from the bodies of planets of the aether accumulated there. The jet of ether ejected into outer space turns into a toroidal vortex at the exit from the planet body, in the inner regions of which the velocity of ether jets can reach superluminal speeds. The nucleus of a comet - the toroid itself - may be meters in size, but it may be thousands of kilometers in size, which is rare.

The collision of comets is not a frequent phenomenon, but the probability of such a collision is not zero. The collision of comets of sufficiently large size can create a new center of vortex formation inside galaxies. In spite of the fact that comets themselves have relatively low velocity, the jets of ether, forming the body of the comet, move inside the comet with velocities many times higher than the speed of light, and the collision of such jets leads to the emergence of a new area of vortex formation of ether.

In the vortex formation region, spontaneous fission and compaction of ether vortices occur until the density of ether in the vortex walls reaches a critical value; at this stage - the stage of proton formation - further fission and compaction stop. A simple calculation shows that at the existing density of ether in the near-Earth space the densification occurs at 28 orders of magnitude, which leads to a pressure drop of the ether in the vortex formation region. The pressure drop attracts ether flows from the conjugate regions, which sets in motion the whole surrounding ether, and the vortex formation process continues.

Since initially the vortex formation process was caused by comets moving in space, after their collision their general direction of moving of the vortex formation center changes, and the new vortex formation center - the nucleus of the future galaxy can move away from its galaxy in any direction, including the possibility of going beyond the galaxy in which it was formed.

At that stage of development of the new center of vortex formation, when the process of matter formation is already quite intense, but few new stars have been formed, collisions of ether jets and vortex fission will generate all kinds of helical uncompact ether structures propagating in all directions and perceived both as light and radio emissions of a wide spectrum of frequencies. These radiations are not shielded by other stars for the reason that they are still few in number. It is quite fair to identify such a formation with *point radio sources*, practically invisible in the optical range.

If as a result of vortex formation formed such an amount of matter that it is able to gather into stars, then such a nucleus becomes visible more brightly, and it can be identified with *quasars* - powerful radio sources of small extent.

Further increase in the number of stars will lead to the fact that part of the radiation will be shielded by the formed stars. Such galaxies are called *Seyfert* galaxies.

Increasing the number of stars formed, building up their number will lead to an increase in the size of the new galaxy and a decrease in the intensity of radio emission. These are *radio galaxies*. They are still compact enough and emit relatively powerful optical and radio emission exceeding the average data.

Further increase in the number of stars and their removal from the core zone will lead to an increase in the galaxy size. The stars spread uniformly in all directions, and when the number is sufficient, they become visible as *globular clusters* (Fig. 11.5, *a*). The age of the stars in this globular cluster can be different depending on the time that has passed since their formation, they may be young or they may be old, but this is no longer in the entire volume, but on the surface. Depending on the number of stars the intensity of their radiation also changes, in older galaxies it should be less and their color should be more yellow.

Starting from a certain point, the matter formed in the core and constituting the body of the star becomes unstable. Protons have lost energy due to the viscosity of the surrounding ether, and they begin to dissolve into the surrounding ether. This happens at the periphery of the galaxy. During the decay, the compacted aether of protons passes into a free state and the pressure of the aether in the space around the galaxy increases. The pressure difference between the periphery, where the pressure is increased, and the nucleus, where the pressure is decreased, forces the ether masses to return to the nucleus and get involved in the process

vortex formation and formation of new proton masses from which new stars will be formed.

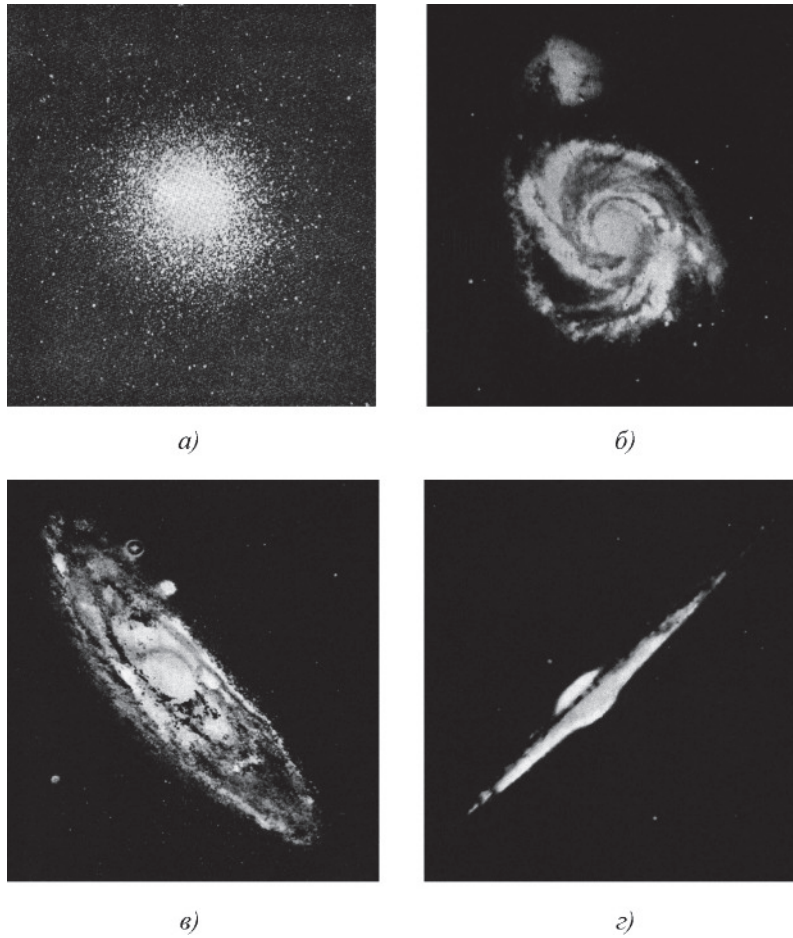

Fig. 11.5. Different types of galaxies: *a* - globular cluster; *b* - typical spiral galaxy, plane view; *c* - spiral galaxy, angled view; *d* - spiral galaxy, side view

As the process is established, branches of galaxies are formed, gradually acquiring a spiral shape analogous to a whirlpool. In these branches, two streams are formed: stars move from

core to periphery, ether flows move from the periphery to the core, and the branches themselves basically keep their position in space unchanged. Such are *spiral galaxies* (Fig. 11.5, *b-d*).

Here variants are possible. If the process of vortex formation in galaxy nuclei, having exhausted the surrounding ether, retains its intensity until the moment when the ether from the stars previously formed in its nucleus begins to flow to it, then the process of vortex formation will be supported and the spiral galaxy will be stable. Then it can exist indefinitely. The presence of regions with young stars in spiral arms indicates that the process of vortex formation and the creation of new galactic nuclei has begun in these regions, with all the consequences that follow from this. Of course, it is not necessarily that these nuclei actually became the progenitors of new galaxies, they may not be supported by ether flows, but in principle such a possibility exists

However, if the intense vortex formation in the galaxy core exhausts the surrounding ether before new portions of ether begin to arrive from its periphery, the vortex formation will stop, the pressure in the center will gradually equalize and the ether, later released into space during the dissolution of matter, will remain there at the periphery. If the spirals have already started to form, but the intensity of the reverse current of ether in them was not enough to support vortex formation, then the dissolution of stellar matter will also occur in the neighborhood of these spirals. Around the galaxy two regions of increased ether pressure will be formed, where sluggish processes of jets collision and formation of relatively long-wave radio emission will occur. In the galaxy itself, the spiral branches will begin to deform and disintegrate, and the galaxy will begin to acquire an *elliptical* shape.

All these processes are taking place in the new galaxy without taking into account what is being done in the galaxy from which the comets broke out.

As already mentioned in connection with the division of toroidal vortices of ether and their compaction, in the new vortex formation center the pressure of ether decreases, and this makes all new masses of ether rush there, which are included in the vortex formation process. The area of reduced pressure begins to expand and reaches first of all that galaxy, which generated this new vortex formation area. And if earlier, before the appearance of a new center of vortex formation, the aether freed as a result of the matter decay was directed to the nucleus of the galaxy in which this matter was formed, now the freed aether will be directed to the new center of vortex formation.

Further, the new vortex formation center, decreasing the ether pressure, will promote the pumping of ether from the neighboring regions of the old galaxy to itself. Decrease of ether pressure will cause accelerated decomposition of stellar matter and interstellar medium in the nearest to this center regions of the old galaxy. This process will support the vortex formation of the new center, which will gradually go beyond the galaxy, capturing more and more portions of ether and matter and increasing its power. At sufficient power, the ether flows will begin to capture the stars, which will be observed as a thin stellar bridge between the galaxy - the parent of the new center of vortex formation and this center. However, the stars themselves practically do not participate in the vortex formation process. Ether streams that have captured the stars will be assimilated by the new center of vortex formation, creating new stars, but the stars arriving from the galaxy will slip through this center, forming a "tail" - a stellar stream penetrating the new center and going far beyond its limits. The length of this "tail" will be determined by the stability time of protons. After their decay at the end of the "tail", the released aether will go to the nucleus of the new galaxy in order to take part in vortex formation. The flow of this ether from the end of the "tail" to the nucleus of the new galaxy should be perceived by observers as a weak magnetic field.

The new center of vortex formation is the nucleus of a new galaxy, and the resulting system of two galaxies is called *double galaxies* in astronomy. For the first time such double galaxies were discovered in the 60s by the Soviet astronomer B.A.Vorontsov-Vel'yaminov [45-47] in the number of several hundreds, now their number is thousands (Fig. 11.6).

Thus, in double galaxies, one galaxy - the old one, perishing, gives its matter - ether to the other galaxy - the new one, assimilating this ether.

However, further the fate of this new galaxy will depend on whether the new center of vortex formation will be preserved until the moment when the stars formed by it and left to the periphery begin to decay, transforming into free ether, and whether the freed ether will have time to return to the new nucleus.

If this process manages to start before the moment when the surrounding ether will be used up to the level of some minimum pressure, then further the whole process will become self-renewing and the structure of the future spiral galaxy with all intermediate stages will begin to form.

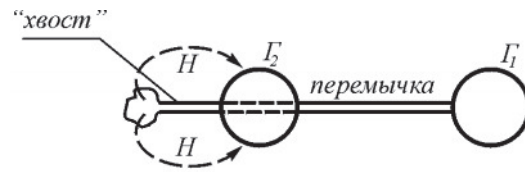

a)

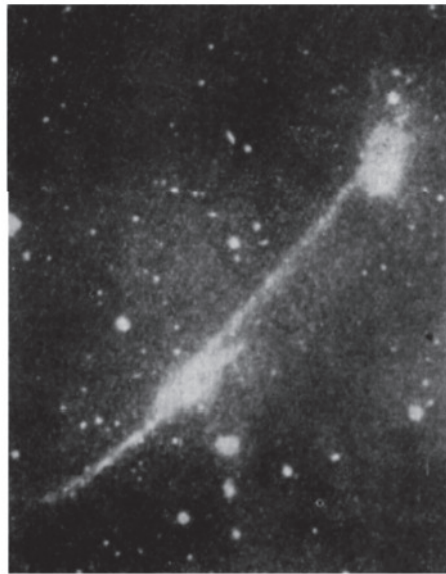

б)

Fig. 11.6. Interacting galaxies: *a* - scheme of galaxy interaction; *b* - photograph of a double galaxy.

Here a stage is possible, when the stars of the old galaxy almost completely dissolved in the ether, except for the remnants of the bridge between galaxies. The formed spirals of the new galaxy will then close on these remnants. In principle it is possible to consider the bar as an extended nucleus or as remnants of the former jumper between galaxies, but this assumption is rather artificial and it should be further clarified.

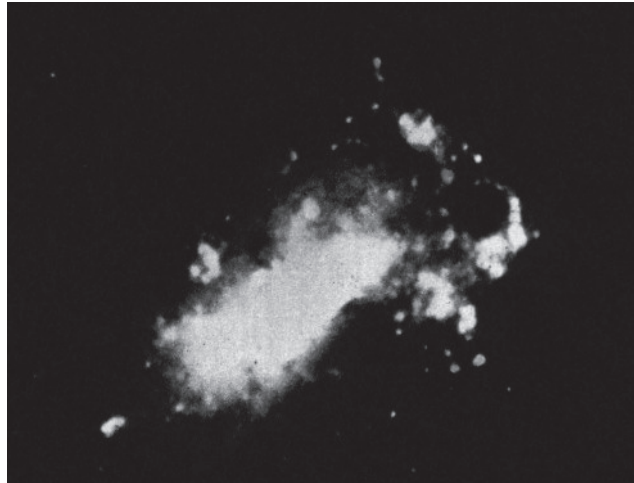

Fig 11. 7. Irregular galaxy - the last stage of existence of a star cluster

If the process of ether return from the stars in the new galaxy does not have time to settle down, and the ether in the surrounding new vortex formation center is insufficient to support the vortex formation process, it will begin to fade, then the matter decay in the galaxy periphery will occur without ether suction (Fig. 11.7). The pressure at the periphery will increase, which will delay the decay of stellar matter, but this process of dissolution of stars will continue, although slower than in spiral galaxies, in which the excess ether is sucked away from the periphery and goes to the nucleus. Such galaxies with stopped vortex formation process will slowly melt like clouds in the Earth's atmosphere. Probably, such galaxies are galaxies that no longer have their nucleus - the Magellanic Clouds, the Horseheads, as well as ring-shaped galaxies and some others, now called *irregular* galaxies.

All other gas and all kinds of radiation in space have the same causes of formation and will eventually disintegrate and pass into free ether, and in their place new masses of matter and radiation will be formed by the nuclei of galaxies. Radiations will also be created by stars, and their fate will be the same.

Thus, the ether dynamical approach allows us to systematize the main extragalactic objects not on a formal but on a functional basis. Functional

classification of galaxies relies on an understanding of the internal process of matter formation and decay (Fig. 11.8).

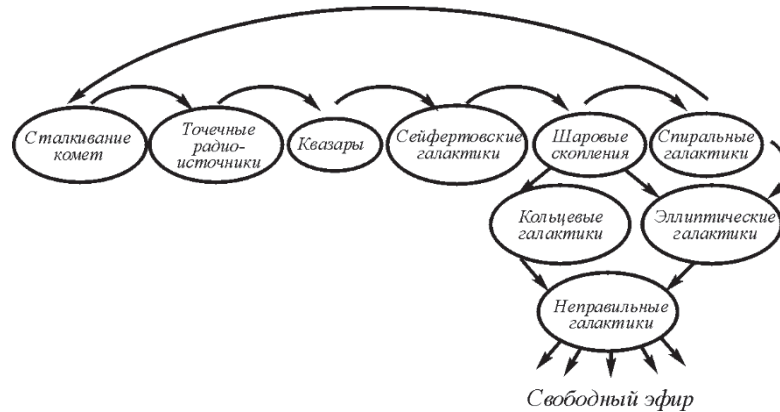

Fig. 11.8: Ether-dynamic functional classification of galaxies

The sequence of galaxies in such a classification may look as follows:

- point radio sources and their fragmentation by types depending on intensity, spectrum composition and distance; these are the centers of vortex formation of the ether and future galactic nuclei;
- quasars are former point radio sources and the nuclei of future galaxies;
- Seyfert galaxies are former quasars and future radio galaxies;
- radio galaxies - former Seyfert galaxies and future globular star clusters;
- globular clusters are former radio galaxies and future spiral galaxies;
- spiral galaxies and their fragmentation by types, for example, by the number of new vortex centers existing in them, the sign of which is the presence of clusters of young stars in different regions of the galaxy; these are former globular clusters;
- elliptical galaxies, which may be regarded as former spiral galaxies, in whose spirals the flow of ether from the

periphery to the center, vortex formation stopped, the nuclei lost activity, and the spirals disintegrated;

- double galaxies, divided on the basis of the mass ratio of the bound galaxies, from which a conclusion can be made about the moments of formation of a new galaxy and the death of an old galaxy;

- galaxies, in which there are no nuclei ("clouds"), divided by the mass and specific density, which characterize their age; these are dying galaxies.

The beginning of this process, as it was shown, can be given by the collision of comets originated in one of the existing galaxies. The end of this process consists in the dissolution of the mass of matter of the dying galaxy and the transition of its matter into the free ether. The pressure in the ether will be increased, and this will create additional conditions for the use of this mass of ether by the nearest developing galaxies.

It is likely that other functional features can be found that can form the basis of a functional classification of galaxies.

11.5. Stars and their evolution

Stars are self-luminous celestial bodies consisting of glowing gases, similar in nature to the Sun. The main parameters of stars are their mass, radius, and luminosity (the total amount of radiated energy), usually expressed as fractions of the mass, radius, and luminosity of the Sun, as well as their effective temperature, spectral class, the stellar magnitude a star would have at a standard distance of 10 parsecs, and color index (the difference in stellar magnitudes determined in two different spectral regions).

The stellar world is extremely diverse [49-51]. Some stars are millions of times larger and brighter in volume than the Sun (*giant stars*), their average density is hundreds of thousands of times less than the density of water; at the same time, there are many stars that are much inferior to the Sun in size and the amount of energy they emit (*dwarf stars*), their average density is hundreds of thousands of times greater than the density of water.

Some types of stars have periodic changes in luminosity; these are *variable stars*. Grandiose changes, accompanied by sudden increases in luminosity, occur in *new stars*. Even greater changes occur during *supernovae*.

Stars are made up of the same chemical elements as all bodies on Earth. They are dominated by hydrogen (70%) and helium (25%), as well as oxygen, nitrogen, iron, carbon, and neon. The remaining elements are few in number.

At present, several theories have been developed to explain the origin and behavior of stars. Many processes of stellar evolution are explained by them quite satisfactorily, nevertheless, some questions related to the origin of stars, their distribution in galaxies, and their evolution remain open. However, the ether dynamical approach can somewhat supplement the available ideas.

According to ether-dynamic ideas, proton-hydrogen gas is formed as a result of collision at high speeds (thousands of kilometers per second) of ether jets. These collisions may be caused, for example, by the collision of comets, in whose bodies ether jets move at superluminal speeds, or by the collision of ether streams flowing along the spiral arms of galaxies from the periphery to the core. Protons are formed as a result of vortex formation of aether streams, their spontaneous compaction and multiple fission. An electron shell is formed around protons as an attached aether vortex.

As a result of temperature decrease in protons relative to the temperature of the surrounding ether, there arises gravitational (thermodiffusive) interaction of protons with each other, and proton-hydrogen gas begins to gather in compactifications, with gravitational instability: the more gas gathers together, the stronger protons attract gas from the surrounding space. Stars are formed whose bodies continue to c o n t r a c t .

Protons, which formed stars, have maximum density and minimum sizes, the velocities of ether flows in the bodies of protons are high, the stability of protons is maximum. The ether flows in the attached vortices - electron shells - also have relatively high velocities, and the sizes of these shells are also relatively small. Therefore, the frequencies emitted by such young atoms are shifted to the region of short waves, and young stars formed by the newly created proton-hydrogen gas have blue color and spectrum shifted to the violet region.

As stars age, the size of protons increases both due to the loss of energy due to viscous friction with the surrounding aether and due to their absorption of the aether of the surrounding space. At conservation of the momentum of motion, the velocity of ether flows in the proton body

decreases, the proton stability decreases. The size of the attached vortex - the electron shell of the atom - also increases, and its elasticity decreases. Now the same atom will emit energy at lower frequencies, the emission spectrum will shift to the red side. Stars will turn yellow, and later red, it will be on the eve of their death. Protons will begin to collapse and dissolve into the ether. Apparently, in spiral galaxies, this occurs at their periphery: in spiral arms at the edges of the disk, and in the sphere surrounding the central region in the surface layers.

Stars caught in the gradient flows of the aether will begin to rotate, which will promote the formation of planetary systems around them.

It is of interest to estimate the energy capabilities of stars.

After protons have formed in the galactic nucleus, gravitational interaction occurs between them and they begin to gather into stars. The interaction of protons in stars leads to their sticking together, forming neutrons from protons and then alpha particles. At formation of each alpha-particle energy 28.3 MeV is released, which is realized in the form of collapse of nucleons and ejection of ether flow from the inter-nucleon space.

The slamming of nucleons leads to the appearance of waves on their surface and, consequently, to high-frequency electromagnetic radiation. The ejection of ether jets leads to the acceleration of protons trapped under them, hence the high temperature of young stars, as well as to the formation of turbulence and a wide variety of electromagnetic radiation.

Further energetic processes take place, apparently, both under the influence of coupling of nucleons into alpha-particles, and in connection with the energy of protons themselves - the motion of ether flows in the body of nucleons.

In principle, the energetics of proton-alpha fusion is sufficient to explain the energy of stellar radiation. Let us trace it on the example of the Sun [52].

As is known, the binding energy of an alpha particle is 28.3 MeV, or $4 \cdot 10^{-12}$ J, which is 10^{-12} J for each nucleon. With the Sun's mass of $1.99 \cdot 10^{30}$ kg, it contains $1.2 \cdot 10^{57}$ nucleons, and their binding energy is $1.2 \cdot 10^{45}$ J. The total radiation power of the Sun is $3.83 \cdot 10^{26}$ W. And hence, the entire energy of the Sun will be used up for radiation in 100 billion years. If we take into account the exponential drop of radiation intensity with time, then 100 billion years will not be a radiation term, but a time constant, while the total term will be several times longer. During this time the Sun will lose $6 \cdot 10^{-12}$ fraction of its radiation

of mass. Thus, in principle, the process of nucleon fusion into an alpha particle explains the nature of the energy of stellar radiation.

However, it should be noted that, in fact, the potential energy of stars is much larger. The above process does not take into account the intrinsic energy of protons, which is many orders of magnitude larger than the fusion energy of alpha particles. On the other hand, the stability of protons essentially depends on their loss of their own energy, which is lost due to the viscosity of the ether surrounding the protons. And if the time of existence of protons is 10-20 billion years, it means that the part of energy radiated into space, hidden from observers, significantly exceeds the energy of electromagnetic radiation, fixed by observers.

The energy of stars, in principle, is provided by thermonuclear reaction of hydrogen synthesis into helium. However, one should also take into account the fact that all celestial bodies continuously absorb the ether of the surrounding space, and since its thermal energy is higher than the thermal energy of the ether in protons, there is a continuous feeding of protons with this external energy. This means that the total radiation energy of the star for the whole time of its existence can be much larger than the value of the fusion energy calculated on the basis of the current state of the star. This means that the time of existence of the star can be longer than that calculated from the energy expenditure for radiation.

In accordance with these ideas, both the mechanism of supernovae decay and the mechanism of pulsars can be considered. Some assumptions can also be made here.

As protons lose energy, their size increases, and their central hole in protons increases accordingly. The position of ether streams forming the attached vortices - electron shells - turns out to be unstable, and if earlier ether streams were closed in the space external to the proton, now they tend to close through the central hole of the proton. This process is able to grow avalanche-like throughout the main mass of the star, and in a short time the whole mass of the star turns into compressed proton gas, which explodes, since all protons experience mutual electric repulsion. It is possible that nuclear reactions of proton fusion into deuterium, tritium, helium-3, and alpha particles with the release of additional nuclear energy are also involved in this process.

As for pulsars, the representation of them as rapidly rotating stars is rather artificial. More obvious is the model of a really pulsating star, in which longitudinal waves of compression of the body of the star and transverse waves traveling along its surface propagate. Then the relation between the periods of radiation generated by the compression waves with ejection of electromagnetic energy and modulation of radiation becomes clear - they are transverse waves. The body of the star itself does not necessarily have to rotate with the frequency of pulsations, and the radiation does not have to be narrowly directed at all, since there can be many wave crests on the surface.

In the considered picture of extragalactic astronomy, pulsars - pulsating stars and supernovae - have not found a place, but some assumptions based on the ether dynamical approach can also be made about the physical basis of these stars. This is all the more legitimate, since no physical basis is offered by modern cosmogony with respect to these formations, being limited only by phenomenology. Here it is also necessary not to forget that any fact can have innumerable interpretations, existing today in science hypotheses about processes occurring in pulsars and supernovae stars should not be considered as the only possible ones, as well as proposed below ether dynamical models of processes occurring in these stars.

Pulsars are known to be faint sources of pulsating radio emission whose bursts follow each other with a very slowly varying period. By the type of radio emission, pulsars differ from all known other sources of radio emission characterized either by constant intensity (galaxies and radio galaxies) or by regular bursts of radio emission.

The studies have shown that the maximum emission of pulsars falls on meter waves, but in one pulse there is a scattering of frequencies: first shorter and then longer waves are emitted. In principle, this can be explained by the peculiarities of the passage of waves in interstellar space. Periods of radiation pulses range from 0.033s to 3.75s. The periods slowly increase, the time during which the period doubles is millions and tens of millions of years. Modern cosmogony explains pulsars by the "rotating beacon" theory, according to which pulsars are a fast-rotating neutron star with a narrow beam of radiation.

However, the ether dynamical approach allows us to propose another model. Without objecting to the high density of matter in pulsars, let us imagine a pulsar as a large compacted ether toroid, on the surface of which waves propagate, and the toroid itself holds the ether due to the toroidal motion of the ether and the presence of a boundary layer on its surface, and has not only toroidal but also circular rotation like a proton.

The passage of waves across the surface creates a change in mechanical stresses in the surface layers, due to which radiation is produced. The ratio of the frequencies of the pulse period to the frequency of radio emission agrees well with the ideas about the velocity of propagation of transverse waves traveling along the surface of the body with longitudinal waves traveling in the body itself. The above model may be more plausible than the model of a "rotating beacon, the origin and functioning of which is still unexplained.

As for the so-called supernovae, the situation with their explanation is similar. Supernovae are stars that have experienced a catastrophic explosion followed by a huge increase in their luminosity. At their maximum luminosity, the luminosity of supernovae exceeds the luminosity of stars such as the Sun by billions of times, sometimes exceeding the luminosity of

the entire galaxy in which they are located. The maximum luminosity comes about 2-3 weeks after the explosion, after which its luminosity decreases and within 100 days decreases by a factor of 25-50. On average, in a galaxy like ours, one or two supernovae erupt per century. Astronomers discover one and a half to two dozen supernovae every year. Supernovae are divided into two types according to the nature of the change in brilliance with time and spectrum. Type I superstars are usually 3-5 times brighter than Type II superstars and are characterized by a slower decrease in brilliance after the maximum. The spectra of type II superstars are most characterized by intense emission lines, whereas type I superstars have very broad absorption lines. Another difference is the presence of strong hydrogen lines in the spectra of type II superstars, which are almost completely absent in the spectra of type I superstars.

The products of the explosion of supernovae are gas envelopes and pulsars expanding at high speed (up to 20 thousand km/s). The remnants of supernovae are sources of radio emission or thermal X-rays.

The ether-dynamic model of the supernova explosion mechanism is based on the idea of energy loss by protons with the passage of time.

As protons lose their energy, their size increases, and the central hole increases accordingly. From a certain moment, any push is enough for the ether streams, which were closing to the outer space and until then formed the first attached vortex - the electron shell, to change their direction and begin to close through this hole. The atom becomes ionized.

The ionization process proceeds avalanche-like, since many atoms are in an unstable state, primarily in the surface layers of the star, since in these layers the temperatures are lower than in the inner layers, hence, the velocities of atoms are smaller and the velocity gradients of the aether on their surfaces are smaller, and hence, the viscosity of the aether is higher. The ionization process spreads over the surface and into the depth with the speed of sound and within a few hours is able to cover all regions of the star where protons are in an unstable state. Very quickly large regions of compacted gas are ionized, all protons are repelled from each other, and an explosion occurs.

It is of interest to estimate the acceleration that the proton on the surface of the star receives as a result of such ionization.

If we visualize the parameters of the star similarly to the solar parameters, i.e., M_{3B} = $2 \cdot 10^{30}$ kg and R_{3B} = $7 \cdot 10^8$ m, then the number of protons in the star is

$$N_p = \frac{M_{3B}}{m_p} = \frac{2 \cdot 10^{30}}{1.67 \cdot 10^{-27}} = 1.2 \cdot 10^{57} \text{ pcs.} \quad (11.3)$$

Assuming that the whole body of the star is ionized, its charge will be

$$Q_{zv} = N_p \cdot e = 1.2 \cdot 10^{57} \cdot 1.6 \cdot 10^{-19} = 2 \cdot 10^{38} \text{ Cl.} \quad (11.4)$$

The Coulomb repulsive force acting on the proton on the surface of the star will be:

$$F = \frac{Q_{zv} e}{4\pi\epsilon R_0^2} = \frac{2 \cdot 10^{38} \cdot 1.6 \cdot 10^{-19}}{4\pi \cdot 8.85 \cdot 10^{-12} \cdot 7^2 \cdot 10^{16}} = 6 \cdot 10^{11} \text{ H} \quad (11.5)$$

and, hence, the acceleration, which the proton moving away from the star will receive, will be equal to

$$a = \frac{F}{m_p} = \frac{6 \cdot 10^{11}}{1.67 \cdot 10^{-27}} = 3.6 \cdot 10^{38} \text{ m-s}^{-2}. \quad (11.6)$$

This acceleration will be greater than the acceleration of gravity on the surface of the Sun by a factor of $1.3 \cdot 10^{36}$!

The real acceleration of protons will be still many times less because, first, not all body of the star is ionized simultaneously, this process spreads out in time, during which the upper layers of plasma move away from the star, and second, not all body of the star is included in the process, there remains some residue from the star. Nevertheless, it is seen that the process of collapse ionization is able to provide the energy of the supernova explosion. As one moves away from the center of the explosion, the acceleration of the proton will decrease by at least a fifth of the distance, as all the mass is atomized into space. This means that at a distance of ten times the radius the acceleration will decrease by a factor of 10^5 , and at a distance of one hundred radii the acceleration will decrease by a factor of 10^{10} . And already after removal on 10 million radiuses acceleration at all will not be any more, the gas flight will continue on inertia. In fact, this limit will come earlier, which corresponds to observations.

The same event can be approached from a different angle.

The average density of the Sun is $1.41 \cdot 10^3 \text{ kg-m}^{-3}$, which means that one cubic meter contains 10^{30} protons, i.e. the distance between neighboring protons is 10^{-10} m. When hydrogen atoms are converted into protons, the repulsive force between protons will be equal to

$$F = \frac{q^2}{4\pi\epsilon r_0^2} = \frac{(1.6 \cdot 10^{-19})^2}{4\pi \cdot 8.85 \cdot 10^{-12} \cdot 10^{-20}} = 2.3 \cdot 10^{-8} \text{ H}. \quad (11.7)$$

and the protons will receive acceleration equal to

$$a = \frac{F}{2m_p} = \frac{2.3 \cdot 10^{-8}}{2 \cdot 1.675 \cdot 10^{-27}} = 6.85 \cdot 10^{18} \text{ m-s}^{-2}. \quad (11.8)$$

The total velocity of the proton can be

$$v = \int adt = \int adr(dt/dg) \quad (11.9)$$

or

$$v^2 = \int_{r_0}^{\infty} adt = \int_{r_0}^{\infty} adr \quad (11.10)$$

Substituting the corresponding numbers, we obtain that the velocity reached by the two protons as a result of their interaction alone is 26 km/s. However, since the entire body of the star explodes, the velocity of the outer layers will increase many times.

As for dwarf stars, neutron stars, etc., one more possibility of their explanation on the basis of ether dynamical concepts should be pointed out. In principle, the formation of large etherodynamic toroids is possible in space, and the participation of ordinary neutrons in their structure is not excluded. Their external parameters will differ little from those of neutron stars. The waves passing on their surfaces and in their depth will stimulate radiation into the external medium. Here the high rotational velocity of the star is immediately explained, since its rotation arises from the same transformation of toroidal velocity into ring velocity as occurs in the body of a proton. In fact, pulsars may turn out to be one of the varieties of such toroids.

Thus, the ether dynamical approach can somewhat complement the ideas about the origin, evolution, and death of stars and their energetics.

11.6. The solar system as an element of the Galaxy

Numerous researchers, such as Descartes (1596-1650) and Kant (1724-1804), devoted their efforts to the question of the origin of the solar system and the explanation of the peculiarities of its structure, Buffon (1707-1788), Laplace (1749-1827), Darwin (1845-1912), Hoyle (1944, 1958), Kuiper (1951), McCree and some others. The concept of O.Yu. Schmidt (1891-1956) is the most recognized at present. A detailed review of the main hypotheses is presented in [54, 55].

The main questions to be answered by the authors of the hypotheses were as follows:

1. How did the solar system come about in the first place?

2. Why does the vast majority of the solar system's mass (99.87%) is encased in the sun?
3. Why do the orbital planes of all planets and all major satellites coincide with the plane of the solar equator?
4. Why do all the planets and the Sun itself orbit in the same direction (forward) direction?
5. Why do the planets themselves also rotate on an axis in the same forward direction?
6. Why do most satellites orbit around their planets in a straight line as well?
7. Why, despite its low mass, does the system of planets carry a major (98%) orbital momentum?

The reviews of the hypotheses point out their shortcomings. While answering some questions, each hypothesis did not answer others. Practically none of the hypotheses, except for Descartes' hypothesis, has not explained the origin of the material from which the Solar System was formed. But the main drawback of hypotheses, apparently, is the separation of the question of the origin and formation of the solar system from galactic processes. Ephyrodynamics for the first time allows us to consider the peculiarities of the structure of the Solar System in connection with these processes, which makes it possible to answer all the above-mentioned questions in a relatively simple way.

It has been shown above that within the spiral Galaxy the aether circulation is carried out - the aether streams rush to the nucleus in spiral arms, from the nucleus the aether leaves in the form of formed toroidal vortices - protons with attached vortices - electron shells. The formed gas - hydrogen - gathers into stars, which continue to move to the periphery of the Galaxy by inertia (the gas, expanding, rushes out of the core).

As Miller believed, the velocity of the ether wind at the present time in the region of the Solar System is about 400 km/s, although, if we rely on the theory of the boundary layer, the data of the same Miller give an overestimated value. According to Miller's data, the ether wind in the Solar System neighborhood has a direction from the star ζ (Zeta) of the constellation Dragon (64° , 17.3 h), i.e. in the direction perpendicular to the axis of the spiral arm, which in the Solar System neighborhood is directed to the constellation Leo (15° , 11 h). However, based on the same Miller's data that at a height of 1860 m the velocity of ether wind does not exceed 10 km/s, and taking into account that the atmosphere with increasing height decreases its density and ability to capture ether flows,

it is necessary to assume the velocity of the ether wind in the region of the solar system of the order of 50 km/s.

It has now been discovered that in the direction of the constellation of Leo there is some anisotropy of space - a shift in the spectra of relic radiation.

According to the experiments conducted on board the U-2 airplane (NASA) by Korn, Wilkins, Smith et al. [55], the following results were obtained: the velocity of the Earth relative to the background radiation is 320-390 km/s and the velocity vector is directed to a point with coordinates $\alpha = 12h \pm 1h$; $\delta = 32^\circ \pm 21^\circ$. In the galactic coordinate system, this direction has coordinates $L = 194^\circ$; $\delta = +65^\circ$. The last measurements of the large-scale anisotropy of the background radiation of the Universe with respect to the Solar System were made in 1977 by a group of authors from Berkeley. The following results were obtained:

$$v = 390 \pm 60 \text{ km/s}; \alpha = 11h \pm 0.5h; \delta = 6^\circ \pm 10^\circ.$$

However, it should be noted that the interpretation of the obtained results as evidence of the motion of the Solar System in this direction is hasty, for in the direction of the constellation of Leo there is a number of gradient parameters of the ether flow having perpendicular directions. These gradients of density, pressure, temperature, etc. are enough to explain the phenomenon not by the displacement of the Solar System towards the constellation of Leo, but by the change of parameters of photons passing through the gradient streams of the ether wind.

In the rarefied gas that forms a star at the initial stage of its development, the ether wind pressurizes each proton. At the ether wind velocity of 10^3 m/s and ether density of 10^{-10} kg/m³ the Reynolds number will be as follows

$$\text{Re} = vD/\chi = 10^3 \cdot 1.12 \cdot 10^{-15} / 4 \cdot 10^9 = 3 \cdot 10^{-22}, \quad (11.11)$$

to this value will correspond to the drag coefficient $c_w = 1000$. Since the midsection of the proton is 10^{-30} m², the acting drag force is

$$F = c_w \rho S v^2 = 10^3 \cdot 10^{-10} \cdot 10 \cdot 10^{-306} = 10^{-31} \text{ H}. \quad (11.12)$$

With a mass of $1.6 \cdot 10^{-27}$ kg, the proton would have an acceleration of

$$a = F/m_p = 10^{-31} / 1.6 \cdot 10^{-27} = 6 \cdot 10^{-5} \text{ m-s}^{-2} . \quad (11.13)$$

In a day the proton will acquire a velocity of about 5 m/s, and in a year of the order of 2km/s.

In fact, this velocity will be much less, because, firstly, the acceleration occurs on one side of the star, and on the opposite side the proton is slowed down, and the acceleration occurs due to the difference of velocities of the ether wind, i.e. due to the gradient of its velocities, and secondly, the formation of the star is accompanied by its compression, which leads to mutual shielding of protons. This means that actually directly under the surface layer the ether wind sharply reduces its velocity. Thus, the acceleration received by the surface gas atoms is redistributed to the entire mass of the star.

As shown above, the time constant of the Sun's mass accumulation at present is about 2 billion years. With the Sun's age of about 5.5 billion years, this means that its initial mass was 15 times smaller than it is now. However, in the core region, the density of the aether is at least two orders of magnitude greater. Consequently, the time constant of mass accumulation was much smaller at that time.

This means that the Sun's initial mass was actually even smaller, amounting to no more than 0.01 of the Sun's present-day mass.

The velocity gradient of the aether in the region of the Galaxy core in the boundary layer of the spiral arm should be of the order of magnitude

$$\text{grad } v = \frac{\Delta v}{\delta} = \frac{10^6 \text{ m-s}^{-1}}{0.3 \text{ ps}} = \frac{10^6}{0.3 \cdot 3.1 \cdot 10^{16}} \text{ m-s}^{-1} = 10^{-10} \text{ ---}, \quad (11.14)$$

where δ is the thickness of the boundary layer in the arm of a spiral galaxy, conventionally assumed to be 0.3 parsec based on the analysis of photographic images of spiral galaxies.

At the Sun's diameter of about 10^9 m (the mass is smaller than at present, but the compaction is still insufficient), the difference in the velocity of the etheric flow at the edges of the Sun amounted to

$$\Delta v_3 = Dc \text{ grad } v_3 = 10^9 \cdot 10^{-10} = 10^{-1} \text{ m-s}^{-1} . \quad (11.15)$$

Hence the difference of forces acting on the protons that are on opposite sides of the Sun is

$$\begin{aligned} \Delta F &= c_w (v_1^2 - v_2^2) = 2c_w \rho v_3 \Delta v S_{3p} = \\ &= 2 \cdot 10^3 \cdot 10^{-10} \cdot 10^{-3} \cdot 10 \cdot 10^{-1-30} = 2 \cdot 10^{-41} \text{ H.} \end{aligned} \quad (11.16)$$

Here the density of the ether is taken to be $\rho_3 = 10^{-10} \text{ kg} \cdot \text{m}^{-3}$, i.e., one order of magnitude higher than in the region of the present near-Earth space, and the velocity of the ether wind is taken to be $v_3 = 10^3 \text{ m} \cdot \text{s}^{-1}$.

It would take time to reach a gas flow velocity of 2000 m/s across the Sun's surface

$$T = v g \cdot 2m_p / \Delta F = \frac{2 \cdot 10^3 \cdot 2 \cdot 10^{-1-6,7-10^{-27}}}{2 \cdot 10^{-41}} = 10^{10} \text{ years} = 10 \text{ billion years.} \quad (11.17)$$

Thus, the presence of the ether wind gradient in the boundary layer of the ether flow rushing to the galactic nucleus is more than enough to ensure the Sun's unwinding, especially if we take into account its subsequent compression, as a result of which further self-winding will lead to even greater acceleration of its rotation.

The actual process was, of course, more complicated. As the Sun shrank, its density increased and the forces acting on protons decreased due to their shielding by each other. Due to the fact that the Sun moved to the region of expanding arms, where both the velocity of the ether wind and the gradient of its velocity decrease, the Sun accumulated mass and the momentum of rotation redistributed to the entire mass, the linear velocity of motion of its surface layers decreased.

Thus, at the early stage of formation, the Sun had a mass much smaller than at present, at least by two orders of magnitude, and at compression its rotation speed could be much higher than now. Later, as the ether was absorbed, the Sun's mass grew, its diameter also increased, and its rotational velocity decreased accordingly, until it reached the present value of 2 km/s.

At the surface of the Sun along the equator, the ratio between the forces of attraction and centrifugal repulsion is now equal to

$$\frac{F_u}{F_t} = \frac{m v_e^2 R \vartheta^2}{Gm M R_{pCC}} = \frac{2 R_c (2 \cdot 10^3)^2 \cdot 7 \cdot 10^8}{6.67 \cdot 10^{-11} \cdot 1.99 \cdot 10^{30}} = 2 \cdot 10^{-5}, \quad (11.18)$$

Therefore, it is out of the question that a part of the matter could break away from the Sun under the action of centrifugal force. However, at an early stage of the Sun's formation, the situation could have been quite different.

As already mentioned, the mass of the Sun was at least two orders of magnitude smaller in the beginning. After compression, its radius decreased significantly and its rotational velocity increased significantly. If the density of the Sun were the same as it is now, its radius would be about 5 times smaller. If by that time the Sun had accumulated all its rotational momentum, then with a smaller mass, the speed of motion of its equatorial layers compared to today's existing would be at least 1000 km/s due to a smaller diameter than now and another 100 times due to a smaller mass.

In view of the above, the above ratio would become quite different. The ratio of centrifugal force to gravity would be

$$k_{zt} = \frac{F_c}{F_t} = \frac{1.4 \cdot 10^8 \cdot (10)^2}{6.67 \cdot 10^{-11} \cdot 2 \cdot 10^{28}} = 10^2 \text{ times!} \quad (11.19)$$

This means that Darwin's hypothesis, which he expressed in relation to the formation of the Moon as a part of the Earth that broke away, can be applied to the formation of the entire planetary system: when the Sun was compressed at the first stage of its evolution, a tidal wave had to arise on its surface at the equator, which, due to the predominance of centrifugal force over gravity, broke away and further disintegrated into parts, since it has internal rotations. These parts formed into planets, with which the same thing happened - they formed satellites. This process could happen once, but it could also happen many times, creating successive tidal waves, ejecting their matter in the equatorial plane and forming planets one by one. Which variant was in fact, it is difficult to establish yet.

The detached planets were still under the influence of the ether wind. However, it should now be considered that the forces that spin the planets in their orbits are much more effective than the same forces that continue to spin the Sun. This is due to the fact that the Sun is a large mass, and the shielding effect of matter for the etheric wind here is considerable

is greater than that of the smaller masses. And most importantly, the diameter of the Sun is smaller than the diameter of the orbits of the planets. Consequently, the velocity difference in the gradient flow for the orbits of the planets is larger than for the surface layers of the Sun, which means that the orbital momentum of the planets will build up much more efficiently than that of the Sun (Fig. 11.9).

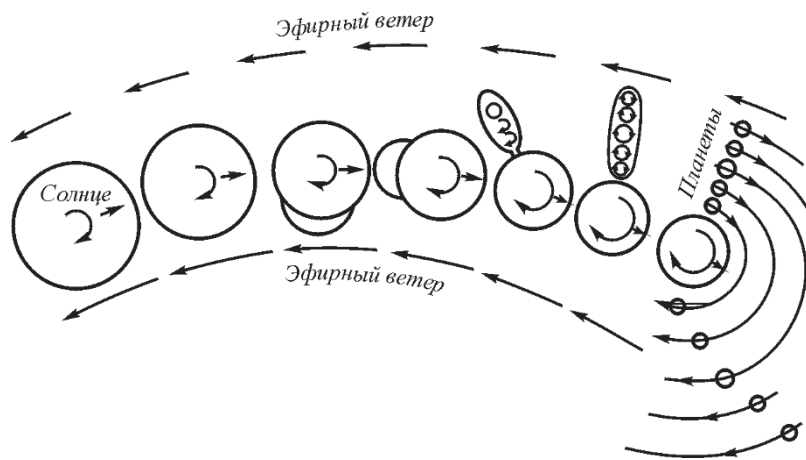

Fig. 11.9. Emergence of planetary system and build-up of orbital momentum of planets under the influence of ether wind gradient

Finally, the absorption of ether by the planets will reduce the rotation rate only in proportion to the accumulated mass. At the Sun the rotation speed slows down both due to mass and due to the increase of its radius. Thus, the excess of the value of the orbital momentum of the planets over the value of the Sun's rotational momentum is quite natural.

The rotation of the planets and their satellites in the forward direction can be explained accordingly. The main difficulty in explaining this fact is the assumption that gaseous bodies must rotate according to the law of constancy of velocity circulation

$$\int_l v dl = \text{const}, \quad \text{or } v = G/2\pi r, \quad (11.20)$$

and, consequently, the deep layers of the Sun should rotate faster than the surface ones, which leads to a reverse rotation of the detached masses. However, this statement is incorrect.

The above law is not true in all cases. This law really takes place at preservation of constant density and common for the whole mass reason of spinning. There is none of this in this case. In the initial stage of formation of the Sun, its compression was accompanied by compaction. The unwinding of the Sun's mass occurred by unwinding of its surface, and the surface layers must move faster than the inner ones. Because of this, the detached masses are bound to have a direct rotation. Thus, this fact finds a simple and natural explanation. The same applies to the satellites of planets.

The opposite fact is a difficulty - a group of small satellites of Jupiter (VIII, IX and XII), satellites of Saturn's Phebus and Neptune's Triton have not direct, but reverse rotation. In principle, if we assume that in the surface layer of Jupiter and Neptune at the time of formation of their satellites still had a conservation of circulation velocity, then this case is explained. But it requires special studies.

After the formation of planets, the Solar System continues its path along the boundary layer of the spiral arm. The direction of the ether wind changes, as well as the direction of its gradient. The Sun finds itself under the influence of forces whose momentum is tilted to its axis. As in any gyroscope, precession begins, which leads to a tilt of the Sun's axis of rotation by 7° with respect to its original position. Due to the fact that the Sun is not a solid solid body, its surface layers retain the same orientation as the orbital plane of the planets. At present, the precession is complete, since the velocity gradient of the aether in this region is small.

Thus, the consideration of the processes of formation and formation of the Solar System as a result of the processes occurring in the Galaxy allows us to explain the main features of the structure of the Solar System on the basis of ether dynamics in a natural way. Of course, the stated assumptions can claim only the role of hypothesis.

From the above, among other things, we conclude that only the stars trapped in the boundary layer of the spiral arms of the Galaxy have their own rotation. These stars can also have their own

planetary systems. The stars, which did not get there, do not have their own rotation and cannot have their planetary systems.

As it is known, at present the orbits of the planets are arranged in such a way that in 1766 the German physicist I.D. Titius managed to deduce an empirical dependence, which thanks to the works of the German astronomer I.E. Bode became widely known. This dependence, called the Titius-Bode rule, establishes that the distances from the planets to the Sun, expressed in astronomical units, obey the dependence 0.4 (Mercury); 0.7 (Venus); 1.0 (Earth); 1.6 (Mars); 2.8 (asteroids); 5.2 (Jupiter); 10.0 (Saturn); 19.6 (Uranus); 38.8 (Pluto) with an error of no more than 3%. Neptune falls out of this dependence. This dependence is obtained as follows. To the numbers of the sequence 0; 3; 6; 12;

24; 48; 96; 192; 384, starting with 3, the number 4 is added, and then all numbers are divided by 10. In fact, it is a geometric progression with a certain initial shift. A satisfactory theoretical explanation of this empirical dependence has not been given to date. However, based on etherdynamic ideas about the essence of processes, we can put forward a certain hypothesis about the physical essence of this dependence (Fig. 11.10, 11.11).

The Sun, rotating, is a centrifugal pump relative to the masses of ether surrounding it, which at the equator ejects ether into the outer space, and at its poles draws it in. As a result, in the area of poles there is a drain of ether, and along the whole equator there is a source. As a result, two toroidal flows are formed around the Sun: one in the northern and the other in the southern part of the Sun. A flat gradient flow will be formed in the equatorial plane, in which the maximum velocity and, accordingly, the maximum velocity gradient will lie in the equatorial plane. Exactly here there will be a minimum of pressure of aether that will force planets to stabilize exactly around the plane. Further the flows will diverge and head towards the poles. The first pair of toroidal flows will be joined by the second pair, the third pair will join it, etc. with ever-increasing sizes, just corresponding to the above mentioned dependences. The position of the planet is stabilized due to the Ether flows pushing it out into the space between the vortices. As for the flows going in the direction transverse to the plane of the Sun's equator, each planet crosses this plane twice during the period of revolution around the Sun and experiences pressure in one half-period to one side and in the other half-period to the other side, as a result maintaining the position of its orbit

unchanged. Thus, a hypothesis about the physical basis of the Titius-Bode dependence is stated for the first time.



Figure 11.10: Secondary vortices indicated by an oscillating cylinder. The currents around the cylinder are similar to the currents around the Sun as a centrifugal pump.

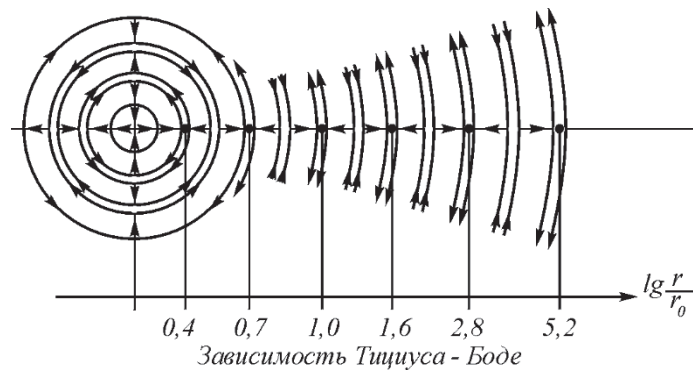

Fig. 11.11. Toroidal vortices of the ether created by the Sun, zones of reduced pressure of the ether corresponding to the **Titius--** Bode dependence.

The origin of sunspots can be considered from a similar position (Fig. 11.12).

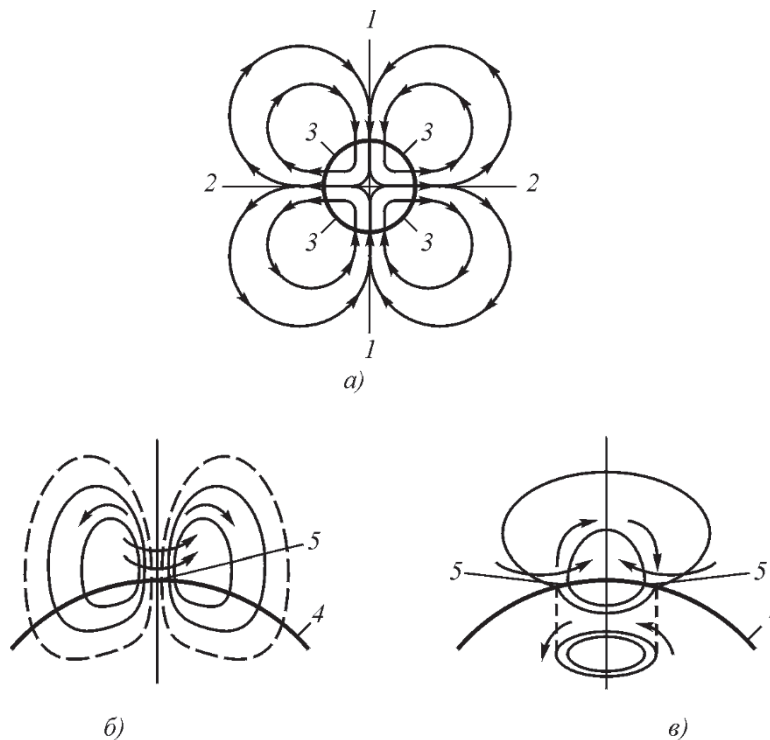

Fig. 11.12. Sunspot formation on the Sun: *a* - the Sun as a centrifugal pump pumping ether; *b* - ether flows in the area of a unipolar spot; *c* - ether fluxes in the area of the bipolar spot. *1* - direction of ether suction; *2* - blowing of ether along the equator of the Sun; *3* - the area of maximum gradients of ether flows and the area of sunspots; *4* - the surface of the Sun; *5* - the areas of observed sunspots.

Consideration of velocity gradients in connection with the Sun's role as a centrifugal ether pump leads to the conclusion that there is no appreciable velocity gradient in the equatorial and pole regions. Spots occur in the region of the northern and southern hemispheres in the belt of latitudes from 5° to 30° (the so-called "royal zones"). It can be suggested that the presence of a large velocity gradient of the aether flows in these regions stimulates the appearance of relatively stable vortex toroidal formations, which are the following

sunspots. Then their nature becomes clear: vortex toroids near the Sun's surface can have two positions: the first, in which the plane of the toroid is perpendicular to the plane of the surface, half of the toroid being in the Sun's body; the second, in which the plane of the toroid coincides with the plane of the Sun's surface. In the first case we have on the surface a cut of the toroid across its plane (bipolar spots), in the second case - along the plane (unipolar spots), in which only the central part of the toroid (core) is visible. Multipolar spots are apparently a chaotic set of bipolar and unipolar spots. Only compact sections of toroids on the Sun's surface are observed as "spots", because the part outside the Sun has a much lower density and larger size, and its observation is difficult.

11.7. The etheric wind and the structure of the Earth

Aether currents flowing in the spiral arm of our Galaxy wash the Solar System and, consequently, the Earth. Many researchers have drawn attention to the fact that space in the area of the Solar System is not quite isotropic. Thus, A.A.Shpitalnaya [57] points out the sharp asymmetry of the Sun's activity: on its northern side flares occur about 1.5 times more often than on the southern side. There are known statements that in the direction of the constellation of Leo there is anisotropy of relic radiation [13]

The anisotropy of space is also traceable at the level of the Earth.

On Earth, volcanic activity is much more intense in the Northern Hemisphere than in the Southern Hemisphere. The Northern Hemisphere is where most of the continents are concentrated. There is a global climatic difference of the Northern and Southern hemispheres on the Earth: the presence of stormy forties latitudes, ocean in the area of the North Pole and ice continent in the area of the South Pole, lowered temperature of the areas of the South Pole in comparison with the northern regions testifies to the spatial asymmetry of the Earth's global processes.

Many of the above phenomena receive a simple explanation if we take into account the blowing of the Earth by the etheric wind, i.e. that flow of ether in which our solar system is located and which flows in the spiral arm of the Galaxy, having a general direction from its periphery to the core.

The fact of existence of the ether wind was experimentally confirmed by the works of Miller and his group in 1905-1907 and further in 1921-1925, and later in 1929 by Michelson, Pease and Pearson, about what there are corresponding reports of these groups. In work [56] the articles are given, in which the results of experiments carried out by these groups are stated, and also the principal gross methodical and instrumental errors made by other groups (Kennedy, Illingworth, Piccard, Staheli, Towns, Cedarholm), which did not receive any results, declaring instead of analyzing their errors about non-existence of the ether wind and the ether itself as such, are shown. At present, studies of the ether wind are carried out by the group of Yu.M.Galaev (Kharkov) [71].

As a result of the works of Miller (see [100-106] to Chap. 1), who set a series of experiments with an interferometer inherited by him from Michelson and Morley, it was found out that there is a clear dependence of the velocity of the ether wind on height, and on the surface of the Earth, as it was shown in 1881 and 1887 by the authors [39, 40], the relative velocity of the ether wind is small and at a height of 250 m above sea level is about 3 km/s, and at a height of 1860 m - from 8 to 10 km/s. Thus, the relative velocity of the ether wind increases with altitude. It can be assumed that the velocity of the ether wind in space is 50-60 km/s.

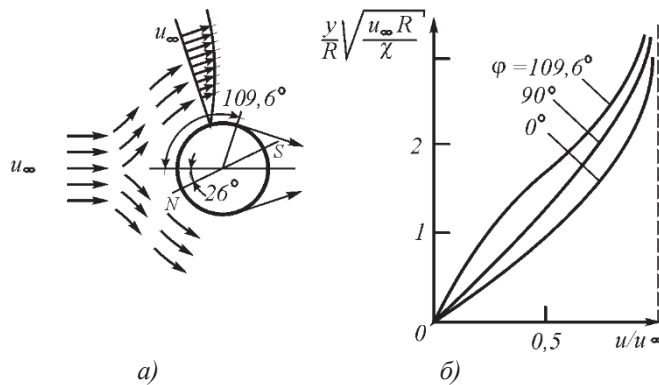

Fig. 11.13. Streaming of a ball by a gas flow: *a* - direction of flows; *b* - epuram of change of relative velocity of the flow with increasing distance from the surface of the ball

- After processing the data, Miller found that the direction of the ether wind is as if the Earth in its motion in the still ether was moving towards the star of the constellation Dragon (declination $+65^\circ$, direct ascension 262°). The probable error in Miller's experiments did not exceed 2° . These coordinates almost coincide with the coordinates of the pole of the ecliptic.

The results obtained by Miller are in full agreement with the theory of balloon flow with gas flow [58, p. 227-232]. The solution of the system of equations for the balloon flow is graphically depicted in Fig. 11.13.

When flowing around a ball, the gas forms a boundary layer, and the layers nearest to the body surface move together with the ball, while the distant ones have some intermediate velocity, and starting from some value, the gas velocity corresponds to its velocity in free space. In other words, the boundary layer has a certain thickness depending on the parameters of both the gas and the balloon. At points with coordinates relative to the central axis of the gas flow $\varphi_{\text{отр}} = 109.6^\circ$ the boundary layer breaks away. Starting from this coordinate, the gas should be stationary relative to the ball at various distances from it up to the detached and passing at some distance from the boundary layer ball.

If the balloon is blown by a flow of gas, the pressure will be different on the surface of the balloon on the side of this flow [56, p. 277-285]. In the frontal part, which is under the direct impact of the impact of the flow, the gas pressure will be increased. On the Earth it corresponds to the area of the Arctic Ocean, the continents cannot penetrate here, as the increased pressure of the ether in this area will push them away. Further the ether stream flows around the ball, a gradient of velocities in the boundary layer is formed, and consequently a reduced pressure. On Earth, this will lead to the fact that from areas of higher pressure in the Southern Hemisphere, the continents will gradually shift to an area of lower pressure in the Northern Hemisphere, which will be somewhat elongated compared to the Southern Hemisphere. As a result, the Earth should take the shape of a pear, which is actually the case: the Northern Hemisphere is elongated compared to the Southern Hemisphere by 400 m, such a shape of the Earth is called a geoid (Fig. 11.14)

Streaming of the Earth's globe by the ether flow leads in the area of the South Pole to the emergence of the attached toroidal vortex. The axis of this toroid will have a constant galactic direction, and the ether flows of the vortex will involve in its motion the Antarctic air masses of the atmosphere.

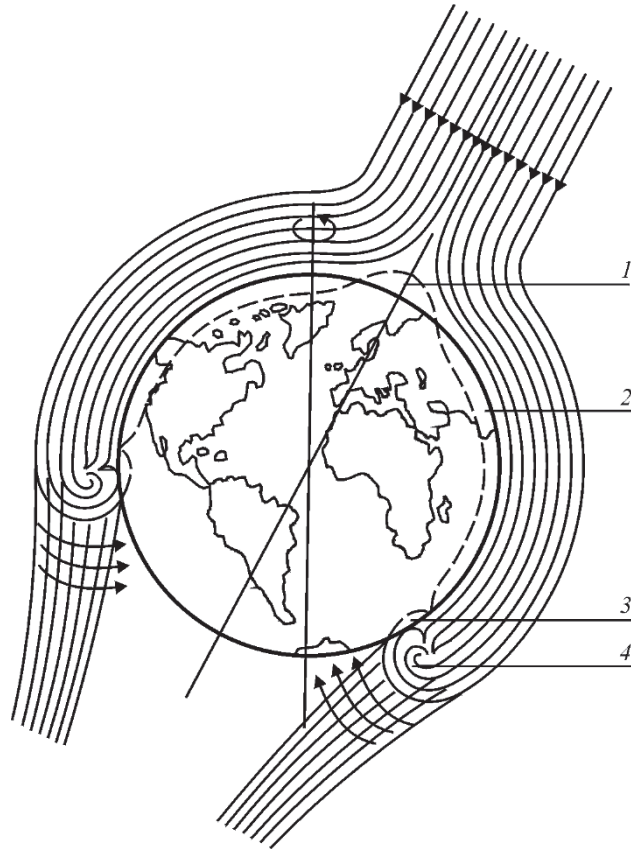

Fig. 11.14. Streaming of the Earth by ether wind: 1- zone of increased ether pressure; 2 - zone of decreased ether pressure; 3 - zone of moisture capture from the ocean; 4 - attached toroidal ether vortex capturing atmospheric air in winter.

The formation of a toroidal attached vortex is confirmed by modeling (Fig. 11.15).

The air masses, which got into the zone of the etheric attached vortex, will circulate, pass over the ocean, where they will gain moisture, and then, rising to the stratosphere and cooling, will pressurize the air there, increasing the pressure, and throw moisture in the form of snow already on the ice continent itself. However, this only happens

in winter. The explanation for this may be the fact that in winter the air of the lower atmosphere is colder and therefore denser.

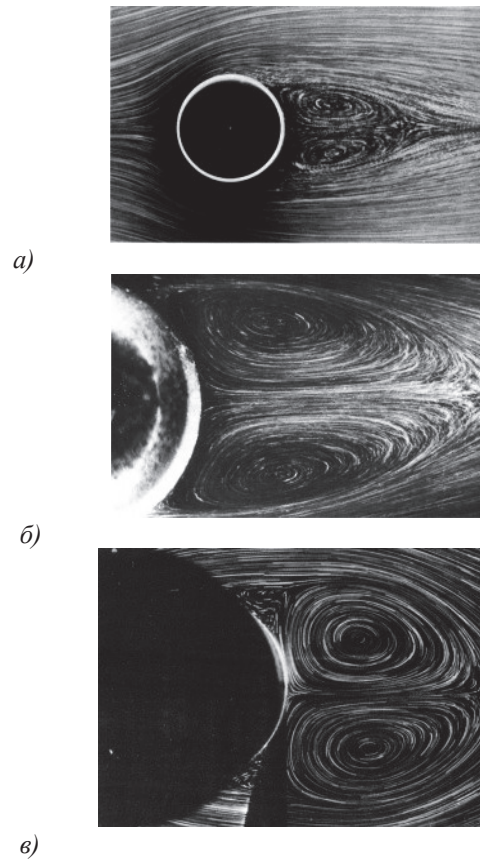

Fig. 11.15 Streaming of a body of rotation by gas flows: a - streamline of a circular cylinder at $Re = 26$; b - streamline of a ball at $Re = 118$; c - **streamline of a ball at $Re = 500$.**

The density of air at the same pressure is higher the lower the temperature:

$$\rho_B = \rho_{B0} T / T_0 \quad (11.21)$$

and at atmospheric pressure and in summer at 0°C is 1.2928 kg/m^3 , in winter at -60°C is 1.656 kg/m^3 , i.e. 1.28 times more. Since the number of air molecules in a unit volume increases, the total force acting on it from the side of penetrating into this volume of ether flows increases proportionally. The air begins to be captured by the attached ether vortex, a toroidal air vortex develops, and this process grows avalanche-like. This corresponds to reality, as there is always a stable anticyclone in Antarctica, and in winter it snows almost all the time, building up ice masses, which gradually slide to the ocean and break off, forming icebergs.

In those places where the attached ether vortex most closely touches the ocean surface, turbulence arises, which leads to the agitation of water masses located in this area. Stable westerly winds blow here, which is explained by the manifestation of Coriolis forces caused by the relative motion of the ether and the rotation of the Earth. These are the "roaring forties", which actively manifest themselves in winter. In summer, everything calms down, which indicates that with the increase in air temperature and, accordingly, with the decrease in its density, air masses are no longer captured by etheric flows with such force to form a stable vortex.

This kind of phenomenon is absent on planets with low atmospheric pressure, such as Mars, but can occur on planets with high atmospheric density at low temperature. It should be noted that the ether wind has not one, but two systematic components - galactic and solar (Fig. 11.16). The solar component of the etheric wind owes its origin to the Sun working as a centrifugal pump. As a result, there is a change in the direction of the etheric wind on the Earth's surface throughout the year, as both components are added on one side of the orbit and subtracted on the opposite side. Combined with the absorption of ether by the Earth, leading to its expansion, mass increase, slowing of rotation, spreading (pulling) of continents apart, formation of the rift ridge system, spreading of the ocean floor and its subduction (crawling) under the continental plates, the general picture of the causes of the Earth's structure becomes clearer.

Emission of toroidal and photon-like structures as a result of internal perturbations of the Sun, recorded by the author on the records of laser beam oscillations, upon their reaching the Earth's

of the surface, leads to fluctuations of values and directions of ether flows on the Earth's surface. This is also the cause of the so-called magnetic storms and disturbances (Fig. 11.17).

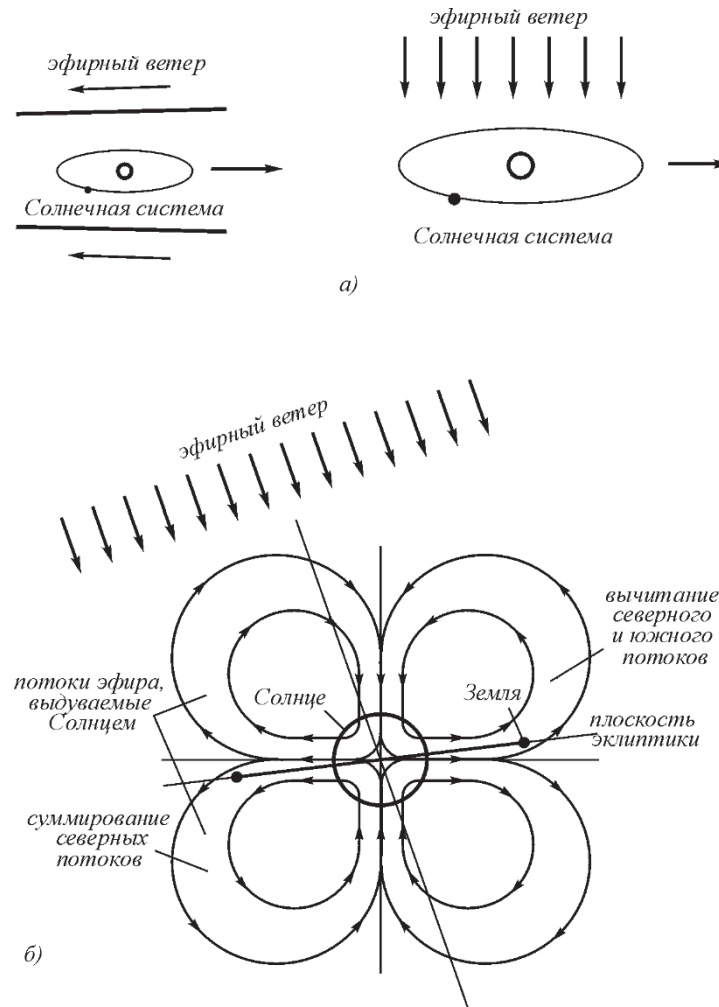

Fig. 11.16. Direction of the ether wind relative to the Earth's orbit: *a* - at the beginning of the formation of the Solar System and at present; *b* - annual displacements of the Earth relative to the ether flows created by the Sun

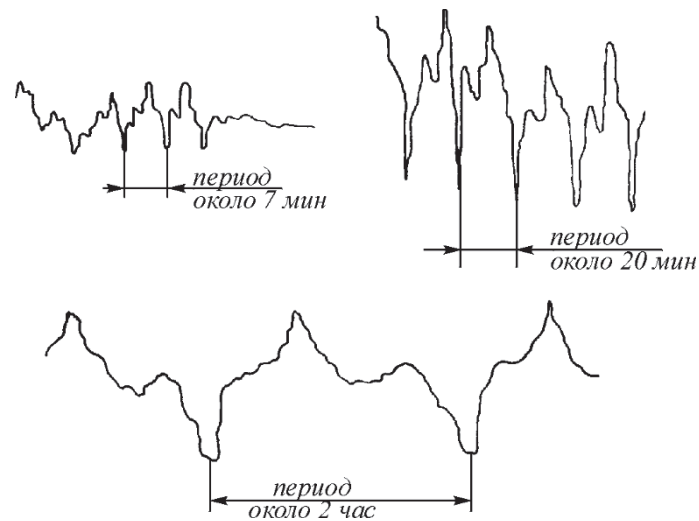

Fig. 11.17. Variations of the ether wind detected during measurements at the laser installation

From the above, there are implications of an applied nature.

1. It has now been discovered that optical and radar high-precision measurements of the positions of planets and artificial satellites give incompatible results. The discrepancy in the measurement results gives values significantly larger than it follows from the summation of the marginal errors of both methods. It seems that the reason is the failure to take into account the influence of the ether wind, which distorts the values of ranges obtained by the radar method.

2. All influences exerted by the Sun on the Earth processes occur by means of an intermediate medium - the ether. Taking into account that all processes have inertia, it can be stated that any processes on the Earth will have delays relative to changes in the ether parameters in near-Earth space caused by processes on the Sun or other influences of other cosmic bodies. According to preliminary data, the time lag in such cases may be several months, and possibly more. This means that studies and regular observations of the ether wind and ether parameters in near-Earth space can be used in the

as elements of a forecast to prevent or at least minimize the negative processes that space influences can cause on Earth. It can be confidently asserted that if there was a forecast of floods in Europe in August 2002, the leaders of the countries would have had time to take the necessary measures to prevent the damage they suffered as a result of the complete unexpectedness of what happened. Thus, the need to study the state of etheric flows and etheric wind, its speed and direction in near-Earth space acquires strategic importance.

It is also plausible that strong and time-long perturbations in the near-Earth ether could seriously affect climatic features, such as those already observed in 2002, when storms, hurricanes and heavy rains hit Europe and at the same time a drought occurred in India, which was expecting the usual monsoon showers. It can also be assumed that the remagnetization of rock layers detected by geologists in a number of areas is not a consequence of the remagnetization of the entire Earth, but only local changes associated with similar perturbations of etheric flows.

11.8. The resistance of the ether to the motion of celestial bodies

One of the basic and traditional objections to the existence of the ether is the assumption that the ether must resist the motion of the planets, with the result that this motion would cease and the planets would fall into the Sun. In this connection it seems useful to make appropriate estimates.

As it is known [58, p. 30], the resistance provided by the medium to moving bodies of spherical shape is determined by the expression

$$F = c_w \rho_3 S v^2, \quad (11.22)$$

where $c = f(Re)$; $Re = vD/\chi$ is the Reynolds number. For ether, the kinematic viscosity $\chi = 4 \cdot 10^9 \text{ m}^2 \cdot \text{s}^{-1}$.

According to the calculation, for the Sun, Mercury, Venus, Earth, Mars, Saturn, Uranus, Neptune, and Pluto for both orbital and galactic motions the drag coefficient $c_w = 0.1$, for Jupiter $c_w = 0.4$ (Table 11.1).

Table 11.1.

Heavenly Body	M , kg	S , m ²	V_{Gal} m/s	d , m	Re_r Re_o	c_w
Sun	$1,99 \cdot 10^{30}$	$1,52 \cdot 10^{18}$	$4 \cdot 10^5$	$1,4 \cdot 10^9$	$3 \cdot 10^9$ -	0,1
Mercury	$3,24 \cdot 10^{23}$	$1,79 \cdot 10^{13}$	$4,8 \cdot 10^4$	$4,8 \cdot 10^6$	10^7 $2,3 \cdot 10^6$	0,1
Venus	$4,86 \cdot 10^{24}$	$1,2 \cdot 10^{14}$	$3,5 \cdot 10^4$	$1,2 \cdot 10^7$	$2,5 \cdot 10^7$ $4,5 \cdot 10^6$	0,1
Earth	$5,97 \cdot 10^{24}$	$1,27 \cdot 10^{14}$	$3 \cdot 10^4$	$1,3 \cdot 10^7$	$2,6 \cdot 10^7$ $3,8 \cdot 10^6$	0,1
Mars	$6,39 \cdot 10^{23}$	$3,55 \cdot 10^{13}$	$2,4 \cdot 10^4$	$6,8 \cdot 10^6$	$1,4 \cdot 10^7$ $1,6 \cdot 10^6$	0,1
Jupiter	$1,9 \cdot 10^{27}$	$1,54 \cdot 10^{16}$	$1,3 \cdot 10^4$	$1,4 \cdot 10^8$	$2,8 \cdot 10^8$ $1,8 \cdot 10^7$	0,4
Saturn	$5,68 \cdot 10^{26}$	$1,05 \cdot 10^{16}$	$9,6 \cdot 10^3$	$1,1 \cdot 10^8$	$1,3 \cdot 10^8$ $1,1 \cdot 10^7$	0,1
Uranus	$8,73 \cdot 10^{25}$	$1,82 \cdot 10^{15}$	$6,8 \cdot 10^3$	$4,8 \cdot 10^7$	10^7 $3,2 \cdot 10^6$	0,1
Neptune	$1,03 \cdot 10^{26}$	$1,62 \cdot 10^{15}$	$5,4 \cdot 10^3$	$4,5 \cdot 10^7$	10^7 $2,5 \cdot 10^6$	0,1
Pluto	$5 \cdot 10^{24}$	$1,27 \cdot 10^{14}$	$4,7 \cdot 10^3$	$1,3 \cdot 10^7$	$2,5 \cdot 10^6$ $6 \cdot 10^6$	0,1

Table 10.2.

Heavenly body	F_{Gal} , kg	F_{op6} , kg	a_{Gal} , m-s ²	a_{op6} , m-c ⁻²	Δv_r per year	Δv_o per year
Sun	$1 \cdot 10^{17}$	-	$5 \cdot 10^{-14}$	-	$4,5 \cdot 10^{-12}$	-
Mercury	$1,3 \cdot 10^{12}$	$1,6 \cdot 10^{10}$	$3,8 \cdot 10^{-12}$	$5,8 \cdot 10^{-14}$	$3,2 \cdot 10^{-10}$	$3,8 \cdot 10^{-11}$
Venus	$7,8 \cdot 10^{13}$	$6,5 \cdot 10^{10}$	$1,6 \cdot 10^{-13}$	$1,4 \cdot 10^{-14}$	$1,3 \cdot 10^{-10}$	$1,2 \cdot 10^{-11}$
Earth	$9,0 \cdot 10^{13}$	$5,2 \cdot 10^{10}$	$1,5 \cdot 10^{-13}$	$8,5 \cdot 10^{-15}$	$1,2 \cdot 10^{-10}$	$8,5 \cdot 10^{-12}$
Mars	$2,4 \cdot 10^{12}$	$3,8 \cdot 10^{10}$	$3,8 \cdot 10^{-13}$	$5,8 \cdot 10^{-14}$	$3 \cdot 10^{-10}$	$7,8 \cdot 10^{-12}$
Jupiter	$3,8 \cdot 10^{15}$	$4,8 \cdot 10^{12}$	$1,9 \cdot 10^{-12}$	$2,6 \cdot 10^{-15}$	$1,6 \cdot 10^{-10}$	$2,5 \cdot 10^{-12}$
Saturn	$6 \cdot 10^{14}$	$4 \cdot 10^{11}$	$1,7 \cdot 10^{-12}$	$8 \cdot 10^{-16}$	$8,5 \cdot 10^{-11}$	$2,5 \cdot 10^{-12}$
Uranus	$7,8 \cdot 10^{13}$	$3,8 \cdot 10^{10}$	$1,5 \cdot 10^{-12}$	$4 \cdot 10^{-15}$	$1,2 \cdot 10^{-10}$	$2 \cdot 10^{-12}$
Neptune	$1,1 \cdot 10^{14}$	$2,1 \cdot 10^{10}$	$1,1 \cdot 10^{-12}$	$2 \cdot 10^{-16}$	$8 \cdot 10^{-11}$	$1,2 \cdot 10^{-12}$
Pluto	$9 \cdot 10^{12}$	$1,2 \cdot 10^9$	$1,8 \cdot 10^{-12}$	$2,5 \cdot 10^{-16}$	$1,5 \cdot 10^{-10}$	$1,6 \cdot 10^{-12}$

The deceleration of the bodies will be

$$a = -F/M, \quad (11.23)$$

whence the change of velocity for the time Δt is:

$$\Delta v = a \Delta t. \quad (11.24)$$

Tables 11.1 and 11.2 summarize the data calculated for the Sun and for the major planets of the solar system.

As can be seen from the tables, the change in the velocity of the planets per year is insignificant for this stage - the galactic velocity change is about $10^{-10} \text{ year}^{-1}$, the orbital $10^{-11} - 10^{-11} \text{ year}^{-1}$ from the current value, which, of course, cannot be detected by direct measurements. It should also be noted that the velocity deceleration should be exponential in nature, i.e., the process may last much longer than the direct extrapolation suggests. In addition, we should not forget that the calculations take into account only one factor of resistance, while the full picture may be much more complicated and may help to reveal not only the factors of slowing down the motion of celestial bodies, but also their acceleration.

11.9. Comets

Comets (from Greek kometes - a star with a tail, lit. long-haired) - bodies of the Solar System, having the appearance of nebulous objects, usually with a light clot - a nucleus in the center and a tail. The number of comets in the solar system is extremely large and reaches hundreds of billions. However, only a small number of comets entering the orbit of Jupiter are available for observation. Comets are observed when its nucleus - a small icy body - approaches the Sun at a distance of less than 4-5 astronomical units, i.e. at a distance of about 600-750 million kilometers. Then it is heated by the Sun's rays, and gas and dust begin to be emitted from the core. This is the opinion of scientists [59-63].

Unlike planets, comets move along elongated trajectories, approaching close to Earth and other planets, but the far side of the orbit - aphelion - many comets go far beyond the solar system. And some comets do not return to it at all.

By 1971, about 1 thousand systems of comet elements had been calculated, and the results of calculations were summarized in appropriate catalogs.

There are short-period comets with a period of orbit around the Sun of less than 200 years and long-period comets with a long period. Comets possessing hyperbolic orbits, moving away from the Sun, leave the Solar System forever, going into interstellar space.

Comets are often accompanied by meteor streams and even showers, when a whole swarm of "shooting stars" falls on the Earth. However, only a few of them reach the Earth; they are called bolides, while most of the "stars", which are actually small particles, burn up in the upper atmosphere.

Modern scientists envision comets as a dense "head" and a rarefied gas tail. Most comets have a star-shaped or diffuse bright nucleus in the middle of the head, which is the glow of the central, densest zone of gases around the comet's true nucleus.

According to modern ideas, comet nuclei consist of water gas with admixture of "ices" of other gases (CO_2 , NH_3 , etc.), as well as stony substances. Dust particles are partly emitted from the nucleus by evaporation of the ices, partly formed in its vicinity by subsequent condensation of the vapors. The gas and dust create a misty shell around the nucleus, the comet's atmosphere, sometimes called the coma, which together with the nucleus forms the comet's head. The head of the comet and its tails do not have sharp outlines.

The atmosphere of a comet is continuously dispersed in space and exists only when there is a release of gases and dust from the nucleus. Under the action of light pressure and solar wind - streams of particles emitted by the Sun, gases and dust are carried away from the nucleus, forming comet tails.

The gas tail is thought to appear on a comet as it approaches the Sun. Astronomers believe that the gas itself is the result of vaporization of the comet's body under the influence of sunlight. Sunlight repels the gas and particles emitted by the comet, and a "tail" is formed. True, there are comets with two "tails", one directed away from the Sun, and the second - to the Sun, more precisely, forward in the direction of motion of the comet. And there are more "tails", and they are scattered in a fan, here the Sun as if and nothing to do.

Observations have shown that comets quickly lose substance and the most persistent of them live no more than have time to make a few thousand revolutions around the Sun, this time is extremely short from a cosmogonic point of view. But there are billions of them in the solar system,

astronomers report to the general public only a few of them, those that can be observed with the naked eye.

All of the above raises the following questions:

1. What is the origin of comets?
2. Why do comets have elongated orbits that are dramatically different from those of planets, how could such orbits have formed?
3. Do comets go through any stages of evolution in their existence?
4. What explains the fact that groups of meteorites are soon found in the place of comets?

Other questions may be asked.

Modern science has put forward two hypotheses about the origin of comets. According to the first of them, put forward by Soviet astronomer S.K.Vsekhsvyatsky, comets are the results of powerful volcanic eruptions on large planets and their satellites. According to the second hypothesis, put forward by Dutch astronomer J. Oort, comets come from a giant cometary cloud surrounding the solar system. This cloud extends to huge distances - up to 150 thousand astronomical units and was formed at the same time as all the planets. Here, however, it becomes incomprehensible the existence of short-period comets, orbiting inside the solar system within the orbit of Jupiter. But this is written off to the perturbing action of the planets. However, the first hypothesis is not confirmed by statistics, and the second hypothesis is not confirmed by astronomical observations.

A hypothesis about the origin, structure and evolution of comets, different from the above-mentioned ones, can be expressed from the positions of ether-dynamics.

As it was shown above, all celestial bodies absorb ether from the surrounding space, which enters them on average with a velocity equal to the second cosmic velocity, for the Earth it is equal to 11.18 km/s. Due to the absorption of aether, all celestial bodies increase their mass and expand. Absorption of ether is distributed unevenly over the surface of bodies, as different parts of the surface of planets due to the presence of different rocks have different ether dynamic resistance, so the accumulation of ether in the depth of the body is uneven. Partially accumulated ether is recycled into matter, and part of it is accumulated in deep layers, creating in some places excessive pressure held by rocks having high ether dynamic resistance, such rocks are any conductive rocks.

The accumulation of ether pressure cannot continue indefinitely. It starts either seeping outward, swirling and creating so-called geopathogenic zones, or, if the accumulation of ether goes faster than resorption, the rocks holding ether break through, and then the jet of ether goes outward through rocks that have a high dielectric constant and because of this are ether conduits, i.e. channels with low ether dynamic resistance. Such rocks are any non-porous insulators.

After the jet of ether from the insulator rushes outward, it collides with empty space, in which dielectric permittivity is equal to one, and the ether dynamical resistance for the jet sharply increases. This is enough for the jet to first expand and then curl into a toroid, its edges touching the surface of the Earth, whose rocks have dielectric permittivity higher than that of free space. This contributes to the completion of the formation of the etheric toroid, which now includes the surface rocks.

The etheric toroid is a stable and energy-intensive system. The gradients of etheric flows inside the toroid create forces sufficient to detach and hold the matter detached from the Earth's surface in it. The ether toroid itself, like any gas toroidal vortex, is repelled from the environment by its external surface and moves in space in the direction in which the ether flows move in its center, i.e. in the same direction in which the ether moved in the jet that formed the toroid. Thus, the ether jet that burst out of the planet's interior will form a toroidal vortex on its surface, which will take the rock in it into its body, a part of it will pass through the top of the toroid and scatter around the circumference in the form of a circular shaft, a small part of it will gather in the center in the form of a slide, and the rest will be dragged away with it (Fig. 11.18, *a*). Further everything will depend on what force and what power was the initial aether jet.

If the power was relatively small, the toroid after formation (Fig. 11.18, *b*) will quickly lose stability. Then there will be an explosion with the scattering of the matter and ether jets. The gradients of ether streams will create forces that will produce destruction, and along the axis of jets the forces will be directed toward the ether movement, and near the jets the direction of forces will be toward the jets. The forces can be very large, sufficient to destroy rocks, buildings, and forests.

If the power of the initial jet is large, the toroid together with the matter will escape into outer space, and a new comet will appear in space. Possessing, like any gas vortex, self-motion, the toroidal vortex of ether, repelling from the surrounding ether, will gradually increase its velocity and orbital momentum, moving to an increasingly elongated orbit until its energy is exhausted (Fig. 11.18, c).

At the same time, the toroidal vortex will be formed into a tube-type formation closed to itself. The matter collected by it will be concentrated in the walls of this tube, since it is in them that the gradient of toroidal velocity is maximal, hence, all matter will be sucked into these walls. The boundary layer of ether on the surface of the tube will not allow either the ether or the entrapped matter to scatter. However, until the ether vortex begins to lose its energy due to diffusion and due to conversion of rotational energy into energy of translational motion.

Further evolution of the comet is associated with the loss of energy by the ether vortex due to the viscosity of the ether and the transformation of its toroidal rotation energy into the energy of the comet's translational motion, with the sublimation of the substance captured by the comet and with a number of other factors, the full accounting of which requires separate studies. However, even here we can make several assumptions.

The matter captured by the toroidal vortex is subjected to grinding inside the vortex, as there are gradient flows of aether and large forces that tear the matter. These forces can be so great that the tearing of the substance can occur not only at the molecular or atomic level, but also at the nuclear level. Therefore, within the ether toroid can occur transmutation of substances and elements, probably, this explains the elemental composition of meteorites, in which the increased content of iron is due to the highest value of the binding energy of nucleons in the atomic nucleus of iron (at. weight $56 = 14 \alpha$ particles) compared to the nuclei of other elements to the left and right of it in the periodic table, as well as the increased content of SiO_2 (at. weight $28 + 2 \times 16 = 7 + 2 \times 4 \alpha$ particles) and MgO (at. weight $24 + 16 = 6 + 4 \alpha$ particles). The presence of other elements - aluminum, calcium, oxygen, silicon, magnesium, nickel and sulfur is also explained by the relatively high specific binding energy of nucleons in even nuclei, although somewhat lower than that of iron. It does not matter what composition of elements was captured by the comet at the time of its birth.

If part of the rotational energy of the vortex is lost, the boundary layer on the surface of the vortex weakens, and it begins to pass through the accumulated matter. In this case, a part of the ground dust-like matter is thrown back by the vortex, and the comet forms a "tail", which will become visible when the comet approaches the Sun (Fig. 11.18, *d*). If the energy losses increase, the boundary layer in the central part of the toroid will be eroded and will no longer hold the matter. Then a part of the crushed matter is *ejected* forward at high speed, and the comet has a front "tail" in addition to the rear one (Fig. 11.18, *e*). And if the energy losses become even greater, the matter will begin to scatter in all directions (Fig. 11.18, *f*). This means that the comet is close to death.

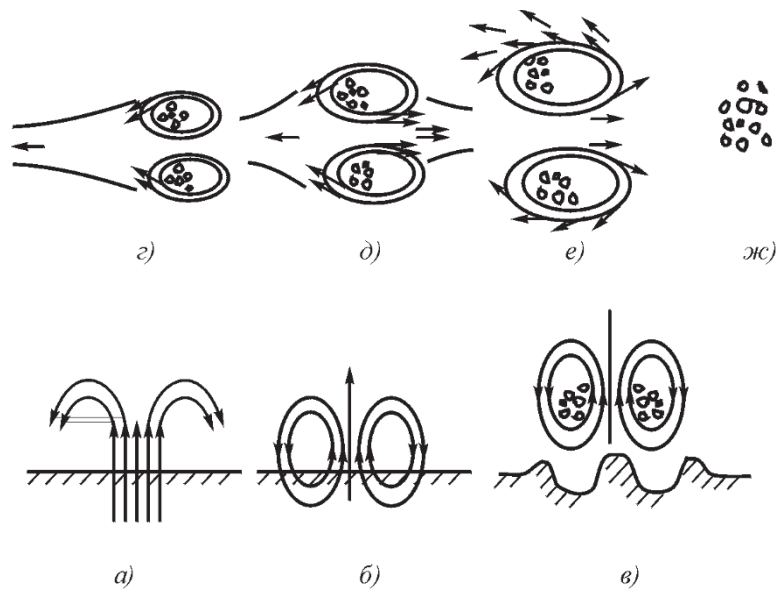

Fig. 11.18. Formation of a comet: *a)* initial stage; *b)* formation *c)* exit of the comet into space; *d)* formation of the rear "tail"; *e)* formation of the front "tail"; *f)* scattering of matter; *g)* meteor stream left after the comet

As the vortex slows down its rotational speed when it loses energy, large formations of matter are future meteorites,

captured by the inner part of the vortex, will gather together, as it happens with teas after stirring tea in a glass. After complete dissolution of the etheric vortex in place of the comet will be only a swarm of meteorites, which no longer increases the orbital momentum, does not produce any transmutations, and just flies by inertia along the same orbit. And the comet is dead. However, since the disintegration of the comet is a gradual process, the meteor stream and its parent comet can coexist for a long time (Fig. 11.186, g).

The matter accumulated by the comet becomes a swarm of meteorites. Thus the Leonid meteor stream, annually visible on November 15, in 1866 was identified with the orbit of a weak comet, which soon disappeared. Later, eight meteor streams - Lirids, Aquarids, Perseids, Jakobinids, Orionids, Taurids, Leonids, Bielids, appearing annually, were confidently identified with comets [46, p. 285-292].

It seems that such a version has the right to exist. On photos of comet Hiyakutaki, received in the Main Russian Observatory of the Academy of Sciences by researchers I.S.Guseva and N.A.Sokolov in the period from March 14 to 21, 1996 (see the newspaper. "Anomaly" No. 11 (119), 1996, p. 5), the toroidal structure of the comet is clearly visible (Fig. 11.19, a). There are also photographs of comets at different stages of development (Fig. 11.19, b-d).

Ether toroids are born by planets, apparently, quite often, but on the Earth it happens more often in the ocean than on land. Firstly, the surface of the oceans is twice as large as the land surface. Secondly, the bottom of oceans is thinner, and dielectric permittivity of water is high, so that conditions for the passage of etheric jets and for the formation of vortex toroids are better here. There are numerous testimonies of sailors about how some gray-colored and saucer-shaped UFOs burst out of the water and go upwards. Are these not future comets? And isn't that why the nuclei of most comets that the Earth encounters are composed of ice? But there is evidence of another kind, when large closed vortex formations are seen under water at great depths. Could these be toroids too, but they didn't have enough energy to move further and got stuck in the water? There have been similar cases on land. There are many dozens of such formations on Earth. In the North there are many round lakes into which no rivers flow. In the town Sasovo of the Ryazan region on April 12, 1991 at night a funnel with a diameter of 28 m and a depth of about 4 m was formed. In the process, 1,800 tons of rock disappeared, and in the surrounding windows and doors were squeezed outward [64] (Fig. 11.20).

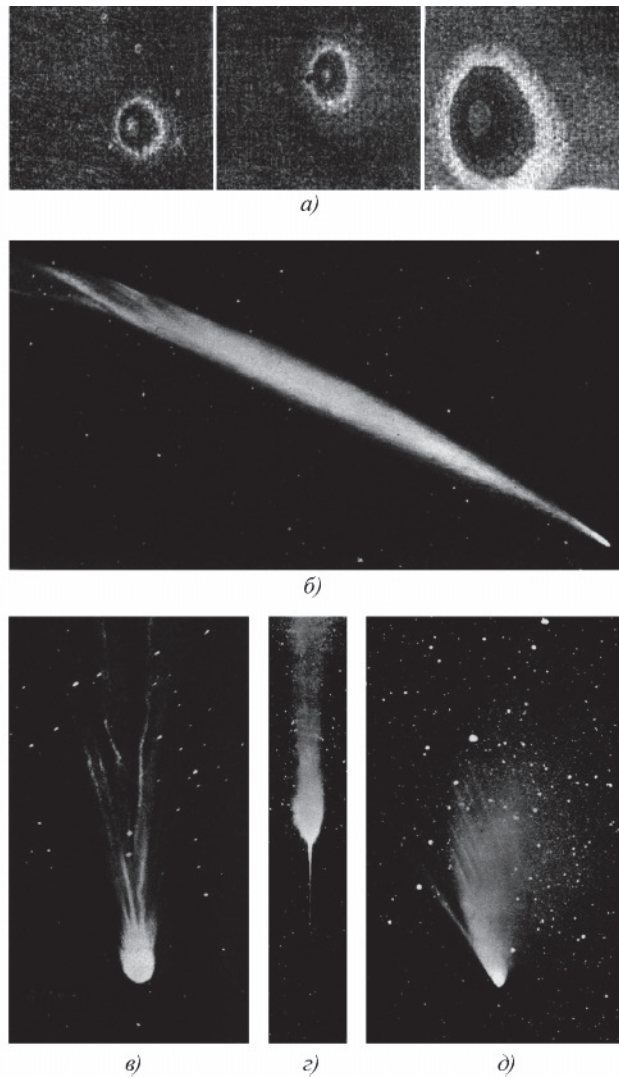

Fig. 11.19. Photos of comets: *a* - Hiyakutaki comet, 1996, the toroidal structure is clearly visible; *b* - Ikea-Seki comet, 1965, the comet has a spindle-shaped rear "tail"; *c* - Ikea comet, 1963, *d* - comet Arenda-Rolan, 1957, the comet has a front sharp tail; *e* - comet Marcos, 1957, the substance is dissipating, the comet is close to death.

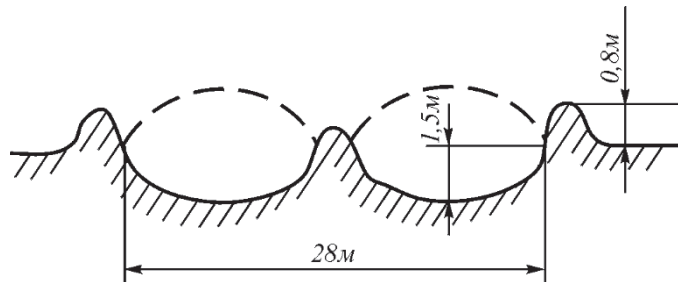

Fig. 11.20. Structure of the Sasovskaya funnel

This is also evidenced, for example, by the Puchezh-Katun astroblema, which was formed about 175 Ma ago and has a total diameter of 80 km, in which, according to gravimetric surveys and seismic profiling, there is an annular trough with an outer diameter of 40-42 km and a depth of up to 1.6 km in the eastern sector and up to 1.9 km in the western sector. There is a central uplift known as the Vorotilov Ridge, which has a diameter of 8-10 km in the arch part and 12-14 km at the base and rises 1.6-1.9 km above the bottom of the annular trough, with steep slopes at its base estimated at 35° - 40° . The apical part of the uplift is a flat annular vault with a height difference of up to 200 m, in the center of which there is a depression 3x5 km in size and up to 525 m deep [65] (Fig. 11.21).

And what can be said about the Moon, on the surface of which there are hundreds of "astroblems" with diameters of many tens and hundreds of kilometers? All of them have circular shafts, partially destroyed due to large temperature differences ($+110^{\circ}\text{C}$ during the day, -120°C at night), at least 10% of them have preserved the central slide (Fig. 11.22).

A similar phenomenon on the Moon in the area of the crater Alfons, lasting only about 3 minutes was observed in November 1958 by the famous astronomer N.A.Kozyrev, which he confidently attributed to a volcanic eruption, but which could not be such at least by virtue of its short duration. Similar phenomena have been repeatedly observed on Mars in the form of the brightest flash of atomic-hydrogen level of luminosity with the expansion of the light spot to several tens of kilometers within a few seconds.

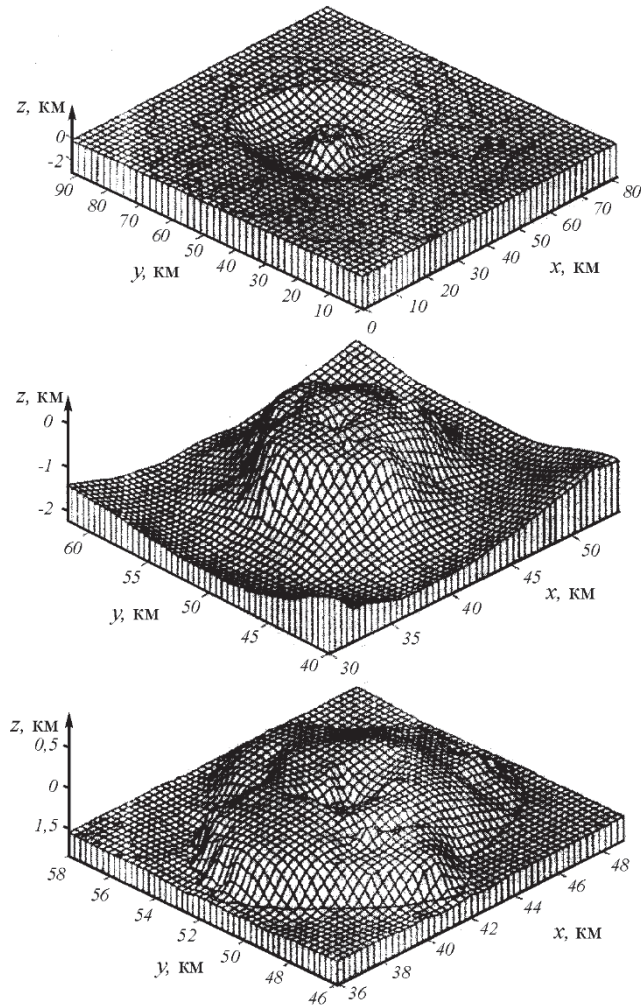

Fig. 11.21. Relief of the surface of the true bottom of the Puchezh-Katun impact structure: *a* - astrobomb as a whole; *b* - central uplift; *c* - vault of the central uplift above the 0.5 km isohypsis. The ratio of vertical and horizontal scales is 1:3.



Fig. 11.22. The surface of the Moon in the first quarter (based on the drawing by Czech astronomer I. Klepešta)

It is possible that the famous "Tunguska meteorite" of 1908 was not a meteorite at all: after all, no traces of the meteorite itself have never been found, and the forest fell and the relief of the surrounding area resembles in its shape an astroblema, maybe not as large as Puchezh-Katunskaya, but still And all this happened directly above the geological fault discovered later.

If we take into account that there are only about 150 large astroblems on the entire land surface of the Earth, and if we assume that all of them have an age less than Puchezh-Katunskaya, it turns out that each large astroblem appears no more often than once in a million years. But small astroblems like Sasovskaya appear much more often.

Thus, the stated ether-dynamic hypothesis about the essence, origin and evolution of comets seems probable.

11.10. Resolution of cosmological paradoxes in ether dynamics

When constructing cosmological theories and models, the question always arises about the solvability of the so-called cosmological paradoxes - difficulties, contradictions arising when the laws of physics are applied to the Universe as a whole or to rather large areas of it. Thus, when the Second Beginning of Thermodynamics was applied to the Universe, the conclusion about the inevitability of heat death was made in the past; the age of the Metagalaxy in the theory of non-stationary Universe up to the 50s of the 20th century was less than the age of the Earth. However, the cosmological paradoxes are usually understood as three specific paradoxes arising from the cosmological application of the laws of classical (Newtonian) physics: thermodynamic [66, 67], photometric Schezo-Olbers, named after the Swiss astronomer Schezo (1744) and the German astronomer Olbers (1826) [68], and gravitational Neumann-Seliger [70], named after the German scientists. These paradoxes are considered to be overcome by relativistic cosmology, but relativistic cosmology itself comes into contradiction with the ideas about space and time as general physical invariants.

Let's consider the resolution of the listed paradoxes from the positions of ether-dynamics.

Thermodynamic paradox. **The thermodynamic** paradox of Clausius (1865) was formulated by him on the basis of the Second Principle

of thermodynamics [66]. According to the Second Principle, any physical system that does not exchange energy with other systems (for the Universe as a whole, such an exchange is apparently excluded) tends to the most probable equilibrium state with entropy maximum. Therefore, all kinds of energy in the Universe, in the end, should pass into the energy of thermal motion, which will be uniformly distributed over the substance of the Universe, after which all macroscopic processes will cease in it. This reasoning is based on the assumption that no motion can spontaneously reverse itself. This is true, but only with respect to each separate form of motion of matter localized in one particular region of space.

Boltzmann hypothesized that the Universe is in a state of thermodynamic equilibrium, but by the laws of chance there are sometimes deviations from this state in one place or another. These deviations are less frequent, the larger the area they cover, the larger the deviations themselves [67].

Such an attempt to explain the absence of "Heat Death" in the Universe cannot be recognized as satisfactory for many reasons, in particular, because the very concept of randomness is only an unrecognized regularity and not a principle of nature's structure. Any deviation from the equilibrium position must be causal and have its own internal mechanism. Therefore, the solution proposed by Boltzmann is just an attempt to push the explanation to another level of the organization of matter.

The relativistic explanation of the absence of Heat Death is based on the principles of non-stationarity of the Universe, which implies the beginning of its creation, and cannot be recognized as satisfactory.

Ether-dynamics approaches to the considered problem in a fundamentally different way, and the explanation of the absence of "Heat Death" in the Universe on the basis of its representations turns out to be relatively simple.

As shown above, there is a circulation of the ether in the Galaxy, and there are two regions separated in space, in which different processes take place: in the galactic core there is a process of vortex formation, accompanied by a decrease in the ether temperature in this region, and at the periphery there is a process of vortex dissolution, accompanied by a spontaneous increase in the medium temperature and pressure.

There is no doubt that the total balance of energy at both levels of matter - at the level of ether and at the level of matter particles - is constant in the sum, the energy is only transformed from the form of ordered motion in each vortex into the form of chaotic motion in free ether, which then moves in the spiral arms of the Galaxy from the periphery to the core. In the nucleus, the reverse process takes place: the forward motion of large masses of ether and its chaotic motion are transformed into rotational motion.

The entropy increase at the level of matter particles loses its meaning after vortices decay at the periphery of the Galaxy. The entropy increase in the free ether loses its meaning after the vortices form in the Galaxy's core. Thus, as Boltzmann supposed, the total entropy of the Universe is constant, but this constancy is traced at the level of the ether and is maintained not due to spontaneous "random" deviations, but due to the presence of a mechanism of transformation of the forms of ether motion in galaxies. A stable galaxy acts as an entropic unit maintaining entropy at a constant level.

In both movements of matter - in the form of matter from the galaxy nucleus to its periphery and in the form of free ether from the galaxy periphery to its nucleus - entropy grows, but in these extreme regions the form of existence of matter changes qualitatively.

All the radiation that pervades the universe eventually decays, and its energy goes into the free ether, from which in some other realms this energy has been taken up.

Thus, the thermodynamic paradox in ether-dynamics is solved in a rather simple way, not requiring any artificial constructions.

Photometric paradox. **The** photometric paradox of Shezo-Olbers consists in the fact that with a homogeneous structure of the Universe and its infinite length in space, the whole sky for an observer from the Earth should be represented as a sphere brightly shining with light similar to the Sun [68]. In reality, there is no such phenomenon, and this is the essence of the paradox.

Indeed, if we put the density of distribution of stars in space q , then the number of stars dn enclosed in a spherical layer of radius r and thickness dr is

$$dn = 4\pi r^2 q dr \quad (11.25)$$

The area covered by the stars,

$$dS = 4\pi r^2 q \eta dr, \quad (11.26)$$

where η - coefficient is the coefficient of between area proportionality of the cross section of stars and their number.

The solid angle from the center of the sphere is

$$d\gamma = 4\pi q \eta dr = d\alpha \quad (11.27)$$

where

$$d\alpha = q \eta dr, \quad (11.28)$$

Taking into account that from the subsequent layer a part of stars is covered by the previous layer, we find the solid angle for the n -th layer:

$$d\gamma_n = 4\pi d\alpha (1 - d\alpha)^n. \quad (11.29)$$

Summing up all angles from the first to the n -th layer of stars by the rules of geometric progression, we obtain the total angle

$$S_n = 4\pi d\alpha \frac{[1 - (1 - d\alpha)]^n}{1 - (1 - d\alpha)} \approx 4\pi [1 - (1 - d\alpha)]^n. \quad (11.30)$$

Considering that

$$n = r/dr, \quad (11.31)$$

where r is the radius of the sphere encompassing all considered stars, and taking r to infinity, we obtain

$$S = 4\pi, \quad (11.32)$$

i.e. the starlight covers the whole sphere. Nevertheless, it is clear from experience that in fact stars do not fill the whole celestial sphere.

The above reasoning is an example of a purely mathematical approach to solving the problem, abstracting from a series of physical phenomena that take place in the real world, are very significant, but are not taken into account in any way in the above solution.

Indeed, since the solid angles of two different stars at different distances from the observer relate to each other as squares of the distances:

$$\delta / \delta_{12} = r_1^2 / r_2^2, \quad (11.33)$$

and the light fluxes coming from the stars are also inversely proportional to the squares of distances, it would seem that the specific brightness of both stars in the sky is the same. In fact, nothing of this kind can be.

The interstellar medium is not absolutely transparent. It is known that interstellar space contains irregularly distributed clusters of interstellar gas, mainly hydrogen, and interstellar dust. The average density of interstellar matter varies within 0.1-10 particles per each cubic centimeter [69]. Because of this, there is absorption of light by the interstellar medium; the average value of this absorption is 0.8 per 1000 ps (1 ps = $3.086 \cdot 10^{16}$ m). The interstellar absorption is inversely proportional to the first degree of wavelength, i.e., it is non-uniform in emission frequencies. And besides, re-radiation by the interstellar medium of the received energy back into space occurs at other wavelengths.

Taking into account only these circumstances shows that the light of a more distant star will be absorbed more strongly than the light of a closer star, and the same brightness of all stars will not be obtained on the firmament. At large differences of distances exactly the same picture should be observed as actually existing: closer stars shine brighter. Stars at far distances will be seen very faintly, which will be manifested outwardly in the form of dark parts of the sky. If to remember about "red shift" of spectra of stars, about nonlinearity of light absorption by interstellar medium, connected, in particular, with quantum phenomena, partial polarization of light, etc., it becomes clear that the paradox of Shezo-Olbers is not physical, but abstracted from real reality purely mathematical phenomenon, just emphasizing that abstractly mathematical approach is not good in all cases.

It is expedient to note some additional circumstances, which follow not from the known facts, but from the ether-dynamic model of light, and which in fact can play a decisive role.

As has already been shown, in 10 billion years a photon loses energy by e times. It means that during the time, the order of which is close to the named value, the photon first largely loses its properties of rectilinear and uniform motion in space by analogy with a smoke ring, which begins to slow down, and then stops and diffuses, having ceased to exist as a vortex formation.

If, as noted earlier, the relic radiation observed in space represents photons at the limit of their existence, then it is logical to assume that photons from sufficiently distant stars located from the Earth at distances substantially greater than 10 billion light years do not reach the Earth observer at all. In turn, this means that optical astronomy has a natural limit to the detection of objects at range. Distant objects simply will not be visible.

Thus, the cosmological paradox of Shezo-Olbers in ether-dynamics is solved quite naturally.

Gravitational paradox. The Neumann-Zeliger gravitational paradox is related to the attempt to apply the Newtonian theory of universal gravitation to a stationary and homogeneous model of the Universe [70]. If we proceed from Newton's law of attraction of bodies

$$F = G \frac{M M_{12}}{r^2} \quad (11.34)$$

and visualize it as a result of manifestation of the potential ϕ of the body of mass M_1 , so

$$\phi = G \frac{M_1}{r}, \quad (11.35)$$

then the gravitational interaction energy will be equal to

$$U = - G \frac{M M_{12}}{r} = M_2 \phi. \quad (11.36)$$

Summing up the energy over all masses in the Universe, we obtain that for any body the gravitational energy of its interaction with all the

masses in the infinite Universe is infinite, and the force of interaction of a body with all masses of the Universe is uncertain. Hence the conclusion about practical impossibility of application of the Newtonian theory of gravitation to the stationary homogeneous cosmological model of the Universe existing in Euclidean space is made.

Such reasoning also has an abstract-mathematical character abstracted from reality, approximately the same as reasoning about the potential as about the work to be done in moving a body from infinity to a given point of space. Only potential difference can be a real physical concept.

There is no need to determine the energy of all gravitational interactions with all masses of the Universe, since the interactions of all these masses are mutually balanced with respect to any body. The body will be influenced only by the bodies close to it, that is what really takes place. Potentially balanced energy cannot manifest itself in any way, so the mathematically calculated value of the gravitational energy of interaction of a body with all the masses of the Universe has no value.

But, in addition, from the ether-dynamic approach to the law of gravitation it is seen that the form of this law must differ from the Newtonian law and have the following form:

$$F = -G \frac{MM_{12}}{r^2} F(r, t). \quad (11.37)$$

The function $F(r, t)$ contains the Gauss integral and at small distances it is practically equal to 1, and starting from some distance it sharply decreases, so it follows from this expression that the real law of attraction has a nonlinear character and with increasing distance between the interacting masses the interaction decreases faster than the value inversely proportional to the square of the distance. Consequently, there is no place even for the above mathematical abstractions and, as well as in the case of the photometric paradox, the gravitational paradox should be considered purely mathematical, caused by the authors' failure to take into account the physical conditions of the interaction between bodies.

Thus, in the ether-dynamic model of the Universe the cosmological paradoxes are solved naturally in the framework of the

ideas about matter, space and time as basic and universal physical invariants.

Conclusions

1. The aether dynamical ideas about the essence of physical phenomena allowed us to develop a model of a stationary dynamical Universe with a stable aether circulation. Within the framework of this model, we developed a model of a stable spiral galaxy with local aether circulation and a model of aether exchange between galaxies - newly formed and decaying. On this basis, the principle of functional classification of galaxies is proposed, taking into account the circulation and transformation of the forms of ether motion in the Universe. The entropy of the Universe is kept at a constant level, and the existence of the Universe is eternal.

2. The hidden mass of the ether concentrated in galaxies and intergalactic space exceeds the mass of the ether concentrated in the substance of stars and interstellar matter by several orders of magnitude, the pressure of the ether in free space essentially determines the properties of the basic particle of the Universe - the proton, and through them - the properties of matter, stars and stellar formations of all levels.

3. The origin and evolution of stars are based on the properties of the proton formed in the centers of vortex formation of the aether and diffusing after the exhaustion of the stability reserve.

4. The developed ether-dynamic model of the origin and development of the Solar System allows us to explain in a natural way the main features of its structure and parameters - the concentration of the main mass of the system in the Sun, and the orbital momentum in the planets, the coincidence of the orbital plane of the planets and the equator of the Sun, the direct direction of the Sun's rotation, the orbital motion of the planets and the rotation of the planets and their satellites around their axes.

5. The aether, due to its viscosity, resists the motion of celestial bodies. However, this resistance is relatively small, and the time constant of celestial bodies' velocity change for orbital and galactic motions is about 3-30 billion years.

6. The Earth, as well as all celestial bodies, continuously absorbs the ether of the cosmic space, due to which it expands, in it there is a formation of new substance from the absorbed ether, which goes outward in the form of rift ridges. This is the same reason why

subduction of the seafloor under continental plates, spreading of continents, continuous growth of tension in the Earth's crust, mountain formation and earthquakes. Presumably, the absorption of ether by rotating celestial bodies is the cause of their magnetic field.

7. The ether wind blowing the Earth leads to uneven distribution of the ether pressure over the Earth's surface: in the North the ether pressure is greater due to the inhibition of the ether flow, in the streamline zone it is less due to the presence of the velocity gradient, in the Southern Hemisphere the ether flow is detached and a connected toroidal vortex is formed, which captures the air in winter. Taking into account the blowing of the Earth by the ether wind, as well as the entire solar system, allows us to explain all the main features of the Earth's shape - elongation to the north, the presence of a large land surface in the Northern Hemisphere and some phenomena such as a colder climate and the presence of the ice continent of Antarctica, the occurrence of storms in winter in the area of "roaring forties" latitudes.

8. The main cosmological paradoxes - thermodynamic ("Thermal Death"), photometric Shezo-Olbers, gravitational Neumann-Seliger - are solved naturally when using the ether-dynamical representations. The thermodynamic paradox is solved by taking into account two processes of transformations of the forms of ether motion separated in space - in the core of the spiral galaxy due to the transformation of free ether into protons, on the periphery of the spiral galaxy due to the transformation of protons into free ether, while the entropy of the spiral galaxy remains constant on average. For the resolution of the photometric paradox it is enough to take into account the "Redshift" of photons. For the resolution of the gravimetric paradox it is enough to take into account the nonlinearity of the real law of gravitational interaction of masses.

Conclusion

As follows from the above, the involvement of hidden forms of matter motion allows us to understand the structures of material entities from elementary particles of matter to galaxies, the essence of basic fundamental interactions and even to predict new ones, to reveal the mechanism of the most heterogeneous physical phenomena. The dynamic approach to the study of natural phenomena turns out to be in many respects more fruitful than the generally accepted phenomenological approach.

A natural question arises: why, with respect to the theory of the ether, such attempts, which have been numerous throughout the history of natural science, have not been successful before? The answer is simple: having no data on the behavior of elementary particles - the last stage of matter organization on the way to the ether particles at their interactions, one could only guess about the properties of their parts. The data obtained in the 60s of the last century gave the missing information. Only after that it was possible not only to guess or postulate properties of particles' parts and properties of their aggregate - the world medium, but to determine them precisely on the basis of analysis of the most general properties of micro- and macrocosm. It should be kept in mind that if this attempt had not been preceded by the work of many generations of researchers and if in the related fields - gas and hydrodynamics - extensive material had not been prepared by the same time, it would have been impossible to fulfill this task.

The material presented here is only the basics of the dynamic theory of matter, its beginning. There is no doubt that further investigations will lead to the development of this direction. Along with the development of the general ether-dynamics proper it is quite right to expect the appearance of the private directions, such as, such as ether-cosmology, ether-astronomy, ether-electrodynamics, ether-chemistry, ether-biology, etc., because each branch of science nowadays needs most of all to understand its processes, to reveal internal mechanisms of phenomena, internal processes of self-regulation, which can be done only by attracting hidden motions of matter - ether motions. The formation of ether-dynamics is not simple. It is understandable, because it does not fit into modern fashionable theories. However, there is no doubt that ether-dynamics belongs to the future, as always the development of natural science went according to the levels of organization of matter, and the modern stage is not a exceptions.

*Literature.**To Chapter 1.*

1. Lenin V.I. Materialism and empiriocriticism. Complete Collected Works - 5th ed. Vol. 18.
2. Atsyukovsky V.A. Materialism and Relativism. Critique of methodology of modern theoretical physics. Moscow: Energoatomizdat, 1992; Izdvo "Engineer", 1993.
3. Einstein A. The principle of relativity and its consequences. *Sobr. nauchn. tr. M.: Nauka. 1965. VOL. 1. P. 138-164.*
4. Fizeau H. *Compt. Rend. 1851. Vol. 33. P. 349-355; Ann. d. chim et phys. 1859. Vol. 57. P. 385-404.*
5. Michelson A.A. The relation motion of the Earth and the Luminiferous Aether. *Amer. J. of Sci. (3). XXXII.1881.*
6. Michelson A.A., Morley E.W.. The Relative Motion of the Medium on the Velocity of light. *Ibid. (3). XXXII.1886. P. 337; The Relative Motion of the Earth and the Luminiferous Aether. Ibid. (3). XXXIV.1887. P. 333..*
7. Einstein A. Aether and the theory of relativity (1920). *Sobr. nauchn. tr. M.: Nauka, 1965. VOL. 1. P. 682-689.*
8. Einstein, A. On the Ether (1924) *Ibid, vol. 2. C. 154-160.*
9. Atsyukovsky V.A. Logical and experimental foundations of the theory of relativity. Analytical review. Moscow: Izd-vo MPI, 1990; Critical analysis of the foundations of the theory of relativity. Analytical review. - 2nd ed. Zhukovsky: Izdvo "Petit", 1996.
10. Under the Banner of Marxism. 1938, № 1.
11. Sonin A.S. "Physical Idealism". History of one ideological campaign. M.: Izd. v izd. of phys. - mat. litt. 1994.
12. Vizgin V.P. Nuclear shield in the "thirty-year war" of physicists with ignorant criticism of modern physical theories. *UFN № 12, 1999. C. 1263-1389.*
13. Frenkel Ya.I. At the dawn of new physics. L.: Nauka. 1970. C. 136-146, 169-171.
14. Engels F. Dialectics of Nature. K.Marx and F.Engels. Op. -2-. ed. Moscow: Gospolitizdat, 1961. T. 20. C. 433-485.
15. Gastev Y.A., Esenin-Volpin A.S. Postulate. BSE, -3 ed, M.: Izdvo "Soviet Encyclopedia", 1975. Vol. 20, p. 423.
16. Lenin V.I. On the importance of militant materialism. Full. sobr. op. 5-th ed. Vol. 45. C. 23-33.

By Chapter 2.

1. Religions of the World. CH. I. Beliefs of Antiquity. Religions of Iran, India. Judaism. Buddhism. 1997; CH. II. Religions of China and Japan. Christianity. Islam. 1999. Moscow: Avanti + Publishing House.
2. Mien A. **The** Origins of Religions. Brussels. 1970.
3. History of Philosophy in Six Volumes. Moscow: Izd. of the Academy of Sciences of the USSR, 1958, T.1.
4. China и Japan. History и philosophy/ Under ed. S.L.Tikhvinsky. M.: Izd. vost.lit., 1961. C.121.
5. Volkov G.N. At the Cradle of Science. Moscow: Molodaya Gvardiya, 1971.
- 6 Makovelsky A.O. Ancient Greek atomists. Baku: Izd. of the Academy of Sciences of the Azerbaijan SSR. 1946.
7. Lurie S.Ya. Democritus. L.: Nauka, 1970. C. 44.
8. Zubov V.P. Development of atomistic ideas before the beginning of the XIX century. Moscow: Nauka, 1965.
9. Akhundov M.D. Problem of discontinuity and continuity of space and time. Moscow: Nauka, 1974. C. 10-55.
10. Lucretius T.K. On the Nature of Things. Moscow: Izd. of the Academy of Sciences of the USSR, 1958.
11. Descartes R. Selected Works: Per. from French / Edited by V.V.Sokolov. Moscow: Gospolitizdat, 1950.
12. Newton I. Optics or treatise on reflections, refractions, bends and colors of light: Per. from English / Edited by G.S.Landsberg. Moscow: Gostekhteorizdat, 1954.
13. Newton I. Mathematical beginnings of natural philosophy: Per. from the Latin by A.N.Krylov. Petrograd, 1916.
14. Vavilov S.I. Aether, light and matter in Newton's physics // Collection of articles "Isaac Newton"/ Edited by S.I.Vavilov. M.-L.: Izd. of the USSR Academy of Sciences, 1943.
15. Faraday M. Experimental studies on electricity: Transl. from English / Edited by T.P.Kravets. Moscow: Izd. of the USSR Academy of Sciences. VOL. 2. 1947; VOL. 2. 1951; VOL. 3. 1959.
16. Helmholtz G. Faraday speech: Modern development of Faraday's views on electricity: Translated from English by V.Tyurin. St. Petersburg: P.P.Soykin Publishing House. 1898.
17. Faraday M. **The** forces of nature and their mutual relations. Public lectures: Per. from English by V.Luchinin. Ed. by O.I.Baket, 1865.
18. Maxwell J.K. Selected Essays on the Theory of Electromagnetic Field: Translated from English by Z.A.Tseytlin. Moscow: Gostekhteorizdat, 1952.

19. Maxwell J.K. Matter and Motion: Transl. from English by M.A.Antonovich/ Edited by B.P.Veinberg. SPb.: L.F.Panteleyev Publishing House, 1885.
20. Maxwell J.K. Treatise on Electricity and Magnetism: Per. from Engl. M.: Nauka, 1989.
21. Maxwell J.K. On Faraday force lines: In Collected Works on Electromagnetic Field Theory: Per. from Engl./ Edited by P.S.Kudryavtsev. Moscow: Gostekhizdat, 1952. C. 11-104.
22. Maxwell J.K. On physical lines of force. Ibid. C. 107- 248.
23. Lorenz G.A. Theories and Models of Ether: Per. from Engl./ Edited by K.A.Timiryazev. M. - L.: ONTI, 1936.
24. Laue M. History of Physics: Per. from German / Edited by I.V.Kuznetsov. Moscow: Gostekhizdat, 1956.
25. Liozzi M. History of Physics: Translated from Italian. E.L. Burstein. M.: Mir, 1970.
26. Kagalnikova I.I. History of development of non-relativistic ideas about the nature of gravitation. Scientific notes of K.D.Ushinsky Yaroslavl GPI. Yaroslavl: Izd-vo GPI. 1963. Vyp. 56. C. 87- 188.
27. **Fresnel A.J.**. Memoire sur la diffraction de la luminiere. Paris, 1821.
28. **Fresnel A.J.**. Consideration mecaniques sur la polarization de la luminiere. Paris, 1823.
29. **Fresnel A.J.**. Memoire sur la double refraction. Paris, 1823.
30. **Stokes G.G.** On the Aberation of Light. Phil. Mag. XXVII. 1845. P.9.
31. **Lorentz H.A.** De aberratic theorie van Stokes. Zittingsverslagen Kon. Akad. v. Wet. Amst. 1892. S. 97.
32. **Lorentz H.A.** De aberratiethorie van Stokes in de onderteflung van een, aether die niet overal dezelf de dicht heid heeft. Zittingsverslagen Kon. Akad. v. Wet. Amst. VII. 1899. S. 528.
33. **Lorentz H.A.** De relative beweging. Van de aarde en den aether. Zittingsverslagen Kon. Akad. v. Wet. Amst. 1892. S. 74.
34. Lorenz G.A. Theory of electrons and its application to the phenomena of light and thermal radiation: Transl. from English / Edited by A.K.Timiryazev and Z.A.Tseytin. Moscow: Gostekhizdat, 1956.
35. **Fizeau H.** Compt. Rend. 1851. Vol. 33. P. 349-355; Ann. d. chim et phys. 1859. Vol. 57. P. 385-404.
36. **Zeeman P.** Proc. Amsterdam Academy. 1915. Vol. 18. S. 398.
37. **Hertz H.** Untersuchungen über die Ausbreitung der elektrischen Kraft. Leipzig. 1884.

38. **Hertz H.** Grundgleichungen der Elektrodynamik für ruhende Körper. Wiedemanns Annalen der Physik. 1890. Vol. 40; 1890. Vol. 41.
39. **Ritz W.** Ann. de chim. et phys. 13. 145; 1908; Über ein neues Gesetz der serienspektrum. Physikalische Zeitschrift, Leipzig. 1908. 6.
40. **W. de Sitter.** Amst. Proc. 15, 1927, 1913; 16, 385, 1913.
41. **Le Sage G.L.** Lucrece G. Newtonian, Nouv. Memoires de l'Academie Royal des Sciences. Berlin, 1782.
42. **Le Sage G.L.** Physique mecanique de Geoges-Lois le Sage (Deux traitees Pierre Prevost). Geneve, Paris. 1818.
43. **Prevost P.** Deux traites de Physique Mecanique. Geneve, Paris, 1918.
44. **Schramm H.** Die allgemeine Bewegung der Materie als Grundsache der Erscheinungen. Wien, 1872.
45. **Schramm H.** Anziehungskraft als Wirkung der Bewegung. Graz, 1873.
46. **Thomson W.** Proc. Roy. Soc. Edinbrough, 1872. Vol. 7. P. 577.
47. **Tait P.G.** Vorlesungen über neuere Fortschritte der Physik. Braunschweig, 1877.
48. **Neuman F.** Vorlesungen über Theoretische Optik, Leipzig. 1885.
49. **Neuman F.** Gesammelte Werke. Bd. 1-3, Leipzig. 1906. S. 28.
50. **Green G.** On the Laws of Reflexion and Refraction of Light. Cambridge Transactions, VI, 1838, p.400.
51. **Mac-Cullagh J.** An Essay towards a Dynamical Theorie of crystalline Reflexion and Refraction. Sam. 1839.
52. **Thomson W.** On a Gyrostatic Construction for Ether. Math. and Phys. Papers, 1890. Vol. III. P. 100.
53. **Thomson W.** On the Propagation of Laminar Motion through a turbulently moving inviscid Liquid. Phil. Mag. (4). XXIV, 1886. P. 324.
54. **Thomson W.** On the Reflexion and Refraction of Light. Phil. Mag. (4). XXVI, 1887. P. 414.
55. Thomson W. Kelvin. About vortex atoms// Thomson J.J. Electricity and Matter. M.-L.: Gosizdat. 1928. C. 184-198.
56. **Thomson W.** Ether, Electricity and Ponderable Matter. Math. and Phys. Papers. 1890. Vol. III. P. 484.
57. **Thomson W.** On the Motion of Ether produced by collisions of Atoms or Molecules, containing or not cotaining Electrons. Math. and Phys. Papers. 1911. P. 211.
58. **Thomson W.** Electrical Insulation in Vacuum. Phil. Mag. VIII. 1904. P. 472.
59. **Larmor J.** Aether and Matter. Cambridge, 1900.
60. Thomson J.J. Relationship between matter and ether on the latest research in the field of electricity: Per. with English / Edited by I.I.Borgman. SPb.: Izdvo "Estestvoistyatel".

61. Thomson J.J. Electricity and Matter: Per. from English / Edited by A.K.Timiryazev. M.-L.: Gosizdat, 1928.
62. Thomson J.J. Corpuscular Theory of Matter: Per. from Engl. by G.Levintov/ Under the editorship of "Bulletin of Experimental Physics and Elementary Mathematics". Odessa, 1910.
63. Thomson J. J. Structure of Light// Electricity and Matter. Moscow: Gosizdat, 1928. C. 113-131.
64. Thomson J. J. Faraday force tubes and Maxwell's equations/ Electricity and Matter. Moscow: Gosizdat, 1928. C. 218-234.
65. Engels F. Electricity // Dialectics of Nature. K. Marx and F. Engels. Soch. -2nd ed. M.: Gospolitizdat, 1961. T. 20. C. 433-485.
66. **Euler L.** Recherches physiques sur la nature des moindres parties de la matiere/ Histoiree de l'Academia de Science de Berlin, 1746.
67. **Euler L.** Dissertatio de maynete. Opuscula varil argumenti. Acad. St. - Peterbourg, Vol. III, 1751.
68. **Euler L.** Anleitung zur Naturlehre. Bullet. Physicomsth. Acad. St. - Peterbourg, Acad. St. - Peterbourg, VII, 1849.
69. Lomonosov M.V. Experience of the theory of insensitive particles of bodies and in general about the causes of private qualities (1743-1744). Complete Collected Works. Moscow: Izd. of the USSR Academy of Sciences, 1950. T.1.
70. Lomonosov M.V. Notes on the gravity of bodies (1743-1744). Ibid.
71. Lomonosov M.V. Notes on the coupling of corpuscles (1743-1744). Ibid.
72. Lomonosov M.V. Letter to Euler dated July 5, 1748. Ibid.
73. Lomonosov M.V. About gravity of bodies and eternity of primary motion (1748). Ibid.
74. Lomonosov M.V. On the relation between the quantity of matter and weight (1757-1758). Ibid.
75. Lomonosov M.V. Discourse on Solidity and Liquidity of Bodies (1760). Ibid.
76. Mendeleev D. Attempt of chemical understanding of the world ether. St. Petersburg: Tip. M.P.Frolova. 1905; Attempt of chemical understanding of the world ether. Izbr. op. cit., M.-L.: 1934. T. 2, c. 467.
77. Yarkovsky I.O. Universal gravitation as a consequence of the formation of weighty matter within the celestial bodies. SPb, 1912.
78. Tsiolkovsky K.E. Ether Island// Way to the Stars. Moscow: Izd. of the USSR Academy of Sciences, 1960. C. 317-326.
79. Tseytlin Z.A. Vortex theory of matter, its development and significance. Moscow: Gosizdat. 1928.
80. Tseytlin Z.A. Development of views on the nature of light. Ibid.

81. **Whittaker J.M.** Proc. Royal Ed. 1926. Vol. 46. P. 116-306. (Vortex theory of electromagnetic motion).
82. Kasterin N.P. Generalization of Basic Equations of Aerodynamics and Electrodynamics. Moscow: Izd. of the USSR Academy of Sciences, 1937.
83. Mitkevich V.F. On the nature of electric current// Telephone and telegraph without wires, No. 15. Nizhny Novgorod Laboratory, 1922. C. 1-13.
84. Mitkevich V.F. Faraday's works and modern development of electric energy applications. M.-L.: GTTI, 1932.
85. Mitkevich V.F. Magnetic flux and its transformations. M.-L.: Izd. of the USSR Academy of Sciences, 1946.
86. **Whittaker E.A.** History of the Theories of Aether and Electricity, p. 1. The Classical Theories. 1951. 435. P. 11. The Modern Theories 1900-1926. 1953. London.
87. Kudryavtsev P.S. History of Physics / Edited by A.K.Timiryazev. Moscow: Uchpedgiz, 1948.
88. Khvolson O.D. Course of Physics in 5 vols. Berlin: Gosizdat RSFSR, 1923.
89. Frenkel Ya.I. At the dawn of new physics. L.: Nauka. 1970. C. 136-146, 169-171.
90. Berestetsky V.V. Vacuum// Physical Encyclopedic Dictionary. Moscow: Soviet Encyclopedia, 1960. T. 1. C. 221-222.
91. Lapchinsky V.G. Physical Vacuum. M.: Central Research Institute of Information and Technical and Economic Research on Atomic Science and Technology, 1982. C. 137-204.
92. Vavilov S.I. Experimental bases of the theory of relativity. Collected Works. Moscow: Izd. of the USSR Academy of Sciences, 1956. T. 4. C. 9-109.
93. Ether Wind. Collection of articles, ed. by Dr. V.A. Atsyukovsky. Moscow: Energoatomizdat, 1993.
94. **Maxwell J.C.** Ether. Gr. Brit. Enc. v.8, 1878. Maxwell J.C. Ether. In Sb. art. Maxwell J.C. Articles and Speeches. Moscow: Nauka, 1968. C. 193-206.
95. **Michelson A.A.** The relation motion of the Earth and the Luminiferous Aether. Amer. J. of Sci. (3). XXXII.1881. P. 220; Amer. J. Phys. 1881. Vol. 22. p. 120-129; Compt. Rend. 1882. Vol. 94. P. 520-523. Michelson A.A. Relative motion of the Earth and light-bearing ether [93, c. 6-17].
96. **Michelson A.A., Morley E.W..** The Relative Motion of the Medium on the Velocity of light. Ibid. (3). XXXII.1886. P. 337; The Relative Motion of the Earth and the Luminiferous Aether. Ibid. (3). XXXIV.1887. P. 333; Phil. Mag. (4) XXIV. 1887. P. 449; Amer. J. Sci. 1887. Vol. 34. P. 333-345;

Phil. Mag. 1887. Vol. 24. P. 120-129. Michelson A.A. and Morley E.V. On the Relative Motion of the Earth in the Light-bearing Ether [93, p. 17-31].

97. **Morley E., Miller D.** Phil. Mag. 1905. Vol. 9. P. 680-685. Morley E.V., Miller D.K. Report on the experiment to detect the Fitzgerald-Lorentz effect [93, p. 35-42].

98. **Miller D.C.** Phys. Rev. 1922. Vol. 19. P. 407-408; Proc. Nat. Acad. Amer. 1925. Vol. 11. № 6. P. 306-314; Science. 1925. Vol. 6/1 № 1590. P. 617-621. Miller D.C. **The ether wind.** A paper read at the Washington Academy of Sciences. UVN, 1925. T. 5. C. 177-185; [93, c. 62-71].

99. **Miller D.C.** Significance of the ether-drift experiments of 1925 at Mount Wilson. Science. 1926. Vol. 68. № 1635. P. 617-621. Miller D.C. **The significance of experiments on the detection of ether wind in 1925 at Mount Wilson** [93, pp. 71-95].

100. **Conference on Michelson-Morley experiments.** The Astrophysical J. 1928. Vol. 68, № 5. P. 34-402. Conference on the Michelson-Morley experiment held at Mount Wilson Observatory. Pasadena, California, February 4 and 5, 1927. [93, c. 112-173].

101. **Miller D.C.** The ether-drift experiment and the Determination of the Absolute Motion of the Earth. 1933. Miller D.C. **The ether-drift experiment and the determination of the absolute motion of the Earth** [93, p. 185-259].

102. **Michelson A.A., Pease F.G., Pirson F.** Repetition of the Michelson-Morley experiments. J. of the Optical Society of America. 1929. Vol. 18. № 3. P. 181-182; Michelson A.A., Pease F.G., Pearson F. Repetition of the Michelson-Morley experiment. [93, c. 177-178]

103. **Pease F.G.** Ether drift data. Astron. Soc. of t. Pacific. S.-Fr. Calif. Aug. 1930. V. XLII, N 248, p. 197-202; Pease F.G. Data on the motion of the ether [93, pp. 179-185].

104. Y.M.Galaev. Effects of ether wind in experiments on propagation of radio waves. Radiophysics and Electronics. T5, No.1. C. 119-132. Kharkov: National Academy of Sciences of Ukraine. 2000.

105. Terentyev M.V. History of the Ether. M.: Izd-vo "FAZIS", 1999.

By Chapter 3.

1. Helmholtz G. On Conservation of Force (Physical Research). M.-L.: Gosizdat. 1934.

2. I.S.Alekseev. Science. BSE - 3rd ed. M.: Soviet Encyclopedia, 1974. T. 17. C. 323.

3. B.M.Kedrov. Natural Science. Ibid. 1972. T. 9. C. 103.

4. Engels F. Letter to Marx in Manchester (1873). Marx and Engels. Soch. -2nd ed. Vol. 33. C. 67-68.
5. A.M.Prokhorov. Physics. BSE -3-e ed. M.: Soviet Encyclopedia, 1977. T. 27. C. 337.
6. Engels F. Anti-Dühring. MOSCOW: IPL, 1983.
7. Engels F. Dialectics of Nature, Moscow: IPL, 1969.
8. Lenin V.I. Outline of the "Science of Logic". The doctrine of Hegel's concept. Full. sobr. op. cit. - 5th ed. Vol. 29. C.203.
9. Maxwell J.K. About Faraday force lines. Izbr. op. cit. on the theory of electromagnetic field. Moscow: Gostekhizdat, 1952. C. 11-104.
10. Jemmer M. **The** concept of mass in modern and classical physics: Translated from English / Edited by N.F.Ovchinnikov. M.: Progress, 1967. C. 98, 99, 175.
11. Lenin V.I. Materialism and empiriocriticism. Polnol. sobr. op. -5-th ed. Vol. 18. P. P. 326.
12. Bohm D. Causality and Randomness in Modern Physics: Transl. from English / Edited by Ya.P.Terletsky. MOSCOW: IIL, 1959.
13. Fourier J. Analytical theory of heat. Paris.1922.
14. Boltzmann L. Essays on the methodology of physics: Per. from German / Edited by S.F.Vasiliev. Moscow: Izd. of the Timiryazev Research Institute, 1929.
15. Flamm L. In Memory of Ludwig Boltzmann. UVN. 1957. T. 61. Vop. 1.
16. Mamchur E.A. and Ovsyannikova N.F. Principles of simplicity and sym-
metrics/ Nature. 1968. № 6. C. 2-11.
17. Mach E. Mechanics. Historical-critical sketch of its development: Per. with German / Under. Ed. N.A.Gezehus. St. Petersburg, 1909.
18. Einstein A. Physics and Reality. Sobr. nauchn. tr. M.: Nauka, 1967. T. 4. C. 201.
19. Einstein A. **The** principle of relativity and its consequences. Sobr. nauchn. tr. M.: Nauka, 1965. T. 1. C. 138-164.
20. Trakhtenberg O.V. Essays on the History of West European Medieval Philosophy. Moscow: Gospolitizdat, 1957.
21. Pogodin S.A. Antoine Lavoisier - the founder of chemistry of the new time. Uspekhi chemii. Moscow: Izd. of the USSR Academy of Sciences. 1943. Vol. XII, Vol. 5. P. 329.
22. Lavoisier A.L. Memoirs. Classics of World Science: Per. from French / Edited by M.A.Blokh. L.: Leningr. obl. izdvo, 1931.
23. Dalton J. Collection of selected works on atomistics 1802-1810: Per. from English / Edited by B.M.Kedrov. L.: Goskhimizdat, 1940.
24. Timiryazev A.K. Kinetic Theory of Matter. Moscow: Moscow State University Publishing House, 1954.

By Chapter 4.

1. Boltzman L. Lectures on the theory of gases. Moscow: Gostekhizdat, 1956.
2. Mitkevich. V.F. Basic physical views. 3rd ed. Moscow: Izd. of the Academy of Sciences of the USSR, 1939.
3. Shapiro I.S. Atomic nucleus. BSE - 3rd ed. M.: Soviet Encyclopedia, 1978. T. 30. C. 456-461.
4. Yavorsky B.M. and Detlaf A.A. Reference book on physics for engineers and university students. Moscow: Nauka, 1977. C. 210, 211, 271
5. Patterson G.N. Molecular flows of gases. M.: Fizmatgiz, 1960. C. 59-71.
6. Mikhailov I.G., Soloviev V.A., Syrnikov Y.P. Fundamentals of molecular acoustics. Moscow: Nauka, 1969. C. 55-87.
7. **Azjurowski W.** Dynamik des Athers. Ideen des exakten Wissens, no. 2, 1974, Stuttgart. S. 48-58.
8. Schlichting G. Theory of Boundary Layer: Transl. from English / Edited by L.G.Loitsyansky. Moscow: Nauka, 1974.
9. Tikhonov A.N., Samarsky A.A. Equations of Mathematical Physics. Moscow: Nauka, 1966. C. 447-455.

Supplementary Literature:

10. Marshak R. Nuclear forces// What physicists think about. Moscow: Nauka, 1965. Vyp. 4. C. 5-26.
11. Kravtsov V.A. Masses of atoms and binding energy of nuclei. -2nd ed. M.: Atomizdat, 1974. C. 316-336.
12. Nekrasov A.N. Diffusion of a vortex. Collected Works, Moscow: Izd. of the USSR Academy of Sciences. 1961. T. 1. C. 92-116.

By Chapter 5.

1. **Erdei-Gruz T.** Fundamentals of the Structure of Matter: Transl. from German / Edited by G.B.Zhdanov. M.: Mir, 1967.
2. Predvoditelev A.S. About vortex motions// Problems of physical hydrodynamics. Minsk: Izd. of the Institute of Heat and Mass Exchange of the BSSR Academy of Sciences, 1971. C. 178-211.
3. **Helmholtz G.** Wissenschaftliche Abhandlungen, Bd 1-3, Leipzig, 1882-1895; Vorlesungen über theoretische Physik, Bd 1-6, Leipzig, 1898-1903.
4. Helmholtz G. Two studies on hydrodynamics. M., 1902; On the

5. Lagrange J.L. Analytical Mechanics - 2 ed. Vol. 1-2, Transl. from Fr. V.S. Gohman. M. - L.: GITTL, 1950.
6. **Beltrami E.** Opera matematiche, t. 1-4. Milan, 1902-1920.
7. **Kirchhoff G.R.** Vorlesungen über mathematische Physik. Bd. 1-4. Leipzig, 1874-94. Kirchhoff G.R. Collected Works, Vol. 2. M. - L. 1941.
8. **Reynolds J.** An experimental Investigation of the Circulation which determines the Motion of Water shall be Direct or Sin and the Law of the Resistance in parallel Channels. Phil. Trans. CLXXIV, 935, 1883. Papers 11, 51; Papers on mechanical and physical subjects, v. 1-3, Camb., 1900-1903.
9. Zhukovsky N.E. Collected Works, vols. 1-7, M.-L., 1948-50; Fundamentals of the Vortex Theory// Electricity and Matter. M.-L.: Gosizdat, 1928. C. 172-184.
10. **Thomson W.** Mathematical and physical papers, v. 1-6, Camb., 1882-1911.
11. Thomson W. **The structure of matter.** C. -Pb, 1895.
12. **Karman Th. und Rubach H.** Über den Mechanismus des Flüssigkeits- und Luftwiderstandes. Physikalische Zeitschrift, 13 (1912), s. 48.
13. Kochin N.E., Kibel I.A., Roze N.V. Theoretical Mechanics. CH. I, II. Moscow: Izd. of physical-mat. lit. 1963. C. 207- 236 (PART II).
14. Friedman A.A. Experience of hydromechanics of compressible fluid. M. - L.: GTTI, 1934.
15. Friedman A.A. About vortices in a liquid with changing temperature// Izbr. tr. M.: Nauka, 1966.
16. **Oseen.** Hydrodinamiks, Leipzig, 1927.
17. Fabrikant N.Ya. Vortex motion// Physical Encyclopedic Dictionary. Moscow: Soviet Encyclopedia. 1960. T. 1. C. 279-281.
18. Schlichting G. Theory of Boundary Layer: Transl. from English / Edited by L.G.Loitsyansky. Moscow: Nauka, 1974. C. 285, 316.
19. Predvoditelev A.S. About molecular-kinetic substantiation of hydrodynamics equations// Problems of physical hydrodynamics. Minsk: Izd. of the Institute of Heat and Mass Exchange of the BSSR Academy of Sciences, 1971. C. 154-171.
20. Predvoditelev A.S. About turbulent currents. Ibidem. C. 212- 235.
21. Lamb G. Hydromechanics: Per. from English / Edited by N.A. Slezkin. M.-L.: Gostekhteorizdat, 1947. C. 99, 304, 839.
22. Frankl F. and Voytel W. Friction in the turbulent boundary layer near a plate in a plane-parallel flow of compressible gas at high velocities. Proc. TSAGI. Moscow: Izd. of TsAGI, 1937. Vyp. 321.

23. Glazer A.G. Structure of a tornado vortex from observation data// Dynamics of cumulus clouds: Transl. from English / Edited by Ch. Anderson. Moscow: Mir, 1964. C. 217-229.
24. Bubnov V.A., Soloviev A.A., Gabdullin I.Z. Modeling of turbulent tornadoes// Physics and technology of aerothermo-optical methods of control and diagnostics of laser radiation. Minsk: Izd. of the Institute of Heat and Mass Exchange of the BSSR Academy of Sciences, 1981. C. 150-173.
25. Bubnov V.A., Martynenko O.G., Solodukhin A.D. et al. Hydrodynamic structure of a typhoon (experimental part). Preprint No. 12. Minsk: Izd. of the Institute of Heat and Mass Exchange of the BSSR Academy of Sciences, 1983.
26. **Rosenhead.** The Formation of Vortices from a Surface of Discontinuity. Proc. of the R. S., 1931. A. Vol. 134. P. 323.
27. Kabardin Y., Kiselev A. Physics of the satellite trail. Aviation and Cosmonautics. 1978. № 3. C. 26-27.
28. **Lichtenstein.** Math. Zeitsch. XXIII. 1925. Vol. 89. P. 310. Grundlagen der Hydrodynamik. Berlin, 1929.
29. Lugovtsov A.A., Lugovtsov B.A., Tarasov V.F. On the motion of a turbulent vortex ring// Continuum Dynamics. Novosibirsk: Izd. of the Institute of Hydrodynamics, Siberian Branch of the USSR Academy of Sciences. 1969. Vyp. 3. C. 50-54.
30. Lavrentiev M.A. Shabat E.V. Problems of Hydromechanics and Their Mathematical Models. Moscow: Nauka, 1973. C. 339-340.
31. Tikhonov A.N., Samarsky A.A. Equations of Mathematical Physics. Moscow: Nauka, 1966. C. 447-455.
32. Nekrasov N.A. Diffusion of a vortex. Collected Works, Moscow: Izd. of the USSR Academy of Sciences, 1961. T. 1, c. 92-116.
33. Yavorsky B.M. and Detlaf A.A. Reference book on physics for engineers and university students. Moscow: Nauka, 1971. C. 210.
34. Prandtl L. Hydroaeromechanics - 2nd edition: Пер с нем. MOSCOW: IIL, 1951.
35. Khaykin S.E. Physical bases of mechanics - 2 ed. M.: Nauka, 1971.
36. Zhukovsky N.E. About the attached vortices. Complete Collected Works. Th. 5. M.-L.: ONTI, 1937.
37. Loytsyansky L.G. Mechanics of liquid and gas - 5th ed. M.: Nauka, 1978.
38. Patterson G.N. Molecular flow of gases: Пер. from Engl./ Edited by V.S.Avduevsky. Moscow: Fizmatgiz, 1960.
39. Boltzmann D. Lectures on the theory of gases: Пер. from German / Edited by B.I. Davydov. Moscow: Gostekhizdat, 1956.

Supplementary Literature.

40. Dynamic Meteorology // Edited by B.I.Izvekov, I.A.Kibel, N.E.Kochin. L.: Izd-vo Tsentral'nyi Upr. of Unified Hydrometeorological Service of the USSR, 1935.
41. Ville A. Theory of Vortices: Transl. from French by P.M.Gumensky. M.-L.: ONTI, 1936.
42. Abramovich T.N. Turbulent free jets of liquids and gases// Proceedings of TsAGI, 1940. № 512.
43. Büschgens O.S. About the helical flow// Scientific notes of the Moscow Hydromeliorative Institute named after Williams. VOL. XVII. M., 1948.
44. Gandhi L.S. et al. Fundamentals of dynamic meteorology. L.: Gidrometeoizdat, 1955.
45. Vasiliev O.F. Fundamentals of mechanics of helical and circulation flows. M. - L.: Gosenergoizdat, 1958.
46. Avduevsky V.S., Kryukov V.N., Solntsev K.N. Experimental study of boundary layer structure and heat transfer on a rough surface. Investigation of Heat Exchange in Fluid and Gas Flows. M.: Mashinostroenie, 1965. C. 55-90.
47. Batchelor J. Introduction to Fluid Dynamics. Chap. 7. Vortex flow in an effectively non-viscous fluid: Transl. from Engl. M.: Mir, 1973. C. 623-732.
48. Sedov L.I. Mechanics of Continuous Medium. M.: Nauka, 1976. T. 2.
49. Bobr V.A., Garmize L.H., Kalinets V.I. Modeling of atmospheric formations// Evolutionary problems of energy transfer in inhomogeneous media. Minsk: Izd. of the Institute of Heat and Mass Exchange of the BSSR Academy of Sciences, 1979. C. 3-19.
50. Hill M.M. On a spherical vortex. Phil. Trans. A. CLXXXV. 1889.
51. Coker and Glementa. Phil. Trans. A. CCI, 45, 1902.
52. Boltze E. Grenzschichten an Rotationskörpern. Gött. 1908.
53. Prandtl L., Tietjens O. Hydro- und Aeromechanic. Berlin, 1929. S. 175-208.

By Chapter 6.

1. Vigier J.P. Voprosy filosofii. 1956. № 6. C. 91.
2. Rutherford E. The Structure of the Atom and Artificial Transformation of Elements: Transl. from Engl./ Edited by G.I.Flerov. Izbr. nauchn. tr. Kny. 2. Moscow: Nauka, 1972.

3. **Chadwick J.** Possible existence of a neutron. "Nature, 1932, v. 129, № 3252.
4. **Ivanenko D.D.** **The Structure of Matter and the Unified Theory of Matter.** Moscow: Znanie, 1960.
5. Heisenberg W. Physics of the atomic nucleus. M. - L., 1947.
6. Kendal G.V., Panovsky V.K.G. Structure of the proton and neutron// Elementary Particles. Moscow: Nauka, 1973. Vyp. 9.
7. Vlasov N.A. Neutrons. -2nd ed. M.: Nauka, 1971.
8. Gurvich I.I., Tarasov D.V. Physics of low energy neutrons. Moscow: Nauka, 1965.
9. Beizer A. Basic representations of modern physics: Transl. from English by A.G.Beda and A.V.Davydov. Moscow: Atomizdat, 1973.
10. Selinov I.P. Structure and systematics of atomic nuclei// Tables of elementary particles and isotopes of elements and their systematics. M.: Izd-vo TsNII informatics and technical and economic research on atomic science and technology, 1982.
11. Nemets O.F., Gofman Yu.V. Reference book on nuclear physics for engineers and university students. Moscow: Nauka, 1971.
12. Fermi E. Nuclear Physics: Scientific Works: Transl. from English / Edited by B.M.Pontecorvo. Moscow: Nauka, 1971, Vol. 1.
13. Marshak R. Nuclear forces// What physicists think about. Moscow: Nauka, 1971. Vyp. 4. C. 5-26.
14. Yavorsky B.M., Detlaf A.A. Reference book on physics for engineers and university students. Moscow: Nauka, 1971.
15. Eisenberg I., Greiner W. Models of nuclei. Collective and single-particle phenomena: Transl. from English / Edited by S.P.Kamerdzhev and B.A.Tulunov. Moscow: Atomizdat, 1975.
16. Eisenberg I., Greiner W. Microscopic theory of the nucleus: Per. from Engl./ Edited by S.P.Kamerdzhev and B.A.Tulunov. Moscow: Atomizdat, 1976.
17. Eisenbud L., Wigner Y. Structure of the nucleus: Per. from Engl./ Edited by A.M.Baldin. M.: IIL., 1959.
18. Bethe G. Theory of Nuclear Matter: Transl. from Engl. by V.M.Kolbisov/ Edited by Y.A.Smorodinsky. M.: Mir, 1974.
19. Bethe G., Morrison F. Elementary theory of the nucleus: Per. from Engl. M.: IIL, 1958.
20. Blin-Stoyle R. Fundamental Interactions and the Atomic Nucleus: Transl. from English / Edited by D.D.Ivanenko. MOSCOW: IIL, 1958.
21. Geppert-Mayer M., Iensen I.G.D. Elementary theory of nuclear shells: Transl. from English / Edited by D.D.Ivanenko. MOSCOW: IIL, 1958.
22. Davydov A.S. Theory of the Atomic Nucleus. Moscow: Fizmatgiz, 1958.

23. Kokkede Ya. Theory of Quarks: Transl. from English by A.S.Zhukharev. M.: Mir, 1971.
24. **Yukawa H.** Proceeding of the Physiko-Mathematical Society of Japan, 1935, v. 17, p.48.
25. Davydov A.S. Atoms, nuclei, particles. Kiev: Naukova Dumka, 1971.
26. Kravtsov V.A. Masses of atoms and binding energy of nuclei. Moscow: Atomizdat, 1974.
27. Shapiro I.S. Atomic nucleus. BSE - 3rd ed. M.: Soviet Encyclopedia, 1978. T. 30. C. 456 - 461.
28. Periodic system of isotopes// Physical Encyclopedic Dictionary. BSE -Z ed. Moscow: Soviet Encyclopedia, 1966. T. 5. C. 384-385.
29. Atomic fission nuclei. BSE - 3rd ed. Moscow: Soviet Encyclopedia, 1978. T. 30. C. 452 - 454.
30. Lebon G. Evolution of Matter: Transl. from French by B.S.Bychkovsky. Petersburg: M.I.Semyonov Publishing House, 1914. C. 339-340.

By Chapter 7.

1. Thomson V.Kelvin. About vortex atoms// Electricity and Matter: Transl. from English / Edited by Z.A.Tseytlin. M.-L.: Gosizdat, 1928. C. 182-198.
2. Volkov G.N. At the Cradle of Science. Moscow: Molodaya Gvardiya, 1971.
3. Makovelsky A.O. Ancient Greek atomists. Baku: Izd. of the Academy of Sciences of the Azerbaijan SSR. 1946.
4. Lurie S.Ya. Democritus. L.: Nauka, 1970. C. 44.
5. Zubov V.P. Development of atomistic ideas before the beginning of the XIX century. Moscow: Nauka, 1965.
6. Elyashevich M.A., Shteinman R.Y. Atomic Physics. BSE - 3rd ed., M.: Soviet Encyclopedia, 1970. T. 2. C. 398-402.
7. **Thomson J.J.** The discharge of electricity through gases. London, 1898.
8. Thomson J.J. Corpuscular Theory of Matter. Odessa, 1919.
9. Thomson J.J. Matter, Energy and Ether. Spb., 1911.
10. **Rutherford E.** The collected papers of Lord Rutherford of Nelson, v. 1-3. London, 1962-1965.
11. Rutherford E. **The Structure of the Atom and Artificial Transformation of the Elements.** Selected Scientific Works. Moscow: Nauka, 1972.
12. **Bohr N.** Phil. Mag. 1913. Vol. 26. P. 1.

13. Bohr M. Three articles on spectra and structure of atoms: Transl. from German. M.- Pg. 1923.
14. **Bohr N.** Die Quantenpostulat und die neuere Entwicklung der Atomistik. *Naturwissenschaften*, H. 15. 1928. S. 245.
15. Compton A.H. X-rays. Theory and experiment. M.-L.: GITTL, 1941.
16. Broglie L. Revolution in Physics - 2nd ed. Translated from French by S.O.Baklanov and L.M.Kovrignykh. M. Atomizdat, 1965.
17. **Davisson C.J, Germer L.Y.** Diffraction of electrons by a cristal of nickel. *Physical Rev.* 1927, v. 30 № 7.
18. Davisson K.J., Germer L.H. Waves or electrons? *UVN*, 1928, vol. 8 vol. 4.
19. Heisenberg W. Physical Principles of Quantum Mechanics: Transl. from German. / Edited by D.D.Ivanenko. M.-L.: GTTI, 1932.
20. **Pauli W.** Collected scientific papers. N.Y. 1964.
21. Theoretical Physics of the Twentieth Century. **In Memory of W. Pauli**: Transl. from English / Edited by Y.A. Smorodinsky. MOSCOW: IIL, 1962.
22. Pauli W. Works on quantum theory: Per. from German / Edited by V.Ya.Smorodinsky. Moscow: Nauka, 1975.
23. Pauli W. Physical Essays: Per. from German and English / Edited by V.Ya.Smorodinsky. Moscow: Nauka, 1975.
24. Born N. Atomic Physics. -3rd ed.: Per. from Engl./ Edited by B.V.Medvedev. M.: Mir, 1970.
25. **Schrödinger E.** Abhandlungen zur Wellenmechanik/ 2 Aufl. Leipzig. 1928.
26. Schrödinger E. New Paths in Physics. Articles and speeches: Transl. from English / Edited by W.I.Frankfurt. Moscow: Nauka, 1971.
27. Dirac P. Principles of Quantum Mechanics: Transl. from English / Edited by V.A.Fok. M.: Fizmatgiz, 1979.
28. Lebedev T.A. On the continuity between the phenomena of micro and macro worlds. M.: Izd-vo ENIN, 1976.
29. Berestetsky V.B. Quantum mechanics. M., Soviet Encyclopedia, 1970. T. 11 c. 398-402. T. 11, c. 572-582.
30. Qian Xue Sen. Physical Mechanics: Per. from Chinese / Edited by R.G.Barantsev. M.: Mir, 1965. C. 28-71.
31. Fermi E. Quantum Mechanics: Per. with Engl. M.: Mir, 1965.
32. **Jammer M.** The conceptual development of quantum mechanics. N.Y., 1966. P.111.
33. **Eddington A.** A new Derivation of quantum equation for masses of proton and electron. *Proc. of t. R.S.* 1940. ol. 174. P. 16.

34. Jemmer M. **The** concept of mass in classical and modern physics: Transl. from Engl. by N.F.Ovchinnikov. Moscow: Progress, 1967. C. 199.
35. Krylov A.N. About some differential equations of mathematical physics. St. Petersburg: Izd. of the Imperial Academy of Sciences. 1913. C. 121-123.
36. **Madelung E.** Quantentheorie in hydrodynamischer Form. Zeitschr. f. Phys. 1926. Vol. 40, № 3, 4. P. 327.
37. **Bohm D.** Phys. Rev. 1952. Vol. 85. P. 166; 1953. Vol. 89. P. 458.
38. Elyashevich M.A. Atomic and molecular spectroscopy. M.: Fizmatgiz, 1962.
39. Kondilenko I.I., Korotkov P.A. Introduction to Atomic Spectroscopy. Kiev: Vishcha Shkola, 1976.
40. Frisch S.E. Optical spectra of atoms. M.-L.: Fizmatgiz, 1963.
41. Tables of spectral lines. - 4th ed. Moscow: Nauka, 1977.
42. Andronov A.V., Khaykin S.E. Theory of Vibrations. Moscow: Fizmatgiz. 1959.
43. Gorelik G.S. Fluctuations and waves. -2nd ed. M.: Fizmatgiz. 1959.
44. Strelkov S.P. Introduction to the Theory of Vibrations. -2nd ed. M.: Nauka. 1964.
45. Feld B. Neutron Physics. In Sb.: Experimental Nuclear Physics: Transl. from English / Edited by E. Segre. MOSCOW: IIL. 1955. T. 2.
46. **Hill M.J.M.** On a spherical Vortex. Phil. Tras. A. 1894, 185.
47. **Taylor G.I.** Motion of solid in fluids, when the flow is not irrotational. Roy. Soc. Proc. A. Vol. 93, 648. 1917. P. 99-113.
48. **Taylor G.I.** Experiments with rotating liquids. Cambr. Univ. Press Roy. Soc. Proc. A, Vol. 100, 703, 1921. P. 114.
49. **Taylor G.I.** The Motion of a Sphere in a rotating liquid. Proc. of t.R.S. A, Vol. CII, NO. 715, 1922. P. 180-189.
50. Batchelor J. Introduction to Fluid Dynamics: Per. from Engl./ Edited by G.Yu.Stepanov. Moscow: Mir. 1973. C. 642.
51. **Greenspan H.P.** The theorie of rotation fluids. Cambr. Univ. Press, 1968. P. 327.
52. Starr V.P. Physics of phenomena with negative viscosity. Per. from Engl./ Edited by A.S.Monin. M.: Mir. 1971.
53. Taylor B., Parker W., Langenberg D. Fundamental constants and quantum electrodynamics: Transl. from English / Edited by B.A.Mamyrin. Moscow: Atomizdat, 1972.
54. Kuh Sh. Structure of atomic nuclei. Moscow: Atomizdat, 1967.
55. **Gamov G.** Scient. Amer. 1959. Vol. 201, № 1. P. 74.
56. Sosnovsky A.N. ZhETF. 1959. T. 59,. Vyp. 4. C. 102.

-
57. **Mayer M.G.** Phys. Rev. 78. Vol. 2. 1950. P. 16.
 58. **Geppert-Mayer M.**, Jensen I.G.D. Elementary theory of nuclear shells: Per. from English / Edited by D.D.Ivanenko. M.: Izd-vo foreign. lit. 1958.
 59. Reinouter J. How the model of spheroidal nuclei arose: Transl. from English // UVN, 1976. T. 12. Vol. 4. C. 529-541.
 60. Bohr O., Mottelson B. Structure of the Nucleus: Per. from Engl./ Edited by S.A.Sliv. M.: Mir, 1971-1976. T. 1-2.
 61. **Erdei-Gruz T.** Fundamentals of the Structure of Matter: Translated from English / Edited by G.B.Zhdanov. M.: Mir, 1976.
 62. Trifonov D.N. Structure and Boundaries of the Periodic System. Moscow: Atomizdat, 1979.
 63. Elyashevich M.A. Periodic Law and Structure of Atoms. Moscow: Atomizdat, 1971.
 64. Didyk Y.K., Artamonov E.V., Vasiliev B.K. To substantiation of optimal variants of periodic systems and periodic law// Scientific Work of Norilsk Evening Industrial Institute. № 17. Krasnoyarsk: Krasnoyarsk book publishing house, 1975. C. 92-108.
 65. Cherkesov A.I. Nucleonic principle of the natural system of chemical elements// Izvestiya vuzov. Chemistry and Chemical Technology. 1975. T. 18. Vyp. 5. C. 91.
 66. Ovchinnikov K.V., Semyonov I.N., Bogdanov R.V. From atom to molecule. L.: Khimiya, 1973.
 67. Krasnov K.S. Molecules and Chemical Bonding. Moscow: Higher School, 1977.
 68. Minkin V.I., Simkin B.Y., Minyaev R.M. Theory of molecule structure. Moscow: Higher School, 1979.
 69. **Van der Waals.** Über die Kontinuität des gasförmigen und flüssigen Zustandes. Leipzig, 1881.
 70. Van der Waals J.D., Kohnstamm F. Course of Thermostatistics, ch. 1-2. M.: ONTI, 1936.
 71. Coulson K. Intermolecular forces - from Maxwell to Schrödinger. UFN 1963, Vol. 81 Issue 3.
 72. Shpilrein E.E. Gases. BSE - 3rd ed., M.: Soviet Encyclopedia, 1971. T. 6, c. 31-33.
 73. **Drude P.** Physik des Aethers auf elektromagnetischer Grundlage. 2-te Aufl. Stuttgart, 1912.
 74. **Drude P.** Lehrbuch der Optik. 2te erw. Aufl. Leipzig, 1906.
 75. Lorenz G. Electronic Theory. Spb.: Izdvo "Obrazovanie". 1910.

76. Lorenz G. Theory of electrons and its application to the phenomena of light and thermal radiation: Transl. from English / Edited by A.K.Timiryazev and Z.A.Tseytlin. Moscow: Gostekhteorizdat, 1956.
77. Belov N.V. Structure of ionic crystals and metallic phases. M., 1947.
78. Inyushkin A.V. Heat Conduction. Physical quantities. Reference book. Moscow: Energoatomizdat, 1991. C. 339.
79. Boreskov G.K. Catalysis. BSE - 3rd ed., M.: Soviet Encyclopedia, 1973. Vol. 11, pp. 516-517.

By Chapter 8.

1. Engels F. Electricity// Dialectics of Nature. K.Marx and F.Engels. Op. 2nd ed. M.: Gospolitizdat, 1961. T. 20. C. 433-485.
2. Kudryavtsev P.S. History of Physics. Moscow: Uchpedgiz, 1956.
3. Liozzi M. History of Physics: Transl. from Italian. E.L. Burstein. M.: Mir, 1970.
4. Bessonov L.A. History of development of electrical engineering and formation of the course of TOE. Theoretical bases of electrical engineering. Electromagnetic field. 9th ed. M.: Izdvo "Gardariki", 2001. C. 305-310.
5. Faraday M. **The** forces of matter and their relations. Public lectures: Per. from Engl. V.Luginin/ Edited by Z.A.Tseytlin. M.: GAIZ, 1940.
6. Faraday M. Experimental studies on electricity: Transl. from English / Edited by T.P.Kravets. Moscow: Izd. of the USSR Academy of Sciences, 1947-1959.
7. Helmholtz G. Two studies on hydrodynamics: Translated from German / Edited by S.A.Chaplygin. Moscow: Tipography of O.L.Somova, 1902.
8. Helmholtz G. Faraday Speech. Modern Development of Faraday's Views on Electricity: Per. from German. V.Tyurin. St. Petersburg: P.P.Soykin Publishing House. 1898.
9. **Thomson W.** Magnetism, the dynamic relation of... Nicol's Cyclopedia, 1860. Proc. of R.S. VI, 1856; VI, 1861.
10. **Thomson W.** Ether, electricity and Ponderable Matter. Cambr. and Dubl. Papers, 484, 1890.
11. **Thomson W.** On the duties of ether for electricity and magnetism. Phil. Mag. IX, 1900, 305.
12. **Thomson W.** Electrical insulation in vacuum. Phil. Mag. VIII, 1904, 472.
13. **Thomson W.** Hydrodynamic. Cambr. and Dubl. Math. and Phys. Papers. IV, 1910.
14. **Challis.** Phil. Mag. XII, 1860; I, II, 1861.

15. Maxwell J.K. On Faraday force lines. Selected Works on the Theory of Electromagnetic Field. Moscow: Gostekhteorizdat, 1952. C. 9 - 88. See Boltzmann's notes there, pp. 89 - 106.
16. Maxwell J.K. On physical lines of force. Ibid, pp. 105 - 193. See also Boltzmann's notes there, pp. 190 - 248.
17. Maxwell J.K. Dynamic theory of the electromagnetic field. Ibid. pp. 249 - 341.
18. **Heaviside O.** Electromagnetic theory. Electrical papers. Vol. 1, 2. London - N.Y., 1892.
19. **Joseph H.J.** Some unpublished notes of Oliver Heaviside. The Heaviside centenary volume. London, 1950.
20. Campbell N.R. Modern electrical theory: Per. from English / Edited by I.I.Borgman. Spb.: Izdvo "Education", 1912.
21. **Larmor J.** Aether and Matter. Cambr. 1900.
22. **Langevin P.** Chim. et Phys. Mai 1905.
23. **Abraham und Foppl.** Theorie der Electricitat. Leipzig, 1904-1905.
24. **Drude P.** Physik des Aethers auf elektromagnetischer Grundlage. 2-te Aufl. Stuttgart, 1912.
25. **Drude P.** Lehrbuch der Optik. 2te erw. Aufl. Leipzig, 1906.
26. **Drude P.** Zur Elektronentheorie der Metalle. Ann. Phys. 1 (1900), s. 566; 3 (1900), s. 369.
27. Lorenz G. Electronic Theory. Spb.: Izdvo "Obrazovanie". 1910.
28. Lorenz G. Theory of electrons and its application to the phenomena of light and thermal radiation: Transl. from English / Edited by A.K.Timiryazev and Z.A.Tseytlin. Moscow: Gostekhteorizdat, 1956.
29. Thomson J.J. Electricity and Matter: Per. from English / Edited by A.K.Timiryazev. M. - L.: Gosizdat. 1928. C. 9-97.
30. Thomson J.J. Relationship between matter and ether on the latest research in the field of electricity: Per. from English / Edited by I.I.Borgman. SPb.: Izdvo "Estestvoistyatel", 1910.
31. Kasterin N.P. Generalization of Basic Equations of Aerodynamics and Electrodynamics. Moscow: Izd. of the USSR Academy of Sciences, 1937.
32. Mitkevich V.F. About the nature of electric current. Telegraph and telephone without wires. № 15. Nizhny Novgorod Laboratory, 1922. C. 1- 13.
33. Mitkevich V.F. Works of V.Thomson. Electricity. № 3, 8, 10, 1930.
34. Mitkevich V.F. Faraday's works and modern development of electric energy applications. Moscow: Gostekhteorizdat, 1932. C 1-13.

35. Mitkevich V.F. Basic views of modern physics. L.: Izd. of the Academy of Sciences of the USSR, 1933.
36. Mitkevich V.F. Basic physical views. - 3rd ed. Moscow: Izd. of the Academy of Sciences of the USSR, 1939.
37. Mitkevich V.F. Magnetic flux and its transformations. Moscow: Izd. of the USSR Academy of Sciences, 1946.
38. **Maxwell J.C.** A treatise on electricity and magnetism, v. 1 - 2. Oxf. 1873. In Russian translation Maxwell J.C. A treatise on electricity and magnetism. Moscow: Nauka, 1989.
39. Nikolaev G.V. Non-contradictory electrodynamics. Theory, experiments, paradoxes. Tomsk: NTL Publishing House, 1997.
40. Gromeka I.S. Some cases of motion of a compressible liquid. *Sobr. Soch.* Moscow: Izd. of the USSR Academy of Sciences, 1952.
41. Vasiliev O.F. Fundamentals of mechanics of screw and circulation processes. M. - L.: Gosenergoizdat, 1958
42. Zhukovsky N.E. Vortex theory of a propeller. *Collected Works.* M. - Л.: 1949. C. 445-493, 529-612.
43. Popov S.G. About helical motions of an ideal liquid. *MSU Bulletin*, 1948. № 8.
44. Büschgens S.S. About a helical flow. *Scientific notes of the T. Williams Moscow Hilromeliorative Institute.* XVII. Moscow: Izd-v. of the Moscow Hydromeliorative Institute, 1948.
45. Kalantarov P.L., Neiman L.R. Theoretical bases of electrical engineering. M.-L.: Gosenergoizdat. 1961.
46. Atsyukovsky V.A. Construction of communication systems of aircraft equipment complexes. M.: Mashinostroenie, 1976. C. 166.
47. Yavorsky B.M. and Detlaf A.A. Reference book on physics for engineers and students of higher educational institutions. Moscow: Nauka, 1971.

By Chapter 9.

1. **Bonch-Bruевич A.M.** Optics// BSE - 3rd ed. Moscow: Soviet Encyclopedia. 1974. T. 18. C. 442.
2. Kudryavtsev P.S. History of Physics. T. 1, 2. Moscow: Uchpedgiz, 1956.
3. Tseytlin Z.A. Development of views on the nature of light// Thomson J.J. Electricity and Matter. M.-L.: Gosizdat, 1928. C. 128.
4. Descartes R. Selected Works: Per. from French / Edited by V.V.Sokolov. Moscow: Gospolitizdat, 1950.

5. Newton I. Optics or treatise on reflections, refractions, bends and colors of light: Per. from English / Edited by G.S.Landsberg. Moscow: Gostekhizdat, 1954.
6. Hooke R. A general scheme or idea of the present state of natural philosophy// Scientific Heritage. Est.-nauchny. series. M. - L.: Izd-vo AS USSR, 1948. T. 1.
7. Huygens H. Treatise on Light: Per. from French / Edited by V. Fredericks. M.-L.: ONTI, 1935.
8. Vavilov S.I. Aether, light and matter in Newton's physics. Isaac Newton. Collection of articles for the three hundredth anniversary of his birth. Edited by S.I.Vavilov. M.-L.: Izd. of the Academy of Sciences of the USSR. 1943. C. 33 - 52.
9. Maxwell J.K. Dynamic Field Theory. Part VI: Electromagnetic Theory of Light. Izbr. op. cit. on the theory of electromagnetic field: Per. from Engl./ Edited by P.S.Kudryavtsev. Moscow: Gostekhteorizdat, 1952. C. 317-331.
10. Helmholtz G. On the Conservation of Force: Per. from the German Acad. P.P.Lazarev. M.-L.: GTTI, 1934.
11. Lorenz G.A. Theory of electrons and its application to the phenomena of light and thermal radiation: Transl. from English / Edited by A.K.Timiryazev and Z.A.Tseytlin. M.: GITTL, 1956.
12. Stoletov A.G. Collected Works Vol. 1-3. M.-L.: Gostekhizdat, 1939-1947.
13. Lebedev P.N. Collected Works. Moscow: Izd. of the USSR Academy of Sciences, 1963.
14. Landsberg G.S. Optics. General course of physics. T. 3. Moscow: Nauka, 1976.
15. Born M., Wolf E. Fundamentals of Optics: Transl. from English / Edited by G.P.Motulevich. Moscow: Nauka, 1973.
16. Akhiezer A.I., Berestetsky V.B. Quantum Electrodynamics. - 3rd ed. M.: Nauka, 1969.
17. Klauber J., Sudarshan E. Fundamentals of Quantum Optics: Transl. from English / Edited by S.A.Akhmanov. M.: Mir, 1970.
18. Thomson J.J. Nature of Light// Electricity and Matter: Per. with English/M.: Gosizdat, 1928. C. 113-132.
19. **Tietjens O., Prandtl L.** Hydro- und Aeromechanik, I Band, Berlin, 1929. P. 217-235.
20. **Karman T.** Collected work. Vol. 1-4. London, 1956.
21. Petrov G.I. About stability of vortex layers// Proc. Tsagi. Moscow: Izd. of Tsagi, 1937. Vyp. 4.
22. Zhevandrov N.D. Anisotropy and Optics. Moscow: Nauka, 1974.
23. Lamb G. Hydromechanics: Per. from Engl./ Edited by N.A.Slezkin. M.-L.: OGIZ, 1947.

24. **Joseph H.J.**. Some unpublished notes of Oliver Heaviside. The Heaviside centenary volume. London, 1950. P. 44.
25. Lavrentiev M.A., Shabat B.V. Problems of hydrodynamics and their mathematical analogs. Moscow: Nauka, 1973.
26. Lugovtsov A.A., Lugovtsov B.A., Tarasov V.F. On the motion of a turbulent vortex ring// Continuum Dynamics. Vop. 3. Novosibirsk: Izd. of the Institute of Hydrodynamics of SB AS USSR, 1969. C. 50- 59.
27. Syunyaev R.A. Relict radiation// BSE - 3rd ed. M.: Soviet Encyclopedia, 1975. T. 21. C. 632.
28. Nekrasov A.I. Diffusion of a vortex// Collected Works, Moscow: Izd. of the USSR Academy of Sciences, 1961. T. 1. C. 92.
29. Kaganov M.I., Filatov A.P. Fermi Surface. Moscow: Znanie, 1969.
30. Panovko Ya.G. Introduction to the theory of mechanical impact. Moscow: Nauka, 1977.
31. Gojaev N.M. Optics. Moscow: Higher School, 1977.
32. Bethe G., Sommerfeld F. Electron theory of metals: Per. from German / Edited by M.A.Elyashevich. M.-L.: ONTI, 1938.
33. Lifshits I.M., Pitaevsky L.P., Kaganov M.I. Electron Theory of Metals. Moscow: Nauka, 1971.
34. Slaughter J. Dielectrics, Conductors, Metals: Per. with Engl. M.: Mir, 1969.
35. Schaefer K. Optics. Theoretical Physics, Vol. 3. Ch. 2: Per. from German / Edited by H.F.Teodorichik. M.-L.: Gostekhizdat, 1938.
36. Kulikov K.A. Fundamental constants of astronomy. Moscow: Gostekhizdat, 1956.
37. Ether wind. Collection of articles under the editorship of Dr. V.A. Atsyukovsky. M., Energoatomizdat, 1993.
38. Galaev Yu.M. Effects of ether wind in experiments on radio wave propagation. Radiophysics and Electronics. T. 5, № 1. Kharkov, Nats. Ak. Ukr. 2000.
39. Schlichting G. Boundary layer theory: Per. from German / Edited by L.G.Loitsiansky. Moscow: Nauka, 1974. Chapter XI. C. 227-232.
40. **Boltze E.** Grenzschichten and Rotationkorpem. Dis. Gottingen, 1908.

By Chapter 10.

1. Newton I. Mathematical beginnings of natural philosophy// Collected Works: Per. from Lat. A.N.Krylov. M.-L.: Izd. of the Academy of Sciences of the USSR, 1931.

2. Lomonosov M.V. On the Gravity of Bodies// Collected Works, Moscow: Izd. of the USSR Academy of Sciences. 1950. T. 1. C. 243.
3. Vavilov S.I. Aether, light and matter in Newton's physics. Isaac Newton. Collection of articles for the Tercentenary of his birth//Edited by Academician S.I.Vavilov. M.-L.: ANS SSSR, 1943. C. 33-52.
4. Vavilov S.I. Newton and his significance in world science. Ibid. C. 5-32.
5. Dubyago A.D. Comets and their significance in the general system of Newton's "Beginnings". Ibid. pp. 235-263.
6. Laplace P.S. Outline of the World System. T. 1-2. SPb, 1861.
7. Einstein A. Foundations of the general theory of relativity. Sobr. nauchn. tr. M.: Nauka, 1965. T. 1. C. 452-504.
8. Einstein A. On gravitational waves. Ibid. pp. 631-646.
9. Zelmanov A.A. Gravitational paradox// Physical Encyclopedic Dictionary. T. 1. M.: Soviet Encyclopedia, 1960. C. 489.
10. Kulikovskiy N.P. Handbook of amateur astronomy. -3 ed. M.: Fizmatgiz, 1961. C. 353.
11. Atsyukovskiy V.A. Logical and experimental foundations of the theory of relativity. Analytical review. Moscow: Izd-vo MPI, 1990; Critical review of the theory of r e l a t i v i t y . Zhukovskiy: Izdvo "Pettit," 1996.
12. Yarkovskiy I.O. World gravitation as a consequence of formation of weighty matter inside celestial bodies. Kinematic hypothesis. M.: Tip. lit. of Kushnerov's t-va. 1912.
13. Gusarov V.I. Interconversion of fields and matter - a single process of existence, motion and development of matter. Saratov: Izd. of Saratov State University. 1972.
14. Blinov V.F. Nasha Zbylshulyaetsya? // Nauka i Suspilstvo. № 6. 1979. C. 41-44.
15. Blinov V.F. On the problem of possible growth of the Earth// Geophys. Sb. of the Academy of Sciences of the Ukrainian SSR. 54. Kiev: Izd. of the Academy of Sciences of the Ukrainian SSR. 1973. C. 85.
16. Blinov V.F. Development of the Pacific Ocean according to the data of sedimentation and magnetic anomalies// Geol. Zh., 1977. 2. C. 82-90.
17. Blinov V.F. Earth Expansion or New Global Tectonics // Geophys. Sb. Kiev: Izd. of the Academy of Sciences of the Ukrainian SSR, 1977. Vyp. 80. C. 76- 85.
18. Udintsov G.B. Rift Zones of the Oceans// Science and Mankind. Moscow: Znanie, 1969.
19. Chudinov Yu.V. Expansion of the Earth as an alternative to the new global tectonics// Geotectonics. 1976. T. 4. C. 16-36.

20. **Steiner J.** An expanding Earth on the basis of seafloor spreading and subduction rates. *Geology*/ 1976/ Vol. 5. № 5. P. 313-318/
 21. **Carey S.W.** Theories of the Earth and Universe. A History of Dogma in the Earth Sciences. Stanford, California, 1988.

Further reading

22. Kittel Ch. Statistical thermodynamics: Per. from Engl. Ed. S.P.Kapitsa. Moscow: Nauka, 1971.
 23. **Jeans J.H.** Introduction to the kinetic theory of gases. Cambr. Univ. Press. 1940, ch. 5.
 24. **Thomson W.** Dynamical theory of warmth. Math. and Phys. Papers, 11-6, 1882-1911.
 25. **Pippard A.B.** Elements of classical Thermodynamics. Cam. 1957.
 26. Einstein A. Explanation of the motion of Mercury's perihelion. *Sobr. nauk. tr. M.: Nauka*, 1965. T. 1. C. 439-447.
 27. Vavilov S.I. Experimental bases of the theory of relativity (1928)// *Collected Works*, Moscow: Izd. of the USSR Academy of Sciences, 1956. T. 4.. C. 90-94.
 28. Gorshkov P.M. *Izvestiya russkogo astronomicheskogo obshchestva*. 1923. Vyp. 25.
 29. Tonella M.A. Fundamentals of electromagnetism and the theory of relativity: Per. from French // Edited by G.A.Zaitsev. MOSCOW: IIL, 1962. C. 351.
 30. Chebotarev G.A. Celestial mechanics. BSE - 3rd ed. Moscow: Soviet Encyclopedia. 1974. T. 17. C. 387.
 31. Roxburgh D. The rotation of the Sun and the motion of the perihelions of the planets. *RZ Astronomy*, 1966. T. 3. № 51. C. 711.
 32. Gurov G.A. What is the Universe. Moscow: Znanie, 1950. C. 161.
 33. Baranov V.B., Krasnobaev K.V. Hydromechanical braking of the solar wind by the interstellar medium// *Aeromechanics and Gas Dynamics*. M.: Nauka, 1976. C. 280-295.
 34. Veselov K.E. Gravitational field and geologic development of the Earth// *Sov. geologiya*. 1976. № 5. C. 70-80.
 35. Kirillov I.V. About a possible direction of the Earth development process// *Astron. vestn.* 1973. T. 7, № 2. C. 113-117.
 36. Neiman V.B. Expanding Earth. Moscow: Geografizdat, 1962.
 37. Neumann V.B. **Transformations** in Nature. Current state of the question and tasks of further research// *Questions of transformations in nature. Concentration and dispersion*. Yerevan: Hayastan, 1971. C. 5-25.

38. Milanovsky E. Pulsating Earth// Science and Religion. 1985. № 3. C. 15-19.

By Chapter II.

1. Galileo G. Selected Works. Moscow: Nauka, 1964. T. 1-2.
2. Naan G.A. Cosmology. BSE -3-e ed. M.: Soviet Encyclopedia, 1973. T. 13. C. 256-258.
3. Zeldovich Y.B., Novikov I.D. Relativistic astrophysics. M., 1967.
4. Observational bases of cosmology. Collection of articles. Transl. from Engl. M.: Mir, 1965.
5. Hambardzumyan V.A. Cosmology and Modern Astrophysics// Scientific Works. Yerevan: Izd. SSR. 1960. T. 2.
6. Aghekyan T.A. Stars, galaxy, metagalaxy. M.: Nauka, 1969. C. 632-637.
7. **Kaplan S.A., Picklner S.B.** Ann. Rev. Astron. and Astrophis. 1974. Vol. 12. P.113.
8. Vorontsov-Vel'yaminov B.A. Essays on the Universe. -6th ed. M.: Nauka, 1969. C. 632-637.
9. Eigeson M.S. Extragalactic Astronomy. Moscow: Fizmatgiz, 1960.
10. Structure of stellar systems: Transl. from Engl./ Edited by P.N.Khokhlov. Moscow: Izd. of Foreign Literature, 1962.
11. Einstein A. Draft of the generalized theory of relativity and the theory of gravitation (1913). Physical foundations of the theory of gravitation (1913). Formal foundations of the general theory of relativity (1914). Toward a general theory of relativity (1915). Foundations of the general theory of relativity (1916). Questions of Cosmology and the General Theory of Relativity (1917). Sobr. nauchn. tr. M.: Nauka, 1965. VOL. 1. PP. 227-298; 326-384; 425-434; 452-504; 601-612.
12. Geophysical Compendium. T. 5, vol. 1. L., 1927. (Dedicated to the memory of A.A.Fridman).
13. **Hubble E.P.** A general study of diffuse galactic nebulae. The Astrophis. J. 56, № 3. 1922.30. The realm of the nebulae. N.Haven. Lond. 1936. The observation approach to cosmology. Oxf. 1937.
14. Levin B.Yu. Pikelner S.B. Cosmogony. BSE - 3rd ed. Moscow: Soviet Encyclopedia, 1973. T. 13. C. 251-254.
15. Questions of Cosmogony. Moscow: Izd. of the USSR Academy of Sciences, 1952-1964. T. 1-10.
16. Schwarzschild M. Structure and Evolution of Stars// Per. from Engl. M.: IIL, 1961.
17. Kaplan S.A. Physics of Stars. -2nd ed. M.: Nauka, 1970.

18. Problems of Modern Cosmogony. -2nd ed. Edited by V.A.Ambartsumyan. Moscow: Nauka, 1972.
19. Halton S.A. Evolution of galaxies// What physicists think about. Moscow: Nauka. 1967. Vyp. 6. C. 92-110.
20. Drozhzhzhin-Labinsky Y.G., Komberg B.V. Nuclei of galaxies// BSE -3rd ed. Moscow: Soviet Encyclopedia, 1978. T. 30. C. 454-455.
21. Vulis L.A., Polatnik I. On the mechanism of turbulent mixing in gas flows// Engineering. -phys. zh. 1961. T. 4. № 9.
22. Townsend A.D. Structure of a Turbulent Flow with Transverse Shear: Per. with English / Edited by A.N.Kolmogorov. MOSCOW: IIL, 1959.
23. Ginevskiy A.S. Theory of turbulent jets and traces. M.: Mashinostroenie, 1969.
24. Van Drayst. Turbulent boundary layer in compressible fluids// Mechanics. Collection of translations No. 1 (11). Moscow: Mir, 1952. C. 27-55.
25. Schlichting G. Emergence of Turbulence: Transl. from English / Edited by L.G.Loitsiansky. Moscow: Izd. of Foreign Literature, 1962.
26. Nekrasov A.I. Diffusion of a vortex// Collected Works, Moscow: Izd. of the USSR Academy of Sciences, 1961. T. 1. C. 92.
27. Kolmogorov A.N. Energy dissipation at locally isotropic turbulence. Moscow: Izd. of the USSR Academy of Sciences, 1941.
28. Tsiolkovsky K.E. Ether Island. Collected articles. "The Way to the Stars". M., ANS SSSR, 1960. C.317-326.
29. Whitney Ch. **The** Discovery of our Galaxy. M.: Mir, 1975.
30. Spoelstra T.A.T. **The** magnetic field of galaxies. UVN. 1977. T. 121, vol. 4. P. 679-694.
31. Kulikovskiy P.G. Handbook of an amateur astronomer. -3rd ed. M.: Fizmatgiz, 1961. C. 154.
32. Einasto J.E. Evolution of galaxies// Problems of Observational and Theoretical Astronomy. Observations and Research of the Universe. M.-L.: Izd. of the USSR Academy of Sciences, 1977. Vyp. 6. C. 26-41.
33. Gorbatsky V.G., Kritsuku A.G. Galaxy clusters. Moscow: Nauka, 1987.
34. Gorbatsky V.G. Introduction to the Physics of Galaxies and Galaxy Clusters. Moscow: Nauka, 1986.
35. Gurevich L.E., Chernin A.D. Origin of galaxies and stars. - 2nd ed. M.: Nauka, 1987.
36. Doroshevich A.G., Efremov Y.N., Zasov A.V. Origin and Evolution of Galaxies and Stars. Moscow: Nauka, 1976.
37. Zasov A.V. Physics of Galaxies. M.: Izd-voor MSU, 1995.
38. Zasov A.V. Dwarf galaxies.M.: Znanie, 1984

39. Zonn W. Galaxies and quasars. M.: Mir, 1978.
40. Labuzov A.S. Observations of galaxies, nebulae and star clusters. M.: Fizmatlit, 1993.
41. Mitton, Simon. **The** study of galaxies. Moscow: Mir, 1980.
42. Suchkov A.A. Galaxies familiar and unfamiliar. Moscow: Nauka, 1988.
43. Hodge A.D. Galaxies: Transl. from English / Edited by Yu.N.Efremov. Moscow: Nauka, 1992.
44. Teyler R.J. Galaxies: Structure and Evolution. M.: Mir, 1981.
45. Vorontsov-Veliaminov B.A. Morphological catalog of galaxies. Moscow: Izd. of Moscow State University, 1962.
46. Vorontsov-Vel'yaminov B.A. Essays on the Universe. Moscow: Nauka, 1969.
47. Karachentsev M.D. Double Galaxies. M.: Nauka, 1987.
48. Narlikar J. **The** Unreal Universe: Transl. from English / Edited by I.D.Novikov. M.: Mir, 1985. C. 192-197.
49. Parenato P.P. Course of stellar astronomy. -3rd ed. M.: Gostekhtheorizdat, 1954.
50. Zonn W., Rudnicki K. Stellar Astronomy: Per. from Polish / Edited by P.P.Parenato. MOSCOW: IIL. 1959.
51. O. Struve, B. Linds, E. Pillans. Elementary Astronomy. Moscow: Nauka, 1967.
52. Dubov E.E. Sun// BSE. -3rd ed. M.: Soviet Encyclopedia, 1979. T. 24/1. C. 150-154. 1967.
53. Vorontsov-Vel'yaminov B.A. Laplace. M.: Nauka, 1985. C. 118-157, 221-274.
54. Ressel G.N. Solar system and its origin: Transl. from English / Edited by N.N.Parijskij. M. - L.: Gostekhtheorizdat, 1944.
55. Brand J., Hodge P. Astrophysics of the Solar System: Transl. from Engl./ Edited by G.A.Leikin. M.: Mir,
56. Ether Wind. Collection of articles, ed. by Dr. V.A. Atsyukovsky. Moscow: Energoatomizdat, 1993.
57. Shpitalnaya A.A. On the spatial asymmetry of nonstationary processes in the Solar System// Development of methods of astronomical research. M. - L.: VAGO ANS SSSR, 1979. C. 538- 542.
58. Schlichting G. Boundary layer theory: Per. from German / Edited by L.G.Loitsiansky. Moscow: Nauka, 1974.
59. Dobrovolsky O.V. Comets. BSE - 3rd ed. M.: Soviet Encyclopedia, 1973. T. 13, c. 500-502.

60. Orlov S.V. On the Nature of Comets. Moscow: Izd. of the USSR Academy of Sciences, 1958.
61. Vsekhsvyatsky S.K. Nature and Origin of Comets and Meteoric Substance. Moscow: Prosveshchenie, 1967.
62. Dobrovolsky O.V. Comets. Moscow: Nauka, 1966.
63. Fesenkov V.G. Solar comet cloud and interstellar space. Earth and the Universe. 1965, № 4.
64. Chernyaev A.F. Stones Falling into the Sky. Moscow: Izdvo "Belye Alvy", 1992; same, 1998.
65. Masaitis V.L., Maschak M.S., Naumov M.V. Puchezh-Katun astrobol: a model of the structure of a giant impact crater. Astronomical Bulletin. 1996, т. 30, № 1. С. 5-13.
66. Novikov I.D. Thermal death of the Universe// BSE. -3rd ed. Moscow: Soviet Encyclopedia, 1976. Т. 25. С. 443.
67. Boltzmann L. Essays on the methodology of physics: Transl. from German. / Edited by S.F.Vasiliev. Moscow: Izd. of Timiryazev Scientific Research Institute, 1929.
68. Zelmanov A.P. Photometric paradox. Physical Encyclopedic Dictionary. Moscow: Soviet Encyclopedia, 1960. Т. 1. С. 489.
69. Kaplan S.A., Tsikel S.B. Interstellar Medium. Moscow: Gostekhteorizdat, 1956.
70. Zelmanov A.P. Gravimetric paradox. Physical Encyclopedic Dictionary. Moscow: Soviet Encyclopedia, 1960. Т. 1. С. 489.
71. Galaev Yu.M. Ether wind effects in radio wave propagation. Radiophysics and Electronics. Т. 5, № 1. С. 119-132. Kharkov, publishing house of the National Academy of Sciences of Ukr. 2000.
72. Shevnin A.D. Earth magnetism. // BSE - 3rd ed. М.: Soviet Encyclopedia, 1972. Т. 9. С. 502-504.

Научное издание

Ацюковский Владимир Акимович

доктор технических наук, академик РАЕН

Общая эфиродинамика

**МОДЕЛИРОВАНИЕ СТРУКТУР ВЕЩЕСТВА И ПОЛЕЙ НА
ОСНОВЕ ПРЕДСТАВЛЕНИЙ О ГАЗОПОДОБНОМ ЭФИРЕ**

Иллюстрации Погореловой Т. В.

Корректор Севастьянова Е. П.

Энергоатомиздат, 115114, Шлюзовая набережная, д. 10

Подписано в печать 30.01.2003 г. Формат 60x90 1/16.

Бумага офсетная № 1. Печ. л. 36,5. Усл. печ. л. 36,5.

Тираж 1000 экз. Заказ 23

Отпечатано с диапозитивов в ГУП «Облиздат»

248640 г. Калуга, пл. Старый торг, 5