

PRIMARY AND SECONDARY COILS  
Experimental Unit at Bolinas, California, 1981

**DISCLAIMER:**

This material was written early in the project and is in need of extensive revision. Pages 1-16 result from experimental investigations and theoretical considerations while at my lab in the Marconi Wireless Building (R.C.A.), at Bolinas, California, from 1980-1981. Pages 22-25 are taken from reference (2) and adapted for relation to Tesla Coil waves. Pages 25-31 are taken from reference (3) and serve as an illustration of how the Tesla Magnifying Transmitter can extract energy from the Earth's resonant electric field.

Eric P. Dollard  
March 22, 1986



P.O. BOX 429 ★ GARBERVILLE, CA 95440-0429 ★ U.S.A.

## THE TESLA TRANSFORMER

© 1986 E.P. DOLLARD

At the turn of the century Tesla was in the process of devising a means of wireless power transmission. The transmission involved the generation of longitudinal ether waves. Whether Tesla accomplished this is not known, but the idea was considered by other notables such as Kelvin and Maxwell. Kelvin\* considered it possible to generate "longitudinal waves in the luminiferous ether" thru the phenomena of displacement current (capacity current  $\partial D/\partial t$ ). He goes on to indicate his feeling that these waves must be faster than light, as the longitudinal waves in a steel rod move with much greater velocity than the transverse waves. Tesla claims that the waves from his transformer propagate at  $\pi/2$  the velocity of light. It is interesting to note that the velocity measured on the Tesla coil is also  $\pi/2$  greater than the velocity of light but this does appear to be a phase velocity rather than a group velocity.

In his writings Tesla indicates some seemingly impossible phenomena surround the emanations from the spherical terminal capacity, and I have determined these to be true by experiment. One is that the power gradient (poynting vector) is in the same axis as the dielectric flux gradient. The other is the slow formation of a conductive area surrounding the sphere that is not ionic in nature (in other words is not a spark or glow discharge).

Contrary to popular relief, the Tesla transformer is not a

\*See reference 6.

steady state device but is a magnifier of transient phenomena. Also it does not behave like a L. C. network nor a transmission line, but more like a unique type of wave guide. If all parts of the system are designed properly the EMF and hence dielectric flux jumps from zero to an enormous value almost instantaneously, thereby producing an almost inconceivable displacement current into space. The transformer is then basically a device for rapidly discharging the capacitor bank nearly instantly into free space, producing an enormous dielectric shock wave similar to a sonic boom.

Because the dissipation of the transformer is for all practical purposes negligible, the energy keeps increasing at a linear rate per cycle of oscillation, thereby accumulating a gigantic quantity of electrical energy. (A form of laser action may be possible.)

In order for the transformer to resonate with the planet the energy storage in the active region that grows around the sphere terminal must equal the conjugate energy storage of the earth, a stiff requirement.

It is interesting to note that dielectric breakdown in this active region grow into a log periodic form based on  $X^2 - X = 1$  as the log base. This will be recognised as the transcendental PHI or the Golden Ratio. In glow discharges the ions of metallic elements form stable spheres of diameter inverse to the atomic weight of the element involved.

The transformer's principals of operation are as follows:

The first requirement is the sudden collapse of an energy field thereby producing a sudden impulse of energy, second is the

FIG 1a TESLA MAGNIFICATION TRANSFORMER

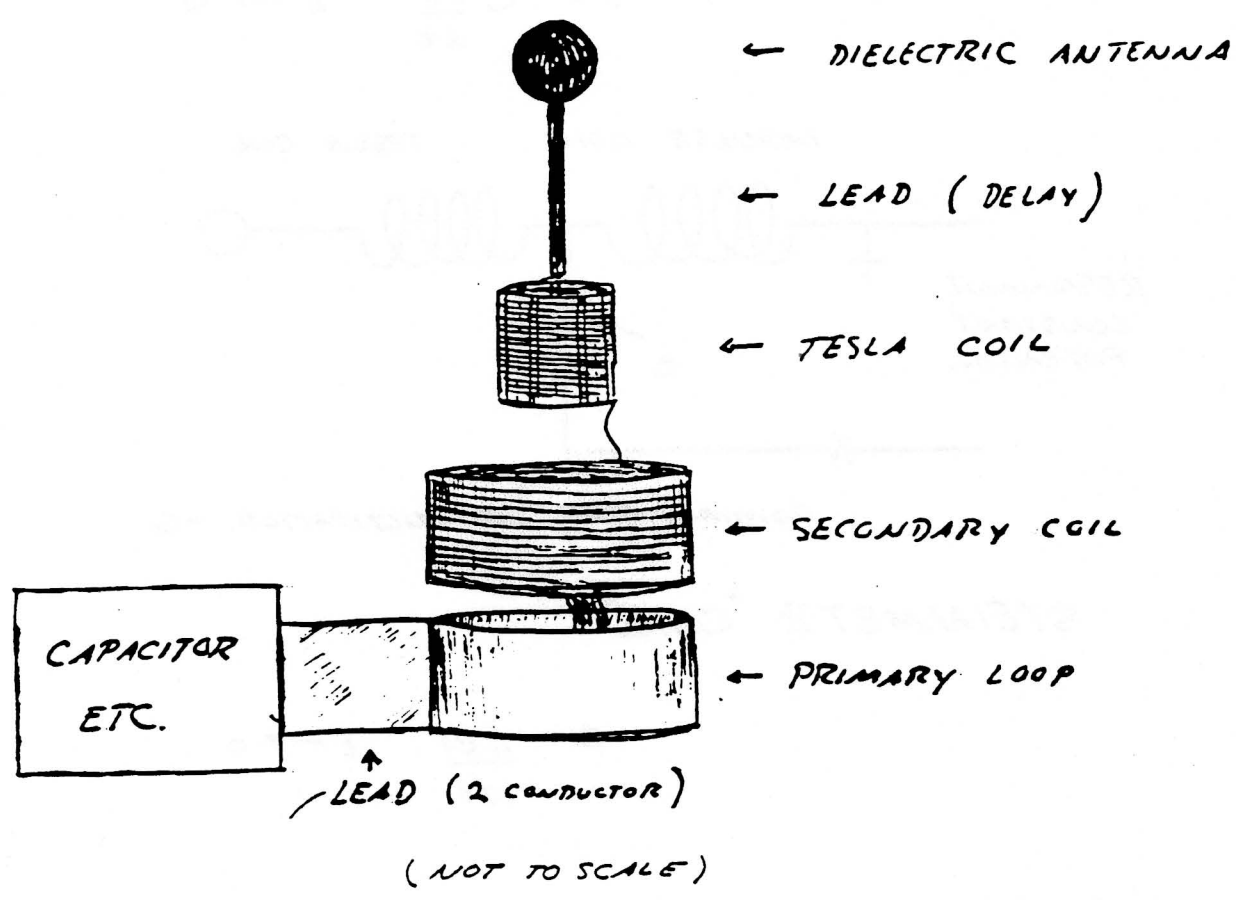

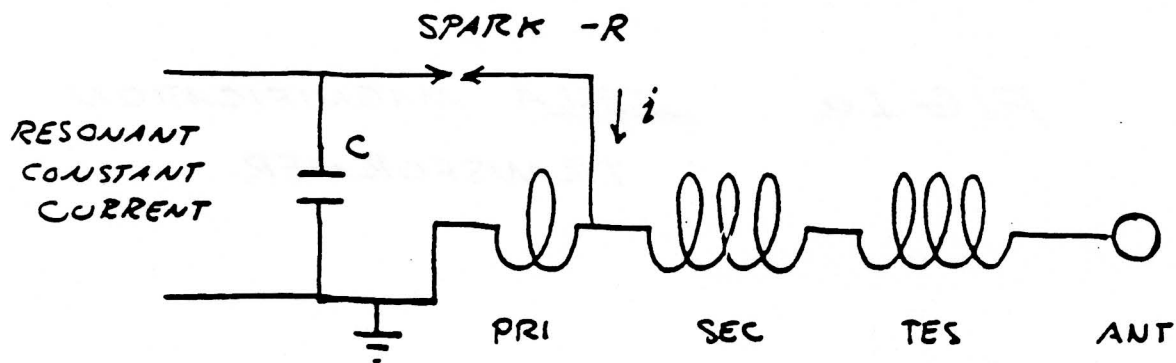

TESLA "COIL"

$$i = C \frac{de}{dt} \quad t \rightarrow 0$$

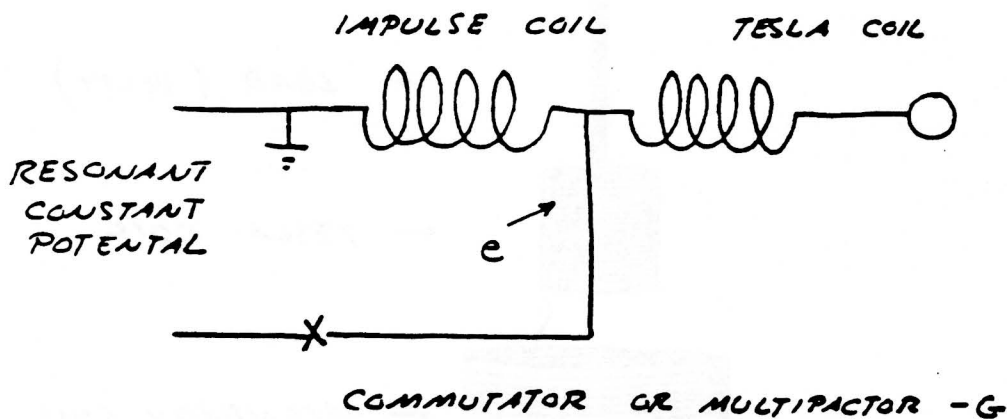

STEINMETZ "COIL"

$$e = \frac{L di}{dt} \quad t \rightarrow 0$$

FIG 16

R = RESISTANCE    G = 1/R

transforming properties of the odd harmonic ordered single wire delay line (coil) which allow for the production of enormous E.M.F. and M.M.F., and third, the dielectric phenomena surrounding the free space capacity terminal.

1) The formation of the energy impulse involves the discharge of a capacitor with the highest practical stored energy into an impedance (inductive) of the lowest practical value, and the discharge path is coupled to an energy supply through a negative resistance device. This negative resistance is classically a spark discharge, but a superior plasma device needs to be developed to enhance efficiency. Under optimal conditions the exponent of oscillation amplitude will be positive over a sustained period of time.

The net result of this system is the production of an extreme impulse of M.M.F. of great  $d\phi/dt$ . An alternate method is the discharge of an inductor of the highest practical stored energy into a circuit of the lowest practical admittance, thereby producing an enormous impulse of E.M.F. of great  $d\psi/dt$ .

2) The energy impulse generated by the aforementioned methods is then coupled into a pair of single wire transmission systems. Through induction a strong travelling wave is formed. Due to the impedance transforming properties of the odd ( $\lambda/4$ ,  $3\lambda/4$ , etc) order line, the E.M.F. of the wave is converted into lightning magnitudes, still retaining the extreme  $d/dt$  of the initial discharge.

The capacitive discharge method of impulse generation is Tesla's favorite, but Steinmetz shows that inductive discharges will also work.

The capacitor contains the initial energy of the oscillating system. The buss from the capacitors to the primary loop should have a negligible transient impedance. The capacitors should be of the bolt on vacuum type, however, the unique dielectric properties of water might be of advantage as capacitor plates. The capacitors must be in symmetrical arrangement with the primary coil. The primary must be of one turn only and exhibit the lowest practical impulse reactance  $Z(P) P=di/dt$ . Tesla indicates the proper length of the primary conductor to be  $\lambda/2=Kn$ , where  $n$  is a harmonic number convenient for the size of the unit and  $K$  is unspecified. Also unspecified is if this value is free osc. disconnected from the capacitors or is LC dependent.

The transmission network consists of two  $\lambda/4$  single wire transmission systems of negligible radiation loss. The first of these is called the secondary coil. The next is called the "extra coil" by Tesla, but henceforth will be called the "Tesla Coil". This network or line is typically absent in most units purporting to be Tesla transformers.

The secondary coil serves as a matching network between the wave generating primary loop and the Tesla coil. The magnetic coupling factor "k" between the PRI and SEC coils is typically 20%. Negligible magnetic coupling should exist between the secondary and Tesla coils.

The function of the secondary is three fold. The first is the transforming of the primary M.M.F. pulse into an abrupt travelling electric wave. Second, to provide a constant potential constant current transformation for good voltage regulation at the output terminal of the Tesla coil, and third is to match the drive impedance of the Tesla coil to the drive impedance of the earth. \*(next page)



The secondary coil is of a low characteristic impedance of the value  $Z_S = \sqrt{Z_P Z_T}$ . This low impedance requires it to be of high self capacity. This capacity is best facilitated by flat spiral coils of wide strip, or by short coils of wide strip, or by short coils of wide strip wound edgewise. The diameter of the secondary must be very nearly that of the primary loop.

3. Connected to this secondary coil is an additional coil, the Tesla coil. This is where the magnification properties are most pronounced. This line or coil is also  $\lambda/4$  long however, it must possess the minimum possible self capacity, resulting in the highest possible characteristic impedance, thereby facilitating the greatest possible magnification of E.M.F. by the relation  $E_o = Z \cdot I_{in}$ .

The self capacity of the coil is minimum when the diameter is equal to length, roughly 1  $\mu$ F per centimeter of diameter. The velocity of propagation along this coil is  $\sqrt{2}$  times the velocity of light due to the distributed shunt capacity. This results in pronounced capacity effects when the coil is operated higher in frequency than resonance. It will discharge a rate much faster than the angular velocity of free oscillation, producing explosive phenomena. The self capacity of the terminal sphere brings the frequency of OSC down to that of light velocity by acting as a shunt capacitor load across the coil. There can be considerable energy radiation from the capacity terminal. Steinmetz equations show a power factor as high as 40% is possible.

Dielectric radiation from the Tesla coil itself must be minimized.

\* It should be noted that the primary acts as a halfwave, therefore exhibiting no impedance transforming properties.

→ INPUT VOLTAGE, IMPULSE

$$E_{IN} = \sum_{n \rightarrow \infty} A_n \sin n\omega t + A_3 \sin 3\omega t + A_5 \sin 5\omega t + \dots$$

→ COIL GRADIENT, DISTORTED STEP

$$E_s = \sum_{n \rightarrow \infty} -B_n \sin v_n x + B_3 \sin 3v_3 x + B_5 \sin 5v_5 x + \dots$$

→ OUTPUT VOLTAGE, DISTORTED IMPULSE

$$E_o =$$

$$\sum_{n \rightarrow \infty} -A'_n Z_n \cos \omega t + \phi_n - A'_3 Z_3 \cos 3(\omega t + \phi_3) - A'_5 Z_5 \cos 5(\omega t + \phi_5) + \dots$$

$A_n \equiv$  VOLTAGE AMPLITUDE FACTOR, TIME

$B_n \equiv$  VOLTAGE AMPLITUDE FACTOR, SPACE

$A'_n \equiv$  CURRENT AMPLITUDE FACTOR, TIME

$\omega \equiv 2\pi F$ , ANGULAR VELOCITY     $F \equiv$  FREQUENCY

$v_n \equiv$  WAVE VELOCITY FACTOR

$\phi_n \equiv$  PHASE LEAD, FUNCTION OF WAVE VELOCITY

$t \equiv$  TIME

$x \equiv$  DISTANCE

$n \equiv$  HARMONIC NO

$Z_n$  CHARACTERISTIC IMPEDANCE OF COIL

FIG 26

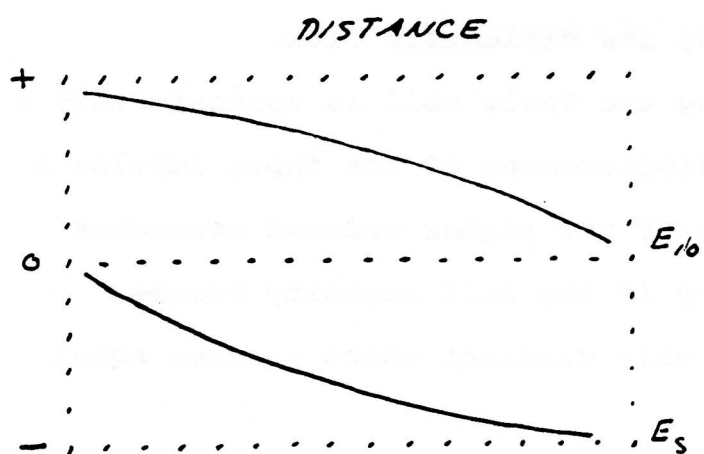

$$F_0 \quad \lambda/4$$

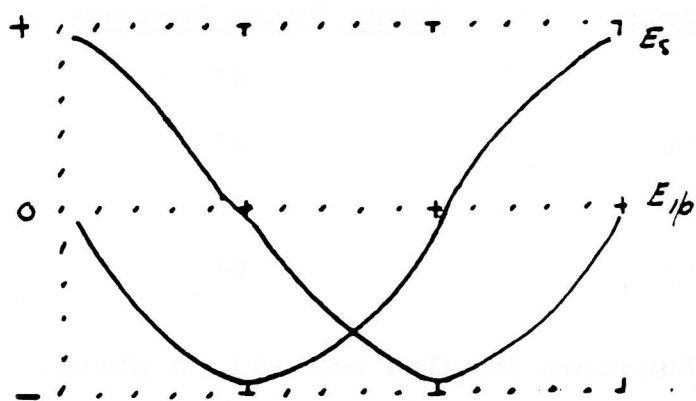

$$3F_0 \quad 3\lambda/4$$

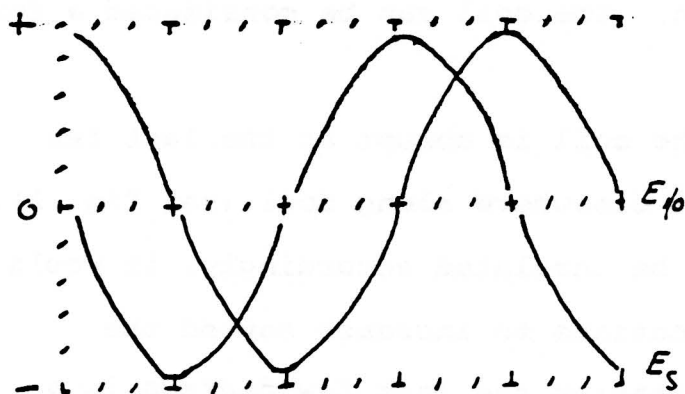

$$5F_0 \quad 5\lambda/4$$

$E_s = \text{GRADIENT}$

$E_{10} \text{ IN/OUT}$   
OR

This is achieved by concentric configuration with the primary/secondary system thereby enclosing its dielectric flux.

The potential gradient along the Tesla coil is approximately a step function due to the phase displacement of the input impulse's harmonics, however, the velocity of the higher ordered overtones become proportionate to frequency if the self capacity becomes significant, thereby distorting this gradient which assumes equal velocity for all overtones.

Consider the table.

<u>Frequency</u>	<u>Coil Length in Degrees</u>	<u>Input Pulse Degrees</u>
$F_0$	$90^\circ$	$0^\circ$
$3F_0$	$270^\circ (-90^\circ)$	$0^\circ$
$5F_0$	$450^\circ (+90^\circ)$	$0^\circ$
$7F_0$	$630^\circ (-90^\circ)$	$0^\circ$

The harmonics of the time function impulse are all in phase, however, the harmonics of the space function are all out of phase and is therefore a step function. The coil can be considered a form of differentiator.

Hence the gradient along the coil is abrupt at the last few degrees of coil length but small elsewhere along coil (see Fig. 2). The last turns of the coil must be insulated accordingly, it would seem possible the gradient to continue to increase beyond the dielectric terminal!\* By facilitating the last few degrees in a lead from coil to terminal, the gradient can be made to appear along the lead rather than in the coil, minimizing capacity and flashov.

\*EMF then also becomes greater farther from terminal, possible reaching astronomical magnitudes.

problems. The dielectric radiation from this lead will be small as it is immersed in the sphere's flux. No data exists as to the ratio of the size of the sphere and earth.

The complete Tesla transformer is shown in Fig. 3. The electrical length is 360 degrees at the fundamental of oscillation. The earth connection must have negligible transient impedance, a star radial system preferred. The earth terminal is the M.M.F. counterpart to the E.M.F. capacity terminal. Like the capacity terminal, it is quite possible that the magnetic gradient and force will increase as the wave penetrates the earth. Hence the 5 sections of the Tesla transformer:

1. Earth
2. Primary system/ power supply
3. Secondary wave coil
4. Tesla or magnification coil
5. Dielectric antenna

It should be born in mind that Tesla designed this system for the transmission of electric waves.\* This is hardly desirable for lab work as severe damage to unprotected apparatus and electrical interference can result. To confine the energy an image coil (180° shift) must be connected to the earth terminal. Making this arrangement in a horseshoe configuration produces intense dielectric flux and displacement current that is quite usefull for plasma work.

Due to the immense difficulties surrounding the spark device, a simple method and one of much greater control is shunt feed of the primary network by an A.M. radio transmitter of special design such as the unit at building number one. Due to the high impedance

\*The theories of radio at that time considered transmission thru existin lines of force or "ether tensions".

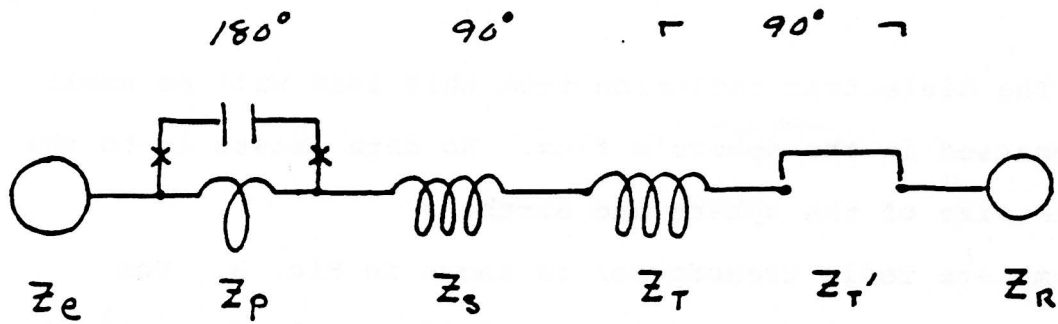

FIG 3

$Z_e$  EARTH  $\lambda/4n$

$Z_p$  PRIMARY  $\lambda/2$   $180^\circ$   
 $\&$   $\lambda/2n'$   $180^\circ/2n'$

$Z_s$  SECONDARY  $\lambda/4$   $90^\circ$

$Z_T$  TESLA  $\lambda/4 - \lambda_{T'}$  }  $90^\circ$   
 $+ Z_{T'}$  LEAD  $\lambda_{T'} = \lambda/H$

$Z_R$  DIELECTRIC ANT.  $\lambda/4n'' ?$

$n, n', n'' \equiv$  HARMONIC NUMBERS

$H \equiv$  DELAY FACTOR

$\lambda_0 \equiv$  WAVE LENGTH

$\lambda \equiv$  DISTANCE

$$Z_p^0 + Z_s^0 + (Z_T^0 + Z_{T'}^0) = 360^\circ \text{ OR ONE WAVELENGTH}$$

FIG 4

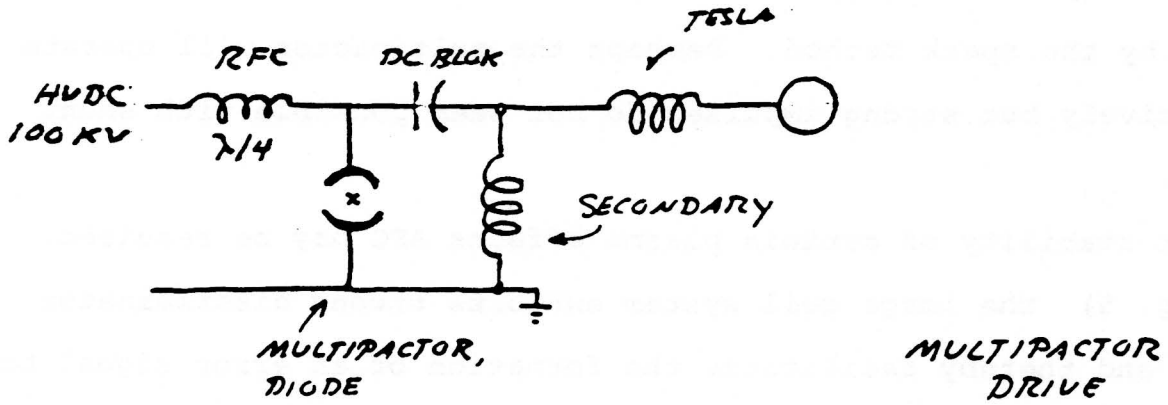
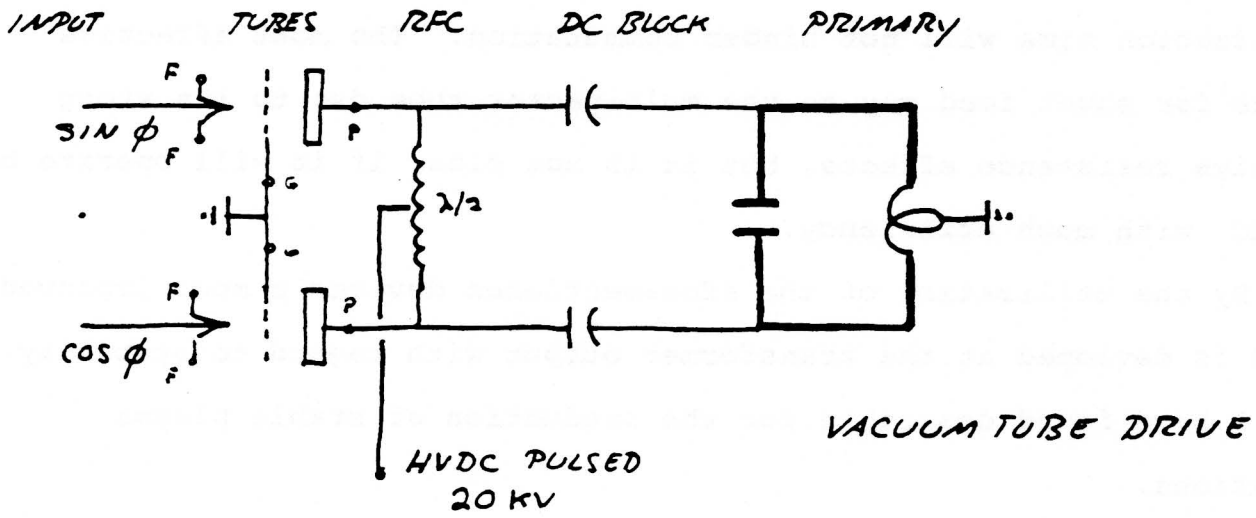
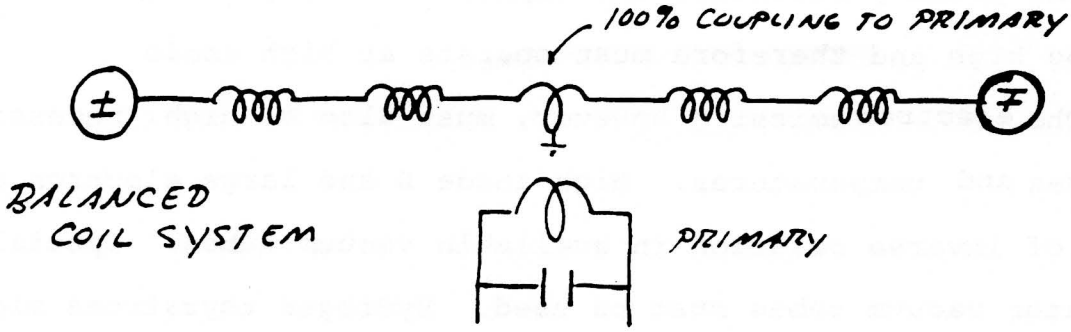

offered by the primary resonator the impedance effective of the tubes must be high and therefore must operate at high anode voltages. The electron emission however, must also be high, necessitating large cathodes and temperatures. High anode  $\mathcal{E}$  and large electron emission are usually of inverse relation in available vacuum tubes. Special pulse modulator vacuum tubes must be used. Hydrogen thyratrons might operate satisfactorily at low frequencies where the 1 microsecond deionization time will not hinder commutation. The most effective device for shunt feed may be the multipactor tube due to its strong negative resistance effects, but it is not clear if it will operate below 1000KC with much efficiency.

By the utilization of the aforementioned devices a much improved field is developed at the transformer output with regard to stability. This I have found desirable for the production of stable plasma formations.

However, I have not noticed the "jamming together of electrons" unless the spark method is used as the rate of rise of EMF is much greater by the spark method. Perhaps the multipactor will operate comparatively but strong impulses do not seem possible with shunt methods.

For stability of certain plasma effects AFC may be required. (See Fig. 5) The image coil system exhibits strong discriminator effects and thereby facilitates the formation of an error signal to the V.C.O.

As to physical construction the primary should be sheet copper of great conductor width and large loop area. Large surface is required as the skin effect is total with impulses. Large width also minimizes inductance allowing for larger capacitors and more



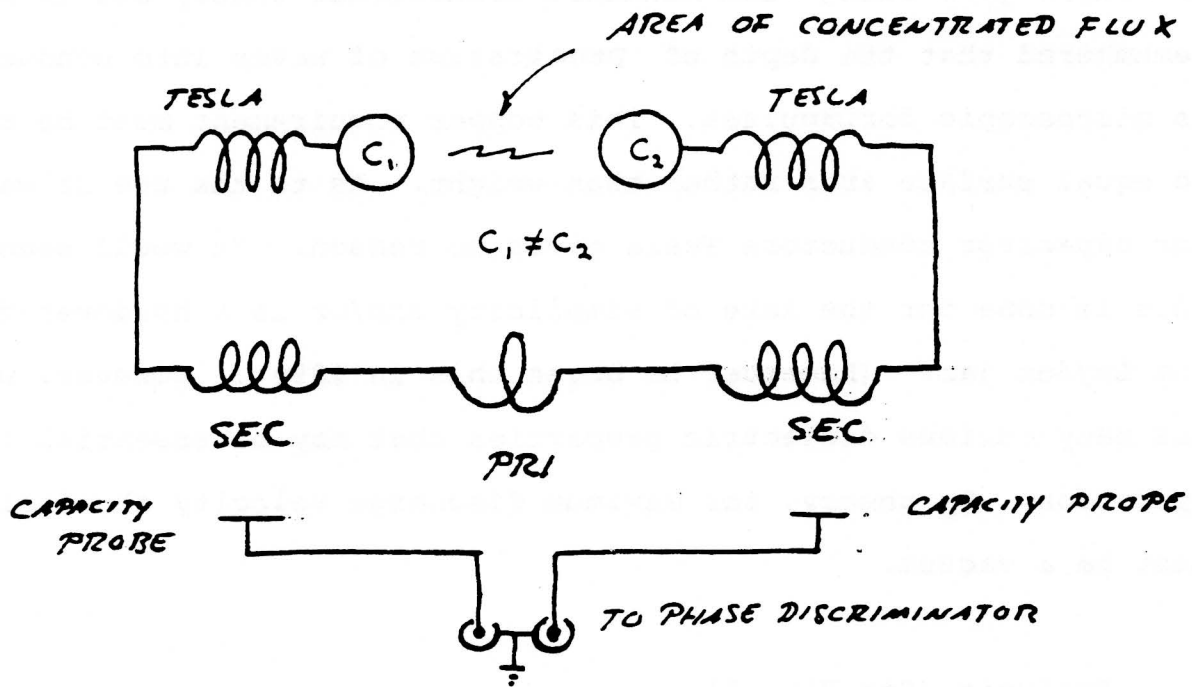
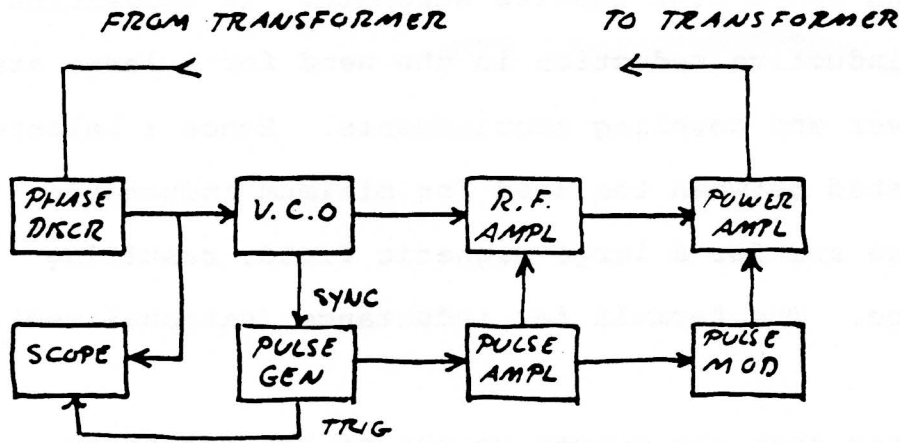

FIG 5

- SETUP FOR PLASMA WORK -

SCOPE SHOWS SIZE OF PLASMA WITH RESPECT TO TIME.

rapid discharge and hence high impulse strength. In opposition to this required inductive reduction is the need for a large area due to the flashover and coupling requirements. Hence a balance has to be established between the need for minimum inductance for rapid discharge and for a large magnetic field, resulting in large inductance. The formula for inductance (rationalized) is  $L = \text{area}/\text{width}$ .

Tesla indicates that the copper weight of the secondary must equal that of the primary for maximum efficiency. This of course goes along with standard transformer theory but it must be remembered that the depth of penetration of waves into conductors is microscopic for impulses. This copper requirement must be modified to equal surface area rather than weight. As to the use of water for capacitor conductors Tesla gives no reason. It would seem that this is done for the sake of simplicity and/or is a holdover from the Leyden jar. (Remember he began this in 1890). However, water has many curious dielectric properties that may be essential in operation. By theory, for maximum discharge velocity the dielectric must be a vacuum.

#### Analysis (See Fig. 6)

The oscillating coil differs from the transmission line on account of turn to turn capacity and distributed mutual induction.

The presence of series capacity causes the coil to respond as a capacitor network (with no inductive effect) towards abrupt impulses and angular velocities greater than the angular velocity of free oscillation.

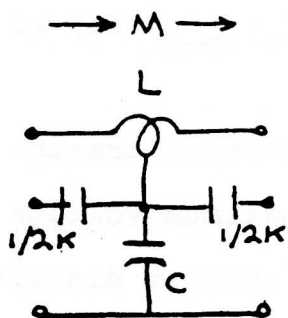

ELEMENT OF  
TESLA COIL ( $dx$ )  
3 PATHS OF FLOW

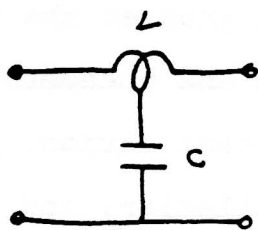

ELEMENT OF  
2 WIRE LINE ( $dx$ )  
1 PATH OF FLOW

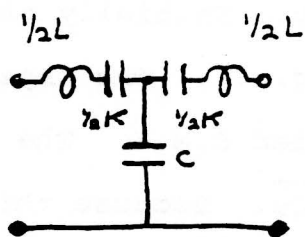

ELEMENT OF  
WAVEGUIDE ( $dx$ )  
1 PATH OF FLOW

$TM_{01}$ , CIRCULAR

FIG 6

$M$   $\equiv$  MUTUAL INDUCTION  
 $K$   $\equiv$  MUTUAL CAPACITY  
 $C$   $\equiv$  SHUNT CAPACITY  
 $L$   $\equiv$  SERIES INDUCTANCE

The voltage distribution along the coil at the first instant depends on the factor  $a = \sqrt{C_g/C_s}$ .  $C_g$  = capacity to ground,  $C_s$  = capacity from end to end.

The greater  $a$ , the greater the concentration of voltage at the feed end of the coil. The maximum voltage per unit length is equal to  $a$  times the voltage of uniform distribution.  $a$  is a small fractional value with Tesla coils.

The greater the  $d/dt$  or  $\omega$  the greater the gradient of voltage.

If the impulse has a long tail the phenomena will be as described but followed by a damped oscillation. (OSC)

By impressing a sustained oscillation, and if the coil has a small dissipation constant  $u$ , the voltage will continue to increase indefinitely. Initially the coil acts as a capacitor ladder network (See Fig. 7). The capacity elements are charged to nearly twice the applied E.M.F. The effective capacity being charged is  $C = \sqrt{C_g C_s}$ . Because this network contains impedance elements of only one type the voltage distribution is hyperbolic rather than periodic. If  $\% = \text{distance}/\text{total length}$  and  $e$  is voltage to ground at the particular distance,  

$$e = E_0 \frac{\text{COSH } a \%}{\text{COSH } a}$$
 For Tesla coils this distribution should be as linear as possible (small  $a$ ).

As the distribution goes from initial to final the voltage can be analyzed into a complex series of decremental waves at various frequencies and wavelengths. This is accomplished by analyzing the initial distribution (hyperbolic) into space harmonics with respect to the final (DC) distribution. If  $a$  is considerable, no linear relation exists between frequency and wave length. (See Fig. 8)

When an oscillating wave follows the initial impulse (as is the

FIG 7

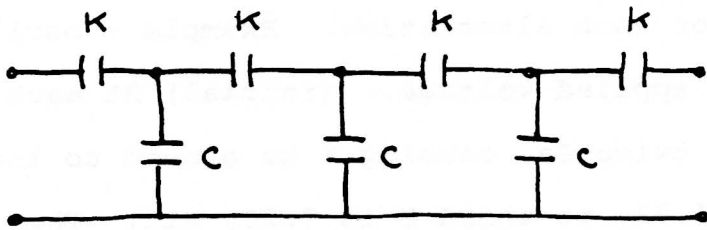

INITIAL  
RESPONSE

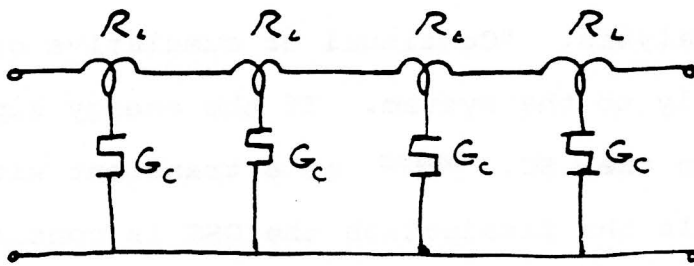

FINAL  
RESPONSE

FIG 8

$$K = \frac{1}{C_s} \text{ DARAFS}$$

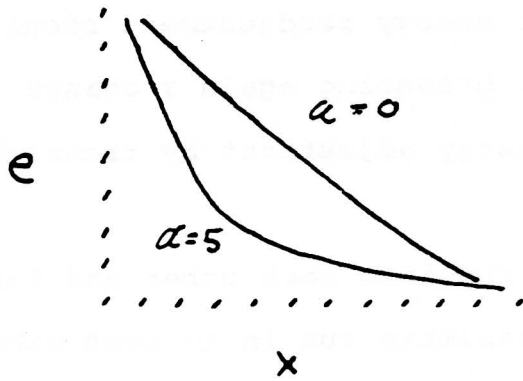

DISTRIBUTION ALONG COIL

$$\alpha = \sqrt{CK}$$

$$\beta = \sqrt{RG}$$

case with the Tesla transformer) the alternate positive and negative voltages cause continuous increase in voltage and energy. The effect of the alternations is to increase the amplitude of the wave by twice the applied voltage for each alternation. Example - oscillating voltage is 1.24 times applied voltage. (initial) At each cycle this is multiplied by twice  $E_a$ , causing  $E$  to ground to increase in steps. At second cycle  $E$  is 4.72, at third  $E$  is 7.20, etc. This effect is reduced or suppressed by large  $u$  or  $a$ .

The action of the spark gap has a multiplicative effect also. Consider Steinmetz' analysis. "Continual or cumulative oscillations involve an energy supply to the system. If the energy supply is less than energy dissipation the OSC damps as a transient with reduced  $u$ . If the supply equals the dissipation the OSC is continuous. If supply is greater the OSC is cumulative.

The OSC represent energy and frequency transformation from the L.F. or D.C. supply to the H.F. OSC system. This transfer may be brought about by the transient of energy readjustment resulting from a change in circuit conditions, producing again a change in circuit conditions and thereby an energy adjustment by transient, etc., etc...

Recurrent oscillations tend to run into each other and form continuous OSC. When successive transients run in to each other they tend to synch.

However, the formation of continuous OSC is not the mere overlap or running together of successive waves. The recurrent OSC cannot start until the preceding OSC has died out, and sufficient charge time has elapsed for next arc over of gap. With overlap no dead period occurs during which normal or supply frequency is supplied. Energy then must be supplied by a phase displacement within arc

FIG - 9

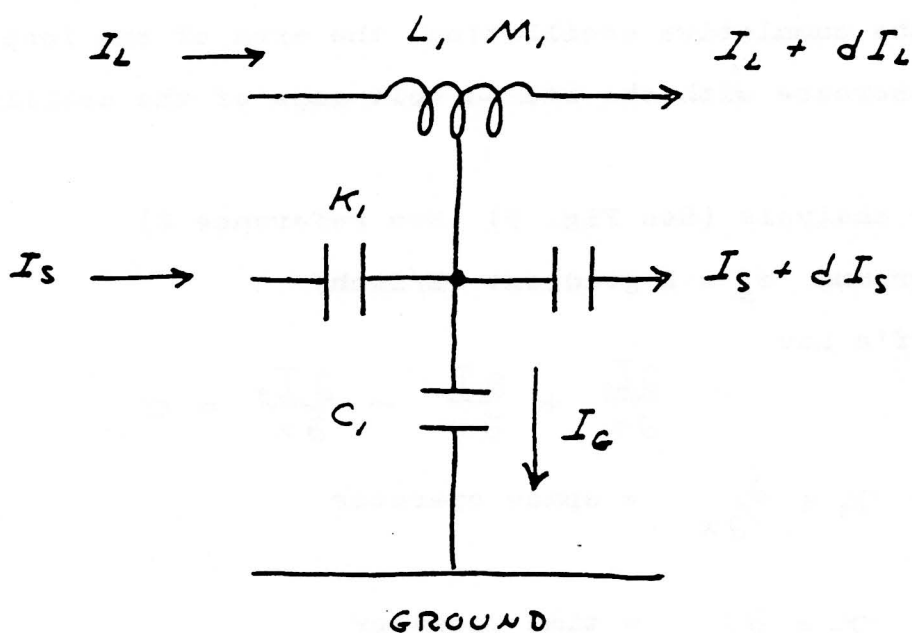

LINE ELEMENTAL

 $dx$  $L =$  SELF INDUCTANCE IN HENRY $C =$  CAPACITANCE TO GROUND IN FARADS $K =$  INTERTURN CAPACITANCE IN DARAFS $M =$  MUTUAL INDUCTANCE IN (HENRY)<sup>-1</sup> $L_1 =$  L PER INCH $C_1 =$  C PER INCH $K_1 =$  K PER INCH $M_1 =$  M PER INCH

$$\alpha = \frac{1}{2} \left[ \frac{R}{L} + \frac{G}{C} \right]$$

During oscillation, which gives a negative energy cycle or a reversed hysteresis loop. For continuous oscillation then, a hysteresis loop must be formed by the lag of effect before cause." (This is negative resistance or the formation rather than the dissipation of energy.) "For the cumulative oscillation, the area of the loop must depend on and increase with the stored volt amps of the oscillating system."

Mathematic analysis (See Fig. 9) (See reference 2)

$e = E$  to ground  $e_s = E$  gradient (E/inch)

By Kirchoff's Law

$$\frac{\partial I_L}{\partial x} + \frac{\partial I_s}{\partial x} - \frac{\partial I_g}{\partial x} = 0 \quad (23a)$$

Let  $\gamma_s = \frac{\partial}{\partial x}$  = space operator

Let  $\gamma_t = \frac{\partial}{\partial t}$  = time operator

Then

$$I_L + I_s - I_g = 0$$

Differentiation of (23a) in time gives

$$\gamma_s \gamma_t I_L + \gamma_s \gamma_t I_s - \gamma_s \gamma_t I_g = 0 \quad (23b)$$

These, (23a) & (23b) are independent of initial and final distribution of EMF.

Equation (23b) must be expressed in one variable. In terms of voltage and current, the current density in capacity to ground is  $C_g$  per inch of coil times the rate of change of  $e$  to ground.

$$\gamma_s I_g = \gamma_t e C_g \quad (26)$$

and

$$\gamma_s \gamma_t I_g = \gamma_t^2 e C_g \quad (27)$$



### Relating $I_s$ and voltage

$I_s$  in capacity between turns equals capacity per inch times the time rate of voltage gradient.

$$I_s = \gamma_t e_s K_1^{-1} = \gamma_s \gamma_t e K_1^{-1} \quad (28)$$

$$\gamma_s \gamma_t I_s = \gamma_s^2 \gamma_t^2 e K_1^{-1} \quad (29)$$

### Relating $I_1$ and voltage:

The relation between magnetizing current and  $I_1$  is complex and defies analysis. (See Fig. 10). For the fundamental distribution ( $\frac{1}{2}$  wave) the effective inductance of the coil is the space integral of the  $\frac{1}{2}$  cosine wave of current of M.M.F. and is equivalent to 2/ times the normal total inductance. For the third harmonic,  $\frac{3}{4}$  cosine wave of current or M.M.F. the inductance of  $\frac{1}{3}$  of the coil opposes the remaining inductance resulting in diminishment of self induction depending on the mutual inductance of the bucking section to the rest of the coil. The process progresses similarly for the rest of the harmonic series (5F, 7F, 9F, etc.). This results in surge impedance for each harmonic but effects tend to cancel for wave length. Capacitance of the coil behaves in a similar fashion and may be voltage dependent giving the coil voltage gain under the proper conditions. (Parametric amplification)

Denoting this residual inductance as leakage inductance  $L$ , and the dimensions of  $l^{-2}$  as the mutual inductance  $M$  (Henry<sup>-1</sup>), then

$$\gamma_s^2 e_s = -\gamma_t I_L (L M) \quad (30a)$$

$$\gamma_s^3 e = \gamma_t I_L (L M) \quad (30b)$$

FIG 10

## MAGNETIC DISTRIBUTION

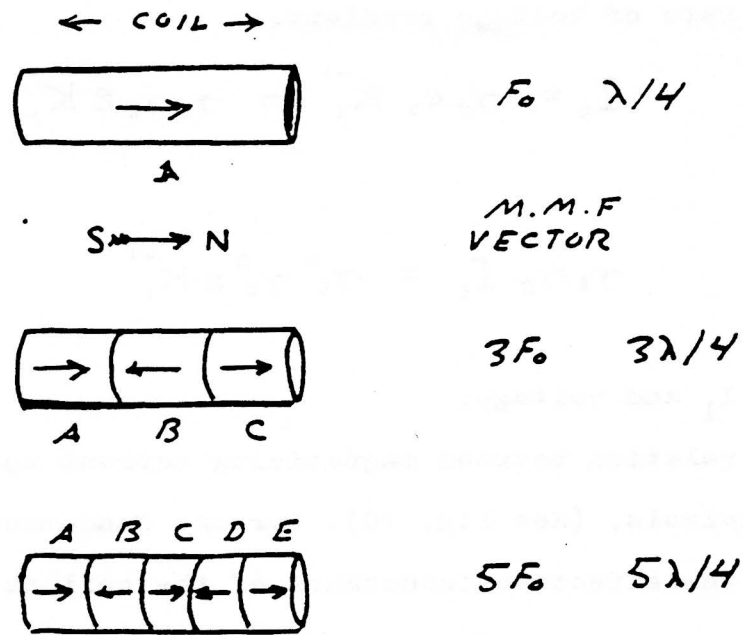

$$\lambda/4 \text{ M.M.F} \quad 2/\pi \text{ M.M.F D.C.}$$

$$3\lambda/4 \text{ M.M.F} \quad (2/\pi - 2/\pi + 2/\pi) \text{ M.M.F D.C.}$$

$$5\lambda/4 \text{ M.M.F} \quad (2/\pi - 2/\pi + 2/\pi - 2/\pi + 2/\pi) \text{ M.M.F D.C.}$$

$$L_n = \text{INDUCTANCE} = n (\text{M.M.F})$$

(30b) gives the value of  $\gamma_t \bar{I}_L$ , while (23a) involves  $\gamma_s \bar{I}_L$ .

If we differentiate the former with respect to  $x$  and the latter with respect to  $t$ , substitution becomes possible.

$$\gamma_s \gamma_t \bar{I}_L = \gamma_s^4 (LM)^{-1} \quad (31)$$

(31), (29) and (27) express in terms of volts the three terms of (23b).

Hence, the general equation:

$$\gamma_s^4 = \gamma_s^2 \gamma_t^2 (L, K, \dots) + \gamma_t^2 (L, M, C, \dots) \quad (33)$$

This equation neglects losses.

Analysis of the interaction between the earth and various coils is possible by the use of velocity measure. This in general is a complex quantity consisting of real and imaginary parts.

By the relation well known:

$$\gamma_s^2 = v^{-2} \gamma_t^2 \quad (34)$$

where  $v$  is the velocity of the wave. Then velocity is the ratio of time to space. Letting this velocity be of unit value, time and space functions become equivalent,  $\gamma_s^2 = \gamma_t^2$ . Steinmetz gives the following instructions for accomplishing this.

"Line constants are typically given per unit length, as per centimetre, mile, 1000 feet, etc.

The most convenient unit of length, when dealing with transients in distributed circuits, is the velocity unit  $v$ .

That is, choosing as unit length the distance of propagation in unit time, or 3 times  $10^{10}$  cm/sec for transverse waves in air, this gives  $v = 1$  and therefore  $LC = 1 = \sigma$

$$C = L^{-1}; L = C^{-1}$$

That is, the capacity per unit of length, in velocity measure, is inversely proportional to the inductance. In this velocity unit of length, distance will be represented by  $\lambda$ ."

Substituting  $\sigma = 1$

$$t_0 = \lambda_0 \quad F = 1/\lambda_0$$

$$\text{Time angle } \theta = 2\pi Ft = 2\pi t/\lambda_0$$

$$\text{Distance angle } w = 2\pi F\lambda = 2\pi\lambda/\lambda_0$$

Analysis of the travelling wave along Tesla coil\* utilizing the light second.

The equation for standing waves on a line are as follows:

$$i = i_0 \times \cos(\theta \mp w) \quad (1)$$

$$e = e_0 \times \sin(\theta \mp w)$$

$u$  is the power dissipation constant. The power involved is:

$$\frac{e_0 i_0}{2} e^{-2ut} \sin^2(\theta \mp w) = ei \quad (2)$$

Because the sine term makes this symmetrical about zero the average power is zero. For the travelling wave:

$$i = i_0 \times \cos(\theta \mp w) \quad (3)$$

$$e = e_0 \times \cos(\theta \mp w) \quad (3)$$

The power involved is :

$$\frac{e_0 i_0}{2} e^{-2ut} [1 + \cos(2)(\theta \mp w)] \quad (4)$$

Power average is now:

$$\frac{e_0 i_0}{2} e^{-2ut} \quad (5)$$

\* Steinmetz's analysis modified.

Thus two waves exist, a travelling steady power flow given by (5) and a standing wave given by (2) such a flow of power flows along the different sections of the Tesla transformer, consisting of sections of different  $u$ . For instance the primary has very low  $u$  due to the large surfaces and the negative  $u$  of the arc, the secondary has a higher  $u$  due to no arc, the Tesla coil has higher yet due to the small conductor size of winding, and the dielectric antenna has a very high  $u$  due to radiation.

In the primary the duration of oscillation is very great as  $u$  is zero or negative. The duration of coil oscillation is shorter due to their higher  $u$ , and by themselves their OSC would dampen quickly. Since all are connected together, all must dampen together. It then follows that power must flow during transient from primary to antenna, so as to have all sections dampen together.

Three conditions can occur in the general compound system:

- a) The power flow is uniform, that is, the power remains constant in the direction of propagation.
- b) The flow decreases in the direction of propagation.
- c) The flow of power increases in the direction of propagation.

This last case is of special interest in the Tesla transformer as it increases the steepness of the wavefront, producing greater displacement current.

If the flow of power increases along system, more power leaves every line element than enters it; that is, the line element is drained of its stored energy by the passage of the wave, and then dies down with time at a faster rate than by its own dissipation. That is, not all the stored energy of the line elements supplies the power dissipated in the line elements, but part of the energy leaves the elements in increasing the flow of power along the line. The

rate of dissipation thus is increased, and instead of  $u$ ,  $u+s$  enters the equation. That is the time decrement is:

$$e^{-(u+s)t}$$

$s$  is the power transfer constant.

But, inversely, along the line the power flow increases, that is, the intensity of the wave increases, by the same factor,

$$e^{+s\lambda}$$

or rather, the wave decreases along the line at a slower rate than that scattered by the power dissipation. Therefore, that taken from the time domain is transferred to the space or distance domain.

$$i = i_0 e^{-(u+s)t} e^{+st} \cos(\theta - \omega t)$$

Similar for  $e$

$$p_{AVG} \text{ is } \frac{e_0 i_0}{2} e^{-2(u+s)t} e^{+2s\lambda}$$

The power transfer constant  $s$  determines the steepness of the wavefront. To meet these requirements the  $u$  of the line must exceed the average  $u_0$  of system.

Example (See Fig. 11):

	Transformer	Line	Load
Length = $\lambda$ in light seconds	$1.0 \times 10^{-3}$	$1.5 \times 10^{-3}$	$0.5 \times 10^{-3}$
Dissipation =	$u$ 100 $u\lambda$ 0.1	900 1.35	1600 0.8
$u_0 = u_{AVG} =$	$\frac{\sum u\lambda}{\sum \lambda} = 800$		
and $s =$	+700	-100	-800

FIG 11

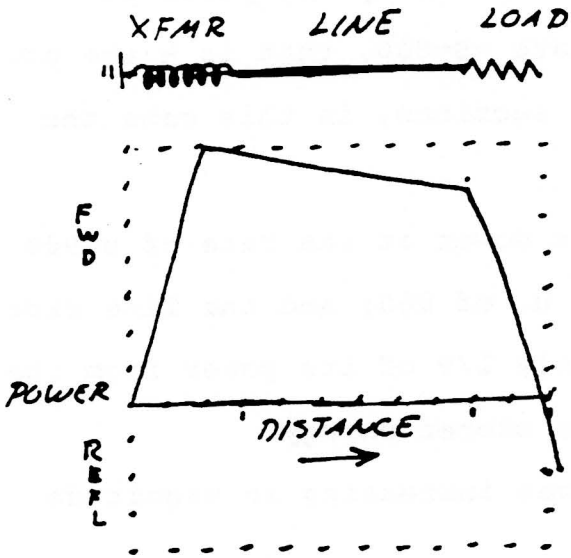

XFMR  $\mu$  -700  
 LINE  $\mu$  +100  
 LOAD  $\mu$  +800

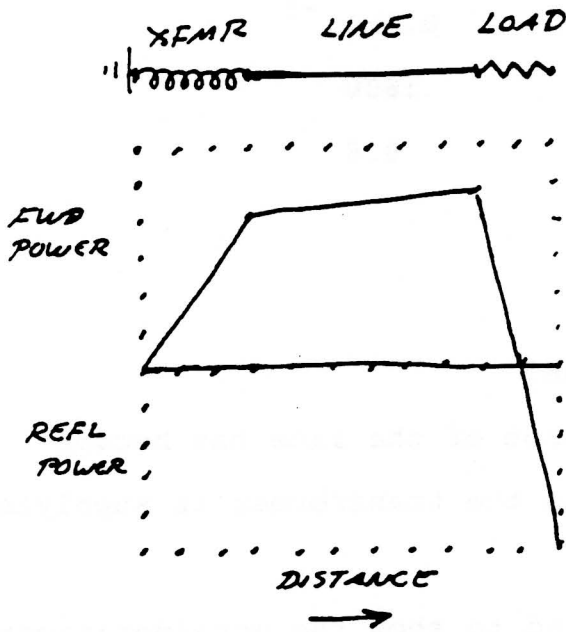

XFMR  $\mu$  -433  
 LINE  $\mu$  -33  
 LOAD  $\mu$  -1067

$$\mu = \text{DISSIPATION}$$

$$= \frac{1}{2} \left( \frac{R}{L} + \frac{G}{C} \right)$$

$$\text{TAN}^{-1} \mu = \text{TIME CONSTANT}$$

The transformer thus dissipates power at a rate  $u=100$  but sends power at the rate of  $S=700$ , or seven times as much as it dissipates by internal losses. The load dissipates power at  $u = 1600$  and receives power at the rate  $-S=800$ , that is  $\frac{1}{2}$  the power it dissipates is supplied from other sections, in this case the transformer,

The transmission line dissipates power at the rate of  $u=900$  only a little faster than the system  $u_0$  of 800; and the line receives power at  $-S=100$ , that is, receives only  $\frac{1}{9}$  of its power from the transformer; the rest comes from its stored energy.

For the special condition of waves increasing in magnitude towards lead;

	Transformer	Line	Load
$\lambda =$	$1 \times 10^{-3}$	$1.5 \times 10^3$	$0.5 \times 10^{-3}$
$u =$	100	500	1600
$u\lambda =$	1.0	0.75	0.8

$$u_0 = \text{AVG } u = \frac{\sum u\lambda}{\sum \lambda} = 533$$

$$S = +433 \qquad +33 \qquad -1067$$

That is the power transfer constant of the line has become positive  $S=33$  and the line now assists the transformer is supplying power to the load (See Fig. 12).

The preceding paper has attempted to show the considerations involved in the optimization of the Tesla transformer. The enormous number of factors involved make this a difficult task indeed! The authors of coil analysis have come up with conflicting results and an attempt towards resolve has been made. Solutions to the differential equations have not been given due to lack of generality of those



available and lack of space.

It has been mentioned in papers on the subject of coil oscillations that theory does not match practice. Much more experimentation is necessary. It also might be possible that  $\frac{\lambda_s}{2\pi}$  does not give the proper velocity, remembering that Tesla claims that his velocities are faster than light. For further information see:

1. ABNORMAL VOLTAGES IN TRANSFORMERS. J. M. Weed. American Institute of Electrical Engineers. Sept. 1915, p.2157.
2. ABNORMAL VOLTAGES WITHIN TRANSFORMERS. L. F. Blume. Feb. 1919, American Institute of Electrical Engineers, p. 577.
3. ELECTRIC WAVES, DISCHARGES AND IMPULSES. C. P. Steinmetz
4. TRAVELING WAVES ON TRANSMISSION SYSTEMS. Bewley, L.V. 1938, 1951. Dover.
5. DIELECTRIC PHENOMENA IN HIGH VOLTAGE CABLES. D. M. Robinson, 1936.
6. ROENTGEN RAYS AND PHENOMENA OF THE ANODE AND CATHODE. E. P. Thompson. 1896, Van Nostrand Co., p. 93 (Kelvin), p. 136 (Tesla).

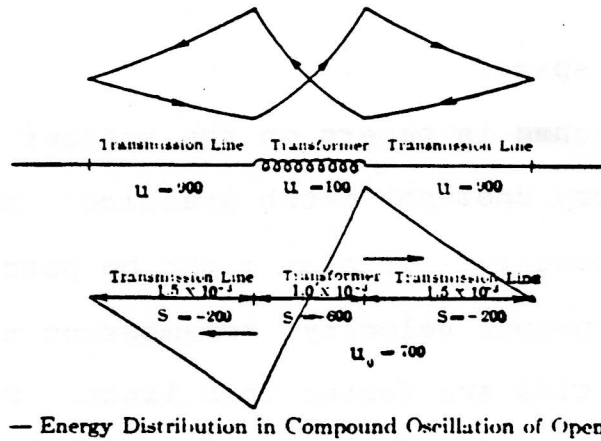
FIG.  
12

## • Faster Than Light! •

By HUGO GERNSBACK

IT may come as a shock, to most students of science, to learn that there are still in the world some scientists who believe that there are speeds greater than that of light.

Since the advent of Einstein, most scientists and physicists have taken it for granted that speeds greater than 186,800 miles per second are impossible in the universe. Indeed, one of the principal tenets of the relativity theory is that the mass of a body increases with its speed, and would become infinite at the velocity of light. Hence, a greater velocity is impossible.

Among those who deny that this is true, there is Nikola Tesla, well known for his hundreds of important inventions. The induction motor and the system of distributing alternating current are but a few of his great contributions to modern science. In 1892, he made his historic experiments in Colorado; where he manufactured, for the first time, artificial lightning bolts 100 feet long, and where he was able, by means of high-frequency currents, to light electric lamps at a distance of three miles without the use of any wires whatsoever.

Talking to me about these experiments recently, Dr. Tesla revealed that he had made a number of surprising discoveries in the high-frequency electric field and that, in the course of these experiments, he had become convinced that he propagated frequencies at speeds higher than the speed of light.

In his patent No. 787,412, filed May 16, 1900, Tesla showed that the current of his transmitter passed over the earth's surface with a speed of 292,880 miles per second, while radio waves proceed with the velocity of light. Tesla holds, however, that our present "radio" waves are not true Hertzian waves, but really sound waves.

He informs me, further, that he knows of speeds several times greater than that of light, and that he has designed apparatus with which he expects to project so-called electrons with a speed equal to twice that of light.

Coming from so eminent a source, the statement should be given due consideration. After all, abstract

mathematics is one thing, and actual experimentation is another. Not so many years ago, one of the world's greatest scientists of the time proved mathematically that it is impossible to fly a heavier-than-air machine. Yet we are flying plenty of airplanes today.

Tesla contradicts a part of the relativity theory emphatically, holding that mass is unalterable; otherwise, energy could be produced from nothing, since the kinetic energy acquired in the fall of a body would be greater than that necessary to lift it at a small velocity.

It is within the bounds of possibility that Einstein's mathematics of speeds greater than light may be wrong. Tesla has been right many times during the past, and he may be proven right in the future. In any event, the statement that there are speeds faster than light is a tremendous one, and opens up entirely new vistas to science.

While it is believed by many scientists, today, that the force of gravitation is merely another manifestation of electromagnetic waves, there have, as yet, been no proofs of this. There are, of course, many obscure things about gravitation that we have not, as yet, fathomed.

At one time, it was believed by many scientists that the speed of gravitation is instantaneous throughout the universe. This is simply another way of putting it that there are speeds greater than light.

Yet, from a strictly scientific viewpoint, no one today has any idea how fast gravitational waves—always providing that the force is in *transit*—travel. If the moon, for instance, were to explode at a given moment, how long would it be before the gravitational disturbance would be felt on earth? Would the gravitational impulse or waves travel at the speed of light—that is, 186,000 miles per second—or would the effect be instantaneous? We do not know.

The entire subject will no doubt arouse a tremendous interest in scientific circles. It is hoped that other scientists will be encouraged to investigate Dr. Tesla's far-reaching assertions; either to definitely prove or to disprove them.

No. 649,621.

Patented May 15, 1900

N. TESLA.

APPARATUS FOR TRANSMISSION OF ELECTRICAL ENERGY.

(Application filed Feb. 10, 1900.)

(No Model.)

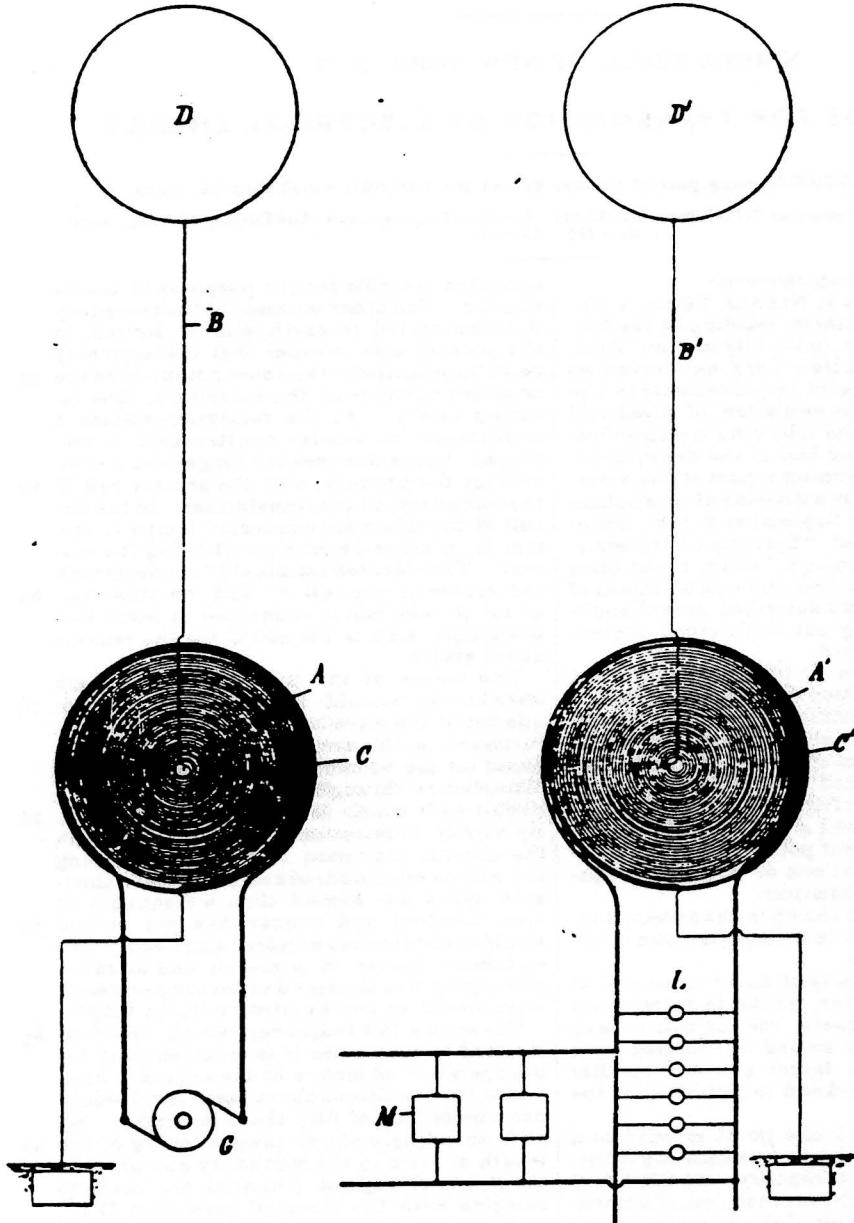

Witnesses:  
*Benjamin Miller*  
*G. W. Marking*

*Nikola Tesla, Inventor*  
 by *Ken. Page Cooper*  
*Att'ys*

# UNITED STATES PATENT OFFICE.

NIKOLA TESLA, OF NEW YORK, N. Y.

## APPARATUS FOR TRANSMISSION OF ELECTRICAL ENERGY.

SPECIFICATION forming part of Letters Patent No. 649,621, dated May 15, 1900.

Original application filed September 2, 1897, Serial No. 686,343. Divided and this application filed February 19, 1900. Serial No. 5,780. (No model.)

*In all which it may concern:*

Be it known that I, NIKOLA TESLA, a citizen of the United States, residing at the borough of Manhattan, in the city of New York, county and State of New York, have invented certain new and useful Improvements in Apparatus for the Transmission of Electrical Energy, of which the following is a specification, reference being had to the drawing accompanying and forming a part of the same.

This application is a division of an application filed by me on September 2, 1897, Serial No. 650,343, entitled "Systems of transmissions of electrical energy," and is based upon new and useful features and combinations of apparatus shown and described in said application for carrying out the method therein disclosed and claimed.

The invention which forms the subject of my present application comprises a transmitting coil or conductor in which electrical currents or oscillations are produced and which is arranged to cause such currents or oscillations to be propagated by conduction through the natural medium from one point to another remote therefrom and a receiving coil or conductor at such distant point adapted to be excited by the oscillations or currents propagated from the transmitter.

This apparatus is shown in the accompanying drawing, which is a diagrammatic illustration of the same.

A is a coil, generally of many turns and of a very large diameter, wound in spiral form either about a magnetic core or not, as may be desired. C is a second coil formed by a conductor of much larger size and smaller length wound around and in proximity to the coil A.

The apparatus at one point is used as a transmitter, the coil A in this case constituting a high-tension, secondary, and the coil C the primary, of much lower tension, of a transformer. In the circuit of the primary C is included a suitable source of current G. One terminal of the secondary A is at the center of the spiral coil, and from this terminal the current is led by a conductor B to a terminal D, preferably of large surface, formed or maintained by such means as a balloon at an

elevation suitable for the purposes of transmission. The other terminal of the secondary A is connected to earth, and, if desired, to the primary also, in order that the latter may be at substantially the same potential as the adjacent portions of the secondary, thus insuring safety. At the receiving station a transformer of similar construction is employed; but in this case the longer coil A constitutes the primary, and the shorter coil C the secondary, of the transformer. In the circuit of the latter are connected lamps L, motors M, or other devices for utilizing the current. The elevated terminal D' connects with the center of the coil A', and the other terminal of said coil is connected to earth and preferably, also, to the coil C' for the reasons above stated.

The length of the thin wire coil in each transformer should be approximately one-quarter of the wave length of the electric disturbance in the circuit, this estimate being based on the velocity of propagation of the disturbance through the coil itself and the circuit with which it is designed to be used. By way of illustration, if the rate at which the current traverses the circuit including the coil be one hundred and eighty-five thousand miles per second then a frequency of nine hundred and twenty-five per second would maintain nine hundred and twenty-five stationary waves in a circuit one hundred and eighty-five thousand miles long and each wave would be two hundred miles in length.

For such a low frequency, which would be resorted to only when it is indispensable for the operation of motors of the ordinary kind under the conditions above assumed, I would use a secondary of fifty miles in length. By such an adjustment or proportioning of the length of wire in the secondary coil or coils the points of highest potential are made to coincide with the elevated terminals D D', and it should be understood that whatever length be given to the wires this requirement should be complied with in order to obtain the best results.

It will be readily understood that when the above-prescribed relations exist the best conditions for resonance between the transmit-

ting and receiving circuits are attained, and owing to the fact that the points of highest potential in the coils or conductors A A' are coincident with the elevated terminals the maximum flow of current will take place in the two coils, and this, further, necessarily implies that the capacity and inductance in each of the circuits have such values as to secure the most perfect condition of synchronism with the impressed oscillations.

When the source of current G is in operation and produces rapidly pulsating or oscillating currents in the circuit of coil C, corresponding induced currents of very much higher potential are generated in the secondary coil A, and since the potential in the same gradually increases with the number of turns toward the center and the difference of potential between the adjacent turns is comparatively small a very high potential impracticable with ordinary coils may be successively obtained.

As the main object for which the apparatus is designed is to produce a current of excessively-high potential, this object is facilitated by using a primary current of very considerable frequency; but the frequency of the currents is in a large measure arbitrary, for if the potential be sufficiently high and the terminals of the coils be maintained at the proper elevation where the atmosphere is rarefied the stratum of air will serve as a conducting medium for the current produced and the latter will be transmitted through the air, with, it may be, even less resistance than through an ordinary conductor.

As to the elevation of the terminals D D', it is obvious that this is a matter which will be determined by a number of things, as by the amount and quality of the work to be performed, by the condition of the atmosphere, and also by the character of the surrounding country. Thus if there be high mountains in the vicinity the terminals should be at a greater height, and generally they should always be at an altitude much greater than that of the highest objects near them. Since by the means described practically any potential that is desired may be produced, the currents through the air strata may be very small, thus reducing the loss in the air.

The apparatus at the receiving-station responds to the currents propagated from the transmitter in a manner which will be well understood from the foregoing description. The primary circuit of the receiver—that is, the thin wire coil A—is excited by the currents propagated by conduction through the intervening natural medium from the transmitter, and these currents induce in the secondary coil C other currents which are utilized for operating the devices included in the circuit thereof.

Obviously the receiving-coils, transformers, or other apparatus may be movable—as, for instance, when they are carried by a vessel floating in the air or by a ship at sea. In

the former case the connection of one terminal of the receiving apparatus to the ground might not be permanent, but might be intermittently or inductively established without departing from the spirit of my invention.

It is to be noted that the phenomenon here involved in the transmission of electrical energy is one of true conduction and is not to be confounded with the phenomena of electrical radiation which have heretofore been observed and which from the very nature and mode of propagation would render practically impossible the transmission of any appreciable amount of energy to such distances as are of practical importance.

What I now claim as my invention is—

1. The combination with a transmitting coil or conductor connected to ground and to an elevated terminal respectively, and means for producing therein electrical currents or oscillations, of a receiving coil or conductor similarly connected to ground and to an elevated terminal, at a distance from the transmitting-coil and adapted to be excited by currents caused to be propagated from the same by conduction through the intervening natural medium, a secondary conductor in inductive relation to the receiving-conductor and devices for utilizing the current in the circuit of said secondary conductor, as set forth.

2. The combination with a transmitting coil or conductor having its ends connected to ground and to an elevated terminal respectively, a primary coil in inductive relation thereto and a source of electrical oscillations in said primary circuit, of a receiving conductor or coil having its ends connected to ground and to an elevated terminal respectively and adapted to be excited by currents caused to be propagated from the transmitter through the natural medium and a secondary circuit in inductive relation to the receiving-circuit and receiving devices connected therewith, as set forth.

3. The combination with a transmitting instrument comprising a transformer having its secondary connected to ground and to an elevated terminal respectively, and means for impressing electrical oscillations upon its primary, of a receiving instrument comprising a transformer having its primary similarly connected to ground and to an elevated terminal, and a translating device connected with its secondary, the capacity and inductance of the two transformers having such values as to secure synchronism with the impressed oscillations, as set forth.

4. The combination with a transmitting instrument comprising an electrical transformer having its secondary connected to ground and to an elevated terminal respectively, and means for impressing electrical oscillations upon its primary, of a receiving instrument comprising a transformer having its primary similarly connected to ground and to an elevated terminal, and a translating

ing device connected with its secondary, the capacity and inductance of the secondary of the transmitting and primary of the receiving instruments having such values as to secure synchronism with the impressed oscillations, as set forth.

5. The combination with a transmitting coil or conductor connected to ground and an elevated terminal respectively, and means for producing electrical currents or oscillations in the same, of a receiving coil or conductor similarly connected to ground and to an elevated terminal and synchronized with the transmitting coil or conductor, as set forth.

6. The combination with a transmitting instrument comprising an electrical transformer, having its secondary connected to ground and to an elevated terminal respectively, of a receiving instrument comprising a transformer, having its primary similarly connected to ground and to an elevated terminal, the receiving-coil being synchronized with that of the transmitter, as set forth.

7. The combination with a transmitting coil or conductor connected to ground and to an elevated terminal respectively, and means for producing electrical currents or oscillations in the same, of a receiving coil or conductor similarly connected to ground and to an elevated terminal, the said coil or coils having a length equal to one-quarter of the wave

length of the disturbance propagated, as set forth.

8. The combination with a transmitting coil or conductor connected to ground and to an elevated terminal respectively, and adapted to cause the propagation of currents or oscillations by conduction through the natural medium, of a receiving-circuit similarly connected to ground and to an elevated terminal, and of a capacity and inductance such that its period of vibration is the same as that of the transmitter, as set forth.

9. The transmitting or receiving circuit herein described, connected to ground and an elevated terminal respectively, and arranged in such manner that the elevated terminal is charged to the maximum potential developed in the circuit, as set forth.

10. The combination with a transmitting coil or conductor connected to ground and to an elevated terminal respectively of a receiving-circuit having a period of vibration corresponding to that of the transmitting-circuit and similarly connected to ground and to an elevated terminal and so arranged that the elevated terminal is charged to the highest potential developed in the circuit, as set forth.

NIKOLA TESLA.

Witnesses:

PARKER W. PAGE,  
MARCELLUS BAILEY.

P-360

N. TESLA.  
APPARATUS FOR TRANSMITTING ELECTRICAL ENERGY  
APPLICATION FILED JAN 18, 1902. RENEWED MAY 4, 1907.

1,119,732.

Patented Dec. 1, 1914

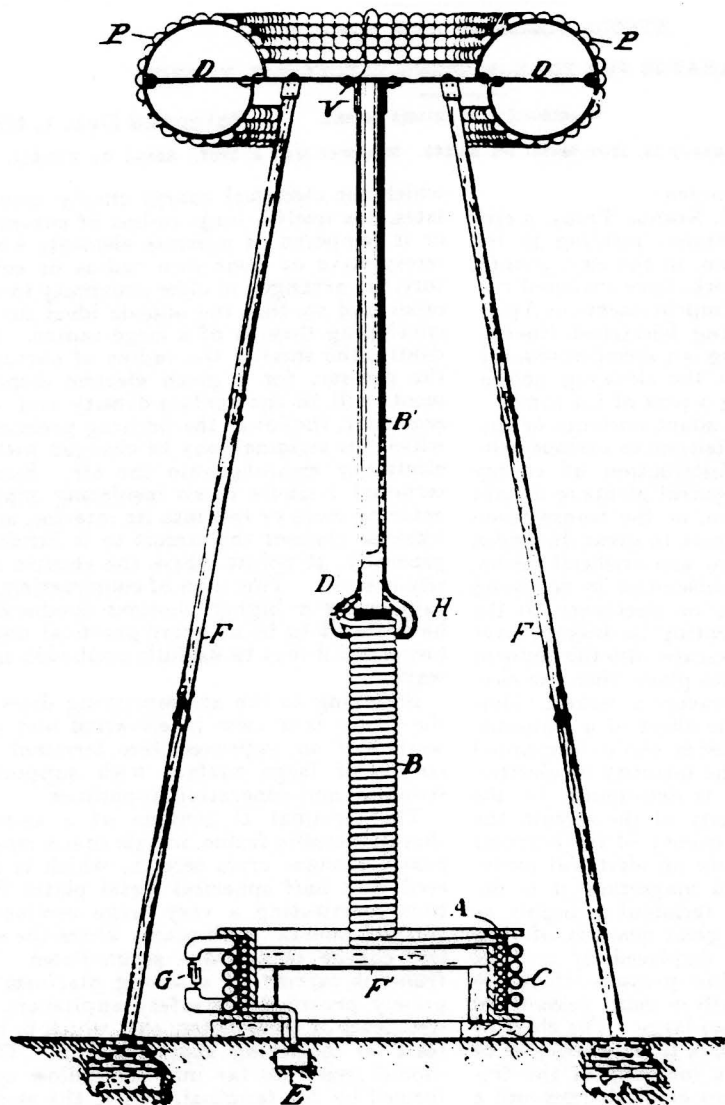

WITNESSES  
*M. Lawson Dyer*  
*Benjamin Miller*

INVENTOR,  
*Nikola Tesla,*  
 BY *Kear, Page & Cooker*  
 his ATTORNEYS.

# UNITED STATES PATENT OFFICE.

NIKOLA TESLA, OF NEW YORK, N. Y.

## APPARATUS FOR TRANSMITTING ELECTRICAL ENERGY.

1,119,732.

Specification of Letters Patent.

Patented Dec. 1, 1914.

Application filed January 18, 1902. Serial No. 90,245. Renewed May 4, 1907. Serial No. 371,817.

*To all whom it may concern:*

Be it known that I, NIKOLA TESLA, a citizen of the United States, residing in the borough of Manhattan, in the city, county, and State of New York, have invented certain new and useful Improvements in Apparatus for Transmitting Electrical Energy, of which the following is a specification, reference being had to the drawing accompanying and forming a part of the same.

In endeavoring to adapt currents or discharges of very high tension to various valuable uses, as the distribution of energy through wires from central plants to distant places of consumption, or the transmission of powerful disturbances to great distances, through the natural or non-artificial media, I have encountered difficulties in confining considerable amounts of electricity to the conductors and preventing its leakage over their supports, or its escape into the ambient air, which always takes place when the electric surface density reaches a certain value.

The intensity of the effect of a transmitting circuit with a free or elevated terminal is proportionate to the quantity of electricity displaced, which is determined by the product of the capacity of the circuit, the pressure, and the frequency of the currents employed. To produce an electrical movement of the required magnitude it is desirable to charge the terminal as highly as possible, for while a great quantity of electricity may also be displaced by a large capacity charged to low pressure, there are disadvantages met with in many cases when the former is made too large. The chief of these are due to the fact that an increase of the capacity entails a lowering of the frequency of the impulses or discharges and a diminution of the energy of vibration. This will be understood when it is borne in mind, that a circuit with a large capacity behaves as a slackspring, whereas one with a small capacity acts like a stiff spring, vibrating more vigorously. Therefore, in order to attain the highest possible frequency, which for certain purposes is advantageous and, apart from that, to develop the greatest energy in such a transmitting circuit, I employ a terminal of relatively small capacity, which I charge to as high a pressure as practicable. To accomplish this result I have found it imperative to so construct the elevated conductor, that its outer surface, on

which the electrical charge chiefly accumulates, has itself a large radius of curvature, or is composed of separate elements which, irrespective of their own radius of curvature, are arranged in close proximity to each other and so, that the outside ideal surface enveloping them is of a large radius. Evidently, the smaller the radius of curvature the greater, for a given electric displacement, will be the surface-density and, consequently, the lower the limiting pressure to which the terminal may be charged without electricity escaping into the air. Such a terminal I secure to an insulating support entering more or less into its interior, and I likewise connect the circuit to it inside or, generally, at points where the electric density is small. This plan of constructing, and supporting a highly charged conductor I have found to be of great practical importance, and it may be usefully applied in many ways.

Referring to the accompanying drawing, the figure is a view in elevation and part-section of an improved free terminal and circuit of large surface with supporting structure and generating apparatus.

The terminal D consists of a suitably shaped metallic frame, in this case a ring of nearly circular cross section, which is covered with half spherical metal plates P P, thus constituting a very large conducting surface, smooth on all places where the electric charge principally accumulates. The frame is carried by a strong platform expressly provided for safety appliances, instruments of observation, etc., which in turn rests on insulating supports F F. These should penetrate far into the hollow space formed by the terminal, and if the electric density at the points where they are bolted to the frame is still considerable, they may be specially protected by conducting hoods as H.

A part of the improvements which form the subject of this specification, the transmitting circuit, in its general features, is identical with that described and claimed in my original Patents Nos. 645,576 and 649,621. The circuit comprises a coil A which is in close inductive relation with a primary C, and one end of which is connected to a ground-plate E, while its other end is led through a separate self-induction coil B and a metallic cylinder B' to the terminal D.



2

1,119,739

The connection to the latter should always be made at, or near the center, in order to secure a symmetrical distribution of the current, as otherwise, when the frequency is very high and the flow of large volume, the performance of the apparatus might be impaired. The primary C may be excited in any desired manner, from a suitable source of currents G, which may be an alternator or condenser, the important requirement being that the resonant condition is established, that is to say, that the terminal D is charged to the maximum pressure developed in the circuit, as I have specified in my original patents before referred to. The adjustments should be made with particular care when the transmitter is one of great power, not only on account of economy, but also in order to avoid danger. I have shown that it is practicable to produce in a resonating circuit as E A B B' D immense electrical activities, measured by tens and even hundreds of thousands of horse-power, and in such a case, if the points of maximum pressure should be shifted below the terminal D, along coil B, a ball of fire might break out and destroy the support F or anything else in the way. For the better appreciation of the nature of this danger it should be stated, that the destructive action may take place with inconceivable violence. This will cease to be surprising when it is borne in mind, that the entire energy accumulated in the excited circuit, instead of requiring, as under normal working conditions, one quarter of the period or more for its transformation from static to kinetic form, may spend itself in an incomparably smaller interval of time, at a rate of many millions of horse power. The accident is apt to occur when, the transmitting circuit being strongly excited, the impressed oscillations upon it are caused, in any manner more or less sudden, to be more rapid than the free oscillations. It is therefore advisable to begin the adjustments with feeble and somewhat slower impressed oscillations, strengthening and quickening them gradually, until the apparatus has been brought under perfect control. To increase the safety, I provide on a convenient place, preferably on terminal D, one or more elements or plates either of somewhat smaller radius of curvature or protruding more or less beyond the others (in which case they may be of larger radius of curvature) so that, should the pressure rise to a value, beyond which it is not desired to go, the powerful discharge may dart out there and lose itself harmlessly in the air. Such a plate, performing a function similar to that of a safety valve on a high pressure reservoir, is indicated at V.

Still further extending the principles underlying my invention, special reference is made to coil B and conductor B'. The

latter is in the form of a cylinder with smooth or polished surface of a radius much larger than that of the half spherical elements P P, and widens out at the bottom into a hood H, which should be slotted to avoid loss by eddy currents and the purpose of which will be clear from the foregoing. The coil B is wound on a frame or drum D' of insulating material, with its turns close together. I have discovered that when so wound the effect of the small radius of curvature of the wire itself is overcome and the coil behaves as a conductor of large radius of curvature, corresponding to that of the drum. This feature is of considerable practical importance and is applicable not only in this special instance, but generally. For example, such plates at P P of terminal D, though preferably of large radius of curvature, need not be necessarily so, for provided only that the individual plates or elements of a high potential conductor or terminal are arranged in proximity to each other and with their outer boundaries along an ideal symmetrical enveloping surface of a large radius of curvature, the advantages of the invention will be more or less fully realized. The lower end of the coil B—which, if desired, may be extended up to the terminal D—should be somewhat below the uppermost turn of coil A. This, I find, lessens the tendency of the charge to break out from the wire connecting both and to pass along the support F.

Having described my invention, I claim:

1. As a means for producing great electrical activities a resonant circuit having its outer conducting boundaries, which are charged to a high potential, arranged in surfaces of large radii of curvature so as to prevent leakage of the oscillating charge, substantially as set forth.

2. In apparatus for the transmission of electrical energy a circuit connected to ground and to an elevated terminal and having its outer conducting boundaries, which are subject to high tension, arranged in surfaces of large radii of curvature substantially as, and for the purpose described.

3. In a plant for the transmission of electrical energy without wires, in combination with a primary or exciting circuit a secondary connected to ground and to an elevated terminal and having its outer conducting boundaries, which are charged to a high potential, arranged in surfaces of large radii of curvature for the purpose of preventing leakage and loss of energy, substantially as set forth.

4. As a means for transmitting electrical energy to a distance through the natural media a grounded resonant circuit, comprising a part upon which oscillations are impressed and another for raising the ten-

tion, having its outer conducting boundaries on which a high tension charge accumulates arranged in surfaces of large radii of curvature, substantially as described.

5 5. The means for producing excessive electric potentials consisting of a primary exciting circuit and a resonant secondary having its outer conducting elements which are subject to high tension arranged in prox-  
10 imity to each other and in surfaces of large radii of curvature so as to prevent leakage of the charge and attendant lowering of potential, substantially as described.

15 6. A circuit comprising a part upon which oscillations are impressed and another part for raising the tension by resonance, the latter part being supported on places of low electric density and having its outermost conducting boundaries arranged in surfaces  
20 of large radii of curvature, as set forth.

25 7. In apparatus for the transmission of electrical energy without wires a grounded circuit the outer conducting elements of which have a great aggregate area and are arranged in surfaces of large radii of curva-  
ture so as to permit the storing of a high charge at a small electric density and prevent loss through leakage, substantially as described.

8. A wireless transmitter comprising in combination a source of oscillations as a condenser, a primary exciting circuit and a secondary grounded and elevated conductor the outer conducting boundaries of which are in proximity to each other and arranged  
35 in surfaces of large radii of curvature, substantially as described.

9. In apparatus for the transmission of electrical energy without wires an elevated conductor or antenna having its outer high  
40 potential conducting or capacity elements arranged in proximity to each other and in surfaces of large radii of curvature so as to overcome the effect of the small radius of curvature of the individual elements and  
45 leakage of the charge, as set forth.

10. A grounded resonant transmitting circuit having its outer conducting boundaries arranged in surfaces of large radii of curvature in combination with an ele-  
50 vated terminal of great surface supported at points of low electric density, substantially as described.

NIKOLA TESLA.

Witnesses:

M. LAMSON DYER,  
RICHARD DONOVAN.

Copies of this patent may be obtained for five cents each, by addressing the "Commissioner of Patents, Washington, D. C."

## CAPACITIES\*

By  
FRITZ LOWENSTEIN

As the seat of energy of an <sup>NEUTRICAL</sup> electrical field is in the space outside of the charged bodies we will consider the shape and concentration of the field only, but not that of the body itself. This distinction is necessary because capacities are usually attributed to the bodies charged, whereas the energy is excluded from that space which is occupied by the body. Considering the space between two charged bodies as the only seat of energy, the expression "charged body" is best replaced by "terminal surface" of the field.

Comparing geometrically similar elements of two geometrically similar fields, the elementary capacities are proportional to lineal dimensions. (See Figure 1.)

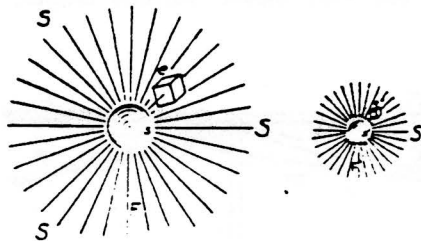

FIGURE 1

Extending this law over the entire field by the integrating process, we find that geometrically similar fields have capacities proportional to the lineal dimensions of the terminal surfaces. It is to be expected, therefore, that capacities expressed in dimensions of terminal surfaces should be of lineal dimensions.

That the capacity is by no means a function of the volume of the field or of the terminal body may be easily seen from Figure 2 where a field element is increased to double the volume by adding

\* Presented before The Institute of Radio Engineers, New York, December 1, 1915.

volume in the direction of the field lines and in a direction perpendicular to the lines. In the first case the capacity has been decreased whereas in the latter case increased, altho in both cases the volumetric increase is the same.

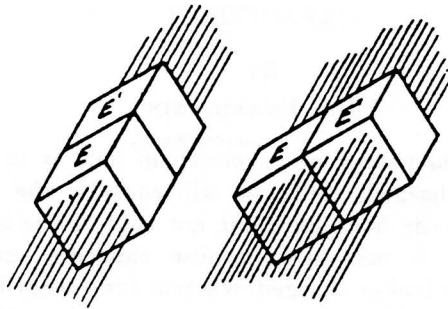

FIGURE 2

It is seen, therefore, that instead of being dependent on the volume, the capacity is rather a function of lineal dimension and therefore the maximum lineal dimension predominates.

An interesting example of this predominating lineal dimension or "maximum reach" is given by the composite capacity of two wires joining at one end under various angles, as shown in Figure 3.

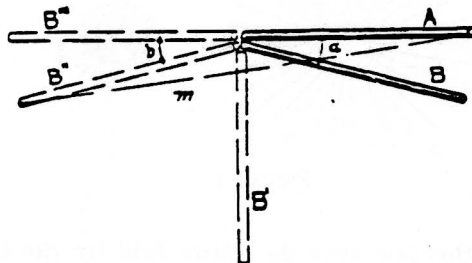

FIGURE 3

When the angle is small the composite capacity is practically the same as that of the single wire, since the addition of the second wire has not increased the maximum reach. If the second wire  $B$  be joined to  $A$  at an angle of 180 degrees, which means in straight continuation of wire  $A$  the total capacity has

oubled, as the maximum reach now is twice that of the single wire. We notice also that by deviating wire *B* slightly from the traight continuation of wire *A*, the maximum reach of the system is not materially altered, from which one may correctly conclude that turning the wire *B* thru an appreciable angle *b* does not materially change the capacity of the system. On the other hand a great change of maximum reach is produced by variations of the angle when the two wires are approximately perpendicular, and in fact the capacity of the total structure is most sensitive to changes of angle between the two elements at about 90 degrees.

In Figure 4, I have given a table of capacities per centimeter of the greater lineal dimension of the different configurations.

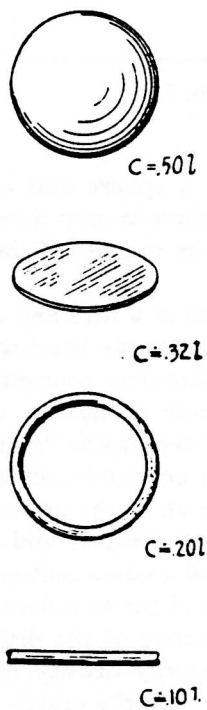

FIGURE 4

In Figure 5 the wire *AB* is assumed to be moved by the variable abscissae *x*, thereby generating a conducting sheet *S*. It is instructive to follow the variation of the capacity  $C_x$ .

At  $x = \theta$  the capacity is that of the wire  $C_{ab}$ ; as long as  $x$  is small the capacity is practically constant because the width of the sheet is small compared to the length  $AB$  and a change of  $x$  does not involve a change of the predominating lineal dimension; however, as  $x$  increases and finally becomes greater than  $AB$ , it assumes the part of the predominating dimension, and, indeed, the graph shows the capacity then to be proportional to  $x$ .

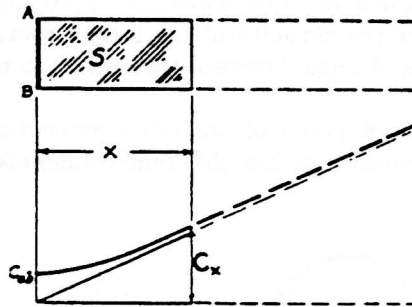

FIGURE 5

Comparing the capacities of a sphere and of a wire, it is found that the capacity of the sphere is only three or four times as great as the capacity of the wire in spite of the million times greater volume.

I have spoken of the capacities of a wire and of other bodies instead of the capacity of the field simply because I do not wish to distract attention from the familiar conceptions. Let me analyze the field shown in Figure 6, having two concentric spheres as terminal surfaces, and defining as "volumetric energy density" the energy contained in one cubic centimeter. As the energy of a field element is made up of the product of potential along the lines of force within that element and of the number of lines traversing it, the energy of a cubic centimeter of electric field is proportional to the square of the field density. Since the field density diminishes as the square of the distance from the center of field, the volumetric energy density diminishes with the fourth power of the distance from the center. The diagram to the left in Figure 6 shows the decrease of volumetric energy density.

Of greater interest than the volumetric energy density is the lineal energy density, which may be defined as the energy contained

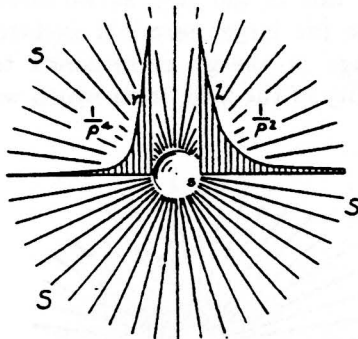

FIGURE 6

in a spherical layer of one centimeter radial thickness; and as the volume of such layer increases with the square of the distance from the center, the law follows from this fact, and from the volumetric energy density law that the lineal energy density decreases inversely as the square of the distance from the center. Such dependence is graphically shown to the right in Figure 6. The shaded surface below this curve represents the total energy of the field and it is easily seen therefrom that the maximum energy of the field is concentrated near the smaller of the two spheres.

I have taken a simple case of a field with spherical terminal surfaces to show that the concentration of energy lies near the smaller terminal surface. Similar considerations can be applied when substituting for this field radiating three-dimensionally, a field of bi-dimensional radiation (as that occurring in the case of long cylindrical terminal surfaces); where, as in this instance, the bulk of the energy of the field is to be found near the smaller one of the two terminal surfaces.

In Figure 7, I have shown a field with concentric terminal surfaces (either spherical or cylindrical), and have increased the scope of the field by reducing the size of the smaller terminal surface without, however, changing either the total number of field lines or the larger terminal surface. As the lineal energy density is very great near the smaller terminal surface, such addition of the field at that point must have materially increased the energy of the field and the change in capacity to be expected should be considerable. In fact, a considerable change in capacity of a sphere is obtained by a change of its diameter.

If, in Figure 7 the larger terminal surface alone is changed,

even materially, the total energy of the field will be increased very slightly only; due to the fact, as we have seen, that the energy density near the larger terminal surface is very small. Such a small change in energy corresponds to only a small change in the capacity of the field, from which we conclude:

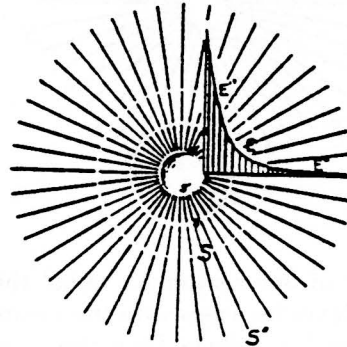

FIGURE 7

In a field having two terminal surfaces of greatly different size, a change of the smaller surface produces a great change in capacity, whereas a change of the larger terminal surface affects the capacity of the field only very slightly. The capacity of a field is, therefore, almost entirely determined by the shape of the smaller terminal surface.

That is why we may with correctness speak of the capacity of a sphere, or any other body, without mentioning the size and shape of the other terminal surface, as long as the assumption is correct that such other terminal surface is of greatly larger dimensions.

It may not be amiss to call your attention to the fact that the increase of field energy as illustrated in Figure 7 is accompanied by a decrease in capacity. This relation may easily be deduced from physical considerations, as well as from consideration of the mathematical expression for the capacity

$$C = \frac{\phi^2}{32 \pi^2 W} \quad \text{where } \phi = \text{total field lines} \\ \quad \quad \quad \quad \quad \quad \quad \quad \quad W = \text{energy,}$$

wherein the capacity is expressed as a property of the field alone. I am tempted to introduce here the reciprocal value of capacity and apply to it the term "stiffness of the field," as an increase of energy would be followed by an increase of stiffness. I am,



however, loath to mar any additional insight which may be gained from these explanations by deviation from so familiar a term as capacity.

For a better conception of the slight change of capacity caused by a considerable increase of the larger terminal surface, I refer to Figure 7, where the difference of capacity is only 1 per cent in spite of the diameter of the larger terminal surface being increased 100 per cent. It appears, therefore, that that part of the capacity of an antenna which is due to the flat top is not materially changed by its height above ground.

While considering the capacity of a flat top antenna to ground, it must have occurred to many engineers, as it did to me, that the statement to be found in many text books on electrostatics is rather misleading: "That the free capacity of a body considered alone in space must not be confounded with the capacity the body may have against another body considered as a plate condenser." This statement is quite erroneous. As the strength and direction in any point of a field is of single and definite value, only one electric field can exist in a given space at a given moment, and, therefore, only one value of capacity. It is incorrect, therefore, to distinguish between free capacity and condenser capacity. This clarifying statement is deemed advisable, or at least permissible, in view of the quoted errors.

By speaking of the capacity of the field instead of that of the body, no such erroneous thought is possible, and it is clear that by free capacity of a body is meant the capacity of the field whose smaller terminal surface is the given body and whose larger terminal surface is one of vastly greater dimensions. It is not essential that this greater terminal surface be located at infinite distance, because of the fact that even if construed as of ten times the lineal dimensions of the small surface the change caused by removing it to an infinite distance would result in a change in capacity of not more than one-tenth of 1 per cent.

At a time when I had not realized the singly determined value of a field capacity, I considered a comparison between free and plate capacity as shown in Figure 8, wherein to an upper disc (of which the free capacity is  $\frac{2}{\pi}r$ ), was added another lower disc, thereby forming a plate condenser. The problem arose in my mind to determine the distance of separation of the two plates so that the plate capacity would equal the free capacity of the single disc. From the well-known formulas for the disc

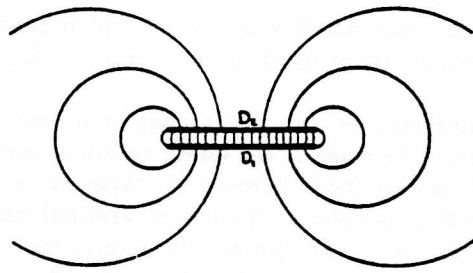

FIGURE 8

capacity and plate capacity, it would appear that the two were equal at a distance equal to  $d = \frac{\pi}{8}r$ , and I must confess that I had quite a struggle to decide whether in speaking of the capacity of the upper plate I would not have to add the two capacities. While such a mistake need hardly be called to the attention of the majority of engineers, I do not hesitate to make mention of it for the benefit of even the few students who might gain therefrom.

The advent of the aeroplane has opened another field, for radio communication. Whereas in the static field of an antenna, one terminal surface is artificial and the other provided by the surrounding ground, both terminal surfaces in an aeroplane outfit have to be artificial and are, therefore, open to design. The question arises in such a radio oscillator as to how much may be gained in energy for each single charge by increasing that one of the two terminal surfaces which consists of a dropped wire. The arrangement is shown in Figure 9. It is evident that

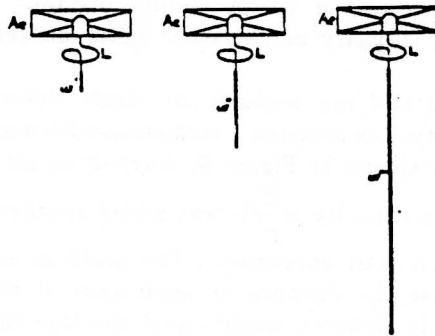

FIGURE 9

as long as the dropped wire is of smaller dimensions than the electrostatic counterpoise provided on the aeroplane, an increase in length of such dropped wire will materially increase the capacity of the field and, therefore, the energy per charge (as we may conclude by analogy from Figure 7). As soon, however, as the dropped wire is materially longer than the conductor on the aeroplane it assumes the role of the larger terminal surface of the field, and any further increase of its length will not materially contribute to an increase of electrostatic capacity nor of the energy per unit charge.

Figure 10 shows the function of the volumetric and lineal energy density in a field whose smaller terminal surface is a long cylinder. Such a field, radiating bi-dimensionally only, shows an energy concentration not so accentuated as that found in the

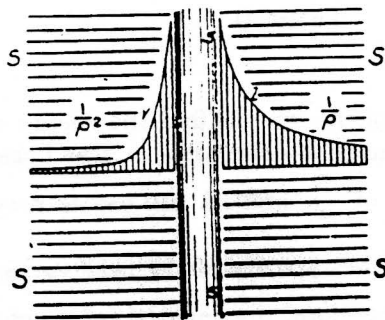

FIGURE 10

tri-dimensionally radiating field; but considering the larger terminal surface of a diameter ten times that of the smaller surface, the capacity would only be changed 1 per cent by increasing the larger terminal surface infinitely.

In all cases, therefore, where the larger terminal surface does not come closer at any point than (say) ten times the corresponding dimension of the smaller terminal surface, we need not be concerned with the actual shape of the larger terminal surface when we determine the seat of energy, the capacity and the configuration of the field lines emanating from the smaller surface. It will be seen, therefore, that from the flat top of an antenna, lines emanate almost symmetrically both upwards and downwards as though the larger terminal surface were one

surrounding the antenna symmetrically on all sides, in spite of the fact that the ground is located entirely at the bottom of the antenna. This is clearly illustrated in Figure 11.

By integrating the lineal energy density of a three-dimensionally radiating field between the radius of the smaller sphere

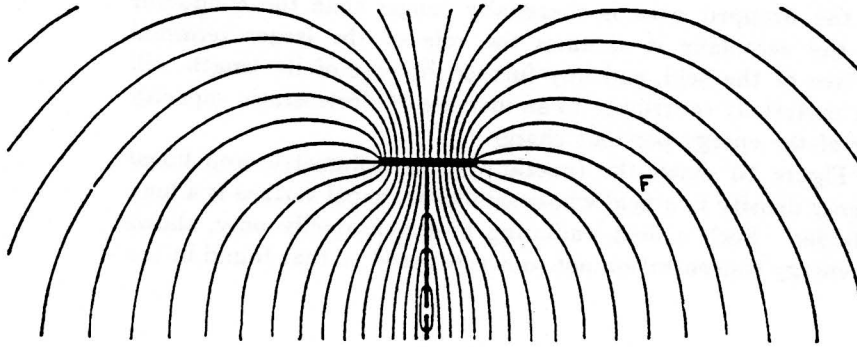

FIGURE 11

and that of the larger sphere, we can find the energy of such a field: whereby the capacity is determined. The lineal energy density follows the law of  $\frac{1}{r^2}$ , and its integral is proportional to  $\frac{1}{r}$ ; and consequently the capacity of the field varies as  $r$ .

We have deduced, therefore, the capacity of a sphere from properties of the field alone, considering the sphere as a terminal surface only.

In deducing similarly the capacity of the wire from properties of the field alone, we have to start with the bi-dimensionally radiating field the lineal energy density of which follows the law  $\frac{1}{r}$  as we have seen. The integral of such function is of logarithmic nature, as indeed is the capacity of the wire.

I wish to call your attention to the fact that in a sphere segments of the same projected axial length contribute equally to the capacity of the sphere, as shown in Figure 12.

If a charge were made to enter a sphere and traverse the sphere in the direction of a diameter, the sphere as a conductor would behave like a straight piece of wire of uniform lineal capacity. This fact was first recognized, to my knowledge, by

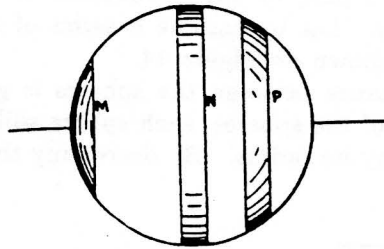

FIGURE 12

Mr. Nikola Tesla, and I expect to come back to the behavior of a sphere as a conductor of radio frequency currents at some later date.

The study of capacities of composite bodies is most instructive and conducive to a clear conception of capacity. Let, as in Figure 13, a number of small spheres of radius be so arranged as to cover completely the surface of the larger sphere, the radius  $R$  of which be 100. If each one of the

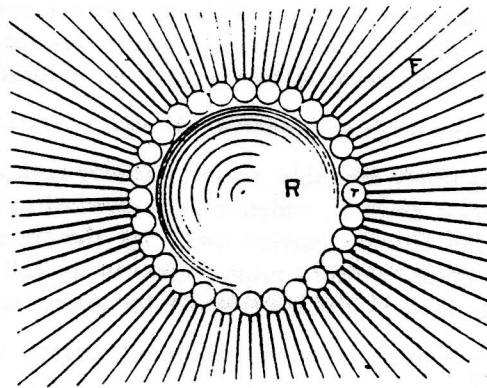

FIGURE 13

31,400 smaller spheres could be counted at its full value of capacity, the capacity of the composite body would be 31,400; as a matter of fact, however, it is not more than radius  $R$  of the larger sphere, that is 100. Indeed, the configuration of the electric field  $F$  could not have changed materially by the arrangement of the small spheres, and the capacity clearly presents itself as a property of the configuration of the field lying outside of the enveloping surface of the composite structure.

Capacity may play a part in the conduction of electricity thru liquids and gases. Let us assume a series of spheres in lineal arrangement as shown on Figure 14.

As long as the distance between the spheres is great compared to the diameter of the spheres, each sphere will retain its full capacity as given by its radius. By decreasing the distance

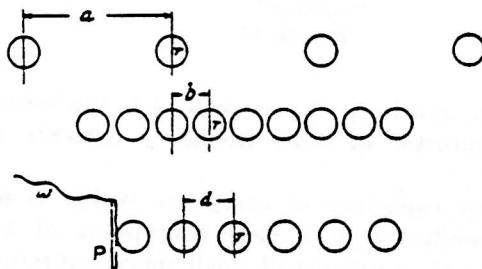

FIGURE 14

between spheres the individual capacities of the spheres decrease, because of the negative capacity coefficients. If such approximation be carried to the point of contact between the spheres, the capacity of each individual sphere would be reduced to approximately  $\frac{1}{\epsilon}$  of the original capacity. If such a row of spheres were conceived as freely movable, so as to enable each sphere to make contact with a plate *P*, which is kept charged to a certain potential, then the charges carried away by the spheres after contact with the plate would be proportional to the full capacity of each sphere as long as the spheres are far apart, and would be only  $\frac{1}{\epsilon} = \frac{1}{2.718}$ th part of such maximum charge when the spheres are in contact. As we assumed the plate *P* to be maintained at a certain potential by an outside source of electricity, the convection current represented by the departing charges of the spheres would vary approximately in a ratio of 2.71 to 1.

In the passage of electricity thru an electrolyte, the molecular conductivity has been found to be the same for all electrolytes, and varying only with the concentration of the solution; the molecular conductivity being approximately 2.5 times as great in the very dilute solution as in the concentrated solution.

I wish to call your attention to the striking similarity between the ratio of conductivity experimentally determined in elec-

trolytes of small and large concentration and the ratio of conductivity of the row of spheres where the spheres are far apart or close together. I do not pretend at this moment that a

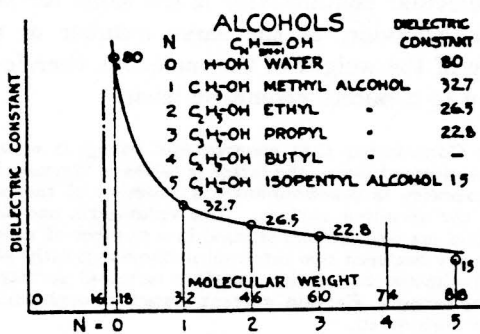

FIGURE 15

plausible modification of the theory of conduction thru electrolytes and gases can be based on such a coincidence; and in fact, assumptions would have to be made. For example, a lineal arrangement of the ions in the direction of the static field impressed on the electrolyte or on the gas must be assumed.

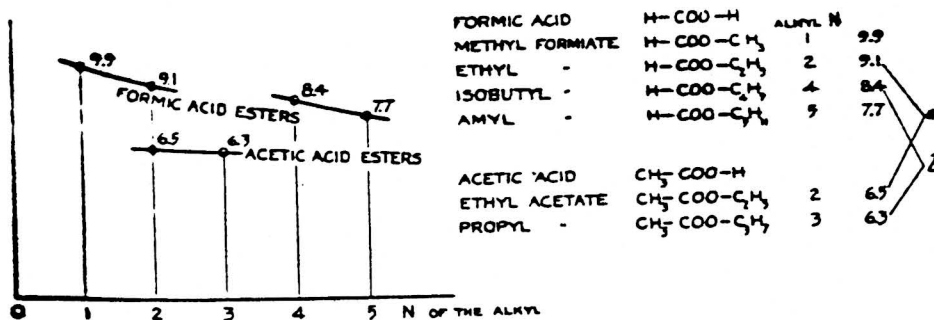

FIGURE 16

But the fact that such ratio in the case of the spheres is deduced from geometrical considerations alone, coupled with the fact that in electrolytes the same ratio follows from purely geometrical considerations, is sufficient to warrant further thought. I do not hesitate to bring this interesting coincidence to your knowledge, with the hope that other physicists may carry on investigations

in the same direction. I have said that the molecular conductivity of electrolytes arose from geometrical considerations only, and I think it advisable to call your attention to the foundation of such a statement. While it is true that the conductivity of different electrolytes varies considerably, it has been found that the molecular conductivity is the same for all electrolytes. The similar behavior, of the same number of molecules, independently of the weight of the molecule, therefore reduces the phenomenon to a purely geometric basis.

**SUMMARY:** Considering that electrostatic energy is actually in the space surrounding a charged body, the latter is called a "terminal surface." It is shown that capacity is predominantly a function of the *maximum* lineal dimension of the terminal surface. The volumetric and lineal energy densities in the field are defined and studied in a number of cases. It is proven that the capacity between two terminal surfaces is greatly affected by changing the lineal dimensions of the *smaller* terminal surface, but not so for changes of the larger. Certain current errors in connection with "mutual capacity" are considered.

The practical applications to a radio antenna and to aeroplane counterpoises are given.

When a charge traverses a sphere, entering parallel to a diameter, the sphere behaves as a conductor of uniform lineal capacity.

Applications of the theoretical considerations are also given in connection with the conductivity of concentrated and dilute electrolytes.



# 1991 BSRF PUBLICATIONS & VIDEOS

[Prices subject to change without notice]

- A PRIMER OF HIGHER SPACE** (Bragdon) \$13.31
- A SYSTEM OF CAUCASIAN YOGA** (Walewski) \$19.95
- ABRAMS METHOD OF DIAGNOSIS AND TREATMENT** (Barr) \$11.95
- THE AIDS/SYPHILIS CONNECTION** (McKenna) VHS \$29.95
- THE AMAZING SECRETS OF THE MASTERS OF THE FAR EAST** (Perara) \$8.95
- ARCHAIC ROCK INSCRIPTIONS** (Reader) \$14.95
- ASSORTED IDEAS ON TECHNOLOGY** (Resines) \$7.95
- ASTRO-CLIMATOLOGY** (Klocek) VHS \$29.95
- ASTROLOGY & BIOCHEMISTRY** (Sawtell) \$8.45
- ASTROSONICS**(Heleus)VHS \$29.95
- ASTRONOMY COURSE**(Steiner) \$20.00
- ATOMS & RAYS** (Lodge) \$16.95....
- AUSTRALIAN ABORIGINAL HEALING** (Havecker) \$11.00
- AUTOMATED DETECTING DEVICES** (Resines) \$14.00
- A BIPOLAR THEORY OF LIVING PROCESSES** (Crile) \$34.95
- BIOCIRCUITS** (Patten)VHS \$29.95
- THE BOOK OF FORMULAS** (Hazelrigg) \$7.50
- THE CALCULATION AND MEASUREMENT OF INDUCTANCE AND CAPACITY** (Nottage) \$9.95
- THE CAMERON AURAMETER** (compiled) \$14.95
- THE CASE FOR THE UFO** (Jessup) \$18.95
- CENTER OF THE VORTEX** (Hamilton) \$14.75
- CERTAIN BODY REFLEXES** (Intl. Hahnemannian Committee) \$5.50
- COLLECTED PAPERS OF JOSE ALVAREZ LOPEZ** (Lopez) \$9.95
- COLOR- ITS MANIFESTATION AND VALUE** (Cowen) \$5.95
- COLOR CAN CHANGE YOUR LIFE** (Hardy) \$4.75
- THE COMING OF THE GUARDIANS** (Layne) \$11.95
- THE COMPLEX SECRET OF DR. T. HENRY MORAY** (Resines) \$11.95..
- CONDENSED INTRO TO TESLA TRANSFORMERS** (Dollard) \$11.00
- THE COSMIC PULSE OF LIFE** (Constable) \$24.95
- THE CRYSTAL BOOK** (Davidson) \$15.95
- DEMONSTRATION OF INSTRUMENT THAT DETECTS A BIOPHYSICAL FORCE** (Payne) VHS \$29.95
- DIELECTRIC & MAGNETIC DISCHARGES IN ELECTRICAL WINDINGS** (Dollard) \$7.95
- THE DROWN HOMO-VIBRA RAY AND RADIO VISION INSTRUMENTS: *Rate Atlas*** (Drown) \$33.00
- DR. SCHUESSLER'S BIOCHEMISTRY**, \$3.45
- EASY STRETCHING POSTURES -- *For Vitality & Beauty*** (Stone) \$7.95
- THE EIDOPHONE VOICE FIGURES** (Hughes) \$7.95
- ELECTRICITY AND MATTER** (Thompson) \$12.95
- ELECTROMAGNETIC & GEOPATHIC POLLUTION** (Wiberg) VHS \$29.95
- ELECTRONIC REACTIONS OF ABRAMS** (Abrams) \$11.95
- ELECTRIC DISCHARGES, WAVES & IMPULSES, and OTHER TRANSDUCENTS** (Steinmetz) \$23.45
- ELEMENT AND ETHER** (Brown) VHS \$29.95
- THE ENERGY GRID I: FOUNDATION, EQUATIONS AND RAMIFICATIONS** (Resines) \$13.95
- THE ENERGY GRID II: ANGLES, MUSIC FROM THE SPHERES AND J. LOBACZEWSKI** (Resines) \$24.95
- THE ENERGY GRID III: MATHEMATICAL TRANSFORMATION AND THE MANY-GRIDS THEORY** (Resines) \$6.95
- ESSENTIALS OF MEDICAL ELECTRICITY** (Morton) \$29.95
- THE ETHER AND ITS VORTICES** (Krafft) \$9.95
- THE ETHER DRIFT EXPERIMENT** (Miller) \$6.95
- THE ETHERIC FORMATIVE FORCES IN COSMOS, EARTH & MAN** (Wachsmuth) \$20.95
- THE ETHER OF SPACE** (Lodge) \$15.95
- THE ETHER SHIP MYSTERY** (Layne) \$7.95
- THE ETHER-VORTEX CONCEPT** (Millard) \$3.00
- EVOLUTION OF MATTER** (Le Bon) \$39.95
- EVOLUTION OF FORCES** (Le Bon) \$29.95
- EXPERIMENTS ON ROTATION LEADING TO DEVELOPMENT OF THE N-MACHINE** (DePalma) VHS \$29.95
- THE EYE OF REVELATION -- *The Original Five Tibetan Rites of Rejuvenation*** (Kelder) \$3.95
- FIVE RITES OF REJUVENATION** (BSRF) VHS \$29.95
- FLYING SAUCERS and HARMONY WITH NATURE** (Crabb) \$7.50
- FLYING SAUCERS AT EDWARDS AFB, 1954** (compiled) \$7.50
- FLYING SAUCERS ON THE MOON** (Crabb) \$6.95
- FOOTSTEPS ON THE HIGHWAY TO HEALTH** (Louise) \$15.95
- GLIMPSES OF THE UNSEEN WORLD** (Krafft) \$6.95
- GOLD RUSH GHOSTS** (Bradley & Gaddis) \$9.95
- GRAND ARCHITECTURE** \$3.33
- HANDBOOK OF MEDICAL ELECTRICITY** (Tibbits) \$16.95
- H-BOMBS HAVE US QUAKING** (Dibble) \$4.44
- THE HEART TO HEART TRANSPLANT** (Crabb) \$6.78
- THE HENDERSHOT MOTOR MYSTERY** (compiled Brown) \$9.96
- IMPLOSION -- *The Secret of Viktor Schauberg*** (Brown) \$19.95
- INDUCTION COILS** (Lowell & Norrie) \$13.95
- INTRODUCTION TO ELECTRONIC THERAPY** (Colson) \$7.50
- INVISIBLE RADIATIONS & THE MANY GRIDS THEORY** (Resines) VHS \$29.95

IS CANCER CURABLE? (Kullgren) \$15.95

THE KAHUNA RELIGION OF HAWAII (Bray & Low) \$6.95

THE KOCH TREATMENT for Cancer and Allied Allergies (Layne) \$9.95.....

THE LAKHOVSKY MULTIPLE WAVE OSCILLATOR HANDBOOK (Brown) \$16.95

LAKHOVSKY MWO (BSRF) VHS \$29.95

THE L.E. EEMAN REPORT (Brown) \$19.95

THE LIFE & WORK OF SIR J.C. BOSE (Geddes) \$20.75

LITHIUM & LITHIUM CRYSTALS (Haroldine) \$9.95

THE LIES AND FALLACIES OF THE ENCYCLOPEDIA BRITANNICA (McCabe) \$7.50

THE MAGICAL FREQUENCY BAND (Hills) VHS \$29.95

MAGNETIC CURRENT (Leeds-kalnin) \$4.45

MAN, MOON AND PLANT (Staddon) \$7.95

THE METATRON THEORY (Hilliard) \$5.55

M.K. JESSUP & THE ALLENDE LETTERS (BSRF) \$7.95

THE MORLEY MARTIN EXPERIMENTS AND THE EXPERIMENTS OF DR. CHARLES W. LITTLEFIELD & WILHELM REICH \$9.95

MY ELECTROMAGNETIC SPHERICAL THEORY & MY MY EXPERIMENTS TO PROVE IT (Spring) VHS \$29.95

MY SEARCH FOR RADIONIC TRUTHS (Denning) \$9.95

NATURE WAS MY TEACHER (BSRF) VHS \$29.95

NEW HORIZONS OF COLOUR, ART, MUSIC & SONG (Louise) \$8.95 .

NEW LIGHT ON THERAPEUTIC ENERGIES (Gallert) \$39.95

O<sub>2</sub>XYGEN THERAPIES (McCabe) VHS \$29.95

PATHOCLAST INSTRUCTION BOOK \$15.95

PATHOMETRIC JOURNAL and Experimental Data \$17.95

THE PHENOMENA OF LIFE (Crile) \$29.95

PLANT AUTOGRAPHS & THEIR REVELATIONS (Bose) \$19.50

THE POWERS BEHIND THE RAINBOW (Nicolaidis) \$1.50

THE PRINCIPLE OF VARIATIONAL HOMOGENEITY (Lopez) \$6.95

PRINCIPLES OF LIGHT AND COLOR (Babbitt) \$100.00

PROCEEDINGS OF THE SCIENTIFIC & TECHNICAL CONGRESS OF RADIONICS AND RADIESTESIA, \$29.95

THE PSYCHEDELIC EXPERIENCE (Crabb compiled.) \$7.65

PSYCHICAL PHYSICS (Tromp) \$39.95

PSYCHO-HARMONIAL PHILOSOPHY (Pearson) \$21.95

QUESTIONS AND ANSWERS ABOUT ELECTRICITY \$9.95

RADIANT ENERGY (Moray) \$4.75

RADIATIONS OF THE BRAIN (Brunler) \$2.22

RADIOCLAST INSTRUCTION MANUAL with Rate Atlas (Miller) \$9.95

RADIONICS - MORPHIC RESONANCE & SPECTRO-VIBRATORY IMAGING (Beans) VHS \$29.95

RAYS OF POSITIVE ELECTRICITY (Thompson) \$19.95

THE RAY OF DISCOVERY I: TESLA (Vassilatos) VHS \$29.95

THE RAY OF DISCOVERY II: RIFE (Vassilatos) VHS \$29.95

THE RAY OF DISCOVERY III: MEDICAL RADIONICS (Vassilatos) VHS \$29.95

REALITY OF THE UNDERGROUND CAVERN WORLD (Crabb) \$5.65

RELATIVITY AND SPACE (Steinmetz) \$21.12

REPORT ON RADIONIC RESEARCH PROJECT \$4.44

REVOLUTION IN FARMING & HUSBANDRY (Bast) VHS \$29.95

ROYAL R. RIFE REPORT (compiled) \$15.95

SCIENCE & PHILOSOPHY OF THE DROWN RADIO THERAPY (Drown) \$12.95

SECRET OF THE SCHAUBERGER SAUCER (Resines) \$4.95

SELF PROPULSION (Lopez) \$5.95

SOME FREE ENERGY DEVICES (Resines) \$17.50

SPIRITUAL SCIENTIFIC MEDICINE (Maret) VHS \$29.95

THE STRUCTURE OF THE ATOM (Krafft.) \$6.95

SYMBOLIC REPRESENTATION OF ALTERNATING ELECTRIC WAVES (Dollard) \$8.65

SYMBOLIC REPRESENTATION OF THE GENERALIZED ELECTRIC WAVE (Dollard) \$12.95

TESLA'S LONGITUDINAL ELECTRICITY (Dollard) VHS \$29.95

THEORY AND TECHNIQUE OF THE DROWN HOMO-VIBRA RAY (Drown) \$29.95

THEORY OF WIRELESS POWER (Dollard) \$10.80

THREE GREAT AQUARIAN AGE HEALERS (Crabb) \$9.75

TRANSVERSE & LONGITUDINAL ELECTRIC WAVES (Dollard) VHS \$29.95

T-SHIRTS \$15.00

TWO INVENTORS RETURN AND PROJECT HERMES (Wright) \$7.45

YOU DON'T HAVE TO DIE (Hoxsey) \$22.95

VITIC Bochure (Layne) \$7.95

VITIC POWER RODS \$99.00.....

WORKING OF THE STARS IN EARTHLY SUBSTANCE (Davidson) VHS \$29.95

## ORDERING INFO:

Send check or money order to:  
 Borderland Sciences Research  
 Foundation  
 PO Box 429, Garberville, CA  
 95440

### POSTAGE & HANDLING FEES:

BOOKS/VIDEOS: \$2.75 first item,  
 plus \$.75 each additional item.  
 CALIFORNIA RESIDENTS add  
 7.25% state sales tax.

REQUEST OUR 1991  
 CATALOG

"Almost legendary..." Fortean Times

# The Journal of Borderland Research

SERVING HIGHER INTELLIGENCE SINCE 1945

## A RENAISSANCE IS HAPPENING IN THE BORDERLANDS OF SCIENCE!

A phenomenal rebirth of ancient knowledge and suppressed technology – a far-reaching exploration of futuristic visions. THE JOURNAL OF BORDERLAND RESEARCH has been at the helm of these exciting discoveries for over 45 years, transporting its readers into a rich and provocative world of ideas and practical information far beyond other contemporary scientific and New Age publications.

Shedding the old, materialistic view of the world, this Free-Thought Scientific Forum examines the living energy of a living Universe, probing deeply beyond the accepted boundaries of body, mind and spirit. Here you will find researchers from all parts of the globe sharing their discoveries, exchanging ideas and opening wide dynamic new avenues of exploration.

Fascinating subjects investigated in this Borderland beyond the visible world include: Archetypal Forms and Forces of Nature, and Developing the Imagination & Intuition to Perceive Them; Light & Color; Radionics; Dowsing, Homeopathy, & Other Subtle Energy Arts; Ether Physics and the Rediscovered Etherial Forces; the Controversial Field of Free Energy & Devices You can Build; Orgone Energy; Water - the Vital Substance of Life; Inventions of Nikola Tesla and the Secrets of Electricity; Alchemy, Initiation and the Science of the Stars; The World Energy Grid & Cosmic Weather Report; Anomalies and Fortean Phenomena; Hypnosis; Photography of the Invisible and the UFO Enigma; and much, much more...

Share in the birth of an evolved new science that will not only transmute your awareness, but transform the world! Sign up now as a member of Borderland Sciences and receive THE JOURNAL OF BORDERLAND RESEARCH.

**BORDERLAND SCIENCES RESEARCH FOUNDATION**  
PO Box 429, Garberville CA 95440

**YES**, I wish to join the most progressive alternative scientific movement on this planet and receive the foremost spiritual-scientific publication available -- *The Journal of Borderland Research*. Membership entitles me to six bi-monthly issues of the *Journal*. Start me with the current issue...

- Sample issue - \$3
- Regular membership - \$25/year
- Senior (over 65) or Student membership - \$15/year
- Supporting membership - \$50/year (Thanks!)
- Sustaining membership - \$100/year (Thanks!!)
- Life membership - \$1000 (Journal for life)
- Here's a donation of \$\_\_\_\_\_ to support your efforts.



NAME \_\_\_\_\_ DATE \_\_\_\_\_

ADDRESS \_\_\_\_\_

CITY \_\_\_\_\_ STATE/COUNTRY \_\_\_\_\_ ZIP \_\_\_\_\_