

---

This is a reproduction of a library book that was digitized by Google as part of an ongoing effort to preserve the information in books and make it universally accessible.

Google™ books

<https://books.google.com>

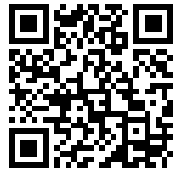

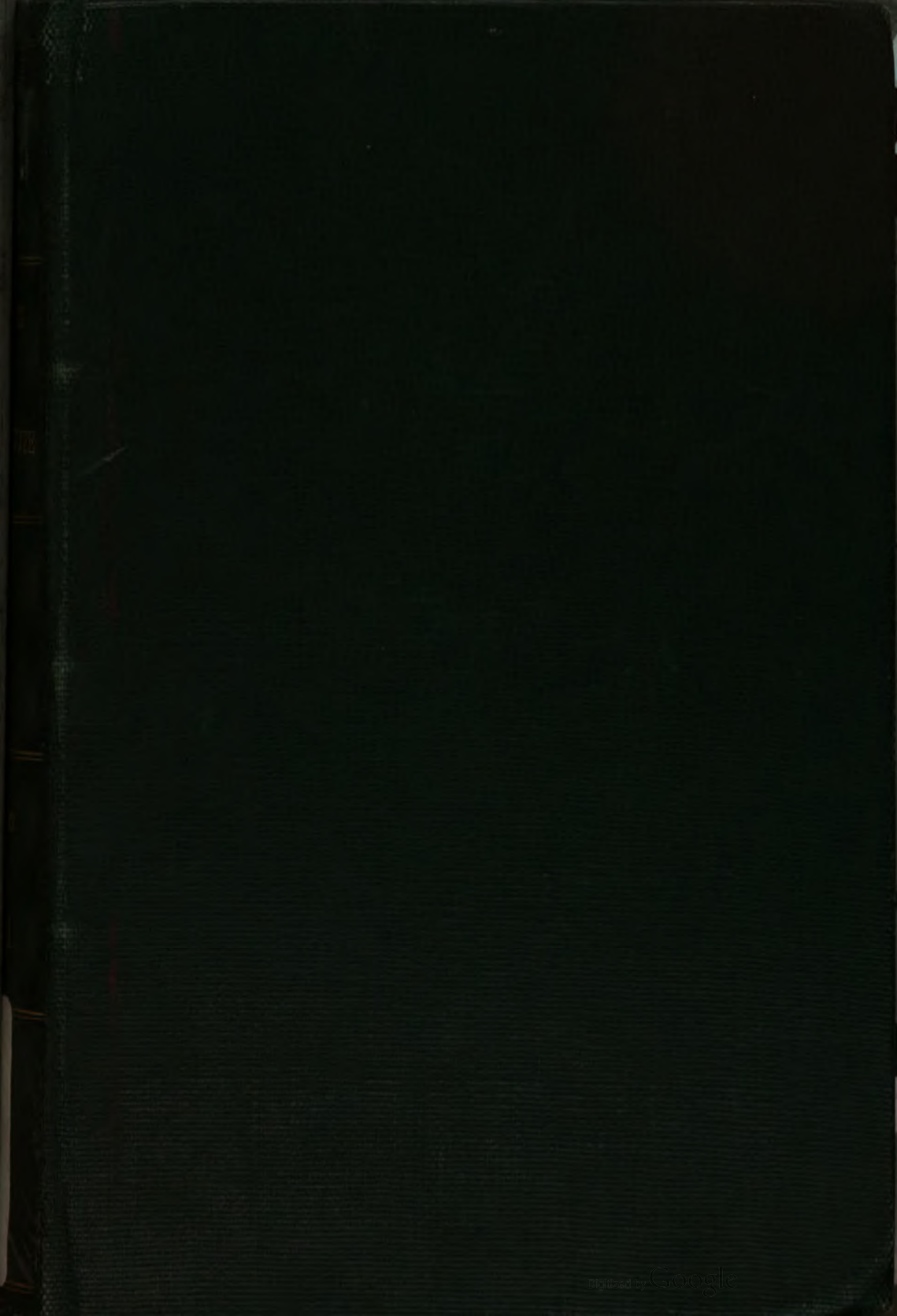

War 30, 18 (47, no. 7-12)



Harvard College Library

FROM

The Institute.















War 30.18

# United States Naval Institute

## Proceedings



EX SCIENTIA TRIDENS

The writers only are responsible for the contents of their respective articles

### CONTENTS

	PAGE		PAGE
The Relation of Personnel to Matériel.— Pond . . . . .	991	Venus as a Day Sight.—Carney . . . . .	1069
Leadership of Men.—Good . . . . .	1013	Specialization Versus Amalgamation.— Ziegler . . . . .	1073
An International Outlook.—Knapp . . . . .	1023	Discussion . . . . .	1083
Europe Since the Armistice.—Creighton . . . . .	1029	Secretary's Notes . . . . .	1086
A Labor Saving and More Efficient Method of Daily Analysis of Engineering Per- formance.—Moore . . . . .	1049	Professional Notes . . . . .	1089
Fleet Radio Communication in War.—Kent . . . . .	1059	Notes on International Affairs . . . . .	1139
		Review of Books . . . . .	1145
		Information Index . . . . .	1088

Copyright, 1921, by J. W. Conroy, Trustee for U. S. Naval Institute

Entered at the Post Office at Annapolis, Maryland, as Second Class Matter

# WORLD'S ONLY MANUFACTURER

Moulded High Frequency—High Tension Insulators and Insulating Parts

~~ELECTROSE~~ **INSULATORS, 1,000 TO 1,000,000 VOLTS**

INSULATION

**"MADE IN AMERICA"**



REG. U.S. PAT. OFF. & FOREIGN COUNTRIES.  
Louis Steinberger's Patents

INSULATION

**"MADE IN AMERICA"**

**"ELECTROSE" Insulators are standard with UNITED STATES NAVY and ARMY and WIRELESS TELEGRAPH and TELEPHONE COMPANIES.**

**"ELECTROSE" is made in a number of grades for various requirements, each grade possessing special characteristics.**

**"ELECTROSE" INSULATORS—BEST IN THE WORLD FOR HIGH FREQUENCY CURRENTS POWER AND TRANSMISSION CIRCUITS**

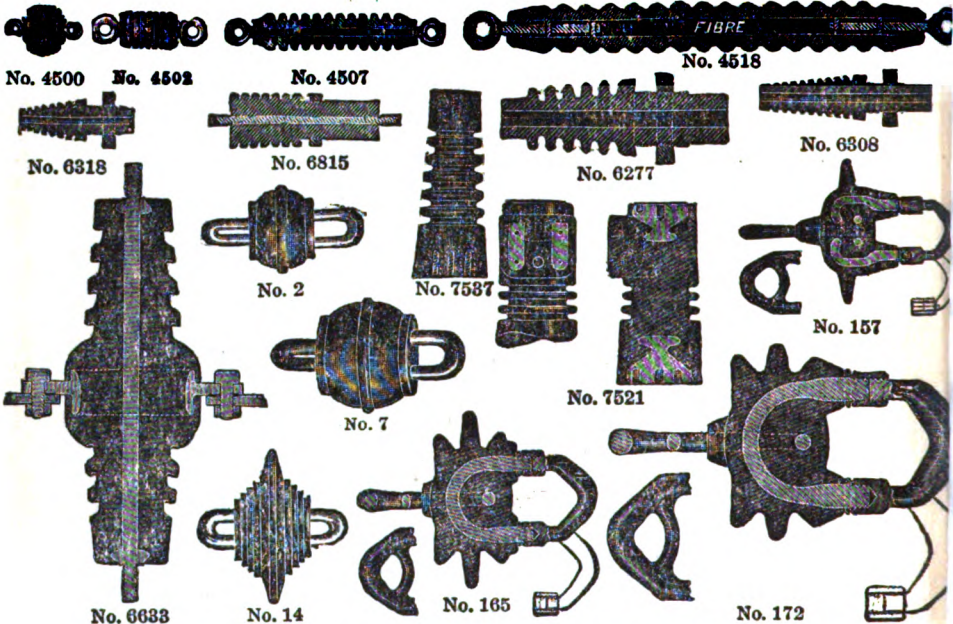

## "ELECTROSE" STANDARD PRODUCTS

**"Arcover" disk strain and suspension line insulators, "Safety Strain" insulators, Disk, Horn, Thimble and Rod type strain insulators, Spool and Bracket-Arm strain insulators, Pin type line insulators, Insulator pins, Roof, Barrier and Wall Bushings and Insulated Connectors, single and multi-part, plain and locking, water and gas tight, Bus-bar insulators, Insulating Support and Pedestals, Arc Lamp Insulators, Insulating Knobs and Handles, Insulating Sheets, Tubes and Rods, etc., etc.**

**"Electrose" Railway Line Material:—"Safety Strain" Insulators, Brooklyn Strain Insulators, Insulated Turn-Buckles, Caps and Cones, "Ideal" Locking Caps and Cones, Insulating Bolts, Feed Wire Insulators, Third Rail Insulators, also special forms of Trolley Wire Suspension Insulators, etc., etc. Complete line always carried in stock.**

**Ignition Insulating Parts:—Distributor Blocks, Disks, Switch Bases, Spools, Brush Holders, Knobs, Handles, etc., etc.**

**"Electrose" insulation (certain grades) is recognized as the best obtainable for use in connection with insulating parts for ignition service for Automobiles, Aeroplanes, Motor Boats, etc.**

**Insulators and Insulating Parts and Devices of special sizes and forms, designed and made to order.**

Sole Manufacturers



66-82 Washington St. 27-37 York  
66-76 Front St. 1-23 Flint St  
**BROOKLYN, N. Y., AMERICA**

# United States Naval Institute Proceedings

PUBLISHED MONTHLY  
EDITED BY H. K. HEWITT



U. S. NAVAL INSTITUTE  
ANNAPOLIS — MARYLAND

△  
War 30. 18 (47, 10.7-12)  
✓



*The Institute*

COPYRIGHT, 1921  
By J. W. CONROY  
TRUSTEE FOR U. S. NAVAL INSTITUTE

**The Lord Baltimore Press**  
BALTIMORE, MD., U. S. A.

6-12

*The writers only are responsible for the contents of their respective articles*

## CONTENTS

---

THE RELATION OF PERSONNEL TO MATÉRIEL. By Commander John E. Pond, U. S. Navy.....	991
LEADERSHIP OF MEN. By Ensign R. F. Good, U. S. Navy.....	1013
AN INTERNATIONAL OUTLOOK. By Rear Admiral H. S. Knapp, U. S. Navy .....	1023
EUROPE SINCE THE ARMISTICE. A Condensed Review of the Political and Military Movements Abroad. By Lieut. Commander J. M. Creighton, U. S. Navy.....	1029
A LABOR SAVING AND MORE EFFICIENT METHOD OF DAILY ANALYSIS OF ENGINEERING PERFORMANCE. By Lieut. Commander W. L. Moore, U. S. Navy.....	1049
FLEET RADIO COMMUNICATION IN WAR. By Lieutenant (J. G.) H. D. Kent, U. S. Navy.....	1059
VENUS AS A DAY SIGHT. By Lieutenant R. B. Carney, U. S. Navy....	1069
SPECIALIZATION VERSUS AMALGAMATION. By Lieut. Commander S. J. Zeigler, Jr. (C. C.), U. S. Navy.....	1073
DISCUSSION .....	1083
SECRETARY'S NOTES .....	1086
PROFESSIONAL NOTES .....	1089
NOTES ON INTERNATIONAL AFFAIRS.....	1139
REVIEW OF BOOKS .....	1145
INFORMATION INDEX .....	1088

## OFFICERS OF THE INSTITUTE

---

### *President*

REAR ADMIRAL BRADLEY A. FISKE, U. S. NAVY

### *Secretary and Treasurer*

COMMANDER H. K. HEWITT, U. S. NAVY

### *Board of Control*

REAR ADMIRAL BRADLEY A. FISKE, U. S. NAVY (*ex officio*)

BRIGADIER GENERAL GEORGE RICHARDS, U. S. M. C.

CAPTAIN JOHN HALLIGAN, JR., U. S. NAVY

CAPTAIN T. L. JOHNSON, U. S. NAVY

CAPTAIN E. J. KING, U. S. NAVY

CAPTAIN W. G. DU BOSE, CONSTRUCTION CORPS, U. S. NAVY

COMMANDER J. O. RICHARDSON, U. S. NAVY

COMMANDER H. K. HEWITT, U. S. NAVY (*ex officio*)

## PAST PRESIDENTS

---

ADMIRAL DAVID D. PORTER, U. S. NAVY, 1873

REAR ADMIRAL JOHN L. WORDEN, U. S. NAVY, 1874

REAR ADMIRAL C. R. P. RODGERS, U. S. NAVY, JAN. 1875-JAN. 1878

COMMODORE FOXHALL A. PARKER, U. S. NAVY, JAN. 1878-JAN. 1879

REAR ADMIRAL JOHN RODGERS, U. S. NAVY, JAN. 1879-JAN. 1882

REAR ADMIRAL C. R. P. RODGERS, U. S. NAVY, JAN. 1882-JAN. 1883

REAR ADMIRAL THORNTON A. JENKINS, U. S. NAVY, JAN. 1883-OCT.  
1885

REAR ADMIRAL EDWARD SIMPSON, U. S. NAVY, OCT. 1885-OCT. 1887

REAR ADMIRAL STEPHEN B. LUCE, U. S. NAVY, OCT. 1887-OCT. 1898

REAR ADMIRAL WM. T. SAMPSON, U. S. NAVY, OCT. 1898-OCT. 1902

REAR ADMIRAL H. C. TAYLOR, U. S. NAVY, OCT. 1902-OCT. 1904

REAR ADMIRAL C. F. GOODRICH, U. S. NAVY, OCT. 1904-OCT. 1909

REAR ADMIRAL RICHARD WAINWRIGHT, U. S. NAVY, OCT. 1909-OCT.

1911





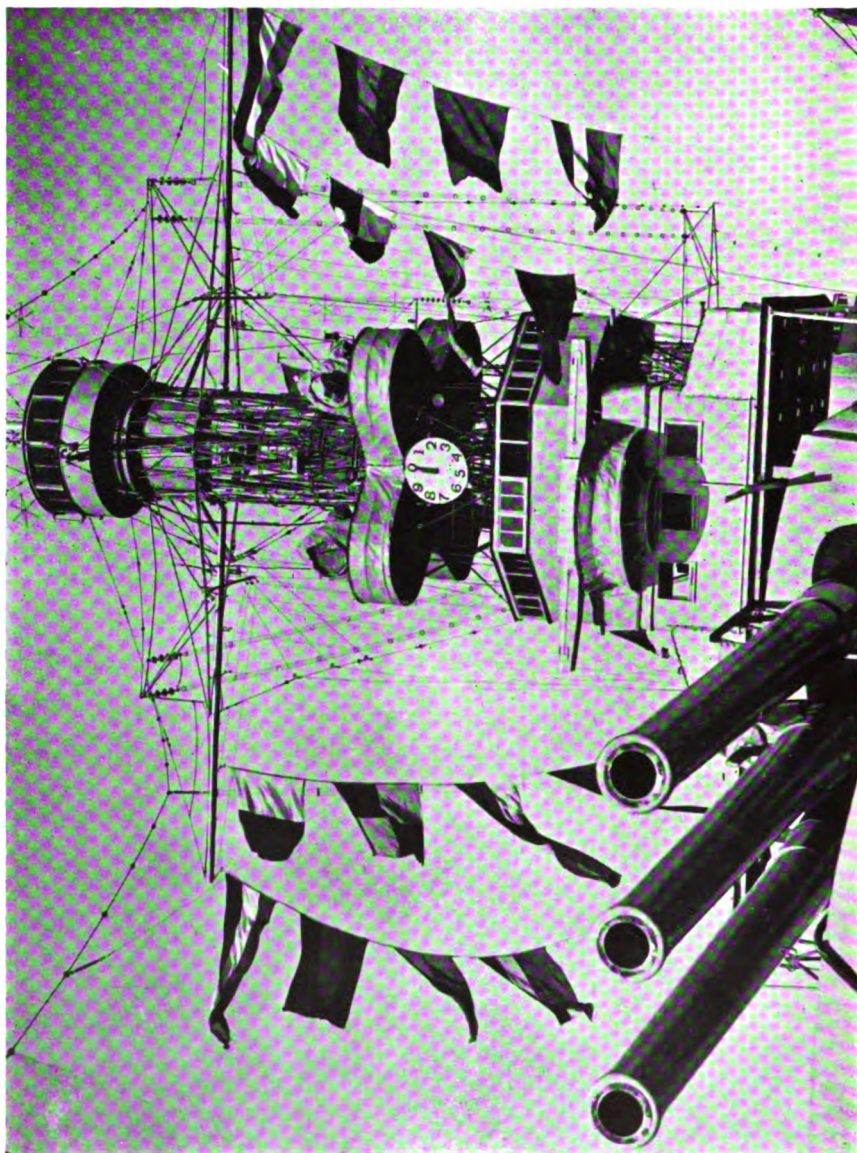

FLAG HOIST, U. S. S. PENNSYLVANIA

# UNITED STATES NAVAL INSTITUTE PROCEEDINGS

---

Vol. 47, No. 7

JULY, 1921

Whole No. 221

---

[COPYRIGHTED]

U. S. NAVAL INSTITUTE, ANNAPOLIS, MD.

---

## THE RELATION OF PERSONNEL TO MATÉRIEL

By COMMANDER JOHN E. POND, U. S. Navy

---

### FOREWORD

During the past ten years I have given much thought to the subject of this paper, and have long held the beliefs set forth in regard to the status of reserve ships and the organization of the reserve force.

I am fully aware that some of my ideas are rather radical, and would entail legislative changes if adopted; but I am fully convinced that I am right in my premises, and I feel that the time is now ripe to set them forth on paper.

I do this with the knowledge that many officers to whom I have presented these ideas have expressed agreement and some have requested me to write them down and submit them to the service for discussion; so if this paper proves worthy of discussion, whether of criticism or approval, I shall feel that I have accomplished my purpose and have rendered a service to the navy and to my country.

For the sake of brevity I have purposely avoided going into many of the essential details of administration and organization, contenting myself with setting forth the main features of my plan and trusting the reader to answer for himself, or bring forth in discussion, any collateral questions that may arise.

My desire is to obtain efficiency with economy, and to see the country get some adequate return for the enormous amount of money it now spends on maintaining the personnel of the navy and the Naval Reserve Force.

If the reorganization I have outlined for the Naval Reserve in the last pages of this paper could be effected, we would never again witness such a spectacle as is going on now—recruiting the navy up to 138,000 on January 21, about facing and inviting acceptance of discharges “without

regard" to rate, length of service, vacancies in complement, etc., in order to reduce to 100,000; and then about facing again today; all in the short space of one short month.

I do not know yet how many men have been discharged; but I do know that it costs an average of about \$100 per man to discharge them, and that those who were discharged from training stations were a total loss to the government, to say nothing of the effect on the morale of those who were expecting discharge when the order to stop was received.

Under the proposed organization of the reserve force, practically all of those *desirable* men would have transferred to the second reserve without further cost to the government.

JOHN E. POND.

U. S. Naval Training Station,  
San Francisco, California,  
March 2, 1921.

## THE RELATION OF PERSONNEL TO MATÉRIEL

### A PLEA FOR A POLICY

It is generally understood and conceded by those who give the subject any thought that armaments are the inevitable result of conflicting national policies.

It is also generally understood by legislators in Congress that some of our own national policies such as Monroe Doctrine, Oriental Immigration, Fisheries, Shipping Laws, etc., do conflict with the policies of other nations, and that at the present time we do need a very powerful armament.

In times of peace the desire and necessity for economy in government expenditures always lead some otherwise sane men into the folly of pacifism, and the military services are always the first to suffer when cuts in appropriations are deemed necessary.

There is a tendency in that direction now, but the lessons of the World War are still fresh and strong enough to offset it despite the great necessity for economy.

The problem of the day is to find a way to cut down the expense of our military establishments and at the same time maintain our relative strength in the face of existing conflicting national policies.

The consensus of opinion born of our experience in the World War seems to be (a) we *do not need* a very large *standing* army (b) we *do need* a very powerful navy.

But there is a very strong feeling against militarism in this country which expresses itself in opposition to any vast military

establishment, particularly from the standpoint of *personnel* as is especially evidenced concerning the army.

In spite of this feeling against militarism there seems to be a disposition on the part of Congress to provide an adequate navy from the standpoint of *matériel*, an adequate force of regular officers, and a large Naval Reserve of trained men from which we can quickly draw in time of need.

The navy should immediately take advantage of this disposition and formulate a definite policy for itself along these lines:—a plan of organization to maintain a large *matériel* in the highest possible state of efficiency and readiness with the reduced personnel that Congress is disposed to provide, together with a *reserve organization that will bear a proper relation to the remaining un manned matériel.*

If the navy should adopt such a policy, and stick to it, and lay its plans in accordance with it, there would be no difficulty in indoctrinating Congress to the navy's needs.

At present there is a habit in the navy of blaming our lack of policy on our form of government and therefore being content with a hand to mouth policy for ourselves.

When the Congress is inclined to favor us we get enthusiastic and take everything we can get Congress to give, oftentimes overreaching along one line of activity without regard to its relation to the whole or to the future.

The present personnel situation is a case in point.

It is the navy itself, the navy's lack of continuing policy, and not the form of government, that is to blame for the ups and downs resulting from the changes of administration and whims of Congress.

The policy outlined below is entirely practical and in the long run will prove more efficient and decidedly *more economical* than the present "Policy of No Policy."

*It requires not only reorganization of our Naval Reserve Force, but the establishment of reserve bases.*

We do not now possess any such reserve bases. However, with plans already under way for the development of Pacific Coast naval bases, with a new administration about to enter office, and considering the existing urgent demand for economy and the disposition of Congress to favorably consider any proposition that might lead to reducing the cost of the navy, the time is most pro-

pitious for the navy to get together and put such a policy into practice.

The federal administration is chiefly concerned with the maintenance of a navy of sufficient strength to back up its immediate foreign policies and to show the flag in foreign ports, with a reserve capable of expansion to meet any national emergency that might arise from a combination of such powers as may be opposed to its policies.

The Secretary, with the advice of the General Board, informs Congress of the administration's naval requirements; but the responsibility for providing the personnel and matériel and appropriating the funds for construction, maintenance and operation, rests entirely with Congress.

Aside from the General Board's duty and responsibility to properly advise the administration as to its naval requirements for carrying out its foreign-policies, *the navy's chief concern is the efficiency of the personnel and matériel provided.*

#### EFFICIENCY OF THE ACTIVE PERSONNEL

Since the maximum efficiency of the active navy can only be attained by operation with full complement, it follows that the navy's policy should first require that all ships in active commission be fully manned.

It also follows that only such ships should be kept in commission as can be fully manned with the personnel provided.

If this policy were adhered to we could depend upon the administration to obtain from Congress the authority for the necessary increase of enlisted personnel whenever its foreign policies require an increase in the strength of the active navy.

Since the personnel of the active navy would thus be subject to sudden expansion and since efficiency depends to a great extent on trained officers and chief petty officers, it follows that the navy's policy should next require that its excess officers and chief petty officers be kept in training by being actively employed in naval duties.

#### EFFICIENCY OF RESERVE PERSONNEL

Since the main purpose of an organized reserve force is to man the reserve ships in case of national emergency, and since effi-

ciency requires not only training of personnel in navy duties and customs but familiarity with the material to be manned, it follows that the navy's policy should next require that the Reserve Force be organized in *ship units* and definitely assigned to reserve ships, and that the reserve ships be kept in condition of readiness for active service.

TO SUM UP PERTINENT FACTS, THE NAVY'S POLICY SHOULD BE

*With Respect to Personnel:*

- (1) To keep the ships in commission fully manned at all times ;
- (2) To keep excess regular officers and chief petty officers actively engaged in naval duties ;
- (3) To organize the Reserve Force in ship units and definitely assign them to reserve ships.

*With Respect to Matériel:*

- (4) To keep only such ships in active commission as can be fully manned with the enlisted personnel provided by Congress ;
- (5) To lay up in reserve all ships for which Congress has not provided regular enlisted personnel ;
- (6) To provide facilities on shore for keeping reserve ships in such condition of readiness that they can be promptly placed in active service when needed, either in case of national emergency or to replace a unit of the active fleet.

#### NAVAL BASES AND THE NAVAL RESERVE

I believe that *our greatest naval need to-day is suitable bases for laying up ships in reserve.*

We do not now possess any such suitable bases and we cannot completely carry out the above outlined policy until they are provided.

But now is the time to make a start—with the projected Pacific Coast Naval Base at Alameda, California.

There is a conception in the public mind (and apparently in the naval mind as well, to judge from the loose way in which the term is used) as to the meaning of the term "naval base."

*A naval base is a port in which naval activities and facilities for the maintenance and supply of a fleet are located.*

Repair yards, dry docks, coaling stations, oil storage depots, supply depots, naval magazines, torpedo depots, receiving ships,

hospitals, marine posts, small arms target ranges, drill grounds, recreation fields, etc., are merely attributes of a naval base, any number of which may go to make up the base, depending upon the character, purpose and strategic position of the base and the composition of the fleet or unit it is intended to serve.

There should be one main naval base on each coast to serve the entire fleet, and they should be located in Chesapeake Bay and in San Francisco Bay, respectively.

The *main naval bases* should, in addition to facilities for repair, docking and supply of the entire fleet, *include reserve bases for the capital ships* of the Atlantic and Pacific fleets.

On the Atlantic coast there should be secondary naval bases at New York and at Pensacola, Florida; with operating bases for destroyers, submarines and aircraft at such other strategic points along the coast line as Portsmouth, Boston (Squantum), Long Island Sound (New London), Charleston, Key West and New Orleans.

On the Pacific coast we should have one secondary naval base at Puget Sound; and operating bases for destroyers, submarines and aircraft at such other strategic points along the coast line as Port Angeles, Astoria, Sausalito, San Pedro and San Diego.

The secondary naval bases should, in addition to facilities for repairing, docking and supply of any one of the units of the fleet, include reserve bases for the cruisers, gunboats, special types and auxiliaries of the reserve fleets.

The destroyer, submarine and aircraft bases in the continental U. S. should, in addition to supply facilities, include reserve bases for destroyers, submarines or aircraft as the case may be.

Fleet operating bases should be located at Guantanamo, Panama, Pearl Harbor and Manila Bay; with destroyer, submarine and aircraft operating bases at strategic points in Alaska (Dutch Harbor and Seward), West Indies (St. Thomas or Porto Rico), Panama, Hawaii, Guam and the Philippines.

The fleet operating bases should each include facilities for repair, docking and supply of the entire fleet.

The destroyer, submarine and aircraft operating bases outside the continental limits of the United States should include only supply facilities for the units they are intended to serve.

All the attributes of a great naval base need not, and I believe should not, be grouped in one place.

For instance, take San Francisco Bay.

The effort to bring about the establishment of a real naval base in San Francisco Bay would never have met with such wilful opposition if there had been a proper conception of the meaning of "a great naval base," not only on the part of the local public affected but of the personnel of the various boards and committees that have been engaged in determining upon the site.

The site of Alameda has finally been chosen; but has the Navy Department any very definite plan as to just what activities or attributes of a great naval base are to be established at this site?

The usual practice in such cases in the past has been to locate a site for a naval station, and then decide what activities to establish there, and let the future needs of the navy determine from time to time what activities shall be added.

Such locations have sometimes been selected through purely political expediency; and, in some cases, even the activities established at naval stations have been established to gratify local political desires and not primarily to fulfil the requirements of the navy, as should be the case.

The result is obvious.

These stations in time become obsolete or inadequate for all the navy's requirements, and incapable of expansion to meet those requirements.

Yet the vested interests of the immediate locality work to prevent abandonment and removal to a better site, or the establishment of additional activities at other sites; and good money continues to be thrown after bad.

This has been especially true in the case under discussion.

The vested interests and jealousies of the city of Vallejo have been able to muster sufficient political power to balk all attempts to establish a naval base in San Francisco Bay capable of handling the Pacific Fleet.

And the country now finds itself in a dangerous state of unpreparedness for war in the Pacific.

Our shore facilities are incapable of handling the entire Pacific Fleet even in time of peace.

Let us therefore avoid past mistakes and first decide on what facilities and activities are required at each strategic point of our coast line before deciding on any definite sites for those activities.



We are now considering San Francisco Bay as a *strategic point* in which a main naval base should be established.

As I have said before in this paper, I believe that *the navy's greatest need to-day is suitable bases for laying up ships in reserve*, and that *each main base should include a reserve base for the capital ships* of the reserve fleet.

I will go into details later as to the exact facilities that should be provided at a reserve base; but suffice it to say now that the first requirement is suitable water frontage, with finger piers to berth the reserve ships, with warehouses on shore for storage of their equipment and supplies, and with sufficient room for expansion of water frontage.

The site at Alameda is admirably situated and wisely chosen for this purpose.

Of the other attributes of a great naval base the repair yards and dry docks are next in importance to be considered.

Except for its distance from the natural center of naval activities in San Francisco Bay, its inaccessibility for both freight and passenger transportation, and the inadequacy of its fresh water supply, there is no reason why Mare Island should not be retained as a ship-building yard, a repair and docking yard for small vessels, a marine regimental post, and a naval hospital.

It is a most suitable site for a naval magazine.

Hunter's Point on the San Francisco shore, directly opposite the Alameda site, appears to be the best location for docking and repair facilities.

*These last are purely industrial activities* and I can see *no logical reason for grouping such purely industrial activities with other purely military activities.*

I would therefore suggest that the dry docks and repair yards for the capital ships be located at Hunter's Point and not at Alameda.

The fleet supply department should be located at the Alameda site.

The reason is obvious, the considerations being accessibility to overland transportation, wharfage, proximity to the fleet's anchorage ground in San Francisco Bay, and the fact that *fleet supply is a military activity.*

The coaling station is suitably located at California City, overland transportation not being involved, as steaming coal is carried to this port in floating bottoms by way of Panama Canal and in the future probably from Alaska.

The oil fueling and storage depot should be located in the vicinity of Richmond, where the present pipe lines come in from the California oil fields; with a distributing line from Richmond to the Alameda Base.

The receiving ship (station?) is suitably located at Yerba Buena Island, and should be retained there.

The best location for a destroyer and submarine operating base is in Richardson's Bay, between Sausalito and Belvidere.

This is a long shallow bay, admirably protected and handy to deep clean water and the Golden Gate entrance.

By dredging the lower part between Sausalito and Belvidere Island, and filling the upper part with dredged material, it would provide not only an ideal site for a destroyer and submarine operating base but an ideal field for an aircraft operating base as well.

Suitable locations for small-arms target ranges, accessible by existing rail transportation, can be found in Marin County and in the country back of the Contra Costa Hills.

Navy Department General Order No. 372 of February 28, 1918, recognizes the necessity of removing "from the navy yard organizations, as now operated, certain activities which have no relation to the actual work of the yards, which is industrial, such as receiving ships, marine barracks, naval hospitals, medical supply department, electrical schools, ammunition depots, armed guard activities, and, in order not to unduly tax the storage facilities at the industrial yard, all supply activities and provision for storage designed to meet the requirements of overseas and district patrol activities rather than the actual needs of the yards for work to be undertaken by them."

This general order segregates the activities in each district into the following groups: Military, industrial, supply, transportation.

A perusal of the various general orders and changes in Naval Regulations that have been issued from time to time in regard to Naval Districts, will show that the present organization of Naval Districts is the result of a gradual development through necessity,

and not the result of any well defined preconceived policy at the time of their first establishment.

That being the case, *why not at least start right this time, and segregate the purely military from the industrial activities in our new naval base in San Francisco Bay?*

#### NAVAL DISTRICTS AND THE NAVAL RESERVE

The country was at war when General Order No. 372 of February 28, 1918, was promulgated, and at that time, of course, there was no immediate necessity for providing for the organization and maintenance of the reserve matériel and personnel on a peace basis.

In General Order No. 519 of March 10, 1920, with certain exceptions, all naval activities outside of Washington are grouped in Naval Districts, and the areas comprised within the various Naval Districts are redefined by "political subdivisions" "in order to facilitate the organization and administration of the Naval Reserve Force."

In General Order No. 522 of March 25, 1920, "The Naval Reserve Force on inactive duty shall be organized in the Naval Districts and assigned to various units in accordance with instructions from the Bureau of Navigation from time to time." This order goes on to define the general organization in "Divisions, Battalions, and Brigades," "depending upon the number of men available."

The whole scheme is very indefinite, and vague, even as regards personnel, and indicates a woeful lack of a policy.

No definite provisions are made for practical training while on inactive duty.

Apparently the idea of organizing the *inactive reserve matériel* has not even been considered.

Certainly no attempt is made to consider it in connection with the organization of the inactive personnel, else the organization ordered for the Naval Reserve Force on inactive duty would be along the lines of *ship units, divisions, and squadrons*, instead of "Divisions," "Battalions," and "Brigades."

## OUR FORMER POLICIES WITH RESPECT TO RESERVE MATÉRIEL

Sometime in the latter part of the year 1915, the Navy Department announced a policy in regard to placing ships in reserve about as follows:

To complete the repairs recommended by the Board of Survey before detaching excess personnel—in other words, to put ships in a first-class condition of readiness before actually placing them in reserve.

Although these ships were detached from the fleet and assigned to the reserve fleet immediately after their arrival at the navy yard, they were not to be considered "in reserve" until their repair or overhaul periods were finished; the idea being to insure proper following up and inspection of the repair work by the officers and men who had cruised in the ship and were familiar with her material condition, and to leave some of these officers and men as her reserve complement to care for her while in reserve.

While in command of the Pacific reserve torpedo flotilla, based at Sausalito and Mare Island from 1912 to 1914, I was able, in some instances, to persuade the Bureau of Navigation to revoke its usual orders and permit one officer and the leading petty officers of a destroyer joining the reserve flotilla to remain with their ship.

The usual orders provided for the exchange of crews bodily between the newcomer and her relief.

From 1914 to 1916 I was on duty at Puget Sound Navy Yard, and later in one of the armored cruisers of the Pacific reserve fleet based at that yard.

I do not recall one single instance in all that time, from 1912 until our declaration of war in 1917, in which the Department carried out the policy it announced in 1915 as described above.

I do recall many instances where it was not carried out.

The usual practice was to detach all the officers and most of the old crew within a few weeks after arrival at the navy yard.

In some cases, when a reserve ship was designated to replace one in full commission, practically the entire crews were exchanged bodily, bag and baggage.

The effect of this practice was not only detrimental to matériel, but was most discouraging to the personnel.

The young officers and petty officers of the reserve organization could not hope to retain their temporary responsible positions, even if they were fortunate enough to go with their ship when she was placed in full commission.

There was never a prospect, for them, of being able to enjoy the fruits of the hard work they had performed while in reserve.

It is to the everlasting credit of those officers and men who worked so hard to keep up the material condition of readiness of the reserve ships, in spite of the discouraging conditions described above, that those ships were able to stand up so well in the arduous duties assigned them during the war.

After demobilization we began to drop back into the old rut.

But instead of re-establishing the old reserve fleet we tried to keep up the fleet organization with inadequate personnel, by operating a few capital ships and destroyers with full crews, and the rest "in commission with reduced complement."

Finally the older battleships and armored cruisers were placed out of commission, owing to lack of personnel to man them even with reduced complements.

It is doubtful if these old ships will ever have to be placed in commission again, but on the other hand it is also more than likely that other more modern ships will soon have to be similarly placed out of commission for lack of personnel.

These ships deteriorate rapidly while out of commission.

Their spare parts will deteriorate, be misplaced and lost, or become obsolete.

Their control systems will become obsolete.

Their outfits of equipment will become depleted in store, and the reserve of expendable supplies and dry provisions necessary for recommissioning will disappear and be forgotten.

Then, when the national emergency does arise, these ships will have to be recommissioned at tremendous expense, after great delay, and with a green crew, and they will be of very little fighting value until they have had a long shakedown cruise.

Under present and past policies (or lack of policy) ships in reserve deteriorate almost as rapidly as if out of commission, principally because the work of moving coal and stores and overhauling machinery is beyond the capacity of the small ship's force to perform, and the interiors of bunkers, storerooms and

machinery are therefore neglected in the everlasting effort to keep the visible portions of the ship clean.

This applies as well to ships "in ordinary" under the old system.

Placing ships in reserve instead of out of commission at the end of a cruise also results in an ever increasing accumulation of obsolete material in their equipment storerooms.

### STATUS OF SHIPS

Section 2, Article 650, of Chapter 17, U. S. Navy Regulations, 1920, defines the "Status of Ships" as either "in commission" or "out of commission."

Vessels in commission may be in any one of four conditions, as follows:

(a) *In Full Commission*.—Vessels in this condition are fully officered and manned, and ready in all respects for service, and under orders or liable to orders for service without previous notice. They may be temporarily disabled for repairs by orders of the department, however, without changing their status. Such vessels will ordinarily be attached to fleets, special service squadrons, detachments or naval districts.

(b) *In Reduced Commission*.—Vessels in reduced commission are officered and manned with less than 80 per cent of their full complement, but with sufficient complement to maintain the vessel in material readiness for service and to perform such operations as may be necessary to insure efficient performance of the material and to train the personnel. Such vessels will ordinarily be attached to fleets, or naval districts.

(c) *In Commission in Reserve*.—Vessels in this condition shall be maintained at some designated navy yard or other suitable place, and shall be kept ready for sea on short notice. They shall have reduced complements of officers and men on board including, if practicable, an engineer officer and such engineer and artificer personnel as may be required to maintain the material in condition for operation. The provision that they shall be ready for sea on short notice shall not be construed to prevent the carrying on of such repairs as may be necessary to keep them ready for sea, or as may be authorized by the Department, but no work shall be undertaken on any of them that will render them unable to move upon the expiration of four working days after the receipt of orders, without first obtaining permission from the Department. Such vessels will ordinarily be attached to fleets or naval districts.

(d) *In Commission in Ordinary*.—Vessels in this condition shall be maintained at some designated navy yard under the commandant in such manner as will best tend to keep them in condition for service if needed, under detailed instructions from the Department. They shall have complements of officers and men on board only large enough to enable them to be properly cared for in the condition in which ordered to be maintained; their complements shall include, if practicable, an engineer officer and such artificer personnel as may be required. Necessary repairs shall be con-

ducted on them, but no work shall be undertaken on any of them without special permission from the Department which would delay them longer than would be necessary to change them from the condition in ordinary to that of readiness for sea service were no repairs in progress. Such vessels ordinarily will not be attached to fleets but will be maintained in ordinary independently.

*Ships Out of Commission.*—Ships in this condition shall have no personnel on board, and shall be under the full control of the commandant of the navy yard at which they lie. Repairs and alterations shall be carried on on board them as may be authorized by the Department, or they may be held out of commission and not under repair awaiting the Department's instructions to commission or otherwise dispose of them.

The controlling factor in determining whether a ship shall be in condition (a), (b), or (c), is available personnel.

The controlling factor in determining whether a ship shall be in the status of condition (d) or "out of commission," is condition of material and naval value.

I believe that *ships in active service should be fully manned*, and that *all others that are of any naval value whatever should be kept in reserve*.

I believe further than *no naval ship should ever be placed out of commission, except for the purpose of extensive alterations or to await disposal as of no further naval value*.

I would therefore redefine the "Status of Ships" as follows:

The status of each vessel of the navy will be definitely ordered either as (a) "in active service," (b) "in active reserve," (c) "in ordinary reserve," (d) "out of commission for alterations," or (e) "condemned."

(a) *Ships in Active Service.*—Vessels in this condition are fully officered and manned, and except when temporarily disabled for repairs, ready in all respects for service, and under orders or liable to orders for service without previous notice. Such vessels are ordinarily attached to fleets, special service squadrons, detachments, or naval districts.

(b) *Ships in Active Reserve.*—Vessels in this condition are fully officered, but with reduced crew sufficient only to maintain the vessel in material readiness for service and to perform such operations as may be necessary to insure efficient performance of the material. Such vessels are attached to the active fleets and are available to replace vessels of the active fleets on short notice. They are also available as practice ships for the Naval Reserve Force, the Naval Academy, and other training purposes.

(c) *Ships in Ordinary Reserve*.—All other vessels in commission shall be maintained in this condition at designated reserve bases.

Upon going into ordinary reserve, and before any of the officers or men are detached, all coal must be removed, all portable equipment (except guns, search lights, control installations, furniture, fighting fixtures, and "title A" spare parts) and supplies must be inventoried, tagged and properly stowed in the storehouses provided on shore, and all structural parts, machinery, and appliances must be properly cleaned, painted and otherwise preserved.

Ships in this condition will have sufficient personnel to properly care for the material and to form a nucleus for the Reserve Force when the ship is needed in case of national emergency.

They will be attached to the reserve base under the commandant and their personnel will be suitably quartered and messed on shore.

(d) *Ships Out of Commission for Alterations*.—Ships in this condition shall have no personnel, and shall be under the full control of the superintendent of the dock yard at which they lie.

Repairs and alterations shall be carried out on board them as may be authorized by the Department.

(e) *Condemned Ships*.—Orders for placing ships in this condition will be issued by the Chief of Naval Operations, and such ships shall thereafter be preserved in their present condition at such stations within a district as the commandant of the district may direct, pending further instructions from the Department as to their final disposition.

Naturally these ships will be placed in the condition of "ordinary reserve" before being placed out of commission or condemned.

Vessels maintained in commission shall fly the flag and commission pennant regardless of their service status as defined above.

Vessels out of commission shall not fly the flag or commission pennant.

#### ADMINISTRATION AND ORGANIZATION OF NAVAL BASES

It will be sufficient for the purpose of this paper to merely mention a few of the points involving changes in Chapter 41 of



Navy Regulations, 1920, without going into details of administration and organization.

Should the policy I have outlined be adopted, such changes as may be necessary will be apparent to those in the office of the Chief of Naval Operations who are charged with the preparation and revision of the Navy Regulations.

These points are:

(1) A naval base should be considered as one of the administrative groups or units of a Naval District.

(2) The headquarters of the commandant of the naval base within the continental United States should be at the reserve base.

(3) The principal administrative establishments that may be included within a naval base, their character, and their administrative officers, should be as indicated in the following table:

#### ADMINISTRATIVE ESTABLISHMENTS WITHIN A NAVAL BASE

Designation	Character	Administrative Officer
Reserve Base .....	Military .....	Commandant—Line.
Supply Depot .....	Military .....	Director—Supply Officer.
Ammunition Depot .....	Military .....	Officer-in-Charge—Line.
Small Arms Target Range .....	Military .....	Officer-in-Charge—Line.
Receiving (Ship) Station .....	Military .....	Commanding Officer—Line.
Base Hospital .....	Military .....	Commanding Officer—Medical Officer.
Dock Yard .....	Industrial ..	Superintendent—Constructor.
Coal Depot .....	Industrial ..	Superintendent—Line Engineer
Fuel Oil Depot .....	Industrial ..	Superintendent—Line Engineer
Destroyer and Submarine Operating Base .....	Military .....	Commanding Officer—Line.
Air Station .....	Military .....	Commanding Officer—Line Aviation.

(4) The activities of a reserve base should include the following principal units:

- Naval base headquarters.
- Branch War College.
- Technical trades schools.
- Reserve ordnance depot.
- Reserve torpedo depot.
- Reserve ship units.
- Officers club (including mess).
- Warrant officers club (including mess).

Chief petty officers club (including mess).  
 Enlisted men's club.  
 General mess hall.  
 Parade grounds.  
 Recreation field.  
 Naval hospital.

#### RESERVE SHIP UNITS

*Facilities.*—Reserve ship units should comprise the following facilities for maintaining them in the condition of "Ordinary Reserve."

1. Berthing space at finger pier with railroad track leading to storehouses.
2. Equipment storerooms.
3. Boat storage shed.
4. Supply storerooms.
5. Reserve Force outfit storeroom.
6. Crew's dormitory.
7. Offices, with officer of the day sleeping room.
8. Executive officer's quarters.

#### ADMINISTRATION AND ORGANIZATION

The regular personnel of a capital ship in "ordinary reserve" should include the following:

1. A commanding and executive officer of suitable rank to continue in the office of executive if the ship should be called to active service.
2. As navigator, a line officer of suitable rank to take the duties of senior watch in active service.
3. As engineer officer, a chief machinist or other line officer of suitable rank and experience to assume the duties of assistant engineer in active service.
4. As gunnery officer, a chief ordnance gunner or other line officer.
5. As first lieutenant, a chief carpenter or carpenter.
6. As electrical officer, an electrical gunner or other suitable line officer.
7. As boatswain, a chief boatswain's mate.

8. As ship's writer a chief yeoman capable of taking the duties of captain's yeoman in active service.

9. As supply officer, a supply officer of suitable rank and experience to continue in the duties of general storekeeper in active service.

10. A chief yeoman for the general storekeeper.

11. Such other ratings as may be necessary for watch duty and for preservation of the equipment, supplies, machinery, and structural parts of the ship.

The regular personnel of other ships in this status should include an executive and an engineer and such other officers and men as the type and size of the ship may require.

Men with from sixteen to twenty-five years service should be assigned to ships in ordinary reserve whenever practicable.

The accounts of officers and men regularly attached to ships in ordinary reserve should be carried by the disbursing officer of the reserve base.

The complete outfit of equipment and spare parts should be kept on hand in the equipment storerooms on shore, all properly inventoried, grouped, and suitably tagged with the name and location of the storeroom in which they are to be stowed when on board ship.

The usual allowance of expendable supplies (except ammunition and fuel, which should be kept on hand at the ammunition and fuel depots, respectively), clothing and small stores, and such dry provisions as are not likely to deteriorate, should be kept on hand in original packages in the supply storerooms on shore; all properly inventoried, grouped, and suitably tagged with the name and location of the storeroom in which they are to be stowed when on board ship.

The bag, hammock, and ditty box of each reservist detailed to a ship in ordinary reserve should be *numbered, tagged* with the owner's name, and stowed in suitable racks in the Reserve Force outfit storeroom on shore.

The service records of the reservists detailed to a ship in ordinary reserve should be kept by the executive officer in the same manner as those of the regular crew.

The executive officer should keep in touch with all members of the Reserve Force detailed to the ship, and should furnish each

of them with a station billet, a roster of officers and men, and other pertinent information in regard to their ship and their duties.

The head of each ship department should likewise keep in touch with the reserve personnel detailed to his department.

The mobilization orders for the members of the reserve force detailed to a ship in ordinary reserve should be issued by the executive officer.

The station billets should include individual instructions as to procedure in case of mobilization or call to active duty.

#### REORGANIZATION OF NAVAL RESERVE FORCE

The Naval Reserve Force should be reorganized and separated into first reserve and second reserve.

The first reserve should comprise those detailed to ships in ordinary reserve and should be organized in ship units.

The second reserve should comprise the Reserve Force general detail list of the naval district, and should not be organized.

The records of members of the first reserve should be carried at the reserve base.

The records of members of the second reserve should be carried at the district headquarters.

Members of the second reserve should be transferred to the first reserve to fill vacancies in ship units.

Members of ship units should be selected as far as practicable from the same locality.

Members of the first reserve should be permitted to wear the uniform *with the cap ribbon of their ship*, on official and social occasions. For this purpose they will be required to retain one blue dress uniform and cotton undershirt. The remainder of their *full bag* outfit will be kept at the reserve base.

Members of the second reserve should not be required to have the uniform, although they may be permitted to wear it on official occasions.

Members of the *first reserve should be paid adequate retainer pay.*

Members of the *second reserve should not receive retainer pay.*

Transfer to the second reserve from the active navy should be substituted for the present "Furlough without pay." (Special Order discharges should be abolished.)

Men so transferred should be placed at the foot of the list of their rating in the general detail, and should not be eligible for transfer to the first reserve until their "number is made."

Transfer from the reserve to the active navy involves losing a place on the list of the general detail should the man desire to return to the reserve before expiration of enlistment.

Men honorably discharged from the active navy are eligible for a place at the head of the list of their rating in the general detail, should they desire to join the reserve.

Ex-members of the first reserve are not entitled to a place on the list of the general detail unless while disenrolled they have completed an enlistment in the active navy.

They must otherwise start again at the foot of the list of the general detail.

Members of the first reserve should be eligible for entrance, at their own request and provided they have the necessary preliminary educational qualifications, to any of the technical trades schools maintained at the reserve bases in their district. Transportation to and subsistence while attending such schools should be at their own expense.

Ships "in active reserve" should be detailed for training the first reserve.

At least two such ships should be detailed to this duty at each reserve base. If the number of first reserves applying for training require it, two groups of such ships should be detailed for this purpose.

These ships should be employed alternately throughout the year in cruises of about one month's duration.

The itinerary and schedule of operations for each of these cruises should be published well in advance by the commander-in-chief of the fleet to which attached.

Each member of the first reserve should be entitled, *but not required*, to take one of these cruises at government expense each year.

Each member of the first reserve should be permitted to take as many more of these cruises as he may desire *at his own expense*.

Each member of the second reserve should be permitted to take as many of these cruises as he may desire *at his own expense*.

Original enrollment in the second reserve should be limited to United States citizens and native-born minors over fifteen years of

age, but such minors are not eligible for advancement to the first reserve until they have reached the age of seventeen with parents' consent or eighteen without parents' consent.

*Membership in the first reserve would thus be a coveted privilege that could only be obtained by going through the second reserve or by completing an enlistment in the active navy.*

NOTE.—Most of this paper was prepared before receipt of U. S. Navy Regulations, 1920. Attention is invited to the definitions given in Section 2, Article 2050, of Chapter 52, U. S. Navy Regulations, 1920, which coincide in substance with the definitions in this paper.

Attention is also invited to the article by Captain Reginald R. Belknap, U. S. Navy, on "Squantum, the Victory Plant," in the February 1921 number of the PROCEEDINGS of the United States Naval Institute.



[COPYRIGHTED]

U. S. NAVAL INSTITUTE, ANNAPOLIS, MD.

---

## LEADERSHIP OF MEN

By ENSIGN R. F. GOOD, U. S. Navy

We should guarantee to every man his full rights, and exact from every man the full performance of his duty.—THEODORE ROOSEVELT.

---

In attempting the preparation of a treatise on the subject of "Leadership of Men" it has been necessary for the writer to view the subject from the standpoint of a young officer in charge of a division on board ship, for, to state frankly a fact which will appear to an older reader only too evident, that has been the extent of his experience.

It is not illogical to assume, however, that there are certain fundamental principles of procedure, modified of course by the degree of education and training to which applied, which will prove equally efficient, whether used by a division officer to gain the loyal co-operation of the petty officers and men under his charge or employed by a commander-in-chief to indoctrinate his force commanders. Furthermore, the mental habits acquired by an officer during his first tour of sea duty are apt to be life-long; and for that reason it is all the more important that during these years an officer should come to understand and observe the principles of true leadership.

It is true that some men are "born" leaders; that is, they inherit the essential qualities of leadership. A far greater number acquire leadership by careful study and industrious application. But no man ever had leadership "thrust upon him." Command, yes, but leadership never. Unless a man be heir to the elements of what Napoleon called "the sacred fire" he can win it to himself only by painstaking effort.

It is, therefore, with the aim of presenting the fundamentals and ideals of leadership to the younger generation of officers, not from the pinnacle of senior officer who has fought and won his



battle, but from the standpoint of one actually engaged with his own problem, that this article is undertaken.

#### LEADERSHIP DEFINED

Webster briefly defines leadership as "the ability to lead." From a military point of view, however, this is scarcely explicit. A more comprehensive definition is arrived at by "putting the cart before the horse." As the object of all leadership is "the achievement, through the acts of men, of a definite purpose or result," so leadership is the means to the end, the procedure by which the leader brings his men, not as individuals alone, but with unified hearts and minds, to direct their efforts toward the attainment of the desired goal.

In this, leadership and morale are inseparably joined. Morale has been broadly defined as the spirit of an organization—its courage, its pride, its loyalty, its stamina. In high morale these qualities (and many others) are found in the superlative degree. Since leadership can operate only through a high morale it is saddled with the two-fold duty of first creating this *esprit de corps* and then administering the force thus created to the accomplishment of the desired end. Some authorities point out that of leadership and morale the latter is the more important, as proof citing instances in which organizations possessing high morale have accomplished much under mediocre leaders. But it must be remembered that such organization was not endowed with this high morale in its infancy. Rather, it will be found that this very morale was conceived and nourished by one who understood the cardinal principles and virtues of leadership.

In a recent address delivered before the Naval War College, Admiral Sims made the following statement: "A fleet of the most powerful vessels would be of little use in war without a personnel at least as efficient as that of our possible enemies." We have, then, in a word, both the meaning and object of leadership (so far as it applies to the military services at any rate); namely, by the creation of a high morale and its scientific administration, the bringing of our personnel to the topmost peak of efficiency. And to do this we must start at the bottom, begin with the relations existing between the division officer and the men under his command. The rest follows as an ascending scale of natural sequence.

## STRUCTURAL ANALYSIS OF LEADERSHIP

The physical structure of leadership (if such a structure is assumed to exist for purposes of analysis) corresponds closely to the erection of a permanent building. The wise architect first selects a firm foundation. Next the component parts are manufactured from the raw material. Lastly these various parts are combined in their proper relation to form the completed whole. So it is with leadership. The foundation on which the leader must build is military character. The component parts to be fashioned from the rough are the individuals with whom he works, and the product, if the work be well planned and carefully performed, is a skilled organization of superior morale.

## MILITARY CHARACTER THE FOUNDATION OF LEADERSHIP

Character is an intangible attribute, composed of all the virtues and vices of the human race, and broadly classified good or bad as the virtues or vices predominate. The point that must be constantly remembered, however, is that character, like small-pox, is contagious, and if the organization is to possess a good character it must be exposed to that which it is expected to contract. Military character is to the leader that which by force of example will inculcate in the followers the military characteristics which the leader himself exhibits. Military character is to the leader as morale is to the organization. If the leader has a strong military character his command will have high morale.

The measure of military character is, to a certain extent, its very intangibility. But for purposes of exposition it may be assumed to consist of a number of virtues—in military character the vices have no place.

Among the prime requisites of military character (the word among is used here because no effort is made to list these requisites in order of their rightful priority) is knowledge. This knowledge is of two kinds. First the officer who aspires to leadership must "know his job." He must know just what is expected of his unit in the larger organization and the most expeditious and efficient way of carrying it out. If he does not know his division work his leading boatswain's mate can do a better job than he can, and even in a division where spirit is excellent a petty officer who thinks he knows more than his division officer will not hesitate

to confide this opinion to his shipmates. By this it is not meant that a division officer must burden himself needlessly with the myriad details of ship's work. But he must "know how," so that when he is appealed to for specific instructions he can give them clearly, concisely, and without hesitation. Otherwise he must inevitably sacrifice the respect of his petty officer and men for his ability, and loss of respect in any way, shape, or form means lowered morale and decreased efficiency.

In the second place, the successful officer must have a knowledge of men. A superficial knowledge is not sufficient, and in this instance an ounce of actual contact is worth a pound of book psychology. The officer has ever before him the goal of increasing the value of the personnel. This can only be done by elevating the value of the individual. As Von der Goltz puts it: "A general must be a discerner of men. He must look into the hearts of his soldiers, in order to be able to perceive rightly, at each moment, what he can acquire of them." The division officer should know every man under his command by name, surely, for nothing lowers a man's self-respect quite so much as to be called "say you," to be made to feel that he is just one of a lot, that he sunk his individuality when he donned his first suit of work whites. More than this even, the real "discerner of men" will know, in a general way at least, where the man's home is and something of his early environment. In a country as large as ours sectional peculiarities, many of them decades old, are very pronounced, and if the leader would know at each moment what he can acquire of his men a knowledge of what a man's ancestors or associates did under similar circumstances and what characteristics have been handed down to him by years of physical proximity will prove invaluable in forming the estimate.

The second essential of military character is loyalty. Being loyal one's self and having the power to instil loyalty in others is a necessity for the leader. Criticism of superiors or the orders of higher authority breeds disloyalty, and it is only too often that young officers forget this and discuss these matters in the hearing of their men. Many are intensely loyal in obeying orders which meet with their approval but either actually disloyal or passively so through indifference in carrying out instructions which do not appeal to them. Initiative is another matter, and should be encouraged, but initiative does not bestow the prerogative of ques-

tioning an order, once it has been given. Rather, initiative consists of accomplishing to the fullest extent not only what the letter but the spirit of the order dictates. Only by sincere and complete loyalty can that quality be ingrained in others. As one authority expresses it :

Leaders may look without hesitation to their subordinates for true loyalty to their plans when they have shown by example that they themselves are loyal and capable.

Energy, earnestness, thoroughness, and perseverance are four qualities which, if not inherent, must be cultivated. Unless an officer, and especially a division officer who is much in the sight of his men, attacks his work with energy and earnestness and sticks to it until it is finished in a thorough manner he can look for nothing better than a lackadaisical and slovenly performance of duty on the part of his men.

Too much stress cannot be placed on the item of self-control. No man can expect to control others and bend them to his will unless that will is invincible, unless he is master of himself. An order shouted and embellished with profanity will gain less quick obedience than one delivered in a clean, clear-cut manner, just loud enough to insure its reaching the ears of all who should hear it. The officer who loses his temper will either provide amusement for his subordinates or earn their resentment under ordinary circumstances and in a real crisis will not find the faith and confidence so necessary to success.

Courage, both physical and moral, is indispensable to the man who would be a successful leader. There is perhaps no other quality so much admired in one man by another as sheer physical courage. Even in the face of this, however, courage must be distinguished from foolhardiness. The brave man does not needlessly take long chances for the sole purpose of displaying his courage. Under ordinary conditions on board ship an officer has ample opportunity to demonstrate whether or not he can remain cool and self-possessed in an emergency, and the officer who can do that without ostentation will find that his men have a quiet but all-abiding trust in him when real danger impends. Moral courage is of a higher order than physical courage, and more difficult to obtain and maintain. Yet its recognition is just as prompt and its response more enduring. Under the heading of moral courage is properly classified readiness to bear responsibility. Of this so-

called courage of responsibility, Von der Goltz says: "It is . . . . strength of mind in high development, schooled to endure the severest trials without swerving from the end in view." It fosters initiative in subordinate leaders and loyalty of the highest order in all who follow.

Last and most important, no one may aspire to leadership who has not the "common" attributes of a gentleman—courtesy, justice, mercy, and a high sense of personal honor. These are all elements of good character in general and form the basis of military character as well. For it follows that unless a leader be courteous he will meet with a surly response; unless he be just and at the same time temper justice with mercy he will not be entitled to and will not receive a "square deal" when his own success depends upon it; and finally, unless his own personal honor is above reproach he can never attain frankness and truthfulness in his relations with others, without which success is and can be only ephemeral.

#### LEADING THE INDIVIDUAL

Having laid the foundation of leadership in military character, the leader must next direct his energies toward fashioning the component parts of the organization he is to build and control when completed.

No more simple and direct statement of the official relation which should govern between officer and enlisted man can be found than in this brief sentence from the pen of Theodore Roosevelt: "We should guarantee to every man his full rights, and we should exact from every man the full performance of his duty."

In a recent order issued from headquarters of the U. S. Marine Corps, Major General Commandant Lejeune characterizes the ideal relation between officers and enlisted men as comparable to that of teacher to scholar and father to son. In connection with this two late orders from Admiral Wilson, commanding the Atlantic fleet, merit careful attention, one regarding absenteeism in the navy and the other requiring division officers to be present at mast when men from their divisions are on report. In addition to the general knowledge of his duties which an officer should impart to his men in the rôle of teacher is instruction in the dishonor attached to absence over and without leave, a conspicuous phase of dis-

loyalty. One writer scores official personnel on the grounds that while all officers deplore desertion few, if any, ever do anything to prevent it. Many a good man has been lost to the service when a little advance understanding and sympathy might have saved him. Requiring division officers to be present at mast is an amplification of the father to son relationship. There are many arguments for and against an offender that do not appear on his enlistment record, and unless the division officer is on hand with the facts concerning each individual the commanding officer is unquestionably handicapped in dealing out the impartial and withal merciful justice so essential to discipline and to a real understanding between the offender and the authority he has sinned against.

Certain it is that the average enlisted man responds more readily to the mutual square deal than to any other angle of approach. There is something ingrained in every American youth that makes him passionately fond of the spirit of fair play. He doesn't want to be coddled and scoffs at favoritism. But guarantee to him his full rights, share his hardships, commend his efforts to better himself and increase his value to ship and service, deal justly, firmly, impartially, and yet mercifully with his misdeeds; in short, open to him the gates of comradeship based on common loyalty to a common cause—do these things and you have won his respect for you, placed his own self-respect on a pedestal to which he must ever look up, and planted the seeds of a devotion to duty that will make *exaction* of the full performance of that duty unnecessary. He will "deliver the goods" cheerfully and unflinchingly in the face of any adversity.

#### LEADING THE DIVISION

As the strength of the service is the ship, so the strength of the ship is the division. A young officer taking charge of a division composed of green men (as it is almost certain to be in these days of depleted personnel) is confronted with one of the severest trials of his naval career. He must attack his problem carefully and thoughtfully, gradually developing an organization possessing the spirit and knowledge that will make it appreciate its share in making its ship the best in the fleet and its fleet the best in the world.

If the analogy between leadership and building is still followed it is immediately evident that the petty officers form the framework which gives strength and stability to the organization, and to

them the division officer must devote his first and most earnest efforts. Having decided of what leadership consists, he must strive just as diligently to make his petty officers in a true sense leaders of their sections as he does to make himself their leader. He should foster the spirit of initiative and willingness to assume responsibilities in them, and make them in all things the connecting link between the command and its final execution.

“Every group of men working together soon comes to have a soul of its own.” The leader who learns to know that spirit has acquired a grip that is invaluable. Having once learned it, he has three means of bending it to his own will in the accomplishment of ordained ends; namely, pride, competition, and faith. Appeal to the pride of an organization, its pride in its good name and its past achievement, and its ensuing endeavor to sustain that pride will prove relentless. Competition is but a species of pride, a pride that is injured when its owner is forced to admit inferiority. The desire to excel is inherent in every individual; no less is it true in any organization. The officer who can intelligently direct this spirit of competition, in athletics, in drill, in all things seamanlike, has a lever at his disposal of incalculable advantage. Finally, let an officer convince his division that he has unbounded faith and confidence in its ability and willingness and it will work long hours under the most trying circumstances to justify that trust. In the face of perfect belief in it on the part of its leader no organization can fail to give a good account of itself.

#### ACQUIRING LEADERSHIP

To acquire leadership the aspirant must first recognize his problem and face it. By introspection he should make a frank inventory of his qualifications and make every effort to develop those he possesses and to win for himself those he does not. Much can be learned from a study of the lives and characters of famous military and naval leaders, Alexander, Cæsar, Napoleon, Nelson, Farragut, Dewey, and adapting such of their methods as are applicable to present day conditions. More still can be learned by observing superiors who, under conditions more similar to those which now confront us, have established their right to be acknowledged as successful leaders.

To conclude, no officer can set himself a higher or yet more workable standard of leadership than that of the officer who be-

queathed to the United States Navy its greatest legacy of leadership, a standard so perfect that it has been placed on every fitness report as an inspiration to and a measure of attainment. It is embodied in these words of John Paul Jones :

It is by no means enough that an officer in the navy should be a capable mariner. He must be that, of course, but also a great deal more. He should be, as well, a gentleman of liberal education, refined manner, punctilious courtesy, and the nicest sense of personal honor. . . . He should be the soul of tact, patience, justice, firmness, and charity. No meritorious act of a subordinate should escape his attention or be left to pass without its reward, if even the reward be only one word of approval. Conversely, he should not be blind to a single fault in any subordinate, though, at the same time, he should be quick and unfailing to distinguish error from malice, thoughtlessness from incompetency, and well-meant shortcoming from heedless or stupid blunder. As he should be universal and impartial in his rewards and approval of merit, so should he be judicial and unbending in his punishment or reproof of misconduct.





[COPYRIGHTED]

U. S. NAVAL INSTITUTE, ANNAPOLIS, MD.

---

AN INTERNATIONAL OUTLOOK

By REAR ADMIRAL H. S. KNAPP, U. S. Navy

---

The charge may fairly be laid at the door of the people of the United States as a whole that they know little about, and care less for, affairs outside their own country unless they themselves be directly affected. The reasons for this unfortunate indifference, for it is unfortunate, are not difficult to discover. They derive partly from tradition and partly from the conditions and situation of the country in the world. As a young nation, sparsely settled over a long stretch of coast, weak in the face of strong European nations, beginning the national life at a time when weak peoples were the prey of the strong, when the world was full of war and only beginning to admit the right of national groups to a separate national existence, it was natural and proper that the United States should be wary of foreign entanglements and very much on its guard against the suspected or real designs of foreign nations. Nor was the world in that day so interdependent as it is now. Life was then more simple; human needs were simpler; while commerce existed, home production sufficed for most necessities in the United States; the country was practically self-sufficient. This self-sufficiency is to-day more nearly our good fortune than that of any other nation, due to our great extent of territory and diversity of climate and resources; but even we are not self-sufficient. To mention only one important raw material, we do not produce rubber; and how long could we get on without rubber? During the war we found other and very vital needs outside of our own resources.

During the years of our separate national existence the conditions of life of civilized peoples have changed more than during any similar period of the world's history. The steam engine has revolutionized communications and transportation. Of equal or

even greater importance, the steam engine has made possible the great manufacturing establishments that mark the industrial age in which we live. In the more highly civilized nations the trend is distinctly away from agricultural and rural life toward industrial and urban life, and such a change can not fail to modify greatly the characteristics of peoples and the aims of governments. Again, in 1776 verbal communication with persons at a distance was by letter, and letters went over seas by sailing vessels or by slow animal transport over land. Now we have the telegraph and the radio, and it is within immediate possibilities that we may have telephone communication as a regular thing over thousands of miles of land and sea. In verbal communication New York is nearer to-day to Shanghai or Constantinople than it was to Philadelphia during our early days. We are on the eve of regular communication through the air. The whole world—certainly the whole civilized world—is more closely knit together now in the exchange of commodities and information than Georgia and Maine were after the Revolution.

The position and influence of the United States in the world have changed no less remarkably than have the conditions of life of civilized peoples. Our population has increased many fold until now there are only two self-governing countries whose population is greater. Our continental territory is settled from the Atlantic to the Pacific, whereas our independence was achieved at a time when only the Atlantic fringe east of the Alleghenies was settled. Our form of government, never before tried upon so great a scale and regarded with any but friendly sentiments by the monarchical governments of Europe existing when it was inaugurated, long ago passed the experimental stage and justified itself; it has withstood the shocks of time from without and within, and now it is firmly established and held in high respect by the rest of the world. Outside of our solid continental territory we have acquired Alaska, the Hawaiian Islands, Tutuila, Guam, the Philippines, Porto Rico and the Virgin Islands, and have built the Panama Canal and guaranteed the independence of Panama, while with Cuba we have peculiarly close relations that involve both rights and obligations. These external possessions and interests are liabilities from the viewpoint of national defense, and in any event

it is plain that they bring with them additional points of contact with the rest of the world.

These trite facts are instanced to show that a habit of thought that fitted our early conditions is not applicable to the circumstances of our present national life. Young ladies planning for a ball do not plan their costumes on the romper styles of their mud-pie days. Yet I believe that it is a melancholy fact that great numbers of the American people are in the romper stage of thought regarding our place in the world. They live on tradition instead of intelligent appreciation of modern conditions; on catchy phrases adapted to the conditions of our national infancy instead of on the realities of the present day. This was the general national attitude until the Spanish War; that brought to many people the realization that the United States was grown up and had a part to play in the world suitable for an adult nation. More have come to hold a similar belief by the Armageddon through which the world has just passed and the effects of which will be felt by the children's children of the entire world. Many—very many—have not been touched. They believe in isolation as a policy, and believe (or profess to believe) that such a policy is a possibility. They see no responsibility towards other peoples except to sign a check when some "drive" appeals to them. They are apparently afraid that the United States may be "done" if she goes out into the society of the world.

This attitude is no doubt honestly held, even by some who are well informed about conditions outside of the United States and of our points of contact with foreign nations. It is my belief, however, that the great reason for any large mass of opinion in this sense is a lack of information of foreign affairs—or, worse, a lack of any interest in them—and a consequent failure to understand how we are affected. Much too small a proportion of our people have any real, well-founded appreciation of our present-day relationship with foreign nations: one based upon knowledge and not upon phrases uttered by men of great wisdom in our early days but not applicable now. This conviction has been growing with me for many years, and the statement in my opening sentence is one I believe fully justified. Compare the items of foreign news in our press and periodical literature with similar items in the corresponding publications abroad. A writer on the position of foreign

securities in the American market in the March (1920) *Annals of the American Academy of Political and Social Science* says:

For this (the familiarity of American investors with foreign investments) it will be necessary to have the newspapers and other publications of this country give a great deal more space and attention to foreign conditions than they have heretofore. One of the results of the Great War has been to arouse the interest of the American people in the doings of other lands and to increase their fund of information regarding various foreign governments and the conditions prevailing in other countries.

The March number of the *Annals* is a symposium on Bonds and the Bond Market, and the quoted words did not fall under my eye until this paper had been drafted in the rough. The observations of the writer from a rather restricted viewpoint are what I would stress here from the general and political viewpoint. It has long been in my mind that, while the nation is grown up in size and power, it has not grown up in its knowledge of the rest of the world, nor in an appreciation of its relation to the rest of the world—the political relation that it ought to occupy.

What has all this to do with naval officers? Everything. The navy is the military instrumentality of the government that is always in touch with foreigners. Not infrequently officers have to act in matters abroad without opportunity to seek instructions from the government at home. If it is too much to say that naval officers are responsible for naval policy, it is not too much to say that they are responsible for expert advice upon naval policy. Naval policy depends upon national policy, and national policy necessarily must take cognizance of external relations. If it is to be formulated as befits our place in the world it must be founded upon broader than parochial considerations. From every point of view it is the duty of naval officers to be well informed about foreign nations, and the broader that information and the opinion founded upon it the better able to serve their country in their chosen profession they will be. It is a source of satisfaction that the officers of the navy saw from the first the practical certainty that the United States would be drawn into the recent war if it proved to be at all prolonged. For a time their voice was as that of one "crying in the wilderness"; their justification came in due course. Had their views been accepted the reproach of unpreparedness might have been spared to the country in large measure.

I have been moved to write this paper, not because I feel that the navy as a class has failed in the past to study and understand our foreign relations, but to urge upon all to go on to a greater proficiency in this particular. As a class naval officers should yield to none in an international outlook that is broad and understanding. No officer can come to high command fully prepared for any contingency of service who does not have an intelligent conception of at least the great questions involving the relations of the United States with foreign nations. Naturally and properly the principal interest of the younger officers is in the material of the navy and the training of the personnel ; but no officer is too young or too much occupied with his immediate duties to form the habit of knowing what is going on abroad and how it affects us, and of reaching his own intelligent conclusions about our foreign policy in the past and what it should be under the conditions of to-day.



[COPYRIGHTED]

U. S. NAVAL INSTITUTE, ANNAPOLIS, MD.

---

EUROPE SINCE THE ARMISTICE

A CONDENSED REVIEW OF THE POLITICAL AND MILITARY  
MOVEMENTS ABROAD

By LIEUT. COMMANDER J. M. CREIGHTON, U. S. Navy

---

Except for the period just following the downfall of Napoleon, there has been never so complete an alteration of the maps of the world, such a crashing of kingdoms, such a delivery to new commonwealths of the lands of the old, and such a partition among the victors of the wealth of the vanquished as is now in progress in the capitals of Europe. As the end of the Napoleonic wars left the Republican ideas of the French to disturb the permanence of the adjustments of the Congress of Vienna, so the downfall of the Central Empire leaves in the air those upsetting ideas of "Racial Equality," "the Rights of Minorities," and "the Rights of Small Nations,"

The details of readjustments of lands abroad have filled the press daily for nearly two years, and, unless they have been closely followed, a recount of them would be confusing and uninteresting. The endeavor has been made in this review to present the situation in a very general fashion, with no great pains taken in the matter of the precise dates involved, nor the record of many events which, while apparently of moment at the time of their occurrence, proved to be only manifestations of a general development which made its appearance later on.

Whether the agreements arrived at after so many months of inquiry, honest investigation, misrepresentation, bickering, parleys and displays of force will endure is yet to be seen, and a review of the possibilities of disturbance leaves much to be desired in the way of confidence in the stability of all the balanced structures erected at Paris. Russia has yet to be accounted for; the little nations in Central Europe have still to learn their business



of government and settle down; Germany is bound to recover a great measure of her strength, and the questions involving Turkey and all the Mohammedan countries of the east furnish problems as great as they did before 1914.

#### GREAT BRITAIN

The armistice was declared on November 11, 1918, and on December 3 the first British troops entered Germany. There followed the normal after-war situation; the occupation of the enemy's territory, the release and return home for demobilization of great portions of the armed forces, and the discussion between the victors of what should be the items of the peace.

As has always happened, the disturbances in peoples' lives caused by a great war made the normally-satisfied populations harbor new and disturbing ideas. In the spring of 1919 the first news of widespread outbreaks in Ireland and Egypt, and of unrest in India began to appear in the press. In England, the war's most distinct political aftermath was the rise to power of the labor party.

On March 14 and 15, 1919, there were extensive riots in Egypt, where the Committee of Union and Progress, whose active members had been expelled from Constantinople when the Allies took that city, had been busy in fostering anti-British ideas. Indian, Egyptian and British soldiers were killed in the streets. The police and the army and the native officials remained loyal, and though there was severe fighting in some places the agitation was finally suppressed. In seeking the source of the trouble we find that at the outbreak of the war, the Egyptians were alarmed at England's declaration that her normal supervision of the country had ceased, and that she henceforth would regard Egypt as a distinct British protectorate. The Egyptian idea of independence was not new, but the great garrisons kept there during the war had prevented there being any possibility of a success for it while the conflict was on.

At the peace conference the Egyptian delegates were especially active in endeavoring to obtain a hearing before the Council, but they were prevented from doing so. Upon the continued agitation of the native leaders in Egypt, the English seized them and interned them in Malta. This led to fresh riots in the valley of the Nile, and the arguments of the Egyptians were strengthened by the news

that Syria and Palestine, which had made comparatively slight efforts to obtain their freedom, had been granted a sort of autonomy by the French and British respectively. General Allanby, the conquerer of the Holy Land, was sent from Jerusalem to take charge of the situation in Egypt, while a special commission headed by Lord Milner came out from England to investigate and to make recommendations to the Crown. Upon the return of Lord Milner to England it was rumored that a modified independence was to be given to Egypt, and in August of 1920 England made it known that she intended to adopt in that country a condition of affairs very much like the one the United States established in Cuba. The British are to hold a district on each side of Suez Canal and will garrison it as we do our own district at Panama; the British officials in Egypt will be practically eliminated in the details of local administration, but no treaties are to be made, and no engagements with any foreign interests are to be entered into, without British approval.

In this yielding before the necessities of the situation, the British, while apparently retreating, are yet holding fast to the original idea which caused them to take charge of that portion of the world; that is, to hold in their hands all the steps on the road between England, India and the East. It is apparent that if the Suez district were in the hands of an enemy, or of anyone they should be unable to control, the British hold upon India and affairs in the Orient would cease, and it is to be expected that they will resolutely refuse to compromise their holdings here or in Aden, or at any of the other points where their guarding of the trade routes might be in danger.

In India there has been no such complete lessening of the British authority, but the normal preludes of change have appeared in severe riots, culminating in what has come to be known as the "Massacre of Amritsar," where General Dyer fired upon a large crowd of natives who had assembled contrary to his orders and killed about six hundred of them. At the time it appeared that the effective reverence in which the British have been held in their great native provinces was about to be lost. British officers and men had been killed in the streets in both Egypt and India, and in Amritsar the culmination of the disrespect of the natives came when an English woman was pursued through the streets by a native mob, thrown from her bicycle, and injured. The situation has been described as being similar to that which preceded the

great massacre of the whites in the days of the Sepoy Mutiny, and General Dyer proceeded to firmly suppress all signs of disturbance. He was later called to England and had a severe time of it defending himself for his actions in this emergency.

In the Pathan lands to the north and west of the peninsula there has been severe and persistent fighting for two years, and this is still in progress. In Persia and Afghanistan the British influence has been upset by the Bolsheviks, operating from their propaganda base for the east at Tashkend. A great deal of submerged political conflict had its evidence in the murder of the Emir of Afghanistan and of his being followed by another prince more favorable to the British. There was announced, shortly after the war, a British treaty with Persia which practically gave to them the entire supervision of the country. This has been more or less compromised by the landing of the Bolsheviks at Enzeli on the Caspian Sea and of their penetration south from that point.

Farther to the west the English have taken over the mandate for Mesopotamia, established their headquarters at Bagdad, and assumed control of the rich oil region at Mosul.

It has been necessary to maintain a very large British army in this district ever since the armistice. The fighting of the natives for independence has been no less active here than in the French district of Syria or farther north around the Greek port of Smyrna. The British line from Basra, the entry port at the mouth of the Euphrates river, to Bagdad has been repeatedly cut, and in response to objections in the Parliament to the expenses of the campaign the British have decided to abandon the country, except for a small district around the mouth of the river called the Vilayet of Basra. However they have created in their rear the "Kingdom of Irak," which is the name given to the district about Bagdad, and have given the kingship to a native chief loyal to them, named Emir Abdullah.

The entire situation in the Near East is extremely complicated, and if you will take the map which accompanies this article in your hand, and patiently endeavor to find all the strange names on it, I shall try to make clear the different spheres which the various powers have taken in the lands of the old Turkish Empire, and what has been happening there since the war ended.

Following up the British zones of supervision, you will see on the border of the Red Sea the Kingdom of Hadjez. The erection of



THE SPHERES OF CONTROL OF THE POWERS IN ASIA-MINOR.

this kingdom under King Hussain, a prince friendly to the British, and the father of Abdullah of Irak, was the counter to the Turkish declaration of a holy war. Mecca, the Mohammedan holy city, lies within it, and in securing the adhesion of King Hussain the British promised him, that if the war was successful for them, the Arab state should extend well into the north and include the country about Damascus.

To the northward, along the western side of Arabia, we come to the British district of the Canal and Palestine, and then, at Akka, advance into the French district of Syria, including the ports of Alexandretta and Beirut.

Adjoining the French district on the north is a district allotted to Italy, centering about Konia, and containing the coal fields of Heraclea. Then comes a stretch of coast line to which none of the Europeans has laid definite claim. The Greek district comes next, centered at Smyrna and including a number of islands off the coast.

The Supreme Council created the Zone of the Straits, administered by an allied commission on which England, France, Italy and Greece are represented, and which controls Constantinople, the Sea of Marmora, the Straits and the islands lying off its mouth.

These districts were apportioned to the various countries at the conference of San Remo in April, 1920, and the subjugation of the country was left to the nations concerned. In Palestine the British, with their usual success in dealing with native people, have so far managed to operate with very little apparent trouble. To the north of them the French have declared the independence of the district of Lebanon, which, ever since France defended the inhabitants from massacre at the hands of the Turks in 1864, has been a district loyal to her. Elsewhere, when they have attempted to extend their authority they have been met by both the opposition of the Arabs, led by Emir Feisal, another son of King Hussain of Hadjez, and that of the Turks, under Mustapha Kemel Pasha. The French armed the native Armenians, who have plenty of reason to fight the Turks, and very severe massacres of these people have marked the progress of the occupation of this district of Asia-Minor.

Emir Feisal had his headquarters at Damascus. The French proclaimed that they wished the native population to choose their own leader for the local government, and on March 8, 1920, they

did so, and Emir Feisal was elected King of Greater Syria by the Pan-Syrian Congress at Damascus. He immediately declared the independence of Syria and invited the French and English to leave the country. In the conflict which followed, the French under General Gauraud occupied Damascus, killed Feisal's Minister of War, and expelled Feisal from the country. At present the French are holding the district but fighting almost constantly on the outskirts, and planning to vacate Cilicia in an endeavor to placate the Turks under Kemel Pasha.

In the conference at San Remo in April, 1920, the decision was reached between France and Great Britain to prosecute the war against the Turkish Nationalists, and as they were both too occupied elsewhere to undertake the necessary operations, they granted the request of the Greek Premier, Venizelos, to be allowed to undertake the work with the Greek army. In addition to the district about Smyrna, Greece was also given all of Thrace up to the Tchataldja lines, just outside Constantinople, where the Balkan armies were stopped in the war of 1912. She promptly landed two large armies, one in Thrace and one in Smyrna, and both started east. The investment of Thrace was carried out with very little trouble, the Greeks defeating the Turkish-Bulgarian force at Adrianople and capturing the leader. East of Smyrna there was heavy fighting. The British assisted by bombarding the Turkish fortifications along the south shores of the Sea of Marmora, and especially at Ismid, where the battleships were reported to have killed a thousand Turks in their shelling of the trenches. To assist the Greek army east of Smyrna another Greek force came south from the Sea of Marmora, and later on a third army started from Ineboli on the Black Sea for the Nationalist capital at Angora. The fighting everywhere went against the Turks, who retreated farther into the interior. For a long time the news of the Greek army became scarce in the papers, and it was only in November of last year that the disintegration of the Greek morale resulting from the contest at home between the followers of Venizelos and ex-King Constantine became known.

As the result of the Turkish Peace Treaty (the Treaty of Sèvres), signed August 10, 1920, Greece has been greatly enlarged, but England and France have kept control of the Dardanelles and

the islands off its mouth by creating the "Zone of the Straits," administered by an allied commission.

As this is written (March, 1921), the premiers of England, France and Italy are in conference in London, in an endeavor to



THE NEW SITUATION AT THE DARDANELLES.

change the Turkish treaty to make it more agreeable to those nations who participate in its provisions. In the modifications which are forecast, it is expected that Greece will suffer a reduction of the territory which was given to her premier, Venizelos, at San Remo last year, and that the Turks will correspondingly gain in the alterations to the treaty.

## FRANCE

The domestic history of France has been strangely at contrast with that of her neighbors in that it has been almost free from internal dissension. Within six months after the war there were several serious disturbances of labor, but they were very firmly handled and no serious results occurred. When the Third Internationale met at Moscow there was a determined effort on the part of the radicals of the French labor parties to secure a public declaration of their adherence to the Moscow meeting, but the moderate elements in the French conference were in the majority. France has had no local disturbances in any way as diverting as those of England, Germany, or Italy, and her peace at home has allowed her to take a prominent part in all the important operations outside her boundaries, and these have brought her a great prestige on the continent.

In the settlements of the details of the peace treaty she has, for several reasons, been forced to fight against the opposition of England and Italy, while assisted in a slight measure by Belgium. France and her little neighbor on her north have been driven into a mutual foreign policy of determining that the Germans shall remain weak now that their desperate defence is over, and they have signed an armed agreement to assist each other in case either is attacked again.

There have been various meetings of the premiers of Italy, France and England to determine upon the details of the carrying out of the treaty of Versailles, and both sides have been forced to make concessions. The French point of view was vigorously and determinedly defended by Premier Millerand, now the president. At one time it appeared that the Germans were planning to break the agreement concerning the number of troops to be placed in the neutral zones along the Rhine and, failing to secure the English cooperation, the French resolutely went ahead without them and occupied Frankfort, Darmstadt and Hanau, on April 6, 1919. The troops stayed in these important cities until the Germans withdrew all excess troops from the district and then, on May 17, marched out. This strong and determined action on the part of the French markedly enhanced their position in all subsequent operations of European politics, but their great success was yet to come in their assistance to Poland on the east, when they held her together in her hours of danger from the Red armies of Russia.



In the old days before the war, an alliance with Russia was the normal means of weakening Germany by strengthening the power to the east of her, and now, with Russia down and Poland up, the French are determined to strengthen and stabilize the latter.

The great mineral wealth of Germany lay in the deposits of potash, coal and iron in Alsace-Lorraine, and other deposits of coal and iron, no less important than the first, in upper Silesia. The first of course, has gone to France, and the second is to go either to Poland or to Germany according to the result of the plebiscite to be held there. Both French and British troops were sent into the district to supervise the election, but a great many of the English officers have resigned, and it is generally conceded that the situation lies in the hands of the French. The district is one of the richest in Europe and the Germans are desperate to keep it; to weaken them, and to assist the Poles, the French are just as determined that they shall not have it, and the elections, already twice delayed, are expected to take place in April.

Taking advantage of Bolshevik weakness in the Spring of 1920, the Poles made an alliance with the Ukranian opponents of the Reds in South Russia, and in April started east with them in a wide sweep of conquest. In early May they took the important city of Kiev and started south for Odessa. For a few days the news from the front was indefinite, and then came report after report of Polish defeats as the Reds took advantage of their thinned-out defenses in the north, broke through them and drove straight for Warsaw. There followed three weeks of headlong retreat and equally rapid advance, with stories of armies wiped out and great areas overrun and ruined. Just as the world was prepared for the news of the downfall of the Polish capital, a remarkable rally of the defenders occurred, coincidentally with the arrival of fresh Polish troops from the south (and of a French military mission under command of General Weygand, Foch's chief of staff). There resulted an almost miraculous saving of Warsaw, and an overwhelming defeat of the Russians, with the capture of about a hundred thousand prisoners. The Poles promptly took up the pursuit and drove the Russians before them some three hundred miles to the points which they occupy at present. These are the same lines at which the Germans stopped after their victories over the Russians in the

world's war, and represent the only feasible line of defence for Poland from the attack from the east.

The success of the Polish war has put France in her old place in political and military supremacy among all the nations on the continent, and in the Polish victory she has not only saved her own ideas of having a strong friend to the east of Germany, but has

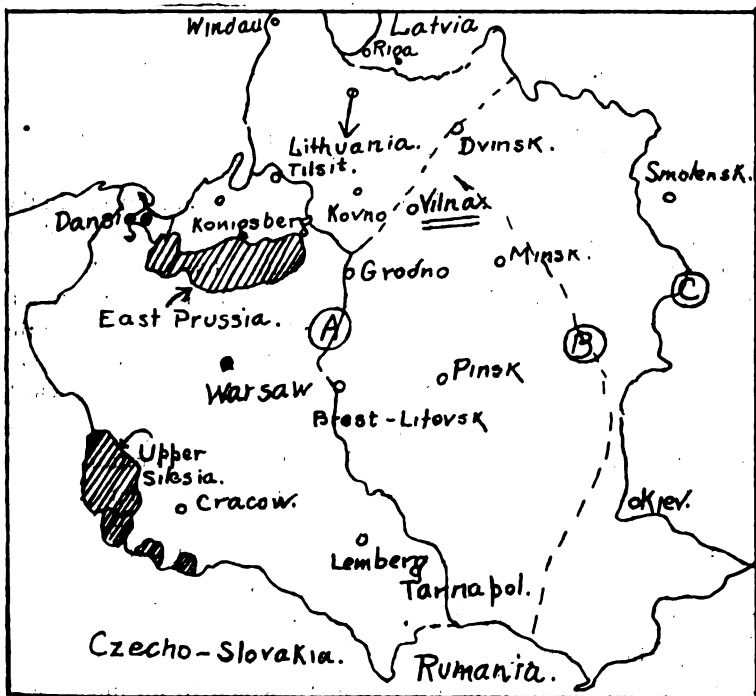

■ Plebescite areas.

A Boundaries fixed by the Supreme Council at Paris.

B The Russo-Polish battle line in June, 1920, before the Reds drove in and nearly captured Warsaw.

C Poland's boundaries before the partition of 1772. Vilna, the seat of the Polish-Lithuanian trouble, is shown underlined.

practically saved Europe from what might easily have been an overwhelming flood of the Soviet idea. The radical elements of Germany were only awaiting the arrival of the Russians in East Prussia to join with them, and as Germany had nothing but desperation ahead in carrying out the present treaty, and at least a distinct chance of relief if they joined with victorious Russians,

this upsetting of Germany and Hungary, and perhaps disturbed Italy on the side, might have gone ahead in the flood of success if Warsaw had gone down. The French interests in Asia-Minor have already been mentioned, and she now occupies, with England, that intimate Inner Chamber where most of the affairs of Europe are being discussed and decided.

#### ITALY

The Italian situation has been a confused jumble ever since the end of the war. Italy lost a great many men and spent a great deal of money in her campaigns, and in addition to having very few vivifying successes to cheer her on, she has felt that she was very badly treated, both at the peace conference and since. In the north, however, she has finally acquired all that it was possible to give her. Her old cry of "Italia Irredenta" has now little basis in fact. The end of the Austrian wars in the 19th century left most of the commanding positions and the mountain passes in the hands of her enemies, and her efforts in this war were hampered in every way by fighting against the tremendous obstacles which the old Austrian generals planned for her when they framed the peace treaties. Now Italy occupies all these mountain passes herself, and controls all the strategic paths into her country, including the whole district of South Tyrol, where some five hundred thousand German-Austrians are brought under their authority. By the treaty of Rapallo, signed with the Jugo-Slavs in November of 1920, the Italian territory is carried around the north of the Adriatic, almost touching the free city of Fiume, and including the islands lying off that port, which to all intents and purposes control its operation. There is very little endeavor made to conceal the fact that the declaration of the status of Fiume as a free city is only a step on its way to becoming actual Italian territory. The original Italian demand was for the whole Dalmatian coast, but after negotiations extending over a year, and a number of small local fights between the Italians and the Jugo-Slavs, including the spectacular performances of d'Annunzio, they have apparently arrived at a satisfactory agreement with their eastern neighbors.

By the provisions of the Treaty of Rapallo, Fiume was given the status of an independent state, whose territory joined that of

Italy on the west. The islands of Cherso, Unie and Lussin go to Italy, as well as the detached city of Zara and the southern islands of Lissa and Lacosta. Mount Nevoso is a commanding elevation



THE SETTLEMENT OF FIUME.

o o o o The "Wilson Line."

----- The line agreed upon between Italy and the Jugo-Slavs at Rapallo, November 10, 1920.

in this region, and that too is in Italy's territory. About 500,000 Serbs are included in these new Italian lands.

Italy has been hampered in her foreign policy by a most dangerous lack of stability at home. There have been repeated strikes, with railroads stopped and factories shut up; with martial law,

soviets set up in the cities, and great manufacturing districts forcibly taken over by the workers. In the elections in the autumn of 1919 the radical socialists had a great increase in strength and captured nearly one-third of the seats in the Chamber of Deputies. It was rumored that the king would fail to address the deputies because of the socialists' threats to upset the chamber if he appeared, but he made his address in spite of them on December 1. The chamber was not disrupted, but the objecting deputies refused to take the customary oath of allegiance to the crown, and left the chamber in a body.

The socialist effort has always been distinctly against sending the army abroad to assist in further expansion, and Italy's efforts outside her own country have not been as successful as her participation in the war might have warranted. She secured her title to a number of small islands in the Aegean and to a small district in Asia-Minor near Adalia, but in Albania her occupying forces were driven out of the country at all points excepting at Avlona, where the warships sustained them, and in Lybia, in northern Africa, a number of Italian officers were captured by the native chiefs and held for ransom. However, she was allowed to extend her boundaries in her province in Eastern Africa across from Aden, called Eritria, and will no doubt receive some distinct benefits in Asia Minor if the British and French withdraw their support from the Greeks.

#### GERMANY

In reviewing the condition of this country it is necessary to realize the density of the population. The number of people per square mile in Germany is about ten times as great as that in the United States, and it is throughout its whole area almost as thickly settled as New Jersey. This brings out the necessity for her intense cultivation of the land and the development of manufactures in order to support such a large population, and her consequent demand for raw materials with which to feed the factories.

Though the actual territorial losses (and the ones which will result if all the plebiscites go against Germany) amount to only 14 per cent of her area, this land includes over 20 per cent of her former agricultural region and practically half of her coal and iron. Before the war the Germans produced twice as much iron and steel as did Great Britain, and they also imported a great deal of ore from Sweden, Spain and Algeria. Of her great fields,

80 per cent of the iron ore lay in Lorraine, and the 20 per cent left to her is of inferior quality and distributed in small beds.

Coal has always been the heart of business. In all the wars of the past, excepting those of a religious character, it is generally to be found that under the covering of high-minded utterances some iron and coal fields were the center of the disturbance, and in the future we may expect the same, with the added pursuit of late years furnished by the need of oil. Germany had by far the largest coal beds in Europe. She used to mine every year 55 per cent of all the coal that was produced in that continent; twice as much as Great Britain, and twice as much as all the rest of Europe, minus Great Britain, combined.

The German coal lay in three fields. Of these, two were in the Sarre region and in Upper Silesia. Together they comprised just half her supply. The first of these is to be exploited by the French for fifteen years to repay them for the German destruction of their big mines at Lens during the war, and at the end of that time a vote shall be taken to decide whether or not the Germans will regain control. Whether Germany or Poland will get the iron and coal and the manufacturing cities of Upper Silesia is to be determined by the plebiscite there, and French, British and Italian troops are supervising the election. Even if Germany loses both of these districts she will still have more coal than Great Britain, and is besides in possession of rich fields of lignite, a brown coal of low calorific value, but converted by dry pressure into an excellent fuel. Germany formerly produced 100,000,000 tons of this annually.

In potash this country used to have a world monopoly, but this is now gone—the potash fields were in Alsace-Lorraine. It is to be remembered that manufacturing districts stay close to coal and iron, and with the loss of her great fields have gone the cities and factories which used to live by them.

During the war the expenses of the German government were piled up with the utmost extravagance. It was planned to have the Allies pay the cost of the war as France did, twice over, in 1870. After the armistice there was no let-down in the uncurbed dispersion of the country's money. The new government tried to please everybody, and pleasing everybody meant subsidizing them to ease the cost of their living. So the government's debts piled on the skies, the value of the mark went lower and lower, and the country went deeper and deeper into its troubles. With the coal and the

iron have gone her ships, and the great merchant fleets which six years ago were pushing the British hard for first place in the world are now completely obliterated. Her once fine railroad equipment has been cut to pieces by the delivery of hundreds of locomotives and thousands of cars to the French and Belgians, and the floating docks, and derricks, and barges, which were to assist her in rebuilding her merchant shipping, have been taken away to repay for the piece of work which made June 23, 1919, such a big day for salvage parties at Scapa Flow.

The republican government which brought a harness maker in to take the place of the departed Hohenzollern has weathered many desperate storms and is still in the saddle. In January, 1919, there were severe Spartacan, or radical, riots over the entire country and it appeared at times that the government would be overthrown. On the 15th of that month Rosa Luxemburg and Karl Liebknecht, the principal radical disturbers, were killed in a fight in the streets of Berlin. On February 6 the new government was established at Weimar, with Ebert as president.

During February and March the disorders continued, with idleness, no trains, and general food shortage helping things along. The coal production in the Ruhr district dropped to 10 per cent of normal, while the railroads were already operating but a small number of trains because of the lack of fuel.

In February, Bavaria broke out in revolt. An officer shot Kurt Eisner, the premier, and was in turn killed at once by a sailor. Munich was in a riot, the crowd searching for all opponents to the Soviet, and in the course of the operations Prince Joachim was arrested and ex-King Ludwig left during the night for Switzerland. The Soviet took control.

On March 3 a general strike was declared in Berlin. The Prussian government proclaimed a state of siege, and Noske came into power. During the night of March 3, 28,000 men under General Von Luttwitz entered Berlin. On March 5 there was fighting all over the city and its environs, and on the 8th the government troops had cleared the center of the area. On the 11th the Spartacans asked for an armistice, upon which the government forces cleared the suburb by attack.

On April 7, 1919, a Soviet was set up in Munich, Bavaria, and the central government openly defied. Then Saxony went down

with widespread strikes in all her industries. There was extreme violence in Dresden. Noske's troops finally attacked and took the city, and on May 2 the Soviet in Munich was also ended.

By August the internal conditions had settled down to a milder character, disturbed perhaps, instead of revolutionary. The government was unavoidably facing conditions which were bound to make it unpopular. It was very easy to blame everything unpleasant on the party in power and very unlike human beings to credit it with any effective or sincere effort. Tides of refugees from the areas given over to Poland began to pour into the district about Berlin with all the miserable Tales of the Dispossessed. The actual signing of the peace treaty was still to be met, and every item of it meant a fresh groan from the German people at home.

In late January of 1920 Berlin was again in the hands of a mob, and their disturbances culminated in an attack upon the Reichstag building. The police seem to have been very reluctant to fire on the crowd, but, having decided to do so, did the job with true German thoroughness and killed forty-two and wounded over a hundred in something less than a minute of firing. This ended the demonstration for that particular afternoon.

With the arrival of the official peace, Germany was filled with widespread despair. The shops were in the hands of Councils of Workmen. There was a paralyzing lack of any raw material from which goods were manufactured. The transportation was even worse than in the fall, and the production of that great essential, coal, had increasingly fallen down.

Up in the northwest part of Old Russia, a large German army of about fifty thousand men had been maintaining themselves in the region called Courland, ever since the armistice. They had persistently neglected to obey the summons of the Supreme Council at Paris to return inside their own borders, and the government at Berlin was forced to confess that they had repeatedly ordered them home but had no means of making them obey. They were finally driven back into Russia by the native Letts, backed by the French and English, and became the forces which in March, 1920, under General Kapp, attempted a restoration of the Monarchists. This revolt lasted three days. President Ebert left Berlin as the troops entered. That afternoon a general strike throughout Germany stopped all work in the country, and on the 16th of March General Kapp, unable to swing the people in behind him, marched his army out of the city.



On March 27 the Spartacan revolt in the rich district of the Ruhr broke out and the Reichwehr, the government army, advanced to crush it. There followed heavy fighting between the armed workmen and the government forces, and as the soldiers continued to pour in, the French called attention to the fact that only a definite number of German troops were allowed in this section by the peace treaty and that the number agreed upon was being exceeded. Upon the continued increase of the Reichwehr forces, France, driven by the fear that the Germans would break all the provisions of the treaty if they could establish a precedent by breaking this one, and unable to secure cooperation from any of her Allies, moved her troops into the Rhine cities of Frankfort, Darmstadt and Hanau. By the middle of April the Germans put down the disturbances in the Ruhr and withdrew the excess troops, and on the 17th of May the French moved out of these cities on the east bank of the Rhine.

In early June there was severe fighting between German civilians and the French troops in Upper Silesia, the latter being there to supervise the elections which were to decide whether this rich territory was to belong to Poland or Germany. The Poles moved heavy forces to the Silesian border and the French declared martial law in the district under their charge.

On July 5 the first conference at which the Germans were admitted to a discussion with the Allies opened at Spa, with representatives from England, France, Belgium, and Italy. Previous to this there had been a number of meetings between the premiers of the four allied countries to determine upon a common platform at Spa, and in spite of the vigorous efforts to have some of the terms of the treaty modified, the Germans got very little out of this conference to add to their comfort.

They had been repeatedly failing to carry out the provisions of the treaty relating to the reduction of their forces, the delivery of war material to the Allies and the monthly allotments of coal to France. It was due to the firm and relentless attitude of the French premier that the conference ended with a German agreement to go about immediately with the reduction of their troops, to guarantee a steady monthly delivery of two million tons of coal to France, and to proceed at once with a trial of those persons designated by the Allies as war criminals. On September 22, it was announced that the Germans had finished the delivery to the

Allies of two million tons of steamers and sailing craft, virtually all that was agreed to at Versailles.

Politically, the German effort may be taken as follows: It is to be assumed that her expansion and influence are entirely blanked off in the west. In the south, however, there are millions of Germans in old Austria whom she seeks to get under her colors, and one may expect her to maintain a steady effort to have these racially-allied people brought into her political sphere. Germany's best chance of alliance and expansion thus lies to the east, and this means that she will work day and night to pull down the newly-established and sorely-tried country of the Poles. In this she will be met by the assistance of the Russians, with whom it will be logical for Germany to join herself when the Soviet ideas have become sufficiently normal to relieve the Germans of the fear that their own government will be carried away by the alliance.

#### RUSSIA

On March 12, 1917, the revolution began, and the Czar abdicated on the 15th. An army of 12,000,000 men was then organized by the revolutionary leaders, and on July 8 Kerensky led it into Galicia. In a battle with the Germans, the way for the attack had been successfully opened by the artillery, but before going over with the infantry the war was held up while a plebiscite was taken in the trenches to determine whether or not the majority wished to advance. In the midst of this genial discussion the Germans attacked on their own hook and started a panic and retreat which was terminated only by the fact that the pursuers were unable to advance as far as the Russians retired.

The German agents in Petrograd now succeeded in undermining the authority of the Kerensky faction and formed in opposition to it the famous Red Guard, which finally proved the undoing of its creators.

On July 3, Kerensky repulsed the first attempt by the Guard to come into power, but his measures to prevent a repetition of the effort were too weak, and in October he was overthrown and fled to England.

The Germans were at this time in Helsingfors, Pskov and Kiev, and their faction, led by Lenine and Trotsky, now executed the treaty of Brest-Litovsk and thus released the German troops for operations on the western front. Count Mirbach (afterward assassinated) was sent to Moscow as the German representative,

and the great quantities of munitions, food, grain, explosives and coal which had been stored for the Russian armies, began to take the road west to Germany. Russia, deserted by her old allies, despoiled of her supplies, shorn of her strength, and in the grip of the Bolshevik reign of terror, passed into the darkness of the revolt.

From that day to this the intricate history of Russia is one long series of attempts by the old Czarist factions, assisted by England and France, to overthrow the power of the Bolshevik government in Russia. The Japanese also took an important part in this operation and extended their influence at various times as far west in Siberia as Lake Baikal. Probably the most romantic picture of the many campaigns is that of the Czech army, taken prisoners by the Russians during the war, arming themselves after the breakdown of Russia, taking charge of the Siberian railroad and advancing, fighting all the way, to Vladivostok, where American ships finally took them out and back to their old home country. Our own participation in Siberia was not extensive, and as the situation became tense there and the demand grew at home for the return of the soldiers, our troops were withdrawn.

The Soviet forces have defeated in succession the armies of Kolchak in Siberia, Judenitch in the northwest, Denekin (backed by French and Rumanian troops) in the district north of Odessa, and after him, the revived remnants of this former army under Baron Wrangel. In the spring of 1920 the Poles advanced deep into South Russia with their allies, the Ukrainians, and advanced as far as Kiev. They were driven clear back into Poland however, in May, and the capital was saved only by the timely arrival of French officers and munitions. Following this the Poles severely defeated the Russians and exacted from them armistice conditions which left their boundaries advanced to the lines formerly occupied by the Germans after their great defeats of the Russians in 1915.

At present the Bolsheviks are in undisturbed control of most of the territory formerly belonging to the old Russian Empire, excepting in Poland and Eastern Siberia. Their ideas are seriously threatening the lands of the English and the French in Asia-Minor, Mesopotamia, Persia and India, and it is expected that spring will witness a determined attack upon the Poles. Meanwhile there is a growing tendency, led by the English, to establish commercial relations with them, and it is not denied that this is a natural and logical prelude to their recognition.

[COPYRIGHTED]

U. S. NAVAL INSTITUTE, ANNAPOLIS, MD.

---

A LABOR SAVING AND MORE EFFICIENT METHOD  
OF DAILY ANALYSIS OF ENGINEERING  
PERFORMANCE

By LIEUT. COMMANDER W. L. MOORE, U. S. Navy

---

The need for some form of daily analysis of the performance of the engineering plant of a ship is well recognized, but the use of such an analysis is not so universal as it should be.

Among the reasons for this condition, the following three (3) may be counted as probably the most important :

(a) Lack of necessary data.

(b) Time and labor required to pick off the data from performance curves.

(c) Lack of understanding of the use and value of the analysis after the form given in the Rules for Engineering Performances.

Reasons (a) and (b) may be traced largely to the universal practice of presenting performance data in the form of curves.

It is true that much data can best be recorded in the form of curves and that curves are indispensable in many cases, yet practically all of the data needed by the operating engineer can be given in the form of the simple algebraic equations which are simpler and easier to use than the curves giving the same data. This is for somewhat the same reason that in many cases the azimuth tables are more convenient than Weir's Diagram.

The data needed to make an analysis is contained in the curves of total steam consumption per hour vs. H. P., or vs. some other fundamental reading of the performance of the machine. Examine the curves for a number of auxiliaries and it will be noted that these lines, the "Willans Lines," are straight within the working range of the machine, or so nearly straight that with only slight inaccuracy a straight line may be drawn through all the plotted test points which located the curve.

Any straight line can be expressed by an equation of the form

$$y = a + bx$$

where  $a$  is a constant — the intercept on the  $y$ -axis.

and  $b$  is a constant — the slope of the line.

$y$  and  $x$  the variables.

Applying this to the consumption curves of auxiliaries, there can be obtained the following equations:

For a reciprocating engine:

$$W = A + Bh$$

where  $W$  = Pounds steam per hour (total)

$h$  = H. P.

This in some cases may be written

$$W_1 = A_1 + B_1R$$

where  $R$  = R. P. M.

For a pump:

$$W = A + BS$$

where  $S$  = Double strokes per minute.

For a generator:

$$W = A + BK$$

where  $K$  = Kilowatts output

or  $W_1 = A_1 + B_1I$

where  $I$  = Load in amperes.

For a turbine with first stage pressure less than .58 inlet pressure:

$$W = A + BP$$

where  $P$  = Steam chest pressure absolute

$A = O$ .

(This formula corresponds to that for a flow through an orifice  $W$  per sec =  $AP/70$ ).

A number of equations derived in this way for destroyer auxiliaries are given at the end of this article. Several are taken from curves given by Lieutenant Commander Osgood in an article on "Daily Analysis," in the August 1920 number of the Institute PROCEEDINGS. These equations should be checked against the corresponding curves to check the validity of the assertions made herein.

It is to be noted that all the equations represent actual test data and are not theoretically derived. Also, that an equation is ap-

plicable over only the same conditions that the corresponding curve is applicable, *i. e.*, if the equation is given for the consumption of a pump at 300-pound discharge pressure, and 5-pound back pressure, another equation would be necessary for 100-pound discharge pressure or 15-pound back pressure, just as another curve would be required.

Note also that the equations for the consumption of turbines based on inlet pressure are independent of H. P., R. P. M., Discharge Pressure, Air Pressure, and within the ordinary range of pressures of Back Pressure.

Consideration of the equations at the end of this article will show the following advantages over curves:

(a) They are so simple that they can be worked out in many cases by mental arithmetic.

(b) They are very compact. A number can be included in very small space.

(c) They give data in a form which can be duplicated and disseminated by the typewriter or printer. This eliminates the need of tracings and blue prints and the expense and labor of making them. The Department could compile a great amount of data in a small pamphlet, and keep this pamphlet up to date through the confidential bulletins, a service of which the cost would be prohibitive if curves were used. Each engineer officer of a ship, when he conducted a water-rate test, could report his results in a form which would be immediately available for dissemination to the service.

(d) For reasons (a), (b), and (c), the data for all auxiliaries can be printed on one form for the daily analysis as illustrated in the sample form appended. This relieves the engineer officer of the necessity of thumbing through a sheaf of blueprints each time he makes an analysis.

This idea of presenting data in the form of equations for the use of the operating engineer can be carried further than is attempted here and probably for all classes of machinery.

As an example, take the boiler test curves given in Lieut. Commander Osgood's article:

Curve C, page 1229, "Equivalent evaporation lbs. water per gallon oil per hour *vs.* gallons of oil burned per hour," and curve, page 1230, "Factor of Evaporation *vs.* F. W. Temperature."

From Curve C, it may be assumed that for port use the equivalent evaporation per gallon of oil is constant at 120. Combining this amount with the data from curve, page 1230, the equation is derived:

$$E = 93 + .1 T$$

where  $E$  is the actual evaporation per gallon oil burned, and  $T$  is the Feed water temperature.

This equation gives the actual amount of water which would have been evaporated had the boiler been in the same state of cleanliness and upkeep, and had been operated under the same conditions and with the same skill as on test.

A further line of development leading from this may be shown using a Sturtevant forced draft blower turbine—equation  $W = 9.8 P$ . Assume port service feed temperature  $220^\circ$ , then  $E = 93 + 22 = 115$  lbs. water per gal. oil. Then the gallons of oil required to run the blower per hour is

$$G = 9.8 P / 115 \text{ or } .085 P \text{ (roughly } 1/12 P \text{)}.$$

A scale can be made out of this equation showing the fuel consumption of the blower and pasted on the dial of the throttle gauge for the instruction of the fireroom force in economical operation.

Returning to the point (c) mentioned in the second paragraph where lack of understanding of the application of the analysis was given as one reason for the non-universal use of daily analysis. This is perhaps natural when it is considered that the final result of the form as given in the Rules is a percentage scarcely more informing than the per cent obtained by dividing fuel allowance by fuel used.

The daily analysis can and should be carried much farther toward a definite determination of the location of faults. The sample form for a destroyer port analysis attached takes it a few steps along this line. Even the best analysis merely affords the foundation upon which the engineer officer can base his efforts to eliminate causes of inefficiency.

The quantities which are required to be determined for this more complete analysis are

(a) Pounds of water which would have been used had all machinery operated at its test efficiency.

This is determined by adding up all individual consumptions calculated by the equations discussed above.

(b) Pounds of water actually used.

Determined by actual measurement—timing given quantities of water collected in feed tank and from that calculating the total amount used in the day.

(c) Gallons of oil burned.

(d) Pounds of water which should have been evaporated, had boilers operated at test efficiency.

Calculated from oil burned using boiler formula given above.

(e) Pounds of water actually evaporated.

Add make-up feed to pounds of water actually used.

(f) Gallons of oil allowed by Engineering Competition Rules.

From these quantities the following percentages are obtained:

(a) divided by (b) gives the relative efficiency of the steam ends of steam-using machinery compared to their test performances.

(e) divided by (d) gives the relative efficiency of the boilers compared to their test performances.

(b) divided by (e) gives the relative efficiency of the whole plant including boilers and auxiliaries.

(f) divided by (c) gives an "Efficiency of Operation" which, although dependent upon the suitability of the competition allowance, takes into account not only the efficiency (b)/(e) but whether machinery is run too fast, too many auxiliaries are operated, or for too long a time, and such operating features.

The difference between (a) and (e) is a measure of leaks inside the steam systems; through leaky valves, traps, piston rings, drain seals, heating systems, etc., where the water is not lost, just as the make-up feed is a measure of leaks where the water is lost.

With all these efficiencies worked out the engineer officer's task of locating each cause of lowered efficiency is much simplified, and more so as he has each day an itemized list of test consumptions for each piece of machinery for comparison with other days. The results he obtains are thereafter dependent upon his engineering ability.

The daily analysis has here been worked out for port use only, and the equations for auxiliaries. Both have been used underway, however, involving a few more complications but none that are prohibitive.



It is hoped that the ideas presented in this article will be found of value to the service and by facilitating a wider dissemination of information and reducing the drudgery of analysis contribute to raising the level of Engineering Efficiency.

EQUATIONS DERIVED FROM CURVES IN AUGUST UNITED STATES  
NAVAL INSTITUTE PROCEEDINGS

(Check Against These Curves to Prove the Validity of the Formula)  
Back Pressure in All Cases, 10 Pounds Gauge

Boiler.

$$E = 93 + .1 T.$$

Main air pump. 15x30x30x24 at 28" vacuum.

$$W = 350 + 90 S.$$

Auxiliary air and circulating pump. 5½x6x8x7 at 2" vacuum.  
15 pounds press.

$$W = 90 + 4.25 S, \text{ or roughly, } W = 100 + 4 S.$$

Main feed pump. Blake 16½x24. Disch. press. 500 pounds  
gauge.

$$W = 500 + 220 S.$$

Auxiliary feed. Blake 16½x11x18. Disch. press. 300 pounds  
gauge.

$$W = 400 + 150 S.$$

F and B pump 7x7x12. Disch. press. 75 pounds gauge.

$$W = 120 + 13 S.$$

When pumping bilges or when used as flushing pump ( $DS =$   
35 to 40 and disch. press. 15 pounds) allow 75 lbs./hr.

F. O. Booster. 6½x7x8. Disch. press. 30 pounds.

$$W = 70 + 4.5 S.$$

F. O. Service. 6½x4½x12. Disch. press. 150 pounds.

$$W = 80 + 11 S.$$

Lubricating oil pump. 7x8x12. Disch. press. 40 pounds.

$$W = 100 + 10.5 S.$$

Oil cooler circulating pump. 8x9x12. Disch. press. 35 pounds.

$$W = 100 + 11 S.$$

Air compressor Westinghouse.

$$W = 25 \times \text{Pressure.}$$

Fresh water pump.  $3\frac{1}{2} \times 4 \times 4$ . Disch. press. 30 pounds.

$$W = 40 + 1.5 S.$$

Evaporator feed pump. Disch. press. 60 pounds.

$$W = 110 + 5.5 S.$$

FORMULÆ FROM CURVES FURNISHED BY NEW YORK SHIPBUILDING CO. WITH 16TH DIVISION

Back Pressure 0 Pounds Gauge

Main air pump. Warren  $11 \times 32 \times 21$ . Between 10 and 25 DS. 28" vacuum. Add  $2\frac{1}{2}\%$  for each 5 pounds back pressure.

$$W = 1800 + 100 S$$

Main feed pump. 300 pounds discharge pressure. Warren  $16 \times 12 \times 24$ . Add 2% for each 5 pounds back pressure.

$$W = 1000 + 225 S.$$

Auxiliary feed. 300 pounds disch. press. Warren  $15 \times 10 \times 16$ . Add  $2\frac{1}{2}\%$  for each 5 pounds back pressure.

$$W = 800 + 100 S.$$

Augmenter condenser - throat  $\frac{13}{32}$  inch.

$$W = 6.67 + P \text{ where } P = \text{absolute pressure.}$$

Fuel oil service pump. Disch. press. 150 pounds. Warren  $6\frac{1}{2} \times 4\frac{1}{2} \times 12$ . Add 4% for each 5 pounds back pressure.

$$W = 70 + 12 S.$$

Lubricating oil pump. Warren  $6 \times 8 \times 12$ . Disch. press. 40 pounds. Add  $3\frac{3}{4}\%$  for each 5 pounds back pressure.

$$W = 20 + 22 S.$$

Oil cooler circulating pump. Warren  $6 \times 7 \times 8$ . Disch. press. 35 pounds. Add  $5\frac{1}{2}\%$  for each 5 pounds back pressure.

$$W = 0 + 10 S.$$

F. & B. pump. Warren  $7 \times 7 \times 12$ . Disch. press. 100 pounds. Add 3% for each 5 pounds back pressure.

$$W = 160 + 21 S.$$

Evaporator feed pump. Warren  $4\frac{1}{2} \times 6 \times 6$ . Disch. press. 160 pounds. Add  $2\frac{3}{4}\%$  for each 5 pounds back pressure.

$$W = 20 + 9 S.$$

Distiller F. W. pump. Warren  $3\frac{1}{2} \times 4 \times 4$ . Disch. press. 30 pounds. Add  $6\%$  for each 5 pounds back pressure.

$$W = 20 + 9 S.$$

Auxiliary air and circulating pump.  $6 \times 8 \times 8 \times 7$ . Water press. 15 pounds. Vacuum  $20''$  Hg. Add  $5\frac{1}{2}\%$  for each 5 pounds back pressure.

$$W = 25 + 10 S.$$

Westinghouse air compressor. Steam pressure 200 pounds.

$$W = 3180 + 6 P \text{ where } P = \text{disch. press.}$$

Generator 25 KW. Back pressure 10 pounds gauge.

$$W = 600 + 46 KW.$$

Note that this is lbs./hr. and that KW is not KWH.  
Fuel oil heater.

$$W = .3 \text{ gals. oil/hr.}$$

Forced draft blower. Terry turbine.

$$W = 33 P \text{ with all hand valves closed.}$$

$$W = 41.5 P \text{ with one hand valve open.}$$

$$W = 50.5 P \text{ with two hand valves open.}$$

$$W = 59 P \text{ with three hand valves open.}$$

$$W = 67.5 P \text{ with four hand valves open.}$$

Note that these figures are independent of RPM back pressure or air pressure so long as throttle pressure (abs) is more than 1.7 back pressure (abs), i. e., about 35 pounds gauge.

The figure for oil consumption by the blower with all hand valves closed is  $33 P/115$  or  $.287 P$  gal./hr.

FORMULÆ FROM TEST DATA, JOURNAL A. S. N. E., AUGUST, 1918.

STURTEVANT TURBINE

$P$  Inlet Pressure Absolute

$$W = 9.8 P \text{ with all hand valves closed.}$$

$$W_1 = 14.2 P \text{ with one hand valve closed.}$$

$$W_2 = 18.8 P \text{ with two hand valves closed.}$$

FORMULÆ FROM CURVES FROM BU. ENGINEERING (FOR BETHLEHEM DESTROYERS)

Auxiliary Air Pump—Simplex Featherweight, 6x10x8

$$W = 90 + 4 S. \text{ Estimated.}$$

Generator 25 KW, G. E. turbine 3600 R. P. M. Steam at 200 pounds, 0° superheat.

On 28" vac.

$$W = 300 + 32 KW.$$

On 25" vac.

$$W = 320 + 34 KW.$$

On 0 pounds gauge

$$W = 410 + 35 KW.$$

On 10 pounds back pressure

$$W = 500 + 48 KW.$$

Auxiliary condenser circulating pump 3x3 reciprocating.

$$W = 50 + .3 RPM. \text{ Estimated.}$$

Main air pump. 15x30x30x24. Worthington.

$$W = 100 + 100 S. \text{ Estimated.}$$

Main auxiliary F. & B. pump. 7x7x12. Worthington.

$$W = 140 + 15 S.$$

Lubrication oil pump. 7x8x12 V. S. Worthington.

$$W = 290 + 7 S \text{ Estimated.}$$

Distiller fresh water pump. 3½x4x4 V. S. Worthington.

$$W = 20 + 1 S. \text{ Estimated.}$$

Oil cooler circulation pump. 8x9x12 V. S. Worthington.

$$W = 420 + 8 S. \text{ Estimated.}$$

Main and auxiliary feed pump. 16½x11x16 V. S. Worthington.

$$W = 250 + 125 S. \text{ Estimated.}$$

Evaporator feed pump. 4½x6x6. Worthington.

$$W = 5 + 2 S. \text{ Estimated.}$$

Fuel oil booster pump. 6½x7x8 V. S. Worthington.

$$W = 140 + 3 S.$$

Fuel oil service pump. 5½x4x8 V. D. Worthington.

$$W = 340 + 19 S.$$

FORM FOR DAILY ANALYSIS AT ANCHOR  
(Bethlehem Destroyers)

S—D. S. PER MIN. P—INLET PRESS. (ABS). R—RPM

Unit	Formula (H)	Hrs.	DS or Por R	Lbs./Hrs.	Lbs. total	Remarks
Feed pump M.orA.	500 + 150 S	.....	.....	.....	.....	Dis.pr.300 lbs
F. D. Blower.....	10 P	.....	.....	.....	.....	
F. & B. pump.....	.....	.....	.....	75	.....	Dis.pr. 15 lbs.
F. & B. pump.....	100 + 13.5 S	.....	.....	.....	.....	Dis.pr. 75 lbs.
Service pump.....	340 + 19 S	.....	.....	.....	.....	
Booster pump.....	140 + 3 S	.....	.....	.....	.....	
Evap. feed pump.	5 + 2 S	.....	.....	.....	.....	
Fresh water pump	20 + 1 S	.....	.....	.....	.....	
Aux. air pump...	90 + 4 S	.....	.....	.....	.....	
Aux. circ. pump..	50 + 3 R	.....	.....	.....	.....	
Lub. oil pump.....	100 + 11 S...	.....	.....	.....	.....	Dis.pr. 40 lbs.
Fuel oil heater...	.3 X gal. oil.	.....	.....	.....	.....	
Air comp. West..	25 X press.	.....	.....	.....	.....	
Generator.....	300 + 32 KW.	.....	.....	.....	.....	At 28" vac.
Generator.....	410 + 35 KW.	.....	.....	.....	.....	At 0 lbs.
Generator.....	500 + 48 KW.	.....	.....	.....	.....	At 10 lbs.B.P.
Main air pump...	100 + 100 S	.....	.....	.....	.....	
Evaps. S. E.....	15 lbs. per gal.	.....	.....	.....	.....	
Evaps. D E.....	8 lbs. per gal.	.....	.....	.....	.....	
Evaps. Aug. Exh.	0 lbs. per gal.	.....	.....	.....	.....	

- (1) Total steam accounted for in 24 hrs.....  
 Make up feed.....gals.....lbs.  
 Oil by account.....Gals.      Feed water temp.....  
 Oil to galley.....Gals.      (4) Rate evap. (93+ .1 T)  
 (2) Oil burned.....Gals. 24 hrs.      .....Lbs/gal. oil.  
 (3) Oil burned/hr.....Gal.      (5) Total computed evap.  
 (11) Oil allowance.....Gal./hr.      (4)x(2).....Lbs.  
 .....Gals. water collected in feed tank in.....minutes.  
 (6) Actual water used.....Gals./hr.....Lbs./hr.  
 (7) Actual water used.....Lbs. total per day.  
 (8) Actual water evaporated....Lbs. total per day (adding  
 make-up feed).  
 Overall efficiency of plant (1)/(5).....%  
 Boiler efficiency      (8)/(5).....%  
 Efficiency auxiliaries      (1)/(7).....%  
 Competition ratio for day (11)/(3).....%

CHECKS.

- (9) Feed pump piston displacement per hour 7400 S.....Lbs.  
 Water end efficiency (6)/(9).....%  
 (10) Service pump piston displacement / Hr. 105 S.....Gals.  
 Oil end efficiency (3)/(10).....%

[COPYRIGHTED]

U. S. NAVAL INSTITUTE, ANNAPOLIS, MD.

---

## FLEET RADIO COMMUNICATION IN WAR

By LIEUTENANT (J. G.) H. D. KENT, U. S. Navy

---

The battle efficiency of any fleet is vitally dependent upon the state of efficiency of fleet radio communications. This is a fact, not an opening argument. The late World War removed all doubts about the effectiveness of radio as a weapon. To-day we are inclined to measure its scope of usefulness and effectiveness by standards set up five years ago. The battle of Jutland gave us proof of radio communication's effectiveness and dependability and on that day it ceased to be an innovation or experiment. In view of subsequent development, we can now consider the radio equipment and organization of communications possessed by each side in that battle as crude. The real development of radio was brought about after the battle of Jutland. It was as much a development of organization as of material. It is the organization features that I propose to discuss herein.

Boilers will steam even though inefficiently fired; engines will turn over and propel ships even though not attended by expert mechanics. Likewise guns can be fired by untrained crews and an occasional hit scored. Communications cannot be employed in war time unless highly organized. Prior to contact with the enemy our plans would be revealed and during battle our fleet would be confused by inefficient communications.

In these days of immense fleets and central command, it is questionable whether or not these fleets could be coordinated and directed in battle except through the medium of radio communication and, even though it might be possible, it is obvious that an enemy who could utilize radio would place us at a tremendous disadvantage—all other things being equal. It will never be the lack of efficient apparatus which will handicap us on the day

of battle but lack of organization. It will not be the fault of present communication and radio officers if we lack organization but rather lack of foresight and sympathy on the part of officers in high command, afloat and ashore.

To promote cooperation and understanding between high ranking officers, we have a Naval War College. The courses there are designed to correct the individual perspectives to the prevailing doctrines, principles of strategy and tactics. Many of the detached ideas of officers who attend this school may be sounder than those advanced in the course but he subordinates his own views to the ensemble of ideas of the whole because the general assembly of the latter is closer fitting and less conflicting.

In war it remains to the commander-in-chief to originate the strategy to be employed. If his plans are sound, they will contain certain reflections of the war college influence and his subordinates will be able to undertake the details of execution understandingly. The main component of strategy is secrecy. Sooner or later the plans of the highest in command must be entrusted to radio. It cannot be avoided in these days of express speed and "thousandship" navies. Unless the organization of communications is extremely efficient, some parts of those plans will be revealed to the enemy and the "prior contact" strategy evaporates. Should this revelation betray our outlines bold and our units unsurprised and ready, all is well. We are building a big navy. If we are not preparing to meet another nation of great sea power, what then are we doing? The people of our country are giving us the weapons. Shall we assume we are only to use them against greatly inferior sea powers? No! Our communications must be organized upon the principle that eventually we will meet an enemy as strong as ourselves. All of which comes back to the fact that we must endeavor to organize for the purpose of handling fleet radio traffic as accurately, expeditiously and secretly as possible.

There is a significant relationship which always exists, to a certain extent, between the plans and movements of a fleet and the radio work carried on between ships of that fleet. The commander-in-chief is dependent to a certain extent upon radio communication for the information upon which he bases his estimate of a situation. After orders are formulated, he must distribute some of them by radio. Later he receives from his scouts information confirming his estimate or requiring readjustment of

plans. His main body may be ordered under way by radio and be maneuvered by radio until physical contact with the enemy is made. At the last minute he may be required to rearrange his line or improvise quickly to compensate for unexpected distribution of strength. Radio offers the most flexible means of doing this. In battle tactical maneuvers can be directed by radio when smoke screens, fog or haze would render signals useless. Fire discipline and fire concentration can be effectively carried out by radio and aeroplane spotting will be essential; using radio to report fall of shot.

To make all this possible, radio material must be installed so that radio communication can be maintained from each ship as long as she is able to stay in the line. Duplication of antennæ is the main requisite. Apparatus can be kept behind maximum thickness of armor.

Assume that the events outlined above are logical and do occur. Is it not obvious that we have confided enough to provide an enemy with a solution of our plans, provided he has intercepted all of the radio traffic of our fleet and can interpret it? Of course he will not be expected to accomplish this easily or quickly but a careful and intelligent study of our work by communication and strategical experts would certainly reveal some parts of our plans which, if correctly interpreted, would advertise the general objective. Even when radio work is most carefully handled, if it is intercepted by the enemy, it will give negative information which would limit his conjectures to a narrower field.

The layman is prone to believe that codes and ciphers, if carefully used, will insure secrecy. Most naval officers are informed to the contrary but most of them place too much confidence in codes and ciphers. Codes and ciphers, no matter how elaborate or intricate, only delay the ultimate receipt of the coded information by the enemy. The fact must be constantly remembered and the consciousness of it will place us on a pinnacle from which a true perspective can be obtained. Only a few moves can be obscured from an alert enemy and therefore the order of succession should never be indicative of the real objective. Sometimes, though, it may be policy to interpolate with "fakes" or to use a program of "fakes," a sort of a "radio feint," so to speak.

The time element or life of a code is an important consideration. No fixed rules can be laid down. Any code or cipher devised by



one human brain can be interpreted eventually by another. If several experts attack the problem scientifically, the solution is hastened. No cipher or code should be given a factor of safety greater than ten days if vital information is being confided to it.

The "breaking" of a code or cipher is much easier if the conditions under which it was sent are known. It is therefore desirable that code and cipher experts be expert operators also. The indications intuitively sensed by a radio operator very seldom can be correctly conveyed to him by another party. Other operators might not perceive significant conditions which would be obvious to the expert.

The above facts do not justify any carelessness or relaxation on the part of officers and men having custody of secret and confidential codes because a diagnosis of traffic has an element of uncertainty, but if we present to the enemy a solution he has hard facts.

More code and cipher organizations are undermined in peace than in war time. During peace there are always a few persons who are careless and compromise codes because they assume disinterestedness on the part of potential enemies. The first few moves of a war may determine the outcome. If our codes are compromised at the start, it is terrible indeed. Even though new codes are substituted the evil cannot be thus remedied. The "en clair" side of a code book is as important as the code. The order of appearance of the "en clair" side will be unique and characteristic of our nation. If the enemy possesses this alone, his difficulties are greatly reduced. For this reason too great care cannot be observed in the destruction of obsolete code books.

In peace time when a potential enemy or even a friendly nation comes into possession of our codes through the diagnosis of intercepted traffic, the damage may not be in the information contained by those messages, but in the fact that he can decipher previous messages which might be very embarrassing. Regardless of the nature of the information contained in a coded message, indifferent or careless coding is most culpable. Even though we could devise an infallible code which the enemy could not break, we could not be indifferent in using it or in handling traffic.

Variation in fleet radio traffic is most significant also. Sudden increase in traffic is invariably an indication of coming fleet activity and therefore fluctuations must be avoided. This can be

done by careful use of "dummy" messages, which are coded from a "dummy" code book but are devoid of meaning—in other words a "blank." However, such messages appear to be bona fide to the enemy. "Dummy codes" should be prepared in three, four, five and six-letter combinations. A definite system of releasing them should be used and the amount of traffic controlled by the flagship. Regular curves of daily traffic of the fleet must be kept and the valleys filled in with "dummies." The average hourly traffic should be kept up to the maximum demand point reached during activities of the fleet.

In addition to serving the above purpose, dummies play havoc with the enemy's code experts because the meaningless jargon can never be interpreted. These experts are bound to include many dummy groups in their respective group classifications. This inclusion makes the application of mathematics in "average re-occurrences" difficult. Also the handling of dummy messages is excellent training for operators as they become accustomed to handling peak traffic continuously and consistently. When "dummies" are used, operators must be required to handle them with as great care as is exercised in real messages.

We should always consider communications from a psychological standpoint. Anything we can do to break down the morale of the enemy's code experts should be carried out. They should be misled as often as possible by special programs. We must always assume that the enemy's commander-in-chief will not possess unlimited confidence in his code experts and communication officers. If they supply him with unreliable information he may be openly skeptical of them. This should be our object. Likewise, our own commanders must expect similar programs by the enemy. Imaginary movements are easily manufactured and staged through clever manipulation of radio sets.

The radio compass has become remarkably reliable ashore in the past two years. We hope for greater accuracy on board ships soon. The radio compass aboard ship is now dependable for relative bearings of a general nature and would often betray simple "fakes" as mentioned above. The writer understands that the Zeebrugge affair was made possible by radio compasses, which were extensively used in plotting the enemy's channels through mine fields by averaging up bearings observed upon testing

submarines as they passed in and out. Radio compasses are at least 25 per cent more accurate now than in 1917, so we must consider the possibility of their employment for similar purposes in future wars.

Radio compasses in aircraft enable them to steer the shortest course to a ship at sea using radio. This fact complicates the scouting problem and makes concealment practically impossible, either of position or of strength.

It would appear from the foregoing that the use of radio at all is unwise but such is not the case. Communication experts and radio operators will never be 100 per cent efficient and not all opportunities offered will be availed of. Commanders-in-chief and other commanders for many years will be reluctant when it comes to relying wholly upon deductions from intercepted enemy traffic. If the communication system of the enemy could be made 100 per cent efficient, strategy would be almost eliminated and all we could do would be to give battle at the most favorable point, provided he was willing to meet us there. But 100 per cent efficiency will never be obtained in radio any more than in ordnance and gunnery, so then our success in naval warfare must depend to a large extent upon difference in relative efficiency. We must assume that our potential enemy will be naturally endowed with cunning and stealth and prepare to play his own game. This requires training along special lines of the best fitted minds.

We should have a lasting communication organization afloat which will be independent of changes in fleet command. This organization requires an original definition of policies which should be governed by the principles laid down at the War College. Communications, strategy and tactics are inseparable.

Until we have properly trained communication officers we can not properly organize fleet communications. The present-day communication officers are too often accidental rather than designed. There are more communication officers in name than in fact. There are too many different kinds of organizations aboard ship, whereas every ship should be organized along the same lines. Each communication officer organizes his force according to his own ideas, but, granting that 75 per cent of the ships are excellently organized, cooperation to the fullest extent is handicapped. These facts are too well known to have these statements construed as critical.

We need a communication college and it should be closely allied with the War College, if not directly under it. There should be initial courses and post graduate courses. The initial courses should be given to officers of suitable temperament and experience. These courses should prepare radio and signal officers. After actual service in both branches, those officers who have been satisfactory should return for a post graduate course in communications and radio strategy. If an officer demonstrates unusual ability in communication work, he should be encouraged to remain in this work. Many communication officers are disheartened because of the fact that long tours of communication duty are jeopardizing their careers. Some arrangement should be made to allow the most skilful and sagacious communication officers to take an advanced course in radio strategy, code and cipher work and languages with the idea of fitting them for division and force radio officers. The logical communication career of an officer would be as follows:

- Midshipman ..... Naval Academy four years.
- Ensign ..... Routine duties afloat three years—engineering and line.
- Lieutenant (j. g.) ..... Eight months Communication College.  
 Radio and Signals.  
 Six months Signal Officer Afloat.  
 Twelve months Radio Officer Afloat.  
 Six months Communication College—post graduate course.
- Lieutenant ..... Communication Officer, battleship two years and then if unusually efficient to Communication College for post graduate advanced course, if desired. If not the above, then return to watch and division duties. If above the average and due for shore duty, then to duty with D. N. C. or Asst. D. S. C.
- Lieutenant commander ... If due for sea and has finished advanced post graduate course, to duty as division communication officer, two years.  
 If due for shore duty and has finished post graduate course, to duty as D. C. S. or with D. N. C.  
 District Radio Material Officer.

Commander .....	Take regular War College course. To duty at sea as Force Communication Officer. To duty ashore—Coast Communication Supt. or Assistant to D. N. C. Bureau of Engineering (Radio).
Captain .....	Fleet Communication Officer. Assistant to Director Naval Communications.
Rear admiral .....	Director Naval Communications.

The program above depends upon the constant elimination of the unfit and unwilling. Regardless of the period spent in communication work no officer would be handicapped in his preparation for command. As a matter of fact the British consider that communication experience is the best kind of preparation for ultimate command.

A communication staff corps is advocated by many but such a corps has many drawbacks. Communication work cannot be handled intelligently until an officer is well acquainted with line duties, fleet organization, strategy and tactics. The formation of a staff corps would tend to isolate the members from the service as a whole. It would also necessarily include many of the present line officers who might not prove to be qualified temperamentally. Subsequent vacancies would have to be filled with civilians or from the ranks. After the nucleus were well up, the lower grades would certainly be filled with officers lacking versatility in general naval work. Many advocates of the staff corps point out that the Army Signal Corps has been a success. The signal corps does little but receive and deliver despatches and maintain the channels. The communication service of the navy is charged with the execution of liaison between departments, which requires a broad knowledge of the service as a whole. The communication officer must always keep his perspective enlarged and correct and be sensitive to the tendencies and trend of policy changes.

We also need an intelligence system reorganization which will keep communication officers informed concerning foreign communication activities, especially those of potential enemies. I doubt if one communication officer in fifty knows of a single unique feature of the Japanese communication system. As early as 1917 the Japanese Government was educating some of their best communication officers in American colleges. I have in mind a lieu-

tenant commander in particular who was sent to Harvard to study under Professor Pierce at Craft Laboratory. He carried back to Japan with him a very good education in radio engineering and an intimate knowledge of our communication service as well. He studied the personnel of the radio school at close range. He "listened in" upon current official radio traffic and usually gleaned some information from each of his conversations with the most astute. He saw us in action in war time. I venture to say that Lieutenant Commander Nichizaki could instruct many of our own communication officers to-day about their own system. If the Japanese have utilized this officer with their customary thoroughness, he has already instructed their whole service along these lines before now. Other Japanese officers are undoubtedly under instruction in the United States of America now. If there should be war with any strong naval power to-morrow, could those of us now on communication duty be reasonably expected to hold our own against a service so well prepared and carefully trained? Our Yankee ingenuity avails but little. Isolated cases of ingenuity are never effective and more likely to confuse our own forces than the enemy.

I have brought out many facts—some of which are not pleasant to consider. It is only fair to state unreservedly that the present heads of the communication service are above any criticism I have raised here. All of these heads are line officers of broad experience, who have been fitted for their present duties by an unusually large amount of service in communication work or its allied branches. These men have demonstrated unusual ability to organize but to get lasting results they must be supplied with enthusiastic officer material to organize upon. The present heads of the communication service deserve great credit for their accomplishment in holding communications to war-time efficiency. It has been a great task to do even that. I believe we have made progress in the last two years towards better preparation for war.

To stimulate greater progress it is essential that all higher ranking officers be fully convinced of the true importance of radio communications. They must also recognize the value of communication duty from an educational standpoint in the preparation of officers for ultimate command. If the officers eligible to serve upon selection boards will give proper credit for communication duty, it will become more desirable duty and attract some of the

most brilliant minds. If brilliant minds, enthusiastic to improve conditions, are enlisted in the course, we can leave to present leaders the work of reorganization.

The present organization has been adjusted to utilize the present type of communication officer—usually one lacking experience and performing many extra duties.

The reorganization must be built upon properly trained versatile communication officers, who are enthusiastic and contented because they are confident that their accomplishments in communications will receive the same weight as those of other officers other lines.

[COPYRIGHTED]

U. S. NAVAL INSTITUTE, ANNAPOLIS, MD.

---

## VENUS AS A DAY SIGHT

By LIEUTENANT R. B. CARNEY, U. S. Navy

---

The problem of accurately determining the ship's position during the day is one that presents many difficulties and varying errors. For the most part, it seldom occurs that proper cross-bearings can be obtained and the navigator is obliged to fall back on that rather uncertain quantity, the run to local apparent noon. On ships whose missions permit of steady steaming on an uninterrupted course, the calculation of the correct interval to noon presents few real difficulties and no real disadvantages, but there are many times in the course of naval work where it is wellnigh impossible to properly run the ante-meridian sight up to local apparent noon with any degree of certainty. The navigator cannot be considered in the matter of maneuvers, and this very question of maneuvers gives rise to an error that varies in amount with the character of the evolutions performed, and with the nature of the ship performing them.

• Particularly in latitudes where the range of solar azimuths is small, that is to say where at no time is the sun near the prime vertical, the greatest accuracy is necessary in order that a good noon fix can be secured; this is evident from a consideration of the intersection of lines inclined at a small angle, and it is also evident that a small mistake in the matter of the ante-meridian line will result in a magnified error when the line is run up to local apparent noon. This accuracy of advancing the line is a hopeless task where there are numerous changes of course such as are encountered in destroyers or other craft engaged in screen, scout, maneuvering, or attack work, and it was this contingency that led the writer to consider the feasibility of using Venus in conjunction with the sun during daylight hours, as a method of



determining position without reference to a sun sight previously taken and run up.

Venus is generally visible to the naked eye some time before sunset as the evening star, and this very fact seemed to indicate that it was only a matter of locating the planet at any time during the day in order to make use of it. This use of Venus is by no means original with the writer; it has been used for years by older navigators, but its general use does not seem to be known among junior members of the craft and it is for their information that this paper has been prepared.

The problem, then, is the location of Venus during daylight hours when it is not discernible to the naked eye, and its solution is so simple as to make it practical, quick, and accurate. It becomes purely a matter of working backward with the star identification tables. Let us first consider the general method involved before taking up a concrete example.

A glance at the chronometer will give an approximate idea of the G. M. T. Apply the data from page two of the Nautical Almanac to obtain the G. S. T. and to this apply the D. R. longitude to determine the L. S. T. From the ephemeris of Venus take out the right ascension and declination roughly, applying the R. A. to the local sidereal time to determine the hour angle. The hour angle and declination, together with the D. R. latitude, are now known—the necessary arguments for entering the star identification tables.

Turning to the identification table with the latitude nearest to that of the D. R. position, find by inspection that part of the table where the tabulated hour angle and declination correspond to those predetermined for Venus; pick out the azimuth and altitude corresponding to these arguments, having due regard to the direction in which the tabulated azimuth must be applied, and also to the fact that should the declination be marked minus (—) it is to be named opposite to the name of the latitude. It is unnecessary to interpolate more closely than is possible by inspection.

With this altitude and azimuth set the sextant and pelorus accordingly. Owing to the fact that these calculations are all made by inspection and are not exactly accurate it has been found advisable for purposes of practical work to use the solar telescope attached to the sextant. This telescope facilitates the location of the star by virtue of its magnification but at the same time offers little hindrance owing to its relatively large field. Venus, although

invisible to the naked eye, shows up surprisingly plain when viewed through the solar telescope in this manner.

The steps enumerated sound rather complicated on the face of it, but in actual practice it is not more than a matter of two or three minutes' work to obtain the necessary information to properly set the sextant and pelorus. An example will serve to illustrate the method more fully.

On February 8, 1921, in about latitude 21 30 00 South, longitude 76 30 00 West, destroyer maneuvers in conjunction with the battle fleet made it impossible to accurately run up the ante-meridian line to local apparent noon. The latitude was easily determined by catching the sun on the dip, but the longitude could not be set down with any degree of certainty. So at about 12.55 p. m., the chronometer was seen to read 6.02; allowing five minutes for working out the data, and knowing that the C. C. was 2 m. 24 s., it was evident that five minutes hence the G. M. T. would be roughly 6 04 36. Applying the correction for G. M. T found on page two (2) Nautical Almanac, the G. S. T. was found to be 3 17 47.6. Subtracting the longitude (5h. 06m. 00s. West) gave the L. S. T. By inspection the R. A. of Venus was seen to be about 0h. 21m. The hour angle was therefore 22 11 47 and the declination was roughly taken as 3 25 00 *North*.

Chro. (allowing five minutes)	6 07 00
C. C.	(-) 2 24
	6 04 36
G. M. T.	21 12 11.8
	59.8
	3 17 47.6
G. S. T.	5 06 00
Long. (D. R.)	22 11 47.6
L. S. T.	21 00
R. A. (Approx.)	21 50 47.6
H. A. Venus	21 50 47.6
	or 2 09 12.4 East
Dec. Venus	3 25 00 <i>North</i>

Entering the star identification tables, it was seen that the above hour angle and declination were closely approximated in juxtaposition where the altitude was 52 00 00 and the azimuth South 128 East or 52 True. The sextant and pelorus were set accordingly and Venus was at once picked up near the horizon

close to the calculated bearings. The actual altitude and azimuth were found to be 50 31 00 and 50 00 00 respectively when the sight was taken.

The ease with which Venus may be located in this manner is surprising and the advantage of its use in connection with the sun is self-evident. Numerous methods of application of Venus as a day sight will suggest themselves to the navigator. For example, the altitude may be predicted for local apparent noon and a cross obtained, the meridian transit of Venus may be predetermined and simultaneously taken with the sun. In point of fact only the roughest assumptions need be made in regard to the selected G. M. T.; if the H. A. is worked to minutes by inspection no difficulty is experienced in locating the planet.

Jupiter offers almost the same advantages at certain times, depending upon its determining coordinates, and the writer has even at times been able to make use of Sirius before sunset, although in the case of the latter more exact calculations are necessary.

The use of Venus and Jupiter, however, is commended to all navigators as a most simple and efficient method of eliminating the uncertainty entering into all calculations that necessitate the advancing of one line to another through a period that may cover hours of steaming through unknown currents or doubtful errors due to service conditions.

[COPYRIGHTED]

U. S. NAVAL INSTITUTE, ANNAPOLIS, MD.

---

SPECIALIZATION *VERSUS* AMALGAMATION

By LIEUT. COMMANDER S. J. ZEIGLER, JR. (C. C.), U. S. Navy

---

From time to time articles appear in our service papers advocating amalgamation of certain staff corps with the navy line. More elaborate essays appear in our professional publications. Occasionally recommendations on the subject find their way to committees of Congress. The alleged advantages of amalgamation vary from monetary saving by the omission of staff initials following officers' names in official correspondence, to improvement in warship design, and even to changes in human nature which will eradicate differences of opinion.

"Amalgamation," a recent article in the U. S. NAVAL INSTITUTE PROCEEDINGS, by Commander N. H. Goss, U. S. Navy, discusses the amalgamation of the Construction Corps. Although many of the arguments for the maintenance of one group of specialists, or staff corps, apply with equal force to other staff corps as well, this discussion will be restricted to the Construction Corps.

That a "Navy *versus* Construction Corps problem" exists at all, or even that a Line *versus* Construction Corps problem exists is seriously doubted. If such a problem does exist in the minds of any line officers, and is allowed to continue and increase, it may lead to failure of cooperation and loss of efficiency. However, the real problem which constantly engages the attention of the naval constructors is rather the one of *the Construction Corps for the Navy*. The Construction Corps is an integral part of the navy. Its only reason for existence is for service to the Navy. It has no independent measure of success; its sole index of efficiency is the degree of success or failure of the fleet, which the Construction Corps' function is to design, construct and maintain. This

fleet, the performance of which gauges the merit of the Construction Corps, is operated by the Navy Line. What reason could there be for any other attitude on the part of the Construction Corps than one of energetic, whole-hearted, cooperative support of the Navy Line? There are other influences toward cooperation such as warm personal comradeships engendered between present line and construction officers by five or six years daily association in the Naval Academy and in steerage messes, at the age most conducive to lifelong friendships. This initial association is a powerful influence for cooperation, and is augmented by the mutual respect resulting from later duty in which line officers and constructors find themselves on the same stations engaged upon closely associated work towards a common result.

It is but natural that from the source, training, and life-work of naval constructors they constitute a loyal element of the naval service. They are an intelligent, hardworking, and efficient group of naval officers, who give their lives in service without any hope of ever reaping the ultimate reward always possible to their classmates who remain in the line, the opportunity successfully to meet an enemy in battle.

*Prima facie* proof of the esteem with which the parent Line of the navy regards its offspring, the Construction Corps, lies in the fact that it is possible, year after year, for the Construction Corps to recruit from the Navy Line officers drawn from the best material which each Naval Academy class has to offer, young officers, energetic, ambitious, patriotic and eager to serve their country to the best advantage.

Naval constructors do not claim to be able to manage destroyers, battleships or fleets better than the line officers in command. Yet we constantly hear, though possibly not seriously advanced, the converse, that line officers could design ships and manage navy yards better than naval constructors. However, at the present state of human development, an engineering project of the magnitude of our navy could not successfully be operated by a managerial personnel composed of a homogeneous type of jack-of-all-trades, any more than could a present-day fleet be successful if composed of a homogeneous squadron of vessels. The modern era is one of the specialist. Just as a modern fleet requires distinctly different types of vessels, a large engineering organization such as the navy requires different special types of personnel.

The trained and experienced surgeon, supply officer, engineer, and constructor, in addition to the executive line officer, who, by the way, is only another type of specialist, are just as necessary to the successful creation, maintenance and operation of a modern navy as is the inclusion of battle cruisers, scouts, destroyers, submarines and aircraft carriers, in addition to battleships, in the material composition of the fleet. There is no more reason to an argument that a homogeneous officer personnel is superior to one made up of well balanced groups of specialists than there would be to an argument for a fleet composed entirely of dreadnoughts, or for a turret crew composed entirely of gun-pointers.

The modern organization of navy personnel with its separate corps of specialists is the outgrowth of evolution extending over the entire period of naval warfare, just as modern fleet composition is the epitome of warship design derived through the slow evolution of type with its progressive branchings into separate diverging types, and embodying the accumulated wisdom of the ages since the days of the homogeneous fleets of Egyptian galleys.

The American Navy is probably the most complex engineering organization in this country. Industrially it is of the same order of magnitude as the United States Steel Corporation. Its property investment exceeds that of the Pennsylvania Railroad. Although the mission of the navy is that of national insurance, while that of a private corporation is to earn dividends for its stockholders, the principles of good management are the same for the navy as for any manufacturing or transportation concern. It is not difficult to imagine how the directors of the General Electric Company would receive the suggestion that their staffs of specialists be scrapped, and that instead the entire work of the company, including research, design, promoting, contracts, accounting, etc., be carried on by all round factory superintendents with a practical "shop point of view." Let us picture such an experiment having been tried out on the General Electric Company a few years ago. The results not only would possibly have been that we would still be without electric drive for battleships, but certainly that the company would now be in the hands of receivers, or finally liquidated.

One of the arguments often advanced in discussions of amalgamation is that transferring a staff corps to the navy line would

not deprive the navy of the special services now rendered by the staff corps, since the same officers after amalgamation would continue to be specialists; additional young officers of the line as required would be given special training, and assigned duty at intervals similar to that formerly performed by the corps, and thus the value of the specialist would not only be retained but also increased, because the young line specialist would have a "seagoing point of view." Is this argument sound? We would like to believe that it is, but we are afraid that it is not.

For a few years after the amalgamation of a staff corps, before the group of individuals amalgamated began to be seriously depleted, the function of the late staff corps would very probably continue to be discharged efficiently. Indeed we have a precedent for this in the amalgamation of the old Engineer Corps. However, without protection from possible discrimination against specialists in promotion, which can be afforded only by separate staff corps, the young officer is dubious about branding himself as a specialist. Such possible discrimination may never occur, but with promotion by selection either in its present or in a modified form practically a necessity, there is always a possibility that the policy of some selection board may be to promote the all-round executive officer at the expense of the specialist. This factor is psychological only, but it is possible that it is already at work, and that it is causing promising young engineer recruit material to shy from post-graduate engineering courses, and from engineering duty in general. It is also within the bounds of possibility that in time it may be necessary to reestablish an engineering corps, in order to supply a sufficient number of engineer officers for the navy.

To return to the Construction Corps, assume it amalgamated, and further assume that it proves possible to obtain a sufficient number of young line officer recruits at the time when replacement of the original specialists becomes necessary, will the proposed part-time specialist be able to deliver the goods up to the present construction corps standard?

The average age at graduation from Annapolis is about twenty-two years. After two years at sea, at the age of twenty-four the candidate for specialization in naval architecture, warship design and industrial management undertakes his three-year post-graduate course. He graduates at the age of twenty-seven. Up to this point he is just the same as any young constructor now

graduating from the Massachusetts Institute of Technology, and he is surely just as anxious to dig in and try out his specialty as any young assistant constructor to-day. Leaving the doors of the post-graduate Alma Mater, however, the courses of the full-time and the part-time constructors diverge.

The line officer who undertakes naval construction as an avocation, upon completion of his three-year course, is already a year overdue to go to sea, and he soon finds himself busily engaged upon a three-year tour of watch standing, at which occupation he is at a distinct disadvantage, for his classmates are way ahead of him in the eyes of the captain, executive and heads of departments. Possibly humiliated and discouraged, but not a quitter, by three years hard work he gains most of what he has lost as a seaman. When his sea duty is over, the part-time constructor, now thirty years old, is ordered to a navy yard or to a superintending constructor's office where he can begin to learn something practical about his specialty. His outlook is indeed gloomy. His post-graduate work has all to be reviewed, because three years hard work at sea has left little time to keep up on a non-applied science. Also since his stay is probably limited to two years he must get busy and learn the practical end of the game.

Work as hard as he can, our part-time constructor encounters heavy weather both ashore and afloat, because it is exceedingly difficult for any one man whether he is dubbed line officer or staff officer to become proficient in two whole-time, man-sized jobs. By the time he is fifty our line-constructor has managed to get in perhaps ten years on his specialty, and is competent successfully to swing a navy-yard job, but he is past the zenith of his career. After this he feels comfortable ashore, but in getting a hold on the beach he has lost his grip at sea. Soon he is out of the running for important commands afloat and puts in the rest of his years until sixty-four as an industrial executive at a navy yard. He finally goes on the retired list with the feeling that he has spoiled a good line officer to make a mediocre naval constructor; of course he is right.

The only excuse for this continual shuttling between sea and shore, which prevented the full development of either marked specialized ability or general military leadership, was to give the intended specialist a "seagoing point of view." The mistake was not in providing him with an opportunity for practical experience



and observation, which is a leaven necessary in order to produce the most effective technicians. The error was in devoting too much time, more than required, to general service, and not enough for sufficient periods of concentration on the specialty.

A fact often overlooked is that naval constructors do go to sea, and that the present Construction Corps, in addition to a corps or rather a technical point of view, has a thoroughly practical seagoing background. This is the result of early sea experience as midshipmen or ensigns in the line, augmented by later intermittent details afloat as fleet and force naval constructors, tours of duty on repair ships, regular service on the Board of Inspection and Survey, and temporary details to duty on trials. Naval constructors are regularly detailed on the staffs of the commanders-in-chief of the Atlantic fleet, and of the Pacific fleet. Officers of the Construction Corps are also provided in repair ships' complements. During the World War constructors served on the staffs of the Commander of the U. S. Naval Forces Operating in European Waters, and of the Commander of the U. S. Naval Forces in France. From a consideration of these facts and of the conditions surrounding navy yard duty where constructors deal daily with ships' officers, it is difficult to conceive how the Construction Corps could escape the essential salty atmosphere.

Another, and more tenable, solution for amalgamation admits that an all-line personnel could not render special service up to present standard requirements, but proposes that the number of specialists be reduced, and the vacated billets be filled by civilians. As a makeshift arrangement, this scheme would suffice. But why substitute plain-clothed experts, at much greater expense, for the present uniformed experts? In the first place, are they available, and would they give better service in proportion to their greater remuneration? Industrial executives, good ones, undoubtedly can be secured, if their price be paid, but the necessary salaries would hardly be forthcoming. The salary limits which could be obtained would very probably be little if any in excess of salaries paid civilians and officers in the naval service to-day. These salaries would not attract competent industrial executives in the open market.

Warship designers, however, are not available at any price, or under any conditions; there is no source of supply. Naval architects, competent successfully to design any merchant craft, are

available on the staffs of any of our large shipbuilding firms, but they cannot replace our warship designers. General warship design requires such an enormous outlay of money for the maintenance of the necessary personnel, for intelligence work, research, and experiments, as well as for the maintenance of archives and experimental stations, in addition to design production, that no private corporation could undertake it. The demand for warship construction is entirely too meagre and intermittent to warrant the expense. Warship designers must be developed and maintained within the Navy itself.

The conditions surrounding general warcraft design and the design of component elements of warcraft are not the same, and analogy cannot be drawn between the development of the whole and its parts. The purely commercial fields for boilers, turbines, electrical machinery and gasoline and oil engines are so great, and commercial competition is so keen, that private manufacturers are leaders in improvement in mechanical and electrical engineering design and practice. While private industry has very materially aided the Navy in working out designs for boilers, turbines, reduction gears, electrical machinery generally including electric drive, and aircraft and submarine motors, the Navy has played a lone hand in general design ever since there has been a real Construction Corps. Naval constructors designed and constructed the first experimental model basin and wind tunnels in this country, and naval constructors conducted all of the original experimentation at these plants, literally blazing the way for this work in America. It is in the span of less than a lifetime that the work of the Construction Corps has been accomplished. Many of the officers who founded the science of warcraft design in this country after study in France, England, and Scotland, are still on active duty in the navy to-day.

Granting that civilian substitutes for navy yard commandants, managers and superintendents, if sufficiently high salaries are made available, can be obtained, would their service be as good as that now rendered by commissioned officers? To say the least, it would be a doubtful experiment. The management of civilian navy yard labor on ships controlled by naval personnel and on shore under semi-military conditions is an extremely delicate task, and it is difficult to conceive a successful manager who is not a master of both naval and labor psychology, and well versed in probable

Washington reactions. Who is more apt to have these triple talents, a naval officer of long experience in navy yard management, or an imported civilian industrial executive?

Until quite recently American naval constructors were all civilian experts employed in navy yards just as civilian foremen are now, except that their employment was usually intermittent. When a navy yard received an order to build a ship a "naval constructor" was employed to supervise the construction. When the vessel was completed, if another ship was not to be built, the naval constructor was discharged along with the foremen and mechanics. The civilian naval constructors who built our wooden navies were practical shipbuilders with a certain knowledge of ship design, but were not warship designers, nor were they administrators of any high degree.

The first naval constructor was commissioned an officer in the navy as late as 1866, the appointee being a civilian, and it was not until 1879 when young Naval Academy graduates were selected to recruit the corps, and sent abroad for special study, that the corps of naval constructors as it exists to-day was commenced. It is worth while to remember that the creation by Congress of a "Bureau of Construction, Equipment and Repair," and the formation of a corps of naval constructors as commissioned officers of the navy, were very largely brought about as a result of agitation by line officers of the navy who realized that the highly important functions of construction, equipment, and repair could not successfully be continued by line officers. The present Construction Corps was thus born of necessity, conceived by the Navy Line itself, of which it is a direct offspring.

Unqualified statements encountered both in print and in ward-room discussions to the effect that when ships come to navy yards, it requires greater effort to get hull work through than machinery work, are capable of ambiguous inference. Did such a condition exist, one explanation might be that the machinery division requests are not properly scrutinized, and the work not properly supervised. As none of us believe this we must search for another reason. Can it be due to the incompetence of the hull division officers? Even if the hull division officers were incompetent, would this be a reason for regrettable delay in accomplishment of construction work? Hardly. All ship work which can be undertaken at a navy

yard without reference to the Navy Department is authorized by one individual, the general manager of the industrial department, whether this individual be commandant or industrial manager, and this general manager has identical authority in regard to all repairs regardless of bureau cognizance. Why should this individual be more prompt to authorize one bureau's work than another's?

Is this delay, then, due to paper work, upon which it is almost standard practice to blame many of the Navy's ills? In some yards, possibly, yes. But who of us familiar with navy yard operation would believe that any yard division ever failed to spend its entire allotment of funds on account of delayed paper work? I believe that I am correctly informed that in three only of the nine principal navy yards are there separate central offices maintained by the hull and machinery divisions. The other six yards have combined central offices, and work for all bureaus is handled by one standard production system for the yard. The paper work is identical, and is accomplished by the same individual planners and clerks for both industrial divisions. Further, at three of these six yards dual superintendence is abolished, so that each unit of the yard organization is in charge of one responsible superintendent. One superintendent's function is identical for each bureau's work. In these yards the sheer difficulty of delaying any one bureau's work would soon tire any obstructionist.

Is the delay then encountered in the execution of the work in the shops and on the ships? As every yard's working force is adjusted to the combined monthly allotments of funds from all bureaus, and as one bureau's funds cannot be diverted to another's work, it necessarily follows that approximately constant forces are employed daily upon work chargeable to each bureau's allotment. It is needless to add that all allotments are fully obligated each month.

It is true that there are many more requests for construction and repair alterations submitted than there are for engineering and ordnance alterations. All of these alterations have to be submitted to the bureaus with estimates, for approval, and the actual work cannot be started by the yard until the proper authority is obtained. This procedure is required by navy regulations and affects all alterations alike. Delay in approval on hull alterations is the same in *degree* as on machinery alterations, the *number* of

items delayed only is greater. How, then, does this construction and repair work become so vexatiously delayed? I leave the answer to a trained psychologist.

To amalgamate the Construction Corps with the line would have little effect upon the material welfare of the present individual naval constructors. Any amalgamation law would at least be fair to the individuals affected, and it is quite within the bounds of possibility that such an act, if passed, would be advantageous to certain individuals, allowing them to retire with higher rank than they normally would attain. Such proved to be the case in the amalgamation of the Engineer Corps, many of the old engineer officers retiring with the rank of rear admiral. Amalgamation would, however, mean the retrogression of the science of which the Construction Corps is the body and the soul. Without an adequate group of specialists to devote their lives, full time, to the science of warcraft design, this vital element of naval defence would in time entirely be lost.

As long as we are human there are bound to be differences of opinion between staff officers and our classmates in the line, just as at present there are differences of opinion among groups and individuals within the line, and just as there are different opinions among naval constructors. However, these differences of opinion nearly always remain friendly, and should never be allowed to interfere with either efficient team work for the Navy, or high regard for the accomplishment of brother officers. The staff officers of the Navy surely join the country in doing honor to the navy's heroes in the line. What staff officer during the World War would not have gladly exchanged his overalls for a suit of wind-proofs? Our only compensation was the thought that the humble navy yard or bureau job was necessary, and that somebody had to do it in order to produce and keep operating a fleet in which more fortunate officers could win the war. In return for the homage which we pay the line, our respect for it, and our service to it, we merely ask, instead of criticism, the Navy's usual reward for good work faithfully performed, an occasional hoist of "WELL DONE."

## DISCUSSION

---

### The High Sea Fleet at Jutland

SEE PAGE 1721, WHOLE No. 213

LIEUT. COMMANDER H. H. FROST, U. S. Navy.—After the publication in the PROCEEDINGS of the paper entitled "A Description of the Battle of Jutland," the writer sent a copy of it to Admiral Jellicoe and three copies to the British Admiralty through the British Naval Attache in Washington, with a request that any errors be corrected.

Admiral Jellicoe in a very courteous letter declined to comment on the paper in view of the fact that the Admiralty was about to publish its official account.

The British Naval Attache later stated that the Admiralty had received the copies and very kindly furnished the writer with a copy of the official report which was recently issued by the Admiralty.

Upon the publication of the paper entitled "The High Sea Fleet at Jutland," copies were forwarded to Admiral Scheer, Admiral Hipper and Commander von Hase, author of that excellent book on the battle, "The Two White Nations." A request was made that any errors might be corrected and any comment considered pertinent might be made.

The following letter was received from Admiral Scheer:

"Weimar, 9.2. 1921.

"DEAR SIR.—I thank you very much for sending me your article, which I have read with great interest.

"The description is throughout correct and quite impartial and fair.

"If I may take the liberty of making a comment I would say this: While the battle is progressing a leader cannot obtain a really clear picture, especially at long ranges. He acts and feels according to his impressions. In looking at the diagrams which are made subsequently it would seem as if we must have regarded our position as critical. In reality this was not the case. We were under the impression of the splendid effectiveness of our gunfire and of the fact that the entire battle line remained most conveniently arranged both while under fire and during the regrouping for the night march.

"Thus we were looking forward with confidence to a new engagement.

"The fact that on August 19 the German Fleet again proceeded in a direction which would have placed us in an even more difficult position may serve as proof of this.

"I would be greatly interested in hearing the criticism which is made by American Naval Officers concerning the behavior of the two fleets.

"With the expression of my highest esteem,

"I am, yours very sincerely,

"SCHEER,

"Admiral."

The letter received from Admiral Hipper contains very interesting information, presented here for the first time. The letter follows:

" I III 21

"DEAR SIR.—Please accept my most sincere thanks for your courtesy in sending me your article: "The High Sea Fleet at Jutland," for which I am greatly obliged.

"I have read the article with much interest and thoroughly appreciate its thoroughness and inherent worth.

"If I might draw your attention to a few not very essential inaccuracies they would be as follows:

"Page 1727. Strength comparison. The Germans had only 65 torpedo boats in the battle.

"Page 1729. The small cruisers of the IV Scouting Group were not sent forward on a scouting line for the fleet, but were placed with the squadrons; they were therefore with the main body while the II Scouting Group was in the van with the battle cruisers.

"Page 1742. The movement was carried out *only* for the purpose of avoiding the enemy torpedoes.

"Page 1758. The smoke was not that of the burning *Lutzow*, but a smoke screen purposely thrown out by that vessel and the accompanying torpedo boats.

"Page 1761. Typographical error. 56° instead of 36°.

"Page 1762. The smallest distance between Scheer and Jellicoe during the night was not three but at least 7 or 8 nautical miles. The course of the German Fleet during the night was 136°.

"Page 1763. The *Moltke* and the *Seydlitz* had, during the night, gone to the head of the main body in order to support the II Scouting Group. The *Moltke* sighted a heavy enemy squadron twice during the night (probably the Battle Squadron which remained behind with the *Marlborough*) and was for a time forced southwards, but at daylight she succeeded in joining the main body of the German forces.

"Page 1765. The rumor of the torpedoing of vessels of the *Konig* class was *not* occasioned by the torpedoing of the *Grosse Kurfurst* and the *Kronprinz* which occurred later, in November, 1916, but resulted from the English reports about the battle. Compare Jellicoe, "The Grand Fleet," page 381, where in fact four ships are mentioned *besides* the *Pommern*.

"If you have another copy of your article to spare, the Naval Archives of Berlin would be exceedingly grateful for it.

"I have the honor to be

"Yours respectfully

"HIPPER,

"Admiral."

The correctness of Admiral Hipper's statement that the Grand and High Sea Fleets were at least 7 miles apart during the night is verified by a fresh estimate of the situation as shown by the recent official dispatches, which shows the minimum distance to have been about 7½ miles.

The fact that the *Moltke* was in contact with a British Battle Squadron during the night is proved by Official British Despatches.

"About 12.30, what was first taken for destroyers approaching was observed and 6-in. guns turned on them and the order had been given to open fire, when it was seen that the object was a large ship. She was challenged and made the reply "PL" and rapidly disappeared astern. She had the appearance of a battle cruiser and resembled our own." (*Revenge*.)

"About midnight smoke was observed ahead of *Marlborough*, which crossed from starboard to port and back again from port to starboard, and then came down the starboard side. It appeared to be a large ship and was challenged by *Revenge*, who was answered by two letters, though they were not the correct ones. She then disappeared." (Vice Admiral, First Battle Squadron.)

Commander Georg von Hase replied in part as follows:

"DEAR SIR.—I received some time ago your work "The High Sea Fleet at Jutland" and give you my best thanks for having sent it to me. Your work is excellent and it gives a superior picture of the seafight off the Skagerrak. I can bear witness that you have handled the subject throughout impartially and concisely. The battle sketches are very excellent and give the specialist a much better and clearer picture than any professional book has done yet. I am very pleased to possess your interesting book.

"As a sign of my esteem I am sending you a copy of my book, 'The Two White Nations.'

"With friendly greeting, I am, yours sincerely,

"GEORG VON HASE,

"Fregattenkapitan, a. D."



U. S. NAVAL INSTITUTE  
SECRETARY'S NOTES

**Membership** Membership. Life, regular and associate, 5481.  
New members, 39. Resignations, 8. Deaths, 1:  
Rear Admiral A. F. Fechteler, U. S. Navy.

Practically the whole service receives the benefit of the PROCEEDINGS yet many officers, who read it monthly, are not members and therefore contribute nothing to the support of the Institute. Members are requested to urge non-members to join. Publication costs are now so high that the Institute is carrying a loss. The cost, per member, however, decreases with an increase in membership.

The annual dues (\$3.00) for the year 1921 are now  
**Dues** payable.

Regular and associate members of the U. S. Naval Institute are subjected to the payment of the annual dues until the date of the receipt of their resignation.

Discussion of articles published in the PROCEEDINGS is cordially invited. Discussions accepted for publication are paid at one-half the rate for original articles, or about \$2.25 a page.

*All members are urged to keep the Secretary and Treasurer informed of the address to which PROCEEDINGS are to be sent, and thus insure their receipt.*

**Address of Members** Members and subscribers are urged to notify the Secretary and Treasurer promptly of the non-receipt of PROCEEDINGS, in order that tracers may be started. The issue is completed by the 15th of each month.

*The Institute Book Department will supply any obtainable book, of any kind, at retail price, postage prepaid.* The trouble saved the purchaser through having one source of supply for all books, should be considered. The cost will not be greater and sometimes less than when obtained from dealers.

The Boat Book, 1920, and the Landing Force and Small Arms Instructions, 1920, are now ready for issue. The price of the former is 50 cents per copy, and of the latter \$1.00 per copy.

In the early part of the summer, the Institute will publish two books, bearing the following titles: "The Aircraft Hand Book," by Lieutenant Albert Tucker (C. C.), U. S. Navy, and "Composition for Naval Officers," by Professors Stevens and Alden, Dept. of English, U. S. Naval Academy.

The prices of these books will be announced later.

The Seaman's Hand Book, containing much valuable information for enlisted men, particularly those of the deck force, has been added to the Institute's publications. This excellent little book is retailed at 65 cents per copy.

The attention of readers of the PROCEEDINGS is invited to the classified analytical index for numbers **Index to Proceedings** 101 to 200 inclusive, which is noticed under "Publications." This is a most complete index, which has been prepared at considerable expense in order to make readily available the information contained in both the articles and the notes of these issues. Only a limited number of copies are being printed. Price, bound in cloth, \$2.35; bound in paper, \$1.85.

The Institute desires articles of interest to all branches **Articles** of the service, including the Reserve Force. Attention is invited to the fact that the submission of articles is not limited to members, and that authors receive due compensation for articles accepted for publication.

All articles and discussions submitted by persons belonging to the navy for publication in the PROCEEDINGS must be in duplicate, one copy being signed by the author, which will be submitted to the Navy Department when the original is published, as required by General Order No. 46, of May 20, 1921.

The attention of authors of articles is called to **Reprints of Articles** the fact that the cost to them of reprints other than the usual number furnished, can be greatly reduced if the reprints are struck off while the article is in press. They are requested to notify the Secretary and Treasurer of the number of reprints desired when the article is submitted. Twenty copies of reprints are furnished authors free of charge.

Authors of articles submitted are urged to furnish with their manuscript any illustrations they may have in their possession for such articles. The Institute will gladly co-operate in obtaining such illustrations as may be suggested by authors.

Original photographs of objects and events which may be of interest to our readers are also desired, and members who have opportunities to obtain such photographs are requested to secure them for the Institute.

Whole Nos. 6, 7, 10, 13, 14, 15, 17, 144, 146, 147, 173. Notice 215 and 217 of the PROCEEDINGS are exhausted; there are so many calls for single copies of these numbers that the Institute offers to pay for copies thereof returned in good condition at the rate of 75 cents per copy.

ANNAPOLIS, MD., June, 1921.

#### INFORMATION INDEX

	PAGE
ADVERTISEMENTS, INDEX TO.....	I
PUBLICATIONS, U. S. NAVAL INSTITUTE.....	(2)
SPECIAL NOTICE .....	1150
TOPICS FOR ESSAYS .....	1151

# PROFESSIONAL NOTES

PREPARED BY

LIEUT. COMMANDER H. W. UNDERWOOD, U. S. Navy

## GENERAL ARRANGEMENT

VESSELS BUILDING.	}	France .....	1091
NAVAL POLICY.		Great Britain .....	1093
MATÉRIEL.		Japan .....	1101
PERSONNEL.		United States .....	1109
MERCHANT MARINE.			
AERONAUTICS .....			1114
MISCELLANEOUS .....			1138
CURRENT NAVAL AND PROFESSIONAL PAPERS.....			1140

## FRANCE

**FRENCH NAVAL PROGRESS.**—There are ample signs on all sides that France, abominably devastated, but victorious—after displaying a patience no other great nation would have shown in her place—means at last to assert her rights as recognized by the 1918 Versailles Treaty. Moreover—a fact overlooked in England—she has no choice; bankruptcy and revolution are at her doors if the long-overdue Boche reparations are not forthcoming. The national indignation at the contrast between France's unparalleled sacrifice and the negative results obtained up to the present is such that the least delay in enforcing redress from Boche land will overthrow the Briand Cabinet or any other Ministry weak enough to trust to conferences and scraps of paper after the unedifying experience of the last two years.

Outside of a very small minority of Socialists that have been won over to the Boche cause by the Berlin subsidies, the great bulk of the French nation is genuinely Anglophile, and would welcome naval and military co-operation with Great Britain; but, if necessary, the Republic is preparing to act single-handed, both at sea and on land. It is understood that Admiral Sagot-Duvauroux (59), now Prefet Maritime at Toulon, an officer reputed for his sangfroid and firmness, would hoist his flag in the 24,000-ton Provence (22 knots, small tubes, ten 13.4-inch guns), and eventually take charge of the "escadre et flotilles de blocus," now being formed at Brest. Toulon, like Brest, is getting alive again, and officers de vaisseau welcome the possibility of an opportunity to work anew on the water.

The rumored adoption of extreme displacements by the English Navy for her "improved Hoods" is having a disheartening effect on French partisans of Cuirassés. France was glad to go one better than the dreadnought (24,000 tons against 18,000), but when it is a question of exceeding 40,000 tons she cannot by any means follow suit, for financial and political reasons, and so, on the motion of Chairman Dupuy, the Commission de la Marine is giving serious consideration to "Dreadnoughts de 15,000 à 16,000 tonnes," designed not to rule the ocean but simply for defensive work in the Mediterranean and round the French coasts, thus with reduced radius of action, but with stout armor and

the biggest practicable calibre, enabling them to have a say against the mightiest dreadnoughts. The 7,000-ton requins of 40 years since lacked freeboard and could not have fought in a seaway; their improved copies, the *Bouvines* (1892), were very unsteady; the *Henri IV* (1899, though remarkable, was too weakly armed. What is wanted to avoid these defects is a *Patrie* carrying three or four guns of 18-inch bore.

The French destroyer flotillas that have been decimated by the fearful wear and tear of the war, and also by the neglect and lack of sea practice of the last two years, are to be strengthened this year by the Normand-built *Enseigne Gabolde*, of 900 tons, 22,000 h.p., with oil furnaces and geared turbines, three 4-inch guns, and four torpedo tubes. This torpilleur d'escadre was commenced in November, 1913, and, significant enough, is the first French-built addition made to the flotillas for the last six years, Gallic yards having from the opening of the war given up new construction to devote their whole energy to ammunition and gun-making for the Allies. Consequently, she compares poorly with the many units of later designs built during the war by the British, American, and Italian navies. Yet she is an interesting craft in several respects. Her speed, nominally 30 knots, will probably exceed 35 knots on trials, the Norman firm, that 25 years since created the famed Forban torpilleur de haute mer type, being known to excel in the construction of motors. Previous boats of the same series, the *Bouclier* and *Casque* notably, exceeded 36 knots with 15,000 h.p. These records ought easily to be beaten by the *Gabolde*, that has had, besides, her armament modified by the addition of a third 100-mm. gun that has led to striking changes in her original silhouette. With her two super-imposed forward guns, she will resemble many British cruisers and destroyers.

If the 2,200-2,500-ton destroyers of the 1921 programme can be pushed forward with as much speed as is officially expected by the several arsenals and private yards that are making ready for the contracts, the *Marine Française* may regain some of the ground lost, though, considering the extremely fine designs produced within the last few years by the British and Italian Admiralties, it will not be so easy to realize the superiority for all-round quality and for individual fighting strength and speed, which is avowedly the object the Rue Royale authorities have in view in adopting unusually high displacements for their projected contretorpilleurs. With the experience of the real thing in their minds. French officers insist on two main points, viz., reliable and high sea speed and superior calibres, with a view to securing the first hits and having the upper chance in the end-on actions that are the rule between destroyers.

Admiralissimo Dartige du Fournet complained bitterly of the fragility of his 800-ton destroyers, and could only find two or three really satisfactory in the whole lot. The successive "Commandants des Flotilles de l'Adriatique" remarked that their contretorpilleurs, though superior to the Austrian on paper, could never catch them at sea, and especially lacked sufficient calibre to stop the enemy. The disclosures made at the time of the *Forget* affaire were edifying on this point. Still, since the advent of the 6-inch gun as a destroyer weapon the 5.5-inch, even improved, will be none too strong for its eventual work.

The painstaking aerial experiments of the last two years in the Mediterranean have led to tangible results, as is shown by the appointment as "chef de l'aviation d'escadre" of Lieut. Teste (28), a gifted young aviator whom his comrades had surnamed "un brave parmi les braves" for the exceptional gallantry and resourcefulness which he displayed off Dunkirk in May, 1917, in an unequal fight between four French flying machines of obsolete type and ten larger and more up-to-date Boche seaplanes, when he was wounded and, after astounding "péripéties," made a prisoner, taken to a Boche reprisals camp, whence he escaped under exciting

circumstances. To his ingenuity and daring is due the success of the comprehensive experiments (landing and flying off under the various conditions of weather and wind) carried out in the Béarn and Bapaume under the supervision of the go-ahead Admiral Violette. Obviously he is the right man in the right place, and, as he combines practical competence with "feu sacré" and a genuine faith in the high destinies of aviation, he may be expected to accomplish much and to substantially add to the fighting worth of la flotte de la Méditerranée, provided he is allowed sufficient freedom of action to fully display his qualities of initiative. Up to the present the development of the French aerial wing has been hampered by the ill-will and incurable dislike for innovations of antiquated admirals, and the fact speaks for itself that, whereas the French army counts scores of flying generals, and among the most eminent, the Marine Française is still waiting for her first "amiral-aviateur," a rather bad sign at a time when maritime efficiency depends to so great an extent on aerial supremacy, especially in narrow Mediterranean waters.

The French "aviation navale," first in date in the naval arena but badly handicapped by incompetence at the head, is getting none too soon in shape when are considered the strides accomplished by the Italian and British naval flying squadrons. The lessons of the fiasco of the trans-Mediterranean group-flight organized by Admiral Ronarch have not been lost. Improvisation, impossible at sea, is, if anything, still more impossible in the air. Success to be attained requires robust and reliable machines together with a thoroughly-trained and numerous personnel, desiderata that can only be the result of constant practice and of careful fostering by the Rue Royale authorities. In addition to the Béarn (to be ready next year) and to the 800-ton porte-avions of the Bapaume class, all battleships and cruisers are gradually to be fitted to carry small "avions de chasse, d'éclairage et d'observation du Air," very satisfactory installations having been worked out, whilst heavy "avions autonomes de bombardement" too large and cumbersome for transportation on board, would operate from basis now being prepared in Corsica and on the North African sea border.—*The Naval and Military Record*, May 18, 1921.

**THE MERCHANT FLEET.**—The *Ligue Maritime* has issued a manifesto which reflects the general feeling of uneasiness regarding the future of the merchant fleet. While the French were fighting for their full share of the surrendered German shipping the condition of the mercantile fleet was painted in very sombre colours, and it was declared that in the absence of a fleet of her own France was absolutely dependent upon foreign freights. Now that most of the surrendered enemy ships have been delivered, and the vessels ordered from British and American yards are in French hands, it is found that there are far too many for present needs, and the harbors are encumbered with ships that are laid up through want of freights. While the tonnage before the war was only 2,500,000 tons, it will before long exceed 4,000,000 tons. The *Ligue Maritime* therefore feels that if some vitality is to be imparted to the merchant fleet it can only be done by a national effort, and it therefore appeals to manufacturers and traders throughout the country to give a preference to French boats wherever possible, for it is argued that if French ships were assured of full cargoes it would be possible to bring down freights, which are at present high on account of the operation of the eight hours' day and other charges with which foreign ships are not burdened.—*Engineering*, May 13, 1921.

## GREAT BRITAIN

**WARSHIP DESIGN AND TORPEDO ATTACK.**—The problems associated with warship design, and especially those relating to protecting against torpedo attack, are again exercising the minds of all interested in the subject, in

view of the fact that four new capital ships are about to be laid down to take the place of obsolescent ships in the British navy. Under these circumstances it is of interest to review the question in the light of recent experience and controversy. It will be remembered that Sir Philip Watts has in two successive years, at the Institution of Naval Architects, raised the question of the protection of battleships against torpedoes. He stated that all the dreadnoughts, battleships and cruisers up to and including the *Queen Elizabeth*, were designed to be safe against the explosion of two torpedoes in any position, and sufficient stability was provided in each case to ensure the vessel not capsizing from loss of stability due to the flooding of compartments. Two battleships, the *Audacious* and *Marlborough*, and one cruiser, the *Inflexible*, were seriously damaged by torpedoes or mines; the *Marlborough* was able to fight on and arrived in the Humber 37 hours after she had been torpedoed. The repairs necessary were subsequently speedily effected.

Sir Eustace Tennyson D'Eyncourt, the present Director of Naval Construction, stated that the *Marlborough* was the only battleship of the past dreadnoughts that was torpedoed during the war, and the value of the longitudinal bulkheads and the subdivision and arrangements adopted was clearly shown, as the ship was able to remain in the line, no vital damage being done. Sir Eustace also mentioned that vessels of the "Royal Sovereign" class were provided with good under-water protection, which in certain of the ships was reinforced by adding outside bulges. These bulges were originally fitted in the "Edgar" Class, after considerable experiments had been made. He further stated that results had proved the efficiency of the bulges.

Sir Philip Watts, in the discussion on this paper, whilst approving of the addition of bulges for ships actually built, submitted that there was no advantage in providing such bulges in the design for the new ships, but asked the question: "What is the shape and construction which provided most protection against torpedo attack?" He pointed out that a torpedo may run at the surface or at any depth below the surface; if it could be compelled to run so as to hit near the ridge of the bulge, the bulge would be justified, whereas if it hits below this ridge the forces of the explosion would be directed inwards by the upper plating of the bulge against the vitals of the ship instead of being allowed to escape upwards. The internal protection seems to be about the same in the two cases. As to form alone he concluded that there was no advantage in the bulge-shaped side over the ordinary side. He pointed out that in the bulge-sided ship it was very difficult to adopt any means to prevent a torpedo from exploding before it reached the side of the ship. Sir Eustace d'Eyncourt, in reply, stated that the bulges had proved successful in resisting the attack of torpedoes. In the old ships the bulge formed a complete protection, and when the bulges were hit by torpedoes some of the hits were near the top and some near the bottom, and some at the centre of the bulge. In all cases adequate protection was given. The bulge, too, keeps the protective structure external to the ship proper; gases due to the explosion are vented in the air immediately above the bulge.

Sir Eustace d'Eyncourt, in his paper in 1920, read at the meeting of the Institution of Naval Architects, on H. M. S. *Hood*, stated that the torpedo protection consists of the bulge arrangement with an outer compartment of air and an inner one especially strengthened with the bulkheads, which renders the ship safe from attack against torpedoes under the water as she is against gun attack above water, and that the bulge fitted to the *Hood* was different to that fitted to the earlier ships, as proved by a series of experiments by Professor Hopkinson. He also stated that trials have shown that the *Hood* can receive the blows of several torpedoes and still remain in the line without serious loss of speed. Sir Philip Watts, in discussing this paper, said that the Hopkinson device

was proposed by Lord Kelvin in the Warship Design Committee of 1905, but Lord Fisher considered the weight prohibitive. Two longitudinal bulkheads between the outer side and the bulkheads were effective, provided air spaces were fitted between them to be filled with water to take up the forces of the explosion, the bulkhead adjoining the machinery spaces having protective plating for stopping the fragments driven in by the explosion. The *Hood* was made of sufficient beam to have the wing spaces wide enough for sufficient protection.

Sir Philip Watts thought that the structural arrangements of the wing spaces in the dreadnoughts were practically the same as in the *Hood*, though not so wide. Between the outside plating of the bulge and the side plating of the machinery compartments there are two longitudinal bulkheads, the space between them being as in the dreadnoughts. The only structural difference was the longitudinal hollow along the *Hood's* side near the water line, on account of which the part below is called a bulge, and the two longitudinal bulkheads are not quite vertical. He further stated that the bulge is not an additional structure. It is a part of the whole as existing in all other dreadnoughts; the bulge does not take the place of a torpedo net. He suggested the use of plate shields outside the hull, which would destroy the torpedo before it reached the ship; these shields could be instantly got rid of if desired, but could only be conveniently stowed and carried on a ship without bulges. Sir Eustace d'Eyncourt replied that the explosion on a ship with a bulge takes place outside and does not destroy the stringer and sheer strake, which is a distinct point gained. The bulge is free from the disadvantage of a shield, which seriously reduces the speed and is difficult to handle. Sir Philip again returned to the question at this year's meeting of the Institution of Naval Architects, in discussing Sir Eustace d'Eyncourt's paper on German battleships.

It will be seen, therefore, that there is a distinct issue between the present and the earlier Director of Naval Construction as to the value of bulges. The actual amount of material used for protection against torpedo attack seems to be very little different in the case of the *Hood* and the *Queen Elizabeth*; the former having a bulge and the latter vertical sides. There is no doubt that the outside of the bulge is farther away from the vitals of the ship in the case of the *Hood* than in the *Queen Elizabeth*, but in order to obtain this the ship has to be made much broader. This advantage of the *Hood* over the *Queen Elizabeth* is not due to the bulge, but to the extreme beam of the ship. A recent correspondent to *The Times* has pointed out that the *Baden*, the German battleship which Sir Eustace was comparing to the *Royal Sovereign*, was 10 feet wider, so that it would seem as if the Germans had appreciated the benefit of greater beam, but had availed themselves of it without adopting a bulge form of construction. There is no doubt that the German ships withstood a great deal of damage without sinking, and that they were attacked by both guns and torpedoes very severely.

Sir Philip Watts and Sir Westcott Abell have recently contributed to this discussion in *The Times*, and both have called attention to the necessity for the provision of sufficient beam to ensure adequate stability should the side protection be defeated, and both are of opinion that the best way to ensure this stability as well as to obtain the protection by the best available construction of the side is a matter which deserves the most careful consideration. Sir John Biles has also contributed to *The Times* discussion without entering into the relative merits of the bulge or vertical side. He has followed up the views expressed by him at the Institution of Naval Architects, and has reminded the authorities "That a policy of secrecy adopted deliberately to avoid criticism is likely to be harmful to the country and to the science of naval design as well as those who practice it," and he urges that the design of the new British



capital ships may well be referred to a suitable committee for consideration, to the satisfaction of all concerned.

From the summary we have given above of the views of the present and late Directors of Naval Construction it will be seen that nearly all that can be said for and against the bulges in public discussion has been said and it is not easy without more detailed information, such as could be placed before a competent committee, to reach any reliable conclusion. The bulges undoubtedly were a satisfactory way of adding to the stability of existing ships, whose stability was deficient. The bulges also keep the point at which the torpedo exploded further away from the vitals of the ship. Whether this is the best way to give the ship the necessary stability and protection seems to us to be sufficiently in dispute to necessitate a thorough investigation of the question by a competent and independent committee. The protection of our battleships from torpedo attack is of vital importance so long as we rely on these battleships for our naval defence. Sir Philip Watts thinks that we should go farther than we have done and that portable shields should be carried. Undoubtedly, if they can be successfully carried they will afford another and a powerful line of defence. The matter is bristling with intricate technicalities, but no harm can be done by, and good is likely to follow, a thorough investigation. Without doubt such an investigation can only be made by considering the whole designs of our recent battleships, and a committee which could do this would have to be similar in character to Lord Dufferin's Committee of 1870 and Lord Fisher's of 1905 on Warship Design.—*Engineering*, May 20, 1921.

**THE NEW SHIPBUILDING PROGRAMME.**—The strategical principles underlying the Admiralty's post-war shipbuilding policy have not been disclosed, nor, according to information which is current in Parliamentary circles, is any statement on this subject likely to be made till after the Imperial Conference. It may, however, be assumed that in drafting their new programme the professional heads of the navy have taken fully into consideration the complete change brought about in the strategical outlook by the collapse of German naval power. Seven years ago the problem of naval defence was a comparatively simple one. Its solution lay in preserving an ample margin of strength in the North Sea, for, as was clearly foreseen, it was there that the only real challenge would have to be met. The strength and composition of our foreign squadrons were a matter of secondary importance. Once the German High Sea Fleet had been accounted for, either by destroying it in battle or hermetically sealing it up in its ports, the safety of British trade and oversea territories would be practically assured, for without coaling stations or base facilities abroad the German cruisers at large could only reckon on a very brief career. On the other hand, a failure to destroy or contain the German battle fleet in the North Sea would inevitably have the most disastrous effects on the sea campaign as a whole. Such was the idea that dictated our general policy before the war, and experience proved it to have been thoroughly sound. Later on the development of the submarine menace necessitated a considerable readjustment of our dispositions, but, broadly speaking, it had no effect on our strategy in the main area. To the very end of the war the Grand Fleet's command of the North Sea remained the dominant factor in the naval situation.

The influence formerly exerted by Germany on British naval policy was not confined to the distribution of the fleet. It had a very marked effect on the design of our warships. While there was never any radical departure from the traditional rule that British men-of-war should be built to go everywhere and do anything, it is certain that the dimensions, armament, and other characteristics of the vessels we built from 1905 onward were largely governed by the trend of contemporary German design. Our aim

then was always to go one better in what were believed to be the vital elements of tactical efficiency, and as a consequence we gave our ships heavier guns and greater speed than the German ships possessed. If less attention was paid to defensive qualities it was because the importance of this feature was not realized. On the whole, however, the purpose in view was achieved. The problem that now confronts the Admiralty is infinitely more perplexing. No one can foretell the future battle ground of the British Navy, and the subject is scarcely one that lends itself to public discussion. Nevertheless, there is a widely-held belief that if the navy is called upon to fight in the next ten years or so it will be in waters many thousands of miles distant from the shores of England. This conviction is apparently shared by the Admiralty, who are well aware that our present fleet is quite strong enough in ships of every type to ensure its indisputable predominance in European waters for many years ahead. If therefore, they have recommended the building of four capital ships to replace obsolete material, it is manifestly with a view to contingencies other than those of a conflict in Europe.

By this chain of reasoning we arrive at the conclusion that our new capital ships have probably been designed for a very extended radius of action. It is said that the proposal to station a powerful fleet in the Pacific has been rejected for a variety of reasons, among them being the dearth of local resources for docking and otherwise maintaining a numerous force of ships of the largest dimensions. If this is the case, and our future battle fleet is to be based on home ports, the importance of endowing the new ships with high speed is evident, for they must be capable of proceeding with the utmost expedition to any part of the world where our interests are threatened. Great cruising endurance and high speed may therefore be accepted as two probable elements in the plans of the "improved *Hoods*." Their armament and protection have doubtless been designed to embody the lessons of the war. As we have said before, the magnitude of the sum at stake entitles the public to an explanation—not necessarily technical or detailed—of the grounds on which the sub-committee presided over by Mr. Bonar Law decided in favor of perpetuating capital ships of the largest dimensions.—*The Naval and Military Record*, May 4, 1921.

**THE FUNCTIONS OF NAVAL AIRCRAFT.**—A rooted conviction as to the present supremacy of the capital ship affords no reason for neglecting to study the development, present and prospective, of other agencies of sea warfare whose past achievements have been such as to entitle them to rank as effective and formidable weapons. It is a highly-significant circumstance that many students who were until lately ardent advocates of the submarine should now be transferring their allegiance to aircraft. This is not surprising in view of the rapid evolution of the heavier-than-air machine, whose progress in the past few years has been incomparably greater than that of the submarine. We know that British naval officers, as a body, are far more anxious about our future in the air than about the menace of the submarine. In the case of the latter familiarity has bred not contempt, but knowledge of its limitations, which, being inherent and ineradicable, disqualify it for the position of arbiter of future naval combats. The submarine will always be dangerous, especially to a nation which is largely dependent on seaborne commerce; but it is a danger that experience has shown us how to counter. With air power the case is different. The boldest imagination cannot discern any limit to its military possibilities. It remains for the time being an auxiliary arm to navies and armies alike, but an auxiliary which has already made itself indispensable; and should its development continue at the pace which has been maintained since 1914, it will undoubtedly supersede at no remote period more than one of the instruments of land and sea warfare which now rank above it in point of supposed importance. Whether air power will ever transcend sea power

is a question which time alone can answer. What is already apparent is that sea power and air power are rapidly becoming complementary and interdependent and may soon be unable to exist apart. That is why a far-sighted and vigorous air policy is so essential to a great maritime community like the British Empire.

The public mind is somewhat hazy as to the precise functions of aircraft in the naval organization, and, indeed, it is not easy to define them off-hand. One of the clearest exposés we have seen is that given by a naval aviator in "Flying" (an American periodical.) He enumerates in the following order the principal duties that fall to aircraft working with the fleet in war-time. (1) Bombing enemy battleships and bases, and attack with torpedoplane; (2) protection of our own fleet from hostile aircraft; (3) scouting; (4) reporting on movements of enemy over smoke screens, in low visibility, and over the horizon; (5) detecting minefields, torpedoes, and submarines; (6) spotting; (7) escort. As regards the first, he holds that all offensive actions must be undertaken by heavier-than-air craft until a practical non-inflammable gas is in use for airships. In the late war offensive action against surface craft was of negligible value, owing to lack of opportunity, small size of bombs, indifferent bomb sights, untrained bombs, insufficient numbers of planes and material, and backward state of aerial strategy and tactics. Nevertheless, good work was done. Two German destroyers were sunk by 230lb. bombs, and towards the end Zebrugge was attacked with 1650lb. bombs, loaded with 1100lb. of T. N. T. He considers that all daylight bombing should be formation work and guided by the principle of concentration. As with projectiles, bombs must be suited to their objectives, and the 3,300-pounders that were being experimented with when the armistice was signed would be particularly effective against capital ships and concrete defences. Smaller varieties could be used with advantage against light cruisers, destroyers, etc., while light bombs with good fragmentation would be most deadly against personnel. "With the accuracy of our new sights and the application of proper tactics and material, the importance of the future of bombing cannot be overestimated."

After explaining in some detail the use of aircraft as protectors of their own fleet, as scouts, and as detectors of submerged perils, he goes on to deal with their value as an aid to accurate long-range gunnery. Towards the close of the war the Grand Fleet, practising long-range shooting by means of aerial spotters, obtained by this means a standard of efficiency at least 300 per cent higher than from masthead spotting. It is not believed, he says, that spotting from the ship can be accurate at over 18,000 yards, whereas aircraft spotting is efficient up to the maximum range of the gun, and is not affected by smoke screens. Airships are best for this work, but their utility is circumscribed by dependence on weather conditions. As for the future of the torpedoplane, the capabilities of this weapon have been set forth by Mr. R. Blackburn, the well-known British designer, who has specialized in the production of such craft. In his judgment surprise can rarely enter into a torpedo attack by surface vessels, for the approach of a destroyer would be observed in clear weather at least ten minutes before it came within torpedo range; whereas "torpedoplanes flying at upwards of 10,000ft. can begin to glide with engine shut off, and therefore silently, some ten miles away, remaining invisible until within three or four miles, and probably undetected until much closer. Gliding at, say, 120 knots, it is unlikely they would be seen more than a minute before launching a torpedo at close range." The foregoing extracts, which do little more than touch the fringe of the subject, yet suffice to indicate the vast field of activity that will lie open to naval aircraft in a future war, and also to create misgiving as to the wisdom of entrusting the development of air-power to a department in which army influence is paramount.—*The Naval and Military Record*, April 6, 1921.

A SUPER-DREADNOUGHT AS TARGET.—*The Latest German Battleship "Baden" Sunk by Gunfire and Torpedo.*—Early in February the ex-

German battleship *Baden*, which was among the former enemy ships allocated to Great Britain, was towed from Portsmouth to Spithead and there subjected to attack by gunfire and torpedoes. According to a semi-official statement issued on February 9, "the *Baden* was subjected to short-range firing in the presence of gunnery experts, and also to aerial torpedo attacks. The object was to test the construction of German battleships and to throw light on the value of capital ships. The ship will be solved for further tests." The photograph reproduced herewith was taken soon after the conclusion of the experiments. As the first occasion on which a really modern war vessel of the largest dimensions has figured as a target ship, this experiment has created great interest in naval circles. The *Baden*, which was laid down in December, 1913, at the yard of F. Schichau, Danzig, and commenced her trials in November, 1916, embodies the latest German ideas on battleship design. The *Baden* is 590 feet long over all, has an extreme beam of 98½ feet, and her displacement at 27 feet 8 inches, 28,074 tons. She represents the latest German ideas in battleship construction.

As regards armor and protective plating, the *Baden* has a main belt 13¾ inches thick, which tapers to 6¾ inches at the lower edge. This is surmounted by a strake of 9⅞ inches armor extending to the upper deck, and the citadel is enclosed by transverse bulkheads. Beyond the main belt there is plating of 6 inches up to the bow and stern. The secondary battery is armored with 6¾-inch plating, the deck above the battery being about 1½ inches thick. Deck protection is less substantial than might have been supposed. The protective deck proper is only 1⅞ inches on the slope, but abaft the citadel this deck increases in strength till it reaches its maximum thickness of 4¾ inches over the steering gear. Forward of the main belt the protective deck is 2⅜ inches thick. The barbettes have a maximum thickness of 13¾ inches, the turrets being 13¾ inches thick at the front, 9⅞ inches at the sides, and from 4 inches to 4¾ inches on the roof. The forward conning-tower is built up of 13¾-inch armor, with a 5⅞-inch roof. The coal bunkers are so arranged that they extend all the way above the protective deck from the foremost to the aftermost barrette, and when filled with coal add considerably to the sum total of protection. Armor gratings of the usual pattern are fitted to all openings in the fore-castle and protective decks. So much for the defense against gunfire.

In the *Baden*, as in every other German warship of modern construction, great pains have been taken to minimize the effect of submerged explosions, an object facilitated by the generous beam of the ship. The principal defense against torpedoes consists of a longitudinal bulkhead which runs throughout the major length of the ship. It has a uniform thickness of 2 inches, and is closed at each end by 1⅞-inch athwartship bulkheads. There is, in addition, a very elaborate system of pumping and flooding, which war experience showed to be more effective than mere passive resistance by means of subdivision. When the ship went into action the commander was posted at a station below deck, where his sole duty was to keep the ship on an even keel. From his central station he could communicate by voice-pipe and telephone with the pumps, sea-cocks, and auxiliary leak-control stations. A pendulum showed him at a glance the exact trim of the ship, while a diagram board indicated the quantity of water which could be admitted to each compartment and the effect which flooding would have on draught, heel, and general trim. The whole ship's company had been thoroughly trained in this work, partly by periodical drill and partly by means of an instructional model, which produced in miniature the subdivision of the hull. Thanks to these careful precautions German ships which received in action injuries of the gravest description were brought safely into port, the *Derfflinger* and *Seydlitz* after the Jutland battle being cases in point.

The *Baden* was armed with eight 15-inch, 45-caliber rifles in four center-line turrets; sixteen 5.9-inch 45 caliber rapid fire guns; eight 3.5-inch 45-caliber anti-aircraft guns, and three 23.6-inch submerged torpedo tubes. An interesting feature of the main armament is the extraordinarily light weight of the 15-inch gun, which weighs only 76.2 tons. On the other hand, the projectile is much lighter than that of the British 15-inch gun, weighing only 1,652 pounds as against 1,930 pounds. Its muzzle velocity is 2,625 feet-seconds, and at 16 degrees (the maximum elevation of which the *Baden's* guns are capable) the extreme range is 22,200 yards. Of the three torpedotubes fitted, the bow tube is horizontal and located 19 feet below the load waterline, while the broadside tubes are depressed two degrees and set at an angle of 20 degrees before the beam, the centers of the tubes intersecting the ship's side at points 13 feet below the load waterline. The torpedoes used in this ship are believed to be the largest extant. Their diameter is 23.6 inches, the length 23 feet, and the total weight 2.16 tons, of which 551 pounds is represented by the bursting charge. Set at a speed of 28 knots these formidable engines have a range exceeding 14,000 yards.

Before being fired at, certain modifications are understood to have been made in the *Baden*, and the foremost turret was removed. Few authentic details of the bombardment are available, but it is known that the vessel succumbed far more quickly than had been expected. According to statements published in the press, the firing ship was the old monitor *Lord Clive*, which during the war carried a pair of ancient 12-inch guns and, subsequently, a single 18-inch gun, with which she shelled the German positions at Zeebrugge. For the *Baden* experiment the *Lord Clive* was fitted with a triple 15-inch gun mount, the first mount of this kind to be used in the British Navy. It is reported to be in contemplation for the four new battleships of the current shipbuilding program, which may therefore mount ten 15-inch guns in two triple and two double turrets, arranged as in the U. S. S. *Oklahoma*; or, possibly, twelve 15-inch guns in four triple turrets, corresponding to the arrangement of the U. S. S. *Indiana*. On this point, however, there is no definite information, and it is by no means certain that the designs of the new type have been finally approved. Nevertheless, the fact that a triple mount for heavy guns has been made and experimented with marks, a distinct epoch in the development of British naval ordnance and indicates the belated adoption of a system which has long been in vogue in the navies of the United States, Italy, Austria and Russia.

Although the *Baden* was shelled at short range, the velocity of the projectiles is believed to have corresponded to a range of about 10,000 yards. The effect was surprising in view of all that has been heard about the super-excellence of Krupp cemented armor plate made at Essen. Round after round cleanly perforated the 13¾-inch belt, and in some cases projectiles impinging at an oblique angle punched their way right through the thickest armor. Under this heavy punishment the great battleship soon displayed signs of distress. Water entering through the numerous shell holes 'twixt wind and water gave her a heavy list to starboard, and long before the specified number of rounds had been fired she heeled gently over and sank, coming to rest on the shallow bottom with most of her hull above water. It is not quite certain whether the torpedo-planes which had been detailed to administer the coup de grâce made their attack before or after the bombardment, but in any case one or more torpedoes were dropped from the air and are said to have found the target. Sir E. T. d'Eyncourt, the Director of Naval Construction, has stated that the *Baden's* armor showed a degree of resistance considerably inferior to that of British armor of the same dimensions. A further point demonstrated by the test was the great improvement which has been made in the quality of British armor-piercing shell since the Battle of Jutland.

In that action, according to Lord Jellicoe, many shells broke up on striking the thick German armor, though there is photographic evidence that a large percentage got through and exploded with terrific effect inside the ships. Views have been published showing clean perforations of the 12-inch belt and barbette armor of the *Seydlitz*, *Derfflinger*, etc., and Commander von Hase, gunnery officer of the *Derfflinger* at Jutland, has admitted in his book, "The Two White Nations," that the two after turrets of his ship were totally wrecked in succession by direct penetrations from British 15-inch projectiles which exploded after passing through the barbette armor.

Interesting as these *Baden* experiments have doubtless been, they will be surpassed in educational value by the test which is to be made this summer with the British battleship *Agamemnon*. This old ship, of a type intermediate between the pre-dreadnought and the dreadnought, is now being equipped as a movable target under wireless control, and will be attacked by the guns of the Atlantic fleet. The speed and course of the target will be unknown to the firing ships, and as the practice is to be at considerable range the experiment should result in valuable evidence as to the present efficiency of the British fleet at long distance firing.—*The Scientific American*, May 21, 1921.

## JAPAN

AMERICA AND THE ANGLO-JAPANESE ALLIANCE.—No greater menace to the British Empire could be imagined than that England should find America arrayed against her with the British Dominions at America's back, and yet this peril is "implied in possibilities" of the Anglo-Japanese alliance. Such is the somber presentiment of some British observers, and it is in no way brightened by various official and unofficial utterances in Canada, Australia, and New Zealand to the effect that the chance of the dominions ever fighting against America, should America become embroiled with Japan, is "so remote as to be scarcely conceivable." The whole question of the alliance is to be threshed out at the coming Imperial Conference in London, we are told, when the dominions are expected to "speak out in meeting," with a voice that was trained in the World War, on other questions besides the alliance. But on the latter subject there is intense concern in some quarters, as may be gathered from the avowal of the conservative London *Spectator* that "an alliance between England and Japan was never meant and never could be used against America," but until now "we have left the most important argument on our side unstated," and this weekly continues:

"Even the most widely imperialistic and aggressive of Britons do not contemplate with pleasure the blowing of the British Empire into smithereens in a single instant. We all know perfectly well this would be the result if we went to war against America, not to support some rights of our own, but in order to help the Japanese. The moment such a war was declared the bonds that united us with our dominions would be severed.

"If the people of Australia and New Zealand were asked on which side they were going to be in a war between America and Japan they would not hesitate a second. They would not waste time in reading diplomatic papers or considering legal points. They would say:

"With our own flesh and blood! If the poor old mother country has gone mad we can not help it. We are deeply sorry, but if things have come to this pass we must reluctantly take the leadership of her elder daughter rather than herself. Help the Japanese to take San Francisco by assault! Good heavens! what are you talking about?"

"The same dreadful message of disintegration would run from one end of Canada to the other with similar vehemence. There could be only one place for Canada in a finish fight between Japan and America—by the side of America.

"White South-Africans would have the same answer. Nor would that be all. The moment they realized what had happened 99 per cent of the

population here would be stoning their own government for the criminal lunacy of backing Japan against their own flesh and blood."

*The Spectator* goes on to say that one of the reasons for continuing the alliance with Japan has been to keep peace and to be able to calm Japan's population should it become excited on "a point of honor." Also, it suggests two possible British proposals to the United States, although it admits they would be "furiously denounced by thousands of so-called naval experts in America and in England," and explains:

"The first of these would be to make our position absolutely clear to the whole American people and also to the people of our own empire, declaring we would not renew the Japanese alliance, although, of course, we would remain in perfect amity with Japan. Next, we should propose a naval convention with the United States. We should say to America: 'You shall take over command of the sea throughout the Pacific and carry on the policing of it. Just as you will be answerable for the Pacific, so we will have command of the sea in the Atlantic, which means not only all the northern waters of Europe and the Mediterranean, but also the waters encompassing the western and southern coasts of Africa.'"

But this view is founded on misrepresentation and misunderstanding of the alliance, declares the Auckland *Weekly News*, which cites as a piece of misrepresentation the arguments of American Anglophobes that "if the United States became involved in war with Japan on a Far-Eastern question Britain would be bound to enter the struggle." This is not so, flatly declares this weekly, which explains that—

"British statesmen have been careful to exclude a possibility which would do so much violence to British sentiment and instincts. In 1911 the following new clause was introduced into the treaty: 'Should either high contracting party conclude a treaty of general arbitration with a third Power, nothing in the agreement shall entail upon such contracting party any obligation to go to war with the power with whom such treaty of arbitration is in force.'"

Melbourne dispatches report the Australian Premier, Mr. William M. Hughes, as saying in concluding a debate in the House of Representatives on the coming Imperial Conference, that "the chief problem before Great Britain is to draw up a treaty which will not involve us or Britain in a struggle with the people of the United States." What is more, the Premier averred that—

- "The hope of the world depends upon some sort of an understanding between America and the empire, and it is to find a way of realizing that hope that the minds of those attending the Imperial Conference should be directed.

"It is unthinkable and not within the bounds of possibility that we should ever take part in a struggle against America. We can not be bound by any treaty which we do not ourselves ratify, although the practical consequences of war between Britain and America, whether Japan was or was not her ally, would of course have to be faced by us. But even if this treaty be renewed it will not bind Australia to go to war with any country in the world."

As an indication of Canadian sentiment we have the unreserved declaration of the Kingston *Standard* that—

"It is unthinkable that, in the event of war between Japan and the United States, Canada would ever be found ranged on the side of Japan, even though the proposed renewal of the treaty between Japan and Great Britain should be consummated. Canada has nothing whatever in common with Japan; she has, on the other hand, much in common with the United States, since in effect we are one and the same people, speaking the same language, living side by side at peace for over a hundred years, and with like ideals, aspirations, and high resolves."

But the Montreal *Daily Star* derides "those Americans who hope that Canada and Australia can be split away from the British Empire on the

Japanese issue," because the Anglo-Japanese alliance is "a larger question than our own irremovable feeling against Asiatic immigration," and it adds:

"The men in Great Britain who have guarded the confines of the empire successfully through the centuries have other things to consider, and they may feel that an alliance with the strongest Power to-day in Asia—if not in the entire Old World—is an asset in these unsettled times which is not to be tossed light-heartedly over the shoulder because the American people can misunderstand it if they insist upon doing so. For they can only regard the Anglo-Japanese alliance as anti-American by deliberately reading all the documents in the case in the contrary sense.

"Suppose Britain refused to renew the Japanese alliance? It would be almost impossible to prevent that action from falling upon the sensitive Japanese cheek like a blow. Japan would be roughly hustled out of the circle of British friends. Where would she go? Does she look to you like a Power which would stand alone and patiently accept the bitter wages of isolation? Or do you not imagine that she might turn up as the protector of Soviet Russia, possibly the champion and beneficiary of the effort of the Soviets to rouse China and India, the spear-head of an Asiatic 'Monroe' movement, and ultimately, perhaps, the nurse and emancipator of Germany."

In sharp contrast is the attitude of the *Toronto Mail and Empire*, which wonders whether the alliance "has not served its turn and had its day." The Far-Eastern question has been changed by the war, according to this daily, which proceeds:

"Japan's alliance has not proved serviceable to Britain in preventing the spread of Soviet Russia's power in Asia Minor, in Persia, and in Afghanistan. For dealing with the new world questions that are looming up the Great Powers should study to avoid unnecessary commitments and entangling alliances. It is recognized more than in previous times that much that formerly fell to what were called coalitions, concerts, and holy alliances can now be left to a permanent grand international agency such as the League of Nations is meant to be."

Among the Japanese press the Tokyo *Nichi-nichi* is aware that the public opinion of Canada, South Africa, Australia, and New Zealand is inclined to oppose the renewal of the Anglo-Japanese alliance, and it bids Japan take due note of this tendency. Moreover, American opinion "takes the line that as a practical issue it is unthinkable that the American Navy should be restricted while the Anglo-Japanese alliance continue to exist," and the *Nichi-nichi* remarks:

"It is general knowledge that the alliance was concluded with the object of maintaining peace in the Orient and consequently of preserving the peace of the world. Yet we find the opinion expressed that the Anglo-Japanese alliance is an obstacle in the way of disarmament, an arrangement designed to promote the peace and prosperity of the world. It is open to doubt whether the existence of the alliance is an obstacle to disarmament, but it is very clear that it is not desirable that such misgivings should be entertained by America, a country with which we are on friendly terms. This is especially the case as the influences which were considered subversive of the peace of the Orient at the time the alliance was concluded have now collapsed."

Those Americans who oppose the renewal of the alliance, says the Tokyo *Yorodsu*, fail to perceive that it is "necessary for the maintenance of peace in the Orient, and makes the functions of the League of Nations more effective locally," hence, "it is impossible for us to see what are the real intentions of the opponents of the alliance."

The Australian Premier's pronouncement, which is quoted above, was submitted to Baron Hayashi, Japan's Ambassador at London, by a representative of the London *Times*, who records the Ambassador's impressions as follows:



"Such a clear expression of opinion could not fail, he thought, to have good results. He had no doubt that it would be welcomed in Japan, where there was a desire to meet the wishes of Australia, Canada, and the United States. Co-operation was the aim of all parties, and he felt sure that in any renewal of the alliance between Japan and Great Britain there would be nothing to which the United States could take exception. It was absolutely necessary for Japan that she should possess the friendship of the United States. The Ambassador went on to say that he was convinced that in good time Australians would come to realize that Japan entertained no aggressive or mischievous designs. Her one idea was to cultivate friendly relations.

"Turning to the question of naval armaments, Baron Hayashi said that Japan had no desire to possess a fleet which was larger than she deemed necessary to maintain her interests and defend her possessions. So long as the Anglo-Japanese alliance lasted Japan was bound to remain on friendly terms with all the dominions, and it was not the wish of the Japanese that any other situation should arise."—*The Literary Digest*, May 21, 1921.

RECENT NOTES ON JAPAN.—The outstanding feature of prevailing conditions in Japan at the present time is the protracted struggle for power between the militarists and the liberals.

While this struggle is an inevitable concomitant of all monarchical forms of government, it naturally reaches an extreme whenever there is a demand on the part of the people for some evidence of reform leading to self-government. Japan represents the survival of the old ideals of a monarchy wherein the ruling house governs by "divine right," and where the proprietary aristocracy is almost if not quite representative of the traditional superiority of the military class. There still exists among the masses an almost superstitious reverence for the *samurai*.

There are in Japan far-seeing and experienced political leaders who with the commercial and industrial circles of the country, are engaged in an effort to institute needed reforms consistent with a growing tendency to world democracy, and to develop the industrial resources of the country by peaceful methods. In these efforts they are constantly balked by the intercession of the militarist leaders, who have their own ideas as to what sort of reforms are desirable.

The power of the military party being deeply rooted in the ideals of the Japanese people, the more progressive leaders of public opinion make little progress.

The Minister of War and Minister of the Navy are *ex officio* members of the Ministry—members of the legislative chambers having no influence over them. This fact constitutes the bulwark of the power of the military party, which power was greatly increased by allied intervention in Russian affairs because it forced the necessity of maintaining Japanese troops in Siberia and gave the reins of government into the hands of the militarists.

National pride compelled the payment to these expeditionary forces of a wage nearly equivalent to that paid by the Allies to their troops.

The rank and file of the people of Japan proverbially are trained to habits of extreme frugality, to the strictest self-sacrifice and restraint, and thus the men of these troops were enabled to send back to their relatives at home the greater part of their wages to be invested in small business—characteristic of Japanese industrial ideas and representing a degree of affluence from the Japanese point of view.

An almost unprecedented period of prosperity self-evidently brought about by a reign of militarism resulted in a wave of popular support of the military party, the masses being led to hope that their success would continue if the military party were kept in power.

Thus the leaders of the military party were faced with the necessity of supplying some excuse for maintaining the troops in Siberia—an excuse which only the continued intervention of the Allies could warrant.

In this way the question of intervention in Siberia has become for Japan a question of home politics rather than of foreign policy.

The absence of any power in the Far East comparable with Japan forced the leaders of the military party to seek afar for something that might justify increased appropriation for military and naval purposes without which the life of the military party would be at an end. The act of the California legislature has given a plausible excuse to raise a hue and cry about Japan having her hands free in Far East questions. The results of the Vanderlip concession have had a similar effect, notwithstanding the fact that Japan has identically the same concession in the name of Mr. Nasamura, well-known industrial magnate of Yokohama and member of the Diet.

"Competition with America in the Far East" is the slogan of the military party, while co-operation with America is not only the dream of all far-seeing financial and industrial leaders of Japan, but also the solution of the internal strife—the struggle between the two parties. With such co-operation assured, all danger from other conflicting interests in the Far East would be at an end. It is for America to decide the future.

The Japanese Navy may be estimated as follows:

*Effective Force:*

*Old Type:* Cruisers 4; battleships of pre-dreadnought type 7; light cruisers 7; destroyers 70; submarines 20.

*New Type:* Dreadnoughts 4; cruisers—dreadnoughts 8; light cruisers 34; destroyers 77; submarines 80.

*In construction:* Dreadnoughts 11; cruiser-dreadnoughts 8; light cruisers 41; destroyers 147; submarines 100.

The first condition of naval strength is fuel; oil as fuel increases naval efficiency in battle because it permits of a longer period of action without refueling. It also increases speed because of homogeneous and modern conditions of firing.

Therefore, the fuel question is the most formidable of the problems now facing the Japanese Navy. Japan has no sufficient source of oil supply outside of America. Recently two limited companies were created with the assistance of the government for the purpose of acquiring the necessary quantities of oil and to build tanks for its safe storage in different parts of the country.

In accordance with the lessons learned during the late war, reorganization of the army on a new basis is proceeding.

Brigades are to be abolished. The plan is to create divisions consisting each of three regiments. In accordance with the reorganization project, Japan will have in the near future 32 army divisions and 1 guard division.

On the 1st of January, 1921, the gold reserve was 2,183,000,000 yen. From this stock 884,000,000 yen were at the disposal of the government and 1,294,000,000 yen were in the Japan State Bank.

Export trade for the year 1920 amounted to the sum of 1,928,864 yen; import to 2,320,712,000 yen. In 1919 the export trade amounted to 2,098,872,617 yen and the import to 2,173,459,880 yen.

The decrease in exports is partly explained by the interference of the government in the domain of commerce; so the government has vetoed the falling down of prices for some export articles, as for instance, raw silk.

It is interesting to note that the amount of exports from the port of Yokohama for 1920 fell to 25 per cent below that of 1918.

The total expense amounted to 1,562,542,797 yen. Of this sum, 183,290,831 yen is designated as "ordinary military expense," and 144,811,078 yen as naval expense.

For extraordinary military expense a sum of 79,853,871 yen is provided, and for that of the navy a sum of 358,826,000 yen. These expenses are in excess of those of the previous year by 227, 187, 480 yen.

The government is planning the construction of new railways and the building of central stores for rice, as a means of decreasing unemployment. As we go to press, reports are current in the daily papers that the Japanese Government has requested from the Diet an additional appropriation for defenses, amounting to 50,000,000 yen, 40,000,000 yen of this sum being required for the navy "to meet the increased cost of construction of warships."—*National Service*, April, 1921.

**JAPAN'S NAVAL EFFORT.**—Since Japan does not unduly advertise her armaments, the extraordinary efforts she is now making to strengthen her position as a naval and military power are not fully appreciated abroad. It is certainly not common knowledge that Japan, in the current year, is devoting no less than 48.7 per cent of her total revenue to the navy and army. Naval armaments alone represent an expenditure equal to 32 per cent of the entire Budget. An analysis of this expenditure reveals the interesting fact that 55 per cent of the money voted for the navy goes toward new construction. The Philadelphia *Public Ledger* prints a table showing the proportion of national income which the three leading naval powers are at present spending on new naval construction, as distinct from other branches of the naval service:

Japan . . . . .	17.5 per cent.
United States . . . . .	1.6 " "
Great Britain . . . . .	1.1 " "

According to the *Public Ledger*, this shows that Japan is putting forth ten times as much effort in naval expansion, in proportion to her national budget, as the United States, and about fifteen times as much as Great Britain. It further shows that since Germany in 1914 set aside 221,000,000 marks, or only 6.2 per cent of her income, for the benefit of her navy, while Japan in 1921-22 proposes to use 32 per cent of her income for the like object, Japan is making a five-fold greater effort in naval expansion than Germany made in the last year before the war. Reducing the German naval estimates of 1914-15 to yen, at the rate of two marks to the yen, the following comparison is obtained:

German naval budget, 1914-15 . . . . .	Yen 110,500,000
Japanese naval budget, 1921-22 . . . . .	Yen 490,000,000

Making allowance for the depreciation in money values since 1914, and assuming five yen in 1921 to be equal in purchasing power to two yen in 1914, Japan, it appears, is still spending about twice as much on her navy as Germany proposed to spend in 1914-15. These figures undoubtedly offer food for thought. The *Ledger*, however, goes on to argue that when Japan has completed the present program her navy will be approximately equal in strength to that of the United States. This assertion is open to dispute. Reckoning dreadnought capital ships only, America has completed 19, and is building 16—a total of 35; Japan has completed 12 (including two "semi-dreadnoughts"), and is building, or about to build, 15—a total of 27. The Japanese total, moreover, will not be attained before 1928, and it is not improbable that long before that date America will have laid down additional ships. The really significant fact is the tremendous proportion of her revenue which Japan deems it necessary to set aside for naval armaments. Her statesmen assure the world that the fleet in process of creation at such appalling cost exists solely for defense, but they do not tell us from what quarter aggression is feared.—*The Naval and Military Record*, May 4, 1921.

**IRON MANUFACTURE AND SHIPBUILDING IN JAPAN.**—The Japanese Special Economic and Financial Investigation Committee adopted at its meeting, held on February 14, under the chairmanship of the Premier, Mr. Hara, the national policy regarding the iron and shipbuilding industries of the

country previously decided on and recommended by the sectional committees. The following is a brief résumé of the policy in question:

It is considered most important to combine the existing ironworkers, while the iron industry should be protected by the imposition of an import duty of 10 per cent on pig iron and 15 per cent on other iron and steel, except that intended for shipbuilding, which may be exempted. Japanese manufacturers should be subsidised for the duration of the conventions to the extent of the difference between the above enhanced duties and the conventional tariff, while those employing Japanese steel for shipbuilding might be subsidised to the extent of a sum equivalent to the import duty on the same kind of steel.

Iron manufacturers should be exempt from payment of business and income taxes for a period of ten years, provided their equipment fulfils the requirements of the Iron Industry Encouragement Law, which should be revived. The electro-iron industry should be similarly protected.

Iron and steel of Japanese make might be employed in most government building works. Due protection should be given for the marine and land transportation of iron ores and iron manufactures. Japanese iron manufactures might be granted special financial facilities, while an ample supply of iron should be insured by the procuring of foreign products, the improvement of transportation methods, their economical employment and the encouragement of domestic production. The technical side of iron manufacturing might be advanced by encouraging the study of the manufacture, the linking up of the laboratories, the training of experts and the standardization of manufactures.

The existing Shipbuilding Encouragement Law is held to be inadequate for the protection of the industry, and it is considered important to exempt from import duties the steel and wood necessary for building and repairing vessels—including warships—in order to place the Japanese shipbuilders on an equal footing with foreign manufacturers; also to exempt from import duties, fittings, engines and other parts, including half-finished vessels, which cannot be manufactured in Japan or may not be manufactured on account of patents.—*The Engineer*, May 6, 1921.

**FLYING INSTRUCTORS.**—Questioned on 23rd March about the reported despatch of a mission of British airmen to join the Japanese Navy, the Secretary of State for Air said it was understood that a certain number of civilians had been engaged by the Japanese as flying instructors, but no mission had been sent by the Royal Air Force, nor had the civilians in question been sent for courses to R. A. F. stations in England. The British Government have neither sold nor sent to Japan any aeroplanes or aero engines, but it is possible that the Aircraft Disposal Company, in which the government have retained an interest, may have sold certain obsolete or surplus engines to that country.

**NAVAL STRENGTH.**—Sir James Craig, on 16th March, gave the following information about the Japanese Navy: Twelve battleships, excluding one attached to the Gunnery School, are at present maintained in full commission, and six battlecruisers, excluding one attached to the Torpedo School. The numbers borne on 19th January, 1921, were 76,600, made up of approximately 7000 officers and 69,600 men, all of whom were available for manning. The corresponding figure in 1914 was 55,712.—*The Journal of the Royal United Service Institution*, May, 1921.

**SHIPS AND SAILORS OF JAPAN.**—By courtesy of the Japanese Naval Attaché and the officers of the ship, I spent a very interesting afternoon last week on board the battleship *Kashima* at Portsmouth. This vessel and her sister, the *Katori* (to which I paid a briefer visit), do not, of course, represent the modern material of the Imperial Japanese Navy; they have already completed three-fourths of the span of "life" allotted to big warships, and,

irrespective of age, they lost a great deal of their fighting value soon after they were completed, owing to the advent of the dreadnought. But "men fight, not ships," and the visit was well worth while for the insight it gave into the character of the personnel and general service conditions in the Japanese Navy. On the naval side there has been an entire absence of ostentation in connection with the visit of the Crown Prince. The voyage was made not in one of the latest and mightiest fighting ships of the Imperial fleet, but in an obsolescent vessel already relegated to the second line, and escort was furnished by a sister ship. Nor in other respects has any attempt been made to create an artificial impression.

I asked a lieutenant of the *Kashima* whether the men had been picked for the voyage, and he replied "No," the ordinary complement already on board had been retained, and this was true of the officers also, excepting certain members of the staff. In the *Katori* a suite of apartments, quite simply furnished, and a special cabin on the shelter-deck were provided for the Crown Prince, but beyond this no alteration of any kind was made in either ship. Having gone practically all through the *Katori*, I came to the conclusion that the Prince's staff must have been rather cramped for room. A pre-dreadnought battleship makes at best an indifferent Royal yacht, but it was, I am assured, the Emperor's particular wish that the entire arrangements for his son's voyage should be characterized by simplicity and lack of display.

The admiral's cabin in the *Kashima* is comfortable, furnished with the exquisite taste that one naturally expects from the Japanese, but by no means luxurious, and the captain's quarters are severely plain. The wardroom is small and somewhat cheerless from our point of view. It is very evident that creature comforts do not enter largely into the Japanese scheme of man-of-war organization. In these two ships space that otherwise would have been available for berthing accommodation has been sacrificed to military efficiency. The 6-inch battery takes up an enormous amount of room, as each gun is in its own large casemate, perfectly isolated, and giving the crew plenty of elbow play. In fact, with the exception of the *Baden*, I know of no ship in which the broadside battery guns are so well protected as in the *Kashima*. On the other hand, the four single 10-inch gun turrets do not seem to be well placed, and probably interfere with the 12-inch main armament. The 10-inch guns are worked hydraulically and the turrets are fairly large, but when the full crew of 19 are inside there cannot be much room to spare. In both ships the officers spoke very highly of the workmanship in the vessels themselves and in their machinery, armament, and general equipment. Said one: "These British-built ships have never given any trouble, and they are as sound to-day as when they were delivered to us. The only change we have made in them was to modify the boilers. But for the new tactical standards set up by the dreadnought these two ships would still be in our first battle fleet. They are, and always have been, very popular ships with us."

The voyage on the whole was favored by fine weather, but heavy seas were encountered near Malta and again in the Bay of Biscay, and on the latter occasion the battleships rolled rather badly, as well they might considering the weight they carry topsides. Few changes have been made in rig or general appearance since the ships left England fifteen years ago, though both underwent big refts during the war. The torpedo nets have been removed, though perhaps only temporarily, as the shelf and the boom fittings remain, and two small Q.F. are now mounted on the crown of each 12-inch turret. Neither ship is fitted for director fire, and the largest rangefinders at present on board are of the 10-foot base type. Very possibly, however, the ordnance equipment in these two ships does not represent the latest Japanese practice, even in the pre-dreadnought squadron.

The mess decks are, if anything, roomier and more comfortable than those in contemporary British battleships. Although the *Kashima* was coaling at the time of my visit, by some miracle the dirt and noise were

localized and did not penetrate unduly to the after part of the ship. The men were putting an extraordinary amount of energy into their work, and if coaling ship is always conducted on the same lines, I shall say that the Japanese Navy easily holds the world's record. Hard work seemed to conduce to cheerfulness, for there were smiling faces everywhere, and all appeared to look upon coaling as a rich joke. Outwardly there was no trace of the iron discipline with which some writers have credited the Japanese Navy. The men, I noticed, were far more self-reliant and far less servile in their bearings towards superiors than was the case in the old German Navy. Orders were given quietly and obeyed with cheerful alacrity. The saluting was most punctilious, not only between officers and ratings, but between the officers themselves. My impression is that the Japanese conception of discipline differs very radically from the Western conception, but that it is wonderfully good, and doubtless well suited to the Japanese temperament. The officers are manifestly absorbed in their profession and exceedingly well-informed on the world's naval affairs. The plain, almost sombre uniform, with the "stripes" in black braid instead of gold, consorts well with their quiet, earnest demeanour, but they soon become vivacious when the talk turns on "shop." They have few relaxations, but one lieutenant confessed to me that his "hobby" was "reading naval war literature," of which he certainly had an imposing stock. A certain British admiral would have liked to hear this officer's quaint but flattering tribute to his book.

Among the men the average of physique was excellent. They are well fed, and the story in one London paper of their "wholesome but rather monotonous diet of rice and beans" is moonshine. They have a generous meat ration at dinner every day, and, as a rule, fish for supper. For recreation they play shuffle-board, quoits, and other deck games, but I was told that wrestling is their favourite pastime. The men's library contained nearly a dozen books in English—including certain popular novels, and several quite passable English scholars were pointed out to me. If these men of the *Kashima* are typical there is nothing wrong with the Japanese lower-deck personnel. Indeed, one might say of the *Katori* and *Kashima*, their officers and their men, that if the rest of the Japanese Navy is "up to sample" the honor of Japan is safe in the keeping of her seamen.—*The Naval and Military Record*, May 25, 1921.

## UNITED STATES

**LAUNCH OF SUBMARINE "S-48."**—The U. S. submarine *S-48*, launched on February 26 at the works of the Lake Torpedo Co., Bridgeport, Conn., is the first of the ten vessels of the *S-42* to *S-51* group to be launched, and is about 75 per cent completed. The displacement is about 993 tons, and the vessels are 240 feet in length overall; beam, 21 feet 6 inches; draft, about 13 feet 6 inches in normal surface condition.

The vessel is of the double hull type for about one-half the length amidships, the forward and after portions of the hull being of the single-hull type. The hull must withstand with safety a submergence test to 200 feet. Particular attention has been given to providing ample strength to ensure against rupture from explosion of depth charges. Strong bulkheads divide internal spaces into six watertight compartments, so proportioned that the vessel will still float if any one compartment is damaged and flooded.

The vessels are propelled on the surface by two Diesel engines, each driving a screw propeller, rated at 950 brake horsepower each. Submerged, the vessel is driven by two electric motors taking their power from a lead-acid storage battery. These motors also act as electric generators for charging the storage battery, being driven by the Diesel engines when operated on the surface or when at rest with propeller shafts uncoupled. The fuel oil system is of the "floating" type, oil used being automatically replaced by salt water.

**NAVY DEPARTMENT—BUREAU OF CONSTRUCTION AND REPAIR**  
**VESSELS UNDER CONSTRUCTION, UNITED STATES NAVY—DEGREE OF COMPLETION,**  
**AND PROBABLE DATES OF COMPLETION, AS REPORTED MAY 31, 1921**

Type, number and name	Contractor	Per cent of completion			
		June 1, 1921		May 1, 1921	
		Total	On ship	Total	On ship
<i><b>Rattleships (BB)</b></i>					
44 California.....	Mare Island Navy Yard.....	97-	97-	96.5	96.3
45 Colorado.....	New York S. B. Cpn.....	73.1	71.3	71.3	69.4
46 Maryland.....	Newport News S. B. & D. D. Co.	99.2	98.9	98.3	97.8
47 Washington.....	New York S. B. Cpn.....	95-	58.5	63.1	56.3
48 West Virginia.....	Newport News S. B. & D. D. Co.	54.1	44.4	52.1	42.4
49 South Dakota.....	New York Navy Yard.....	30.5	22.3	29.1	21.1
50 Indiana.....	New York Navy Yard.....	28-	20.7	25.8	17.8
51 Montana.....	Mare Island Navy Yard.....	24.4	15.2	22.1	13.2
52 North Carolina.....	Norfolk Navy Yard.....	32.3	23.1	29.4	21-
53 Iowa.....	Newport News S. B. & D. D. Co.	23-	19-	19.3	15.4
54 Massachusetts.....	Beth. S. B. Cpn. (Fore River)..	6.4	.9	3-	.5
<i><b>Rattle Cruisers (CC)</b></i>					
1 Lexington.....	Beth. S. B. Cpn. (Fore River)..	18.7	9.2	16.6	6.5
2 Constellation.....	Newport News S. B. & D. D. Co.	10.5	7.7	9.3	6.3
3 Saratoga.....	New York S. B. Cpn.....	22.4	13.4	20.4	11.8
4 Ranger.....	Newport News S. B. & D. D. Co.	1.8	.7	1.6	.9
5 Constitution.....	Philadelphia Navy Yard.....	7.7	4-	6-	2.9
6 United States.....	Philadelphia Navy Yard.....	7.7	4-	6-	2.9
<i><b>Scout Cruisers (Light Cruisers CL)</b></i>					
4 Omaha.....	Todd D. D. & Const. Cpn.....	92.1	83.4	91.4	82.7
5 Milwaukee.....	Todd D. D. & Const. Cpn.....	89.2	80.9	88.3	79.7
*6 Cincinnati.....	Todd D. D. & Const. Cpn.....	81.7	74.1	80.6	68.9
7 Raleigh.....	Beth. S. B. Cpn. (Fore River)..	56.7	38.8	53.8	35.2
8 Detroit.....	Beth. S. B. Cpn. (Fore River)..	56.6	38.7	53.6	35-
9 Richmond.....	Wm. Cramp & Sons Co.....	66-	40-	64-	38-
10 Concord.....	Wm. Cramp & Sons Co.....	63-	37-	62-	36-
11 Trenton.....	Wm. Cramp & Sons Co.....	45-	25-	44-	22-
12 Marblehead.....	Wm. Cramp & Sons Co.....	43-	22-	42-	20-
13 Memphis.....	Wm. Cramp & Sons Co.....	37-	19-	35-	14-
<i><b>Auxiliaries</b></i>					
Fuel Ship No. 18, Pecos.....	Boston Navy Yard (Oiler AO6)	88-	87.5	82.5	81.6
Repair Ship No. 1, Medusa (AR 1).....	Puget Sound Navy Yard.....	62.4	47.7	60.6	44.5
†Dest. Tender No. 3, Dobbin (AD 3).....	Philadelphia Navy Yard.....	62.3	62-	57.3	57-
Dest. Tender No. 4, Whitney (AD 4).....	Boston Navy Yard.....	25-	16.5	21-	12.5
Sub. Tender No. 3, Holland (AS 3).....	Puget Sound Navy Yard.....	17.8	2.5	16.8	1.4
Aircraft Tender, Wright (AZ 1).....	Tictjen & Lang.....	76-	.....	70-	.....
<i><b>Patrol Vessels</b></i>					
Gunboat No. 22, Tulsa (PG 22).	Charleston Navy Yard.....	67.7	48-	64.6	44.7

\*Scout Cruiser (Light Cruiser), No. 6—Launched 5/23/21.

†Destroyer Tender No. 3—Launched 5/5/21.

In addition to the above there are under construction 4 destroyers, 37 submarines, and 4 fleet submarines. Authorized but not under construction or contract 12 destroyers, 7 submarines, and 1 transport.

There were delivered to the Navy Department during May, 1921, 4 destroyers.

The armament consists of four 21-inch torpedo tubes in the bow and one in the stern. A 4-inch 50-caliber gun is installed on the deck forward of the conning tower. Ammunition is served by means of an inclined ammunition hoist with spring actuated cover. Three periscopes are installed, one of which has its eye-piece in the conning tower, but arranged with a platform and trunk to permit the operator to ride up or down with the periscope and take observations at any height. The eye-pieces of the other two are in the control room. The variable ballast tanks are of sufficient capacity to provide for adjustment of weight under all probable conditions. The flooding and venting arrangements are ample, and are designed to permit the vessel to be submerged in approximately one minute. The *S-48* is equipped with radio apparatus, both for surface and submerged work, and with submarine coils for receiving radio messages submerged. Submarine oscillator signalling sets are also provided. Particular attention has been given to providing comfortable quarters for the crew and the inner surfaces of the hull in way of the living spaces have been sheathed with cork. Stowage for a 14-foot boat is provided in the superstructure. (*Army and Navy Journal*, Mar. 5, 1921.)—*The Technical Review*, May 17, 1921.

#### MERCHANT MARINE

GOVERNMENT'S ARMADA OF INACTIVE STEEL SHIPS CROWDS JAMES RIVER.—In the James River opposite Camp Eustis, Va., there are approximately 160 steel Shipping Board vessels tied up in groups of eight, in some places three groups abreast. Most of the ships are of the "Lake" type and have proven unprofitable for operation in the coastwise and West Indian trade in normal times. The groups of ships, which are designated as "units," clutter the river for miles up and down on each side of the pier—quietly floating, orderly islands with sheer black and red steel sides and each with a forest of masts and stacks atop.

The dreamy and peaceful appearance of the scene is belied by the life on the "motherships" of the units. The men work hard aboard the vessels. In the morning they turn to at eight and begin chipping or painting or continuing whatever job is under way until five o'clock, with an hour free at noon. Many evidences of neglect, poor workmanship and graft on the part of the builders are coming to light. Usually they are defects which would be unimportant except in time of extreme danger. Then, however, they are liable to cause loss of life. Whenever it is possible, the crew put things to rights, or report the trouble if they are unable to remedy it. A defect common to many of the ships was the fact that the shackle pins in the anchor chains were "frozen" and could not be moved with a sledge hammer, making it necessary to saw the pin in half to part the chain.

Suppose that a vessel so handicapped is anchored on a lee shore during a gale and another vessel drags down on her. No time to heave up the anchor—the chain must be slipped. The crew set to work to knock the pin out of the shackle, in order to release the chain. They have only a few minutes—no time for sawing. The pin won't move! The other ship is drifting down surely and steadily! They pound it frantically but without success! Too late! The ships collide and both are swept into the surf, to be pounded to pieces. But "dead men tell no tales." On several of the ships, round pins were found forced into oval holes.

The most important and most difficult work falls to the lot of the engineers, and thanks to their activities the vessels in a number of the units will go out in a better condition than that in which they arrived. On one unit, the engineers constructed an electric welding machine and made repairs which, in a shipyard would have cost the Shipping Board many thousands of dollars. The chief concern of the deck force is to see that all the ships are securely fastened together. The vessels lie side



by side, with their bows pointed in opposite directions, so that one vessel points up stream and its neighbor down stream. Each vessel has both bow anchors out nearly to the ends of their chains, so that the average unit has sixteen anchors out, eight on each side. Even that number sometimes fails to hold. One unit dragged a hundred and fifty yards during a squall in March.

The danger of fire is the chief concern of the officers of the units. Inspections of all ships are conducted hourly, both day and night. Lines of fire-hose are stretched across the unit, and spare hose is always ready. Smoking and the use of oil lamps are not allowed on any but the mother-ships. Everything is ready so that if any ship catches fire it can be taken out of the unit in short order. The crew are drilled thoroughly in their fire-duties and everyone is ready for any emergency. So far there have been no serious fires.

There has been much talk of the ship's rotting to pieces and opinions have been expressed that they will be worthless when the time comes to put them in operation again. The general belief of the officers aboard the ships, however, is just the opposite. There is naturally a large depreciation in any laid-up ship, but it is being offset to a considerable extent by the work of the caretaking crews. The captains and engineers are doing their utmost to put the ships in the best condition, although they are somewhat handicapped by lack of men and equipment. In February, all the engineers in the fleet sent a letter to the Shipping Board asking for more skilled engineers and assistants. In support of their request, they declared that the ships would gain in efficiency and that the Shipping Board would save money by enabling these men to make many necessary repairs which otherwise would be done in a shipyard by men whose only interest in the work would be the amount of money they could get out of it. Nothing came of the appeal, however.—*The Nautical Gazette*, May 21, 1921.

WORDS OF WISDOM ON THE SHIPPING PROBLEM.—There is probably no subject, unless it be that of reparations, upon which so much has been said and written and such diverse solutions offered as in respect to the problems of our Shipping Board policy. To our thinking, the best summing up of the situation is that which was made by James A. Farrell at the recent National Foreign Trade Council Convention in Cleveland, Ohio.

Looking at the matter broadly, Mr. Farrell laid his finger at once on one root of the trouble when he said that the present conditions are the outcome of haphazard efforts to deal with a problem which from the very first called for a settled policy and a well-defined purpose. To begin with, for a period extending from the Armistice well into the year 1919, there was an opportunity to dispose of a large portion of the fleet at prices bearing a fair relation to a moderately depreciated cost. That was the time, our readers will remember, when a *bona fide* offer was made to purchase the *Leviathan*, a deal which would have gone through except for the spiteful opposition of the Hearst papers and certain other influences of a strongly anti-European favor. Through not taking advantage of this opportunity, the government, says Mr. Farrell, "missed its market," and, it is estimated, lost a chance to realize at least 800 million dollars, this sum representing the difference in the market value of the tonnage which could have been sold at that time and the value of the same ships to-day. The Shipping Board fleet cost over three billion dollars, and the question of getting rid of these ships by sale is hampered by our perfectly impossible navigation laws. We are told, moreover, that even a temporary improvement in ocean freights would fail to absorb the world's idle tonnage in less than three years. Approximately seven million tons of the world's carrying capacity is laid up out of a total of 60 million tons, of which five million tons is not yet completed.

In Mr. Farrell's opinion, we have to recognize that the policy of the Shipping Board of endeavoring to build up trade routes from every Atlantic, Gulf and Pacific port to practically every port in the world is expensive, and, under present conditions, impracticable. He believes that a partial solution of Shipping Board difficulties would be to lay up a considerable portion of its tonnage and withdraw from all but supervisory activity by chartering the steamers to reputable and experienced operators. With this policy we have always been in hearty agreement. The operation of shipping, with all its multiplied and varied activities and problems, is one of the most highly specialized branches of commerce and industry. It should be left to the genius of the men who have had long experience. The Shipping Board scheme of laying out trade routes and supporting the unprofitable lines by active and very generous financial help is attractive on paper, but, as the event has proved impossible of fulfilment, at least under the present disturbed world conditions.

But after all is said and done, Mr. Farrell lays his hand upon the most serious handicap of all when he says that the main factor in determining whether we can compete successfully with foreign tonnage is our shipping laws. From the very day on which the La Follette bill was passed the *Scientific American* has realized that this bill would be the undoing of our Merchant Marine; and everything that has happened since then has proved the fear to be well founded. Not only do our navigation laws strangle our ocean-going ships, but they are affecting even the carriers on the Great Lakes, where we have no local foreign competition. As compared with competing foreign ships on the high seas, American vessels must maintain larger crews, 65 per cent of whom must be licensed men and they must carry in the engine room crew 30 per cent more men. The solution of the shipping problem lies in chartering the boats to competent people of long experience in the shipping business, coupled with a drastic revision of our navigation laws.—*The Scientific American*, May 21, 1921.

**POLICY OF DISCRIMINATIONS FRAUGHT WITH DANGER TO OUR SHIPPING.**—The advocates of discriminatory tonnage dues and preferential tariff duties on goods imported in American bottoms are not idle, however. They are even proposing the enactment of new legislation calling for the imposition of a ten per cent ad valorem tax on all commodities brought into this country in foreign ships. Not even articles on the free list are to be exempt from this tax. As we have pointed out before, such unequal treatment of foreign shipping would be almost certain to evoke retaliatory measures on the part of other nations and lead to our vessels being discriminated against. The British colonies have had for some time a system of preferential duties in favor of Great Britain and would probably be glad of a pretext to impose discriminatory tonnage dues against American ships.

It is argued that any such retaliatory legislation could be offset by the simple expedient of our again raising our discriminatory charges and keeping them on a higher level than those established by foreign countries. In other words, still higher discriminations are to be imposed against nations which may rebel against the enforcement of the discriminatory clauses of the Jones Act. We should then be in the illogical position of deeming it a cause for reprisals should foreign nations venture to discriminate against our tonnage, while claiming for ourselves the right to levy any dues we saw fit on the ships of these same nations when they visited our harbors. Such an unfair attitude would be almost certain to cause commercial warfare to the resultant detriment of our shipping and of our trade. Furthermore, in the event of any such war of discriminating tonnage dues, the United States would be a heavy loser by reason of the fact that its exports are far greater than its imports. As American ships arriving in foreign ports would have to pay heavier tonnage dues than foreign vessels it would be cheaper to ship our products abroad in the latter. All that our discriminator tonnage dues could effect would be the defect-

ing of our less numerous and less valuable import cargoes to American ships, while our far more precious export cargoes would move out in foreign bottoms. This would be a losing proceeding for us. Instead of furthering our shipping as alleged, discriminatory tonnage legislation would be certain to imperil seriously its position.—*The Nautical Gazette*, June 4, 1921.

### AERONAUTICS

CALENDAR OF BOMBING TESTS.—June 21—Tuesday: Bombing of ex-German sub-*U-117* by army and navy air forces jointly.

July 22—Wednesday: Destruction *U-140*, *U-111*, *UB-48* by destroyers.

June 28—Tuesday: Search for and bombing or radio controlled battleship *Iowa* by navy and army air forces using naval aircraft only. *Iowa* to be between latitude of Capes Hatteras and Henlopen 50 to 100 miles off shore at zero hour.

July 13—Wednesday: Bombing of ex-German destroyers about 60 miles off Cape Charles light ship in 60 fathoms of water. Army and navy aircraft jointly. If not sunk by bombs to be sunk by destroyer fire.

July 15—Friday: Destruction remaining destroyers by gunfire.

July 18—Monday: Bombing of ex-German cruiser *Frankfurt* under same conditions as above. If not sunk by bombs to be sunk by big guns of fleet.

July 20—Wednesday: Destruction of ex-German battleship *Ostfriesland*. Flyers must register at least two hits with largest bombs. If vessel still afloat to be sunk by big guns of battle fleet.

Notes: Naval air forces under command of Capt. A. W. Johnson, commanding Atlantic fleet air forces, flag on U. S. S. *Shawmut*. Army air force under command of Brigadier General W. Mitchell, director of training and operations army aviation. Shore base operations under command of Capt. S. H. R. Doyle, base commander, Hampton Roads, Va. General supervision of bombing experiments in charge of Admiral H. B. Wilson, commander-in-chief, U. S. Atlantic fleet. U. S. S. *Shawmut* take station center of scouting area for *Iowa* experiment and a target in other tests.—*The Aerial Age Weekly*, June 6, 1921.

BOMBING THE RADIO-CONTROLLED "IOWA."—Among the bombing tests to be conducted jointly by the army and navy air forces the latter part of June and the first part of July, the most spectacular and interesting from the public viewpoint will be the search problem and accuracy of bombing test on the radio controlled *Iowa*, scheduled for June 28.

In one respect war conditions will be accurately simulated in this problem, for the old *Iowa*, under the control of a distant ship, will maneuver as an enemy ship, just as though she had a crew aboard, except that her speed will be somewhat reduced. Starting at a point somewhere between 50 and 100 miles at sea off the Virginia Capes, the *Iowa* will steam toward shore, while the planes from shore, starting at the same hour, will fly out to locate her. When this is accomplished, the bombing with dummy bombs will begin.

For this operation the army will use only the seven seaplanes it obtained from the navy and four airships, all of its land planes having been withdrawn from this test. The navy will have four of the *NC* type of flying boats and 12 *P-5-1s* in the search problem and four Martin bombers, land planes, aiding in the accuracy of bombing tests. The navy dirigible probably will take part in the search problem.

In order to use the *Iowa* for a moving target, she has been fitted out with special apparatus that will enable her to be controlled by wireless from a ship at a distance. Some extensive changes in the *Iowa's* power plant were necessary, as the propelling machinery must be capable of running for a considerable time without attention. The boilers were changed

to burn fuel oil instead of coal and automatic devices for feeding the fuel to the burners and supplying water to the boiler were provided.

The apparatus for controlling the ship consists of a standard radio transmitter aboard the controlling ship, a receiving aerial on the *Iowa* with special radio receivers, amplifiers, relays, etc., for converting the radio signals into a form such that they will operate the electrical devices which control the steering gear and the throttle of the main engines.

The officers in charge of sending out the radio signals from the control ship has absolute control of the starting of the *Iowa*, steering her in any direction and stopping her when desired. The various operations which take place are as follows:

When everything on board the *Iowa* is ready, the main engines are started up and are left running very slowly. The ship is then abandoned and the officer aboard the controlling ship has control of the *Iowa*. The first radio signal sent out is intercepted by the aerial on the *Iowa* and is received by the radio receiver located well below deck.

This signal is then amplified by means of special vacuum tube amplifiers and is made to operate a very sensitive relay or switch, which in turn operates a larger relay. This large relay closes an electrical circuit which operates an electrically controlled pneumatic valve. When this valve opens, it admits compressed air to the throttle control of the main engines, which causes the throttle to open and bring the ship up to full speed.

The above mentioned relay also operates a device called a commutator, which is a special switch having control of the steering mechanism.

The steering gear consists of a standard steam engine driven rudder gear, the throttle valve of the engine being geared to a small electric motor. The commutator is connected to the control panel of this motor and is thus able to operate the electric motor, which in turn causes the steam engine to drive the rudder to either starboard or port as desired.

A very novel feature of this installation is the automatic steering, which is made possible with the aid of a gyro-compass. The compass is electrically connected to the control panel of the electric motor on the steering gear, so that the ship can be made to hold any course, the gyro-compass immediately operates the steering gear to return the ship to her course. The officer sending the control signals can steer the *Iowa* to either starboard or port or may put the gyro-compass in control and hold a steady course.

The commutator might be considered the mechanical brains of the *Iowa*, it receives the radio signals and interprets them, passing them on directly to the electric motor controlling the steering engine, if the order is either starboard or port, or giving the gyro-compass control, if that is the order.

If the officer in control desires to stop the *Iowa*, he sends a long signal of about ten seconds duration. This operates a special relay which opens the circuit on an electrically controlled pneumatic valve, which shuts off the various fuel oil and feed water pumps, thus shutting down the power plant and stopping the ship.

A special safety device is provided in the form of a time clock, which automatically shuts everything down in case the radio receiving apparatus should become inoperative, or in case no control signals were received after a certain lapse of time.

The radio receiving instruments and amplifiers are navy type instruments. The special relays for converting the radio signal to a form which can be made to control the electrical devices were furnished by John Hays Hammond, Jr. The electrically operated pneumatic valves and their controlling relays for controlling the throttle valves of the main engines, the automatic time clock, the commutator, and the electrical control for the steering gear (with the exception of the gyro-compass itself) were furnished by the General Electric Company.—*The Aerial Age Weekly*, June 6, 1921.

## AERIAL CO-OPERATION WITH THE NAVY

BY SQUADRON LEADER C. H. K. EDMONDS, D. S. C., O. B. E., ROYAL AIR FORCE

## CONTENTS

## INTRODUCTION

CHAPTER I.—“*Co-operation with the Fleet in the North Sea.*”—Evolution of the Aeroplane Carrier.—Grand Fleet’s Aircraft.—German Aircraft in the North Sea.—Narrative of events in the North Sea: Some Observations and Criticisms.

CHAPTER II.—“*Commerce Protection and Prevention of Enemy’s Commerce.*”—The Blockade.—Anti-submarine Warfare: General Description.—First Phase: October, 1914, to December, 1916.—Second Phase: December, 1916, to March, 1917.—Third Phase: March, 1917, to Midsummer, 1917.—Airships for Convoy Work.—Large Flying-boats for Convoy Work.—Seaplanes, Aeroplanes and Kite Balloons for Convoy Work.—Fourth Phase: Midsummer, 1917, to Autumn, 1918.—Last Phase, and General Considerations.

CHAPTER III.—“*Support of Military Expeditions Overseas.*”—Dunkirk, Dardanelles, etc.—Value of the Fast Seaplane Carrier.—Future Combined Operations by Navy, Army and Air Force.

CHAPTER IV.—“*The Possible Future of the Various Types of Aircraft.*”—Limitations of Machines Heavier-than-air and Lighter-than-air.—Probable Requirements in a Future War Against a First-class Naval Power.—Aircraft in Fighting Ships.—Aircraft in Carriers.—Aircraft from Shore Bases.—Conclusion.

CHARTS.—North Sea.

## INTRODUCTION

The object of a nation at war is to stop the enemy’s national life, and the strategic plan which either belligerent follows to achieve this end may be divided into three classes, viz., naval strategy, military strategy, and independent air strategy.

When aircraft are employed for reconnaissance over the sea and in co-operation with the navy the objectives must be the same as those which are the aims of the naval strategy, hence the use of aircraft against any other objectives comes under the heading of independent air strategy, or possibly military strategy, and is outside the scope of this paper.

Now the object of naval strategy is the control of maritime communications, and the destruction of the enemy’s battle-fleet is the principal means to this end. The subject may be conveniently considered under the three following headings:

- (a) The Battle Fleet.
- (b) Commerce protection and prevention of the enemy’s commerce.
- (c) Support of military expeditions overseas.

In Chapters I, II, and III the use of aircraft in the late war in co-operation with the navy under the above three headings will be examined and some criticisms offered. In Chapter IV the limiting factors of various types of aircraft will be considered in conjunction with the probable requirements of future naval warfare. From this a forecast will be made of “the possible future of the various types of aircraft in a war against a first-class naval power.”

Whenever “The War” is mentioned the late world conflict is meant. And the phrase “the future,” unless specially stated, refers to the next ten years, for the author considers that the progress of aeronautics may be so rapid as to render impracticable conjectures beyond that period. No attempt has been made to discuss the work of aeroplanes and kite balloons in any detail, as they are not included in the “Definition of Subject” given in A. M. W. O. 915 of the 14th August, 1919.

## CHAPTER I

## CO-OPERATION WITH THE FLEET IN THE NORTH SEA

*Evolution of the Aeroplane Carrier.*—On the outbreak of war very little was known of working aircraft from ships, therefore the solution of the problem of how to provide aircraft for the fleet at sea was at once energetically sought.

Two classes of seaplane carrier were tried: a large ship with considerable stowage space for machines and considerable radius of action, and smaller ships with correspondingly less radius and stowage. In the former class was the old Cunarder, the *Campania*, for use with the Grand Fleet; and in the latter class were the *Engadine*, *Riviera* and *Empress*, all three cross-Channel packets.

By December the three last-named ships had joined the Harwich Force, and on Christmas Day, 1914, a successful air raid on Cuxhaven and Wilhelmshaven was made by the seaplanes from them. This popularized such operations. The three existing carriers were fitted with improved accommodation for seaplanes, and others of a similar class were taken up.

When the refitted ships rejoined the Harwich Force, however, attempts to make similar raids led to repeated failures and disappointments. It was found that the North Sea in average weather was too rough to permit of seaplanes being hoisted out and in. Also surprise was practically impossible because the flotilla on passage to the German coast was almost invariably observed by Zeppelins, which the low performance seaplanes were quite incapable of bringing down. The seaplane carriers, too, had only a speed of about 19 knots, consequently it was very risky to keep them near the enemy's coast once they had been observed. Therefore, the policy of raiding the enemy's naval bases continuously was abandoned, and no more than sporadic attacks were afterwards attempted.

H. M. S. *Campania* joined the Grand Fleet in the summer of 1915. Experience with her, confirming that gained with the Harwich Force, was that the use of aeroplanes from ships at sea was impracticable, that an aircraft carrier must have a speed at least equal to that of the ships with which she works, and that there was a need for both the large and the small class of carrier. Further, this experience enabled the commander-in-chief to lay down his aerial requirements for the fleet at sea as follows:—

- (i) To prevent reconnaissance by Zeppelins.
- (ii) To reconnoitre the enemy's fleet.
- (iii) To spot for gunfire after the battle was joined.

Accordingly the pre-war experiments in flying seaplanes with wheels, or aeroplanes, off the deck of a ship steaming at high speed into the wind were pressed on, and the results were good. In the meantime the possibility of an aeroplane alighting on the deck of a ship under way became recognized, which obviated the necessity of stopping to hoist-in after a flight, with the consequent risk from submarines. The construction of H.M.S. *Argus*, with a special alighting deck, began in 1916. In the autumn of 1917 successful trials of landing an aeroplane on H. M. S. *Furious* were carried out, also the practicability of flying an aeroplane off a turret had been proved; and from this date onwards aeroplanes were carried on ships in lieu of seaplanes.

*Grand Fleet's Aircraft.*—At the time of the Armistice a comprehensive programme for Grand fleet aircraft was nearly completed. There were two large aeroplane carriers (*Furious* and *Argus*) and one small one (*Vindictive*), whilst two more large ones were under construction. *Argus* had torpedo machines, the other carriers reconnaissance machines.

In each light cruiser, except when prevented by questions of stability, a single-seater fighter was carried, whose primary rôle was the attack of Zeppelins.

Each battleship, or battle-cruiser, carried two aeroplanes. These were either single-seater fighters or two-seaters, so distributed that each squadron of ships had its own planes for spotting or reconnaissance, and fighters to protect them.

This use of aeroplanes for overseas flying was necessary, because no seaplane existed which had the necessary performance to permit of flying off platforms, or of landing on a deck, or to bring down a Zeppelin. Nevertheless, there were certain unavoidable drawbacks. Even with airbags and hydrovanes on the chassis, the strain on the pilots and observers and the wastage of machines was greater than if seaplanes could be used. Also, to keep the personnel in practice, there must be aerodromes, lighters for landing and embarking machines, etc., at each fleet base. In the war these drawbacks were not prohibitive, because as the oversea flying was only occasional the strain on the personnel was never very great, neither was the wastage excessive, as the aerodromes and shore organization could be easily provided. In peace, however, or in a war where the fleet was more at sea, the same methods might not work. This matter will be dealt with further in Chapter IV.

Kite balloons were carried in a proportion of the cruisers, T.B.D.'s and battleships, being used respectively for reconnaissance, anti-submarine work, and control of gunfire. Considering that a great division of opinion existed as to the value or otherwise of the balloons, and that shortage of either men or material, or both, was always a difficulty throughout the war, the author considers that once the aeroplane programme was accepted the kite balloons should have been given up, except in a few destroyers for anti-submarine work. Airships of sufficient performance to meet the fleet's requirements were not available during the war.

*German Aircraft in the North Sea.*—Having reviewed the development of aircraft with the Grand Fleet, it is appropriate to consider the enemy's naval aerial resources, before passing on to a more detailed examination of their employment. Unlike ourselves, the Germans started the war with an efficient service of large rigid airships, whose primary rôle was the patrol of the south-east corner of the North Sea. They were based on Tondern, Altona and Cuxhaven, and it is no exaggeration to say that in the region of their patrols they held the supremacy of the air. Hence, the German fleet when at sea in good weather always enjoyed aerial co-operation, the movements of any ships were nearly always screened by airships, whose great radius of action, speed range, and long endurance rendered them capable of this work.

The airship patrols were supplemented by seaplanes from Sylt, Heligoland, a station near Cuxhaven, and Borkum. Flying-boats were not used, but the German float-seaplanes were much superior to our own. They had no aircraft carriers, neither were aircraft carried aboard warships. Presumably the enemy relied on his large airships to fulfill the requirements of the fleet at sea.

*Narrative of Events in the North Sea, with some observations and criticisms.*—A brief review will now be made of the work of the Grand Fleet and Harwich Force, in order that the work of aircraft co-operating with them may be examined. Generally speaking, the guiding policy for our fleet was to keep the majority of ships in harbor, and to carry out continual sweeps of varying strength with the remainder. Early in the war, as already mentioned, there were no aircraft to co-operate in these sweeps, which extended far beyond the range of our aircraft working from shore bases. The direct result was that the enemy's Zeppelins, being entirely unopposed, were in a position to warn their outlying small craft; if the sweeping force was small it ran the risk of interception by a superior force suitably guided by information from the air; if the sweeping force was strong this fact was reported, and the enemy was not to be enticed out. In any case the sweeps were far less effective and much more risky than if aircraft had been available.

The only offensive operations made by the enemy's ships were three similar sweeps, during which towns on our East coast were bombarded. On only one of these occasions were we able to intercept the raiders by our surface ships and submarines. Had there existed on our side a more extensive system of air patrols, airships at long range, and seaplanes and aeroplanes closer inshore it seems that our fleet would certainly have had a much better chance.

It was in January, 1915, that our battle cruisers intercepted the enemy's, who were probably embarking on one of these sweeps. The running fight of the *Dogger Bank* took place, in which two enemy battle cruisers were sunk and one seriously damaged before they could escape behind their minefields. This gives an excellent example of an opportunity for torpedo-carrying aircraft, had they been available. One hit on each ship with even a 14-inch torpedo would probably have so reduced the squadron's speed that all would have been overtaken and sunk.

In May, 1916, the Battle of Jutland took place. As is well known, before a superiority could be brought to bear, the German fleet turned away under cover of a smoke screen and a failing light, and escaped a decisive defeat. On neither side were aircraft available in any numbers, yet the action is of interest by reason of the work which the few aircraft did, and more especially by reason of the proof it provides of the imperative necessity for air work in a fleet action.

The seaplanes in H. M. S. *Engadine* were the only aircraft available for the British. One of these sent by wireless an accurate report of part of the German fleet before the action commenced—information which light cruisers could only have obtained after considerable fighting. The author believes, but does not know definitely, that during the battle the German airships patrolled to the southward of the High Sea fleet, watching its line of retreat. On the morning following the battle they did valuable work in reporting our fleet's position.

Two points are made strikingly evident by the official despatches and Lord Jellicoe's book, "*The Grand Fleet*." The first point is the uncertainty in the C.-in-C.'s mind as to the position of the enemy, after receiving a few reports from the battle cruisers; in other words, insufficient reconnaissance. The second point is that until about twenty minutes after the enemy had turned away, the C.-in-C. was unaware that they had done so, and to this their escape seems largely due. Again, insufficient reconnaissance. Any aircraft flying above the mist and the smoke might well have reported the turn immediately it was made.

After the Battle of Jutland the enemy abandoned any idea of an active policy for his High Sea Fleet, and concentrated on the submarine campaign. Accordingly, we greatly extended the Heligoland Bight minefields, and in connection with the mining, long reconnaissance flights from Killingholme, Yarmouth, and Felixstowe were made as often as possible by flying-boats. The chief object of these flights was to ascertain if and where the Germans were sweeping. At the end of the war the F.2A's were capable of patrols measuring 400 miles on the chart, but this only took the reconnaissance about half-way across the Bight, and the need for longer range aircraft became increasingly evident. This was emphasized during the last few weeks when a final sortie by the High Sea Fleet was confidently expected.

An interesting point in connection with these long reconnaissances was the difficulty of accurate navigation over the sea, and the need for developments in this direction. Obviously the more accurate the position of mine-sweepers reported, the more valuable the report.

Whenever the flying-boats were near Borkum, considerable fighting occurred with the German seaplanes. This led to development in flying the boats in strong formation, and of defensive armament and control of fire in the boats, which eventually enabled them to hold their own.



But to send a strong formation for each reconnaissance was most uneconomical, thus showing the need of a moderately maneuverable seaplane of high performance, which, though not intended for offensive fighting, could look after itself if attacked (A). These machines would have undertaken the work near Borkum, and the flying-boats would have undertaken the longer range work, the latter of necessity avoiding areas where opposition was likely to be very heavy. Such a machine, *Fairey* with a Rolls-Royce engine, was produced just before the armistice. There was much controversy on this subject, one school of opinion declaring that aeroplanes could do the work. It is, however, significant that those actually employed on continuous long-distance overseas flights (frequently over minefields) were emphatic that seaplanes or flying-boats, providing, as they do, more chance of safety in case of engine failure, are essential. Where the flights were less frequent and the strain consequently less, as in the Grand Fleet, the use of aeroplanes was satisfactory.

Whilst the large flying-boats, sometimes extending their radius by the use of lighters, confined their activities to the southern part of the "prohibitive area," a number of reconnaissances over the northern part, and a raid against Tondern, were made by aeroplanes from the *Furions*. The aeroplanes in light cruisers also, from time to time, had chances of attacking Zeppelins. In these operations it became evident that although the large airship falls an easy prey to an aeroplane that brings it to action, yet the action is often most difficult to bring about, because the airship can generally make a reconnaissance without coming very close, and if pursued can often escape in clouds of fog. Critics of the airship are much too prone to make capital out of the number of German airships destroyed over the North Sea (actually only six!), whilst forgetting the countless occasions on which they did valuable work without molestation.

The reconnaissances made latterly by machines from the *Furions* had an excellent effect on the morale of the Fleet's flying personnel, and in the Tondern raid gave a fine return in material damage done, but unfortunately the extent to which the minefields had now increased, put most objectives out of range. It is interesting to examine the good results which would probably have followed if more aeroplane carriers had been sanctioned along with the *Argus* in 1916, whereas actually it was nearly a year later that *Furious*, *Vindictive*, etc., were sanctioned, and at a time when there was very little more data than in 1916 regarding the capabilities of aeroplane flying off and on to ships, and when the pressure on the shipyards had increased. Had more carriers been available earlier, before the great expansion of the minefields in 1917, continuous air raids on a small scale could have been made. Their object would have been to keep the enemy occupied, to collect information, and to keep up an offensive. If the development of the torpedo aeroplane, whose possibilities were proved at the Dardanelles in 1915, had received the attention it deserved, these machines would have played an important part in such raids, which might have been developed into the landing of raiding parties on the Frisian Islands, etc. Actually, however, the enemy enjoyed complete immunity from attack on his seaboard, he was thus able to decrease his defensive measures to a minimum, and concentrate on the offensive submarine campaign. Perhaps also the earlier provision of more fast carriers would have enabled the enemy's air patrol to have been neutralized. Efforts were made in this direction with the *Vindex* and *Manxman* in the Harwich Force, but their low speed and inferior carrying capacity prevented success.

The author considers that our inability to raid the German seaboard with ships and aircraft, and the fact that until the end of the war we lacked efficient aircraft with the Fleet, handicapped us and helped the enemy (whose airships provided the aerial co-operation which we lacked)

to an extent not fully realized at the time. Had our fleet not been so handicapped the war might have been considerably shortened.

## CHAPTER II

### COMMERCE PROTECTION AND THE PREVENTION OF THE ENEMY'S COMMERCE

*The Blockade.*—To the stoppage of the seaboard commerce of the central powers, their collapse and our ultimate victory were largely due. Their stoppage was accomplished by means of the blockade, based on the right of search, which necessitated the examination of all ships entering or leaving the North Sea by the Dover Straits or round the North of Scotland.

A minefield across the Straits of Dover compelled merchantmen to enter the Downs, where examination took place, and rendered this part of the blockade comparatively simple. But the Northern Patrol was a much more difficult proposition, involving as it did the watching of a line of some six hundred miles, from Scotland to Iceland, and thence to Greenland, where the weather was of the worst and submarines were a constant menace to the patrolling ships. In June, 1918, the laying of a mine barrage from Scotland to the Norwegian coast was commenced. Primarily this was an anti-submarine measure, but it would also have helped the Northern patrol, by forcing merchantmen to use certain swept passages.

In conjunction with the plan for this barrage a considerable aircraft program was contemplated, which comprised the expansion of the existing seaplane stations in the Orkneys and Shetlands, the use of airships, and the allocation of aircraft carriers and kite balloons to the patrol. Actually the program was never undertaken, for it was realized that the long nights, the bad weather, and the great distances required to be flown rendered the work beyond the capabilities of contemporary aircraft. Had the conditions been easier there can be no doubt but that the effect of aircraft would have been great. For instance, they would have provided a most economical method of locating merchant ships and directing them to rendezvous where the searching craft would be. Again, they would have provided valuable protection for the patrol ships against submarines. In short, the great possibilities of the more efficient aircraft of the future in connection with a maritime blockade were clearly shown.

The activities of the German cruisers, such as the *Emden*, and their raiders such as the *Wolf*, merely emphasize the difficulty from which surface ships suffer in searching and patrolling, by reason of their limited speed and vision, as compared to aircraft. This amplifies the remarks made above concerning the use of aircraft in a maritime blockade. It is interesting to note that the *Wolf* used a seaplane, which is believed to have materially helped her.

*Anti-Submarine Warfare—General Description.*—The German submarine campaign, and our anti-submarine war, can conveniently be considered in five phases. In October, 1914, the first submarine attack on an allied merchant ship was made; later the enemy announced that all shipping in a prescribed zone round the United Kingdom was liable to attack, and in January, 1915, the first merchant ship was sunk without warning. Meanwhile, our policy had been one of attacking submarines wherever they were reported, in so far as the very limited means available would allow. By December, 1916, however, the situation had become so serious that a special organization was established in the Admiralty to deal with it, and with its establishment the first phase ended.

The main feature of the second phase was that increased efforts were made to harass each submarine from the moment of leaving the base until her return. During this phase Germany declared her policy of unrestricted submarine warfare, which virtually brought the United States into the war.

The third phase commenced with the inauguration of the convoy system in the spring of 1917, previously to which the trade had been directed by "routing" or by "suspended sailings." It was the convoy system which, above all other methods, did most to prevent the success of the German submarine campaign, and it was in connection with the convoy system, above all other anti-submarine operations, that aircraft proved of the greatest value.

In the summer of 1917 the policy of intensively mining the Heligoland Bight began to take effect, and the fourth phase may be said to have begun. Its characteristic was the great extension of mining in the North Sea and Dover Straits. The final phase was inaugurated by the enemy abandoning his attack on merchant ships, recalling his submarines, mine-laying off our Northern fleet bases, and apparently making all preparations for a large naval engagement.

The five phases referred to apply mainly to the waters round the United Kingdom. In the Mediterranean we followed the same methods, so far as resources allowed. The work of aircraft during these phases will now be examined.

*First Phase: October, 1914, to December, 1916.*—During this period air stations grew up near every naval base at home and in the Mediterranean. Also a wing was sent to Flanders during the first weeks of the war, which later became based on Dunkirk. It is doubtful if aircraft contributed much towards such anti-submarine measures as were taken during this period, but experience was gained which helped greatly towards the aircraft being usefully employed when the inception of the anti-submarine division of the Admiralty led to the more vigorous measures of the later phases.

By the end of 1916 the force at Dunkirk had grown to a strength of about four wings, composed of fighters, bombers, reconnaissance and photographic machines, and seaplanes. These were used continuously over Zeebrügge and Ostend, and it was proved conclusively that seaplanes are so handicapped by the weight and head resistance of their floats, that they cannot be used where the opposition from anti-aircraft guns and hostile aircraft is very strong.

*Second Phase: December, 1916, to March, 1917.*—Immediately on the inception of the anti-submarine division there followed a great increase in all anti-submarine measures, and co-ordination of the methods of their employment.

At Dunkirk the R. N. A. S. was continually augmented, until at the time of transfer to the R. A. F. it consisted of a brigade. Up to the closing months of the war constant reconnaissance and bombing of the Flanders naval bases was done. This reconnaissance, which provided accurate data of the extent to which submarines used the Flanders ports, was of great value.

As regards the bombing in April, 1918, 17.5 tons of bombs were dropped, while in August this had been increased to 98.8 tons. From the evidence available it seems that the material damage done was slight, probably one submarine was destroyed in Zeebrügge docks, and in July, 1918, the lock gates at that place were probably burst. On the other hand, the enemy was forced to construct the most elaborate protection for the submarines, the constant alarms of raids must have retarded the refitting of the boats, and the effect on the crews necessitated their being sent into Germany for their leave. In addition to this, the enemy's very elaborate anti-aircraft organization must have absorbed great numbers of men and many aeroplanes, searchlights, etc., on purely defensive work.

The distinguished air officer who is best qualified to judge has estimated the relative value of the moral damage to the material damage done by the independent bombing force as twenty to one. It is probable that the effects of the Dunkirk bombers and the bombing of Cattaro were similar.

Certain it is, however, that aircraft provided the only means of attacking submarines in their bases.

All this bombing was done by aeroplanes, and therefore falls outside the strict scope of this paper. Mention has been made of it, however, because it shows where the legitimate work of seaplanes ends and that of aeroplanes begins.

*Third Phase: March, 1917, to Midsummer, 1917.*—The feature of this phase was the substitution of the "convoy" system for the previous system of "routeing." In the latter, merchant ships had been instructed, as far as possible, to keep clear of dangerous areas. Also trade was ordered to pass through one of the four "cones of dispersion," of which the apexes were Falmouth, Innistrahull, and Kirkwall. It was thought that the submarines would operate in these areas where the trade converged, and that it would be possible to patrol them adequately with every means available, including aircraft. However, this proved to be bad policy, for the increasing range of the submarines so magnified the cones that the controlling craft were insufficient. This led to the introduction of convoys, by which system merchantmen were collected at certain ports, and then escorted to their destination. It will readily be seen that the new system presented great advantages over the old, especially for aircraft. Patrolling a large "cone of dispersion" for a periscope was indeed searching for a needle in a haystack, but convoying ensured that the flying was done where the submarine was most likely to be, and most likely to take risks.

To co-operate in the convoy system, air-stations were built up first of all in the Channel and on the East coast, and later were extended to the Mediterranean, Irish Channel and French coast. The U. S. A. took over the convoy work in Ireland, and the Canadians made stations in Newfoundland and at the mouth of the Gulf of St. Lawrence.

The general organization was as follows: An air group was formed for each operational area. The headquarters of the group was in immediate touch with the S. N. O. and the local base intelligence office, and also in telephonic and wireless connection with the air stations or sub-stations of the group. This provided the rapid means of communication which experience had shown as essential. As regards the equipment of such a group, this came to comprise airships, flying-boats, seaplanes, aeroplanes, and kite balloons. The functions of each of these in convoy work will now be examined.

*Airships for Convoy Work.*—The S.S. Airship, virtually a B.E. aeroplane stripped of its wings and suspended under a small envelope, was the first type to be used. Early in 1918 it was superseded by S. S. Z., which had greater speed, duration, bomb-carrying capacity, and facilities for observation.

The S. S. Z. was in turn being superseded by the twin S. S. This type, whilst giving an all-round increase in efficiency, had the great advantage of twin engines, and consequent greater safety in the case of engine failure or adverse winds. Further, to meet the demand for increased performance, larger non-rigids of the coastal and North Sea classes were produced but never in great numbers.

Except for the R-29, which helped in sinking the U-115, no rigids were completed in time to play much part in the anti-submarine war, but had the war gone on they would probably have done important work in escorting convoys far into the Atlantic, for which purpose large airship sheds were in course of erection in Ireland. As the submarines were gradually driven to work farther and farther from the coast, the problem of how to provide an escort when the convoy was out of range of the smaller types of surface craft and aircraft began to arise. The difficulties of flying aeroplanes from and back to a ship are so great that at present there is little chance of each convoy carrying its own aerial escort (except kite balloons), and for the future it seems that convoy work at a great distance from the coast will be the rigid airship's rôle.

The airship's greatest difficulty was that of providing adequate sheds. Finally, mooring out sites were selected for the smaller non-rigids, and this proved most satisfactory, the ships riding out gales of over 60 m.p.h. without damage.

Much criticism was levelled at the policy of employing airships. The great expenditure on the sheds was one argument, but this was largely met by mooring out. Another argument was based on the airships' inability to fly in strong winds, and although this was true in fact it was counteracted by the facility with which they flew by night or in foggy weather.

When escorting a convoy and a submarine is sighted, the airship on account of its low speed usually fails to get over the submarine with bombs before the enemy dives. Hence it is clear that the principal value of the airship is that it locates the submarine and frightens it into diving, whereupon the submarine's speed is so reduced that probably it cannot get into position to attack.

The great variation of speed facilities for observation, signalling, and accurate bombing make airships excellent for convoy work, though on account of their vulnerability this must be confined to areas which hostile aircraft do not frequent.

Very careful statistics were kept at the Admiralty of man power, etc., used up by the various anti-submarine arms in relation to the results achieved. By these the employment of airships was fully justified. In the author's opinion the only criticism that can justly be levelled is against the pre-war policy which so neglected airships.

*Large Flying-Boats for Convoy Work.*—The large flying-boats very early proved their value, for they had the essential qualities lacking in smaller seaplanes, viz., excellent view, good bomb-carrying capacity, big radius of action, and reliable engines.

Compared to airships the boats could fly in much stronger winds provided they had calm water for the take off. With the convoy station-keeping was more difficult, but the high speed gave a better chance of bombing a submarine before it dived. They were also capable of escort work where hostile aircraft were met; for instance, the Dutch traffic from Felixstowe.

As regards disadvantages, the F-2A suffered from extreme heaviness on controls, which was, however, largely rectified in later types. The chief disadvantage was the great requirements in sheds and slipways; but as in the case of airships this was met by the expedient of mooring out. Although this was satisfactory in modern weather, the machines were always exposed to the risk of a gale when they would almost certainly "fly" at their moorings and stave in the hulls. To render the large flying-boats really reliable when they are away from main bases where extensive slipways and sheds exist, some means of enabling them to ride-out gales in a sheltered anchorage must be found. Possibly an adjustable trailing edge by which the plans could be set to give no lift would meet the case. The author considers that this question of mooring is of great importance, and demands immediate attention (D). Some improvement was effected by keeping machines moored on lighters, but this did not entirely meet the case in really heavy weather.

*Seaplanes, Aeroplanes, and Kite Balloons for Convoy Work.*—Several types of seaplanes, the Short, the Wright, the Sopwith Baby, etc., were used, and all suffered from the bad view ahead, inevitable in a single-engined tractor, and insufficient bomb capacity. These disabilities, together with the fact that the seaplanes were often prevented from rising by a choppy sea, and also the necessity for reducing the number of types in production, led to the gradual elimination of the seaplane, whose inshore work was taken over by aeroplanes.

In turn these aeroplanes suffered from the same disadvantages as the seaplanes, except in the case of the Blackburn *Kangaroos*, and in addition flying over the water, even with air-bags, imposed an extra strain on the personnel, and caused extra casualties.

This leads one to the logical conclusion that the type of heavier-than-air machine required for inshore anti-submarine work, say, up to about 30 miles to seaward, is a medium-sized amphibian with floats and detachable wheels, carrying at least one 500-lb. bomb and either a pusher or twin tractor (c). Normally the machine would work from an aerodrome, but, if necessary, the wheels could be dropped, and she could alight on the sea and be capable of taxiing or rising again.

Kite balloons were extensively used with convoys, for they provided the only possible aerial escort when out of flying range of the shore stations. As in the Grand Fleet there was much difference of opinion over their value, and finally the majority held the opinion that they did more harm in giving away the position of the convoy than they did good as look-outs or as "scarecrows."

*Fourth Phase: Midsummer, 1917, to Autumn, 1918.*—The feature of this phase was the great extension of mining and barrage work in the North Sea, the Dover Patrol, and the Straits of Otranto—the work of aircraft in this connection in the North Sea has already been described.

At Dunkirk seaplanes were originally employed for this. Their value lay in their ability to observe any change in the positions of buoys or surface nets, to act as "scarecrows" and force the submarines to dive into minefields, and to help hunting flotillas. Later the use of seaplanes had to be abandoned because they were no match for the German fighter aeroplanes, and the overseas anti-submarine work was taken over by a squadron of D.H.'s with Rolls-Royce engines.

At the Otranto barrage most of the flying consisted of hunting in co-operation with the surface craft. Kite-balloons unquestionably proved their value, for, used at the extremities of the barrage area, they forced the submarine to dive before entering the area. Generally speaking, experience on this barrage led to the same conclusions as at home.

Seaplanes were found preferable on account of the reduced risk from engine trouble, but a certain number of aeroplanes were essential for weather when seaplanes could not get off, and to provide machine to get away quickly in response to urgent calls. That aircraft are a necessary part of a mobile barrage is proved. However, it was also proved that a mobile barrage is an extravagant method of using aerial and other resources, for after the Armistice it was found that the Otranto barrage had accounted for only one submarine.

*Last Phase: Autumn, 1918.—General Considerations.*—Of this period little need be said. The enemy abandoned the attack on merchant ships, and concentrated on submarine mine-laying off our Scottish fleet bases. To meet this all available aircraft were moved to the East Coast of Scotland and England, and employed with hunting flotillas and on patrols.

Throughout all the anti-submarine operations there was a constant demand for increased size of bombs, more accurate bombing, and better fusing. The fusing question was the most difficult, and remained unsolved at the time of the Armistice. What was required was a variable fuse, which the observer could adjust to whatever depth he required.

Intercommunication between aircraft and ships was another vitally important question. Visual signalling by Aldis lamps was proved the best, wireless only being used for long ranges. Especially abroad, however, many patrol craft carried only indifferent signallers, and in these cases dropped messages in watertight containers proved a good expedient.

Frequently aircraft failed in their attacks because a submarine heard their approach without seeing them and dived. Experiments were made to try and find a means of silencing both engine and propeller, but they met with little success, and it is hoped that the research will be continued on this most important question.

The destruction of a submarine by aircraft alone proved most difficult. Officially aircraft are credited with only twelve submarines, though the instances when they helped surface craft in successful hunts are numerous.

Undoubtedly the most effective rôle of aircraft in anti-submarine warfare was convoy work. This was proved by statistics in 1918, when of 7,000 convoys escorted by aircraft only six were attacked.

### CHAPTER III

#### SUPPORT OF MILITARY EXPEDITIONS OVERSEAS

*Dunkirk, Dardanelles, etc.*—A considerable proportion of the anti-submarine work already described was in support of our numerous military expeditionary forces. However, in addition to this, certain other air work falls within the scope of this chapter, of which some of the flying on the Dover Patrol and that at the Dardanelles form the most important part.

The principal duty of aircraft, in this connection, on the Dover Patrol was to keep so close a watch on Zeebrügge, Ostend, and the eastern approaches to the Straits as to prevent the enemy's naval craft bringing off a raid in force against the cross-channel communications of the army in France. During the passage of the expeditionary force a seaplane patrol was maintained from Westgate to Ostend, and a mixed force of aeroplanes and seaplanes was sent to Belgium.

After the German occupation, however, the aircraft for the Dover Patrol were based on Dunkirk and Dover. It has already been stated that the great opposition necessitated the anti-submarine patrols and bombing being done by a squadron of D.H.4's with R.R. engines. Exactly the same conclusion was reached in the work of spotting for monitors, and reconnoitring (chiefly by photography) the enemy bases.

At the Dardanelles conditions were different. Enemy opposition was much less, calm water was nearly always available for the get-off, and hence throughout the operations seaplanes played an important part.

When the operations began in February, 1915, the only aircraft available on either side were seaplanes on H. M. S. *Ark Royal*, which were employed chiefly in locating the forts and entrenchments on the peninsula. Later, both sides were reinforced by aeroplanes, and in May H. M. S. *Ben-my-Chree*, a small seaplane-carrier of high speed arrived.

From this time onwards the presence of submarines necessitated *Ark Royal* (a ship of only eight knots) remaining in harbor. Her machines were chiefly employed in spotting for the monitors and blister ships against positions on the peninsula. This work they did most satisfactorily, their performance being quite sufficient against the limited numbers of enemy aircraft and anti-aircraft guns. Spotting for ships was gradually developed, and together with the experience gained at Dunkirk led to the following definite conclusions:

(1) The best intercommunication between 'plane and firing ship is by W. T. (but the wireless telephone gives great promise for the future).

(2) The clock system gives the best results.

(3) With these aids a ship at anchor can fire sufficiently accurately to take on counter-battery work.

(4) It is, however, risky to take on targets very close to our own troops ashore.

*Value of the Fast Seaplane-Carrier.*—The work of *Ben-my-Chree* exemplified the great value of a fast seaplane-carrier, used as a self-contained highly-mobile unit. Wherever aircraft were suddenly required, this ship was sent. In July, 1919, her machines were spotting for the monitor *Roberts* against the Asia batteries. During the second landing in August they assisted in a dummy landing, as a diversion, near Smyrna; and later, in the same month, effectively used torpedo seaplanes in the Marmora and Dardanelles. When Bulgaria entered the war, *Ben-my-Chree's* machines reconnoitred most of the Bulgarian coast, and were used from the Island of Milo in demonstrations against Greece. Finally,

when aerial reconnaissance of the approach to Egypt through Syria and Palestine (which were out of range of aeroplanes in Egypt) were urgently required in January, 1916, this ship was detached to the Egypt and East Indies stations. In each of these various operations it was found possible for seaplanes, judiciously employed, to compete with such moderate opposition as was found at first. The opposition invariably grew too strong later, but by this time the less mobile aeroplane units had had time to select their aerodromes, etc., and get to work. The simplicity of working seaplanes from a carrier, granted always the *sine qua non* of sheltered water, is very marked in comparison with the use of aeroplanes from an aeroplane-carrier, which must be both under way and head to wind.

Similar work was done by seaplanes in the operations on the coast of German East Africa, and also in the Red Sea, when in the spring of 1916 the Allied diplomatists were beginning to cast their flies over Mecca, and during the evacuation of North Russia in 1919. All of which proves not only the great value of the fast seaplane-carrier under certain circumstances, but also the value of the type of "fighter reconnaissance" seaplane already mentioned (see A, page 242).

*Future "Combined Operations," by Navy, Army and Air Force.*—Now an opposed landing on the enemy's territory (which may be termed a "combined operation") or the defence of our own possessions against such expeditions, has been a very frequent employment for the fighting forces of the Empire throughout history, and would seem to be a probable task for them in the future. Moreover, it seems that the effect of aircraft on such operations will be great. Therefore, the subject may now be considered briefly in the light of war experience and of probable developments.

Let us examine the effect of aircraft on such an expedition in its various stages. The first point is that the selection of the base or advanced base will be largely governed by the range and characteristics of the defender's aircraft. Even if his aircraft were not very strong the base could hardly be as close to the actual point of landing as were Imbros and Mudros, or all secrecy would be lost.

If, however, the defender's air force was strong, and included large airships, to ensure secrecy during the preparations and embarkation of troops the base would need to be about 1000 miles from the point of landing.

The next point is the air work during the voyage from the base to the landing. This will comprise aerial escorts against hostile aircraft, surface craft, and submarines. The relative distance between the base or advanced base and point of landing must largely decide what types of aircraft are used for these duties, and whether they work from aircraft carriers for shore bases.

The effect of the defender's air patrols might be considerable. For instance, if it was intended for the expedition to approach the coast after dark, and land by night, a machine patrolling to seaward in the previous afternoon might discover the whole expedition, and to retain any chance of surprise the attacker's air force must shoot down that machine, not merely drive it off. Probably, too, the defenders would have coastal aeroplane patrols in the evening, which would prevent the expedition approaching to very near the coast before dark, and might be a considerable handicap at a season when nights were short.

The provision of the necessary flying for covering the landing, and immediately after, presents considerable difficulties for various reasons. First because the number of aircraft carriers would probably be limited, and there might be difficulties against keeping them under way or even anchored head to wind. Again, landing grounds ashore might be bad or even non-existent. These considerations might necessitate the use of seaplanes, providing another example of the value of seaplanes and their



carrying-ship under certain circumstances. Further difficulties are imposed by the great variety of work required, such as spotting for naval or military guns, fighting, contact work, and naval or military reconnaissance.

The great vulnerability of the beaches to low-flying aircraft, and of the large numbers of anchored transports to attack by torpedo aeroplanes, must not be overlooked.

Generally speaking, the introduction of aircraft into "combined operations" appears to favor the defender more than the attacker, as the latter's machines will probably have to work from ships, or extemporized bases, and whilst suffering from the inevitable disadvantages which such conditions impose, will have to carry out complicated, varied and difficult flying.

#### CHAPTER IV

##### THE POSSIBLE FUTURE OF THE VARIOUS TYPES OF AIRCRAFT

A forecast of the future of the various types of aircraft can only be attempted after duly weighing the various governing factors of the problem. There appear to be three factors: First, the limitations of the various types; second, the probable requirements in another war against a first-class naval power; and finally, the teachings of the late war, many of which have already been dealt with in previous chapters. On the above lines the problem will now be considered.

*Limitations of Machines Heavier-than-Air and Lighter-than-Air.*—The way in which machines are likely to develop in the future appears to be determined by certain mechanical facts. If heavier-than-air be considered first, the farthest that an aeroplane or seaplane can fly in still air, taking a reasonable load of bombs, guns, etc., is, to-day, about 400 miles. Now this is not improved by increasing the size of the aeroplane, because in practice the bigger the aeroplane the greater is the structural weight compared to the useful load carried; and also because the spreading of weights over the structure, which seems necessary with increase of size, causes heavy stresses when alighting. Hence, in the future aeroplanes and seaplanes appear to be limited to flights of about 400 to 800 miles, and the average speed at which they fly is at present about 110 miles per hour. (Attention is drawn to the fact that, as explained in the Introduction, "the future," unless specially stated, refers to the next ten years.)

Improvements in the motor, in constructional methods, in propellers, will doubtless cause greater efficiency, but as these are likely to be gradual improvements and not fundamental changes, the limit suggested above seems reasonable.

With the airships the conditions are different. If the ship is increased in all its dimensions in the same proportion, the volume increases as the cube, and the surface as the square, therefore to drive it at the same speed requires relatively less power. This advantage is not all lost through the fact that the stresses on each circular sector increase with the diameter. Generally speaking, then, the bigger the airship the more efficient it is, and the limits which are met first are the size of the shed, or the difficulty of mooring out a really large ship. Notwithstanding these limits, the present-day airship is capable of carrying a reasonable fighting load a distance of about 1500 miles in still air at a speed of about 60 miles per hour. In the future then, the use of the airship is for flights beyond the limits of heavier-than-air machines, accomplished at a more moderate speed and with a bigger load.

The extreme vulnerability of the airship to attack by a high performance aeroplane is another limit. At present it precludes the use of airships from localities where enemy fighters are strong, and the writer considers that probably this will remain the case in the future. The question of defensively arming the big airships demands very careful investigation, also the question of airships fighting each other.

*Probable Requirements in a Future War against a First-Class Naval Power.*—Having defined the fundamental limits of the two main classes of aircraft it is appropriate next to consider whether the requirements of a future war against a first-class naval power are likely to differ from the late war.

A little reflection leads to the conclusion that we are most unlikely to find ourselves placed in so favorable a strategic position as in the late war, with the British Isles situated across the arteries of the sea communications of our enemy.

Again, in the late war the main bases of the opposing fleets were separated only by some 500 or 600 miles. Is this likely to occur again? On the contrary, it is far more probable that this distance will be greatly extended, and the key of the naval situation instead of being the control of the North Sea may be the control of a great ocean. Or it is possible that the enemy's fleet may be so distant that before naval operations on a large scale can begin, our fleet will have to move to bases situated nearer the enemy, whilst our trade and possessions within striking distance of the enemy's fleet are protected as much as possible in the meantime by local resources.

Another consideration is that the increasing use of aircraft in naval warfare will have the effect of forcing fleets to move at night or under water if they are to be unobserved, in the same manner as troop movements are nowadays made in darkness, or with great attention paid to concealment and camouflage.

What, then, are the inferences to be drawn from the difference between the probable requirements of the future and those of the late war? Obviously we cannot be content with ranges and performances which would have suited the North Sea. There must be no slackening of effort to produce aircraft with greater radius of action, greater speed, and greater all-round efficiency. Night flying and anti-submarine work must continue to be developed. Also the possibility of the Admiralty calling upon the independent air force to endeavor to secure aerial supremacy over a specified part of the ocean during any big fleet movement should be recognized. The possibility referred to above of distant possessions and maritime trade being protected by local resources pending the arrival of our fleet (which would probably take several months) opens up great possibilities for aircraft. Aircraft would be invaluable as part of these local resources—their use in defence against invasion has been emphasized in Chapter III.

The rapidity with which aeroplanes can get to Australia forms a striking contrast to the time it would take our fleet to reach the Pacific should its presence there be necessary. When once the Empire's air routes are developed, a powerful air force from some central position, such as Egypt, could be sent to any threatened possession long before the fleet could arrive.

If imagination is allowed to take us somewhat beyond the ten years by which the writer defines "the future" for the purpose of this paper, it is not difficult to visualize the Air Force undertaking some of the present functions of the fleet, transporting expeditions to enemy countries by air, arriving rapidly to reinforce beleaguered garrisons, or fighting a campaign against merchant shipping with large numbers of torpedo-carrying aircraft. Indeed, the imagination leads us into a veritable Abdullah's Cave of strategical possibilities. We are led, perhaps, out of the scope of this paper—co-operation with the navy—into the sphere of independent air strategy. But in an age when the rapidity of communications and transportation continues to increase, a contemporary speeding up of warfare is inevitable, and such possibilities for the more distant future must be recognized. By recognizing them we can ensure that aerial development in the immediate future, and the development of imperial strategy, progress

along lines which will eventually enable air power to be a safeguard to the Empire.

To return, however, to the question under consideration. Another point which should be borne in mind before trying to predict the future uses of aircraft, is that in the late war machines designed for work with the army were produced in much greater numbers than those for the navy. Therefore, it was often good policy to adapt a primarily military machine to naval use, because only by reducing the number of types could sufficient production be maintained. But in the next war the opposite might be the case, and therefore in peace time the provision of makeshift machines for naval purposes should be avoided.

Subject to the various considerations enumerated in this Chapter, some prediction of the future of the various types of aircraft for sea reconnaissance and co-operation with the navy will now be attempted, and aircraft from ships at sea will be dealt with first.

*Aircraft in Fighting Ships.*—In a modern fleet the writer considers there should be special aircraft-carriers and also aircraft in certain fighting ships.

Each light cruiser should carry a machine, either a single-seater fighter or a two-seater reconnaissance machine, so allotted that there was one of each type in each pair of light cruisers. The rôle of the fighters would, of course, be keeping down all enemy machines. The reconnaissance machine was not part of our Grand Fleet program during the war, but as so much of a light cruiser's work is reconnaissance there can be little question that they would be most valuable, and it should be possible in the future to produce a suitable two-seater for this work. Wireless telephony will probably prove a most useful means of communicating with reconnaissance machines, and also with spotters.

As regards the battleships and battle cruisers. Each, it is thought, should carry at least one two-seater for spotting and at least one fighter. This would ensure that each squadron of ships had its own quota of spotting planes and fighters to protect them. Also it would avoid the complications and the anxiety to the flag officer commanding the squadron which there would be, if machines from a special aircraft carrier accompanying the squadron carried out these duties. In future it may be possible to produce a three-seater for spotting; if so, it would be a great advantage to have a gunner in addition to the pilot and observer. The author considers that spotting, and reporting enemy movements in a naval action is too difficult for the pilot alone to do, and this necessitates the passenger (if only one is carried) being primarily an observer.

*Aircraft in Carriers.*—Now as regards the aircraft carriers. It is impossible to lay down any definite proportion of these to the other classes of ships, since this must depend on the composition of the adversary's fleet and the nature of the battle it is expected to fight. But it is possible to predict the types of machines to be used from the carriers. These ships should work directly under the commander-in-chief (except, perhaps, one or two under the flag officer commanding the most advanced light cruisers or battle cruisers), and should be stationed within visual-signalling distance of him, if possible. They should carry fighters to enable aerial supremacy to be obtained at any given time and over any particular area should the commander-in-chief wish it; also torpedo machines, bombers and reconnaissance machines, all working directly under the commander-in-chief. It is quite clear that this will necessitate there being a considerable number of aircraft carriers in a modern fleet, and that the number of carriers should be greater in proportion to the surface craft than was the case in the Grand Fleet in the late war.

Another use for the fighters will be low-flying attacks on ships, particularly destroyers whose personnel is so exposed. A determined low-flying attack on a flotilla by a squadron of fighters might easily prevent a destroyer attack being pressed home.

The carriers generally should be large ships, but a certain number of small ones (probably without landing-on decks) will be necessary for operations with light forces, like the Harwich force in the war. Apart from the value of carriers in a fleet action, they will be useful for minor offensive operations against objectives which are beyond the reach of aircraft from shore bases.

Then there is the question of whether the machines carried in fighting ships and in carriers should be aeroplanes, or seaplanes with wheels for flying-off and capable of being dropped. The author considers that if seaplanes can be produced to fulfil the necessary flying-off conditions from the fighting ships, and in addition the necessary alighting conditions in the carriers, and also have the required performance in the air, they should be used. Obviously the fighters must be aeroplanes, but in the future the spotting machines and perhaps those for reconnaissance might be seaplanes. With the seaplanes the strain on the personnel and the wastage would be much reduced. Also, wherever the fleet went in peace time the machines could make daily practice flights, weather permitting, irrespective of whether there was an aerodrome near by or not, and of whether the fleet was at sea or in harbor. There will also be special uses for seaplanes from seaplane-carriers, in combined operations and minor operations, as explained in Chapter III.

*Aircraft from Shore Bases.*—From shore bases the future of the airship is to work beyond the range of heavier-than-air machines, or in localities where hostile fighters are weak or neutralized. Fleet reconnaissance, patrols, anti-submarine work, bombing and reconnaissance of enemy ports, and perhaps mine-laying will all be part of the airship's duties under these conditions.

The same duties will be carried out at shorter ranges by heavier-than-air machines. Here, again, the question of seaplane or aeroplane arises, and the answer, the writer considers, is the same, viz., where the performance which is required permits, use a large flying-boat if a big machine is wanted, or a seaplane (fitted with wheels and flown off an aerodrome if sheltered water is not available) if a smaller machine is wanted. The writer considers that small flying-boats have no future, as experience has proved that they are so easily swamped.

But if the employment necessitates a very high performance an aeroplane must be used; for instance, the amphibian suggested (see c, page 248) would be suitable for anti-submarine work if there was little opposition, although for similar work or reconnaissance on a strongly-defended hostile coast, everything else should be sacrificed to performance, and an aeroplane used.

In addition to the duties enumerated, heavier-than-air machines would be most valuable for attacks against an attempted landing, as already explained. In such operations, and for attacks on ships in harbor the torpedo machine has a great future. These machines should be developed on two lines, the small handy machines (particularly suitable for work from ships) to attack at close range, and large machines for attack at longer ranges, requiring less maneuverability. For the latter work the flying-boat is believed to have already been found suitable. With the advent of the improved mooring-out capabilities suggested (see d, page 248), it is easy to visualize a squadron of torpedo-carrying flying-boats working like a destroyer flotilla of to-day.

In all aspects of overseas flying the difficulty and importance of accurate navigation is very great. Too much attention cannot be given to this question. At present directional wireless seems the most promising method.

*Conclusion.*—Finally, it is only necessary to add that whereas in the late war aircraft gradually became valuable in nearly every branch of naval warfare, study leads to the conclusion that in the next war against a first-class naval power the use of aircraft will be very greatly extended.

Consequently, to a naval power which now develops aerial co-operation with the fleet, largely and on sound lines, aircraft are a vast accession of strength. But to a nation which fails to do this they are a most serious danger.—*The Journal of the Royal United Service Institution, May, 1921.*

**THE ACTUAL STATE OF THE HELICOPTER PROBLEM.**—The helicopter problem has again been brought to the general attention by a few attempts made in different countries to realize such flying apparatus. For this reason a few competent remarks on the actual state of this problem would be at present not without interest.

The *helicopter* is understood to be a flying apparatus where the lift is derived from rotating blade-screws.

A helicopter, in order to actually fly, must not only be able to lift itself but must also be fully *stable* and *manoeuvrable*, and in addition, must be able to safely reach the ground in case of the stoppage of the motor. A clear idea of how the helicopter will behave when free to move in space must first be gotten before the requirements of design can be met. I will give a short survey of these different sides of the question.

1. *The Lifting Problem.*—The present state of the blade-screw theory is such that it is not difficult to design and build helicopter screws that can secure a very high lift, and the difficulty in the realization of helicopters is not at all in this problem. In Fig. C is given a general picture of the thrusts per horsepower than can be secured by helicopter screws. This figure has been established for a first checking and must be considered as giving rather an underestimate of what can be really realized; which means that the data here furnished shows only the minimum of what can be expected from a helicopter-screw and by a careful design these performances can be easily exceeded. As abscissae, are plotted the helicopter screw diameters and as ordinate, the thrust per horsepower. The two systems of curves give the corresponding total horsepower and numbers of revolutions per second. For example, a helicopter-screw absorbing 10 h. p. and having 6 meters in diameter will be able to furnish 10 klg. thrust per horsepower when turning 2 revolutions per second. This means that the total thrust would be 100 klg. for the 10 h.p. If for the same power the diameter of the helicopter-screw would be reduced to  $4\frac{1}{2}$  meters then at around 3 revolutions per second, such blade-screw would give us only 8 klg. per horsepower, that is, 80 klg. for the whole power. One can see how easily any power or size relation concerning helicopter-screws can be answered by this diagram and that helicopter-screws when properly designed can with ease furnish the thrust necessary to lift a helicopter with its powerplant and pilot. The data used in the establishing of this diagram are of such reliability that they illustrate the relations which hold in the present case with great accuracy. I will mention here that several blade-screws built and tested by the author have more than justified the data here furnished.

A point of interest is, that it is easier to get a high lift per horsepower from a smaller power blade-screw than from a higher power one. The helicopter-screw must only make a number of revolutions appropriate to power and diameter selected in order to work in efficient conditions. The study and discussion of all such subjects as helicopter-screw efficiency and general method of the design will be found in the author's *Blade-Screw Theory* above mentioned. The general conclusion to be drawn is: With the knowledge actually available helicopter-screws securing the necessary lift can be built with ease. The foregoing diagram is here given to justify this opinion. It is only ignorant inventors who think the whole helicopter problem consists in the building of the lifting screws, although they usually do not even reach so far. It is necessary to bring attention to this state of this question. It must be remembered that the blade-screw problem is one of the most difficult problems of modern aerodynamics and no one can

hope to familiarize himself with it in a few days. But those at the level of the present state of knowledge and experience on this subject know well that there is nothing to invent in order to build a helicopter-screw giving a high lift.

II. *The Problem of the Descent When Motor is Stopped.*—Insofar as is known to him, the author was the first to investigate the blade-screw problem in such generality as to discuss all the possible states of work of a blade-screw and among which the brake state is to be found. The situation stands thus: Different brake states are possible for a blade-screw. Two of these brake states which I call the first and second brake state require that power is applied to the blade-screw in order to get the braking action. These brake states can thus not be used in the helicopter case. The third brake state is, exactly speaking, the turbine or wind mill case. Usually a wind mill is used as a generator. But, as well known, the wind mill when working produces an axis thrust which is usually balanced by proper bearings. But in the helicopter case, when the motor stops and the helicopter is obliged to descend it is possible to make its blade-screws work as wind mills and simply use the axial thrust thus produced to brake the descent of the helicopter. In order to reach this result it is only necessary to design the helicopter screws so as to secure a high braking action of the kind above explained and that a proper resistance be provided to be overcome by the helicopter screw when rotating as a wind mill. Under such conditions the same helicopter screws which secure the lift of the apparatus when the motor power is furnished to them, will secure the descent, when motor is stopped, working as wind mills, the power being absorbed by a special device. Thus one must not think that the helicopter will simply drop down if its motor stops, but its blade-screws are able to secure the descent if properly designed. For all qualitative relations referring to the braking action of blade-screws, the reader is referred to the author's "Blade-screw Theory," especially its Chapter II. The figures A and B of this chapter give a general picture of all the states of work possible for a blade-screw and the relation of the lifting state of work (marked 1 in figure B) to the wind mill braking state can easily be seen (marked 4 in figure B). In the question of slowing down of the descent of the helicopter, there is in principle nothing to invent but only to use properly the knowledge available.

I apologize for having to refer so much to my own investigations on the subject but I do not know of any other investigations which have treated especially this braking action of the blade-screws, with the necessary generality.

III. *The Behavior of a Helicopter When Free to Move in Air.*—I think it will not be without interest if I will explain a little in detail as to what will be the general behavior of a helicopter, when it has hopped off and is left free to move in the atmosphere.

I will first mention that it is quite a naive idea to imagine that the helicopter will rise and fall exactly vertically through the point of its start. The trouble is that most usually we have winds in the atmosphere and once a helicopter has hopped off, it will be immediately carried away by the wind in the same manner as a spherical balloon. If we would like to have the helicopter remaining nearly over the place of start, we must equip our apparatus with the means of propulsion able to communicate to the helicopter a translational speed equal and opposite to the wind speed. It is only if the helicopter will be able to move against the wind with the speed of the wind that we will be able to keep an apparatus over the place from which we have started. We thus see that if we do not want the helicopter to be carried away by the wind we must secure its propulsion at the speed of the wind. The magnitude of the wind speed fixes the lower limit of the horizontal velocity that a helicopter must be able to develop. If we want the helicopter to be able to travel, as we certainly do, we must



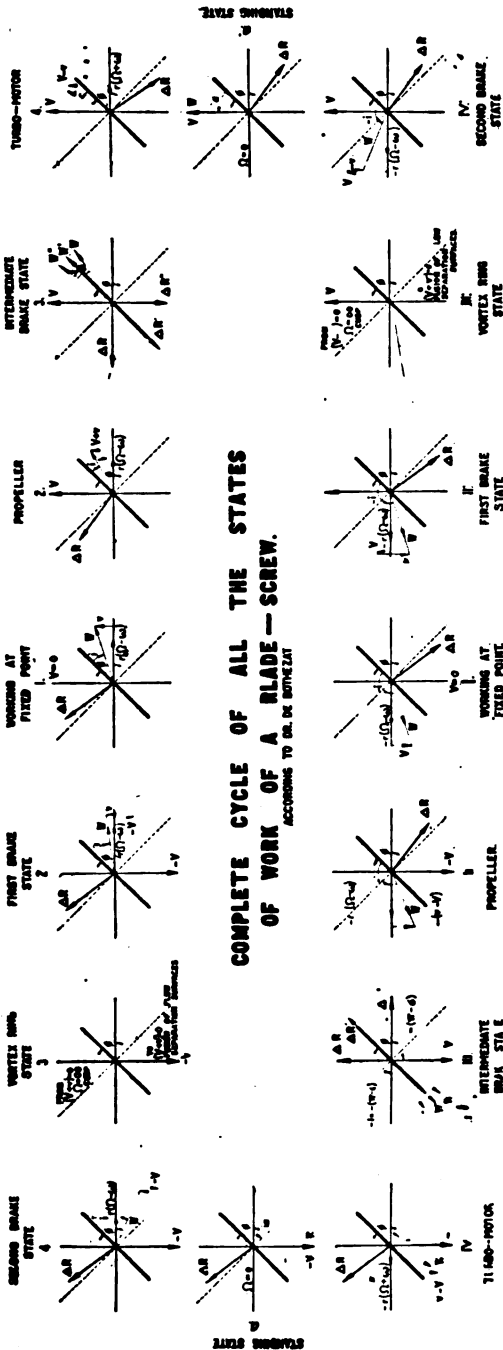

COMPLETE CYCLE OF ALL THE STATES  
OF WORK OF A BLADE — SCREW.  
ACCORDING TO DR. DE BERTHELOT

FIG B



even secure for the apparatus the possibility of developing horizontal velocities greater than the usual wind velocities. This means that the helicopter in order to be really useful must be able to develop horizontal velocities of the same range as the actual aeroplanes. It is just on account of this fact that the following must be well understood. Lifting screws and propulsive screws are of a totally different nature. A screw giving a high efficiency as a lifting screw is of no good as a propulsor. On the contrary, a good propulsive screw is a very poor lifting screw. This brings us to the very important conclusion that a helicopter reasonably conceived must have for its propulsion a special separate propeller, and that the lifting screws must not be used for the propulsion. An additional fact in favor of the last is that if a lifting screw (whose axis is vertical) is moved in a horizontal plane, and thus will have to work in a relative horizontal wind sweeping the plane off its rotation, the lifting ability of a helicopter-screw is not decreased but, on the contrary, some experiments have even shown

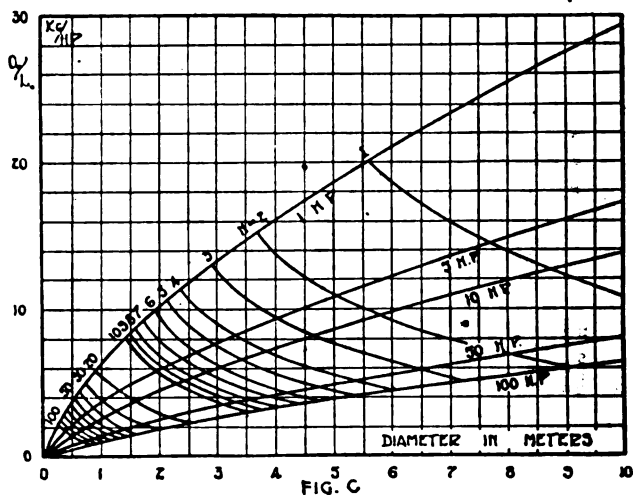

FIG. C

that there is a tendency to the increase of the thrust. Thus the propulsion of the helicopter will not unfavorably effect the work of the lifting screws. But the helicopter screws as such are unable to secure an efficient propulsion. It is thus clear that a helicopter must have a special propulsive-screw or propeller in order to secure its propulsion with a good efficiency. This question of an efficient propulsion is even of first importance because the power demanded by a helicopter will be—for the first helicopter at least—somewhat bigger than the power absorbed by an aeroplane of the same carrying capacity and same speed of travel and thus no waste of power can be tolerated. We have thus reached the fundamental conclusion that a helicopter rationally conceived must, in addition to its lifting-screws with vertical axis, have also at least one special propulsive-screw or propeller with a horizontal axis. Concerning the lifting screws there must be at least two of them in order to balance the two reactive torques. All proposed types of fins for the balance of the reactive torque of a helicopter-screw are rather unhappy propositions which complicate the question without satisfactorily solving the problem. Thus only the propelled helicopter will really be able to hover over its starting point and be able to land, in the usual case of winds, with a small ground speed.

Let us imagine now that on a perfect, still, windless day a helicopter has just hopped off and its propulsive screw is at a standstill. What will be its general behavior? It is easy to realize that it is impossible to expect that the lifting-screw will give a thrust directed exactly along the vertical. Ideal conditions exist only in the imaginations of men. In addition, the slightest disturbance, a slight wind gust, etc., will incline the helicopter. If the thrust furnished by helicopter-screws will be admitted as not perfectly vertical, this thrust with the helicopter weight, which is always exactly vertical, will give rise to a resultant side force, which will produce a side slipping of the helicopter. The idea to have well in mind is that a helicopter as soon as it has hopped off will show a tendency to side slipping and this side slipping will be quite a natural phenomenon. Thus the first quality a helicopter must have is to be built in such a way that the pilot may have control of this side slipping, that is to be able to check it when it starts and to be able to provoke it when necessary. The fact is that by the aid of this side slipping a certain translational motion of the helicopter may be secured. The pilot may rise to a certain height, then side slip, then rise again, then side slip again and so on, because during the side slipping a loss of altitude will usually occur.

We can now see the kinds of evolutions that the helicopter may perform. The helicopter may rise vertically or descend, during which rising and descending, side slipping can occur. The helicopter can also have a translational motion produced by its propulsive screw when working simultaneously to the lifting screws. It is during all these evolutions that the complete stability and maneuverability of the helicopter has to be secured. And it is just this stability and maneuverability of the helicopter that has to be the more thoroughly thought through. It is clear that this stability and maneuverability cannot be secured by rudders such as in the case of the aeroplane, because during the lifting or descending the relative winds will be very weak, if any, and the rudders will not act. Thus, for the stability and maneuverability of the helicopter special devices must be provided. A detailed investigation of this question has brought the author of this note to the conclusion that such stability and maneuverability of the helicopter can be fully secured by very simple means based on the knowledge of the properties of blade-screws. In principle the stability of the helicopter is the more closely connected with the aeroplane stability and a good knowledge of the last is the first step for the understanding of the helicopter stability. The author's investigation of the aeroplane stability, published in Paris in 1911, can be with much profit consulted on this last subject. Aeroplane and helicopter stability have this in common, both are vehicles free to move in space, which is not the case for ships and automobiles that move in one plane. Aeroplane and helicopter stability are especially similar when the helicopter has a translational velocity.

**IV. Practical Importance of the Helicopter.**—It must not be thought that the helicopter presents an interest only as a pure and simple scientific curiosity. On the contrary, the helicopters will find many very important applications.

First of all, the helicopters will, with great advantage, replace observation balloons because they will be a much less visible target and, in addition, the great trouble of carrying the balloons filling gas is wholly avoided.

Afterwards, in many instances, the helicopter will, with great advantage, replace aeroplanes. A properly propelled helicopter being able to fly quickly in the same manner as an aeroplane can in addition perform other very important evolutions. Thus the helicopter will have a speed range from zero up to its maximum which is out of reach for the aeroplane. From this last fact there follows for the helicopter such a big set of applications which the aeroplane is unable to fulfill, that it is rather impossible to enumerate them all. The reader will with ease be able to find such applications.

The realization of the helicopter must thus be considered a very important step in the progress of aeronautics.

I hope this short survey will give a general idea as to how the helicopter problem stands. Actually we have all the necessary knowledge on hand in order to build a helicopter, and such an apparatus can be built, even with small expense, in a rather short time. Even no preliminary tests are necessary so clear are all the relations that hold in this case. If the helicopter has not been realized until the present, it is only because those who have the facilities and possibilities to do it are usually ignorant on the subject. The usual helicopter inventor thinks that the entire problem is in securing the necessary lift. He concentrates all his attention on the last and because he is totally ignorant about blade-screws, is unable to even reach so far. If the building of helicopters would have been left to men of knowledge on the subject, it would have been long since realized.—*The Aerial Age Weekly*, May 23, 1921.

#### MISCELLANEOUS

**DUTCH OIL, LUBRICANT AND IRRITANT.**—Oil has a persistent way of "seeping into political discussion, as witness the cases of Mexico, Colombia, and Mesopotamia," remarks the *Rochester Times-Union*, as it views the international fight for control of the world's oil resources. Far-off Sumatra is now brought into diplomatic discussion through the State Department's protest to the Dutch Government against the exclusion of American oil interests from Sumatra and other Dutch East Indian islands. The note, says the Washington correspondent of the *New York Times*. "is merely another step in the vigorous prosecution of a very definite and fixed policy of the Harding Administration in opposition to the monopolization of the oil resources of the world by any foreign interests in any manner that involves discrimination against American capital or peril to valid American interests." The keen international rivalry which now exists, points out the *Rochester Post-Express*, "is not a struggle merely for the money profits in oil production, but a battle for world trade, commercial supremacy, naval dominance, and the control of the air, for control of a great part of the world's supply of oil could bring these things." Besides, as the *Chicago Tribune* points out, "the owners of some seven and a half million motor-vehicles in the United States are keenly interested in the future supply of oil and gasoline."

Secretary of State Hughes reminds the Dutch Government that "Dutch capital has had free access to American oil deposits," and a similar privilege for American interests in the Djambi fields of the Dutch East Indies is demanded. His note, which the American Minister handed to the Dutch Government, says in part:

"I have pointed out that the United States has for years carried a burden of supplying a large part of the petroleum consumed by other countries, and that the petroleum resources of no other country have been so heavily drawn upon to meet foreign needs as the petroleum resources of the United States. I have pointed out that in the future ample supplies of petroleum have become indispensable to the life and prosperity of my country as a whole, because of the fact that the United States is an industrial nation in which distance renders transportation difficult, and agriculture depends largely on labor-saving devices using petroleum products.

"In these circumstances, my government finds no alternative other than the adoption of the principle of equally good opportunity, with the proviso that no foreign capital may operate in public lands unless its government accords similar or like privileges to American citizens; and, furthermore, I have submitted that in the light of the future needs of the United States such very limited and purely defensive provisions as the above might

become inadequate should the principle of equality of opportunity not be recognized in foreign countries."

Thus the note makes it clear that "if American capital does not receive equality of opportunity with other foreign capital in the development of the oil resources in various parts of the world, there will be vigorous reprisals on the part of the United States," is the way another writer puts it. "It is not the function of the government to become the partner of any interests searching for oil concessions, but it is the government's proper function to insist on the 'open door' in lands controlled by foreign governments," maintains the *Brooklyn Eagle*, and the *Columbia (S. C.) Record* agrees that "it is high time that the United States Government put its weight and influence behind American oil companies, for oil is rapidly replacing coal as a fuel for ships."

It was the Netherlands lower house that denied to the Standard Oil Company of New Jersey the right to obtain concessions; the upper house has yet to act. The vote, in the opinion of the *Washington Herald*, "represents a victory for the Anglo-Dutch concerns...in which a number of ex-ministers and former members of the (Dutch) Chamber are interested." Not only are principal Dutch oil companies "partly British, but they are British-government-owned, which makes the matter all the more serious from the political as well as the economic standpoint," asserts the *Denver Rocky Mountain News*. "British political interests find it convenient now and again to put forward a Dutch organization instead of a purely British one," significantly adds this paper, and it goes on:

"The British Government is in the oil business directly and indirectly. The government is shareholder in several of the giant oil-producing corporations. Besides, the government is spending many millions securing and policing oil territories in the ear East. Indian and British armies are employed for the purpose."

"The Dutch Government apparently has played fast and loose with our Minister, and it should now clear up its ambiguous attitude toward the admission of American capital and also refute, if possible, the charge of admitting British capital secretly to the development," declares the *Mobile Register*. "The note makes it clear that the United States demands nothing which it is not willing to grant to any other country," we are reminded by the *Chicago Daily News*; but "Holland and Great Britain appear to have arranged an oil alliance, and it is against this discrimination that the Hughes note protests," explains the *St. Louis Post-Dispatch*. As we read in the *New York Herald*:

"What the Dutch and English governments have neglected to say, but what is really at the bottom of the oil controversy, is that England has, in the words of one of her own financial authorities, 'got her claws on the future oil supply of the world and she intends to keep them there.' It is not the present supply or distribution of petroleum about which England is concerned, but a monopoly of the future supply and distribution after the oil resources of the United States, so heavily drawn upon to-day, shall have been exhausted. Then American companies will be out of the running and American industries, automobiles, airplanes, and merchant and naval ships will obtain their supplies of oil at a price and in a quantity to suit the convenience of foreign producers in a virtual monopoly."

In reply to the charges of discrimination, which it denies, the Dutch Government tells us that when competition for the oilfields in the East Indies was free to all companies several years ago, American oil concerns displayed no interest whatever.

Moreover, we are reminded in the *New York Journal of Commerce* of some of our own sins:

"Our shipping policy is discriminating, and our immigration limitations as well as various less familiar elements in the Federal policy all run counter to the ideals of internationalism which seem to lie at the root of the note to Holland. We can not be international where American foreign

trade is concerned and national where the foreign trade of other countries is at stake. It will require the exercise of very great diplomatic ingenuity to present our case in such a way as to offset this outstanding fact in the situation."—*The Literary Digest*, May 21, 1921.

#### CURRENT NAVAL AND PROFESSIONAL PAPERS

Effect of Temperature and Specific Gravity on Storage Battery Operation. *Power*, May 24, 1921.

Atmospheric Disturbances, or Static, in Radio Telegraphy. *The Journal of the Franklin Institute*, May, 1921.

The Scientific Control of Combustion. *Engineering and Industrial Management*, May 12, 1921.

Submarine Warfare. *The Journal of the Royal Artillery*, May, 1921.

The Use of the Air Force for Replacing Military Garrisons. *The Journal of the Royal United Service Institution*, May, 1921.

Must We Fight Japan. A Review of Prof. Pitkin's book. *National Service*, May, 1921.

Twenty years of Marine wireless. *The Nautical Gazette*, May 21, 1921.

Determination of Position of Aircraft by Radio. *Flying*, June, 1921.

Aluminum and its Alloys in Engineering. *The Engineering*, May 6, 1921.

Recent Improvements in Steam Turbine Design. *The Engineer*, May 6, 1921, *et seq.*

Pneumatic Transmission of Messages on Warships. *Engineering*, May 6, 1921.

Large Gyroscopes for Stabilizing Ships. *Engineering*, May 6, 1921.

Aeroplane Superchargers. Translated from the German. *Aerial Age Weekly*, May 30, 1921.

# NOTES ON INTERNATIONAL AFFAIRS FROM MAY 10 TO JUNE 10

PREPARED BY  
ALLAN WESTCOTT, Professor, U. S. Naval Academy

## GERMANY AND ALLIED POWERS

**GERMAN REPARATIONS PAYMENTS.**—Complying with the terms of the Allied ultimatum of May 5, Germany on May 30 completed her initial reparations payment of one billion gold marks by turning over to the Reparations Commission in Paris the equivalent of 160 million gold marks in currency, and presenting German treasury bonds for the remainder. These bonds were twenty in number, each for about \$10,000,000, and maturing within three months. The first two were paid as they fell due early in June. Germany's plan of taxation to cover reparations payments includes mortgages on 20% of all real estate at pre-war value, and also a 20% government share in all business enterprises.

**WIRTH CABINET ORGANIZED.**—Following his appointment as head of the German Cabinet at the time of the reparations crisis in early May, Chancellor Wirth encountered difficulty in filling portfolios and securing parliamentary support. For the time being, he assumed the post of foreign minister. On June 5 the Reichstag gave a vote of confidence of 213 to 77 (48 of the German People's Party not voting.) The majority came from the three parties composing the government coalition—Centrists, Majority Socialists, and Democrats—supported also by the Independent Socialists. Without votes from the parties of either the right or the left wing, the three-party coalition hardly supplied a safe working majority.

**TRIALS OF WAR OFFENDERS AT LEIPSIK.**—Trials of Germans accused of crimes against established laws and customs of war, as called for by the Versailles Treaty, began at Leipsig in June. Three of the accused were convicted and given varying sentences. Lieut. Neumann was acquitted on the charge of sinking a British hospital ship, on the ground that he was obeying the orders of his superiors.

## ALLIED CONTROL IN SILESIA

**NEUTRAL ZONE ESTABLISHED.**—As a means of stopping hostilities in Silesia, France and Great Britain in early June agreed upon the policy of establishing a neutral zone between the parts of Silesian territory occupied respectively by German and Polish irregular forces, the neutral zone to be held by British and French troops. No final allotment of the disputed districts was to be made until hostilities ceased. In execution of this policy, British troops were despatched to Silesia, the first detachments arriving about June 1.

Speaking in parliament on May 13, Premier Lloyd George declared himself strongly for "fair play" toward Germany in the Silesian difficulty, saying that either Allied troops should be used to prevent the Poles from unwarranted seizure of territory, or the Germans should be allowed to defend themselves. He held Poland responsible for the activities of irregulars under General Korfanty.

Premier Briand, defending his foreign policies in the French Chamber, received on May 26 a favorable vote of 403 to 163. The French premier opposed the British plan for an immediate meeting of the Supreme Council at Boulogne to discuss Silesia. Instead it was decided that the authority of the Interallied Commission should first be reestablished in the territory under dispute, and an additional commission appointed to settle boundaries. On May 28 an armistice was negotiated between the German and Polish factions.

**AMERICA REFUSES INTERVENTION.**—To a long appeal from Poland for American assistance in the Silesian affair, Secretary Hughes on May 18 made public the following answer:

In reply I have the honor to inform you that, in my opinion, the settlement of such boundary disputes as arise in the case under consideration is a matter of European concern, in which, in accord with the traditional policy of the United States, this government should not become involved. The attitude of the government in this matter is clearly understood by its representatives in Europe, who will, therefore, as far as at present may be seen, take no part in the discussions concerning Upper Silesia, and will express no opinion as to the settlement.

### LEAGUE OF NATIONS

**COL. HARVEY CONDEMNS LEAGUE.**—In a speech at a dinner in his honor given by the Pilgrims on May 19 in London, Ambassador Harvey interpreted American foreign policy in a manner that attracted general attention. He declared that while, in the words of President Harding, the United States would "play its full part in joining the peoples of the world in pursuit of peace," it would not be "beguiled into the League of Nations." Col. Harvey announced at the same dinner that he had been authorized to attend the meeting of the Supreme Council, if one were held to discuss Silesia.

**AMERICAN PLAN FOR A LEAGUE.**—According to press reports at the close of May the policy of the American Government was tending to favor an association of nations to be developed out of the present Supreme Council of the Allied Powers, supplemented by an international court of justice. It was stated also that informal inquiries regarding an international conference on reduction of armaments had already been made by Ambassador Harvey.

**PROGRAM FOR LEAGUE COUNCIL.**—Geneva, June 6 (Associated Press).—Amendments to the covenant of the League of Nations, mandates, the Polish-Lithuanian dispute, settlement of the Aland Islands question, and the protests of Germany against the presence of French troops in the Sarre Basin and of Poland against the decisions of the High Commissioner in Danzig regarding the maintenance of Polish troops in the port will take

up a great part of the approaching session of the Council of the League.

Dr. V. K. Wellington Koo of China will make a report on the Sarre administration, with special reference to Gergany's complaint concerning the use of French money to pay the miners, as well as the garrisoning by French troops.

Viscount Ishii of Japan will present a report on the terms of Class B mandates, and M. Hymans of Belgium will report on the Class A mandates. It is understood these reports will concern only the terms under which the mandates shall be exercised, and will not relate to the question of the allocation of the territories, including the Island of Yap, subject to mandates.

Arthur J. Balfour, Chairman of the Special Amendments Commission, will present its report on amendments to the covenant, with the draft of the notice to the forty-eight members of the League concerning the proposed amendments to be voted on at the September meeting of the Assembly of the League.

The Secretariat of the League of Nations has received from the Hungarian Chargé at Berne a formal application for the admission of Hungary to the League. The application will be placed on the agenda of the Assembly, which will meet in September.—*N. Y. Times*, July 6, 1921.

**ARMAMENT COMMISSION MEETING POSTPONED.**—The meeting of the Armament Commission of the League of Nations, scheduled to meet at Geneva on June 10, was postponed until July 10 and shifted to London.

## GREAT BRITAIN AND IRELAND

**RESULTS OF IRISH ELECTIONS.**—The election to the Southern Parliament of Ireland, held on May 12, resulted in a complete victory for the Sinn Fein. There was no polling, since there were no opposition candidates. Of the 128 seats all but four (for Dublin University) were filled by Sinn Feiners. Of the new members more than half are now imprisoned, and since none will take the oath of allegiance, the parliament will not function, and the viceroy must either organize a provisional government or put all Southern Ireland under martial law.

In Ulster the elections resulted in the choice of 40 Unionists, 6 Nationalists, and 6 Sinn Feiners. At the formal opening of the Northern Parliament on June 7 the Sinn Feiners and Nationalists did not appear. Premier Sir James Craig was first to take the oath of office; R. W. H. O'Neill was elected speaker. It was expected that King George, and possibly Premier Lloyd George, would be present at the state opening on June 21.

**BRITISH IMPERIAL CONFERENCE.**—An Imperial Conference of Premiers of British Dominions and Colonies was scheduled to meet in London on June 22, the problems to be considered including naval support, the Anglo-Japanese Treaty, trade and political relations between the mother country and the dominions, and an imperial constitution. President Butler of Columbia was invited to address the conference.

## AUSTRIA.

**PLEBISCITES FOR UNION WITH GERMANY.**—An unofficial plebiscite held in the province of Salzburg on May 29 resulted in an almost unanimous vote in favor of union with Germany. An earlier plebiscite in Tyrol



resulted similarly, and another was to be held in Styria on July 3. The Austrian Government objected to these plebiscites as certain to have an unfortunate effect upon Austria's relations with neighboring states and with the Allied Powers. Without credit and strength, however, the central government at Vienna could do little to check the "Anschluss" movement. On June 1 the Mayr Cabinet resigned.

CONFERENCE AT PORTO ROSA.—Washington, June 7.—The Inter-Allied Conference for the consideration of ways and means of improving economic conditions in Central and Southern Europe will be held at Porto Rosa on June 15, this government was officially informed today.

This meeting, originally set for April 15, was postponed because of difficulty in agreeing upon a program. Great Britain, France and Italy will be officially represented at the meeting, and several smaller powers more directly interested will probably send spokesmen.

It has been definitely decided that the United States will be represented unofficially at the conference by Lieut. Col. Clarence B. Smith, former American representative on the Austrian section of the Reparations Commission.—*N. Y. Times*, July 6, 1921.

### ITALY

GIOLITTI COALITION WINS ELECTION.—The parliamentary elections held in Italy on May 15 resulted in the choice of 226 members of the parties forming the coalition in support of Premier Giolitti. Of the total 535 members of the Italian parliament, the Socialists elected 134; Catholics, 102; Republicans, 8; followers of former premier Nitti, 15; Slavs, 6; and Germans, 4. The Slavs and Germans came from recently annexed territory. As a result of the elections the Socialists suffered a reduction from 170 to 134 seats. Numerous casualties were due to conflicts between Socialists and the patriotic organization of Fascisti.

### NEAR EAST

BRITISH POLICY IN TURKEY.—London, June 9.—A conference of Ministers was held at Chequers today on the situation which has arisen in the Near East.

The new facts are, that since the failure of the last Greek offensive against Kemal two months ago, his government at Angora has assumed a truculent and uncompromising hostility towards Great Britain. The Kemalists have closed down some mines belonging to British subjects in Anatolia, on the ground that they belong to "belligerent" subjects, thus designating the British as belligerents. Kemal's Government, also, has prohibited British ships from touching at Turkish ports, and they have refused to stand by their own agreement signed in London relating to prisoners, having even seized some further British subjects and shot a British Indian. The Kemalist Extremists also have thrown over both Bekir and Sami and the agreement he made with the French, and they have just refused to receive M. Franklin-Bouillon, who wished to go to Angora as the French Agent.

Whether the Extremists at Angora have absorbed Mustapha Kemal or whether he is leading them as before may be in doubt, but what is not in doubt is that his government is receiving arms and munitions from Bolsheviks in Russia and that in sympathy with Bolshevik counsels they are defying the Western powers.

The Greeks are now contemplating a new offensive in Anatolia, the issue of which, says *The Chronicle's* diplomatic correspondent, may be pregnant with results affecting Europe.

The correspondent points out that if the Greeks were defeated and driven back to Constantinople, where there are British troops, would be in danger, and if the Kemalists gained Constantinople not only would they close the straits and so rob the Allies of one object for which the war in the East was waged, inflicting thus a deep wound on allied prestige in the Middle East, but they would without doubt proceed to attack Thrace and set the Balkans again in a blaze. It will be seen, therefore, how a situation may arise affecting closely British interests.

The British Government, although no fresh decision is called for at the moment, might, if the Kemalist hostility be persisted in, have to consider certain steps against the Kemalists. A blockade of Black Sea ports would cut off the supply of munitions to the Turks and the raising of the British embargo on the sale of arms and munitions would enable the Greeks to strengthen their forces. It may be anticipated, adds the correspondent, that no policy would be adopted which would involve this country in anything in the nature of a land campaign, but the pressure of events might necessitate Britain giving indirect assistance to the Greeks.

**NEW GREEK OFFENSIVE AGAINST TURKS.**—A new Greek offensive against the Turkish Nationalists was planned for the third week in June. The Turkish forces were estimated at about 100,000, against which the Greeks could launch 120,000 men, with superior equipment secured from Great Britain. King Constantine was to leave for the front on June 11.

## FAR EAST

**JAPANESE FOREIGN POLICY.**—Tokio, June 2 (Associated Press).—The *Hochi Shimbun* says to-day that it has reason to believe that Japan has proposed to give the United States the Yap-Guam cable, with the privilege of control of the line to the Island of Yap. While Japan intends to keep the mandate, the newspaper says, she considers this to be virtual internationalization.

The Parliamentary Committee of the *Kensei-kai*, or opposition party, published a statement to-day that Viscount Uchida, the Foreign Minister, in receiving the members of the committee yesterday, said that Japan did not claim the exclusion of Manchuria and Mongolia from the Chinese consortium, but had insisted on assurance of protection of Japan's economic and general defense interests, to which the powers had consented. The committee asked what Japan would do if these claims were not granted. The Foreign Minister expressed confidence that the United States and Great Britain would observe the spirit of the agreement.

Asked if Japan should insist to the last on the Yap mandate and what was the government's policy, Viscount Uchida said:

"Of course, Japan will adhere to the mandate, but we are negotiating with Washington concerning the disposition of the Yap cables."

He further said that the time for the evacuation of Siberia had not arrived.

"Is Japan endeavoring to have China open negotiations for the restoration of Shantung by adopting a new policy?" the Foreign Minister was asked.

"No," he replied. "No negotiations have been opened by the two governments." *N. Y. Times*, March 6, 1921.

**REDS IN VLADIVOSTOK OVERTHROWN.**—At the close of May the Soviet authorities in Vladivostok were overthrown by anti-red forces, the remnants of Kolchak's army. The anti-red forces afterward advanced towards Chita, in East Baikal, the seat of the Far Eastern Republic.

It was stated by Japan that her troops in Vladivostok maintained a neutral attitude, but the Japanese commander at Vladivostok announced that,

in view of the situation developed, the Japanese would occupy various Siberian towns of strategic importance.

Following the fall of Vladivostok the Russian Foreign Minister, M. Tchitcherin, protested to the British and French Governments against the alleged unneutral policy of Japan in Siberia. On June 9, Earl Curzon replied for the British Government, pointing out that the charges were not supported by evidence, and refusing further correspondence on the subject.

#### UNITED STATES AND MEXICO.

**TREATY PROPOSALS.**—Mr. George T. Summerlin, American Chargé d'Affaires in Mexico, on May 29 presented a memorandum to President Obregon containing the outlines of a proposed political and commercial treaty between the United States and Mexico. To this memorandum President Obregon made a preliminary reply on June 6, and later expressed objection to certain parts of the proposed treaty, on the ground that they involved a violation of the Mexican constitution.

Secretary Hughes on June 7 issued a statement of the relations between the United States and Mexico, reading in part as follows:

"The fundamental question which confronts the Government of the United States in considering its relations with Mexico is the safeguarding of property rights against confiscation. Mexico is free to adopt any policy which she pleases with respect to her public lands, but she is not free to destroy without compensation valid titles which have been obtained by American citizens under Mexican laws. A confiscatory policy strikes not only at the interests of particular individuals, but at the foundations of international intercourse, for it is only on the basis of the security of property, validly possessed under the laws existing at the time of its acquisition, that commercial transactions between the peoples of two countries and the conduct of activities in helpful co-operation are possible.

"This question should not be confused with any matter of personalities or of the recognition of any particular Administration. Whenever Mexico is ready to give assurances that she will perform her fundamental obligation in the protection both of persons and of rights of property validly acquired, there will be no obstacles to the most advantageous relations between the two peoples.

"This question is vital because of the provisions inserted in the Mexican constitution promulgated in 1917. If these provisions are to be put into effect retroactively, the properties of American citizens will be confiscated on a great scale. This would constitute an international wrong of the gravest character and this government could not submit to its accomplishment. If it be said that this wrong is not intended, and that the constitution of Mexico of 1917 will not be construed to permit, or enforced so as to effect, confiscation, then it is important that this should be made clear by guarantees in proper form. The provisions of the constitution and the executive decrees which have been formulated with confiscatory purposes make it obviously necessary that the purposes of Mexico should be definitely set forth.

"Accordingly this government has proposed a treaty of amity and commerce with Mexico, in which Mexico will agree to safeguard the rights of property which attached before the constitution of 1917 was promulgated.

## REVIEW OF BOOKS

---

"Arithmetic for Engineering." By Charles B. Clapham, Hons. B. Sc. Eng., London, Goldsmiths' College. pp. xi, 465. Price \$4.00. (New York: E. P. Dutton & Co.)

"Mathematics for Engineers." By W. N. Rose, B. Sc. Eng., London, Goldsmiths' College. In two parts, pp. xiv, 510 and xiv, 419. Part I \$6.00, Part II \$7.00. (New York: E. P. Dutton & Co.)

These three books are meant to bridge the gap between two sorts of treatises: those that lean so far toward the practical as to give little or no scientific basis for the mathematical processes used by engineers, and those that are so academic as to be too difficult for any but college trained men either to comprehend or to apply to everyday problems.

Useful processes are introduced in many instances before it is advisable to present proofs of the principles upon which they depend, and are followed by explanations, more or less complete, after further progress has been made. Proofs likely to be found too intricate or too abstract are abbreviated or omitted, and typical concrete instances are used to show the general truth. Approximate methods are in some instances distinguished from those that are exact; in other instances such discrimination is lacking or incomplete. The choice in most of these cases seems wisely made.

Readers without technical training are likely to find as great difficulty with these books as readers without adequate schooling find with the ordinary academic texts. The problems are direct from practice, with little attempt to simplify their technicalities.

The Arithmetic for Engineers presents ordinary arithmetical processes, simple algebra, mensuration, logarithms, graphs and the use of the slide rule. Some of the presentation, especially in the case of simple equations, is remarkably full and tedious; the author seems unduly impressed either with the difficulty of the subject or with the simplicity of his readers. In parts much space is given to warnings against possible errors. These characteristics are much less prominent in the later volumes and are partly accounted for by the author's desire to make the book useful to those who must study without teachers.

Part I of the Mathematics for Engineers reviews and extends the presentation of algebra, and treats practical mensuration, the use of graphs and plane trigonometry. Part II is devoted to the calculus and its applications; the theoretical treatment here is fuller than the earlier parts of the series would lead one to expect. Graphical and mechanical methods of differentiation and integration are given full prominence, but analytical methods are not slighted. The problems in the second part give the reader insight into principles of physics, mechanics, strength of materials, hydro-mechanics, and ship-design. There are chapters devoted to mean values, differential equations, physical applications, harmonic analysis, probability and least squares. A chapter on polar coordinates is interpolated, and another on the solution of spherical triangles. The graphic solution given

for the spherical triangle is of little value; it does not compare at all favorably with the use of stereographic projections, which in a book of this nature might readily have been presented in brief form as the outcome of four or five principles.

The D. U. Series is full of interest and valuable information for a person trained in either school or shop; it could hardly be of great value to one trained in neither.

P. C.

"Drake, Nelson and Napoleon." By Sir Walter Runciman, Bart. Price \$4.50. (G. P. Putnam & Sons.)

In this interesting work Sir Walter Runciman deals first with Drake and his *Confreres*—the great sailors of the Elizabethan Period—pirates according to present standards, but pure patriots according to those of the age in which they lived. They discovered new lands, opened up new avenues of commerce and fought the Spaniards wherever they could be found. In fact, Drake, the greatest seaman of that period, pursued the Spaniards into their own ports and captured their towns and ships on the Spanish Main where the prizes of war consisted of vast ransoms and rich plunder. Drake and the leaders of his time may be considered the seeds or roots from which sprang the modern British Sea Power with its fine traditions dating back to the seventeenth century.

Nelson may be considered the flower of the plant of which Drake was the seed. He has had no peer as a naval leader, but Sir Walter deals at length with Nelson as a man. In fact the major portion of the book treats of Nelson and his affair with Lady Hamilton. Sir Walter certainly calls black, black, and white—but no, there is no white to be found here.

It is amazing to read how this man—so great as a leader and still greater in the presence of the enemy—could be so mawkishly weak in his personal conduct. It makes one think of a strong and wise man made weak and foolish by too free use of liquor. And the corroding influence of his impure passion is shown to have affected finally Nelson's judgment.

As Nelson was undoubtedly the greatest stumbling block in the ambitions of Napoleon, Sir Walter treats of Napoleon in the last part of the book. Here is shown the errors of diplomacy committed by the weak English King and diplomats of the time. According to Sir Walter these English leaders failed to recognize the legitimacy of Napoleon's efforts, and instead of uniting with him as they should have done, they united with the rest of Europe to overthrow and send him to an exile's death. By so doing they made the grievous error of clearing the field for Prussia which later combined, as clearly foretold by Napoleon, with the minor German States to form the German Empire. These errors of Englishmen were the seeds of the Great War with its overwhelming losses of blood and treasure.

Thus Sir Walter shows that the Great War was not the result of the act of an assassin but that the causes date back more than a century.

This is a most interesting book. One does not often read such frank opinions of men and their acts as Sir Walter expresses. It is most refreshing.

T. L. J.

"The Machinist's Blue Book." E. R. Glass, Editor. Price \$4.00. (By International Association of Machinists Publishing Co., 25 West Street, New York.)

This book is a compilation of different mechanical subjects, and its nature is more nearly that of an aid to the worker than a text book for the student. It is essentially practical, describing not merely what to do, but *how* to do it and should be invaluable to the engineer, shop manager, or repair officer.

The contents are somewhat loosely arranged, consisting apparently of contributions from a large number of practical machinists.

The following is a general outline of the subjects handled: Properties of metals, alloys, etc. Influence of different elements on steel. Tempering, hardening, and testing of metals. Measuring instruments, verniers, micrometers, gauges, of all kind. A discussion of the slide valve, with the Stephenson link and Walschaerts gear for locomotives, and very complete instructions for valve-setting.

Bearings, their lubrication, and adjustment, re-lining and fitting. A treatise on all the common machine tools, lathes, drills, boring machines, planers, shapers, slotting, and milling machines. This part of the work goes deeply into the mechanism of the machines themselves, with their accessories, tools, methods of testing, centering, adjustment, face plate and chuck work, tapering, reaming, drilling, boring and screw cutting; the forging, tempering and grinding of tools; cutting angles, cutting speeds, etc. Similar matter for all the different machine tools with special instructions for the design and cutting of gear teeth.

Blue prints and mechanical drawings, and how to read them. Forge work, with welding, tempering, and hardening. Bench work, hammering, filing, chipping, broaching, tap-and-die threading.

Grinding machines, with the forging, hardening, and tempering of all kinds of drills and cutters. Formulae for the design of gears and gear teeth.

Pipes and pipe-fitting, flanges, couplings, gaskets, expansion-joints, with soldering, brazing, lead-wiping and other methods of joining. The grinding and re-seating of valves.

Mill-wright work, including engine foundations and the lining up of engines, shafting, etc. Special kinks and information of a useful nature for shop work.

Questions and answers in gas engines, turbines, condensate pumps, air ejectors, condensers, reduction gears and electricity. Spontaneous combustion, analysis of coal, chemical tests of water and a dictionary of terms used in shipbuilding.

Questions and answers on shop work.

About one-fifth of the whole book is devoted to welding by the oxy-acetylene process. This is most complete, covering the general theory, properties of metals to be handled, preparation, pre-heating, numerous examples of the method to be used in different cases, and a description of the plant for generating the gases required.

A large number of useful tables are included in the body of the work, comprising the following:

Tensile strength of materials, equivalents of millimeters in decimals of an inch, of fractions of an inch in millimeters, demical equivalents of parts of an inch, decimal equivalents of Stubs' steel wire gauge, and of twist drills and steel wire gauge by number.

U. S. Standard Gauge for sheets and plates, giving No. of gauge, thickness in fractions of an inch and in decimals, and weight per square foot in ounces and pounds. Comparative table of various standard gauges. Thickness and weights of iron and steel sheets by Birmingham Wire Gauge and Brown and Sharpe.

Table of sharp V-threaded screws, of thread parts for Acme Standard or 29° thread, of Morse tapers for shanks and sockets, of lathe cutting speeds for different materials, of Footstock Setovers for Morse and Brown and Sharpe tapers.

Table of lathe cutting speeds in feet per minute for various diameters of work and speed of revolution, of lubricants for cutting various materials, of decimal equivalents of normal sizes of drills for tapping.

Thread tables for Whitworth Standard, British Standard Fine, and Acme Standard. Tables for tap drills, giving size of tap, number of threads, and size of drill hole. Tables of tooth parts for gearing in terms of diametral and circular pitch, thickness of tooth, etc.

Table of dimensions and weights of pipe fittings, etc. Tables of allowances and limits for sliding, driving, and shrinkage fits. Tables of ordinary weights and measures, of areas and circumferences of circles, and of squares, cubes, square and cube roots.

The foregoing sounds like dry reading, but as a matter of fact the book will be found of interest, not only to the machinist, but to anyone of general technical knowledge.

R. C. P.

"The Elements of Fuel Oil and Steam Engineering." By Sibley and Delany. Price \$5.00 (McGraw-Hill Book Company, Inc., 1921.)

The book is divided into three main subdivisions, the first including a general description of the modern power plant equipped with oil burning boilers and giving an exposition of the elementary laws of steam engineering; the second dealing with the efficient utilization of fuel oil in a modern power plant, and the third covering the testing of oil fired boilers and giving suggestions for conducting boiler tests and taking, recording and tabulating the data.

The description of the modern power plant is too general to be of value to any save those entirely lacking in knowledge of the subject. The presentation of the elementary laws of steam engineering is too disconnected to be of use to a beginner in this subject and not complete enough for an advanced student.

The subject of safe operation of steam boilers, the efficient operation of oil fired boilers, and furnaces in fuel oil practice is well handled.

Generally the illustrations are of little value. Many are not clear, few are described and a large number are photographs of no value to the student.

The third subdivision on testing oil fired boilers is excellent and contains many valuable suggestions.

J. O. R.

"Introduction to the Study of Submarine Warfare." By Commander A. Laurens. (Published by Augustin Challamel, Paris, France.)

In his preface to the book, Commander Laurens explaining the title states it as a brief and rather dry collection of facts concerning the action of submarines during the World War.

This most valuable collection of data, while rather dry reading, furnishes an excellent historical record to be used as a basis for study of the possibilities of submarine development in the future.

Commander Laurens takes up in chronological order the economic results brought about by submarine warfare and the political action of the various powers, allied and neutral, which were taken as the result of these economic conditions. The actual campaign of the submarines is detailed, and the offensive and defensive measures taken by the Allies to meet the enemy submarine warfare.

Commander Laurens was fortunate in being on duty at the Ministry of Marine during the greater part of the war, and was personally interested in compiling, month by month, the many valuable charts and tables in the appendix of the book. One of these tables gives the cruise of each submarine and the numbers and types of vessels sunk on each cruise. Another interesting table shows, by curves, the rise in the destruction of tonnage until April 1917, and the gradual fall until August 1918, when it became evident that the submarine warfare was a failure. Another table gives the life of each submarine. It shows how short was the life of most of the boats. A study of this table makes clear the mode of destruction; but this mode of destruction was unknown to the Germans themselves, they only knew that the boats did not return.

The British, early in the war, urged that nothing should be given out concerning this destruction of the submarines, arguing that if the Germans did not know how the boats were lost they would have great difficulty in avoiding further loss from the same cause. They further argued that the mysterious disappearance of boat after boat would eventually have a tremendous psychological effect upon the officers and men who still survived, and that they would evince greater and greater reluctance to go out to an unknown fate until finally they would be driven to mutiny. As is well known the German Navy did finally mutiny, and, no doubt this policy had much to do with the mutiny.

As a compilation of the official facts of submarine warfare this book is particularly valuable.

R. H. J.



## SPECIAL NOTICE

### NAVAL INSTITUTE PRIZE ARTICLE, 1922

A prize of two hundred dollars, with a gold medal and a life-membership (unless the author is already a life member) in the Institute, is offered by the Naval Institute for the best original article on any subject pertaining to the naval profession published in the PROCEEDINGS during the current year. The prize will be in addition to the author's compensation paid upon publication of the article.

On the opposite page are given suggested topics. Articles are not limited to these topics and no additional weight will be given an article in awarding the prize because it is written on one of these suggested topics over one written on any subject pertaining to the naval profession.

The following rules will govern this competition :

1. All original articles published in the PROCEEDINGS during 1921 shall be eligible for consideration for the prize.

2. No article received after October 1 will be available for publication in 1921. Articles received subsequent to October 1, if accepted, will be published as soon as practicable thereafter.

3. If, in the opinion of the Board of Control, the best article published during 1921 is not of sufficient merit to be awarded the prize, it may receive "Honorable Mention," or such other distinction as the Board may decide.

4. In case one or more articles receive "Honorable Mention," the writers thereof will receive a minimum prize of seventy-five dollars and a life-membership (unless the author is already a life member) in the Institute, the actual amounts of the awards to be decided by the Board of Control in each case.

5. The method adopted by the Board of Control in selecting the Prize Essay is as follows :

(a) Prior to the January meeting of the Board of Control each member will submit to the Secretary and Treasurer a list of the articles published during the year which, in the opinion of that member, are worthy of consideration for prize. From this a summarized list will be prepared giving titles, names of authors, and number of original lists on which each article appeared.

(b) At the January meeting of the Board of Control this summary will, by discussion, be narrowed down to a second list of not more than ten articles.

(c) Prior to the February meeting of the Board of Control, each member will submit his choice of five articles from the list of ten. These will be summarized as before.

(d) At the February meeting of the Board of Control this final summary will be considered. The Board will then decide by vote which articles shall finally be considered for prize and shall then proceed to determine the relative order of merit.

6. It is requested that all articles be submitted typewritten and in duplicate; articles submitted written in longhand and in single copy will, however, receive equal consideration.

7. In the event of the prize being awarded to the winner of a previous year, a gold clasp, suitably engraved, will be given in lieu of the gold medal.

By direction of the Board of Control.

H. K. HEWITT,

*Commander, U. S. N., Secretary and Treasurer,*



Mar 30.18

# United States Naval Institute

## Proceedings

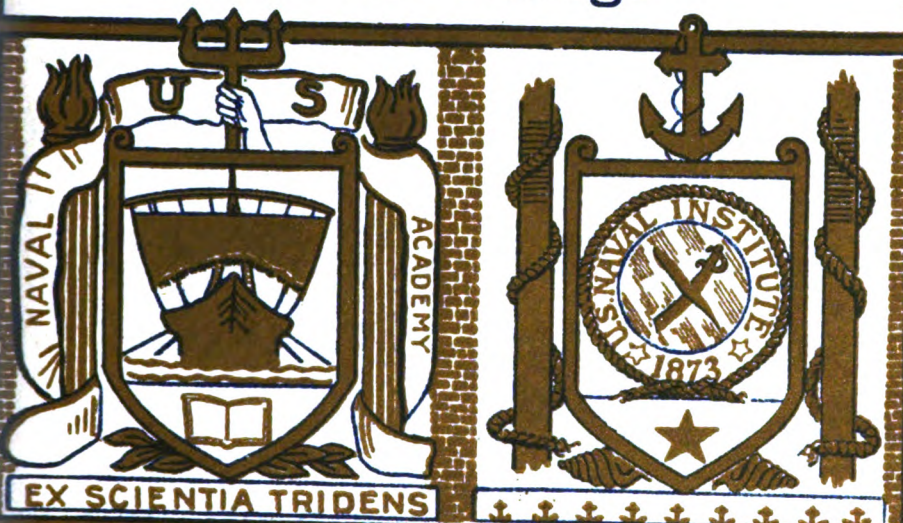

The writers only are responsible for the contents of their respective articles

### CONTENTS

	PAGE		PAGE
A Study of Our Navy Personnel Situation.— Taussig . . . . .	1153	An Analysis and Discussion of Various Sys- tems of Promotion in the Navy, with Out- lines of a Proposed New System of Transfer from the Active List.—Bryan . . . . .	1251
Radio Communications. From an Operator's Viewpoint.—Ingraham . . . . .	1201	Discussion . . . . .	1271
Amalgamation and Specialists Versus Corps.—Fisher . . . . .	1209	Secretary's Notes . . . . .	1276
The Factor of Safety in Navigation.—Todd . . . . .	1221	Professional Notes . . . . .	1279
New Ballistic Corrections.—Hawkesworth . . . . .	1233	Notes on International Affairs . . . . .	1311
		Review of Books . . . . .	1319
		Information Index . . . . .	1278

Copyright, 1921, by J. W. Conroy, Trustee for U. S. Naval Institute

Entered at the Post Office at Annapolis, Maryland, as Second Class Matter

# WORLD'S ONLY MANUFACTURER

Moulded High Frequency—High Tension Insulators and Insulating Parts

~~THE~~ **INSULATORS, 1,000 TO 1,000,000 VOLTS**

INSULATION

"MADE IN AMERICA"



REGISTERED U.S. PATENT OFFICE

Louis Steinberger's Patents

INSULATION

"MADE IN AMERICA"

**"ELECTROSE" Insulators are standard with UNITED STATES NAVY and ARMY and WIRELESS TELEGRAPH and TELEPHONE COMPANIES.**

**"ELECTROSE" is made in a number of grades for various requirements, each grade possessing special characteristics.**

**"ELECTROSE" INSULATORS—BEST IN THE WORLD FOR HIGH FREQUENCY CURRENT POWER AND TRANSMISSION CIRCUITS**

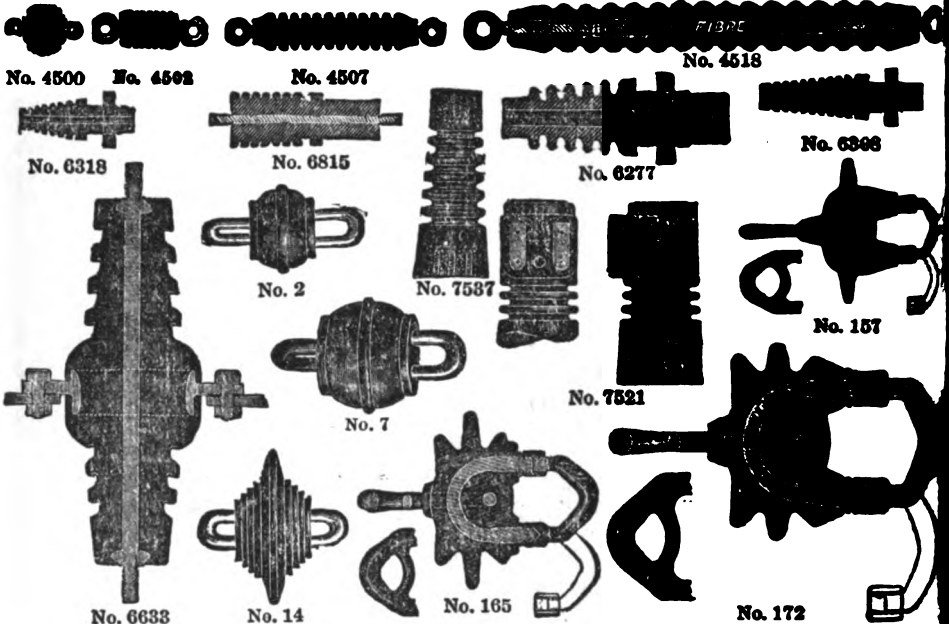

## "ELECTROSE" STANDARD PRODUCTS

**"Arcover" disk strain and suspension line insulators, "Safety Strain" insulators, Disk, Hook, Thimble and Rod type strain insulators, Spool and Bracket-Arm strain insulators, Pin type insulators, Insulator pins, Roof, Barrier and Wall Bushings and Insulated Connectors, single and multi-part, plain and locking, water and gas tight, Bus-bar insulators, Insulating Supports and Pedestals, Arc Lamp Insulators, Insulating Knobs and Handles, Insulating Sheets, Tubes and Rods, etc.**

**"Electrose" Railway Line Material:—"Safety Strain" Insulators, Brooklyn Strain Insulators, Insulated Turn-Buckles, Caps and Cones, "Ideal" Locking Caps and Cones, Insulating Bolts, Feed Wire Insulators, Third Rail Insulators, also special forms of Trolley Wire Suspension Insulators, etc., etc. Complete line always carried in stock.**

**Ignition Insulating Parts:—Distributor Blocks, Disks, Switch Bases, Spools, Brush Holders, Knobs, Handles, etc., etc.**

**"Electrose" insulation (certain grades) is recognized as the best obtainable for use in connection with insulating parts for ignition service for Automobiles, Aeroplanes, Motor Boats, etc.**

**Insulators and Insulating Parts and Devices of special sizes and forms, designed and made to order.**

Sole Manufacturers



66-82 Washington St. 27-37 York St.

66-78 Front St. 1-23 Flit St.

**BROOKLYN, N. Y., AMERICA**

Please mention the PROCEEDINGS when writing advertisers

Vol. 47, No. 8

August, 1921

Whole No. 227

---

# United States Naval Institute Proceedings

PUBLISHED MONTHLY  
EDITED BY H. K. HEWITT



U. S. NAVAL INSTITUTE  
ANNAPOLIS — MARYLAND

COPYRIGHT, 1921  
By J. W. CONROY  
TRUSTEE FOR U. S. NAVAL INSTITUTE

**The Lord Baltimore Press**  
BALTIMORE, MD., U. S. A.

*The writers only are responsible for the contents of their respective articles*

## CONTENTS

---

A STUDY OF OUR NAVY PERSONNEL SITUATION. By Captain J. K. Taussig, U. S. Navy .....	1153
RADIO COMMUNICATIONS. From an Operator's Viewpoint. By Lieut. Commander C. N. Ingraham, U. S. Navy.....	1201
AMALGAMATION AND SPECIALISTS VERSUS CORPS. By Cominander J. O. Fisher, U. S. Navy .....	1209
THE FACTOR OF SAFETY IN NAVIGATION. By Commander Forde A. Todd, U. S. Navy .....	1221
NEW BALLISTIC CORRECTIONS. By Alan S. Hawkesworth, F. R. S. A..	1233
AN ANALYSIS AND DISCUSSION OF VARIOUS SYSTEMS OF PROMOTION IN THE NAVY, WITH OUTLINES OF A PROPOSED NEW SYSTEM OF TRANSFER FROM THE ACTIVE LIST. By Rear Admiral B. C. Bryan, U. S. Navy .....	1251
DISCUSSION .....	1271
SECRETARY'S NOTES .....	1276
PROFESSIONAL NOTES .....	1279
NOTES ON INTERNATIONAL AFFAIRS .....	1311
REVIEW OF BOOKS .....	1319
INFORMATION INDEX .....	1278

## OFFICERS OF THE INSTITUTE .

---

### *President*

REAR ADMIRAL BRADLEY A. FISKE, U. S. NAVY

### *Vice President*

REAR ADMIRAL HENRY B. WILSON, U. S. NAVY

### *Secretary and Treasurer*

COMMANDER H. K. HEWITT, U. S. NAVY

### *Board of Control*

REAR ADMIRAL BRADLEY A. FISKE, U. S. NAVY (*ex officio*)  
REAR ADMIRAL HENRY B. WILSON, U. S. NAVY (*ex officio*)  
BRIGADIER GENERAL GEORGE RICHARDS, U. S. M. C.  
CAPTAIN JOHN HALLIGAN, JR., U. S. NAVY  
CAPTAIN T. L. JOHNSON, U. S. NAVY  
CAPTAIN J. A. FURER (C. C.), U. S. NAVY  
CAPTAIN JOHN DOWNES, U. S. NAVY  
COMMANDER J. O. RICHARDSON, U. S. NAVY  
COMMANDER H. K. HEWITT, U. S. NAVY (*ex officio*)

## PAST PRESIDENTS

---

ADMIRAL DAVID D. PORTER, U. S. NAVY, 1873  
REAR ADMIRAL JOHN L. WORDEN, U. S. NAVY, 1874  
REAR ADMIRAL C. R. P. RODGERS, U. S. NAVY, JAN. 1875-JAN. 1878  
COMMODORE FOXHALL A. PARKER, U. S. NAVY, JAN. 1878-JAN. 1879  
REAR ADMIRAL JOHN RODGERS, U. S. NAVY, JAN. 1879-JAN. 1882  
REAR ADMIRAL C. R. P. RODGERS, U. S. NAVY, JAN. 1882-JAN. 1883  
REAR ADMIRAL THORNTON A. JENKINS, U. S. NAVY, JAN. 1883-OCT.  
1885  
REAR ADMIRAL EDWARD SIMPSON, U. S. NAVY, OCT. 1885-OCT. 1887  
REAR ADMIRAL STEPHEN B. LUCE, U. S. NAVY, OCT. 1887-OCT. 1898  
REAR ADMIRAL WM. T. SAMPSON, U. S. NAVY, OCT. 1898-OCT. 1902  
REAR ADMIRAL H. C. TAYLOR, U. S. NAVY, OCT. 1902-OCT. 1904  
REAR ADMIRAL C. F. GOODRICH, U. S. NAVY, OCT. 1904-OCT. 1909  
REAR ADMIRAL RICHARD WAINWRIGHT, U. S. NAVY, OCT. 1909-OCT.  
1911





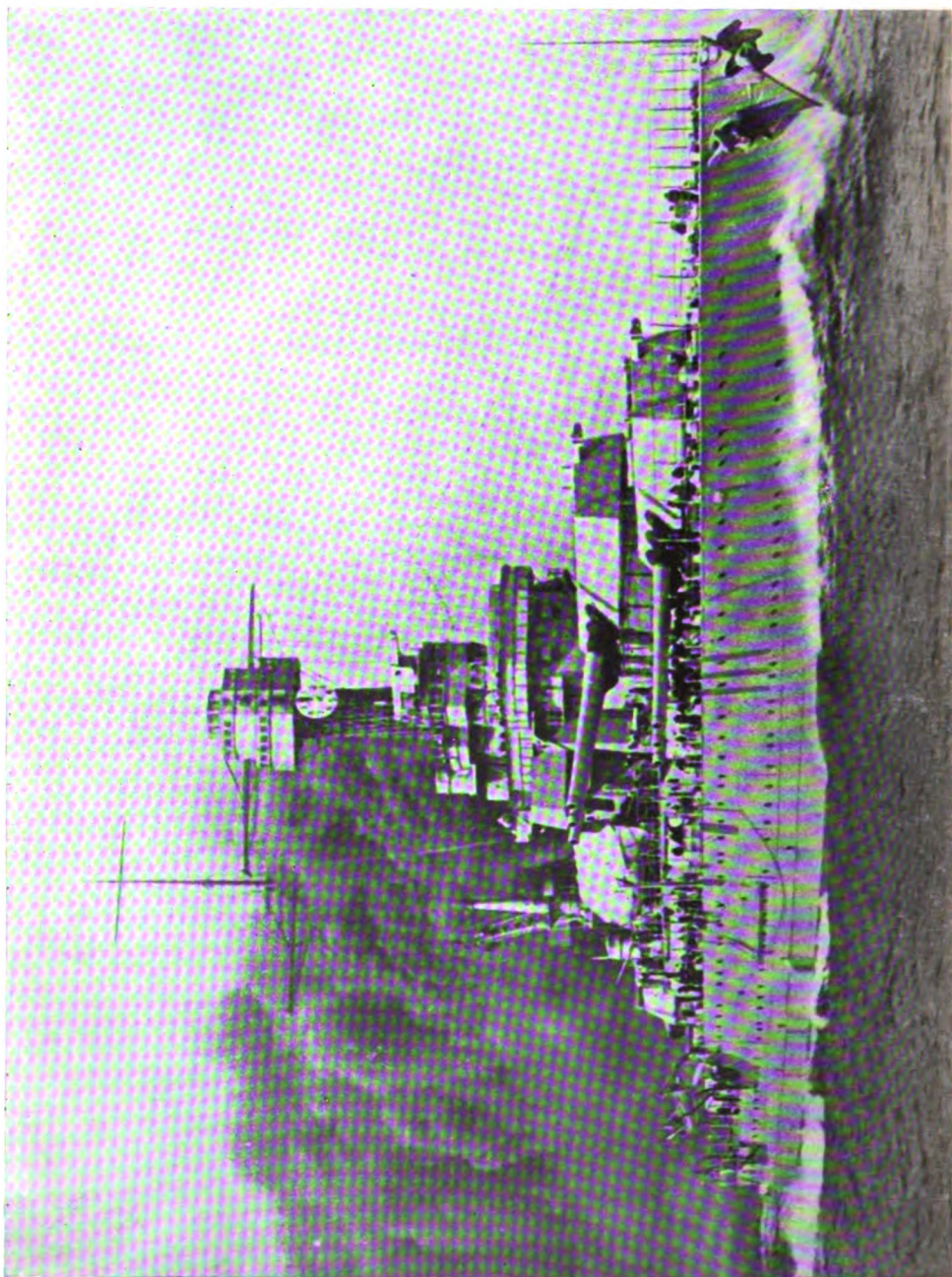

U. S. S. TENNESSEE, TAKEN DURING HER RECENT FULL POWER TRIALS

# UNITED STATES NAVAL INSTITUTE PROCEEDINGS

---

Vol. 47, No. 8

AUGUST, 1921

Whole No. 222

---

[COPYRIGHTED]

U. S. NAVAL INSTITUTE, ANNAPOLIS, MD.

---

A STUDY OF OUR NAVY PERSONNEL SITUATION

By CAPTAIN J. K. TAUSSIG, U. S. Navy

*Motto: "Men fight, not ships."*

---

## FOREWORD

In a recent address, the president of the Naval War College<sup>1</sup> said:

The sole purpose of a navy is that it may afford the country adequate protection against the aggression of possible enemies. To this end it must not only be adequate in material strength, but must be intellectually and materially ready to attack at any time, because the most efficient means of naval defense is a prompt offensive against the enemy's naval forces.

The elements of efficiency are:

1. A fleet of adequate strength in each type of vessel that is necessary to the fighting efficiency of the whole.
2. A personnel thoroughly trained in handling such a great force with the maximum possible efficiency.
3. Thoroughly digested plans to meet the strategical and tactical plans of our possible enemies.
4. A logical organization for the administration of the navy as a whole, its maintenance in readiness during peace, and its successful operation in war.

\* \* \* \*

Of the four elements, the most important is the second, that is, a personnel thoroughly trained in the art of naval warfare, . . . .

This is a clear and concise statement of the elements of efficiency as they concern the navy. A noteworthy feature is the em-

<sup>1</sup>Rear Admiral Wm. S. Sims.

phasis placed on the fact that the personnel is the most important. It is fitting that this should be brought to the attention of all who are interested in a proper development of our navy. It is especially desirable to keep in mind, in any study or consideration of our navy's needs, that this element—the personnel—has more to do with the ultimate efficiency of the navy than has any of the others. This point is set forth at the beginning of this paper because it is the custom in the navy to treat personnel as secondary to material: because it is the custom for the people of the country, their representatives in Congress, and even the naval administrators, to estimate the strength of the navy entirely on the numbers and types of ships carried on the navy list. These are customs of long standing. They are fundamentally in error. We should come to the true understanding that whether or not we build proper types of ships in adequate numbers; that whether or not we have thoroughly digested plans to meet the strategical and tactical situations which may arise; that whether or not we have a logical organization for the administration of the navy; that all these depend primarily on personnel.

We should cease to consider when speaking of the strength of the navy that it is sufficient to refer only to the material strength; that is, the number of ships. Consideration should be given as to whether or not we have the trained personnel properly to command and fight these ships. This certainly is the primary element of strength. Lord Fisher aptly stated: "Men fight, not ships." Mahan's often repeated quotation, "Historically good men with poor ships are better than poor men with good ships," is just as true to-day as in the past. It is certain that good men will get the most there is out of poor material. It is also certain that poor men will get nothing worth while out of the best material.

Our personnel situation shortly prior to the entry of this nation into the late great war is an excellent illustration of the contention that the importance of personnel has not been understood by the people of the country. It was generally known that we had a large number of fine ships. It was generally supposed that the navy was ready for any emergency. Whether or not we had the trained personnel properly to fight these ships was not even thought of. The understandings and suppositions in regard to the fighting strength of the navy were so far from the truth,

it is important, now that we are reverting to pre-war conditions, to make a brief summary of the actual status of our navy in 1916.

The facts are:

1. The authorized complements of the ships in commission were "peace" complements and were from 15 to 30 per cent less than were required in time of war.

2. The ships did not have even these inadequate peace complements on board—the battleships being many officers short, and having an average of over 100 vacancies per ship in the enlisted force. This meant that each of our battleships lacked from 300 to 400 men of the numbers necessary for their war complements.

3. There were 42 ships with only three-tenths of their peace complements on board; 16 ships with only one-tenth of their peace complements on board; 38 ships out of commission with no personnel on board. There was no personnel, active or reserve, available to fill these vacancies.

4. In case of war the immediate requirements to place all our available naval material on a fighting basis were 106,000 enlisted men and 4440 commissioned line officers, with staff officers in proper proportions.

5. There were actually in service at that time only 1920 line officers and 53,000 enlisted men. The organized reserves consisting of the upper classes of midshipmen, the retired list, the naval militia; and the unorganized reserves comprising those officers who had resigned, and those ex-enlisted men who would probably rejoin, amounted to 24,000 men and 1420 line officers. The total trained personnel was, therefore, only 77,000 men and 3340 line officers. *This left the country short of actual requirements for immediately using such naval material as was available by 1100 line officers and 29,000 men. There was no trained personnel in the country to supply this deficiency.*

6. The staff corps were correspondingly deficient in officers.

7. Much additional personnel would be required as the war progressed, and all these would have to be partially trained before being available for sea service.

It is no wonder, of course, that all our first line battleships instead of being employed immediately in the rôle for which they were intended, were converted into training ships. The reason becomes clear when we understand these facts, why we did not immediately throw all our supposed strength into a whole-hearted

offensive against the enemy. The truth is that while we had the ships, we did not have sufficient trained personnel to fight them. Consider the embarrassment that would have been ours had some unforeseen calamity happened to the Allied fleets. Our battle fleet instead of being ready to fight, was actually depleted of much of its trained personnel, and was actually engaged in training recruits instead of preparing for battle. This is not pleasant to contemplate.

We got away with the war. This is now being used as an argument by those who again are doing their utmost to deplete our naval personnel to the status in which it was just prior to the great war. It is a weak argument. No consideration is given to conditions that prevailed at that time. The fact that the fleets of our allies kept the enemy at bay is not taken into account. It is not appreciated that it was the British grand fleet which permitted our navy to prepare in security after war was declared, and it was because of this British fleet that our capital ships were not immediately called on to take the offensive, for which rôle they were not prepared owing to lack of trained personnel. To rely again on an ally to hold the enemy in check while we prepare would be the utmost folly. Such conditions are not likely to occur again. Should another war come it behooves us to be ready to jump at the crack of the bat. This cannot be done unless our *active fleet* is continually kept in commission with full complements of trained officers and men.

It is hoped that the study which follows will not be taken as a plea for a large navy, or an argument against the reduction of armaments. Nothing of this sort is intended. Nor is it the intention to estimate the numbers and types of ships this country should have in the navy. The object is to show the necessity for an active naval personnel sufficient as to numbers and suitably educated and trained in order to be able efficiently to employ such material as we now possess, and to ensure our being ready in case of an emergency.

#### THE NUMERICAL STRENGTH AUTHORIZED BY LAW

The numerical strength of the enlisted personnel is fixed by statute. The authorized numbers are as follows:

Enlisted men proper .....	131,485
Apprentice seamen .....	6,000
Authorized enlisted strength .....	137,485

In addition to the above the law provides for a hospital corps which shall equal three and one-half per cent of the authorized enlisted strength of the navy (137,485) and of the marine corps (27,000), which is 5561. This number added to the authorized strength gives:

Total authorized enlisted strength .....143,396

The number of commissioned line officers (exclusive of chief warrant officers) is automatically fixed at four per cent of the authorized enlisted strength; *i. e.*, 4 per cent of 137,485, which is 5499. This number is distributed in the various grades as shown in the following table:

TABLE I.—DISTRIBUTION OF AUTHORIZED LINE OFFICERS BY GRADES

Grade	Per cent of total	Number
Rear admiral .....	1	55
Captain .....	4	220
Commander .....	7	385
Lieutenant commander.....	14	770
Lieutenant .....	32.5	1,787
Lieutenant (J. G.) .....	.....	.....
Ensign.....	41.5	2,282
Total commissioned line officers .....	.....	5,499

The number of commissioned officers in each of the staff corps is fixed at a certain percentage of the line officers, with the exception of the medical corps and chaplains, in which cases the numbers are fixed on percentages of the total personnel in the navy and marine corps.

The distribution by grades is shown below for each corps:

TABLE II.—DISTRIBUTION OF AUTHORIZED STAFF OFFICERS BY GRADES

Corps	Number	Rear admiral	Captain	Comdr.	Others
Medical.....	1,225	6	49	98	1,072
Construction.....	275	1	23	39	212
Supply.....	660	3	26	53	578
Civil engineer.....	110	1	6	15	88
Chaplain.....	151	..	15	30	106
Total .....	2,421	11	119	235	2,056

NOTE:—There are eight officers in the corps of Professor of Mathematics. This corps ceases to exist as soon as the present incumbents complete their service.

The numbers of chief warrant officers and warrant officers are not limited by law excepting in the pay and hospital corps. The total number of officers of this class at present approximates 2000.

The remaining authorized regular naval personnel not so far listed is:

Dental corps .....	189
Flying corps (officers) .....	150
Midshipmen .....	3,136
	<hr/>
Total miscellaneous .....	3475

The total authorized personnel is summarized in the table below:

TABLE III.—TOTAL AUTHORIZED ACTIVE NAVAL PERSONNEL

Enlisted men .....	143,396
Commissioned line officers .....	5,499
Commissioned staff officers .....	2,429
Chief warrant and warrant officers .....	2,000
Miscellaneous .....	3,475
	<hr/>
Grand total .....	156,799

It should be borne in mind that the above numbers are those that are authorized by law, and that the actual numbers in the service are far short of these figures.<sup>1</sup>

#### THE FACTORS WHICH DETERMINE OUR PERSONNEL NEEDS

The law passed in 1916 which fixed the numerical ratio between the enlisted men and officers, and at the same time distributed the officers of each corps in the various grades in accordance with definite percentages, was the most important constructive personnel legislation that had been passed in many years. It did much towards stabilizing this part of the service. The anomalous feature of the law was the fixing of the ratio between officers and men, but establishing no basis for estimating the required number of men. As a rule the estimates did not take into con-

<sup>1</sup>Since writing this paper Congress has appropriated only sufficient funds to pay 106,000 men during the fiscal year ending July 1, 1922. The total authorized enlisted strength is not changed and remains at 143,306

sideration the proper balance between the material and the personnel necessary to operate the material. So long as the enlisted men were not provided for in proper numbers, it followed, of course, that the officers were likewise not in proper numbers relative to the material.

This condition has long been recognized as being one of the chief drawbacks to an efficient naval personnel. The deficiency in numbers affects the efficiency throughout because this deficiency is what causes the instability of which there is so much complaint.

The General Board appreciated this, and well expressed the evil results therefrom in its annual report to the Secretary of the Navy for the year 1916. This portion of the report stated:

The authorized enlisted strength is in no law known to the General Board fixed in any way relative to the material strength of the navy, and when additions to the fleet are made it has often been impossible to obtain the corresponding additions to the personnel which should be provided for at the same time as the ships themselves. That condition still exists. The enlisted strength of the navy is not established on any fixed basis relative to the material strength of the navy, and the efforts of the Navy Department are directed and the time of Congress is given up to annual consideration of the question of strength of the enlisted personnel. The General Board believes this condition to be illogical and it recommends that legislation be sought from Congress that will fix automatically the total strength of enlisted personnel relative to the needs of the navy on some recognized basis to be determined in the wisdom of Congress at the presentation of the matter by the Navy Department.

The whole scheme of personnel will then be established on a logical basis and one that will not require annual reconsideration by Congress. The enlisted personnel will be fixed by the material strength of the navy and the duties to be required of it. The commissioned personnel of the line will be four per cent of the enlisted personnel and the distribution of the officers in the grades will be in accordance with the percentages established by law; thus the growth of the navy in personnel will go hand in hand with the provision for the ships in a logical manner, one established by the Congress itself, and one that will not require annual consideration of the whole question with the consequent great loss of time as the least evil, and an adequate provision of personnel as a greater evil, and one that has so frequently occurred in the past.

The Navy Department has not presented this matter to Congress. The two evils pointed out are still in evidence. It now appears that the "inadequate provision of personnel . . . that has so frequently occurred in the past," is about to be repeated with the authorization of an enlisted personnel strength far below the actual needs.



If the enlisted strength is to be placed on a safe and sound basis in some such manner as recommended by the General Board, there are two questions which immediately present themselves. These questions are:

1. Is it practicable to fix on some recognized basis the total strength of the enlisted personnel relative to the needs of the navy?

2. If so, what should this basis be?

The first question can be answered in the affirmative without discussion. To answer the second question involves a somewhat long process of reasoning. To determine the basis for automatically fixing the relation between personnel and material there are a number of factors which must be considered. It will first be necessary to ascertain the enlisted strength required to operate our navy as it stands to-day on a peace basis. At the same time the officer strength will be considered. This will demonstrate whether or not the present authorized percentages as applicable to the officers, are correct.

The factors which must be considered in determining the navy's personnel strength in times of peace are:

1. The types and numbers of fighting ships that are to be maintained in full commission, in reserve, and otherwise.

2. The complements of these ships.

3. The number of auxiliaries necessary for the maintenance and operation of these fighting ships, and the complements of these auxiliaries.

4. The types and numbers of ships under construction.

5. The shore stations and shore activities for which officers and enlisted men are required.

6. The number of officers at the War College and those taking post graduate courses, and the number of men to be kept under training at all times.

7. The number of men on general detail, on re-enlistment leave, and in hospital.

8. The numerical strength of our trained reserve force.

#### THE STATUS OF OUR FIGHTING SHIPS IN PEACE TIMES

If there is a Department policy in regard to what portion of our fighting ships should be maintained in full commission in peace times, this policy has never been promulgated to the service.

In reality there is no such policy. There is, however, a fixed Department practice in regard to this matter. The practice is to keep in commission just as many fighting ships as our limited personnel will permit. This, of course, is a backward process. The logical thing is to establish a policy as to the size of our active fleet in peace times, and then obtain the officers and men necessary to carry out the policy.

The necessity for such a policy is felt by the service just as keenly as is the lack of balance between the personnel and material. When the General Board took up the personnel questions shortly before the great war, it recognized the necessity for establishing a department policy in this matter, and in its reports to the Secretary of the Navy for 1915 and 1916 made a number of recommendations which, briefly summarized, were:

1. Keep in full commission all battleships under 15 years of age from date of authorization.
2. Keep in full commission all destroyers and submarines under twelve years of age from date of authorization.
3. Keep in full commission half the cruisers.
4. Keep in full commission all the gunboats.
5. Keep in full commission all the auxiliaries necessary for the maintenance and operation of the fleet.
6. Provide 50 per cent of the full complements for battleships, cruisers, destroyers, and submarines which are not to be kept in full commission, but which would be used in war.
7. Provide adequate complements for the material upkeep of all other ships.
8. Provide adequate personnel for the shore establishments and replacements.

Had not the Great War intervened it is probable that the Department would have carried through, and established as a policy, the recommendations of the General Board as summarized above. This statement is made because the Secretary of the Navy in his annual report for 1916 gave a list of ships of the navy as it would be in 1921 on completion of the then recently authorized three years building program, and stated that all the ships listed would be in service in the status recommended by the General Board. The number of ships thus contemplated to be kept in commission in the ordinary course of events, is illuminating when compared with the actual number which our present personnel permits.

The anticipated status of the ships is given in the following table:

TABLE IV.—CONTEMPLATED COMPOSITION OF THE FLEET IN 1921 HAD NOT THE GREAT WAR INTERVENED

Type of ship	Total number	In commission full crews	In commission half crews
Battleships, first line.....	27	26	1
Battleships, second line.....	25	0	25
Battle cruisers.....	6	6	0
Armored cruisers.....	9	1	8
Scout cruisers.....	13	10	3
Cruisers, first class.....	5	3	2
Cruisers, second class.....	3	1	2
Cruisers, third class.....	10	5	5
Destroyers.....	108	72	36
Fleet submarines.....	12	12	0
Coast submarines.....	130	115	15
Monitors.....	6	0	6
Gunboats.....	18	18	0
Supply ships.....	4	4	0
Fuel ships.....	15	15	0
Transports.....	5	5	0
Tenders to torpedo vessels.....	6	6	0
Special types.....	8	8	0
Ammunition ships.....	2	2	0

The significant point in this table is concerning the large ships. It is important to note that the Department contemplated carrying out the recommendation of the General Board which called for a battle fleet in 1921 composed of 26 dreadnaughts and 6 battle cruisers. The full commissioned complements of these ships alone are 42,000 men.

The Great War prevented the three-year building program from being completed in 1921, and resulted in the acquiring of an unusually large number of destroyers and small craft of other types. It made unfeasible the carrying out of the General Board's policy of keeping in full commission ships in accordance with their age. It made evident the necessity for adopting a policy that would state the size of the battle fleet that should be kept in full commission in peace times and for keeping in commission the auxiliaries that should go with the battle fleet.

The Department, so far as is known, not having adopted a policy in regard to the size of the battle fleet, it becomes neces-

y, in order to determine the personnel requirements, here to formulate one.

#### THE SIZE OF OUR ACTIVE FLEET

In determining the number of ships that should be kept in commission in peace times, it would be desirable from a strictly naval point of view to eliminate the questions of cost and of politics. We can readily see that our navy would be more efficient at all times if all of our ships were kept in full commission. But we must count in the cost and the politics, and attempt to frame a policy that will be within reasonable bounds. The first realization must be that the present political situation will not permit of our keeping in full commission the 26 dreadnaughts as the Navy Department had contemplated five years ago. What then is the least number of dreadnaughts that should be kept in commission in peace times in order that we may assure ourselves that the navy will be ready for an immediate offensive should there be another war?

Before attempting to answer this question it is well to state that all personnel estimates will be based on the assumption of a return to the sound principle of having a single united active fleet instead of the two squadrons which are now appearing under the designation of fleets. It is essential for training in fleet tactics that the battle fleet be of sufficient size to make fleet tactics applicable. A fleet cannot be trained by dividing it into two parts any more than a football team can be developed by practicing each half in widely separated places. *We will not have an efficient fleet in time of war unless our officers and men have fleet training in times of peace.*

The War College, the Post Graduate School for officers, the Naval Academy, the trade schools and training stations for the enlisted men are all necessary adjuncts for the training of the officers and enlisted men; but none of these educational institutions, nor all of them together, will produce officers and men with the necessary practical training to fight a fleet. This practical knowledge can be had only through actual maneuvers at sea, and the units employed in these maneuvers must be of sufficient size to show the proper relation they bear to one another. If the active fleet in peace times is not of sufficient size to give the higher

commanding officers practical experience in handling large forces, it cannot be expected that these same officers will be as efficient as should be in case of war. If the policy of economy on the part of the legislators is such as to deprive the navy of the necessary personnel to insure adequate training at sea, the onus from failures due to this neglect, should, of course, be placed on the legislators. But history has shown that wherever a military or naval failure has resulted from *any cause whatever*, the onus is placed on the commanders in the field. Therefore it behooves us from a personal, as well as from a patriotic, point of view, to do everything in our power to bring about conditions that will insure adequate training for the Admiral down through the lowest rating.

If we ignore the always changing international and strategic situations as a basis for determining the size of our active fleet in peace times, we must determine its size from the tactical viewpoint. That is, no matter what the strategical and international situation may be, our active fleet must be no smaller than is required for the proper training of the personnel. The game board has demonstrated that so far as the training of the higher command is concerned, this cannot be done in squadron units such as we now have in our so-called fleets. For proper fleet training there must be a battle fleet composed of no less than three squadrons of battleships, with a separate fleet flagship. Each squadron should have two divisions. Our present standard organization calls for four ships in a division. We *can* train with three ships in a division. Therefore, in order to effect the economy which is recognized as being essential, we adopt as a policy for the basis of our fleet organization in peace times, a battleship force composed of six three-ship divisions with a separate fleet flagship and one extra ship for replacement purposes—making a total of 20 dreadnaughts to be kept in full commission. This is the least number that permits of adequate training for the personnel. It is six less than was contemplated by the General Board in its 1916 recommendation.

So long as the battleship is the backbone of our naval strength, the other ships to be kept in commission should be in such numbers as to balance the fleet. There is no other way in which we can train the personnel to the degree which will insure efficient coordination and cooperation on the part of the different forces

which constitute a fleet. And without efficient coordination there can be no victory.

The necessity for the balanced fleet in peace times was appreciated by Admiral Jellicoe, who, in his book, "The Crisis of the War," wrote:

in the matter of organization we must be certain that adequate means are taken to insure that the different arms which must cooperate in war are trained to work together under peace conditions. A modern fleet consists of different types—battleships, battle cruisers, light cruisers, destroyers and submarines. . . . It is very essential that senior officers should have every opportunity of studying tactical schemes in which various classes of ships and kinds of weapons are employed.

That the six battle cruisers which are under construction should be kept in full commission as soon as completed is conceded as essential. These battle cruisers will form a squadron of the battle fleet. They will be used in conjunction with the battleships in determining the number of destroyers that should be maintained in commission.

In considering the destroyers, the impracticability of determining the size of our peace fleet by the ages of the vessels is made evident. The stimulus given destroyer building during the war has resulted in a force of about 300 destroyers, all of about the same age. The necessity for economy will not permit of all these vessels being kept in full commission, which would be done if the age policy was adopted. There is no prospect of additional destroyers being built for some years; so if the age determined the status we would find in 12 years from now all of our destroyers being placed in reserve, and leaving none with the active fleet.

For many years it was the custom to consider that there should be four destroyers for each capital ship. This was before the submarine became so effective. The war has demonstrated, and maneuvers on the game board have shown, that from the tactical point there must be, for efficient cooperation, not less than one squadron of destroyers for each division of capital ships. Each destroyer squadron should be composed of three divisions of six ships each, and as we are entirely lacking in flotilla leaders, there should be one additional destroyer in each squadron to act as leader. This makes 19 destroyers in each squadron, and as there are eight divisions of capital ships in the fleet there should be eight squadrons of destroyers—a total of 152. It is regretted that the question of economy does not permit a policy of keeping more

of these new vessels in full commission, as it is criminal to permit them to deteriorate in idleness on account of lack of personnel to keep them going. It does seem, however, that it will be desirable and necessary to keep at least two additional squadrons in commission for service in the Philippines and elsewhere. We should therefore make personnel estimates for 38 destroyers in addition to the fleet destroyers, making a total of 190 destroyers to be kept in full commission and leaving 135 with reduced crews.

Every tactical and strategical game shows that we are woefully lacking in light cruisers. The other cruisers which we now have would be useful in certain rôles. But none of them have the necessary speed that will permit of their use with the battle fleet. The ten new scout cruisers which are now completing must of necessity perform the double rôle of the scout cruiser and the light cruiser. It is essential that all of them be kept in full commission as a part of the active fleet. As the other cruisers are not required in fleet training, the best policy to adopt in regard to them is to keep one-half in full commission. This is in accordance with the recommendation made by the General Board. It will be necessary to keep these vessels in service as flagships of detached squadrons, and for the performance of police duty—a certain amount of which is always essential. Nearly all gunboats will be required for detached duty. Those so employed must have full complements.

Our submarine force has grown large. On account of the intricate construction of these vessels they must have highly trained crews. It is impracticable to have a reserve of sufficient experience to be qualified to perform submarine duty in an emergency. So all the submarines, with the exception of a few of the older ones, must be kept in full commission.

The Great War resulted in the development of certain types of vessels that previously were considered of little importance. These are the aircraft carriers, mine layers, mine sweepers, eagles, and submarine chasers. Sufficient numbers of these must be kept in full commission during peace times in order to insure development along special lines, and to insure the nucleus of trained officers and men for the certain expansion which would take place in case of war.

In determining the necessary personnel provisions for peace times it must be taken for granted that all ships carried on the

navy list will be used in case of war. Some of them may not be used for fighting, but they will be used for training or housing purposes. Therefore, in order to insure the upkeep of these vessels there must be provided personnel to keep them in material readiness. The argument has been advanced that it is ridiculous to suppose that all the vessels carried on the navy list will be used in case of war. The same argument was used prior to the war. It was refuted by what actually occurred. Every vessel on the

TABLE V.—PROPOSED STATUS OF THE FIGHTING SHIPS ON THE NAVY LIST

Type	Class	Total No.	Full commission	In reserve	In ordinary
Battleship...	Battleship, 1st line.....	27	20	7	0
	Battleship, 2d line.....	22	0	13	9
	Monitor, 2d line.....	6	0	4	2
Cruiser.....	Battle cruiser.....	6	6	0	0
	Cruiser, 2d line.....	16	8	8	0
	Light cruiser, 1st line.....	10	10	0	0
	Light cruiser, 2d line.....	3	0	3	0
	Aircraft carrier.....	1	1	0	0
	Mine layer.....	4	2	2	0
Destroyer..	Destroyer, 1st line.....	304	190	114	0
	Destroyer, 2d line.....	21	0	0	21
Submarine..	Submarine, 1st line.....	94	94	0	0
	Submarine, 2d line.....	48	34	6	8
	Fleet submarine.....	12	12	0	0
Patrol vessel	Eagle.....	55	5	50	0
	Gunboat.....	30	19	0	11
	Yacht.....	10	5	5	0
	Submarine chaser.....	60	30	30	0
Totals.....		729	436	242	51

navy list was used for some purpose—even those like the old *Constitution* and the *Granite State* being of value. In addition many ships were purchased. There can be no logic in considering that this government is maintaining in peace times men-of-war that would not be used in case of war. Such an expenditure of public funds would be extravagant waste. If there are such vessels on the navy list they should be scrapped. So long as we carry them, they must be considered in the personnel estimates.

Having decided the composition of our active fleet in so far as the fighting ships are concerned, and having adopted the prin-



ciple that all ships on the navy list must be considered in our personnel estimates, it is practicable to divide these ships into three groups for determining their personnel status. These groups will be designated under the headings of full commission, in reserve, and in ordinary, and the vessels listed thereunder according to whether they are to have full crews, partial crews, or nucleus crews.

Experience has shown that this large number of fighting ships require many auxiliaries. As those now on the navy list are not sufficient in numbers to supply and repair the fleet, it is essential that all of them, with the exception of the fleet tugs and mine sweepers, be kept in full commission. There will not be included in this list however the large number of small craft which are required for service at the naval districts, naval stations, and navy yards. The fleet auxiliaries are as follows:

TABLE VI.—FLEET AUXILIARIES TO BE KEPT IN FULL COMMISSION

Type	Number	Type	Number
Destroyer tenders .....	9	Ammunition ships.....	2
Submarine tenders.....	8	Cargo ships.....	2
Aircraft tender.....	1	Transports .....	3
Repair ships.....	4	Hospital ships.....	4
Store ships.....	6	*Fleet tugs.....	44
Colliers .....	12	*Mine sweepers .....	46
Oilers .....	13	Miscellaneous .....	7

\* Twenty fleet tugs and twenty mine sweepers to be kept in full commission.

#### COMPLEMENTS OF SHIPS IN PEACE TIMES

One would naturally suppose that the complements of ships in full commission should be the full numbers of officers and men that are necessary to fight the ships. This, however, was not the case prior to the war. As a result the battle fleet suffered greatly in efficiency. Nor was it appreciated at the Navy Department, or at least by those in authority at the time, that our fleet was lacking in efficiency owing to lack of sufficient personnel. In fact the departmental reports invariably announced that there was sufficient personnel and that the fleet was in a high state of efficiency. At the same time, the commander-in-chief was bitterly complaining of the unsatisfactory personnel conditions. That part of the report of the commander-in-chief<sup>2</sup> on the subject, made after the

<sup>2</sup> Rear Admiral F. F. Fletcher.

fleet target practice in the spring of 1915, is so pertinent, in view of the present conditions, that it is quoted here :

*Shortage of Personnel.*—The most vital weakness in the Atlantic fleet is the shortage of officers. It takes approximately ten years to educate and train an officer and no amount of legislation can provide officers when trouble is imminent. Expansion of the navy is limited by the number of officers available. The fleet is handicapped not alone by the shortage of officers but by the inexperience of the large number of young officers that have been added to the navy in the past few years. This condition, coupled with the shortage of officers, has resulted in officers being ordered to duties beyond their capacities and for which their experience and judgment do not fit them. Owing to the short enlistments our men require continuous training and the shortage of officers is certain to result in a lessening of efficiency. The shortage of officers is not confined to battleships, but exists in all classes of ships.

Second in importance to the shortage of officers is the shortage of men. The shortage of men is put as of secondary importance to that of officers since there will always be a reserve of trained men; and trained men can be made efficient in a much less time than is required for developing officers. The shortage of men in the Atlantic fleet, coupled with the shortage of officers, has prevented the fleet from attaining the degree of efficiency which is to be expected. Too much emphasis cannot be placed on what I believe to be the most serious weakness in the fleet to-day—lack of trained officers and shortage of enlisted men. To equalize the shortages in the different vessels there results a constant exchange of officers and men, tending to promote instability and to weaken the efficiency of the various units of the fleet. With a few exceptions, every vessel in the Atlantic fleet is short of the complement of officers and men necessary for battle. The shortage of enlisted men in the battleships alone, as I reported in January, 1915, exceeds 5000 men. It is evident that under-manned and under-officered ships can not be kept in a state of preparedness and efficiency to meet on equal terms similar types in other navies. *I believe that all ships in full commission attached to the active fleet should be kept fully manned for battle, ready for any duty to which they may be called. In no other way can the units of the fleet be kept in a thoroughly efficient state.*

This quotation is worthy of the most careful consideration. It is one of the few expressions on the part of a commander-in-chief of our fleet in which the true difficulties and the lack of efficiency, together with the causes therefore, have been forcibly stated in an official document. It should demand attention as the report was made at the time when the public believed that the fleet was in a high state of efficiency. A lesson should be learned from it as the conditions in our fleet to-day, so far as personnel is concerned, are similar in many respects to those stated in this report. And what

is of more significance is the tendency to reduce still further the personnel strength, and thereby further reduce the fleet's efficiency.

We can, of course, with a reduced personnel, keep a comparatively few ships in commission. By providing just sufficient officers and men for these few ships, they can and will reach a high state of efficiency as individual ships. But this will not answer for the fleet training which is necessary if our purpose is to win battles. And in all our peace procedure, we must not lose sight of the great and only function of a navy: that is to be able to defend the country in case of war.

Believing that the navy will fail in the next war unless full preparation is made beforehand, and knowing that this preparation cannot be made unless we keep in commission in peace times sufficient ships with adequate personnel to insure sufficient training, there is here laid down a policy which keeps in service with full complements of officers and men the least number of ships that will meet these demands.

Table VII gives the full commission complements of all classes of ships in the navy with the exception of the numerous small craft required at the shore stations.

#### PERSONNEL REQUIREMENTS FOR THE ACTIVE FLEET

Having determined the number of ships to be kept in full commission and the complements for each of these ships, it is now practicable to ascertain the personnel required for the ships of the active fleet maintained on a peace basis. The fighting ships are taken first, and, in order to avoid too many statistics, the figures will be carried through only for the line officers and the enlisted men. The proportion between line and staff and warrant officers is, of course, in accordance with the complements of the individual ships.

Prior to the war some of our colliers and oilers were operated with merchant crews. This was done because there were not sufficient men of the regular navy to provide crews for them. Under a false impression of economy, Congress did, however, annually appropriate the money for running this adjunct service in connection with the navy. In reality it was not economy. The pay of the merchant crew was less than the pay of a navy crew. But when we consider that there is no eight-hour day in the navy, and the less cost of repairs due to better upkeep, the final cost to the

TABLE VII.—AVERAGE COMPLEMENTS OF LINE OFFICERS, STAFF OFFICERS, WARRANT OFFICERS AND ENLISTED MEN BY CLASSES OF SHIPS ON THE NAVY LIST\*

Class of ships	Commissioned line				Medical corps			Supply corps			Chaplain		Chief warrant and warrant officers						Enlisted men			
	Captain	Commander	Lieut. comdr.	Lieutenant (J.G.)	Ensign	Commander	Lieut. comdr.	Lieutenant	Lieutenant (J.G.)	Commander	Lieut. comdr.	Lieutenant	Lieutenant (J.G.)	Lieut. comdr.	Lieutenant	Chief boatswain and boatwain	Chief gunner and gunner	Chief carpenter and carpenter		Chief machinist and machinist	Chief pharmacist and pharmacist	Chief pay clerk and pay clerk
Battleships, first line.....	1	1	5	11	11	1	1	1	1	1	1	1	1	1	3	1	3	1	1	2	1	350
Battleships, second line.....	1	1	5	8	8	1	1	1	1	1	1	1	1	1	2	1	2	1	1	2	1	1,075
Monitors.....	1	1	1	4	4	1	1	1	1	1	1	1	1	1	1	1	1	1	1	1	1	350
Battle cruisers.....	1	1	5	11	11	1	1	1	1	1	1	1	1	1	3	1	3	1	4	1	2	1,400
Cruisers.....	1	1	3	6	6	1	1	1	1	1	1	1	1	1	2	1	2	1	2	1	2	625
Light cruisers, first line.....	1	1	3	4	4	1	1	1	1	1	1	1	1	1	2	1	2	1	3	1	2	600
Light cruisers, second line.....	1	1	1	4	4	1	1	1	1	1	1	1	1	1	1	1	1	1	1	1	1	350
Mine layers.....	1	1	1	4	4	1	1	1	1	1	1	1	1	1	2	1	2	1	1	1	1	320
Airplane carriers.....	1	1	3	4	4	1	1	1	1	1	1	1	1	1	1	1	1	1	1	1	1	300
Destroyers.....	1	1	4	11	24	1	1	2	2	1	1	1	1	1	1	1	1	1	1	1	1	115
Submarines.....	1	1	1	1	1	1	1	1	1	1	1	1	1	1	1	1	1	1	1	1	1	32
Gunboats.....	1	1	2	3	3	1	1	1	1	1	1	1	1	1	1	1	1	1	1	1	1	190
Frigates.....	1	1	2	2	2	1	1	1	1	1	1	1	1	1	1	1	1	1	1	1	1	60
Yachts.....	1	1	1	2	2	1	1	1	1	1	1	1	1	1	1	1	1	1	1	1	1	100
Submarine chasers.....	1	1	1	1	1	1	1	1	1	1	1	1	1	1	1	1	1	1	1	1	1	25
Aircraft tenders.....	1	1	3	4	4	1	1	1	1	1	1	1	1	1	1	1	1	1	1	1	1	250
Destroyer tenders.....	1	1	3	4	4	1	1	1	1	1	1	1	1	1	2	2	2	2	2	2	2	350
Submarine tenders.....	1	1	2	3	3	1	1	1	1	1	1	1	1	1	2	2	2	2	2	2	2	250
Repair ships.....	1	1	3	2	2	1	1	1	1	1	1	1	1	1	2	3	3	3	3	3	3	400
Store ships.....	1	1	1	2	2	1	1	1	1	1	1	1	1	1	3	3	3	3	3	3	3	160
Cargo ships.....	1	1	1	1	1	1	1	1	1	1	1	1	1	1	4	4	4	4	4	4	4	90
Coilers.....	1	1	1	1	1	1	1	1	1	1	1	1	1	1	4	4	4	4	4	4	4	115
Oilers.....	1	1	1	2	2	1	1	1	1	1	1	1	1	1	4	4	4	4	4	4	4	100
Ammunition ships.....	1	1	1	2	2	1	1	1	1	1	1	1	1	1	1	1	1	1	1	1	1	200
Transports.....	1	1	1	3	3	1	1	1	1	1	1	1	1	1	1	1	1	1	1	1	1	400
Hospital ships.....	1	1	1	2	2	1	1	1	1	1	1	1	1	1	1	1	1	1	1	1	1	100
Fleet tugs.....	1	1	1	1	1	1	1	1	1	1	1	1	1	1	1	1	1	1	1	1	1	100
Mine sweepers.....	1	1	1	1	1	1	1	1	1	1	1	1	1	1	2	2	2	2	2	2	2	40
															2	2	2	2	2	2	2	50

\* These complements do not include men of the hospital corps, nor do they include the officer and enlisted personnel which would be assigned to aviation duty only.  
 Note.—One-third the destroyers, one-sixth the submarines, one-half the gunboats have commanders in command. Other commanding officers of these types are of the grade of lieutenant commander.

government is less with the navy crews. In addition, the halfway status between merchant ships and men-of-war led to a number of difficulties in the operation of these ships. Vessels belonging to the train of a fleet should be manned entirely by naval personnel and be subject to the naval regulations instead of merchant laws. The position of these ships was untenable as soon as war was declared; their merchant crews were discharged; they were placed in commission with regular naval crews, and this separate organi-

TABLE VIII.—PERSONNEL OF COMMISSIONED LINE AND ENLISTED FORCE REQUIRED FOR ACTIVE FIGHTING SHIPS IN PEACE TIMES

	Number of ships	Captains	Commanders	Lieut. comdrs.	Lieutenants	Lieutenants (J. G.)	Ensigns	Enlisted men
Battleships, first line.....	20	20	20	100	220	220	220	27,000
Battle cruisers.....	6	6	6	30	66	66	66	8,400
Cruisers.....	8	8	8	24	48	48	48	5,000
Light cruisers.....	10	10	10	30	40	40	40	6,000
Mine layers.....	2	..	2	2	8	8	..	640
Airoplane carrier.....	1	1	1	3	4	4	4	300
Destroyers.....	190	..	63	190	507	380	..	21,850
Submarines.....	140	..	23	117	257	280	..	4,480
Gunboats.....	19	..	10	19	48	57	..	3,610
Eagles.....	5	..	..	..	10	10	..	300
Yachts.....	5	..	..	5	5	10	..	500
Submarine chasers.....	30	..	..	..	30	30	..	750
Totals.....	436	45	143	520	1,243	1,153	378	78,830

Total number of line officers, 3482.

zation came to an end. We must not go back to any such anomalous situation. Therefore all the naval auxiliaries that may be expected at any time to accompany and to operate with the fleet must be manned by regular naval crews.

A perusal of Table IX shows that no commissioned line officers are assigned to cargo ships, colliers, oilers, fleet tugs, and mine sweepers. This is because these ships could as well be officered by chief warrant and warrant officers, the complements being in accord with those given in Table VII. Some of these ships were formerly officered by merchant officers. The unsuitability of this has been pointed out. Our chief warrant and warrant officers

will make excellent captains, executives, engineers, etc., for these vessels. By officering these ships with officers of this type it will materially increase the number of warrant officers, thereby keeping open the avenue of promotion for the enlisted man.

The chief warrant officers long pressed for legislation that would give them the rank of lieutenant commander. Their error was in that they made a point that all should be promoted to this grade. There is no question as to the value of the warrant officers. But it is not fair to the government to advance any class beyond

TABLE IX.—PERSONNEL OF COMMISSIONED LINE AND ENLISTED FORCE REQUIRED FOR ACTIVE AUXILIARIES IN PEACE TIMES

	Number of ships	Captains	Commanders	Lieut. comdrs.	Lieutenants	Lieutenants (J. G.)	Ensigns	Enlisted men
Aircraft tenders . . . .	1	1	1	3	4	4	0	250
Destroyer tenders . . .	9	..	9	27	36	36	..	3,150
Submarine tenders . .	8	..	8	16	24	24	..	2,000
Repair ships . . . . .	4	..	4	12	8	8	..	1,600
Store ships . . . . .	6	..	6	6	12	12	..	960
Cargo ships . . . . .	11	..	..	..	..	..	..	990
Colliers . . . . .	12	..	..	..	..	..	..	1,380
Oilers . . . . .	13	..	..	..	..	..	..	1,300
Ammunition ships . .	2	..	2	2	4	4	..	400
Transports . . . . .	3	..	3	3	9	9	..	1,200
Hospital ships . . . .	4	..	4	4	8	8	..	400
Fleet tugs . . . . .	20	..	..	..	..	..	..	800
Mine sweepers . . . .	20	..	..	..	..	..	..	1,000
Total . . . . .	113	1	37	73	105	105	..	15,430

Total number of line officers, 321.

their value. It is held that a chief warrant officer who does not qualify for a position higher than boatswain of a ship or as subordinate in the engineers division, or something corresponding, should not be advanced above the grade of lieutenant. But any chief warrant officer who qualifies as the commanding officer of an auxiliary, or as the chief engineer of a vessel of this class, is certainly entitled to, and should be advanced to, the rank of lieutenant commander. The principle of selection should apply to the warrant officers in the same manner as to the commissioned officers.

This question is dealt with at length because it has an important bearing on the efficiency of the fleet. We must not have naval vessels officered and manned by merchant crews. We must not increase our regular commissioned officer personnel to the stage where it will meet with opposition simply on account of its size. We must keep open the doors for the advancement of the enlisted men. We must give adequate promotion to the chief warrant officers who are deserving of this promotion. The best way to accomplish this is to officer certain of our auxiliaries entirely with chief warrant officers and warrant officers.

TABLE X.—PERSONNEL OF COMMISSIONED LINE OFFICERS AND ENLISTED MEN REQUIRED AT SEA FOR AVIATION DUTY

	Number of units	Rear admirals	Captains	Commanders	Lieut. comdrs.	Lieutenants	Lieutenants (J. G.)	Ensigns	Enlisted men
Battleships .....	20	...	...	...	...	20	40	40	200
Battle cruisers .....	6	...	...	...	...	6	12	12	60
Airplane tenders .....	3	...	...	...	12	45	45	45	750
Airplane carriers .....	1	...	...	...	4	8	20	20	200
Total .....	30	...	...	...	16	79	117	117	1,210

Total number of line officers, 329.

In the foregoing summaries no estimate has been made for aviation personnel required for service at sea. In addition to the regular crew each battleship and battle cruiser should carry the officers and men for the operation and maintenance of three planes. The airplane carrier and airplane tender will both require a large number of officers and men in addition to their regular crews. For the present, at least, it will be desirable to keep in service, as airplane tenders, two of the mine layers, and these will require augmented personnel to maintain and operate the planes. With the development taking place in aeronautics, all vessels carrying planes or acting as tenders for planes must carry additional personnel for training.

As the number of men in the hospital corps should depend on the total number of officers and men in the service, the estimates

for this corps should be made on the completion of the estimates of the personnel required at sea and on shore.

#### STAFF DUTY REQUIREMENTS

The commander-in-chief of the fleet, the commanders of forces and other subdivisions, together with the officers and men who compose their staffs, form a vital part of the sea going personnel. The service has been prone to look upon staff duty as of secondary importance. However, the more we study the matter, and the more experience we have—just that much more do we gain an appreciation of the importance of staff duty and the necessity for all flag officers having staffs of sufficient size and adequate training. The Navy Department's policy has been beggarly in the assignment of officers to staff duty. Our high ranking officers frequently have been left to carry on with staffs that were entirely inadequate as to numbers, training and experience. Such a condition invariably leads to the imposition on the commander of a number of minor details which take up the greater part of his time, and prevent him from giving his undivided attention to the big things with which he is concerned. *A commander of a force without an adequate staff spends most of his time in administering, and little of it in commanding.* The efficiency of the entire command suffers in consequence.

The army has long realized the necessity of adequate staffs. Their general officers have more trained assistants than do our flag officers. The navy in peace times must have the staff training that will insure knowledge of how to organize, administer, and command large forces in time of war.

The staffs given in Table XI are for the administering of a fleet composed of 550 vessels valued at considerably over a billion dollars, and having a personnel of about 100,000 officers and men. This fleet is the country's insurance against aggression from without. If these essential points are kept in mind it will readily be seen that the size of these staffs is small in comparison with the tremendous responsibilities which they carry.

The total number of line officers and enlisted men required for manning the vessels of the active fleet can now be tabulated.

Let us have a clear understanding as to exactly what the above summary represents. The total of 4314 line officers and 96,265 enlisted men are the numbers necessary to man fully only those



TABLE XI.—FLAG AND STAFF PERSONNEL OF LINE AND ENLISTED FORCE REQUIRED FOR THE ACTIVE FLEET IN PEACE TIMES

	Number of units									
	Admirals	Vice admirals	Rear admirals	Captains	Commanders	Lieut. comdrs.	Lieutenants	Lieutenants (J. G.)	Enlisted men	
Fleet.....	1	1	1	...	1	4	4	4	4	100
Battleship force.....	1	...	1	1	1	2	2	2	2	50
Cruiser force.....	1	...	1	1	1	1	2	2	2	50
Destroyer force.....	1	...	1	1	1	2	2	2	2	50
Submarine force.....	1	...	1	1	1	2	2	2	2	50
Mine force.....	1	...	1	1	1	1	1	1	..	15
Aviation force.....	1	...	1	1	1	1	1	1	..	15
Train.....	1	...	1	1	1	1	2	2	2	25
Battleship division.....	5	...	5	...	...	5	10	..	..	125
Battle cruiser division.....	1	...	1	...	...	1	2	..	..	25
Light cruiser squadron.....	1	...	1	...	...	1	2	..	..	25
Destroyer flotilla.....	2	...	2	...	2	4	4	4	4	50
Destroyer squadron.....	10	...	10	...	10	10	10	10	..	100
Submarine squadron.....	4	...	4	...	4	4	4	4	..	40
Detached forces.....	5	...	3	...	3	3	3	3	..	75
Totals.....	34	1	4	18	31	16	43	51	18	795

TABLE XII.—PERSONNEL OF COMMISSIONED LINE AND ENLISTED FORCE REQUIRED FOR ACTIVE FLEET IN PEACE TIMES

	Number of units										
	Admirals	Vice admirals	Rear admirals	Captains	Commanders	Lieut. comdrs	Lieutenants	Lieutenant (J. G.)	Ensigns	Enlisted men	
Table VIII.—Fighting ships.	436	...	...	45	143	520	1,243	1,153	378	78,830	
Table IX.—Auxiliaries.	113	...	...	1	37	73	105	105	...	15,430	
Table X.—Aviation.	30	...	...	...	...	16	79	117	117	1,210	
Table XI.—Flag and staff.	34	1	4	18	31	16	43	51	18	795	
Total.....	610	1	4	18	77	196	652	1,478	1,393	495	96,265

Total number of line officers. 4314.

vessels which are assigned to the *active* fleet. No estimate has so far been made for the additional 284 fighting ships which are carried on the navy list, for the entire shore establishment, the numbers to be maintained under training, nor the requirements for replacements. In making such estimates consideration must be given to the numerical relation between the active personnel and the reserve personnel. That is, the peace quota for the shore establishment, and the partial complements for the ships not maintained in full commission must be such that when these numbers are added to our trained reserves, the total will be sufficient to employ immediately all of the available material.

#### COMPLEMENTS OF SHIPS IN RESERVE

Not only must the complements of the reserve ships be such that they can be completed when the reserves are mobilized, but they must be sufficient to insure the material upkeep. There is an impression on the part of our legislators that by reducing the active personnel and thereby decreasing the appropriation for the pay of the officers and men, they are saving money for the government. They are right only up to a certain limit. Just as soon as the money appropriated will not permit of a personnel of sufficient size to keep the ships in material readiness, the ships deteriorate in value at a rate in excess of the pay of the personnel which is necessary to prevent such deterioration. In addition, at the time that these ships may be urgently needed, they will not be ready, with the consequent loss of their services, and the necessity for spending large sums of money on repairs. We actually had this experience prior to the great war. A large number of ships were permitted to deteriorate for lack of personnel. They were not ready for service at the time we became a belligerent. Many millions of dollars were spent in making them materially fit. The loss of their services apparently was not felt by the country, *because it so happened in this case that even had they been ready, there was no personnel to man them.* But had we not been protected by the navy of an ally, the result would have been very different. The truth of the matter is that while the country was saved a *few* millions of dollars by the inadequate personnel, it lost *many* millions of dollars in the deterioration of these ships. The net loss would have been much less had the appropriation necessary to place these ships in material readiness

previously been applied to the pay of sufficient personnel which would have made these repairs unnecessary.

For valuable fighting ships—and all such ships not kept in full commission must be kept in reserve—the least number of officers and men that can keep them in material readiness, and also insure their ability to operate with the joining of the reserves when mobilization takes place, is fifty per cent of the full commissioned complements.

The number of fighting ships to be kept in a reserve status is shown in Table V. The personnel required for them is ascertained by applying one-half the full commission complements as shown in Table VII.

TABLE XIII.—PERSONNEL OF COMMISSIONED LINE AND ENLISTED FORCE REQUIRED FOR RESERVE SHIPS IN PEACE TIMES

	Number of ships	Captains	Commanders	Lieut. comdrs.	Lieutenants	Lieutenants (J. G.)	Enlisted men
Battleships, 1st line . . . . .	7	7	7	21	35	35	4,725
Battleships, 2d line . . . . .	13	13	13	26	52	52	6,985
Monitors . . . . .	4	..	4	4	8	8	700
Cruisers . . . . .	8	4	8	12	24	24	2,500
Light cruisers . . . . .	3	..	3	3	6	6	525
Mine layers . . . . .	2	..	2	2	4	4	320
Destroyers . . . . .	114	..	19	95	114	114	6,555
Submarines . . . . .	6	..	1	1	3	3	75
Eagles . . . . .	50	..	..	..	50	50	1,500
Yachts . . . . .	5	..	..	..	10	10	250
Submarine chasers . . . . .	30	..	..	..	..	5	360
Mine sweepers . . . . .	26	..	..	..	..	..	650
Fleet tugs . . . . .	24	..	..	..	..	..	480
Total . . . . .	292	24	57	164	311	306	25,525

Total number of line officers, 862.

The administration of this large number of reserve ships will require flag officers and suitable staffs. While the vessels may be distributed at the various navy yards, there should be an organization which will insure practicability of mobilization.

Such an organization could be considered as *The Reserve Fleet* with a commander-in-chief directly under the Navy Department, or it could be a detachment of *The Fleet*, with a commander

directly under the commander-in-chief. The personnel requirements are the same in either case.

There remain now only those older ships which have various uses, but which do not warrant the expenditure of the amount of

TABLE XIV.—FLAG AND STAFF PERSONNEL OF THE LINE AND ENLISTED FORCE REQUIRED FOR THE RESERVE FLEET IN PEACE TIMES

	Number of units	Vice admirals	Rear admirals	Captains	Commanders	Lieut.-comdrs.	Lieutenants	Lieuts. (J. G.)	Enlisted men
Fleet.....	1	1	1	1	2	2	2	2	50
Battleship force.....	1	1	1	1	1	1	1	1	25
Battleship divisions.....	4	2	2	2	2	2	2	2	50
Cruiser force.....	1	1	1	1	1	1	1	1	25
Destroyer force.....	1	1	1	1	1	1	1	1	25
Destroyer squadrons.....	6	3	3	3	3	3	3	3	30
Patrol force.....	1	1	1	1	1	1	1	1	10
Totals.....	15	1	6	7	4	11	9	4	216

Total number of line officers, 42.

money that would keep them ready for instantaneous mobilization. These ships, in peace times, will require only such personnel that will enable them to be used for experimental purposes, housing

TABLE XV.—PERSONNEL OF COMMISSIONED LINE AND ENLISTED FORCE REQUIRED FOR SHIPS IN ORDINARY IN PEACE TIMES

	Number of units	Captains	Commanders	Lieut. comdrs.	Lieutenants	Lieuts. (J. G.)	Enlisted men
Battleships, second line.....	9	1	1	9	9	9	1,350
Monitors.....	2	2	2	2	2	2	60
Destroyers, second line.....	21	1	1	21	21	21	315
Submarines, second line.....	8	8	8	4	4	4	40
Gunboats.....	11	11	11	11	11	11	165
Unclassified.....	20	20	20	20	20	20	300
Totals.....	71	1	2	12	47	11	2,230

Total number of line officers, 74.

purposes, or possibly for loan to the states for naval militia training. If these ships are not to serve any useful purpose, they should, of course, be scrapped. So long as they are carried on the navy list it must be taken for granted that they have their uses.

This completes the estimates for the requirements afloat. A summary of the requirements of vessels other than those in full commission follows:

TABLE XVI.—SUMMARY OF PERSONNEL OF COMMISSIONED LINE AND ENLISTED FORCE REQUIRED FOR VESSELS IN RESERVE AND IN ORDINARY

	Number of units									
	Vice admirals	Rear admirals	Captains	Commanders	Lieut. comdrs.	Lieutenants	Lieuts. (J. G.)	Enlisted men		
Table XIII.—Reserve ships .....	292	...	24	57	164	311	306	25,525		
Table XIV.—Flag and staff .....	15	1	6	7	4	11	9	4 215		
Table XV.—In ordinary.....	71	...	1	2	12	47	11	2,230		
Totals .....	378	1	6	32	63	187	367	321 27,970		

Total number of line officers, 977.

The total requirements afloat are now found by adding the totals for the active fleet and the reserve fleet together.

TABLE XVII.—TOTAL REQUIREMENTS AFLOAT OF PERSONNEL OF THE COMMISSIONED LINE AND ENLISTED FORCE IN PEACE TIMES

	Number of units										
	Admirals	Vice admirals	Rear admirals	Captains	Commanders	Lieut. comdrs.	Lieutenants	Lieuts. (J. G.)	Ensigns	Enlisted men	
Table XII.—Active fleet.	610	1	4	18	77	196	652	1,478	1,393	495	96,265
Table XVI.—Reserve fleet.	378	...	1	6	32	63	187	367	321	...	27,970
Grand totals.....	988	1	5	24	109	259	839	1,845	1,714	495	124,235

Total number of line officers, 5291.

Let us not forget:

1. That these are requirements for manning in times of *Peace* such vessels as we actually have in service or nearing completion.
2. That for 363 of these vessels estimates are made for only partial complements. An additional 40,000 men with officers in proportion are necessary to fill these complements.
3. No estimate as yet has been made for the peace time requirements of:
  - (a) The shore establishment.
  - (b) Personnel under training.
  - (c) Necessary replacements and sick.

#### THE NAVAL PERSONNEL ON SHORE

Prior to the Great War there was an impression in some quarters that all the trained officers and men employed on shore duty would be sent to sea immediately on the outbreak of hostilities. Those who held this conviction were, of course, in error. Not only were many of these officers and men not sent to sea, but it was necessary to actually augment the shore forces with trained personnel that was much needed to fill the depleted complements of our ships. The importance of the shore establishment must be realized, if we are to have an efficient navy. The fleet must depend on the navy yards and stations for stores, provisions, repairs and docking. The fleet must depend on the Navy Department for general information, plans, and instructions, and for the administration of the large affairs not directly concerned with the various units. The fleet must depend on the Naval War College, Post Graduate Schools, Naval Academy, and training stations for officers and men. In fact the efficiency of the fleet depends, in a great measure, on the efficiency of the shore establishment.

This brings up the important question as to what personnel is necessary for the conduct of the shore establishment. The answer is—the sea-going personnel. Men who go to sea appreciate the necessity of having the shore establishment controlled and operated by men who thoroughly understand the personnel and matériel requirements of the vessels employed on active duty. *And only men who go to sea can thoroughly understand these complex requirements.* It is essential, therefore, that a certain number of line officers and enlisted men be retained at all times on

duty at the Navy Department, the navy yards, and other shore activities. Navy yards are military establishments and must be operated in accordance with military methods and principles if military efficiency is to be attained. And here again we must not forget that the great reason for the existence of the navy is to defend the country in time of war, and that this defence will not be successful unless military efficiency is attained on the part of the personnel. The foundations for this efficiency must be laid in times of peace.

Our shore establishment is big. Whether or not it is bigger than is necessary to maintain the fleet is not the question that concerns us in this study. Our concern is—having this shore establishment composed of a Navy Department, naval districts, navy yards, and many other activities, and having a policy of maintaining all these elements whether or not they are needed for the efficiency of the navy and the welfare of the country—what must be done to insure their efficient operation so that in addition to the overhead cost of keeping them open, we do not add expense owing to neglect of maintenance and to inefficient operation? There must, of course, be a large number of officers and men connected with all these activities. Some of the personnel should be civilian; some of it should be naval. There are cases where the work required at a navy yard or station could be more cheaply done by civilian labor or employees than by navy enlisted men or officers. But the appropriations frequently are not sufficient to pay for the work that must be done. The only remedy is for the Department to deplete the naval personnel at sea by detailing officers and men to the shore establishment.

On the other hand civilian employees are used in a number of places where the efficiency of the navy would be improved if naval personnel was assigned. There is some politics in such cases. With our form of government it appears impracticable to keep politics out of the naval and military establishments altogether. So we find here again the questions of economy and politics which, unfortunately for efficiency, cannot be eliminated.

Having determined the size of the active peace time fleet and the number of ships to be kept in the reserve status, and knowing the number of shore activities that are actually kept in operation, it is practicable to make an estimate of the number of line officers and enlisted men required for operating such shore activities in a

manner that will insure the efficient maintenance of the fleet as constituted.

There are a number of factors to be considered in such an estimate. These are:

1. The great value and importance of ships of the navy require in the shore establishment an organization and administration that will insure the efficient operation and maintenance of the navy as a whole.

2. The shore establishment must have sufficient trained personnel to insure a nucleus that will warrant the transition from a peace to a war status without so disrupting the machinery of administration that inefficiency will result.

3. The shore establishment must have trained officers and men in sufficient numbers to educate the officers and train the large number of men that are needed continuously for replacements.

4. There must be sufficient officers and men employed on shore to insure a standard of morale that can be obtained only by periodically detaching the personnel from duty aboard ship and giving them an opportunity to enjoy for a time the more natural method of working and living on shore.

5. There must be on shore sufficient officers, especially in the higher grades, to form the necessary reserve for augmenting the fleet personnel in case of war. *It must be borne in mind, and considered as important, that these high ranking officers employed on shore are the only real reserve of flag officers, captains, and commanders that we have.*

The chief naval activities on shore that require naval personnel are:

The Navy Department, its bureaus and offices.

The Naval War College, Post Graduate Schools, Naval Academy, training stations.

The naval districts.

The navy yards and stations.

Inspection duty.

Recruiting duty.

Aviation duty.

Radio duty.

To one who has not looked into the details of the shore establishment it may be impracticable to appreciate why so much of the naval personnel is required for this duty. To make clear the



reasons for this it is necessary to go somewhat more into detail than might otherwise be interesting. But it being the object of this paper to give a clear estimate of our needs, it is essential to set forth the requirements. The series of tables which follow are simply a general summary showing the numerous and varied activities requiring line officers and enlisted men on shore.

The first table—that for the office of the Chief of Naval Operations—is gone into detail, because this is really the staff which administers the navy as a whole. The personnel requirements are in accordance with the organization of the office approved in 1920.

TABLE XVIII.—LINE OFFICER REQUIREMENTS; OFFICE OF CHIEF OF OPERATIONS

	Admirals	Rear admirals	Captains	Commanders	Lieut. comdrs.	Lieutenants
Chief of operations .....	1	..	..	..	..	..
Personal aides.....	..	..	..	1	1	..
Assistant chief of operations.....	..	1	..	..	1	..
Planning division.....	..	1	5	9	..	..
Intelligence division .....	..	1	2	4	5	5
Communication division .....	..	1	1	4	4	9
*Inspection division.....	..	2	4	3	3	..
Gunnery exercises .....	..	1	2	2	2	2
Naval districts.....	..	1	1	..	1	..
Material division .....	..	1	4	4	4	..
Naval operating forces.....	..	..	1	1	7	2
Record and files .....	..	..	..	1	..	..
Totals .....	1	9	20	29	28	18

\*Includes board of inspection and survey.

Total number of line officers, 104.

There are three Navy Department bureaus under the cognizance of line officers. These are Navigation, Ordnance, and Engineering. The requirements under these bureaus are summarized in Table XIX. The numbers given were ascertained in the same detailed manner as were those in the table showing the requirements for the office of the Chief of Operations. To insert so much detailed work here would be an unnecessary encumbrance. Therefore, only summaries are given, as these in themselves demonstrate the facts to be presented.

TABLE XIX.—REQUIREMENTS FOR LINE OFFICERS AND ENLISTED PERSONNEL, BUREAUS OF NAVIGATION, ORDNANCE, ENGINEERING

	Number of units	Rear admirals	Captains	Commanders	Lieut. comdrs.	Lieutenants	Enlisted men
<i>Bureau of navigation</i> .....	1	1	7	9	15	5	....
Naval observatory .....	1	1	1	4	..	..	....
Hydrographic office .....	1	1	1	2	2	..	....
Branch hydrographic office .....	14	..	..	4	10	..	....
Naval war college .....	1	2	5	5	..	..	....
Naval academy .....	1	1	7	14	50	50	500
Training stations .....	4	..	4	4	16	16	2,600
Receiving ships .....	11	..	5	12	11	..	2,200
Recruiting stations .....	..	..	8	8	25	25	1,500
<i>Bureau of ordnance</i> .....	1	1	4	9	15	5	....
Inspection duty .....	..	..	2	8	8	8	....
Torpedo stations .....	3	..	2	3	6	5	1,900
Ammunition depots .....	10	..	1	4	4	..	100
Mine depots .....	2	..	..	..	1	1	50
Ordnance plant .....	2	..	1	2	2	..	....
Gun factory .....	1	..	1	3	8	8	....
Proving grounds .....	1	..	1	1	2	2	50
<i>Bureau of engineering</i> .....	1	1	4	9	15	5	....
Inspection duty .....	..	..	8	15	15	5	....
<b>Totals</b> .....	<b>55</b>	<b>8</b>	<b>62</b>	<b>116</b>	<b>205</b>	<b>135</b>	<b>7,900</b>

Total number of line officers, 526.

The naval districts, navy yards, naval stations and bases are essential for the administration and operation of the navy. There are more navy yards and stations than are required for the most efficient operation or the best economy. But so long as these stations are operated they must have sufficient personnel to prevent further waste of the public funds. In Table XX will be given the line officer and enlisted men requirements for all the naval districts, navy yards, naval stations and bases, and minor stations.

Under the naval stations and bases are included those in the Philippines, Guam, Samoa, Hawaii and the West Indies.

Under miscellaneous are included the General Board, office of the Judge Advocate General, office of the Secretary of the Navy, Naval Examining Board, Shipping Board, Army General Staff

TABLE XX.—LINE OFFICER AND ENLISTED PERSONNEL REQUIREMENTS FOR NAVAL DISTRICTS, NAVAL STATIONS, BASES, ETC.

	Number of units		Rear admirals	Captains	Commanders	Lieut. comdrs.	Lieutenants	Lieuts. (J. G.)	Ensigns	Enlisted men
Naval districts.....	16	9	14	11	25	18	..	..	..	3,200
Navy yards .....	9	9	19	26	52	52	..	..	..	1,250
Naval stations and bases.....	14	4	18	18	14	14	..	..	..	1,400
Air stations.....	8	..	6	8	16	100	100	100	..	4,000
Radio stations.....	..	..	..	..	..	..	..	..	..	2,200
Miscellaneous .....	9	9	18	9	5	2	..	..	..	....
Totals .....	56	31	75	72	112	186	100	100	100	12,150

Total number of line officers, 676.

College, Supervisor New York Harbor, Naval Home Philadelphia, naval attaches at the embassies and legations, the Pacific Coast Communication Service, and commissions to foreign countries.

A large number of the enlisted men required for duty in the navy yards and stations, and the naval districts, is in connection with the district craft. There are about 1000 of these of various types, including ambulance boats, barges for fueling, etc., derricks, dredges, ferry-boats, car floats, lighters for various uses, pile drivers, scows, tugs, patrol vessels. All of these are in constant use. They should be operated by naval crews because their operation is cheaper than with civilian crews; the regular navy men on these craft form an important part of the trained reserve for the fighting ships; it gives the older men an opportunity for shore duty which is essential for the morale. They must be available for use twenty-four hours of the day, which is practicable with naval crews, but not with civilian crews.

The numbers of officers that take the course at the Naval War College and those that take the post graduate courses depend on the size of the total operating requirements for sea and shore. The number of men at the trade schools and the training stations likewise depend on the size of the operating forces at sea and on shore. The next step, therefore, is to summarize the sea forces and those required for the shore establishment.

A summary of the shore duty requirements follows:

TABLE XXI.—REQUIREMENTS OF COMMISSIONED LINE OFFICERS AND ENLISTED MEN FOR DUTY ON SHORE IN TIMES OF PEACE

	Admirals	Rear admirals	Captains	Commanders	Lieut. comdrs.	Lieutenants	Lieuts. (J. G.)	Ensigns	Enlisted men
Table XVIII.—Office of operation . . . . .	1	0	20	29	28	18	...	...	...
Table XIX.—Duty under bureaus . . . . .	8	62	116	205	135	...	...	...	7,900
Table XX.—Navy yards, stations, etc. . . . .	31	75	72	112	186	100	100	12	1,50
<b>Total . . . . .</b>	<b>1</b>	<b>48</b>	<b>157</b>	<b>217</b>	<b>345</b>	<b>339</b>	<b>100</b>	<b>100</b>	<b>20,050</b>

Total number of line officers, 1307.

TABLE XXII.—LINE OFFICER AND ENLISTED PERSONNEL REQUIREMENTS FOR SEA DUTY AND SHORE DUTY IN TIME OF PEACE

	Admirals	Vice admirals	Rear admirals	Captains	Commanders	Lieut. comdrs.	Lieutenants	Lieuts. (J. G.)	Ensigns	Enlisted men
At sea . . . . .	1	5	24	109	259	839	1,845	1,714	495	124,235 (Table XVII)
On shore . . . . .	1	...	48	157	217	345	339	100	100	20,050 (Table XXI)
<b>Totals . . . . .</b>	<b>2</b>	<b>5</b>	<b>72</b>	<b>266</b>	<b>476</b>	<b>1,184</b>	<b>2,184</b>	<b>1,814</b>	<b>595</b>	<b>144,285</b>

Total number of line officers, 6598.

THE REQUIREMENTS FOR THE NAVAL WAR COLLEGE, POST GRADUATE COURSES, AND TRAINING

The Naval War College has at last come into its own and gained its place in the sun. After years of effort on the part of a few enthusiasts, the service has learned to recognize not only the desirability of having all the high ranking officers pass through the college, but the necessity for it. Many officers have gone to the War College either in open opposition as to the benefits claimed, or doubtful in regard to them. If after completing the course

there is a single officer who does not feel that he was benefited, or who does not hold that all officers should be required to take the course, such officer has not expressed himself.

In the August, 1920, number of the U. S. NAVAL INSTITUTE PROCEEDINGS there is published the "Report and Recommendations of a Board Appointed by the Bureau of Navigation Regarding the Instruction and Training of Line Officers." The desirability of and necessity for comprehensive instruction and training of line officers throughout their active service is clearly shown. There can be no question as to the logic of the reasoning and the soundness of the conclusions reached by this board. The numbers of officers required for the carrying out of these recommendations could, of course, be best calculated by the Bureau of Navigation which has approved the report of the board in toto. Such estimates as follow herein are simply given for the purpose of showing that a certain number of officers should be allowed for the colleges and schools, and that the proper numbers can be calculated by a simple method.

In peace times the course at the Naval War College is of paramount importance. All officers should have it before reaching the grade of rear admiral. There must be provision in the peace time requirements to allow for the number of officers who constantly should be in attendance. If such allowance is not made the regular sea and shore forces will be greatly handicapped by continual shortages. It is also important that there should be this allowance, as the officers who are in attendance are, together with certain others performing shore duty, the only trained reserve in the higher grades.

There should be two War College courses, one for the officers in the grades of lieutenant commander and commander, and one for those in the grade of commander and captain. For convenience in administration, as well as for educational considerations, there should be a definite policy in regard to what officers are eligible for the courses, and the numbers to be in each of the classes.

Every officer should preferably complete the junior course prior to commanding a ship as large as a destroyer. Every officer should preferably complete the senior course prior to commanding a battleship or a battle cruiser. If this is adopted as policy, then the officers taking the junior course should be taken from the

upper half of the lieutenant commander's list and the lower half of the commander's list; those taking the senior course should come from the upper half of the commander's list and the lower half of the captain's list. It is not held that this is an absolute requirement, as the administrators may find from a more complete estimate than is made here that some other division is better, as in the recommendation of the board referred to above.

However, using the above as a basis it is a simple matter to ascertain the number of officers that should be in each of the classes to insure all the officers taking the courses. There are required for shore duty and sea duty a total of 742 captains and commanders. One half of this number, 371, must have the opportunity of taking the senior class course between the times of reaching the upper half of the commander's grade and the upper half of the captain's grade. This normally should be a period of approximately eight years. Therefore, allowing for casualties, there should be 50 officers in each senior class. The proportion of captains to commanders should be the same as that between the two grades, which would make in each senior class 17 junior captains and 33 senior commanders. By the same process of reasoning, allowing a period of 10 years as the average time of passing from the middle of the lieutenant commander's list to the middle of the commander's list, there would be required for each junior War College class a total of 85 officers, distributed in the proportion of 23 junior commanders and 62 senior lieutenant commanders.

The assignment of officers to the War College is necessary if our high ranking officers are to have the knowledge required for the successful operation of the fleet in time of war. There is no more important duty for an officer in time of peace. These officers cannot be ordered to take the courses unless there is an allowance for them in the authorized numerical strength. The success of the navy as a fighting organization in time of war depends more than anything else on the qualifications of the high ranking officers. It is unjust to these officers, to the naval service, and to the country, to deny them any opportunity for attaining fighting efficiency. Therefore the few additional officers necessary in order that all may have such opportunity must not be begrudged by the legislators.

Younger officers, after they have been commissioned from five to ten years, should be assigned to take the general line course in order (1) to confirm the Naval Academy education in the light of their sea experience, (2) to start them in the study of command and staff duty, and (3) to broaden their understanding of the conduct of affairs in the political, economic and industrial worlds.

In addition to the year's work of the general line course, a certain proportion (say 10 per cent) should have special instruction in the theories which govern the design of ships, engines, guns, torpedoes, etc. In order to insure this there must be post graduate technical courses covering these subjects. It is the practice to assign a number of officers who show special inclinations for this duty to classes at the Naval Academy, industrial plants, and certain of the universities. This practice must be continued if we are to develop sufficient officers with the necessary technical knowledge to insure the ability of putting into practice certain things which practical knowledge show to be necessary or desirable. The great field to be covered requires at all times no less than 100 of the younger officers to be taking post graduate technical courses. These should be evenly divided in the grades of lieutenant and lieutenant (j. g.).

A summary of the officers who should be allowed for educational purposes is:

Captains .....	17
Commanders .....	56
Lieutenant commanders .....	62
Lieutenants .....	75
Lieutenants (J. G.) .....	75
	<hr/>
Total .....	385

This is only about 6 per cent of the total line officer requirements.

The figures arrived at by this method of calculation are not so large as if the recommendations of the board, above referred to, were followed. It is acknowledged that it would be better to adopt the board's report in its entirety and base all the calculations on the recommendations contained therein. But, as previously pointed out, in all the estimates given in this paper, the question of cost has been considered, and the figures arrived at are not

those that would give the maximum efficiency, could cost be eliminated, but are *the minimum numbers permissible*.

It has long been recognized as essential that all recruits should have a preliminary period of training on shore before being sent on board ship. This is in order to give assurance that the incubation period for the contagious diseases is passed, and to teach the young men how to take care of their persons and their clothes. They are also given their first insight into military methods by preliminary instruction in handling boats, infantry, artillery, etc., so that when they appear on board ship they will know what it means to obey orders, and therefore be that much more easily assimilated into the organization.

Experience has demonstrated that this period of instruction at the training stations should be four months. The length of this period together with the number of replacements that must be made each year determine the number of men that should always be under training. This is arrived at as follows:

It has been shown (Table XXII) that the peace time requirements of enlisted men ashore and afloat are in round numbers 145,000. The average normal enlistments are for four years. We should therefore expect that one-quarter of this total would be lost to the service each year owing to expiration of enlistments. But owing to attrition from sickness, special discharges, desertion, and bad conduct, etc., the annual loss is in reality approximately one-third of the total, and the loss from expiration of enlistments is approximately only one-fifth of the total. The total annual loss, therefore, is one-third of 145,000 or 48,000. Of this number, one-fifth of 145,000 or 29,000 is from expirations of enlistment. The number of replacements with recruits that must be made each year is the difference between 48,000 and the number of reenlistments. What percentage of reenlistments can we expect? A study of the statistics has shown that it varies from 30 per cent to 85 per cent. The average, under normal conditions, can be taken at 60 per cent, which means that out of 29,000 men discharged each year on account of expiration of enlistment, approximately 17,500 will reenlist. Subtracting this number from 48,000 (the total annual replacements that must be made) leaves 30,500 recruits to be obtained each year, all of whom should pass through the training stations. The time to pass through the stations being one-third of a year, there should be approximately



one-third of 30,500 men under training at all times. However there is a large percentage of losses, due to various causes before the recruits pass through the training course to general service. To allow for these losses the average number of recruits under training should be not less than 12,000.

With the low rate of pay for recruits, it cannot be expected that men who have already learned a trade will enlist in any great numbers. It is therefore necessary for the navy to conduct a number of trade schools in order that the enlisted men may be given the absolutely essential instruction in certain technical matters that will insure the efficient maintenance and operation of the ships. There have been a number of such schools in operation for a number of years. They are essential. They must continue to operate. These schools are for the instruction of torpedomen, radio men, electricians, machinists mates, yeomen, gunners mates, cooks—all of which there is no supply from civil life. The least number under instruction that can supply the needs is 3000 men. This number added to the recruits, makes a total of 15,000 men that must be under training at all times.

#### REPLACEMENTS

It has been shown that 6598 commissioned line-officers and 144,285 enlisted men are necessary to officer and man the ships and shore stations on a peace basis. With the great number of changes continually taking place owing to sickness, transfers to other duty, retirements, expirations of enlistments, promotions, and other causes, there is a continual shifting of the personnel from one station to another. This shifting goes on at a rate detrimental to efficiency. It should be reduced to a minimum. It can only be appreciably reduced by having a surplus for replacement purposes. If there is no authorization for such a surplus, all of our ships and stations are bound always to be short of the number of men necessary for efficient operation. There never has been any allowance for these replacements. This is the main cause for the continual changes that bring forth so much complaint from the fleet. Unfortunately these complaints are usually made in connection with the target practice reports and are therefore considered confidential. Neither the public nor the legislators know anything about them. It is impracticable to reproduce them here, but anyone sufficiently interested need only

read those portions of the target practice reports prior to the Great War which deal with personnel to appreciate the great loss of efficiency due to continual changes in personnel. It is clearly shown in these reports that this continual shifting, mainly brought about by inadequate personnel, results in our never getting beyond the elementary stages of training. This is not as it should be. It can only be remedied by having an allowance for replacements. What should the allowance be?

The records show that an average of about one and a half per cent of the commissioned officers are unavailable for duty owing to sickness. It shows that about three per cent of the enlisted personnel are unavailable for the same reason. These percentages do not include those who are temporarily ill at their stations, but only those who are actually under treatment at hospitals and on sick leave. With the large number of widely scattered ships and stations which necessitates much travelling to and fro; with the leave that is necessary after a tour of strenuous duty, and for the men who reenlist; with the necessity of having depots—or receiving ships or barracks, as we call them in the navy—in order that the men may be assembled and distributed, it should be realized that there must be a percentage allowance to take care of these items. This allowance has been found by long experience to be not less than two per cent for officers and five per cent for enlisted men of the total operating forces. Endeavor after endeavor has been made by the administrators in the Bureau of Navigation to reduce this number, but it has been found impossible. The fleet cannot be supplied with personnel to fill vacancies, unless there is such personnel available for distribution.

The hearings before the Naval Committees of Congress always develop an opposition on the part of the legislators to provide for these replacements. "Why," they ask, "is it necessary to have several thousand men apparently idle on receiving ships?" It might as well be asked why is it necessary to have store houses with stores in them, fuel depots with fuel in them, reservoirs with water in them. Just as stores, fuel, and water cannot be supplied to the ships and stations without having storage depots for them, so neither can men be supplied and distributed unless they are first assembled at the receiving ships. This is a necessity it is impossible to get along without.

These replacements complete the requirements for ascertaining the strength of our active commissioned line officers and enlisted men on a peace time status. The basis for the estimate is the number of ships now on the navy list together with the shore establishment which present policy requires to be operated.

TABLE XXIII.—SUMMARY OF COMMISSIONED LINE OFFICERS AND ENLISTED MEN REQUIRED FOR ACTIVE SERVICE IN PEACE TIMES

Rank	Requirements at sea and at shore stations. Table	Additional for educational purposes	Additional for sickness. Officers 1.5%, enlisted men .3%	Additional for replacements. Officers 2%, enlisted men 5%	Totals	Percentages in grades by this estimate	Percentages in grades by present authorization.
Admirals .....	2	0	0	0	2	....	....
Vice admirals.....	5	0	0	0	5	....	....
Rear admirals.....	72	0	1	1	74	1.1	1.0
Captains .....	266	17	5	5	293	4.1	4.0
Commanders .....	476	56	7	9	548	7.6	7.0
Lieut. commanders.....	1,184	62	18	24	1,288	18.1	14.0
Lieutenants .....	2,184	75	33	44	2,336	32.9	32.5
Lieutenants (J. G.) and ensigns.	2,409	175	36	48	2,668	36.2	41.5
Totals .....	6,598	385	100	131	7,214	100.0	100.0
Enlisted men.....	144,285	15,000	4,300	7,200	170,785		

The facts to be learned from this summary together with the reasoning which produced it are:

1. That to insure to the country the readiness of the navy for war, should such an event occur, there must be maintained in times of peace a personnel of sufficient size to insure the immediate employment, in an offensive rôle, of the ships we possess. The number of enlisted men required for this purpose is 170,785. The number of commissioned line officers is 7114.

2. That any reduction in these numbers will result in a corresponding reduction in efficiency, which loss of efficiency will always be in greater proportion than the direct shortage in numbers.

3. That the present law which places the commissioned line officers at four per cent of the enlisted personnel is satisfactory.

4. That the authorized percentage of officers in grade is approximately correct. The chief difference being in the increase of

the lieutenant commanders by four per cent, and a corresponding reduction in the grades of lieutenant (j. g.) and ensign. This is mainly due to the increase in the number of destroyers which require lieutenant commanders as commanding officers.

5. That as the present percentages in grades for the line officers are correct, it can be assumed that the percentages allowed for the staff corps are also approximately correct. Consequently the numbers in all the staff corps should be increased to correspond to the increases found necessary for the line.

It especially should be borne in mind that :

1. In this estimate 73 per cent of the enlisted men are assigned to sea duty, while usually it has been found practicable to actually have only 70 per cent on board ships. Therefore any errors that may be in the summary are on the side of an under estimate of the actual requirements. The figures arrived at are conservative.

2. That a large number of valuable fighting ships, including dreadnaughts and new destroyers, are provided with only partial complements. That in case of war they cannot be employed until the crews are mobilized, and that they cannot fight until a period of training has been had after the mobilization.

3. That there is no reserve for the higher grades other than a certain percentage of the regular officers employed on shore and those taking the special courses in the War College classes.

4. That the reserve of lower officers must come from our regular reserve force and from the upper classes of the Naval Academy, a very few of whom have had any real training in the fighting line.

5. That the reserve of enlisted men must come from the fleet reserve, as no others of the reserve force are men-of-warsmen except in name.

Therefore the next step in our study is to look into the Naval Reserve Force and ascertain whether or not it can meet the demands which will be made on it when employed in connection with the regular active force of 7214 commissioned line officers and 170,785 enlisted men.

#### THE NAVAL RESERVE FORCE

In determining the number of officers and men required to man our fighting ships on a peace basis, the estimate was made on the assumption that 292 of these ships would be operated with half

crews, and that 71 of them should have only sufficient personnel on board to insure their material upkeep. It would add greatly to the efficiency of the navy if all these ships could at all times be kept in service with full complements. This is impracticable owing to the cost involved. The number of additional men necessary to place these 363 fighting ships on a fighting basis is approximately 40,000. The officer requirements are in proportion.

But these 363 ships are not the only ones that require additional personnel in case of war. It is a conservative estimate that an additional 400 vessels would be acquired immediately for auxiliary purposes. The crews of these 400 ships total no less than 60,000 men and officers in proportion. Therefore we are safe in stating that with an authorized active strength of 170,000 men and 7200 line officers (which numbers were found to be the peace time requirements) there would still be necessary for immediate use afloat in case of war an additional 100,000 trained sea-going men and 4000 trained sea-going commissioned line officers.

These numbers, bear in mind, are needed at sea. Many additional will be required for duty on shore, and for the future employment and replacements, both afloat and ashore, as the war progresses. *The requirements for immediate service afloat, together with trained sea-going men on shore, are what should determine the composition of the Naval Reserve Force.* Just as there should be no officers and men in the regular navy who do not at some time or other go to sea, neither should there be any officers and men in our naval reserve force who have not been trained at sea and who are not qualified for sea duty and ready to go to sea in case of a call.

This statement may not be in accord with the generally accepted belief. It is of great importance in connection with this study. This is because it has been assumed in allowing only partial crews of regulars for a large number of fighting ships that there will be *a reserve of trained sea-going personnel* available for making these reserve ships immediately operative. There is already in evidence in Congress a marked antipathy to providing the funds necessary to maintain a reserve force as large as 100,000 men. *In fact there are not now available sufficient funds to maintain a force of that size in a manner that will insure its permanency.* Therefore our efforts should be placed in securing a reserve of sea-going men and officers, and all that are not in that status

should be eliminated. *This is the only assurance that the reserve force will be able to survive in a valuable capacity.*

It is held that unless our reserve force is confined to sea-going personnel, it will not survive. It is also held that any reserve which is composed of officers and men other than those who are qualified for sea duty is not a reserve except in name. There is nothing so dangerous for the success of any future war operations as a reliance on a reserve force which in reality exists only on paper. The people of the country must not be led to believe, as is now being done, that any man who wears a sailor hat is a sailor just because he wears that kind of a hat. Recent developments in Congress show a determination to reduce the authorized enlisted strength of the regular navy on the ground that we have an effective reserve force which, in emergency can step in and take the place of the regulars. This is not in accordance with the facts. It results in false impressions in regard to our naval strength, and if these impressions are allowed to predominate which they will if not refuted, the country gets a false sense of security which may result disastrously. To show that these suppositions in regard to the reliance to be placed in our reserve force are erroneous it is necessary to make an analysis of its composition.

The naval reserve laws as they now stand on the statute books are the outgrowth of an appreciation of the necessity for a reserve force. They were framed without an appreciation of the proper composition of such a force, and its relation to the numerical strength of the regular service. The first fundamental principle violated is the neglect of confining the membership to officers and men who really are reserves. From a military standpoint *a reserve is one who passes into that status from the regular service, and none should serve in the reserves until he has had service as a regular.* By far the greater part of our reserve force as now constituted came into this organization not through the regular service, but direct from civil life. They had no previous military or naval training and therefore *were reserves in name only.* A large part of this personnel did not go to sea and did not in any way qualify for naval service. Many did not complete their preliminary training at the camps on shore, and a large number spent their entire service at the desks in the numerous offices maintained throughout this country and abroad. Many of them did no duty other than construction work on shore and as

stevedores. About 10,000 of them are women. In fact the greater part of them did everything rather than regular navy duty. *And these are the men who are now being depended on to complete the complements of our fighting ships in case of emergency and to put in service the four hundred additional auxiliaries that would be required immediately. The folly of depending on this is self evident.* The men individually are fine; the principle is entirely wrong.

Although the law authorizing the formation of the reserve force became effective several years before this country became a belligerent, the Navy Department was unsuccessful in its attempts to organize an effective force prior to the war. As soon as war was declared, this so-called reserve force grew with leaps and bounds until it reached a numerical strength of 300,000. The reserve law saved the situation for the navy. Not because it was a good law, but because the statutes did not permit of sufficient regulars to man the ships, nor the clerical force necessary to do the work, and therefore both the regular naval service and the civil service of the Navy Department were operated by the enrolled reserves who, in reality, were untrained regulars and clerks. In other words our present reserve force did not come into existence because of the possibility of war, but because of the actuality of war. As certain as this organization found its creation because of the war, just as certain will it find its death because the war is over. It cannot be saved unless the laws are changed, and unless we come to appreciate the fact that the only reserve that should be maintained in times of peace is one that is at all times qualified for sea service.

The attrition taking place in the reserve force has been steady since the Armistice. During the year 1921 a large number of enrollments will expire. The majority will not reenroll. In two years from now the reserve force will be a mere skeleton. To keep it alive requires much more money than Congress appears willing to appropriate.

If the limits of this study permitted, further reasons could be given to show that our reserve force cannot survive *as an effective force under present conditions*. This is evident to anyone who has studied the subject. The assertion is made here because our regular force is being depleted on the false assumption that we are going to be able to rely on a defunct reserve in case of another

war. We must do something to make and keep our reserve force effective. The first step is to eliminate the non-sea-going portion and place our efforts into building up the sea-going part. Even with 170,000 men in the regular naval service we require an active sea-going reserve of not less than 120,000 men with corresponding officers. Otherwise the navy will not be able to throw its full force into any future war that may come. The numerical strength of the sea-going reserve is far less than 120,000.

#### CONCLUSION

There are, of course, many elements in addition to the numerical strength which should be treated in a study of our naval personnel situation. Practically all of them are affected by the numerical strength. To discuss them is impracticable within the limits of a paper of this sort. They will be left for future consideration. But it is important to keep in mind that if the navy once finds itself in a position where there is sufficient force to work with, the other problems which confront it will be comparatively easy.

Even if our ability to start immediately on a whole-hearted offensive should not effect the final outcome of the next war, it will of necessity have a great influence on the length of the war. It is an historical fact that the longer a war lasts the greater the expenditure in lives and money. It is our duty to make this expenditure as small as possible. This cannot be done unless the navy is always ready for immediate offensive operations. *The navy cannot be ready for such operations unless there is maintained an active regular force of not less than 170,000 men with corresponding officers, and an organized sea-going reserve of not less than 120,000 enlisted men with the corresponding officers.* These numbers are simply a matter of arithmetic. Should there be partial disarmament, there should, of course, be a corresponding reduction in personnel. On the other hand should Congress make provision for new ships, there must be a corresponding augmentation in the number of officers and men.

These potent facts having been pointed out, the navy must guard against the public getting information which is not in accord with the truth. It is such information that leads to false assumptions and consequently to inadvisable legislation. There



is evidence now of this in the avowed intention of Congress to reduce the numerical strength of the navy enlisted personnel to 100,000 men. If this is done, it means that the ships of the navy will revert to conditions even worse than those pointed out by the commander-in-chief of the Atlantic fleet in the confidential report made in 1915, previously quoted.<sup>1</sup>

Let us not forget that, "Men fight, not ships."

<sup>1</sup> See page 1169.

[COPYRIGHTED]

U. S. NAVAL INSTITUTE, ANNAPOLIS, MD.

---

RADIO COMMUNICATIONS  
FROM AN OPERATOR'S VIEWPOINT

By LIEUT. COMMANDER C. N. INGRAHAM, U. S. Navy,  
Aide and Force Radio Officer, Staff of Commander Destroyer  
Force, Pacific, U. S. S. *Charleston*, San Diego, Calif.

---

The present state of Naval Radio Communications, from the operating viewpoint, is capable of great improvement. The steady progress made in recent years in quality and quantity of radio apparatus has not been followed by a corresponding increase in efficiency of operation. The service may successfully meet this problem if we realize more fully the importance of radio, and attain a greater knowledge of the limitations and possibilities of radio communications.

One of the cardinal principles of warfare is the concentration of a superior force at the critical time and place. This is a collective effort of the highest degree. Coordination is the most important element in any collective effort. Communication is the most vital factor in coordination. Accurate and speedy dissemination of information and transmission of orders is the ultimate aim of our naval radio communications.

A commander-in-chief cannot hope for a successful campaign without an efficient communication system. It is up to the communication personnel to deliver such an efficient performance of duty as to obviate the danger that efforts of flag and commanding officers may become, through failure and delay in communication, individual unit efforts, which would defeat the cardinal principle of naval warfare. Obviously then, since communication is vital to those in command, it is from these officers that the impetus for the betterment of naval radio communications must come. In order that they may give the movement the proper direction, these officers should know the limitations and possibilities

of radio communication in much the same manner that they are cognizant of the same factors in any system of visual signals. Unfortunately, radio is a recent development still in the process of rapid changes and improvements, and is, consequently, a difficult subject in which to keep oneself fully informed.

In all departments of the naval profession, while material never reaches the ideal of giving perfect satisfaction, I believe that most faults develop and failures occur by reason of the personnel falling short of perfect performance of duty. This is the case in radio. To a lesser degree than "Wooden ships—iron men; iron ships—wooden men," may the relative advance and retrogression of apparatus and personnel be compared. Not all limitations of radio communications may be ascribed to personnel, but I have seen makeshift apparatus operated with more reliability, at greater distances, with efficient personnel, than more recent apparatus of higher power and supposedly greater range, with inefficient personnel. In most cases this was due to the superiority of the personnel operating the makeshift apparatus—superiority in the point of morale.

We are all decrying a lowering of morale among our enlisted men, ascribing it to causes varying from rapid demobilization and high rate of pay in civil life, to the inexperienced and youthful personnel of this day. All of these are doubtless contributing causes which go to make up an unsatisfactory condition. We cannot place the blame for, nor correct conditions which are beyond our power to control. We can, and should take such steps as are in our power to better as a whole, or in part, those conditions which lie close to us and contribute greatly to this lower state of morale. Any advance in morale must start at the top and permeate downward through the forces of inspiration and example. I do not believe that the enlisted man of the present day can, or will, be reached through any other method than by example and by corrective measures. Respect and admiration for his superior officer will lead him to do more than his duty. Fear of punishment will breed only compliance with commands or orders. He can be led to any end by the proper leader, but can be driven only so far. There is no better way to gain the enlisted man's respect and admiration than by showing him that his superior knows more about his game than he does himself. This breeds in him a desire to reach the same degree of perfection.

In radio this is perhaps truer than in any other branch, due to the fact that it is a new, everchanging, and somewhat mysterious game, and, is regarded with something akin to awe by those who do not know it. If one excuse, which the operator knows is invalid, is accepted by a superior, new ones are thought up and the game of "putting something over" becomes a more engrossing one than the radio game. In addition, the operator begins to think his officer does not know as much as he and rests content with his superiority, and he might believe that his superior does not care much, and would not appreciate his best work, even though it reached perfection. But the officer who can send and receive, can command the respect and enforce the obedience of the men under him, and *in no other way* can he do it. If he can send and receive more accurately than they, he has their admiration and gains efficiency through their emulation of his expertness. Once an officer learns to operate, he has valuable talents above those of the enlisted man which render him in every way a more capable and efficient operator.

The first fleet radio officer under whom I served, then Lieutenant S. C. Hooper, could operate faster and with a greater degree of accuracy than any man under him. He was the fleet radio officer in the days when, if ship operators were kept out of port unexpectedly, they might ask one of the shore operators, "Say, old man, how is it to call Gertrude and say I can't get in today"; when Morse and Continental were mixed according to the desire of the sender, and when no regard was given to any form. By continual practice he learned to tell each vessel in the fleet by her spark, almost unerringly, and to distinguish, by certain peculiarities, the sending of each man under him. He was not the only competent officer operator in the fleet, but in being one, and realizing its importance, he was able to take the necessary steps to see that all radio officers be detailed for that duty alone, and that they give to their work a certain number of hours each day including one watch. Though all of these did not take advantage of the opportunity to become proficient operators, a certain percentage took enough interest in the work to master operating. I know that some of those who made good, disliked the assignment at first as much as, or more than, those who did not make good, but later became interested through the determination to do their best in any position assigned. For it is interesting after the long

and tedious practice necessary to acquire proficiency is finished. It is as much a real game as auction bridge, and requires infinitely more finesse.

When this officer left the fleet, he had brought it to the highest state of efficiency possible at that time with the apparatus provided. Every operator in the fleet wanted, above all else, to "burn up" the fleet radio officer, and at the same time send "good stuff." They could not do this, but they kept trying. Each operator hated to be obliged to ask for a repetition of any part of a message because the fleet radio officer never did. Mr. Hooper would tell them he had transmitted so many miles, or had received such and such a distance with a stated apparatus, and they would endeavor to beat that record. At one time, in Vera Cruz, at a conference, he said he had copied a message from Nauen, Germany, where a new spark station had just been installed. One operator, I know, sat up all night the following night with the radio room completely shut up—not even a fan going, for fear of induction—and copied a complete message from the same station, on a crystal detector where the fleet radio officer had used an audion. You may say that such things as this officer was able to do are not possible with the fleet at its present proportions. No, not as a whole, but distinctly YES, if all forces, squadrons, and divisions, had officers well versed in operating and in procedure.

An officer must know operation to its finest detail to have an efficient radio force. Naturally, he must have material from which to form operators. Here again, the cooperation of the senior officers can be of great value. In many cases the divisional officer, upon being ordered to transfer one man to the radio division, calls for the boatswain's mate and asks which man is least useful, and that one goes. Or, to be more charitable to them, divisional officers may call for volunteers and select the least useful of these without inquiring into their qualifications. If he is useless in the mechanical details of drills and lazy about work, he has less chance than the proverbial snowball to become even a fair operator—radio, certainly, is no place for deadwood.

The principal causes of the poor state of operation in radio communication are interference, static, and faulty sending; of which interference is the most important. This could be reduced to an unimportant factor by intelligent supervision. The most frequent causes of interference are:

1. The operator refuses to observe the rights of others to finish communication already established by them before he can use the same wave length. In some cases this may be merely carelessness in failing to listen in before opening up, but in many cases operators hear the other vessels transmitting, and in the endeavor to clear traffic, will increase power to the maximum and try to force his message through. It may also arise from the fact that sometimes the originating officer, on being told that his message must wait on account of the other vessels sending, orders, "Get that message through." A complete understanding of the problems of radio communications would obviate such an order.

2. The power of transmitting apparatus is not regulated according to the demand of the moment; that is, it is not reduced to the minimum consistent with reliable communication. This also causes interference on neighboring wave lengths on vessels nearby. But, in order to intelligently regulate the power, the operator must know approximately distances of station for which messages are destined, and must take into account the strength of static. The superior officer who understands radio communications, keeps the radio room informed of the location of the vessel with which it is desired to establish or maintain radio communication. Operators usually open up on the highest power in order to be certain to reach the other vessel. Intelligent officer supervision would reduce this fault, and in time, would obviate it.

3. The tuning of the modern apparatus and the use of rejectors and acceptors, where fitted, would decrease the "interference" excuse if the operators were properly instructed in the use of the instruments. Here again intelligent officer supervision would provide for the instruction of operators in the proper use of the instruments. I remember in an inspection of one vessel, the instruction books issued by the department were found in the safe of the communication officer, having never been touched.

But the "interference" excuse is, as often as not, a case of pure laziness on the part of the operator who does not care to make the necessary effort to concentrate on one of two spark tones. Where signals are of equal strength, one spark can usually be read through another one by concentration on the one tone for very few sparks are exactly alike. Here again the officer operator comes to the front. He has learned to concentrate, can do it with less effort, and therefore *will* concentrate and get his message.

"Static" is another excuse given by operators for inability to get messages through. It, also, is a perfectly logical excuse, but only in the minority of cases where it is given, does static actually prevent communication. Up to the point where static discharged occupies fifty per cent of the given period, messages can be easily read by those who are able to concentrate. It may require repetition, but if intelligent operators are sending, it should not require anything more than "heavy" sending or repeating each word twice."

One of the most frequent causes of inaccurate communication and of slow communication is that of too rapid sending. This also, has a distinct bearing on the question of interference, since invariably repetitions of all or parts of messages are required. The transmitting operator will usually endeavor to "burn up" the receiving operator by a burst of "speed," in which he cannot send accurately, and which he probably could not read himself if he had not the message before him. Also the receiving operator will answer a "call up" with a speed which he himself would be incapable of receiving. This deceives even a good operator, who endeavors to send according to the ability of the receiving operator. Proper regulation of speed of transmitting would do much to increase the efficiency of communications in which, as in every other branch, accuracy must be the first consideration. Yet if the officer in charge cannot operate, he cannot control this, though he gives a thousand orders.

The result of all this is that, excepting in cases where competent officer operators who are interested in their work are in charge, radio communication is almost entirely controlled by enlisted personnel. There is no other department which is so controlled, yet there is no other branch which is more important strategically or tactically in peace or war.

I have endeavored to bring out the salient features of the faults at present existing in radio communications and have tried to show that each fault may be lessened and finally eradicated by proper officer operator supervision. I can go further and show that in war time, officer operators can solve some problems connected with scouting, in addition to that information furnished by the radio compass, without seeing the enemy, providing the enemy's radio is not entirely silent. There are minor but unmistakable differences between the installations on various classes of

vessels, just as there are dissimilarities between the tone of installations of the same class. There exists a marked difference between the note of low power and a high power note of the same installation. This difference also is noticeable in stages between highest and lowest power—to a practiced observer. An experienced officer operator should know the power necessary for certain distances. In this way he may, by hearing an enemy vessel transmitting, determine the class of vessel and her approximate distance, by means of note and power. In a like manner he may be able to determine relative distances between the vessel of origin and the vessel addressed, and from this there may be formed an estimate of the disposition of the enemy in regard to concentration. The results are approximations, if you like, but the more experienced the observer, the closer the approximation.

In addition, the officer operator would know which of any number of messages were most important to deliver first, and this ability to discriminate would be invaluable for rapid and efficient communication in time of war.

We can safely assume that officer operators would not commit, nor allow, any of the faults of communication I have enumerated. In addition, the use of wrong form and unofficial conversation would be eradicated. These points alone would make it worth while to train all radio officers, but the further points of greater ability to concentrate and discriminate, should make them indispensable.

However, the trained officer operator is not the complete answer. Flag and commanding officers should be as conversant with the possibilities and limitations of radio communications as they are at present with those qualities of bridge signals. With knowledge of these points would come realization of that approach to perfection of devotion to duty, which they can exact from their radio officers. And if the best be demanded, the best will be given in line down from flag officers through commanding officers and radio officers to the lowest rated man in the radio division.

But to continue, necessarily flag and commanding officers must be indoctrinated with the idea of the importance of radio communication and the utter futility of conducting an efficient campaign without the best possible radio control. This, it would appear, could best be accomplished by including it in the cur-



riculum of the Naval War College, not as a side issue, but as one of the main features of strategy and tactics of chart maneuvers and game boards. It may be that the reader believes that I am overestimating the importance of radio communication, but to controvert this idea one has only to consult standard works of eminent strategical and tactical experts. In all of these may be found examples of failures or defeat due entirely to lack of information, delay in transmission, inaccurate information, and inability to transmit orders accurately and speedily. The examples may not apply today in the factors of composition of fleets or their disposition for battle, but where these factors have changed, corresponding changes in other factors will be found making cause and effect equal.

Obviously then, in common with all other advances in efficiency, the forward movement in radio must be initiated and pushed by flag officers by exacting from their subordinates the closest approach to perfection that they know is practicable from consideration of the limitations and possibilities of radio communication. In order to approximate this perfection, radio officers must learn to operate and must learn "communications." When operators learn that their officers understand the possibilities and limitations of radio, and that their work will be taken at its face value, they will produce the results that are desired. For after all, even the lowest in the scale finds joy in a duty well performed and accurately appreciated.

[COPYRIGHTED]

U. S. NAVAL INSTITUTE, ANNAPOLIS, MD.

---

## AMALGAMATION AND SPECIALISTS *VERSUS* CORPS

By COMMANDER J. O. FISHER, U. S. Navy

---

1. The keystone argument advanced in favor of corps and specialists is "that the activities of this particular line require a special knowledge and special training." This argument applies equally well to both. It is the equivalent to saying that one man is not capable of doing all things equally well.

2. As an argument for specialization of officers, it carries exactly the same weight as assigning officers to different duties. If used for the establishment of a corps it is equally applicable to the organization of all officers in corps. The objection to a corps is that it is not a number of specially qualified individuals along identical details of naval activities, but an organization of individuals covering a wide field of activity. Therefore, an argument for specialists—special knowledge and experience—is not an argument for organizing these individual specialists in a corps.

3. Corps continually extend and increase in power and authority, all of which must be given up or taken over from the existing authority in the navy. The preceding conclusion is obvious since authority cannot rest in two places for the accomplishment of any given result. For that reason, all authority in the corps organization is authority subtracted from the navy and given to an organized few in the navy.

4. The next step after the formation of a corps of officers is to provide enlisted personnel. The first step has already been made by the medical corps in acquiring hospital corpsmen, over which they have greater control. If this action is necessary why should not gunnery officers have control of gunnery corpsmen, or engineer officers, control of engineer corpsmen, or communication officers, of radio corpsmen, or navigators, of navigation corpsmen? It certainly takes no longer to make a hospital corps-

man than a gun pointer, or engineman, or radio operator, or helmsman.

5. The same development has taken place in the present supply corps. As the original pay corps, they controlled the expenditure of money under the commanding officer, who made the return to Washington. At that time, the pay officers were a few specialists. Since then, they have been consolidated into a corps with an organization established by law in the Bureau of Supplies and Accounts and they have acquired the control of the pay, clothing and small stores, commissary and, now, the purchase of all supplies except new ships. The time is not far distant when they may require their own supply corpsmen, and, for the same reason, obtain the same decision the medical corps obtained—that their requirements of personnel are such that they cannot be adequately supplied by the Bureau of Navigation.

6. In all of these cases, the big argument for the establishment of a few specialists has been “that the activities of this particular line require a special knowledge and special training.”

7. As has been stated previously, this is no argument for the establishment of a corps. It is an argument for the designation of specialists, but nothing more. The establishment of corps is due to the desire for power by certain specialists who realize that special knowledge along only one line of activity places them in an advisory capacity only. It does not qualify them for executive authority in the navy. Therefore, they acquire executive authority in law by weight of numbers and the desire on the part of many line officers to be relieved of the drudgery of details.

8. Corps cater to mental and physical laziness in officers of the line. They relieve the line officer of detail drudgery. He is glad to escape. He pretends to admire their efficiency when he really wants to shirk the detail drudgery of their work. In the meantime the corps have transferred the detail drudgery to the junior officers of the corps, to draftsmen and to clerks.

9. How many officers in each corps are actually doing the special work for which they were trained? Most naval constructors are in navy yards or on inspection duty. Few are doing the work for which they were specially educated. Most of them are doing similar duty to that performed by line officers on inspection duty, navy yards, and in the bureaus.

10. The senior officers in the supply corps are all doing administrative work, similar to that performed by line officers in administrative positions ashore in navy yards and at the bureaus. Again in the medical corps, which is the specialty of specialties, there is a similarity between being executive officer of a hospital and first lieutenant on a ship. Few of the senior officers of the medical corps are doing the duty of a specialist. Most are doing administration duty which is almost diametrically different and calls for broad general experience and knowledge of the navy.

11. An analysis of each corps and the duty performed by its senior members will disclose that it is the exception and not the rule for corps members to be doing strictly specialist duty. They are exercising that part of the administrative authority delegated under the law to the corps' bureau. They have ceased to be specialists and have become administrators and co-ordinators of specialists in the navy although their experience and knowledge has been limited by their corps activities.

12. There is a reason for specialists in all lines of activities in the navy. But, that is not a reason for combining specialists along certain lines in a corps organization headed by a bureau with control of appropriations and authority subtracted from the central authority.

13. The navy consists of (1) the fleet and (2) the shore establishment. The sole reason for the existence of the shore establishment is the fleet. In time of war, the fleet, by the decision which it obtains in battle, must justify the existence of the navy and the expenditure on the navy. For that reason, the organization and administration of the fleet must be at least equal and should be superior, as an instrument for action, to the organization and administration of the shore establishment.

14. The fleet is a complicated weapon. It is divided into battleship, cruiser, destroyer, submarine, mine and air forces and the train. The names of the different forces indicate in general their function in the fleet. Each force, to a greater or less degree, has its own tactics, its own weapons, its own personnel, and its own separate and distinct functions in fulfilling the mission of the fleet, all of which are coordinated and administered by the commander-in-chief and his organization.

15. The fleet must be paid, clothed, fed, receive medical attention. Crews must be developed and trained for each turret, engine

room, fire room, fire control party, for navigation and communication, and to handle each unit of each force as a unit of that force. The men doing what is called engineering duty must handle reciprocating steam engines, gasoline engines in power boats and aircraft, Diesel engines and storage batteries in submarines, turbine generators and electric on the more modern battleship. Communication requires training of individuals to handle visual signal and radio. The train must supply fuel, fresh provisions and other necessary supplies and repair facilities. These are only a few of the multitudinous activities in the fleet.

16. Officers are assigned to different ships as navigators, gunnery, engineer, turret, fire control, medical and supply officers, first lieutenants, communication officers, engine room watch, deck watch, and all of these details to duty are for varying periods of from one year to three years.

17. To continue in one line of duty for a period of three years is the first step in making a specialist. To continue for a longer period than three years in a particular line of duty is to be limited in opportunities for broadening an officer's experience. Only in the medical profession are more than three years' special instruction and training allowed to make a specialist. And, three years' experience and training in any particular line of duty mentioned above, or on any particular type of ship mentioned above, will have a similar effect in training a specialist. After three years spent in a special line of work, an officer then by change of duty, acquires a broader knowledge and experience in the navy. If he belongs to the line, the duty available for him is much broader, and furnishes a much wider range of experience than as though he belonged to any corps. An officer of any corps after a three-year tour of duty is limited as regards the opportunities for general experience open to him. Officers of corps are cut off from a great many activities for which they are well fitted. Vice versa, corps cut off many line officers from acquiring experience in the activities of that particular corps as limited in general by the duties assigned each corps.

18. Line officers have, in the past, controlled the navy. They have done so not by virtue of any God-given right of birth or by any other special privilege, but solely by virtue of custom based on the fact that their range of duty and the variations in duty to which they may be assigned and for which they may be held

responsible for results, is much greater than that of any specialist. In the navy, if a ship is given a particular mission, that ship must accomplish the mission, and the commanding officer is held responsible. If a man gets sick and he has no doctor, it is up to the commanding officer. If the pay officer dies, the commanding officer must assume the responsibilities and detail a relief from the line officers. If the ship runs aground and receives much damage and must be repaired, the commanding officer must make the necessary arrangements and pass on the repairs. If it becomes necessary for a commanding officer to build a storehouse or a dock and there is no civil engineer available, the commandant or the commanding officer must get the result. If there is no chaplain, it is up to the commanding officer to hold services.

19. In other words, the duties and responsibilities of line officers are the direct growth from the duties and responsibilities of commanding officers and exactly as no commanding officer can evade any duty and responsibility which is necessary to the operation of his ship in the accomplishment of a given result, so should no line officer evade duty which will qualify and train him to shoulder the responsibilities of commanding officer.

20. In the organization of the fleet as examined above, we have many specialists who assist commanding officers and force commanders in their duties. The specialists, however, are not limited to the members of a corps, but include all officers other than those under instruction and those in command. Neither is there any corps organization in the fleet. Members of corps are all doing their assigned duty. But, as specialists in the fleet, they are not organized under the law with control over any activity in the fleet. It is realized that if a number of individuals with limited knowledge and experience in fleet activities were permitted to organize under the law, with control of any part or function of the fleet, the commander-in-chief would be handicapped in his control. The corps authority would have to be subtracted from his authority. Corps control would have to be subtracted from his control, and corps responsibility would have to be subtracted from his responsibility. It is apparent that if corps organization were permitted in the fleet, the unity of authority and responsibility necessary for obtaining the right decision in battle would be wanting.

21. To summarize, we define a specialist as being an officer with special training, knowledge, and experience in one of the many activities in the navy. We define a corps as being an organization of individuals, under the law, centering in a bureau and controlling special activities in the shore establishment, for which the bureau's appropriations may be expended. We define amalgamation as being an organization in which junior officers are given training and experience along the broadest and most comprehensive lines of activity in the navy, with opportunities for special education and training as they show inclination therefor, and where the senior officers in the navy with a broad and general experience occupy positions as commanding officers and in administrative functions in the shore establishment, all under a single control with undivided authority and responsibility for the efficiency of the navy.

22. The fleet is operated without any corps organization. The shore establishment is operated by corps and bureaus. The bureaus are necessary to perform the same functions that they perform at the present time. But every bureau in the Navy Department can be efficiently administered by officers from the fleet. What bureau activity cannot be accomplished with the fleet personnel?

23. The question therefore evolves around the proposition—Are corps necessary for the shore establishment when amalgamation with specialists doing special duty is sufficient for the fleet? This is the question to which the answer is required. It is undoubtedly easier for the members of a corps to assimilate a limited experience in their corps than to acquire experience and knowledge of more of the activities of the navy. It is undoubtedly easier for line officers to shirk experience along certain lines and to permit the organization of corps to take over those duties. Line officers must remember, however, that each duty necessary to the navy in which they have had no experience subtracts from their qualification to control the navy.

24. More and more are naval activities in the shore establishment coming within the control of corps through corps control of bureaus. Why should a corps control a bureau which controls certain functions only of the shore establishment of the navy?

25. The fleet has many functions included in its activities, and the activities of its forces. No corps controls any function in the

fleet. Functions in the fleet are just as complicated and call for just as much special knowledge and experience as the bureau functions in their relation to the shore establishment. The fleet contains more specialists than any bureau of corps. But the fleet contains no corps. There is no activity in the navy which is not duplicated in the fleet.

26. The fleet has unity in authority and responsibility. The shore establishment has not. The fleet has many specialists and no corps. The shore establishment has many corps and no more specialists than the fleet.

27. The organization of each corps, with its central authority in a bureau controlling appropriations made for the benefit of the navy, weakens the unity of authority and responsibility for an efficient navy.

28. Specialists are necessary. They always will be necessary. But the necessity for specialists does not require their organization under the law as a corps.

29. Why is an organization, under the law, centering in a bureau, necessary for civil engineers and not for navigators? for supply officers, and not for gunnery officers? for naval constructors and not for engineer officers? for medical officers and not for first lieutenants? Why should officers doing special duty connected with pay, commissary, clothing, accounting at navy yards, requisition and issue of supplies, all of which are different, be organized into a corps under a bureau controlling expenditures under appropriations made for the navy?

30. Is it not apparent that the organization of these officers in a corps is unnecessary to the accomplishment of these functions and the administration of the bureau?

31. Members of corps, by virtue of what they know of navy activities outside their specialties, qualify for administrative positions in the bureaus and elsewhere in the shore establishment. An officer of a corps who has had bureau experience only is not qualified to administer the bureau in the interest of the navy. Why, then, should each corps have its own bureau? Why should not each bureau make use of various classes of specialists as their special knowledge, experience, and inclinations especially qualify them, for one of that bureau's activities?

32. For instance, each bureau requires an accounting of that bureau's appropriation. Why should that duty not be done by an



accounting specialist? As a matter of fact, it is, by an officer assigned that particular duty (*i. e.*, a specialist by assignment to duty.) Of course, he may be unfamiliar with that duty at first, but he learns it and adds to his general knowledge and experience in the navy. The only reason for not assigning officers with experience in that particular duty in each bureau is that officers with that special experience are members of a corps, and that their corps or bureau would immediately apply for an increase of officers in the corps to handle these additional details.

33. No bureau wants to be the indirect cause of increasing the number of officers in a corps, centering in some other bureau, and thereby decreasing their own relative authority.

34. Amalgamation does not mean that all officers must qualify in all the forty-one activities of the navy. Such a requirement is absurd. Under a corps organization, all members of a corps are not qualified in all its special activities, any more than are all the line officers qualified in all the activities of the line.

35. At present when an officer is assigned any duty for which he is available under the law, he must assume the responsibility of his rank and grade in that duty. He may have a general academic knowledge of that particular duty and have had no practical experience, and no special knowledge, but he can get assistance from others who have had, he can study the service literature on that duty and as an incentive for his intensive study, he must assume the responsibilities for results.

36. In assignment of officers to duty, a reasonable common sense basis is generally followed of consulting the qualifications and preferences of seniors and assigning juniors where there are opportunities for instruction.

37. This is not only the case in the line, but in every corps. There are naval constructors who have never done any legitimate design work and there are naval constructors who are specialists in duty as superintending constructors at private ship yards and in hull division work at navy yards. There are officers in the supply corps who have never done duty as supply officers of navy yards; others who are always assigned duty as accounting officers ashore; and still others who specialize in disbursing pay. There are officers in the medical corps who have specialized in eye, ear, nose and throat; others as operating surgeons; others as general practitioners.

38. To define corps activities as a specialty is a misnomer. Corps are made up of specialties. The bureaus as the center of a corps is an administrator of specialists. The bureaus as a subdivision of the Navy Department are administrators of specialties. As the experience of the bureau personnel in the navy is broad and general, that bureau is an efficient subdivision of the Navy Department.

39. In fact, every officer in the navy who occupies any position other than commanding officer of a fleet, squadron, division, ship or naval station is a specialist by assignment to duty.

40. Each bureau controlled by a corps controls promotions under selection in that corps by virtue of their control and power of assignment to duty. They can by virtue of this control develop bureau spirit and bureau loyalty in opposition to navy spirit and navy loyalty which belongs primarily to the fleet.

41. With specialists and promotion under selection by a board of rear admirals, and assignment to duty under control of the bureau of navigation, the temptation and control necessary to establish bureau rather than fleet spirit and loyalty are lacking and the whole navy is the recognized power which rewards efficiency and controls the future of all officers.

42. The whole history of development of corps in armies and navies could be written up as a brief which could be known as the "Why of Corps," a splendid example of what logicians term arguing in a circle.

#### THE PRINCIPAL ARGUMENT

The principal argument: The navy is now so big that people must specialize. No man can know all about the navy.

#### FIRST STEP

Specialists are designated. They are given rank and precedence. They are organized as corps in law with a bureau and with executive power, all of which are subtracted from the central authority.

#### SECOND STEP

As time goes on, corps have increasing weight along executive lines. First one corps and then another, as the quality of their leadership determines, acquires a preponderating influence in the counsel of the Secretary of the Navy.

## FINAL STEP

The final act is after we have had a navy run first by supply corps; then by gunnery corps; then by tactical corps; then by engineer corps; then by construction corps; then by medical corps; then by navigators corps; then by marine corps, etc. The secretary and different members of the corps finally realize that they need some co-ordinating authority. So a naval general staff is established to be the co-ordinating influence. The fundamental requirement for the members of the general staff is diametrically the opposite of the original argument establishing specialists. It is realized that to control the navy the members of the general staff must have broad and general experience in all lines of activity. Therefore, after years of development, we finally return to our original position that *an officer to be an officer in the executive and administrative activities of the navy must have general knowledge and experience in all activities of the navy*, and the circular argument is complete in all its error.

## END OF BRIEF

43. A man acquires general experience and knowledge not by shirking details and transferring them to some other individual, but by facing them squarely and obtaining a right and just decision. We cannot close our eyes and render a decision on the plausible argument that "The navy is so large that specialists are necessary" and use that as a reason for establishing a multiplicity of corps. Specialists are necessary. They will always be necessary. They may be temporary or permanent. They may be established by law or by conditions. But, the navy needs no corps as a corps.

44. The officer or officers with the widest knowledge and experience in all the multitudinous activities of the navy are the best qualified to control these activities. *The qualification of line officers for this control is decreased with the establishment of each corps which automatically cuts them off from certain experience and knowledge.*

45. A central control is necessary. The establishment of corps which temporarily subtracts from it, eventually leads to its re-establishment in a naval general staff, of which the members will be given broad and general experience and training in all lines of

naval activity—or the same training line officers have had for many years.

46. Many hundreds of years experience has established the principle “that the power to direct and control flows only to the man who, by general experience, knows how.”

47. It is of little importance what happens to specialists. The variations in origin and training, the environment of duty assigned, and among officers themselves, will always insure a greater and less knowledge and experience of certain special duty among officers. That variation may or may not be recognized in law.

48. What is of importance is the decision on corps. Whether or not we shall have additional corps or shall amalgamate those existing at present.

49. We need special knowledge, experience and training of all kinds in the navy. We need a central authority, with broad general experience and knowledge of all navy activities, to control those activities.

50. We need no corps or other organizations of individuals in the navy to subtract from that central authority.



[COPYRIGHTED]

U. S. NAVAL INSTITUTE, ANNAPOLIS, MD.

---

THE FACTOR OF SAFETY IN NAVIGATION<sup>1</sup>

By COMMANDER FORDE A. TILDEN, U. S. Navy

---

Navigation began as an art, pure and simple, but science has been applied to it to the extent that the majority of present day text books, "wrinkles," and articles on navigation treat it principally as a more or less exact science. St. Thomas taught that where science ends faith begins. The object of this paper is to point out what amount of faith may be placed in it as a science or, in other words, how far in error may a navigator be in the application of his science without being culpable.

One has only to note the many articles on navigation by naval officers to realize the interest they take in it. However, they almost invariably write on how to find the position at sea and very seldom on when to navigate in pilot waters. No arguments are necessary to prove that grounding can only occur in shoal water.

The record of almost every court of inquiry or court martial in the navy for grounding brings out the question, "Why did you lay a course only—distance from the point of grounding?" or "Why did you lay such and such a course?" The answers seldom carry logical weight; they seldom state it was good practice or refer to any authority. Nevertheless, each navigator can establish for himself rules for use in fog and thick weather, when in pilot waters, which will bear inspection. This involves a factor of safety.

A factor of safety is the ratio of the breaking stress to the working stress. When an architect designs a building he not only specifies that the material shall be strong enough to withstand

<sup>1</sup>The writer is much indebted to an article by Professor W. A. Rogers, of Cambridge (U. S.) Observatory, published in the U. S. NAVAL INSTITUTE PROCEEDINGS in 1881, and to officers at the Naval Observatory for their help in supplying data for this article.

the probable strain, but as a factor of safety adds to this strength of the material so that it will be able to withstand a greater strain than to which the structure is ever likely to be subjected. As a result of theory and experiment, empirical formulas have been established by which we can approximately ascertain the breaking load of a beam of certain dimensions and known material; but to cover all possible differences that may exist in different beams, to meet all unforeseen emergencies and to allow for changes that time and age inevitably bring, a factor of safety is added to the result obtained by the formula.

A similar procedure is not generally used by navigators. As a rule, the greater is his experience the more confidence he has in own powers and the less is he inclined to follow rules of safety. Professor Rogers, of Cambridge Observatory, stated, as a result of his investigation, "If I were asked to name the one cause which, next to positive negligence, produce the largest number of wrecks, I should say, over-confidence." This is natural. A successful seaman must rely upon his judgment and it inevitably follows, as a result of many years of varied experience, he becomes convinced that his judgment is rarely in error. We all remember navigators in the navy whose only interest, apparently, in the navigation results of junior officers was an opportunity to make a sarcastic remark or get material for a good story. Also, we always see the divergence of opinion of navigators as expressed by the different ships' "position report" in the fleet.

It has been found in every field of investigation that average error multiplied by 3.5 should cover not only the range of error which is likely to occur but also practically all extreme cases in which a combination of errors acting in the same direction may produce errors of such magnitude that even the most prudent investigator would fail to suspect. This may appear to be a bold statement. However, the writer has examined many records of data and the results all support the contention. Before passing on to our subject of finding the approximate limits within which, under ordinary circumstances, the position of a vessel can be located at sea, a graphic chart is presented of the plotted fall of shot that may be expected from the firing of 100 shots from a field gun, using the same range and deflection for all shots, to illustrate the application of the factor 3.5 in the law of dispersion.

DEFLECTION.

MEAN POINT.

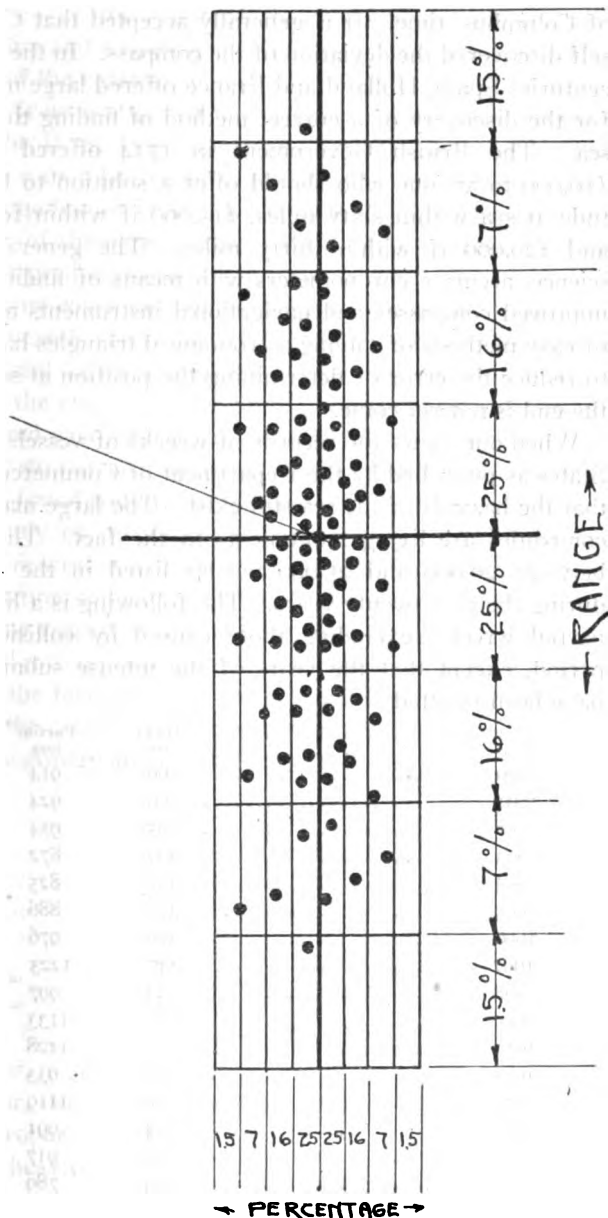



Interest in the accuracy of navigation at sea has steadily increased with the march of time since the voyages of the great navigators of Columbus' time. It is generally accepted that Columbus himself discovered the deviation of the compass. In the 16th and 17th centuries Spain, Holland and France offered large money rewards for the discovery of a correct method of finding the longitude at sea. The British Government in 1714 offered a reward of £10,000 to anyone who should offer a solution to find the longitude at sea within sixty miles, £15,000 if within forty-five miles and £20,000 if within thirty miles. The general progress of science, accurate chronometers with means of finding their error, improved compasses and navigational instruments and the advent of easy methods of solving astronomical triangles have done much to reduce the error of determining the position at sea. However, the end is not yet come.

When one views the records of wrecks of vessels of the United States as published by the Department of Commerce, it is realized that the hazards of the sea still exist. The large marine insurance companies are living monuments to the fact. There have been between 20,000 and 25,000 vessels listed in the United States during the past twenty years. The following is a list of total and partial wrecks, excluding those caused by collision during the period, except that the years of the intense submarine warfare have been omitted.

Year	Total loss	Partial loss	Total
1900	360	914	1274
1901	366	924	1290
1902	405	954	1359
1903	332	872	1204
1904	357	825	1182
1905	323	886	1149
1906	350	976	1326
1907	447	1223	1670
1908	344	997	1341
1909	282	1133	1415
1910	365	1128	1493
1911	294	933	1227
1912	328	1119	1447
1913	274	991	1265
1914	293	917	1210
1915	289	789	1188
1916	317	823	1140
1919	303	335	638

It is very hard to draw any conclusions from such a list as the casualties sprang from so many causes. The principal causes of the total losses, in the order of their occurrence are stranding, foundering, fire and abandoning. Of these, stranding covers about 60 per cent of the cases.

However, from a study of the reports of the British Board of Trade and the U. S. Department of Commerce a general résumé of information may be drawn as follows :

(1) The number of vessels wrecked is largely dependent upon the character of the cargo ; coal, grain, brick and stone, and vessels in ballast predominating.

(2) As many casualties occur in good weather as in bad.

(3) New vessels predominate over old ones in wrecks.

(4) The total losses are about proportional to the number of vessels, with the exception that the proportion of vessels wrecked that are insured vastly exceed those uninsured.

(5) About 50 per cent of those coming within the jurisdiction of courts are found to be from the preventable causes.

From a study of insurance statistics the writer is firmly convinced that the wrecks in 1907 were caused by "hard times" and wilful destruction of heavily insured vessels and that the harvest of money being reaped by shipping in 1914-15, with every available vessel pressed into service, accounted for the comparative decrease of wrecks in the face of an increased number of vessels employed.

However, the causes of wrecks with which this paper deals are classed by the American and British as follows :

#### AMERICAN

Error of judgment.

Error of pilot.

Neglect of master.

Ignorance.

Carelessness.

#### BRITISH

Error, neglect or incompetence of man or mate.

Error, neglect or incompetence of pilots.

Improper stowage.

Not heaving lead.

It will be seen they are strangely alike. The one item of neglect enumerated by the British classification—not heaving lead—is the source of fully one-fifth the findings of culpability in the case of grounding.

From a study of groundings in the navy, the first cause is from not giving due weight to carefully kept dead reckoning or lack of dead reckoning. Courts of inquiry in many cases show that working back from the point of grounding to the last previous fix, making due allowance for current, the ship was within one-quarter of a mile of her dead reckoning position when she struck; and I think, it will be conceded, that in thick weather, with danger on one side and sea room on the other side, one-quarter of a mile is too close a margin of safety. Many most careful navigators regard within a mile as “exact” position for a ship out of sight of land. Neglect of lead comes second, mistaking aids to navigation, land marks or tangents to headlands or islands, third; and uncharted or incorrectly charted coasts, dangers or aids to navigation, fourth. More than one cause generally existed.

Having considered some of the causes of error that may be wholly or partly avoidable let us now turn to some of the unavoidable sources of error. They are:

- (a) Personal error.
- (b) Chronometer error.
- (c) Compass errors.
- (d) Other instrumental errors.
- (e) Dip and refraction errors.

The personal error may creep in in many ways. It may vary from one side to the other or it may generally be constant on one side. These errors may include an inaccurate valuation of the index error, an error of making the contact without the middle of the telescope, an error of the contact itself, an error of marking time and a slight error of reading off the arc of altitude, an error caused by the rolling of the ship and an error of noting the correct chronometer correction. The error of marking time will include the error of calling “mark” and the error of actually reading the time. No one can pretend that time will ever be noted closer than one second at sea from watches or chronometers. If an error of one second be multiplied by 3.5 an error of nearly a mile will result.

The chances for chronometer errors have largely decreased with the advent of wireless for getting a "tick" at frequent intervals but still we have to depend on chronometers and the daily rate has still to be reckoned with. Handling of chronometers, gun fire, motion of the ship at sea, changes of temperature, thickening of oil or the balance acquiring a magnetic polarity may cause a sudden change in the rate since the last "tick."

It is doubtful if the chronometers of to-day are any more reliable than they were forty or fifty years ago. The price of hand labor of the greatest skill has become prohibitive and recourse is largely had to machinery in the manufacture of chronometers. Professor Rogers tabulated the chronometer records of several astronomical expeditions between 1850 and 1881 and the results to be got from them is a mean daily error of  $\pm .41$  and dividing that into the range between the greatest and least daily variation  $\pm 1.434$  we have exactly 3.5 as a coefficient of safety. From an examination of recent chronometer records covering a period of 11 years and 6 months and throwing out all chronometers that had a mean daily rate of over two, an average of  $\pm .79$  is found, with a range between the greatest and least daily rate of this class of good chronometers of 2.66. In this case  $\frac{2.66}{.79} = 3.37$  as a coefficient, which is slightly lower on account of having discarded the chronometers with a larger mean daily rate than 2.0. At the Naval Observatory an effort is made to never send out a chronometer with a daily rate greater than 3 seconds. However, more weight is attached to the uniformity of rate than to the rate itself.

The gyro-compass has almost displaced the magnetic compass for general use on board navy ships. The causes of the error in the gyro-compass are not as well understood as those of the older compass, consequently, the magnetic compass has been largely relegated to the place of "check" on the gyro. The causes of deviations in a magnetic compass and the character and degree of their change is so well understood that no comment is necessary here. As both compasses are checked by observations it follows that the error assigned depends on the accuracy of observations. Assuming that they are correct within one-half of a degree there remains to be determined the error of steering. Helmsmen are

generally permanently assigned to that duty. If a check is made, using a gyro-repeater in the chart house or central station, at frequent stated intervals of time it will be surprising to find that each helmsman has a mean error that does not vary greatly for the same course and state of weather. The writer has performed this experiment but the figures are not conclusive as they vary for each man both in regard to his length of experience and his attention to duty. Even with expert helmsmen a course made good is seldom steered within  $2^\circ$ . That is an error of about two-thirds of a mile in twenty miles. This may be called "leeway," "current," or bad steering, but it is generally present. The external causes of "leeway" and "current"—wind, waves and an actual current—have now, with faster vessels having motive power, only about one-third the effect that they formerly had with sailing ships averaging only one-third the slower speeds of to-day, *i. e.*, they are subjected to them only one-third the time.

Other instrumental errors are mostly included in sextant errors and pelorus and azimuth circle errors. All instruments have constant errors of eccentricity and graduation. In addition, sextants have errors due to slight inclinations of index and horizon glasses, telescope in a plane inclined to that of the instrument, surfaces of shade glasses not parallel to index glass, etc. The fore and aft line of the pelorus may not coincide with the fore and aft line of the ship, the sight vanes may be out of line, the roll of the vessel may cause the plane of the pelorus to be canted from the plane of the horizon, the reflecting mirrors may be slightly inclined and the sight radius—the distance between the front and rear sights—is so short and the sight marking so coarse that a large personal error may be caused. The necessary corrections are dealt with in Bowditch and almost every text book on navigation. The majority of errors are merely mentioned here to stress the liability to error from instrument causes. The errors vary for each instrument and the care taken of them by the officer charged with their care.

The largest errors in taking an altitude are likely to occur from "dip" and "refraction." Due to the difference in trim and the rise and fall of the ship the height of the eye may vary and the tabulated dip itself is for a mean condition of atmosphere. The greatest variations are to be expected when the temperature of the

air and water differ materially, as, for instance, altitude observed while in the Gulf Stream in cold weather. The apparent horizon is depressed below or elevated above its mean positions according to whether the sea is warmer or colder than the air. The tabulated refraction also becomes more uncertain when the altitude of the body is low. A mirage is a common phenomenon caused by refraction. A high position of the eye will tend to diminish the dip error.

From above it will be seen that it is very difficult to obtain data from which to assign a mean error of observation with the sextant at sea. Even the results of a series of observations are subject to the objection that they are compared with the mean of the series and not with a fixed value. The writer kept a record of the positions of twelve destroyers reported at noon and 8.00 p. m. during a voyage from San Diego to Honolulu and back last spring in good weather. That only gave 12 vessels times 9 days times 2 = 216 reported positions. As a rule, a circle with a radius of five miles included all the positions after they had been corrected for formation, but occasionally it took a ten-mile radius to include the one farthest away from the mean.

No better data are available than two examples collected by Professor Rogers in his investigation of the errors of observations as follows:

Scattered through the volumes of the *Nautical Magazine* will be found records of the determinations of the longitude of various stations, chiefly in the West India Islands, made by various British naval expeditions. The data required are in many cases wanting, but sufficient are available to furnish a fair estimate of the average range of error. The chronometers employed were rated at the Greenwich Observatory at the beginning of the voyage, and the observations for time at the terminal stations were made in the usual way with the sextant. They were probably made on shore, though I can find no definite statement to this effect. Evidently more than usual care was taken with the observations and reductions. It is probable also that a sufficient number of observations were made at each station to eliminate accidental errors in a large measure.

Place of observation	Range between results given by different chron'rs.	Range between results for longitude	Number of chron'rs.	Number of days duration of voyage
	<i>Miles</i>	<i>Miles</i>		
Funchal .....	2.0	1.5	10	11
Teneriffe .....	0.2	0.9	11	3
Port Prayo .....	3.2	1.3	11	10
St. Antonio .....	9.0	2.6	11	18
Cape Blanco .....	2.2	2.0	6	3
Cape Bojada .....	1.8	3.3	7	5
Goree Island .....	.....	2.6	..	..
Great Cayman .....	1.5	1.7	3	7
Cape St. Antonio .....	0.6	2.3	3	7
St. Salvador .....	9.5	18.8	6	6
Martinique .....	0.8	1.4	3	2
New Providence .....	3.2	6.1	6	15
Guadaloupe .....	.....	2.2	..	..
St. Martin's .....	.....	4.3	..	..
Alta Vela .....	.....	2.5	..	..
Trinidad .....	.....	3.7	..	..
Barbadoes .....	5.3	4.9	5	13
Navassa Island .....	0.8	1.6	3	6
Island de Aves .....	.....	7.5	..	..
New Orleans .....	.....	2.2	..	..
Chagres .....	1.6	2.0	2	15
Carthagena .....	4.0	1.7	2	3
St. Martha .....	2.2	8.3	2	6
Curacoa .....	.....	2.7	..	..
La Guayra .....	.....	3.8	..	..
Archilla .....	.....	2.4	..	..
Margaritta .....	.....	7.1	..	..
Port Desire .....	7.5	1.2	7	19
Port Farrin .....	7.2	.....	10	19
Callao .....	.....	7.4	..	..
Valparaiso .....	6.0	1.4	13	17
Talcahuana .....	1.5	3.8	4	15
San Carlos .....	15.1	31.6	20	27
San Carlos .....	6.8	10.9	18	12
Panama .....	.....	3.3	..	..
Guayquil .....	.....	7.6	..	..
For 36 stations { Mean .....	4.2	5.0	..	11
{ Range .....	14.9	30.7	..	..
{ Coefficient .....	3.5	6.1	..	..

During the spring and summer of 1880 Officer W. H. Bacon, of the Cunard steamer *Scythia*, kindly undertook for me a series of systematic observations from which the relative errors could be determined with considerable certainty. A complete series for a single day consisted of five sights at intervals of fifteen minutes, about eight o'clock in the morning, five sights in the neighborhood of eleven o'clock, and five sights at the corresponding hours in the afternoon. Observations were also made when the ship was in known positions as often as possible.

This series of observations has an exceptional value on account of the conscientious fidelity with which the programme was adhered to and of the skill with which they were made. The relative errors were determined by comparing each position with the mean of the series, the rate being determined both from the morning and afternoon observations and from the log.

The results obtained are found in the following table:

Limits in miles	Average error from observations at 9h and 3h	Average error from log at 9h and 3h	Average error from observations at 11h and 1h	Average error from log at 11h and 3h	Difference between observation and log at 9h and 3h	Difference between observation and log at 11h and 1h
	No. cases	No. cases	No. cases	No. cases	No. cases	No. cases
0.0...0.5	1	0	0	0	7	6
0.5...1.0	0	6	2	3	1	2
1.0...1.5	8	13	3	5	3	3
1.5...2.0	4	5	3	3	3	2
2.0...2.5	6	4	6	5	2	3
2.5...3.0	2	1	3	4	1	0
3.0...3.5	2	2	6	5	7	2
3.5...4.0	4	1	4	5	1	2
4.0...5.0	1	3	6	5	4	4
5.0...6.0	0	0	2	1	1	5
6.0...7.0	0	0	2	1	2	2
7.0...8.0	1	1	0	1	1	1
8.0...9.0	2	0	1	1	0	2
9.0...10.0	0	1	0	0	1	2
10.0...11.0	0	0	0	0	1	1
11.0...12.0	0	0	0	0	2	1
12.0+....	1	1	0	0	0	0

From whatever angle we approach with investigation it appears that under normal conditions the mean error of a position at sea is about three (3) miles. Therefore, *when approaching land from sea, we should always allow  $3 \times 3.5$ , or 10.5, as the radius of a circle within which the vessel may be and is reasonably certain to be.* This rule only holds good for a comparatively recent astronomical fix.

The writer's further conclusions as to the accuracy that may be best hoped for in navigation are:

- (1) To log within  $1/20$  of the correct distance.
- (2) To steer within  $2^\circ$  or  $1/30$  of the distance run.



- (3) To arrive by sextant within 1.5 miles of the correct spot.
- (4) To "cut in" position (except in constricted waters) within .5 of a mile of correct position.

However, no one man has the opportunity in a lifetime of acquiring an experience that will cover all eventualities. The writer hopes that the small amount of data here collected will cause some navigator to remember to :

- (a) Always keep an open mind.
- (b) Make use of soundings as described by Sir William Thompson.
- (c) Keep accurate dead reckoning and give it due weight.
- (d) Check up the steering.
- (e) And, finally, apply the necessary factor of safety where nothing can be gained by "taking a chance."

[COPYRIGHTED]

U. S. NAVAL INSTITUTE, ANNAPOLIS, MD.

---

## NEW BALLISTIC CORRECTIONS

By ALAN S. HAWKESWORTH, F. R. S. A.

---

Five important corrections should enter into the calculation of any long trajectory pretending to accuracy, namely:

(1) The corrections of gravity for latitude, and for the varying altitude throughout the trajectory.

(2) The curvature of the earth; increasing the range and the altitude; and momentarily varying the direction of the gravitational attraction.

(3) The westerly drift, given to the projectile in its flight, by the rotation of the earth.

(4) The drift towards the equator; southward in the northern hemisphere; and northward in the southern; due to the projectile travelling on a great circle of the earth. And lastly:

(5) The alterations in the projectile's weight, and in the gravity coefficient, through the variations of centrifugal force by its flight.

The third, fourth, and fifth of these corrections have hitherto been unnoticed by ballisticians; and will be solved in this paper. As well as convenient solutions given for the first two corrections. To begin with the westerly drift.

When a projectile is fired in any direction; besides the forward motion so imparted, it has the rotational velocity of the point upon the earth from which it has been fired. Rising in the air, it passes through regions of much greater rotational velocity, yet retains that of its starting point.

And since all these rotational velocities are to the east, the net result is that the projectile drifts to the west. By an ever-increasing amount, in its ascent to the summit, and by an ever decreasing amount, in its descent therefrom, but ever to the west. So that the final striking point must fall due west of the point where it would otherwise have landed, had this drift not been acting, by the sum of all the drifts at the various altitudes passed through in the flight.

And when considerable heights have been reached, the resulting "westing" will be found to be quite important.

The factors entering into the solution of the problem are evidently the five following :

(a) The angular velocity of the earth in radians per second.

(b) The distance of each and every point upon the trajectory from the axis of rotation. Which, multiplied into the said angular velocity, will evidently give us

(c) The respective velocity in, say meters per second (or in feet per second), according to the units in which we have reckoned the distances from the axis of each and everyone of the said infinite number of points upon the trajectory. Which respective velocities must each, in turn, be "weighted," or multiplied by

(d) The infinitesimal time in seconds, spent at the altitude in question. This giving us the actual drift in meters (or feet) for the said altitude.

(e) Whereupon the integral summation of the two sets, for the ascending and descending branches, respectively, will give us the desired total drift.

Now, two simplifying considerations will greatly aid us. In the first place, if  $r$  meters be the radius of the earth at the given point on its surface, of latitude  $L$ . And  $y$  meters be the altitude of any point directly above it. While  $M$  radians per second is the eastward angular velocity of the earth's rotation. And  $a$  and  $b$  are the earth's equatorial and polar semi-diameters, respectively; whereupon  $\frac{b}{a} \tan L = \tan \phi$ ; and  $\frac{b^2}{a^2} \tan L = \tan \beta$ . So that  $\zeta$  being the inclination of the plumb line to the equatorial plane; we will have

$$\tan(\zeta - \beta) = \frac{\sin \beta \cos \phi}{29.48372208g - \cos \beta \cos \phi};$$

with  $g$  as the gravity coefficient in meters/sec.<sup>2</sup> at the point in question. Practically  $\zeta$  can be taken as  $\phi$ ; or as  $\frac{L + \phi}{2}$ . Then  $r \cdot M \cdot \cos \beta$  will be the eastward velocity, in meters per second, of the said point upon the earth's surface. While  $[r \cos \beta + y \cos \zeta]M$  meters per second will be that of the point  $y$  meters directly above it. So that their difference, the westwardly drift here, will be at the rate of  $y \cdot M \cdot \cos \zeta$  meters per second. And the radius of the earth has disappeared from our equation; the altitude  $y$  alone concerning us.

Then, in the second place, it is true that the latitudes, and hence also the velocities in meters per second, of each and every point upon the trajectory, will differ somewhat from each other. For even firing due east, or west, the horizontal projection of the trajectory, being a great circle of the earth, must bend increasingly southward, in the northern hemisphere, cutting the parallels of latitude and longitude in a sinusoid, as will be shown.

Nevertheless the summit is approximately the medial point, both in range and in time. And is, furthermore, the region in which the greater portion of the time is spent; and time is our most important factor. So it is evident that the latitude of the summit can be, very accurately, taken as the "weighted mean" latitude for the whole trajectory.

Next, the earth revolves once in 86164.09965 seconds, the sidereal day. This being chosen, rather than the more usual solar day, for the reason that the rotation in respect to the stars is absolute. While that in relation to the sun is complicated by the yearly revolution, so that the traced path is a trochoid. Hence, the angular velocity  $M$  is  $\frac{2\pi}{86164.09965} = .00007292106$  radians per second, or 15.041086 seconds of arc.

For the trajectory, therefore, whose summit is in latitude  $L$ , north, or south; at a height of  $Y$  meters. The drift for an elementary altitude of  $y$  meters will be  $(y \cdot M \cdot \cos \zeta \frac{dt}{dS})$  meters.

With  $\zeta$  as the inclination of the plumb line to the equatorial plane,  $M = .00007292106$  radians per second, and  $S = Y - y$  meters as the difference between the summit and the chosen altitude, falling which  $S$  meters distance a body would attain the velocity of

$\sqrt{2g(Y-y)}$  meters per second. So that  $\frac{dt}{dS} = \frac{1}{\sqrt{2g(Y-y)}}$  is the infinitesimal time spent by the projectile at the said elementary altitude  $y$ . Whereupon the integral for the entire trajectory will be

$$\begin{aligned} 2 \int_0^Y \frac{\cos \zeta M \cdot y \cdot dy}{\sqrt{2g(Y-y)}} &= \frac{\sqrt{2} \cos \zeta M}{\sqrt{g}} \int_0^Y \frac{y \cdot dy}{\sqrt{Y-y}} \\ &= \frac{\sqrt{2} \cos \zeta M}{\sqrt{g}} \left[ -\frac{4Y+2y}{3} \sqrt{Y-y} \right]_0^Y \\ &= -\frac{\sqrt{2} \cos \zeta M}{\sqrt{g}} \left[ \left( \frac{6Y}{3} \sqrt{0} \right) - \left( \frac{4Y}{3} \sqrt{Y} \right) \right] = \frac{4\sqrt{2} \cos \zeta M}{3\sqrt{g}} Y^{\frac{3}{2}}. \end{aligned}$$

So that, for the trajectory whose summit is  $Y$ , in latitude  $L$ , north, or south; with  $g_1$  as the "mean gravity" value (namely, the gravity for latitude  $L$ , minus .000020573 m./sec.<sup>2</sup>, as will be shown; and also used in determining  $\zeta$ ) the log of the westerly drift  $D$  will be

$$\log D = \log \cos \zeta + \frac{3}{2} \log Y - \frac{1}{2} \log g_1 + 4.1383073472.$$

For example, taking a 6-inch 53-caliber gun, firing a projectile of 105 pounds C of F. 65, with an initial velocity of 914.4018 m./sec., or 3000 ft./sec. At an elevation of 25° this will attain a summit of 3373.1168 meters. Hence, at Washington, in 38° 53' 20" north latitude, where gravity is 9.80113 m./sec.<sup>2</sup>, the westerly drift, at the end of its 19269.8445 meters range; with 9.79419 m./sec.<sup>2</sup> as the "mean gravity," will be 6.7216 meters, or 22.055 feet, due west. If the alterations in range, and the deflection, caused by this westerly drift, are required, then these are quite simply given by

$$\Delta X \text{ meters increase in range} = -D \sin \psi$$

and

$$\Delta z = \text{deflection to the right in meters} = -D \cos \psi,$$

wherein  $\psi$  is the azimuth angle of the line of fire. And for all practical purposes, the latitude  $L$  can be employed for  $\zeta$ , and the ordinary gravity coefficient for the "mean gravity," with but a minute error in the results.

The equation of the drift  $D$  can also be written

$$\frac{7272.644\sqrt{g}}{\cos \zeta} D = Y^{\frac{3}{2}}.$$

and its graph is thus a semi-cubical parabola, increasing as the cube of the square root of the altitude  $Y$ . So that, with high angle fire, it will reach important values. In the case of the 70-mile range gun, where the summit is say 17 miles, or 27,358 meters, the drift at Paris, in latitude 48° 50" north, will be 131.38535 meters west; adding this to the range, if fired westward. Had the firing been in the latitude of Washington, the westward drift would have been 155.2343 meters.

If the latter part of the trajectory falls below the point of fire, then such portion, having a negative altitude, drifts to the east by an amount that is only one-half of that given by the above equation, since it relates to but one branch of the trajectory. And thus the said easterly drift of this inferior part must be deducted from the westerly drift of the superior part, to obtain the final striking point.

Or, conversely, if the point of fall of a trajectory, with summit  $Y$  meters is  $y_1$  meters higher than the gun's muzzle, the westerly drift  $D$  will be that for  $Y$ , minus one-half that for  $y_1$ .

And quite similarly for bombs dropped from an aeroplane or dirigible, or objects falling down a mine shaft. The resulting easterly drift being one-half that given by the above equation written with negative altitude.

For example, a bomb dropped from an elevation of 2000 meters will have 1.5301 meters easterly drift. While a stone falling over the western lip of a very deep and vertical mine shaft, 5 feet wide, neglecting the gravitational attraction of the shaft walls, would strike the eastern wall 6080.78 feet below.

Conversely, in anti-aircraft firing, the westerly drift for a point upon the ascending branch.  $y_1$  meters from the ground, will be one-half that given by the equation, writing  $y_1$  for  $Y$ . Or, if the "burst" be upon the descending branch, beyond the summit  $Y$ , and  $y_1$  meters from the ground, then the westerly drift will be that for  $Y$ , minus one-half that for  $y_1$ .

Taking up next the southerly drift, in the northern hemisphere, of the projectile towards the equator, the horizontal projection, or "trace" of the trajectory on the earth must evidently lie on a great circle. Which, if developed upon the usual Mercator projection map, with rectangular parallels of latitude and longitude, will cut those parallels in a sinusoid; having the equator for its axis,  $2\pi a$  for its wave length, with  $a$  equalling the equatorial radius, and  $\frac{l}{a}$  for its amplitude, or distance of wave crest from the axis.

Take the origin directly beneath the crest, and let the tracing point  $l$  meters distant from the center of the generating circle lie on a diameter of that circle, whose center travels along the axis, said diameter making an angle  $\gamma$  with the axis.

Then the equation of the generated sinusoid will be  $x = a \cdot \text{Arc} \left( \frac{\pi}{2} - \gamma \right)$ , and  $y = l \sin \gamma$ , with  $\frac{dy}{dx} = -\frac{l}{a} \cos \gamma$  as the slope in which the parallel of latitude is cut, at the point whose coordinates are  $x$  and  $y$  meters. The longitude parallel being here cut at the complementary angle.

If our line of fire be due east, or west, in latitude  $L$ , then  $l$  will be the distance in meters along the surface of the earth of the said point from the equator, and is thus calculated.

The equatorial and polar semi-diameters are  $a=6,378,388$  meters, and  $b=6,356,909$  meters, respectively. Whence,  $\frac{b}{a} = .99663253$ , and  $\frac{b^2}{a^2} = .9932764$ . And  $\frac{b^2}{a^2} \tan L = \frac{b}{a} \tan \phi = \tan \beta$ , giving us  $\phi$  the eccentric angle for latitude  $L$ , and  $\beta$  the inclination of the earth's diameter there to the equatorial plane. Whereupon,  $r = a \cdot \cos \phi \sec \beta$  will be the earth's radius and  $\sqrt{a \cdot r} \arccos \beta = a \cdot \arccos \beta \sqrt{\frac{\cos \phi}{\cos \beta}}$  will give us the distance along the surface of the earth of the said point in latitude  $L$  from the equator.

If the line of fire be due east or west, take our given range as the first approximation to  $x_1$ , the coordinate of the point of fall. Whereupon  $\frac{x_1}{a} = \arccos \left( \frac{\pi}{2} - \gamma_1 \right)$  will define  $\gamma_1$ , and  $y_1 = l \sin \gamma_1$  will give us an approximate value for  $y_1$ , which subtracted from the initial  $l$  will give us our first approximation to the southerly drift.

If, however, our line of fire is at some angle  $\delta$  with the east and west direction, then take our first approximate  $x_1$  as the component (range  $\cdot \cos \delta$ ). Whereupon  $\tan \delta = \frac{dy}{dx}$  for our starting point being known, and also  $y$  the calculated distance of that point from the equator,

$$\frac{y}{dx} = - \frac{l \sin \gamma_0}{a \cos \gamma_0} = -a \tan \gamma_0$$

determines for us  $\gamma_0$  at the origin. And this origin lies in the direction of fire if  $\frac{dy}{dx}$  be positive, but in the opposite direction if  $\frac{dy}{dx}$  be negative. And at a distance of  $\arccos \left( \frac{\pi}{2} - \gamma_0 \right)$  along the equatorial axis. While the crest of the sinusoid will lie above the origin, with amplitude

$$l = \frac{y}{\sin \gamma_0} = \frac{-a}{\cos \gamma_0} \frac{dy}{dx}$$

If the given slope  $\frac{dy}{dx}$  be positive; then  $x_1 = (\text{Range} \cdot \cos \delta)$  is subtracted from  $a \cdot \cos \left( \frac{\pi}{2} - \gamma_0 \right)$ ; or, if the given slope be negative,

it is added thereto, to obtain the first approximation to the drift abscissa. Dividing which by  $a$  will give us

$$\text{arc} \left( \frac{\pi}{2} - \gamma_0 \right) \pm \frac{x_1}{a} = \text{arc} \left( \frac{\pi}{2} - \gamma_1 \right).$$

Whereupon, as before,  $y = l \cos \gamma_1$ , gives us a first approximation to the drift ordinate.

But this is only a first approximation. For plainly the range must be measured along the arc of the sinusoid and not along its abscissa, and, for the small interval involved, the said sinusoidal arc may be considered equal to the circular arc, tangential to it at its extremities.

Write  $\delta_1$  for the angle of the given slope of the sinusoid at the firing point, and  $\delta_2$  for that of its just calculated slope at the point of fall. Whereupon the tangential arc will subtend the angle  $\delta_2 - \delta_1$ .

With fire due east or west, the radius of the tangential circle will be quite simply  $\frac{\text{range}}{\sin(\delta_2 - \delta_1)}$ . And its arc  $(\delta_2 - \delta_1) = \sin(\delta_2 - \delta_1)$  will determine for us a new angle  $\delta_3$ , somewhat smaller than  $\delta_2$ , which will be the slope  $\frac{dy}{dx}$  at the extremity of the sinusoidal arc which equals the range, and  $\frac{dy}{dx} = \frac{l}{a} \cos \gamma_3$  determines the final and corrected value  $y_1 = l \sin \gamma_3$  for the true ordinate of the drift.

Yet inasmuch as the sinusoidal function is here dealing with very minute angular values, but huge  $y$  values, it is somewhat more satisfactory to employ the tangential circle to evaluate the drift.

Whereupon  $\frac{\text{range}}{\sin(\delta_2 - \delta_1)}$  versine  $(\delta_2 - \delta_1)$  will give us the southerly drift for the stated range.

But if the line of fire be inclined to the east and west line at some angle  $\delta_1$ , then some quantity  $P$ , added to the range, will make a total equal to  $\tan(\delta_2 - \delta_1)$  of the tangential circle. And  $x_1$  being our first approximation to the sinusoidal abscissa of the point of fall.

$$x_1 \left[ \tan \left( \delta_1 + \frac{\delta_2 - \delta_1}{2} \right) - \tan \delta_1 \right] \frac{\cos \delta_1}{\cos(\delta_2 - \delta_1)} = P.$$

With which calculated value for  $P$  we can obtain

$$\frac{\text{Range}[\tan(\delta_2 - \delta_1)]}{\text{Range} + P} = \text{arc}(\delta_2 - \delta_1).$$



Determining for us the true slope  $\tan \delta_3 = \frac{dy}{dx}$  of the extremity of the sinusoidal arc that equals the given range. Whereupon  $-\frac{a}{l} \tan \delta_3 = \cos \gamma_3$  determines  $\gamma_3$ . Whence  $y_3 = l \sin \gamma_3$  gives us the true and final ordinate for our southerly drift.

For  $x_3 = a \cdot \arcsin\left(\frac{\pi}{2} - \gamma_3\right)$  is the abscissa of the point of fall. Subtracting from this the abscissa of the point of fire, and multiplying by  $\tan \delta_1$ , gives us the southerly component due to the direction of fire. Adding this to the calculated value for  $y_3$ , and subtracting that sum from the ordinate  $y$  of the point of fire, will give us the true southerly drift for the stated range and inclination of fire.

Or, employing the tangential circle for greater accuracy of computation, the southerly drift, for the stated range and inclination, will be equal

$$\frac{\text{Range} + P}{\tan(\delta_2 - \delta_1)} \sin\left(\frac{\delta_2 + \delta_1}{2}\right) 2 \sin\left(\frac{\delta_3 - \delta_1}{2}\right).$$

As an example, take Paris in latitude  $48^\circ 50'$  north. Where angle  $\phi$  is  $48^\circ 44' 15''$ , and angle  $\beta$  is  $48^\circ 38' 30''$ . While the semi-diameter of the earth at this point is 6366261.6 meters, and the distance  $y$  along the surface of the earth from the equator is 5,409,828 meters.

Were the gun with 70 miles or 112,651 meters range fired due west at Paris. The great circle sinusoid has now its crest  $l = y = 5,408,828$  meters from the axis. Its generating diameter travels  $1^\circ 00' 42.912''$ . So that  $\gamma_1$  is  $88^\circ 59' 17.088''$ . Making  $y_1 = l \cdot \sin \gamma_1 = 5408978.2$  meters. Hence the southerly drift for this 112,651 meters range is 846.182 meters, and the latitude parallel will be cut at the angle of  $0^\circ 51' 29.2212''$ .

Or, had the gun been fired in a southwesterly direction, at  $45^\circ = \delta_1$ . Then  $\frac{dy}{dx} = -1$ , and  $y_1 = 5,409,828$  meters, being both given, we will have  $-a \cdot \tan \gamma = -5,409,828$ , which defines  $\gamma$  as  $40^\circ 18' 10.5''$ . Therefore the origin of our sinusoid lies eastward 5532471.4 meters along the equator and the crest amplitude above it is  $l = 8363626.7$  meters. The given range's projection on the axis is 79656.32 meters so that the first approximation to the drift's

abscissa will be 5612127.72 meters, and the tangential circle subtends an arc of  $0^{\circ} 17' 58.6''$ , with a radius of 21639631.643 meters. The corrected subtended angle, with an arc of 112,651 meters, will therefore be  $0^{\circ} 17' 53.76''$ , and the true final southerly drift works out as 293.89 meters for this inclination and range.

Turning now to the alterations in the projectile's weight, and in the gravity coefficient, caused by its varying velocities while in flight.

For the westerly drift, the latitude and altitude of the summit were the sole considerations; caliber, velocities, and direction of fire being all indifferent. While, with the southerly drift, the direction of fire and length of range are the only data needed. But in the problem we are now going to consider the latitudes, altitudes, and direction of fire, and the projectile's weight and varying velocities and inclinations must all be considered.

Let  $\delta$  be the angle, measured counter-clockwise, that the horizontal projection of the trajectory makes with an east and west line. While  $\theta$  will be the inclination of the trajectory to that horizontal projection at any given altitude  $y$ . Angle  $\delta$  thus varying with the great circle sinusoid as has just been shown, and  $\theta$ , of course, differing at each point in the trajectory.

Let  $v_1$  be the momentary velocity of the projectile at the said point in the trajectory, whose altitude is  $y$ , in latitude  $L$ , north or south.

Then  $U = v_1 \cos \delta \cos \theta$  will be the easterly component of the said velocity. The case of a due north, or south direction of fire, and the northern or southern components of any line of fire, being taken care of by the latitude and altitude variations in gravity, yet to be considered.

Let  $V$  be the velocity of the earth's rotation, expressed in the same units as the other factor (say in meters per second), at the stated latitude  $L$ , and altitude  $y$ . And let  $R$  be the distance of the same point from the earth's axis.

If  $Q$  be the length in meters of a degree of longitude at latitude  $L$ . While  $M = .000072921$  radians per second is the angular velocity of the earth. And, as heretofore,  $a$  and  $b$  being the equatorial and polar semi-diameters;  $\frac{b^2}{a^2} \tan L = \frac{b}{a} \tan \phi = \tan \beta$ ; giving us  $\phi$  the eccentric angle for latitude  $L$ ; and  $\beta$  the inclination thereof of the earth's diameter to the equatorial plane.

While  $\tan(\zeta - \beta) = \frac{\sin \beta \cos \phi}{29.48372208g - \cos \beta \cos \phi}$  gives us  $\zeta$  the inclination of the plumb line to the quatorial plane; with  $g$  as the gravity coefficient in meters/sec.<sup>2</sup> at the point in question.

Then  $R$  will equal  $[a \cdot \cos \phi + y \cdot \cos \zeta] = \frac{180}{\pi} Q + y \cdot \cos \zeta$ . And  
 $V = MR = .000072921R = M \left[ \frac{180}{\pi} Q + y \cdot \cos \zeta \right] =$   
 $M[a \cdot \cos \phi + y \cdot \cos \zeta].$

Lastly, let  $g_1$  be the normal gravity coefficient at the stated latitude  $L$  and altitude  $y$ . And let  $g_2$  be the desired value, as influenced by the projectile's motion. Similarly,  $W_1$  would be the projectile's weight, were it at rest at this point. While  $W_2$  will be the weight as the velocity component  $U$  acts upon it.

Then the difference between the centrifugal forces acting upon  $g_2$  and  $g_1$  will evidently be

$$\frac{(U+V)^2}{R} - \frac{V^2}{R} = \frac{U^2 + 2UV}{R}.$$

So that

$$g_2 = g_1 - \frac{U^2 + 2UV}{R}.$$

While since  $\frac{g_1}{g_2} = \frac{W_1}{W_2}$ , writing the above equation in the form

$$g_2 = g_1 \left[ 1 - \frac{U^2 + 2UV}{gR} \right],$$

gives us, similarly, as the weight equation

$$W_2 = W_1 \left[ 1 - \frac{U^2 + 2UV}{gR} \right] \text{ with } \frac{U^2 + 2UV}{gR}$$

as the ratio of decrease if  $U$  be positive, or of increase, if  $U$  be negative, and to the west.

If we write this proportionate increase, with  $U$  negative, as  $\frac{V^2 - (V-U)^2}{gR}$  it can readily be seen that, as  $U$  rises from zero,  $g_2$  and  $W_2$  will also increase in value; until they reach their maximum when  $U = V$ ; whereat their ratio of increase is  $\frac{V^2}{gR}$ . But as  $U$  increases beyond the value of  $V$ , the proportionate increase diminishes; until  $U = 2V$ ; at which point it disappears; and  $g_2$  and  $W_2$  have their "rest values"  $g_1$  and  $W_1$ . A further increase

of  $U$  beyond  $2V$  turns the ratio negative;  $g_2$  and  $W_2$  shrink; until at the westward  $U = \sqrt{gR + V^2} + V$  they will both vanish; and the projectile, without any weight, or gravitational attraction, would travel for ever around the earth as a satellite. While a further increase of  $-U$ , the westward component of  $v_1$ , beyond this value  $\sqrt{gR + V^2} + V$ , would cause the projectile to travel away from the earth in a spiral path.

Hence a westward and negative  $U$ , if it be greater than  $2V$ , will have the same effect in diminishing gravity and weight as any and all eastward and positive values of  $U$ ;  $(K+2)V = -U$  westward having precisely the same effect as  $K \cdot V = +U$  eastward. With which eastward and positive values  $g_2$  and  $W_2$  are ever diminished; until they vanish when  $U = \sqrt{gR + V^2} - V$ . At which eastward velocity the weightless and gravitationless projectile would become a satellite. And any rise of  $U$  beyond this critical value would cause the projectile, with negative weight, and negative gravity, to travel away from the earth in a spiral.

But note the problem we are now considering is solely the variations in gravity and weight, through the velocity component  $U$ , and not at all the question of the velocity at which the projectile would abandon the earth. For, were we dealing with this latter, the vertical component  $v_1 \sin \theta$  of the projectile's velocity in the trajectory, with inclination  $\theta$ , would be the most important factor; although it does not appear at all in the problem we have been considering. For obviously a projectile must continue to rise; so long as the said vertical component  $v_1 \sin \theta$  exceeds  $g_2$  the gravity coefficient, amended for latitude, altitude, and velocity. So that the projectile in which the stated  $v_1 \sin \theta$  were ever large enough would depart from our earth; irrespective of what value the component  $U$  might have.

At Washington, in latitude  $38^\circ 53' 20''$  north, the eccentric angle  $\phi$  is  $38^\circ 47' 40''$ ; and  $\beta$  the angle the earth's semi-diameter here makes with the equatorial plane, is  $38^\circ 42' 00''$ . So that a degree of longitude here measures 86765.6 meters =  $Q$ . Making the velocity of the earth's rotation 362.5 m./sec. While  $R$  the distance from the earth's axis is 4,971,313 meters. And  $g = 9.80113$  m./sec.<sup>2</sup>

Therefore the maximum gravity and weight will be when  $-U$  the westward component is 362.5 m./sec.; or 1189.3 ft./sec. When gravity and weight will both be increased .2697 per cent. Gravity

becoming  $9.82756345$  m./sec.<sup>2</sup> And a 2100-pound projectile weighing 2105.66 pounds.

On the other hand, an eastern velocity, whose component  $+U$  is 918.6 m./sec. or 2800 ft./sec., will diminish both  $g$  and weight by 3.09883 per cent. Gravity now being only  $9.49741$  m./sec.<sup>2</sup> And the 2100-pound projectile weighing but 2034.924. The critical values for component  $U$ , to give zero weight and gravity at Washington, will be 7352.13 m./sec. westward; or 6627.15 m./sec. eastward values which are respectively 20.28 and 18.28 times 362.5 m./sec., the velocity here of the earth.

In connection with this subject it is interesting to note that in the spring of 1909 the Russian Government placed a warship in the Black Sea at the disposal of a Professor Hecker; in order that he might experimentally determine the variations in gravity caused by a ship running due west. When it was found that the said variation, with the ship running "at a fair speed" was of the "order of .100 dyne."

If we take the "fair speed" as say 25 knots, or 12.87 m./sec. And the latitude of the experiment as  $43^\circ$  north; where gravity has the value of  $9.80435$  m./sec.<sup>2</sup> While  $R=4,672,235$  meters from the earth's axis. And  $V$  the velocity of rotation is 340.698 m./sec. Then, when running west at 25 knots, the gravity would be increased by .18415 dynes. While a 25-knot due easterly course would decrease it .19124 dynes.

Or, were the "fair speed" 15 knots; or 7.722 m./sec.; then this speed westward would add .11134 dynes; while on an easterly course it would subtract .11389 dynes.

Furthermore, if the warship were a destroyer of say 1100 tons, the westerly 25 knots would add 462.8 pounds to her weight; with corresponding increase of displacement and draft. While the same speed eastward would subtract 480.628 pounds from her weight; with consequent decreased displacement and draft.

Similarly, a battle cruiser of 43,000 tons, steaming 35 knots off the Virginia Capes in latitude  $38^\circ$  north. Running due west, the normal gravity of  $9.79937$  m./sec.<sup>2</sup> would be increased to  $9.801933$  m./sec.<sup>2</sup>; and the vessel's weight would rise to 43011.247652 tons; increasing her draft by .10044415 inches. While steaming due east 35 knots; gravity becomes  $9.7966777$  m./sec.<sup>2</sup>; and the weight and displacement fall to 42988.1862 tons; with .10548 inches less draft.

And quite similarly, one could calculate the differences in weight of an aeroplane or dirigible; due to its easterly component of speed.

In all the foregoing,  $g_1$  and  $W_1$ , the normal gravity coefficient and weight, are assumed to be those of the latitude and altitude in question. And while gravity tables true for various latitude and places are generally available; such is not the case for altitude corrections. In default of which tables we must assume that gravity decreases .000003086 m./sec.<sup>2</sup> for each meter in altitude. So that, for example, when gravity, at the sea level is 9.80113 m./sec.<sup>2</sup>; at 1000 meters above this, it will be 9.798044 m./sec.<sup>2</sup> And  $\frac{g_2 W_1}{g_1} = W_2$  will give us the corresponding weight corrections.

For use with the westerly drift, the mean gravity for the whole trajectory, whose summit of  $Y$  meters is in latitude  $L$ , can be obtained through the same integral whereby we solved the westerly drift itself.

For if .000003086y is the subtractive value for an elementary altitude of  $y$  meters. Weighting this by the infinitesimal time spent there  $\frac{dt}{dS} = \frac{1}{\sqrt{2g(Y-y)}}$ ; where  $S=Y-y$ . And dividing the integral summation by the time spent in reaching the summit; namely,  $\sqrt{\frac{2Y}{g}}$ , will give us the "mean subtractive value" for each branch; and thus also for the whole trajectory. Whereupon

$$\begin{aligned} \sqrt{\frac{g}{2Y}} \int_0^Y \frac{.000003086y \cdot dy}{\sqrt{2g(Y-y)}} &= \frac{.000001543}{\sqrt{Y}} \int_0^Y \frac{y \cdot dy}{\sqrt{Y-y}} \\ &= \frac{.000001543}{\sqrt{Y}} \left[ -\frac{4Y+2y}{3} \sqrt{Y-y} \right]_0^Y = .0000020573 Y \text{ meters/sec.}^2 \end{aligned}$$

as the amount to be subtracted from the sea level gravity value of the summit of altitude  $Y$  in latitude  $L$ ; since the said latitude, as we have shown, can best represent the mean latitude of the whole trajectory.

Nevertheless it is preferable not to employ this "mean gravity," except for the westerly drift. But to take the several gravitational values, corrected for latitude and altitude; and similarly for the weight values; at each step in a small arc computation of the trajectory. Since in this way we duly allow for the otherwise neglected north or south components of the varying velocities throughout the trajectory.

This answers the proposed first ballistic correction. While the second, for curvature of the earth, might be roughly approximated by taking the calculated range; finding what arc it subtends upon the earth's surface; with  $r = a \cdot \cos \phi \sec \beta$  as the earth's semi-diameter. And then multiplying the  $(\sec - 1)$  of the said arc by the cotangent of the angle of fall. And adding the result to the calculated range.

Yet this is faulty; inasmuch as the curvature affects, not only the range and altitude of the summit; adding to both; but also alters, at each instant in the trajectory, the gravitational direction. So that the only adequate treatment is to use a small arc computation; say Moulton's method; and take the required correction, at each step, in the second differentials of range and altitude; which represent the momentary retardations. With the Moulton method the respective corrections will be,

$$x'' = Fx' + g_2 \frac{X}{r}. \quad \text{And } y'' = Fy' + g_2 - g_2 \frac{2Y}{r},$$

Wherein  $r$  is the semi-diameter of the earth at the point in question; and  $g_2$  is the gravity coefficient, corrected for latitude, altitude, and velocity. While  $X$  is the horizontal, and  $Y$  the vertical coordinates, in meters, of the stated point;  $x'$ ,  $x''$ ,  $y'$ , and  $y''$  the first and second differentials; and  $F$  the retardation function.

And indeed this introduction of the differential corrections at each step in a small arc computation is not only the best way to allow for earth curvature; and for latitude and altitude variations in gravity; but it is also the only possible way whereby we can take any account of the changes in gravity and weight through the centrifugal forces set up by the projectile's velocity. Since the retardations of that velocity have not, as yet, been expressed in an accurate law. Our only guidance, up to the present, being empirical formulæ and tables; which do not pretend to give us a mathematical equation for our varying velocities, that we could integrate.

Hence, when we wish to compute a long trajectory; it is best to employ a small arc method, say Moulton's; and to proceed as follows:

First, lay off a graph of the sinusoidal great circle trace of our trajectory; calculated for say 1000-meter intervals; up to, and beyond the roughly guessed at point of fall. Interpolation will then conveniently give us both the varying latitudes, and the  $\delta$

inclinations to the east and west line, at each step throughout the trajectory.

Or a simple table should be easily computed ; giving the southerly drift and slope for a series of ranges and initial inclinations.

Then, computing at say half-second intervals, correct gravity and weight at each point, for latitude, altitude, and the velocity component  $U$ . And employ these corrected values for the second differentials of retardation; the earth curvature; and the amended ballistic coefficient at this step.

Finally, when the whole trajectory has thus been computed, step by step, evaluate the westerly drift; using the "mean gravity" value. Since this is an effect totally independent of all the other factors in our problem.

As an example, take the 16-inch 45-caliber naval gun; initial velocity 2600 ft./sec.; weight of projectile 2100 pounds;  $C$  of F. 7. At an  $8^\circ$  elevation the computed range, is 12992.608 meters; the summit 526.01 meters; the time of flight 20.707 seconds; and the drift to the right 94.664 meters.

At Indian Head, in latitude  $38^\circ 36'$  north; longitude  $77^\circ 11'$  west; the computed gravity coefficient is 9.80088 meters/sec.<sup>2</sup> And the azimuth angle of the line of fire is  $220^\circ$ . Hence the integral mean gravity for the stated  $8^\circ$  trajectory will be 9.8008236 meters/sec.<sup>2</sup> And the resultant westerly drift will be .414624 meters; or 1 foot 4.324 inches. With a resultant gain in range of .2565 meters, or .2915 yards. And a deflection to the right, or positive deflection of .3176 meters, or .347 yards.

While at Dahlgren, in latitude  $38^\circ 30'$  north; longitude  $77^\circ 11' 40''$  west; computed gravity coefficient 9.8007927 meters/sec.<sup>2</sup>; and azimuth of fire  $120^\circ$ . The integral mean gravity, for the said  $8^\circ$  trajectory, will be 9.800618 meters/sec.<sup>2</sup>; the westerly drift .41605 meters, or 1 foot 4.38 inches. With a resultant loss in range of .208 meters, or .2275 yards. And a positive deflection to the right of .359 meters, or .393 yards.

The drift to the south, through the trajectory tracing a great circle of the earth, will be negligible, both at Indian Head and at Dahlgren. Not merely because of the shortness of range, but also because it is so steeply inclined to the south, in both cases.

But the alterations in the projectile's weight, through the easterly components of its varying velocities, will be quite important. Giving us an increased range, at Indian Head, of 9.616 meters, or



10.516 yards. While at Dahlgren there will be a corresponding loss in range of 54.0686 meters, or 59.23 yards. A difference of 63.685 meters, or 69.75 yards, in favor of Indian Head.

## NOTES

(1) Proof by differentiation of the integration :

$$\begin{aligned} \frac{d}{dy} \left[ -\frac{4Y+2y}{3} \sqrt{Y-y} \right] &= \frac{d}{dy} \left[ -\frac{4}{3}Y\sqrt{Y-y} - \frac{2}{3}y\sqrt{Y-y} \right] \\ &= - \left[ \frac{\frac{4}{3}Y(-1)}{\sqrt{Y-y}} + \frac{\frac{2}{3}y(-1)}{\sqrt{Y-y}} + \frac{2}{3}\sqrt{Y-y} \right] dy \\ &= - \frac{\frac{2}{3} \left\{ Y-y - Y - \frac{y}{2} \right\}}{\sqrt{Y-y}} dy = + \frac{y}{\sqrt{Y-y}} dy. \end{aligned}$$

(2) Taking the earth as an ellipsoid of revolution, whose generating ellipse has its semi-major axis  $a=6,378,388$  meters, and its semi-minor axis  $b=6,356,909$  meters, while  $O$  is its center. Let  $P$  be any point upon this ellipse, whose corresponding point  $p$  upon the major auxiliary circle is determined by the ordinate  $pPN$ , cutting the major axis in  $N$ . Draw  $Op$  making angle  $pON=\phi$ . And  $OP$  making angle  $PON=\beta$ . By elementary theorems  $pN:PN=a:b$ . And the tangents at  $P$  and  $p$  concur on the major axis in  $T$ . Then  $TPN$  being  $L$  the latitude, and  $TpN=pON=\phi$ , we will have  $PN \tan L = pN \tan \phi$ . Or  $\tan \phi = \frac{PN}{pN} \tan L = \frac{b}{a} \tan L$ .

Similarly  $PN \cotan \beta = pN \cotan \phi$ . And  $\tan \beta = \frac{PN}{pN} \tan \phi = \frac{b}{a} \tan \phi = \frac{b^2}{a^2} \tan L$ .

(3) Take the same generating ellipse and points upon it. Let  $\zeta$  be the inclination of the plumb line at point  $P$  to the semi-major axis  $Oa$ . While  $r=PO \cos \beta=a \cos \phi$  is the distance of  $P$  from the semi-minor axis  $Ob$ . While  $W$  is the weight of the plumb line; and  $C$  is the centrifugal force at  $P$ . Then

$C \cos \beta$  is the component, along  $PO$ , of the  
centrifugal force at  $P$ .  
 $C \sin \beta$  is the component, perpendicular to  $PO$ , of the  
centrifugal force at  $P$ .  
 $W \cos (\zeta - \beta)$  is the component, along  $PO$ , of the  
plumb weight  $W$ .

$W \sin(\zeta - \beta)$  is the component, perpendicular to  $PO$ ,  
of the plumb weight  $W$ .

Then the centrifugal force  $C$  (acting perpendicularly to the minor axis, the axis of revolution), and the plumb weight  $W$  (inclined at the angle  $\zeta$  to the major axis), being balanced in equilibrium; we must have

$$W - C \cos \beta = W \cos(\zeta - \beta); \text{ and } W \sin(\zeta - \beta) = C \sin \beta.$$

Now the general formula for any centrifugal force  $C$ ; acting upon a weight  $W$  at a distance  $r$  from the axis of revolution, in time  $t$  seconds for one revolution; with  $g$  as the gravity coefficient; will be  $C = \frac{4\pi^2 W r}{g t^2}$ . For this earth 86164.09965 seconds, the sidereal day, is  $t$ ; while  $r = a \cos \phi$ .

So that

$$\begin{aligned} W &= \frac{(29.48372208g)C}{\cos \phi}. \text{ Whereupon } \tan(\zeta - \beta) = \frac{W \sin(\zeta - \beta)}{W \cos(\zeta - \beta)} \\ &= \frac{C \sin \beta}{W - C \cos \beta} = \frac{\sin \beta \cos \phi}{29.48372208g - \cos \beta \cos \phi}. \end{aligned}$$



[COPYRIGHTED]

U. S. NAVAL INSTITUTE, ANNAPOLIS, MD.

AN ANALYSIS AND DISCUSSION OF VARIOUS SYSTEMS OF PROMOTION IN THE NAVY, WITH OUTLINES OF A PROPOSED NEW SYSTEM OF TRANSFER FROM THE ACTIVE LIST

By REAR ADMIRAL B. C. BRYAN, U. S. Navy

For nearly 35 years after the close of the Civil War promotion in the navy was in order of seniority only, with an age limit of 62 years, or retirement after 40 years of service at the option of the President.

It was not within the range of human possibilities to expect all officers to keep up the highest interest in their profession, during this time, to fit themselves for grades that they either could not hope to reach or would reach only to retire without a chance to exercise the duties thereof; though it is to the lasting credit of the service that many able officers did keep up their interest in spite of the hopelessness of their position, and the writings of at least one of them, Captain A. T. Mahan, are recognized authority on naval strategy up to the present time.

The hard experience of this period made it evident that some drastic change was necessary and that some system must be established that would weed out the unfit and promise a flow of promotion to those who showed themselves deserving it, in order to keep up the general morale of the service.

Various schemes were proposed, but, in the end, the Personnel Act of March 3, 1899, was passed—whereby the old engineer corps was amalgamated with the line and voluntary retirement and “selecting out” were added to stimulate the flow of promotion.

Various changes were made in this system, usually tending to destroy its usefulness, and its provision in regard to selecting out was finally repealed in 1915.

The next act was that of August 29, 1916, which, with certain modifications, should give satisfactory results.

It is unknown how the numbers in the various grades as designated in these acts were arrived at, certainly in the Act of March 3, 1899, and subsequent amendments thereto, they were established

in some arbitrary manner. It is doubtful, in any case, whether a systematic analysis of the actual causes of vacancies occurring in a large number of officers has been made and the results so tabulated as to form a basis for approximating to a well-balanced list in all grades from the time of appointment to the Naval Academy up to time of retirement for age limit.

It is the object of Part I of this paper to advance a method by which this may be done, approximately at present, but with increased accuracy from time to time as years go by and a greater number of records become available for the necessary period.

The following principles have been advanced as expressing the underlying idea for a correct system of promotion:

- (a) Promote the majority by seniority.
- (b) Select up the small minority of exceptionally able men.
- (c) Select out those found deficient during the process of searching out those to be selected up.

An analysis of the Navy List for the last 22 years shows that selecting out will be unnecessary with proper age limits in the various grades of lieutenant commander, commander and captain.

There is an odium carried by the selecting out process for other than physical defects, that should not be imposed upon an officer unless absolutely necessary, and it should then be done by the action of a court martial or examining board.

The subject matter contained in this article will be arranged under four heads, as follows:

Part I.—Actual and Expected Promotions Under Various Conditions, as follows:

(A) Actual Promotion Under the Personnel Act from March 3, 1899, to January 1, 1915, the time its provisions were in force, with an extension by interpolation showing what would have happened had the same method been pursued up to 1922.

(B) Promotion that would have taken place during that time (1899 to 1922) by a system that provided for an age limit of 62 years only.

(C) Conditions as in (B) with an age limit of 64 years.

(X) Promotion that may be expected with an age limit of 64 years, and retirement in grade of lieutenant commander at 45 years, commander at 50 years and captain at 56 years as provided by present laws, when their provisions become active.

Part II.—Discussion of the Effect of the Selecting Out and Selecting Up Systems.

Part III.—Outlines of a Proposed New System.

Part IV.—Disposal of Age in Grade Retirements.

PART I.—ACTUAL AND EXPECTED PROMOTION UNDER VARIOUS CONDITIONS

(A) *Actual Promotions Under Personnel Act of March 3, 1899.*—The principal provisions in the Act of March 3, 1899, in regard to promotion after the amalgamation of the Old Engineer Corps are as follows:

The number of officers allowed in each grade was: Rear admirals, 18; captains, 70; commanders, 112; lieutenant commanders, 170; lieutenants, 300; and lieutenants (junior grade), and ensigns, 350; in all 1020.

NOTE.—By the Act of March 3, 1903, the number of lieutenant commanders was increased by 30, and lieutenants by 50 with “such total numbers of lieutenants (junior grade) and ensigns as may qualify for such grades under existing law and the provisions of this act.”

On January 1, 1916, there were 733 lieutenants (junior grade) and 454 ensigns, or a total of 1187 in those grades.

Officers in the grades of lieutenant commander, commander, and captain were allowed to apply officially for voluntary retirement and “when at the end of any fiscal year the average vacancies for the fiscal years subsequent to the passage of this act above the grade of commander have been less than 13, above the grade of lieutenant commander less than 20, above the grade of lieutenant less than 29, and above the grade of lieutenant (junior grade) less than 40, the President may in order of rank of the applicants, place a sufficient number on the retired list to cause the aforesaid vacancies for the fiscal year then being considered.”

When such vacancies were not voluntarily made, “plucking” was resorted to as follows:

The board shall then select, as soon as practicable after the first day of July, a sufficient number from the before-mentioned grades . . . to cause the average vacancies enumerated to Sec. 8 of this act, provided not more than five captains, four commanders, four lieutenant commanders and two lieutenants are so retired in any one year.

This “plucking” section of the act was repealed on March 3, 1915, and no voluntary or selected retirements were made after

June 30, 1914. It was, therefore, in operation for 16 periods embracing  $15\frac{1}{2}$  years. Under the provisions of this act the officers were distributed in the various grades as shown by Table I.

TABLE I

Grade	Total number		Per cent	
	In grade	In grade and above	In grade	In grade and above
Rear admiral .....	18	....	1.76	....
Captain .....	70	88	6.86	8.62
Commander .....	112	200	10.98	19.61
Lieutenant commander .....	170	370	16.67	36.28
Lieutenants .....	300	670	29.42	65.69
Lieutenants (J. G.) and ensigns...	350	1020	34.31	100.00
Total .....	1020			

The officer standing No. 1000 by the Navy List of July 1, 1899, was taken and his actual standing on the list on January 1, 1900, and each following year up to January 1, 1915 (end of operation of act) is recorded in line 3, Table II.

The data are accurate for these years, at the end of which time his position is found to be No. 331 on the list.

The officer standing No. 331 on the list in 1900 was then taken and his standing recorded for six more years in line 4. The standing from 1900 to 1906 is very irregular as during this time the provisions of the law were not properly carried out. This was corrected in 1905 by an unusual number of retirements and the figures are corrected to spread these equally over those years and are recorded in line *A* and are shown on the diagram (Fig. 1) in curve *A*, *A*, *A-A*. The final results are in no way altered by this correction.

From the actual standing of this officer by the Navy List of 1915 ( $15\frac{1}{2}$  years after graduation) a line is drawn (Fig. 1) taking the average number that must disappear from the commander's list (twenty) to the top of the commander's list (No. 200) and again from this point at the average yearly rate of disappearance of officers from the captain's list (thirteen) to the top of the list of captains (No. 88). These points show the extreme limit of the time of such officer reaching these grades, *A*, under the provisions of this act.

TABLE II

July 1, Jan. 1

	1899	1900	1901	1902	1903	1904	1905	1906	1907	1908	1909	1910	1911	1912	1913	1914	1915	1916	1917	1918	1919	1920	1921	1922
1. Navy register of.....																								
2. Years after graduation .....	0	1	2	3	4	5	6	7	8	9		10	11	12	13	14	15	16	17	18	19	20	21	22
3. Actual standing from registers. ....	1000	966	944	895	844	810	774	685	635	590	545	501	465	426	396	362	331	317*	306*	290*	275*	259*	240*	..
4. Extended for officer No. 331 on register of Jan. 1, 1900.																								
(A). Actual standing under Act, March 3, 1899. (Corrected for 1899-1906).	1000	975	926	877	829	781	733	685	635	590	545	501	465	426	396	362	331	306	281	256	231	206	182	..
5. Correction for voluntary and selected retirements.	+ 0	+ 9	+ 18	+ 23	+ 23	+ 25	+ 27	+ 28	+ 26	+ 116	+ 130	+ 147	+ 161	+ 178	+ 195	+ 217	+ 234	+ 234	+ 234	+ 234	+ 234	+ 234	+ 234	..
6. Natural standing age limit 62 yrs. (un-corrected for deaths and age voluntary and selected).	1000	975	942	908	867	835	801	770	721	706	675	648	626	604	591	579	565	551	540	524	509	493	474	..
7. Correction for deaths, voluntary and selected retirements.	0	0	0	1	3	4	5	6	7	10	11	15	22	28	32	34	38	42	47	51	51	55	55	..
8-7. Natural standing, corrected for deaths, voluntary and selected.	1000	975	942	907	864	831	796	764	724	696	664	633	604	576	559	545	527	509	493	473	458	438	419	..
9. Correction for reaching 62 yrs., voluntary and selected.	0	0	0	0	0	0	0	0	1	1	2	3	11	24	30	35	39	44	53	63	72	83	94	..
8-9 (II). Corrected natural standing, age 62 yrs.	1000	975	942	907	864	831	796	764	723	695	662	630	593	552	520	510	488	465	440	410	386	355	325	..
10. Retirements at 62 years, active list....	0	4	6	9	15	24	34	44	58	70	85	98	112	122	127	134	139	147	153	162	170	180	190	..
8+10. Standing without retirements for age.	1000	979	948	916	879	839	808	782	766	749	731	716	698	686	679	666	656	646	635	624	618	609	599	..
12. Correction for retirement 64 years. Voluntary and selected.	0	0	0	0	0	0	0	0	0	0	1	1	2	3	11	24	30	35	39	44	53	63	72	..
11-12. Natural standing age limit 64 yrs. (un-corrected for age retirements active).	1000	979	948	916	879	839	808	782	766	748	730	714	695	675	655	635	616	607	591	575	555	537	517	..
14. Correction for age retirements 64 yrs. Active list.	0	0	0	4	6	9	15	24	34	44	58	70	85	98	112	122	127	134	139	147	153	162	170	..
13-14 (C). Natural standing. Age limit 64 years.	1000	979	948	912	873	846	815	784	748	722	690	660	639	597	563	533	509	487	468	444	422	393	367	345
15. Corrected for retirements for age in grade (10 per year).	0	5	15	25	35	45	55	65	75	85	95	105	115	125	135	145	155	165	175	185	195	205	215	225
(C)-25 (X). Standing under present laws, with retirements for age in grade.	1000	974	933	887	838	801	760	719	673	637	595	555	514	472	428	388	354	322	293	259	227	188	152	120

\* Corrected for age limit of 62 years.



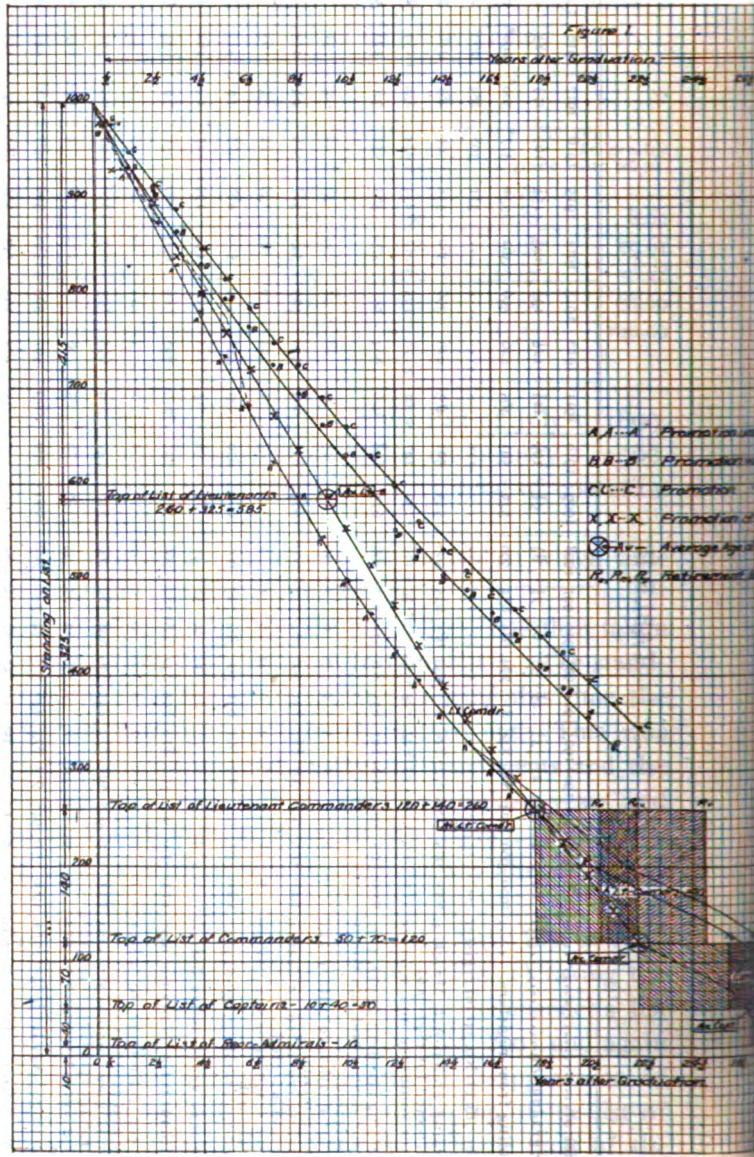

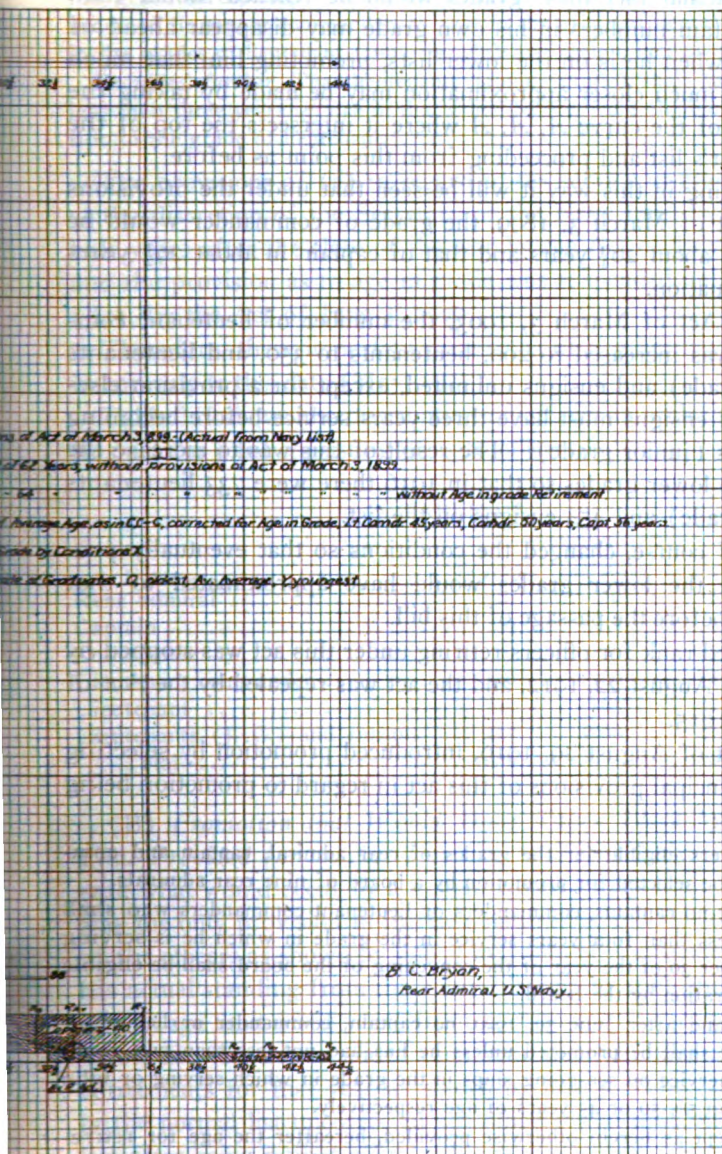

As an actual fact these grades would be reached sooner than this as certain numbers in his own grade may disappear ahead of an officer when he is on the lower lists, promoting him that much sooner—a much closer approximation may be made by taking the extension of the curve *A, A, A* where it intersects the top of the commander's list and proceeding from this point as before.

Proceeding in this way it will be seen that under the provisions of the Act of March 3, 1899, the grade of commander would be reached in about 20½ years and that of captain in about 29½ years after graduation.

By the Act of March 3, 1903, the number of lieutenant commanders was increased to 200, lieutenants to 350, and lieutenants (junior grade) and ensigns unlimited, except for a provision elsewhere that ensigns must have three years service before becoming lieutenants (junior grade). The result of this was to increase the lists in the lower grades so that in 1916 there were 733 lieutenants (junior grade) and 454 ensigns on the list.

This, of course, changed the conditions so that eventually promotion in the lower grades would have approximated to that obtaining before the passage of this bill.

Increased rank for officers retiring under this act was stopped by the Act of August 22, 1912, and the act was repealed by the Act of March 3, 1915.

The Act of August 29, 1916, introduced promotion by selecting up, the principal provisions of this act in regard to promotion being as follows:

(a) Officers eligible for the grades of rear admiral, captain and commander to be selected for promotion by a board of nine rear admirals.

(b) That no captains, commanders or lieutenant commanders who shall have had less than four years service in the grade in which he is serving on November 30 of the year of the convening of the board shall be eligible for consideration by the board.

(c) On and after June 30, 1920, no captain, commander or lieutenant commander shall be promoted unless he has had not less than two years actual sea service on sea-going ships in the grade in which serving or who is more than 56, 50 or 45 years of age respectively.

(d) Except as herein otherwise provided, hereafter the age for retirement of all officers of the navy shall be 64 years instead of 62 years as now prescribed by law.

(e) That the total number of commissioned line officers on the active list at any one time, exclusive of commissioned warrant officers, shall be

distributed in the proportion of one of the grade of rear admiral to four in the grade of captain, to seven in the grade of commander, to 14 in the grade of lieutenant commander, to 32½ in the grade of lieutenant, to 41½ in the grades of lieutenant (junior grade) and ensign, inclusive:

*Provided further*, That lieutenants (junior grade) shall have had not less than three years service in that grade before being eligible for promotion to the grade of lieutenant.

The provisions of (e) in regard to sea service in grade was put at the discretion of the Secretary of the Navy until two and one-half years after the close of the war by the Act of July 1, 1918—and the provision as to age in grade was suspended until June 30, 1921, by the Act of June 4, 1920.

Therefore, these important provisions of this act have not been in force up to this date (May, 1921).

Table III shows the distribution of officers in each grade under this act for a list consisting of 1000 officers.

TABLE III

Grade	Total number		Per cent	
	In grade	In grade and above	In grade	In grade and above
Rear admiral .....	10	10	1	1
Captain .....	40	50	4	5
Commander .....	70	120	7	12
Lieutenant commander .....	140	260	14	26
Lieutenant .....	325	585	32.5	58.5
Lieutenants (J. G.) and ensigns.....	415	1000	41.5	100
Total .....	1000		100	

(B) *Promotion that Would Have Taken Place by a System That Provided for an Age Limit of 62 Years Only.*—To investigate what would occur by a system where an age limit of 62 years was the only provision to increase natural promotion, the standing of the officers as shown by line A in Table II is extended by taking his actual standing from the Navy Lists up to 1921 and correcting for an age limit of 62 years from 1916 to 1921 as shown in line 3, Table II. To this is added each year the voluntary and selected retirements for that year as shown by line 5. The result, line 6, is the normal list uncorrected for officers who died on the retired list after being retired voluntarily or by selection. Subtracting the deaths as shown by line 7 we get line 8 which gives the normal list uncorrected for officers retired voluntarily or by selection who

reached the retiring age each year as shown by line 9. By subtracting line 9 from line 8 we have the actual standing that would have obtained had only an age limit of 62 years been provided—line (B) shown on Fig. 1 as curve B, BB-B.

(C) *Conditions as in (B), With an Age Limit of 64 Years.*—If we now take the figures in line 8 and add the accumulated number of retirements on the active list each year we arrive at the actual standing that would have taken place by natural retirements without any age limits whatever and obtain line 11.

Subtracting from this the accumulated number of officers retired voluntarily or by selection who reached the age of 64 years and then those on the active list who reached this age, we arrive at line C which shows the promotion each year by a law having an age limit of 64 years only provided. Shown on Fig. 1, as curve C, C, C-C.

Table IV is of interest as showing:

Column 1. What actually happened to the 1000 officers considered from 1899 to 1915, by the operations of the Act of March 3, 1899.

Column 2. What would have happened up to 1921 if the personnel act had not passed, with an age limit of 62 years.

Column 3. The same as Column 2 with an age limit of 64 years.

TABLE IV

SHOWING CASUALTIES, ETC., OF 1000 OFFICERS ON NAVY LIST JULY 1, 1899

	1	2	3
Resignations .....	42	43	43
Retirements—Age .....	139	284	242
Voluntary .....	164*	...	...
Selected .....	80	...	...
Other causes .....	138†	164	164
Deaths .....	105	173	173
Transferred to other branches of service.....	5‡	5	5
Dropped or dismissed.....	6	6	6
	<hr/>	<hr/>	<hr/>
Total casualties .....	669	675	633
	<hr/>	<hr/>	<hr/>
Remaining on list.....	331	325	367

\* 155 voluntary retirements—one returned to list by special act.

† 139 other causes—one returned to list by special act.

‡ 6 transferred to other branches—one returned to list by special act.

(X) *Promotion that May Be Expected with Age Limit of 64 Years and Retirement for Age in Grade as Now Provided by Law.*

—The average age of entrance to the Naval Academy for the last 20 years has been  $18\frac{1}{2}$  years. The average age at graduation  $22\frac{1}{2}$  years. It will therefore be necessary for the officer of average age to go through the lieutenant commander's grade in  $22\frac{1}{2}$  years with the age limit in this grade of 45 years as now fixed by law.

It will be seen from Table II and the curve C-C-C that out of each thousand graduates we may expect all but 345 to disappear from the list in  $22\frac{1}{2}$  years with an age limit of 64 years.

However, in  $22\frac{1}{2}$  years all but 120 must disappear, as there are only 120 officers above the grade of lieutenant commander, therefore, there must be  $345 - 120 = 225$  forced retirements, that is, 10 each year for each thousand officers.

The time allowed for such officer to go through the grade of commander is five years (from 45 to 50 years of age). There are 70 on this list for each 1000 on the total list, therefore 14 numbers must be made yearly for each 1000 officers on the total list.

It is unlikely that such officer will make this many natural numbers. The average number of retirements for 40 years service and age in the 1000 officers considered would have been about 12 per year, and casualties are few in so small a number as are now above him. It is therefore probable that retirements for age will have to take place in the grades of captain and commander.

It is well here to note the fact that the operations of the old Personnel Act of March 3, 1899, will affect the flow of promotion for a number of years and the list will not become entirely normal until somewhere about 1940.

For example, the Navy Register of January 1, 1921, shows that only 57 officers are due to reach 64 years of age in the next 10 years, but it must be remembered that 244 officers were retired voluntarily and by selection during the  $15\frac{1}{2}$  years the provisions of the Act of March 3, 1899, were in operation and to make the list normal many of these officers should be on the active list instead of the retired list now.

If this were the case, it would be found as follows:

#### RETIREMENTS AT 64 YEARS

Year	Officers now on active list	Officers who should be on active list	Total
1921 .....	8	11	19
1922 .....	11	14	25
1923 .....	2	7	9
1924 .....	6	7	13
1925 .....	5	6	6
1926 .....	3	3	12
1927 .....	6	6	9
1928 .....	8	1	10
1929 .....	2	8	10
1930 .....	6	4	10
	<hr/>	<hr/>	<hr/>
Total .....	57	67	124
	<hr/>	<hr/>	<hr/>
Average .....	5.7	6.7	12.4

It may be expected therefore that until the list becomes normal, the retirements for age in the grades of commander and captain will be abnormally large, and promotion in all grades will be slow and congested.

It should be noted also that, with an officer of average age, his failure of selection will almost surely result in his retirement for age in grade.

The principle of "selecting up," if properly and impartially conducted would insure the selection of the best officers and proper age limits in grade would give the necessary flow of promotion, without resorting to "selecting out"—which process should be taken care of by courts martial—and examining boards.

By subtracting 10 numbers each year for retirements for age in grade below the grade of commander from line (C) in Table II we get the results on line (X) showing the expected results by an age in grade limit of 45 years for lieutenant commanders.

From Table II or Fig. 1, it will be seen that the average yearly vacancies that may be expected at the bottom of the list of ensigns is about 44 for every thousand officers on the list.

For a navy of 5500 commissioned officers this would mean  $44 \times 5.5 = 242$  vacancies each year.

Since 1899, there have been 7657 appointments to the Naval Academy and of these 3581 or about 46.8 per cent have graduated.

Two hundred and forty-two graduates would mean an average entering class of  $\frac{242}{.468}$  or 511. This would probably mean an average of about 1400 midshipmen at the Naval Academy as follows:

4th class .....	511
3d class (70 per cent).....	358
2d class (55 per cent).....	282
1st class (50 per cent).....	250
	1401

The following would be the expectations of an appointee of the average age of 18½ years:

Graduation .....	4 years .....	Age 22½ years.
Lieutenant (J. G.).....	3 " .....	" 25½ " "
Lieutenant .....	6 " plus .....	" 31½ " plus.
Lieutenant commander..	9 " .....	" 40½ " plus.
Commander .....	4 " .....	" 44½ " plus.
Captain .....	5 " plus .....	" 50 " "

Fifty-five officers would be retired for age in grade each year in the grades of lieutenant commander, commander and captain.

PART II.—DISCUSSION OF THE "SELECTING OUT" AND "SELECTING UP" SYSTEMS OF PROMOTION

(a) *Selecting Out.*—The necessity for providing unusual means for "selecting out" the unfit in any system is an admission of weakness and inefficiency of organization.

No reflection is intended on any one in making this statement, but it is only reasonable to suppose that in an efficient organization run on firm and impartial business principles the unworthy or useless employees would be noted by their immediate superiors and weeded out by the means provided for that purpose, without the necessity of appointing special boards for the work.

In the case of the naval service the means provided for this purpose are fitness reports of commanding officers, examining and retiring boards and military courts.

With proper coordination, firmness and impartiality in the employment of these functions of organization the "weeding" would



be done without any necessity for special machinery to do the work and there would then be left only those of standard requirements from which to select the best for higher grades, in order to offer a reward for unusual talent and further to insure the necessary flow of promotion and prevent loss of ambition and lassitude due to stagnation.

We must admit our organization defective if the officers allowed to remain on the list passing from grade to grade are not up to a required standard.

Having made the admission that such officers are of standard quality it is unjust to throw them out and brand them as being of no further use.

The only good points in "selecting out" as practiced under the operation of the Personnel Act of March 3, 1899, were that it provided for promotion to prevent stagnation and that the "selected" left the service to nurse their grievances elsewhere in civil life. It is doubtful whether it was equitable to the government to lose the services of these officers who were, in general, healthy and capable, and whether some means of using their services should not have been provided. This will be discussed further on.

(b) "*Selecting Up*."—Supposing the service to be run on efficient business principles we have a list of officers certified at the time of their promotion to be up to the required standard for the duties of the grade they are to enter or, perhaps, since promotion, marked for disciplinary action for failure to keep up to that standard.

A point is reached where it becomes necessary, for the efficiency of the service to select those best fitted for the duties of command rank, that is, for grades above that of lieutenant commander.

This is a business proposition common to all large organizations and is the real gauge of efficiency of any organization. The same elements enter into the case both in civil life and in the naval service. Politics in the service (which may be classified with family relationship in outside life) and personal influence, are the most prominent evils to be eliminated, and an impartial selection of the most fit is necessary to efficiency and contentment.

In all organizations the evils above mentioned should be guarded against and entirely eliminated if possible. In civil life it may be expected that relatives or friends of the members of the firm are to receive unwarranted promotion especially if the business is of a

private character and not an incorporated body of stockholders, but in the government service each individual is supposed to stand on his own merit and it is not only his inherent right to know the cause of any denial of such standing but necessary for his self-respect and the best exercise of his faculties to feel that he is going to be treated with justice.

### PART III.—OUTLINES OF A PROPOSED SYSTEM OF PROMOTION

Since the year 1679, the right of a defendant to be present and confronted with the cause of his being held has been a well-recognized principle of English law, and it should be recognized as a fact that any system of procedure by which any individual is condemned without knowledge of the cause is contrary to the American idea of freedom and liberty.

It is evident that any board so constituted that it has the power to deprive an officer of his rightful standing on the active list of the navy without his having full knowledge of the reasons for such deprivation and without power to defend himself does not coincide with the American ideas of justice and in a military system it leads so sycophantly or servility in association with superior officers and crushes the personal initiative of the individual, a quality absolutely necessary for efficiency.

The Act of March 3, 1899, contained the following mandatory provision:

Its (the selection board's) finding, which shall be in writing, signed by all members, not less than four governing, shall be transmitted to the President, who shall thereupon, by order, make transfer of such officers to the retired list as are selected by the board. . . .

The Act of August 29, 1916, constituting the board for "selecting up" contains the following provisions as to the routine followed by the finding of the board:

The report of the board shall be submitted to the President for approval or disapproval. In case any officer or officers recommended by the board are not acceptable to the President, the board shall be informed of the name of such officer or officers, and shall recommend a number of officers equal to those found not acceptable to the President and if necessary shall be reconvened for that purpose.

An officer plucked or passed over takes no part in the proceedings in either case and he is not informed of the cause of his displacement nor given a chance to defend himself. All he knows or is

allowed to know by the present system is that he did not receive the votes of six members out of the nine composing the board.

It is contended that this method of procedure is not in line with American ideas of right or justice, and that an officer should have the right to know the cause of his displacement and be heard in defence before an impartial jury.

To attain this end the following system is proposed :

Instead of appointing one board as now provided by law, two to be appointed, which for the purpose of easy reference will be designated Board "A" and Board "B." Board "A" to be composed of three rear admirals on the active list of the highest rank available. Board "B" to consist of five or seven rear admirals on the active list of lower rank than those on Board "A."

Board "B" to meet, organize and be furnished with the number of vacancies and number of eligible officers as now prescribed by law.

This board is then to proceed as follows :

The list of eligible officers in any grade shall first be scanned for any officers who may have shown such unusual qualities as strategists, organizers or leaders as to warrant unusual advancement. No such officer to be more than two years in length of service junior to the senior officer on the eligible list of his grade. From such number of unusual officers the board may select the senior in each grade having the votes of all members of the board for unusual advancement, it being understood that such unusual qualities are exceptional and it is not obligatory to make such selections each year.

Not more than one such officer shall be promoted in any one year from any one grade and the board shall certify in writing that in the opinion of all of its members such officer warranted unusual promotion and his name will be placed at the top of the list of those selected for promotion that year in his grade.

The board shall then proceed to vote on the eligible officers in regular order of their seniority on the list and so proceed until a sufficient number have received a majority vote of the board to fill the list of vacancies remaining.

Should any eligible officer voted on fail to receive a favorable majority of votes, the officers voting in the negative will furnish the board their specific reasons for so voting, which shall be recorded by the board.

The names of all selected officers will then be forwarded to Board "A" with the records of all officers who have been voted upon by the board, and the reasons as recorded by Board "B" for passing over each officer displaced.

Board "A" will then notify all officers who have been passed over by a negative vote that their names have not been favorably considered, giving the specific reasons therefore as furnished by Board "B." Such officers will be notified that they will be given a specified (reasonable) time to make a statement or present evidence for the consideration of the board.

At the expiration of the time specified, Board "A" will consider the records of all officers passed over by Board "B" together with those who have been advanced ahead of them. Should a majority of Board "A" consider that the record of any officer together with the evidence he has produced warrants his advancement he shall be placed on the list of those selected in the regular order of his seniority but below any unusual selection made that year in his grade and the list shall be completed in this manner for transmission to the President as now required by law.

The usual rules of secrecy applicable to courts martial will apply to the proceedings of the boards:

Some of the advantages claimed for this system of promotion are as follows:

(a) A regular flow of promotion will obtain through retirement for age in grade without the humiliation of carrying through life the stigma, sometimes unjust, of being specially marked for incompetency.

(b) Only competent officers will reach the final higher grades.

(c) Provision is made for the promotion of the few especially gifted.

(d) An officer can feel that he will not be condemned in secret for some mysterious cause but must be accorded the rights of every freeborn citizen to hear the accusation against him and present his defence.

(e) An officer will be free to express his honest opinions and exercise his initiative, subject of course to Navy Regulations, without fear of hopelessly jeopardizing his future by antagonizing some superior who happens to be present.

## PART IV.—DISPOSITION OF OFFICERS REACHING THE MAXIMUM AGE IN GRADE

It will be noted that it is estimated that out of every thousand officers on the active list 10 may be expected to retire each year, for age in the grades of lieutenant commander, commander and captain. For a list of 5500 this would mean 55 such retirements each year.

When these officers are retired from the grades of lieutenant commander and commander at the ages of 45 and 50 years they will have 19 and 14 years, respectively, before they will reach the age now set as limiting their period of usefulness.

In a commercial business these men would probably be kept on in the job they were holding without promotion as long as their services justified it or would be demoted to an inferior position. That is, a firm would feel an obligation to provide in some way for a faithful employee who had been in their service from 22½ to 27½ years, and their services would be utilized in some way, if possible.

To utilize the remaining useful years of these officers the following method is proposed:

That there be constituted an additional class of the Naval Reserve Force known as Naval Reserve Force—Special. That these officers be transferred to the Naval Reserve Force in that class. That they receive a retainer pay of 2½ per cent of the base pay of their grade for each year of service up to 30 years. Service in the Reserve Force Special to count the same for all purposes as service in the regular navy.

That officers of the Naval Reserve Force Special shall be eligible for promotion to the rank of commander after 30 years total service and captain after 35 years total service under such regulations as may be prescribed by the Secretary of the Navy, and shall be transferred to the retired list of the navy at the age of 62 years with 75 per cent of the base pay of the grade they then hold.

That in time of peace officers of the Naval Reserve Force Special shall be eligible for duty on vessels of the naval auxiliary service, emergency fleet service, and such other special vessels of the government as the President may direct, and for such shore duty as may be directed by the Secretary of the Navy, provided that not over 15 per cent of the total number of such officers shall be employed on shore duty at any one time.

That officers of the Naval Reserve Force Special, shall, when on active duty, receive the same pay and allowances as received by officers of the active list of the navy of the same grade and length of service.

Some of the advantages claimed for this system are as follows:

(a) Under the provisions of the Act of March 3, 1899, and also under the provisions of the acts now in force when the temporary restriction on age limit in grade is removed, officers who are active and capable are placed on the retired list with 75 per cent of their active pay and their services are no longer utilized except in time of war. Under the proposed system they are transferred to the reserve list on a graded pay, well earned by their length of service and in general less than that of the retired list, and their services are utilized for very necessary duties, thereby reducing the amount paid by the government and giving a return for the money expended.

(b) Under the present system, with the restriction on age in grade retirement, officers passed over are condemned to remain stationary until they reach the extreme limit of age, doing duty under formed juniors, without any hope of advancement or incentive to exert themselves in the performance of their duties. Under the proposed system they are freed from such humiliation and given an incentive to exert their best efforts on very necessary duties for which they are well fitted and with different environment.

(c) These officers would be of inestimable value in time of war as they would be experienced and capable, having been continually in touch with the greater part of their naval duties, and in time of peace they would form an organization which has long been necessary, and for which the necessity is rapidly growing.

In conclusion, attention is called to the fact that the figures given are, of course, only approximations made from what forms about the only data available.

Table IV shows that out of the 633 officers who would have disappeared from the list of 1000 under a 64 years' age limit between July 1, 1899, and January 1, 1921, 579 or about 91 per cent were by retirements from age, retirements from other causes and deaths. Anyone of these causes may vary from time to time but a large variation in the total is unlikely as each has an influence on the others. Resignations, transfers and dismissals are of but

slight importance and have but little effect on promotion in the higher grades.

The system advanced would form, at least, a logical basis for calculations which may be corrected from time to time as experience suggests.

The list of officers considered contained many who had served during times when the service was not as strenuous as it is now and more may have reached advanced age than would be the case at present, however, against this may be set the facts that sanitary conditions are much better and the advance of medical science and the great attention paid to the morale of the service should prolong life and usefulness.

It may be taken for granted that for a number of years, in fact, not until about the year 1940, owing to rapid promotions in increasing the number of officers, and to the voluntary and selected retirements made under the personnel Act of 1899, the list will not become normal and a time of stagnation and retirement for age limit in the higher grades is at hand, which latter condition no system can avoid.

## DISCUSSION

---

### A New Method of Coastal Navigation

(SEE PAGE 723, WHOLE No. 219)

CAPTAIN J. V. CHASE, U. S. Navy.—The author clearly describes this new method of coastal navigation and deduces the trigonometrical formulæ necessary for the solution of the problem. The use of these formulæ, however, is a process too slow and laborious to make this method attractive. The general solution of the problem by use of tables previously prepared is not practicable as such tables would be too bulky for convenient use. Captain Edmonds of Australia has sought to overcome these difficulties by preparing a set of tables whose use is limited to the case where the first and third bearings make equal angles with the second bearing and the author suggests the advisability of preparing a set of tables whose use would be limited to the special case where the three bearings are taken at equal intervals of time.

It appears to me that recourse to either set of tables is both unnecessary and undesirable as the graphical solution of the general problem is both simple and easy and the accuracy of the results obtained by such a graphical solution is largely a matter of the scale adopted.

The graphical solution is especially easy if the navigator has at hand a universal drafting machine, that useful instrument which is rapidly becoming a part of the standard equipment of the modern chartboard. If such an instrument is not available its place must be taken by a compass rose or protractor, a pair of parallel rulers or a pair of triangles and a graduated scale.

Fig. 1 shows in full lines the general graphical solution. Fig. 2 shows in full lines the solution for the special case where the initial "fix" lies on the first bearing and the bearings are taken at equal intervals of time.

In Fig. 1,  $P$  represents the landmark, the bearings of which are observed and recorded.  $A$  represents the position of the ship at the time  $t_0$ .  $PD$ ,  $PE$ , and  $PF$  represent the bearings of  $P$  observed at the times  $t_1$ ,  $t_2$ , and  $t_3$  respectively.  $AG$  represents the steady course of the ship steered during the time interval  $(t_3-t_0)$ .  $B$  is the dead reckoning position of the ship at the time  $t_3$ .  $OM$  equals  $(t_2-t_1)$  to some convenient scale and  $ON$  equals  $(t_3-t_2)$  to the same scale. Draw the lines  $MD$  and  $NK$  parallel to  $PE$ . These lines intersect the first and third bearings in the points  $D$  and  $K$  respectively. Draw through  $A$  a line parallel to  $DK$ . This line is the course made good. It intersects the third bearing in the point  $C$  which is the final position of the ship. Join  $B$  and  $C$ .  $BC$  is to scale the set of



the current and wind during the time interval  $(t_2 - t_1)$ , the direction of the set being from  $B$  to  $C$ .

In Fig. 2,  $t_0$  equals  $t_1$  and  $(t_2 - t_1)$  equals  $(t_2 - t_1)$ . The same lettering is used as in Fig. 1. It will be noted that the solution is simplified because the points  $A$ ,  $M$ , and  $D$  merge into one point on the first bearing, the points  $C$  and  $K$  merge into one point on the third bearing and the distance  $OM$  equals  $ON$ .

It appears to me that the solution shown in Fig. 2 is the one that, in practice, will be the one most generally used. It is very probable that the initial "fix" will lie on the first bearing and I can see no good reason why the remaining bearings should not be taken at equal intervals of time.

It should be noted that the graphical solution can be carried on while the ship is proceeding from the first to the third bearing, little remaining

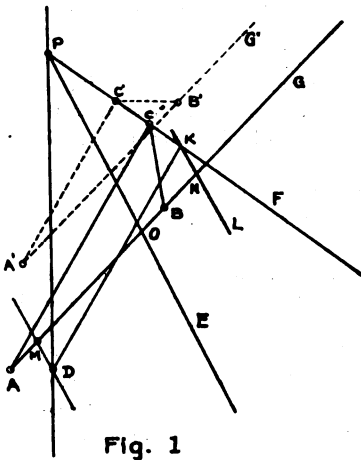

Fig. 1

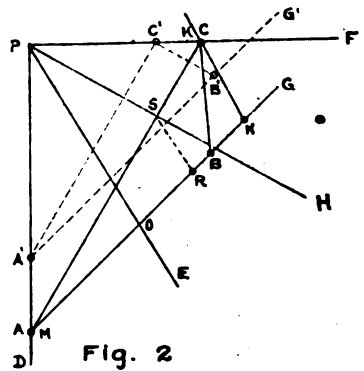

Fig. 2

to be done to complete the solution when the third bearing is obtained. This is evident, if we consider the case shown in Fig. 2. As soon as the first bearing and the initial "fix" are plotted, the course  $AG$  may be drawn. The time intervals for the second and third bearings are decided upon and the point  $B$  is plotted. As soon as the second bearing is plotted the point  $N$  is plotted by making  $ON$  equal to  $OA$ . An indefinite line  $NK$  is drawn through  $N$  parallel to the second bearing. When the third bearing is finally obtained and plotted all that remains to be done to complete the solution is to draw the lines  $AC$  and  $BC$ .

A preliminary solution may be obtained if an intermediate bearing between second and third bearings be taken. For example, in Fig. 2 if such a bearing  $PH$  be taken after half the time interval between the second and third bearings has elapsed,  $OR$  is laid off equal to one half  $ON$  and  $RS$  is drawn parallel to the second bearing, intersecting this intermediate bearing in the point  $S$ . Join  $AS$  and prolong this line to meet the line  $NK$  in the point  $C$ , thus obtaining a predicted final position of the ship.

As has already been stated, the solution shown in Fig. 2 is so simple that it should be the one generally used. In order, however, that preliminary solutions can be readily obtained I would recommend taking five bearings at equal intervals of time. The main solution in this case would depend upon the use of the first, third and fifth bearings. As soon as the first three bearings had been taken a preliminary solution could be made and when the fourth bearing had been taken three other preliminary solutions could be made. All these preliminary solutions should be consistent, provided the bearings be accurately taken. Any inconsistencies not accounted for by the probably inaccuracies of the bearings indicate that the current is variable in strength or direction and, therefore, that the method cannot be relied upon.

In Figs. 1 and 2 is shown in dotted lines the effect produced by inaccuracy of the initial fix. In each figure the ship, actually at  $A$  is believed to be at  $A'$ . It will be noted that the final positions  $C'$  are inaccurate. What is more important is that the apparent current effect is wholly erroneous both in strength and direction. If this erroneous current data be used in subsequent navigation serious consequences may result.

If at  $C'$ , in Fig. 2, the course is changed and another problem solved using the same time intervals as in the first problem, it will be found that the current in the two problems will not be consistent, due to the inaccuracy of the initial fix. It is possible, however, with these two consecutive solutions at hand to determine the true track of the ship. The procedure is as follows:

Plot the dead reckoning track of the ship. Extend backward the second dead reckoning course a distance equal to the run on that course. Through the point so obtained draw a line parallel to the second true course (already determined). This line will intersect the first true course (already laid down) in a point. Through this intersection draw a line parallel to the first bearing of the first problem. This line will intersect the final bearing of the first problem (which is also the first bearing of the second problem) in the true position of the ship on that bearing. The true courses, already determined, draw through this true position will give the true track of the ship, the true initial and final positions and thus render easy the determination of the true direction and true strength of the current.

It is obvious that much of the work just described can be done while the ship is proceeding from the initial to the final position, so that little remains to be done after the final bearing of the second problem has been taken in order to determine the true track of the ship.

This particular application of the method may be found to be very useful in making a running survey of a coast off which may run a current whose strength and direction are unknown. In a running survey the positions of uncharted objects may be accurately fixed by bearings only in case the position of the ship is accurately known at all times. The method just described determines the true track of the ship when only one charted object is available for fixing the ship's position.

Probably much more could be written in favor of using the graphical solution of the problems involved in the use of this method, but it is

believed that enough has been said to warrant my taking issue with the statements contained in the quoted sentence with which the author ends his article.

### Trans-Pacific Communication

(SEE PAGE 1803, WHOLE No. 213)

LIEUT. COLONEL C. A. SEOANE, Signal Corps.—In keeping with the sound principle that cable and radio systems should be laid out so as to have radio stations near the corresponding cable stations, which you very well discuss, the thought occurs to me that when the time comes to lay a cable across the northern Pacific it will certainly follow a route along the Aleutian Islands. Cable relay and radio stations would naturally be located there.

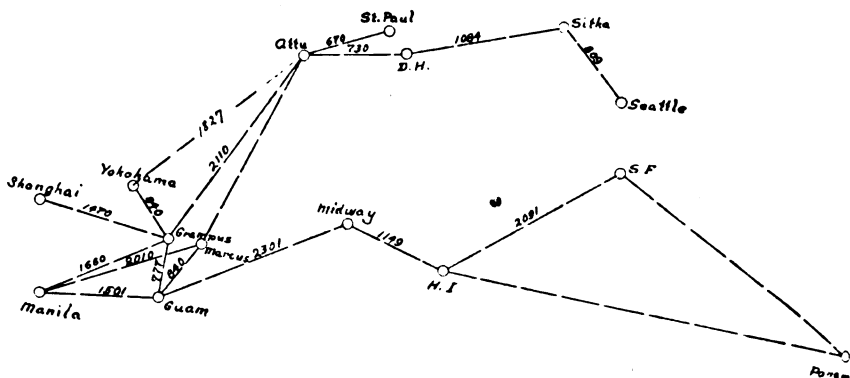

The St. Paul radio station is admirably located for this and a nearby cable station would probably be at Dutch Harbor.

The next westward relay point might naturally be Attu, 730 miles west of Dutch Harbor, and about 670 from St. Paul. So far, so good, but from here on I do not think that a very clearly defined communication route, either for cable or radio, has ever been laid out.

I have been thinking over the matter and believe that from Attu the next point should be Marcus Island, in 24 N., 154 E., and about 1980 miles from Attu, and approximately 2473 miles from St. Paul.

It may be interesting to know that St. Paul-Sitka Marcus midway form a parallelogram with equally long and short sides.

About 381 miles west of Marcus in 25 N. and 147 E. lies Sebastian Lobos, about 2110 miles from Attu and about 2630 from St. Paul, I have not been able to find that this island is owned or claimed by anybody. Some charts show it under the name of Grampus and Marcus under the name of Weeks.

The reasons why I claim that either of these would make a most desirable relay station in reaching the Orient are these: it would make possible a system by which lines could radiate to Yokohama, 840 miles, Shanghai, 1470 miles, Manila, 1660 and Guam 777—via Grampus, and the distances

from Marcus would be, Yokohama, 1050 miles, Shanghai, 1860, Manila, 2010, Guam 840.

By connecting up the cable and radio systems with Guam, connection is established with the existing system to the Hawaiian Islands, etc., and would enable communication to be routed over either system, as bulk of traffic or breaks might require.

Let us, for instance, imagine that a great deal of traffic would be going from Manila to the United States and that this would be centered on radio, due to cable breaks. Manila would be able to work alternately with Grampus and Guam, enabling each to relay what it received without holding up Manila (Cavite).

It would make a grid or network covering the Pacific Ocean with a flexibility as outlined, which means that the efficiency of transmission should be at a very high rate indeed and in keeping with our commercial and other requirements in the Pacific Ocean.

It would be very difficult to develop any such possibility as this if the terminus of any new system were to be in a foreign port such as Shanghai or elsewhere. In fact, due to international agreements, that would have to be arranged, it might become impossible to do this, and the result would be that the two systems could not tie up with each other with the ease that the proposed arrangement would permit.

I cannot help reiterating that I consider Grampus a very valuable location indeed and we should lose no time in occupying it, as I think it belongs to the United States.

U. S. NAVAL INSTITUTE  
SECRETARY'S NOTES

**Membership** Life, regular and associate, 5493.  
New members, 25. Resignations, 9. Deaths, 4:

Lieut. Commander S. A. Wilson, U. S. N.

Lieut. A. L. Ware, U. S. N.

Captain D. A. Hall, U. S. C. G.

Mr. E. M. Paddleford.

Practically the whole service receives the benefit of the PROCEEDINGS yet many officers, who read it monthly, are not members and therefore contribute nothing to the support of the Institute. Members are requested to urge non-members to join. Publication costs are now so high that the Institute is carrying a loss. The cost, per member, however, decreases with an increase in membership.

The annual dues (\$3.00) for the year 1921 are now  
**Dues** payable.

Regular and associate members of the U. S. Naval Institute are subjected to the payment of the annual dues until the date of the receipt of their resignation.

Discussion of articles published in the PROCEEDINGS is cordially invited. Discussions accepted for publication are paid at one-half the rate for original articles, or about \$2.25 a page.

**Address** *All members are urged to keep the Secretary and Treasurer informed of the address to which PROCEEDINGS are to be sent, and thus insure their receipt.*  
**Members** Members and subscribers are urged to notify the Secretary and Treasurer promptly of the non-receipt of PROCEEDINGS, in order that tracers may be started. The issue is completed by the 15th of each month.

**Book Department** *The Institute Book Department will supply any obtainable book, of any kind, at retail price, postage prepaid.* The trouble saved the purchaser through having one source of supply for all books, should be considered. The cost will not be greater and sometimes less than when obtained from dealers.

The Boat Book, 1920, and the Landing Force and Small Arms Instructions, 1920, are now ready for issue. The price of the former is 50 cents per copy, and of the latter \$1.00 per copy.

In the early part of the summer, the Institute will publish two books, bearing the following titles: "The Aircraft Hand Book," by Lieutenant Albert Tucker (C. C.), U. S. Navy, and "Composition for Naval Officers," by Professors Stevens and Alden, Dept. of English, U. S. Naval Academy.

The prices of these books will be announced later.

The Seaman's Hand Book, containing much valuable information for enlisted men, particularly those of the deck force, has been added to the Institute's publications. This excellent little book is retailed at 65 cents per copy.

**Index to Proceedings** The attention of readers of the PROCEEDINGS is invited to the classified analytical index for numbers 101 to 200 inclusive, which is noticed under "Publications." This is a most complete index, which has been prepared at considerable expense in order to make readily available the information contained in both the articles and the notes of these issues. Only a limited number of copies are being printed. Price, bound in cloth, \$2.35; bound in paper, \$1.85.

**Articles** The Institute desires articles of interest to all branches of the service, including the Reserve Force. Attention is invited to the fact that the submission of articles is not limited to members, and that authors receive due compensation for articles accepted for publication.

All articles and discussions submitted by persons belonging to the navy for publication in the PROCEEDINGS must be in duplicate, one copy being signed by the author, which will be submitted to the Navy Department when the original is published, as required by General Order No. 46, of May 20, 1921.

**Reprints of Articles** The attention of authors of articles is called to the fact that the cost to them of reprints other than the usual number furnished, can be greatly reduced if the reprints are struck off while the article is in press. They are requested to notify the Secretary and Treasurer of the number of reprints desired when the article is submitted. Twenty copies of reprints are furnished authors free of charge.

**Illustrations** Authors of articles submitted are urged to furnish with their manuscript any illustrations they may have in their possession for such articles. The Institute will gladly co-operate in obtaining such illustrations as may be suggested by authors.

Original photographs of objects and events which may be of interest to our readers are also desired, and members who have opportunities to obtain such photographs are requested to secure them for the Institute.

**Notice** Whole Nos. 6, 7, 10, 13, 14, 15, 17, 144, 146, 147, 173, 215 and 217 of the PROCEEDINGS are exhausted; there are so many calls for single copies of these numbers that the Institute offers to pay for copies thereof returned in good condition at the rate of 75 cents per copy.

ANNAPOLIS, MD., July, 1921.

#### INFORMATION INDEX

	PAGE
ADVERTISEMENTS, INDEX TO.....	I
PUBLICATIONS, U. S. NAVAL INSTITUTE.....	(2)
SPECIAL NOTICE .....	1322
TOPICS FOR ESSAYS .....	1323

# PROFESSIONAL NOTES

PREPARED BY

LIEUT. COMMANDER H. W. UNDERWOOD, U. S. Navy

## GENERAL ARRANGEMENT

VESSELS BUILDING.	}	France .....	1279
NAVAL POLICY.		Germany .....	1282
MATÉRIEL.		Great Britain .....	1287
PERSONNEL.		Japan .....	1293
MERCHANT MARINE.		United States .....	1296
AERONAUTICS .....			1301
ENGINEERING .....			1304
CURRENT NAVAL AND PROFESSIONAL PAPERS.....			1310

## FRANCE

THE FRENCH NAVAL PROGRAMME.—Circumstances have placed France in a difficult position as regards the determination of her future naval policy. If, on the one hand, the collapse of Germany and the dismemberment of the Austrian Empire have materially reduced the risk of attack by sea, on the other, she has emerged from the war still a great Colonial Power, burdened with all the maritime responsibilities inseparable from that status. Since neither national dignity nor considerations of a more practical nature permit her to rely permanently on foreign aid for the safety of her coasts and oversea communications, she finds herself compelled to take such measures of naval defence as are feasible within the narrow limits imposed by a depleted exchequer. It is now going on for 20 years since France abandoned the hopeless attempt to compete on equal terms with this country, Germany and the United States in building great battle fleets. Unable to stand the severe financial strain which this policy involved, she adopted a new formula of relative strength, based principally on the maintenance of supremacy in the Mediterranean. Thanks to the *entente* with England, she was able to withdraw most of her forces from the Channel and concentrate them in the Middle Sea; for although she had no explicit assurance that the British Navy would protect her northern coasts from German aggression, she nevertheless proceeded on that assumption, and subsequent events vindicated her judgment. The French building programmes from 1905 onward were therefore framed with a view to securing a margin of superiority over Austria and Italy, who in virtue of the Triple Alliance had to be reckoned as potential confederates. The last pre-war building project, authorized in 1913, included five battleships, constituting the *Normandie* class, which were chiefly remarkable for the disposition of their 12 heavy guns in quadruple turrets. All five vessels were under construction when war broke out, but it soon became necessary to suspend work upon them, and from that day to this the ultimate fate of these 25,000-ton vessels



has been the subject of endless debate. A numerous party in France favoured their completion more or less to the initial design, but with minor modifications indicated by war experience. Others proposed a recast of the plans to embody 18-inch guns and a higher speed, whilst some suggested converting them into merchant ships. The French Government has now decided to scrap four of the unfinished hulls but to complete the fifth ship, the *Béarn*—which was launched in April, 1920—as an air craft carrier, Although it means sacrificing a considerable sum of money which has been spent on the four condemned ships, this decision is unquestionably the wisest that could have been reached. No amount of tinkering with the plans could have made these vessels equal in fighting power to the capital ships now being built in other lands, and by completing the group France would merely have added five inferior ships to her navy at an estimated expenditure of £28,000,000 sterling.

In submitting this decision to the Chamber of Deputies last week, M. Denise, *Rapporteur* of the Naval Committee, defended it on the ground that heavy ships were too vulnerable to submarine attack, thereby implying that battleships would in any case be useless to France, even though she could afford to build them. Without reopening a controversy which has been closed for the nonce by the unanimous resolve of the three leading naval powers to perpetuate great ships as the primary units of their respective fleets, we may assume that France is dispensing with this type, not because her naval advisors have embraced the alluring doctrines of the *Jeune Ecole*—“*le nombre, la vitesse, l'invulnérabilité, la spécialisation*”—but because she is unable at the moment to spare the money for a squadron of modern capital ships. Unless this fact be duly emphasised, there is a danger that false conclusions of a technical nature may be drawn from the new French programme. It authorizes the construction of 6 cruisers, 12 flotilla leaders, 12 destroyers, and 36 submarines, and, including the cost of transforming the *Béarn* into an aircraft carrier, represents a total outlay of 1,416,000,000 francs, to be spread over five or six years. Such meagre particulars of the cruisers as have transpired show them to be more akin to the British *Raleigh* and the American *Omaha* classes than the conventional light cruiser. On a displacement of 7500 or 8000 tons they are to steam at 34 knots and carry a powerful armament, either of 6.4-inch or 7.6-inch guns. They are expected to cost 70 million francs apiece. It is a noteworthy fact that no light cruiser has been laid down in France since 1897. The new ships are already evoking criticism on the score that they signify a return to the discredited armoured cruiser type, are needlessly large, and will cost too much money. These strictures are countered by references to the generous dimensions which have been adopted in latest British and American cruisers designed for ocean work. The 12 flotilla leaders are to displace about 2000 tons, and will cost 22 million francs each. Their design may have been influenced by that of the similar vessels which Italy is now building, and also, perhaps, by the ex-German boat *S 113*, now incorporated in the French navy as the *Amiral Sésès*. This latter vessel, with her relatively tremendous armament and high speed, would doubtless prove very formidable in smooth water, but the great weight of top-hammer causes her to roll dangerously in a seaway. Having had the opportunity of studying the German prototype at first hand, the French constructors may be relied upon to avoid its defects in the big flotilla leaders they are about to lay down. The size of the 12 new destroyers has not been stated, but as a sum of 168 million francs has been set aside for them and they are estimated to cost 11,000 francs per ton, the displacement is presumably about 1270 tons, which would make them rather smaller than our *Admiralty W* class. Finally, there are the 36 new submarines, costing 504 million francs in the aggregate. Their displacement, it is said, will average 1000 tons, but two or three distinct types will be represented, including large submersible cruisers, minelayers, and medium ocean-going boats of 800 to 1000 tons.

In this case, too, French constructors have a large selection of models to choose from. They do not seem enamoured of the German types which have come into their possession—and which, though the fact is studiously ignored in Germany, are modifications of the *d'Equivilly* type, and therefore French in conception—regarding them as unworthy of imitation except in certain minor features, though the excellence of their M. A. N. Diesel engines is admitted. French submarine development has suffered in the past from the very fertility of the national genius. A restless desire to attain perfection led to the too hasty adoption of experimental types, theories of construction were promptly put into practice before they had been thoroughly studied, and so it befell that France never gained a fair return for the vast amount of thought, energy, and treasure which she expended on the submarine arm. But her faith in its efficacy is unshaken. French naval experts, with few exceptions, consider the geographical position of their country to be exceptionally favourable for the employment of submarines and naval aircraft, both for defence and attack. Speaking in the Chamber in March, 1920, M. de Kerguézec declared that “the day on which France is supported by a fleet of 250 to 300 submarines she will be able to contemplate the future without any misgiving whatever.” And many years before, when the submarine was still primitive and unreliable, a French admiral had exclaimed, “*Jamais nous n'aurions trop de sous-marins!*”

The restoration of French sea power to a level commensurate with the extensive maritime commitments of the republic will be watched with interest and sympathy in this country. Throughout the war the navy of France performed splendid service, and the valour of her seamen often triumphed over material deficiencies. The large majority by which the new programme passed the Chamber without modification or amendment is proof that the French people appreciate the value of naval power and are not to be deterred from cultivating it by the heavy cost involved.—*The Engineer*, June 24, 1921.

**THE RHONE.**—The bill authorizing the carrying out of works for utilizing the Rhone as a waterway between the Swiss frontier and the Mediterranean, as a producer of electrical energy and as a means of irrigating large areas of land that are at present unproductive, has now been passed, and every effort is to be made to carry out a scheme that has been discussed for nearly three decades. If the enterprise is regarded as of national importance it is because the hostilities showed the danger of leaving the country dependent upon foreign coal supplies, and it is hoped by utilizing the hydraulic power of the Rhone to limit the home demand for coal to what can be supplied by the home collieries. The hydro-electric installations will furnish 800,000 horsepower and will represent an economy of 42,000,000 tons of coal a year, which is nearly equal to the quantity imported before the war. Again, by releasing such a large quantity of fuel more will be available for the smelting of the Lorraine ores which are in need of cheap coal from the Saar or from the Nord if the industry is to develop to the extent justified by the importance of the deposits. The Rhone electrical distribution will permit of the country south of the Loire largely reducing its demands upon the northern coal fields. The canalization of the Rhone is intended to permit of the passage of boats of 1200 tons between Strasbourg and Marseilles, for which purpose the canal between the Rhine and the Rhone will have to be enlarged. The scheme also provides for the irrigation of 675,000 acres of territory which, by this means, will be able to produce twice as much as they are now doing. The cost of the undertaking is estimated at 3,400,000,000 francs, and it is to be carried out by a company comprising all the interests concerned. This vast enterprise will contribute greatly to the industrial activity of the country, which, with the reconstruction and other work, should find an abundance of employment in nearly all branches of industry in the near future.—*The Engineer*, June 3, 1921.

## GERMANY

THE GERMAN MARITIME REVIVAL.—“Ten years hence Germany will once more possess a flourishing mercantile marine and a formidable war navy. Thousands of people here are working for the great maritime renaissance which will, they believe, precede and make possible the complete restoration of imperial Germany,” so writes a well-informed correspondent who has spent the last six months in Berlin and the chief industrial centres of the Fatherland. He reports the existence of a vigorous propaganda on behalf of sea power. Every effort is being made to slur over the inglorious collapse of the old “Reichsflotte,” and with so much success that the Kiel mutiny is now universally ascribed to the machinations of agents financed by the Entente. The fact that the personnel of the High Seas Fleet remained docile enough until ordered to go out and face the British guns is conveniently ignored. A legend of victory has been woven round Jutland, as witness the enthusiastic celebrations of the anniversary reported from Berlin last week. Because the High Seas Fleet escaped annihilation by a rare combination of good leadership and amazing luck it is held to have been victorious, just as the German army boasts itself “unconquered” because—for reasons best known to the Allied statesmen, but inexplicable to everyone else—it was permitted to return home with bands playing, colors flying, and all the outward signs of “withdrawal according to plan.” In this way the fable of German “invincibility by land and sea” has been carefully preserved. It is already forgotten that Hindenburg and Ludendorff were metaphorically on their knees before Foch, pleading for an armistice at any price; that Ludendorff himself declared the army to be incapable of further resistance and warned Berlin that any delay in arranging a truce would lead to a débâcle without precedent in military history; and that the German Navy purchased its exemption from ordeal of battle by the most humiliating surrender on record.

Those who knew the Germany of pre-war times never believed for a moment that she would allow matters to proceed to the last extremity in the event of an unsuccessful war. They foresaw that she would, on the contrary, seize the psychological moment to draw back from the abyss of irretrievable disaster and endeavor by political chicanery to make good the consequences of military defeat. But it may be doubted whether the keenest student of German methods anticipated the sublime effrontery with which our late enemies are now perverting the facts of recent history. The average Briton smiles indulgently over his newspaper when he reads of these Jutland “victory celebrations” in Berlin or scans the pompous rodomontade of some Prussian general who less than three years since was quaking in his shoes at the name of Foch. But it is wrong to dismiss as unimportant these manifestations of reviving “Kriegslust.” According to the correspondent who is quoted at the head of this article, “hatred of England is the cement that keeps the German Empire together and saves it from total disruption. Anglophobia was general enough before the war, but it is tenfold more rampant to-day. The Germans affect to despise France, and such grudging tribute as they pay to the military genius of Foch is due to the popular myth that he is of German extraction. They are equally contemptuous of America, while privately regarding her as a potential ally (the German conception of America is that of a country where all the brain power and most of the political influence are vested in the ‘German-American’ element). For England is reserved the honor of unequivocal hatred, and although public allusions to ‘revanche’ are officially frowned upon, nine Germans in ten live for the day of reckoning with Great Britain which they believe to be foreordained.”

From further information supplied by my correspondent it seems that the “Abrechnung mit England” may be postponed as the result of disagreement concerning the means. The naval enthusiasts are all for the restoration of German sea power, mercantile and military, which they

consider to be the only weapon capable of reaching the heart of England. These favor the rapid development of German shipping side by side with the gradual building up of a naval force, the main components of which will be fast cruisers, submarines, and aircraft. They are working more or less hand in hand with the Air Leaguers, who see in a supreme air fleet the one sure method of achieving the common aim. Both schools are at loggerheads with the Ludendorff party, which claims priority for the reorganization of German military power and dreams of revenge in terms of cadres and divisions. Col. Repington's articles in *The Daily Telegraph* on German army reorganization show this party to be in the ascendant for the time being. The old army formations are being kept together under the camouflage of police ("Orgesch," an abbreviation of "Organization Escherisch"; Einwohnerwehr, etc.), and most elaborate measures have been taken to facilitate the rapid expansion of these nucleus bodies, mainly composed of veteran officers and N. C. O.'s, into full-fledged army corps when the time is ripe for throwing off the mask. How far the corresponding preparations for aerial warfare have progressed is a point on which the information is somewhat conflicting, but presumably the Allied Governments are kept au courant by their respective missions.

Secret naval preparations at the German ports are reported from time to time, mainly by the French Press, and M. Lefèvre claims to have reliable news of the building of submarines in defiance of the Peace Treaty. So far, however, none of these rumors has been confirmed. They are, in fact, inherently improbable. Germany knows full well that precipitate action of this kind would be fraught with the gravest consequences to herself. Moreover, the Allied missions still maintain a vigilant watch and appear to have established an efficient intelligence service. Some weeks ago British and French officers paid a surprise visit to the Jaeger Ironworks in the Varresbeck, which were found to be manufacturing equipment for submarines—ostensibly to Dutch order. The mission insisted on the immediate stoppage of this work and the destruction of all material, models, and drawings relating thereto. Not until the Allied control officers have been withdrawn from Germany shall we have real cause for apprehension in regard to the secret manufacture of submarines, aircraft, and other war material.

The German shipping revival is making remarkable progress, considering the adverse circumstances. Most of the yards are well supplied with orders, every month witnesses the launch of several big ocean-going ships, and the well-known lines are taking advantage of the abnormal rate of exchange to recover some of their former business which had temporarily passed into foreign hands. That the German public believes in a bright maritime future is shown by the eagerness with which it is investing money in shipping enterprises. In the first three months of this year new capital to the amount of 210,720,000 marks was contributed to overseas shipping, shipbuilding, and deep-sea fishery undertakings, either in the form of subscriptions to new companies or increases in the capital of existing concerns. In the corresponding quarter of last year only 10,150,000 marks were similarly invested, the total for the whole year amounting to 223,684,000 marks, which was barely 13,000,000 marks more than the sum invested during the first three months of 1921. These figures speak for themselves. Taken in conjunction with the far-reaching schemes of harbor works and port improvements reported from Kiel, Hamburg, Cuxhaven, and Wilhelmshaven, and with the announcement that 90 per cent of the total amount of money which the German Government has agreed to pay its nationals by way of compensation for war losses in shipping is to be spent on new construction in German yards, they show how fallacious is the popular belief that Germany has abandoned her maritime ambitions. When she is once more in possession of a great merchant fleet she will undoubtedly begin the reconstruction of her war navy, a task for which the ground is already

being prepared by intensive propaganda. We have not done with Germany yet.—*The Naval and Military Record*, June 8, 1921.

GERMAN JUSTICE.—Seven judges in violet robes upheld the German policy of frightfulness when they acquitted Naval Lieutenant Karl Neumann of the sinking of the English hospital ship *Dover Castle*. Such is the view of the Providence *Bulletin* and a score of editors the country over. The lieutenant's defense was that he merely obeyed orders, and the judges of the High Court at Leipsig, where the trials of German war prisoners are being held, acquitted him accordingly. "If this ruling is to be considered a general precedent, no submarine commander, no field commander, no military governor of occupied territory is likely to be brought to punishment, whatever may have been his crimes," concludes the *Detroit Free Press*. Nevertheless, thinks the *Utica Press*, "the subordinate who would sink a hospital ship or a *Lusitania*, with its hundreds of non-combatant men, women, and children, is not one whit less a murderer than his superiors who would order it; Neumann is freed by a German court, but by his own confession he and the government he served are branded as murderers."

The long-delayed trials of German war criminals, originally intended to bring some one in authority to book for some of the major crimes committed in the war, began with the trial and conviction of a sergeant charged with brutal treatment of British war prisoners. Ten months' imprisonment was his portion, but, as the *Tacoma Ledger* puts it, "he was only one of the goats; the big criminals are the important items on the list." Next came the case of the commandant of a German prison camp, who, according to the diary of a British prisoner, was "responsible for the deaths of hundreds of Tommies." Another British witness against the Herr Commandant said the German officer "liked to amuse himself by riding horseback into groups of sick prisoners too weak and helpless to get out of the way." Six months, said the seven judges in violet robes. A second non-commissioned officer, for striking prisoners with a rifle-butt, knocking them down, and continuing to strike them, was found guilty and sentenced to six months' imprisonment; then came the trial of Lieutenant Neumann. This was the crucial case of the four selected by the Germans to prove that they could render justice. But "it was not Lieutenant Neumann who was on trial; it was the whole German people, whose government had ordered ruthless submarine warfare," declares Arno Dosch-Fleurot in a dispatch from Leipzig to the *New York World*. In this correspondent's opinion—

"It made no difference whether Neumann was convicted or acquitted, he was not the real criminal before the bar. The German Admiralty was on trial, yet the decision of the court had nothing to do with the guilt of the Admiralty. The question really before the court was whether the Admiralty had the moral right to sink British hospital ships, although the court could decide only whether Neumann was guilty.

"The trial consisted in Neumann explaining that he only carried out explicit orders to sink British hospital ships, of which the *Dover Castle* happened to be one. He gave a cold recital of how he waited for six hours near the *Dover Castle* while it zigzagged in flight until the opportune moment to strike. His orders were read in court and the case came to an end. There were no witnesses because they were at the bottom of the sea."

Editors and correspondents remind us that Germany promised at Versailles to hand over to the Allies for trial an imposing list of indicted German war criminals. "There are 573 of them listed in a French 'Who's Who of Atrocity,'" according to the *Chicago Tribune*, including the names of Von Hindenburg, Prince Rupprecht, Von Mackensen, Von Bülow, Von Tirpitz, and Prince Eitel Friedrich. Even the former Kaiser was to be no exception; in fact, we are told, Premier Lloyd George's election pledge in 1919 was to "hang the ex-Kaiser." Germany, however, did not keep

her promise, and the Allies thereupon permitted Germany to try the prisoners herself. Leading London papers call the trial a farce, as do the *Milwaukee Journal*, the *Providence Journal*, and a dozen more of our own papers. Yet, notes the *Baltimore American*, "an impartial effort by the Germans to fix the guilt of their countrymen is contrary to the laws of nature; the pot can not sincerely call the kettle black."

"The real criminals are the men higher up, the field-m Marshals and statesmen," asserts the *New York Times*, and its neighbor, *The Tribune*, tells us why:

"It follows that real responsibility for ruthless submarine warfare, the sinking of hospital ships and merchant ships, neutral or Allied, carrying non-combatant passengers; for the bombing of unfortified towns and land hospitals, the slaughter of enemy civilians and the wanton destruction of property outside the zone of battle rest with the German higher-ups, who determined that war should be waged on a new basis. The German policy was deliberate and cold-blooded. It was predicated on the assumption that the fighting was to occur mainly on foreign soil and that Germany would be fairly safe from reprisals. She had no merchant marine on the high seas. . . . ."

"Will the court go after the high command which framed the German policy of ruthlessness on land and sea and place the guilt where it belongs, even if the trial leads to Tirpitz, Falkenhayn, and Ludendorf, and to the once Aller-Höchste, now a crestfallen, cringing exile in Doorn? Or will it be solemnly adjudged, should they be brought into court, that they were not guilty because they took no personal part in the atrocities?"

"It does not appear that the Leipzig court has any intention of trying the higher-ups," says the *Albany Journal*, as if in reply. In fact, avers the *Columbus Ohio State Journal*, "the spirit of Germany is the same as it was under the rule of the Kaiser; it is as full of deception, evasion, trickery, and assumption as ever."—*The Literary Digest*, June 25, 1921.

**THE LEIPZIG TRIALS.**—Up to the time of going to press four only of the subordinate German war criminals have been tried for the hideous barbarities they perpetrated during the war, either against defenceless prisoners or against the sick and wounded passengers on hospital ships; and while one of them has escaped any punishment whatever on the wholly insufficient grounds that he acted under orders, the three remaining ruffians have been given sentences ridiculous and even offensive in their leniency. We notice that the Attorney-General deprecates the tendency he observes in Parliament and in the press to sit in judgment on the Leipzig sentences upon what he terms "very imperfect information," while he smugly remarks that he considers the righteous indignation which has universally been aroused as "a little premature." We do not envy Sir G. Hewart his point of view, nor do we know what further evidence he requires that the whole Leipzig procedure is becoming a disgusting and sorry farce. The four criminals were found guilty of the foul acts of which they were accused; three have been awarded wholly inadequate sentences—which, moreover, neither will serve out in full—while the fourth gets off under something like a quibble. The policy our legal representatives foolishly followed of prosecuting subordinates only stands condemned, as all sensible people prophesied that it would; the present series of trials, selected and accepted as a test of good faith, has demonstrated that German courts are not the proper places for deciding upon the guilt and for the punishment of Germans accused of horrible crimes against their opponents in the late war; and there is only one thing to be done in the matter, and that is at once to consider the propriety of having the rest of the trials removed to London, and to demand the immediate extradition of the superiors who formulated and issued the orders which caused their subordinates to act in a manner contrary to the laws of civilized nations.

The view expressed in these columns last week about the trial of the first German military officer charged at Leipzig with inhuman and barbarous offences against British prisoners of war applies with even greater force to the result of the so-called trial of the first of the submarine commanders. Indeed, the circumstances of the latter case afford a convincing endorsement of the argument which was put forward, that it is somewhat of a farce to proceed further with these trials without bringing to account those in higher positions whose code of discipline and warfare made possible the crimes which were committed. If ten months' imprisonment is, as most people will admit without question, a hopelessly inadequate punishment, and if six months and two months in the next cases are even more so, what is to be said about the acquittal of Lieutenant-Commander Neumann, of *UC-67*, on the charge of torpedoing the hospital ship *Dover Castle* on May 26, 1917? Neumann admitted the act, but pleaded his conviction that ammunition was on board the ship, although he was unable to adduce proofs, of course. Even the judge, in relation to an alleged photograph brought by a German prisoner from France of the loading of ammunition in hospital ships, said he had never seen such a picture, and could not regard the allegation as proved.

Neumann's defence rested solely and wholly on the fact that he was carrying out the orders of his superiors issued on March 29, 1917. This is the first time we have heard of any order of this date, although the particular edict referred to is probably well known to the British Government. It is quite certain, however, who were the persons who first started the submarine war on merchant ships, hospital ships and the like, and the immediate need is to bring them to trial, for if the plea of obedience to orders is to be allowed as in the case of Neumann it is futile to proceed with the cases of the subordinates. The surprising thing is that our government should have acquiesced in the plan of trying the juniors first, or rather in the arrangement whereby an officer like Neumann is put up to get off scot free. If it was known that the line of defence would be that no charge could stand where an officer adhered strictly to orders, it should have been easy to find plenty of cases where officers did not do so, but committed personal cruelties over and above their orders. Even these arch-criminals, however, might try and shelter behind the war lords in authority. We are glad to learn that some of the latter are to stand their trial later before a more important Leipzig tribunal. So far, the trials have been utterly devoid of justice.—*The Army and Navy Gazette*, June 11, 1921.

HERR HUGO STINNES, who was a great man in Germany before the war, has loomed even larger since the Peace. Known originally as an iron and steel magnate, he has since acquired immense influence as an owner of a great number of newspapers, and, indeed, of many other organizations, and at one time it really appeared as though he could dictate his policy to the government of the day. Yet the Hamburg-American Company, in which undertaking Herr Stinnes is a large shareholder, has shown that they felt strong enough to be independent of him. The annual general meeting of the company was held at the end of April, under the chairmanship of Herr Max von Schinckel, who, in recommending the official candidates for election to the board, told the shareholders that the directors could not recommend the inclusion of the name of Herr Stinnes. The board has arrived at this decision because the gentleman in question has started a new line to South America, and has done so without any regard to the interests of the Hamburg-American Company. This action would have been annoying enough under any circumstances. The policy of German shipping has for many years been towards agreements and inter-working. But since the war it seems to have been agreed that no co-ordination is essential to the re-starting of the German

shipping machine. And the inauguration of a rival company by their own familiar friend was therefore about the bitterest blow that could have been struck at the directorate. Indeed—considering that Herr Stinnes has so large an interest, not only in the Hamburg Company itself, but also in the German East African and the Woermann Lines, in which the company, too, has large interest holdings,—it seems strange enough that he should have encouraged a new competition in the field. However, whatever his reasons may be, the company has made its protest against what the chairman terms “exaggerated ambitions,” and has evinced its determination to maintain its freedom of action and its independence. The policy of the company, indeed, is not to be changed. For, losing the services of Herr Stinnes, they filled his place by the election of another great industrial magnate, Herr Heniel, who is the leading spirit of the Gutehoffnungshutte, whereby they evidently hope to secure themselves against any ill consequences from their bold action. Meanwhile, Herr Stinnes proceeds on his way unruffled, his latest reported transaction being the purchase of a group of newspapers, of which the *Deutsche Zeitung* is chief, at a price of no less than seventeen millions of marks. This is a huge sum enough. For, though the mark may not be worth more than a penny in the international markets of the world, depreciated currency has hitherto always maintained its face value in domestic transactions.—*The Marine Engineer and Naval Architect*, June, 1921.

#### GREAT BRITAIN

**COMBINED STAFF TRAINING.**—In the early part of this month a discussion was evoked in the House of Lords by Viscount Haldane who, as has ever been the case, succeeded in putting his finger on a weak spot in the defensive plans of the nation. In common with every close student of the successive events of the late war, he recognized that in spite often of most brilliant work separately, there had been an unfortunate lack of cohesion, or rather of combination, between the forces which were fighting on land and those which were fighting on the sea. Lord Haldane, therefore, in laying stress on the necessity of unity of knowledge and understanding, further emphasized what has justly been described as a cardinal feature of our traditional strategy, in other words as an “amphibious strategy.” This, of course, is familiar to all as embracing command of the sea and an expeditionary force that can be supported by the fleet.

It is undeniable that in order that warfare carried on with such means should prove successful, there must be not only unity of knowledge in the navy and the army, to which now, of course, must be added the air force, but also in the relations between the services in the air, on the water, and on the land. As a naval correspondent of the *Morning Post* points out, owing to their training being on entirely different lines, it is quite the exception for a soldier and sailor to regard a particular problem with the same mental outlook. This, as we have just observed, is further complicated by the comparatively recent introduction of a third arm—the air service. Yet our insular and imperial position is such that practically every question of major strategy affects all three arms. “If three people come together and talk in different tongues, the result is not much better than a tower of Babel in miniature. To obtain the maximum effort there must be co-ordination and co-operation; which, in its turn, is possible only if those concerned are able to regard the particular problem from a common point of view. Or, in other words, they must think the same strategical thoughts; talk an identical strategical language; and be animated by a common doctrine of war. It seems that this desirable end can be achieved only by means of a close liaison between the services, most particularly in regard to staff work.” The Naval Staff College is, in the near future, to be moved from Greenwich to the vicinity of the Military Staff College at Camberley.



It is only reasonable to assume that sooner or later a similar institution for the air force will be established, and if so it also will be placed somewhere in the same neighborhood. Thus, as our contemporary's correspondent observes, with common lectures, free intercourse, discussions, and debate between the staffs and students of the various colleges, there will come in time that common mentality, which again, in course of time, will permeate throughout the three services. From three separate staff colleges the institution will become an imperial staff university, and with dominion representatives there and on the various staffs, there will be built up an organization which, to use Lord Haldane's words, will ensure "cohesion in naval matters and unity in other matters also, and we should become such a power as the world had never seen."

Too much importance can hardly be placed upon the desirability, nay, the urgent necessity of collaboration among the various forces. The want of such collaboration has often been unfortunate, and only luck has prevented it from being disastrous. The plan now being adopted should reduce risks of this nature to a minimum in the future. In the discussion in the House of Lords, Lord Lee stated that the scheme included officers from the dominions "in order to produce, so far as practicable, that community of ideas" upon which the future of the empire may depend. Lord Lee added that the subject would doubtless be discussed at the Imperial Conference. The regular attendance of successive parties of officers from overseas portions of the empire should prove valuable in two ways. It is clear it can be but advantageous that when colonial forces share in a campaign with those of the mother country, the training of both should as far as possible have been similar, and the military education of the staff officers identical. The constant presence of the most intellectual officers from overseas dominions should also tend to the tightening of the bond of sentiment which as long as it remains united must render the British Empire invincible. The scheme for the co-ordination in the work of the two, and presumably three later on, staff colleges, is in every way commendable and in theory really excellent. It is to be hoped it may prove equally good in practice.—*The United Service Gazette*, May 28, 1921.

EMPIRE NAVAL POLICY.—Now that the Imperial Conference is on the point of assembling it is well not to cherish exaggerated hopes of what may result from these intimate discussions between the leading statesmen of the empire. Here at home an idea has undoubtedly gained ground that the dominions are about to lift from our shoulders a large share of the financial burden involved by the up-keep of our post-war naval and military forces. This would, indeed, be good news for the British taxpayer, but we are bound to confess our inability to discern any solid basis for such an assumption. It appears to have arisen from the report that the laying down of two or four new battleships would be delayed until the conference had met, and many people at once concluded that half the cost of the building programme would therefore be debited to the dominions. This, to put it mildly, is very improbable.

The Navy League has done well to discourage hopes which are almost certainly doomed to disappointment. A leading article in the June number of its organ, *The Navy*, pours cold water on the expectation that the Imperial Conference will devise means of sharing imperially the expense of the new building programme. The inference it believes to have been unjustified, and "it is well that it should be dismissed from our minds." There is not a tangible shred of evidence that the peoples of Australasia or Canada are ready to contribute between them the 12 to 14 million pounds represented by the cost of two improved Hoods; on the contrary, such action as they have taken since the war has been indicative of a firm resolve to cut down expenditure on armaments to a very low figure indeed, and the present

naval establishments of Australia and Canada are considerably smaller than those maintained before the war.—*The Navy and Military Record*, June 15, 1921.

**AUSTRALIAN AND CANADIAN VIEWS.**—It is not a question of loyalty to the empire. All through the war the dominions gave lavishly of their best, and shrank from no sacrifice of blood or treasure which they knew to be essential to victory. Nor are they likely in future to shrink from assuming a fair proportion of the common burden of defence. But at the present moment there is nothing to suggest that they are ready to contribute largely to the cost of warships which are to be built in Great Britain, manned by the Royal Navy, and administered by the British Admiralty. In the opinion of those competent to judge, the Australians would far rather spend 10 millions on their local fleet than contribute one million to the cost of the Royal Navy. Australia, in other words, believes more firmly than ever before in the principle of local control, and is determined to make this principle the foundation of her future naval policy.

As regards Canada, that dominion is not at the moment displaying any marked enthusiasm for naval projects, but there is no reason to suppose that she has changed her mind since 1913, in which year the Borden programme was rejected by the Canadian Senate because it was regarded as a contribution to the Royal Navy, instead of providing, in Sir Wilfrid Laurier's words for "a Canadian service, built, manned, and equipped in Canada—the goal to which we look forward." In our frequent allusions to the questions of defense which loom so large on the agenda of the Imperial Conference we have invariably expressed the hope that no scheme will be submitted by the Admiralty which does not begin by recognizing, fully and unreservedly, the right of each dominion to create and maintain such naval forces as it considers necessary for its own protection. As the Navy League puts it, "the individual fleet unit remains the political ideal of the dominions, and it is the business of the conference so as to adapt its measures that politics and strategy run, if not in double harness, at least as a manageable tandem."—*The Naval and Military Record*, June 15, 1921.

**LOCAL FLEETS.**—Why there should ever have been so much boggling at Whitehall over this question of local control we fail to understand. No one gifted with a spark of imagination can have believed for an instant that the dominions would stand aside if the mother country got into difficulties. The veriest stay-at-home must have had some inkling of the deep-rooted patriotism and loyalty which bind the member-states of the empire together with ties stronger and more durable than links of tempered steel.

Two, and only two, serious objections could be urged against the building up of an Imperial Navy comprising individual fleet units, and both could have been removed by the exercise of tact and statesmanship. The first objection was under the control of a central authority both material and methods of training might cease to be uniform and the *Imperial Fleet* degenerate into an ill-assorted collection of ships, heterogeneous in design, personnel, and training. As a matter of fact, this particular difficulty never arose, because the dominions very wisely took the Royal Navy for their master pattern, building their ships and training their men on the model of the parent service.

The second objection was somewhat more serious, but in this case, too, experience showed its gravity to have been exaggerated. Apprehensions seem to have been entertained at Whitehall lest the dominions, assuming that they were prepared in case of Imperial emergency to place their respective fleets at the disposal of the Admiralty, should nevertheless insist on having a voice in strategic dispositions, with special reference to the defence of their own seaboard. This contingency, which did in fact show

some tendency to develop in the early months of the war, could have been forestalled by the creation of an Imperial Naval Staff. It is of good omen that this ideal should be categorically endorsed in the First Lord's recent memorandum. Gradual progress is to be made by appointing dominion officers both to the Naval Staff at the Admiralty and as students at the Staff College, while it is hoped that the dominions will eventually set up similar institutions of their own, working on the same lines as the college at home. This matter is to be laid before the dominion representatives, and when their views have been ascertained the Admiralty hope to indicate the machinery required to ensure the building up of navies imbued with a common doctrine and working to a uniform plan.—*The Naval and Military Record*, June 15, 1921.

**FUTURE OF BRITISH AIRSHIPS.**—The fate of our airship fleet is still in the balance. While the government declines to provide any more funds for the up-keep of the big dirigibles built under the war programme, it is ready to hand them over to private enterprise on very favorable terms. If the airship really possesses a title of the commercial value which enthusiasts claim for it, this offer should not go begging for long. The latest proposal concerns the employment of the vessels as mail and passenger liners between England and the nearer parts of the empire. It is suggested that trial flights be made to Gibraltar, Malta, and Egypt, preliminary to the establishment of a regular air service to India.

Many naval officers who regard the airship as a unit of great value for reconnaissance at sea would welcome any arrangement which had the effect of keeping these vessels available in case of emergency. So far, however, it has been a case of much cry and little wool. The possibilities of the airship, strategic as well as commercial, remain more or less theoretical in the absence of practical performance. With the exception of R 34's voyage to America two years since, no airship has been sent on a trans-oceanic cruise, though we now have several which are said to be capable of such journeys.—*The Naval and Military Record*, June 15, 1921.

**GETTING TOGETHER.**—The statement of American foreign policy transmitted from Washington last week constitutes the most cheering development in international affairs which has occurred since the armistice. If the *Times* correspondent has rightly interpreted the aims of the Harding administration, we may witness in the near future the negotiation of an agreement between this country and the United States, allocating to each a definite standard of naval strength which neither will attempt to exceed. Such an instrument would not only banish the spectre of Anglo-American naval rivalry, but make impossible a new attack upon the freedom of the seas, either from Germany or any other power. This journal has consistently upheld the view that a warship-building competition with the United States would be madness. It is not merely that the country cannot afford to lavish hundreds of millions on armaments; the economic argument is, of course, highly important, but it is not decisive. If the British people believed absolute supremacy at sea to be as indispensable to their security in the future as it was in the past, we think they would not hesitate to maintain it, be the cost what it might. But that belief is no longer held by the majority. Instinct and reason alike tell us that we have nothing to fear from a powerful American navy. We know that in the United States there exists a body of opinion which, on racial grounds, is implacably hostile to Britain, and would like nothing better than to see the two nations engaged in a fratricidal conflict. But this faction, though it doubtless comprises several million "typhnates" and is vociferous out of all proportion to its numerical strength, has entirely failed to influence American policy. Its motives are too transparent, to obviously at variance with the principles of genuine Americanism to make them acceptable to the American people as a whole.

There will be an immediate and most cordial response from this side to American overtures for limiting armaments and stabilizing world peace. Our government, without being unnecessarily loquacious, has twice affirmed in the formal way our acceptance for the future of a one-power naval standard. Lord Lee of Fareham referred to that fact in his excellent speech of March 17, and made it perfectly clear that British statesmen are ready to put aside all other business, however pressing, when the moment come to discuss the naval issue with their American confrères. He spoke for the whole country when he insisted so strongly that "in this matter we are not engaged in a game of poker or of bluff, but in a sort of game where we ought to lay our cards on the table and discuss frankly with our friends what the future should be." It was not enough, he added, to talk of hands across the sea; we must have our heads across the sea as well. There is undoubtedly a certain amount of sentiment in this matter, as there must always be in matters affecting kindred peoples, and it will be a bad day for the world when, if ever, sentiment is wholly divorced from Anglo-American affairs. But at the present juncture we want that "plain horse sense" which Lord Lee rightly declared to be characteristic of both countries. Hitherto it has been argued that two are needed to make an agreement and that American opinion had not shown any marked enthusiasm for a naval agreement with England. That argument loses its validity in face of the positive statement by the *Times* correspondent that "the ultimate desire, even the deliberate plan, of the Harding administration is to bring the United States and the British Empire together.

No moment more opportune could have been chosen for this announcement. It has come on the eve of a conference which meets primarily to determine the basic principles of empire defence by sea, land, and air. Were the future attitude of the United States at all doubtful, the problem before the conference would be difficult to the point of hopelessness. But with that attitude more or less clearly defined, the problem is at once reduced to comparatively simple proportions. Let us consider briefly what it would mean if the United States proposed to take over the naval guardianship of the Pacific, leaving us responsible for the Atlantic and European waters. Such an arrangement would, we take it, absolve us from the necessity of creating huge fleet bases in the Far East—a financial nightmare which has oppressed thoughtful minds for the past year or two. It would render possible the most effective and economical application of their naval power by the British Empire and the United States respectively, by enabling each to concentrate its entire strength in one particular area, instead of dissipating it by trying to maintain adequate forces in several prospective "danger zones." It would allay the apprehensions felt in Australasia and Canada as to the future of the white race, and, by forging a real bond of community between these dominions and the United States, make Britons and Americans working partners, if not formal allies, the world over. Nor would the bargain be by any means one-sided. The United States, on her part, freed from all anxiety as to the protection of her Atlantic coastline, could turn with an easy mind to the Pacific and take such measures as she deemed expedient for the security of her Western seaboard and her insular possessions. Such an arrangement, we are told, would "naturally involve the renunciation of the idea of the Anglo-Japanese Alliance." That, apparently, is the sole obstacle in the way of a compact which in our judgment would be infinitely more effective as a preservative of peace than the League of Nations. If a naval agreement on the lines indicated could in any sense be construed as a menace to or a betrayal of Japan, honor would forbid our accepting it. But the Japanese know as well as we do that their legitimate interests would be promoted not prejudiced, by an Anglo-American understanding of this nature. As a fact, judging by the comments of the

press, the alliance has long since ceased to enjoy popularity in Japan, and it is doubtful whether its denunciation would cause a single tear to be shed in that country.—*The Naval and Military Record*, June 22, 1921.

**OIL FUEL IN THE NAVY.**—As engineers in general, and marine engineers in particular, are quite familiar with the advantages of oil fuel for the propulsion of warships, and the remainder of the community has lately been most forcibly reminded of some of the drawbacks of coal, little serious opposition to the Admiralty's decision to build only oil-burning ships in future was to be expected. The matter was discussed on Tuesday last when the House went into Committee of Supply on Navy Estimates, in connection with the vote of £5,836,600 for works, buildings and repairs at home and abroad. A considerable proportion of the proposed expenditure under this heading is to be incurred in the construction of tanks at various naval centers in this country to provide storage for a reserve of oil fuel for our warships. Such a provision is obviously essential for the future efficiency of the navy, and though it involves considerable expenditure at a time of serious financial stringency, we are of the opinion that the expenditure is fully justified. The sum allocated in the present estimates for oil storage at home amounts to £657,600, of which £388,000 will be spent on the new depot at Plymouth. The total estimate for the construction of this depot is £1,400,000, and £265,000 has already been spent on it, leaving £747,000 to be voted in future estimates.

Additional oil storage accommodation is being provided on the *Clyde* in the Glasgow district, and a sum of £201,000 will be spent on this work during the year, while £2,430 is required for the oil fuel installation and pipe line now approaching completion in the same district. In the Rosyth district it is proposed to provide oil storage at Grangemouth on which £80,000 will be spent in the current financial year, while a further sum of £10,670 is allocated to the work in hand at Port Edgar. For similar work in progress at Portland, a sum of £145,500 is required, and at Pembroke it is proposed to commence work which will involve a total expenditure of £480,000; of the latter sum only £40,000 is voted for the current year. With regard to the proposed expenditure on oil storage facilities abroad, the Civil Lord, Mr. Eyres-Monsell, was careful to explain that the provision made was intended to meet the peace requirements of our ships on the ordinary ocean routes; strategic requirements, he stated, would probably be discussed at the forthcoming Imperial Conference.

The oil-fuel now under construction at Malta will have cost £308,000 before completion, while the cost of similar work at Gibraltar, including the construction of a pipe line, will be £311,800. Work at both these depots is in hand, but is not very advanced in either case; the expenditure during the current financial year is estimated at £77,600 and £76,200, respectively. Storage accommodation at Hong Kong and Port Said will be finished during the year by the expenditure of £65,000 and £43,650, respectively, while that at Jamaica will be nearly completed by a further expenditure of £21,340.

Of the new work decided on, the most important is that at Singapore, the total cost of which will be £250,000 but only £50,000 of this is to be spent during the current year. A similar sum is required this year for work to be commenced at Rangoon, the total cost of which is estimated at £150,000. Storage facilities are also to be provided at the Cape of Good Hope, the Falkland Islands, and Sierra Leone. The total cost of the first-mentioned proposal will be £90,000, and £42,000 of this will be spent during the year. The total costs of the other two depots mentioned will be £75,000 and £65,000, respectively, and £10,000 will be spent on each of them this year. Overseas oil-storage accommodation thus accounts for a total sum of £445,890 in the current estimates.

The only important points raised in the debate on the estimates was the question of adequate defence of the depots against hostile action, and this, we think, may safely be left in the hands of the naval authorities. The vote, which was agreed to, also includes the expenditure of about £100,000 on what may be regarded as welfare work, its object being to improve the arrangements for the comfort and well-being of naval ratings in dockyards.—*Engineering*, May 27, 1921.

### JAPAN

**TO CLEAR PACIFIC WAR-MISTS.**—In time of peace prepare against war, is the new reading of an old saw introduced by Japan and the United States in their decision to sit down and reason out points at issue between the two countries, which fire-eating militarists and publicists in both lands envelop in dangerous war-mists, subject to explosion. Such is the comment in some quarters on the conversations of Secretary of State Hughes and Baron Shidehara, Ambassador from Japan, having for their ultimate object, say Washington dispatches, the negotiation of a treaty or agreement between the two governments which will cover perhaps a dozen matters now in dispute. Among these occupation of various territory in the Far East and the Japanese land and immigration questions in the United States. In addition, we are told, there is the question of the island of Yap and cable rights in the Pacific, but it is pointed out that settlement of this question will be distinct from settlement of the others, "inasmuch as it involves the rights and privileges of France, Great Britain, and Italy as well as of Japan and the United States." Thus the negotiations between the two governments fall into two classes—those concerning only Japan and the United States and those concerning other nations as well. What is more, Washington dispatches report that the American Government will not participate in the deliberations of the latest Council of the League of Nations now at Geneva, because this country and Japan are having a cleaning-up time of their own. Among the Japanese press there is occasional complaint that America's attitude is "open to question in the light of international law and diplomatic precedent," and the Tokyo *Kokumin* suggests that the Harding Administration had "better abandon its present stand and recognize all the facts relating to the Paris Conference, endeavoring to take part in the Peace Treaty and the League of Nations Covenant," for even—

"If it is difficult for America formally to join the Treaty, she may make a declaration of a tenor similar to its provisions and thus publicly pledge herself not to deviate from them. This is a means of maintaining international confidence in her and, indeed, is a condition precedent to her diplomatic activity."

The *Kokumin* turns to the partial evacuation of Siberia, which was decided upon by Premier Hara and General Tanaka, the War Minister, "by themselves alone," and add.

"The militarists have been kicked over. They may be resentful, but that is a sign of the times.

"Evacuation is at least one year overdue. For this reason the people have been compelled to waste over 100,000,000 yen. Japanese evacuation from Siberia was urged by America, demanded by public opinion in this country, and informally approved by the government itself. . . . .

"In any case, the decision of the present government to carry out evacuation without much further delay, if not immediately, almost without any conditions, may be considered an expiation on its part for its past sins."

Of Shantung the Tokyo *Yamato* tells us of a reported proposal that Japan "withdraw all the garrison from Tsing-tao and abandon the project for the establishment of an exclusive Japanese settlement, only succeeding to the rights formerly possessed by Germany." Though this newspaper

professes inability to vouch for this report, it believes it would be advisable to open negotiations with China if the Shantung question can be settled that way, because—

"There has never been greater need of Chino-Japanese cooperation than at present. It is inimical to the interests of both Japan and China that they should be at loggerheads at such a moment. Moreover, America is inclined to interfere in the negotiations of Japan and China, and in a certain contingency the question may become further complicated. It is very desirable, therefore, that direct negotiations should be opened between Japan and China. We should be grateful to America for her anxiety, but in the present state of affairs there is a Monroe Doctrine in Asia as there is in America. If America is to be bothered for Asiatic affairs, especially matters relating to Japan and China, the consequences may be mutually unpalatable. It may be for the purpose of bringing American pressure to bear on Japan that China is trying to enlist the support of America, but will it not damage the interests not only of China but of Asia as a whole if the seed of evil is now sown impulsively?"

"Japan has no ambition whatever. The conditions which she proposed for the return of Shantung were due to doubt whether peace and order could be secured in Shantung, and also to apprehension lest the rights to be abandoned by Japan should pass into the hands of a third country. If China is fully prepared on the two points, we believe that Japan will not insist on the original conditions."

Even for the purpose of domestic politics, the Tokyo *Jiji* believes Japan should adopt a new policy, though it admits that so important a matter as Chinese and Siberian policy "should not be exploited for the purpose of serving temporary political ends," and this daily proceeds:

"The fact is, however, that this is the best opportunity for deciding a new policy. Let us advise the government fundamentally to renovate its policy with great determination. Above all, it is necessary that double diplomacy should be done away with. Its evils are clear to everybody. Indeed, military diplomacy should be held responsible for the fact that troops have not yet been withdrawn from Siberia, the Chinese Eastern Railway zone, and Shantung.

"There may be various circumstances and designs accountable for the refusal of the Chinese Government to entertain Japan's proposal to open direct negotiations, but it is perhaps necessary that Japan should immediately withdraw her troops from Shantung in order to demonstrate her sincerity to the world. It is evident that Chinese suspicions regarding Japan, which form an obstacle to Chino-Japanese diplomacy, are due principally to the diplomacy of the militarists."

As to the Californian issue, the *Japan Chronicle* calls attention to an article by Count Soyeshima, in the *Japanese Diplomatic Review*, in which he declares that it is purely "a Californian issue" and "can not be a cause of war between the two nations." The Californian problem can be settled "as a local issue," he believes, and urges his fellow citizens not to "risk national fortunes over a question which does not menace our country." In other states the Japanese are comparatively favorably treated, according to this personage, who adds:

"In California, too, there is no reason why the Japanese immigrants should be subjected to so much opposition and persecution. Even according to the report of the committee for the investigation into the conditions of Japanese immigrants, composed exclusively of American citizens, 'they are well educated, they are eager to learn English, they have a high standard of personal cleanliness, they are generous in their relations with others, and they are generally temperate.' In fact, the Californians are benighted, deficient in the sense of justice, and impervious to reason, but while Japan has the absolute right to protest against their benightedness, their injustice,

and their unreasonableness, and it is further necessary that she should resolutely assert and enforce this her right, it would be absurd for Japan to stake her national fortunes on a local issue like this. Though it is held by some people that the Californian complication is nothing but an expression of American Imperialism and a conflict of the national policies of the two powers, yet in my opinion the trouble is a domestic one. Nor is it racial or religious, as some people think. So long as Japan and America do not come into a great conflict on the Asiatic continent, the Californian problem can be amicably settled as a local issue. It is not wise to risk national fortunes in a war over a question which does not menace our country. At every new phase of the Californian problem, there are some irresponsible politicians who refer to Bushido and otherwise have recourse to boastful language. But this is very thoughtless of them. On the occasion of national danger, incitement and instigation may be in place, but it is unwise to employ violent language to the prejudice of sound diplomacy when the question can be quietly and peacefully settled."—*The Literary Digest*, July 2, 1921.

**JAPAN EMPLOYS BRITISH AIR EXPERTS.**—Tientsin, June 27.—Japan's naval program includes not only the capital ships, of which mention has been made so frequently, but an abundance of minor craft and particular submarines, destroyers and seaplanes. Japan to-day has three air squadrons of six hydroaeroplanes each. The program being rushed to conclusion calls for fifteen squadrons of six machines each. These will be based at the three great naval stations and in Formosa, where a great base has been established near the lower end of the island, only a few hours from the Philippines.

There have arrived in Japan 86 aviation experts who have seen service in the British Army or Navy. In all, 100 such Britishers have been employed as instructors by the Japanese Naval Department. They include both pilots and mechanical experts. These men are brought here from England at Japan's expense and are paid 1500 yen (\$750) a month, in addition to light, heat and quarters allowances, according to a naval authority. A great shop for the manufacture of motors and airplanes is being erected in Nagoya.

Major Wynder, representing Vickers, Ltd., has been in Japan for some time and is selling Japan a large amount of aircraft material. The aviators who have come from England are headed by Lieut. Col. Cecil H. Mears.

They include among other well-known officers of the late British air force Lieut. Commander Todd, Majors F. B. Fowner, H. C. Bradley, B. M. Dodds, Captains A. H. Ellis and A. Hillis and a large number of men who held the rank of lieutenant.

Coincident with the arrival of the British airmen there have arrived in Japan from Germany five experts from the House of Zeiss and six from the Goerz factory. These also are paid 1500 yen and allowances monthly. They are to manufacture periscopes and range finders for the Japanese navy and to train and supervise Japanese workmen in the branch.

A force of experts from the Short Brothers Airplane Manufacturing Works is teaching the Japanese how to assemble the eight airplanes of the F-5 class recently purchased by Japan from that plant. This type of machine is of the seaplane style, with a wing spread of 110 feet and body of 50 feet. It has two motors of 350 horsepower each and can remain in the air with six passengers for 10 hours.

Major Dodds said that these machines were equipped with the Eagle VIII type of engines from the Rolls-Royce plant. The Average speed is 80 miles an hour and the oil tanks hold sufficient for 10 hours' flight at maximum speed, thus giving a range of 800 miles. The machines are being assembled at the Yokohuka station.—*The N. Y. Times*, June 28, 1921.



## UNITED STATES

## NAVY DEPARTMENT—BUREAU OF CONSTRUCTION AND REPAIR

VESSELS UNDER CONSTRUCTION, UNITED STATES NAVY—DEGREE OF COMPLETION,  
AS REPORTED JUNE 30, 1921

Type, number and name	Contractor	Per cent of completion			
		July 1, 1921		June 1, 1921	
		Total	On ship	Total	On ship
<i>Battleships (BB)</i>					
44 California .....	Mare Island Navy Yard.....	98.0	98.0	97.	97.
45 Colorado .....	New York S. B. Cpn.....	75.4	73.5	73.1	71.3
46 Maryland.....	Newport News S. B. & D. D. Co.	99.5	99.3	99.2	98.9
47 Washington .....	New York S. B. Cpn.....	67.3	60.8	65.	58.5
48 West Virginia.....	Newport News S. B. & D. D. Co.	57.	48.2	54.1	44.4
49 South Dakota.....	New York Navy Yard.....	32.2	25.7	30.5	22.3
50 Indiana.....	New York Navy Yard.....	29.8	22.7	28.	20.7
51 Montana.....	Mare Island Navy Yard.....	26.1	17.3	24.4	15.2
52 North Carolina.....	Norfolk Navy Yard.....	35.8	26.6	32.3	23.1
53 Iowa.....	Newport News S. B. & D. D. Co.	26.3	22.6	23.	19.
54 Massachusetts.....	Beth. S. B. Cpn. (Fore River)..	8.6	3.0	6.4	.9
<i>Battle Cruisers (CC)</i>					
1 Lexington .....	Beth. S. B. Cpn. (Fore River)..	21.1	12.3	18.7	9.2
2 Constellation .....	Newport News S. B. & D. D. Co.	11.5	9.	10.5	7.7
3 Saratoga .....	New York S. B. Cpn.....	24.2	15.4	22.4	13.4
* 4 Ranger.....	Newport News S. B. & D. D. Co.	2.0	0.8	1.8	.7
5 Constitution.....	Philadelphia Navy Yard.....	9.2	5.7	7.7	4.
6 United States .....	Philadelphia Navy Yard.....	9.2	5.2	7.7	4.
<i>Scout Cruisers (Light Cruisers CL)</i>					
4 Omaha.....	Todd D. D. & Const. Cpn.....	93.0	84.7	92.1	83.4
5 Milwaukee.....	Todd D. D. & Const. Cpn.....	90.5	82.1	89.2	80.9
6 Cincinnati.....	Todd D. D. & Const. Cpn.....	84.4	77.0	81.7	74.1
7 Raleigh.....	Beth. S. B. Cpn. (Fore River)..	59.7	41.5	56.7	38.8
8 Detroit.....	Beth. S. B. Cpn. (Fore River)..	59.8	41.6	56.6	38.7
9 Richmond.....	Wm. Cramp & Sons Co.....	67.	45.	66.	40.
10 Concord.....	Wm. Cramp & Sons Co.....	64.	42.	63.	37.
11 Trenton.....	Wm. Cramp & Sons Co.....	47.	30.	45.	25.
12 Marblehead.....	Wm. Cramp & Sons Co.....	45.	27.	43.	22.
13 Memphis.....	Wm. Cramp & Sons Co.....	39.	24.	37.	19.
<i>Auxiliaries</i>					
Fuel Ship No. 18, Pecos.....	Boston Navy Yard (Oiler AO 6)	97.2	97.	88.	87.5
Repair Ship No. 1, Medusa (AR 1).....	Puget Sound Navy Yard.....	63.6	48.1	62.4	47.7
Dest. Tender No. 3, Dobbin (AD 3).....	Philadelphia Navy Yard.....	64.8	64.5	62.3	62.
Dest. Tender No. 4, Whitney (AD 4).....	Boston Navy Yard.....	28.9	21.9	25.	16.5
Sub. Tender No. 3, Holland (AS 3).....	Puget Sound Navy Yard.....	20.2	4.2	17.8	2.5
Aircraft Tender, Wright (AZ 1).....	Tietjen & Lang.....	80.	....	76.	....
<i>Patrol Vessels</i>					
Gunboat No. 22, Tulsa (PG 22).	Charleston Navy Yard.....	69.2	50.5	67.7	48.

\* Battle Cruiser No. 4—Keel laid 6/23/21.

In addition to the above there are under construction 4 destroyers, 5 fleet submarines, and 37 submarines.

Authorized but not under construction or contract 12 destroyers, 7 submarines and one transport.

## MERCHANT MARINE

TO RESCUE OUR MERCHANT FLEET.—Albert D. Lasker may not know the difference between the starboard bow and a marlinspike, as the *Baltimore Evening Sun* suggests, but dozens of editors laud his courage in giving up extensive business interests to accept the chairmanship of the Shipping Board, after the honor of handling its tangled affairs had been declined by several others. "The work of salvaging the government fleet from ruin and decay, in view of American shipping laws, American construction and operating costs, and American export conditions, will not be child's play," notes the *New York Herald*, "but the country has every reason to feel confidence in the ability of Chairman Lasker to do the thing if it is in anybody's power to do it." "The questions before the Board are the knottiest that confront any government agency," asserts the *New York Times*, and if Mr Lasker fails to solve them, "it will be his first failure in which supposed sea and trade Solomons also have failed," remarks the *Baltimore Sun*.

"The fleet can be put on a paying basis, and I can operate it at a profit," was the astounding dispatch that was sent from Mr. Lasker's home city, Chicago, to a New York paper as the new chairman left for Washington, but, upon telegraphic inquiry, Mr. Lasker assured *The Digest* that he was misquoted. "What I said was that the President wanted a basis established for a permanent and profitable American merchant marine to be developed through private initiative and enterprise," the new chairman telegraphed. Thus Mr. Lasker is seen to be in full accord with President Harding's policy, as outlined in a dispatch from the *Baltimore Sun's* Washington correspondent:

"1. That the business of ship operation be turned over to private interests with as little delay as possible.

"2. That the deficits must be stopped.

"3. That the Shipping Board shall make an appraisal of the assets of the government under its jurisdiction and charge to the war every liability that cannot be made useful and profitable."

"The first step of the new Board will be to formulate a policy, and the second will be to take the government out of the shipping industry," is the positive statement of George Rothwell Brown, writing in the *Washington Post*. "President Harding is taking a direct and personal part in the impending liquidation of the largest single business in the world today, and a highly important policy which can not fail to have far-reaching and beneficial results has been outlined," adds Mr. Brown. The withdrawal of the government from merchant shipping will require at least three years, he thinks. As we read on in *The Post*:

"It is to be the helpful intention of the administration which the new Shipping Board is destined to become such an important part, to correlate the merchant marine with American commercial expansion with port development, and all the other factors which are essential to a country's economic stability and development. Its plans are marked by breadth and vision.

"It is not to be expected that these things are to be brought about at once by the waving of a magician's wand; that cannot be. The processes necessarily must be slow. It is the purpose of the government that this part of the national structure shall be built up on a solid foundation.

"An asset which cost \$3,000,000,000 could hardly bring to-day more than \$750,000,000. This, also, is authoritative. The taxpayers will have to make up their minds that the enormous sum represented by the difference will have to be charged off on the ledger of patriotism as a part of the cost of the successful war against Germany, precisely as have been thus charged off the cannon, the guns, the ammunition, and the airplanes with which the war was won."

This is rather hard on American taxpayers, many editors agree, "but it is only what the merchants of the country have been compelled to do during the past few months in readjusting their war-time operations to a peace-time basis," notes the *New York Commercial*. "We have had the Treasury Department and the Federal Reserve Board telling the people of the country that their business enterprises must be deflated, yet the government itself, engaging in what is essentially a private business, has hitherto refused to face the issue," maintains this business organ.

"After being in a position near the bottom of the list of the great seafaring nations we are once more near the top, and our Shipping Board crews are 80 per cent American, whereas four years ago they were only 10 per cent American," we are told by the *Marion Star*. What to do with the fleet of steel and wooden ships, however, "is a question that has perplexed even the experts in the shipping business," says the *Chicago News*. Here is part of Mr. Lasker's statement, made after he had accepted the chairmanship:

"American industry and finance can not exist on the scale to which it has been created unless foreign markets are opened and remain open. American commerce must compete successfully on the seas with the commerce of the world.

"The constructive end of the Shipping Board's work is to inaugurate and put in being a policy that will accomplish this. To this end it must call into cooperation other departments of the government, all those interested in merchant marine and the manufacturers and financiers of the country. The President has said that the inspiration of private initiative and enterprise must be the guiding principles of the Board's work.

"It will be the first duty of the Board to do those things which are necessary to end incompetence and make of the Shipping Board a business institution guided by business principles and measuring up to business standards. The charge on the public treasury must be cut down, and that with all possible expedition, so that this burden on the taxpayers will be alleviated."

"At the end of May 684 steel ships (about one-third of this country's steam and oil tonnage) were laid up," declares the *New York Times*. "So many are idle that expenses run to \$20,000,000 a month," is the startling announcement of the *Baltimore News*, and the *Boston Herald* notes that "there are 275 wooden vessels on the hands of the Shipping Board, and the care of them costs the government \$440,000 a year." What to do with them is one of the new chairman's problems. "Far better to give them away if they can not be sold, or to burn them if they cannot be given away," thinks the *Philadelphia Inquirer*.

"The taxpayers of the United States must pay a stiff price for the procrastination of their government," writes Ernest Cordeal in the *Transportation World* (New York); "two years ago the government might have come well out of its investments in ships and shipyards, but to-day it must take a heavy loss. And the longer it delays in disposing of its interests, the greater will be the loss." "If the Shipping Board had not been prevented by the Hearst injunctions from putting ships on the auction-block a year or more ago, and had it not held them at too high a valuation, the government might have cut its losses materially," declares the *New York Tribune*. Now, it adds, "the only way to avoid throwing good money after bad is to sell all the ships than can be sold and to stop operating the others." "The American public is tired of government coddling and nursing; it will not tolerate the ship-subsidy talk that has been going the rounds," agrees the *New York Journal of Commerce*.

"The merchant marine should not be entirely in private hands," thinks the *Washington Post*, "although the ships may be privately operated." As

the *Providence Journal* sums up the four-year régime of the Shipping Board:

"When all is said and done, the foundation has been laid for an American merchant marine. It has cost extravagantly, but the excess over what it is now worth may be absorbed in time. It has been an expensive experience, but has afforded a convincing demonstration of the shocking waste possible, even inevitable, to government ventures into the field of business. There is compensation in that. The educational value of the experience should serve us well, into the far future. At any rate, we have made a big beginning and there can be no thought of turning back."—*The Literary Digest*, June 25, 1921.

AMERICAN MARITIME POLICIES.—In his address before the Eighth National Foreign Trade Convention, Mr. James A. Farrell made the following points: One, no sale at present of government vessels to private owners; two, our steamships are well constructed and compare with the best abroad; three, the average cost approximates that of foreign ships; four, even with temporary improvements in freights it will take three years to absorb the world's idle tonnage; five, international agreement to stabilize rates and lay up tonnage might be useful; six, American traders and travelers should use American ships; seven, we should abandon the attempt to build up trade routes from every United States port and serve only ports where cargo is available; eight, Time-charter Shipping Board vessels with option of purchase; nine, operating costs must be reduced to equality with foreign costs; ten, shipping laws which impose a disadvantage estimated at five per cent on investment should be repealed.—*The Scientific American*, July 2, 1921.

SHIPPING TROUBLES.—We have before us an analysis by the editor of the *Shipping World* of the discouraging conditions which existed in the British Merchant Marine in the spring of the present year. It is the statement of one of the world's best authorities on shipping matters, and all that he says of conditions three months ago may be repeated with greater emphasis to-day. One cannot read this material without being struck by the fact that like causes have produced like effects on our side of the Atlantic. In commenting on the report of the Liverpool Shipping Association, attention is drawn to the fact that though the ship-carrying power now available in the world is sufficient to deal with a larger volume of overseas traffic than was handled in 1913, and the needs of Great Britain as a consumer are greater than ever before, yet in 1920 the overseas commerce of the United Kingdom was in weight 19 per cent below, and the exports 56 per cent below those dealt with in 1914. To-day, of course, the situation is considerably worse than that. In 1920, although the British tonnage available was at least equal to, and the foreign tonnage available was far in excess of, that afloat in 1913, there was used in the overseas trade of the United Kingdom in 1920 ship-carrying power only in the proportion of 80 against the 100 employed in 1913. Furthermore, although more ships were employed, under the present conditions it is taking five ships to do the work that was performed by four ships in 1914.

Bearing in mind conditions in the deep sea trade in this country, there is something familiar in the British analysis of their own troubles. We are told that the advance in wages has raised the cost of production and transport, making it impossible for the British to sell their exports in foreign markets. We are assured that, in the main, it is the advance in food prices which has brought about such an advance in wages. Take note also of the fact that they have reached the maximum traffic which can be dealt with through the ports working under prevailing conditions, and unless those conditions can be altered, it will be impossible to import only five-sixths of the overseas supplies of food obtained under pre-war conditions. Hence follow scarcity and high prices; continued demands for high wages to meet those prices; a cost of production which makes selling of manufactures

and coal in foreign markets an impossibility; constant curtailment of production; a decrease in exports; and last, a further and inevitable reduction in imports. Thus the whole thing runs in an endless circle, and it can truly be said that, with modifications due to local conditions, we are passing through a similar experience. The principal modification as between us and Great Britain is the question of exchange; but of our merchant marine, as of theirs, it is true that the greatly increased costs of operation constitute a severe handicap. Indeed, in this respect we are in a more parlous state than they; this for the reason that our impossible laws—the burden laid upon our shipping by the suicidal LaFollette Act—renders successful competition on a common rate basis out of the question.—*The Scientific American*, June 25, 1921.

**INTERNAL-COMBUSTION ENGINES FOR SHIPS.**—The American Society of Naval Architects and Marine Engineers have recently been discussing the relative merits of oil engines as against steam engines for the propulsion of cargo vessels. The subject was brought before them by a paper entitled "The Internal-Combustion Engine as Applied to Marine Propulsion," read by Messrs. John F. Metten and J. C. Shaw at their meeting on May 26 last, in New York. The authors appeared to be far from satisfied with the development of the motor ship in America as compared with the progress made in Great Britain and the Scandinavian countries, and pointed out that the country found itself in the possession of a large government-owned fleet, almost wholly steam-driven, which private owners were reluctant to purchase or operate. The advantages of the internal-combustion engine were taken for granted, and the question was presented as to whether it would be preferable to convert some of the existing steam vessels or to build new motor ships. No direct answer was given to this question, the authors devoting themselves principally to the question of the relative costs of operating comparative vessels of 13,000 tons deadweight capacity and 3500 shaft horsepower, one driven by geared turbines and the other by Diesel engines. The steamer was supposed to burn oil in the furnaces. Very complete estimates were presented, which may be summarized by saying that the motor ship was calculated to earn 16.65 per cent on the capital invested as against 10 per cent in the case of the turbine vessel. The *William Penn*, a vessel of 12,375 tons deadweight, the first large oil-driven vessel to be owned by the United States Shipping Board, has a pair of six-cylinder Diesel engines, of 3500 shaft horse-power, the bore of the cylinders and stroke being 740 mm. and 1150 mm. respectively. The vessel will have a service speed of 10.5 knots to 11 knots and will be operated over the same route and by the same company as the electrically-driven ship *Eclipse*, recently put into service. This should enable very useful comparative figures to be obtained, and we may fairly presume that in due course they will be published, in accordance with the open-minded policy which is characteristic of American engineers.—*Engineering*, June 17, 1921.

**PROGRESS IN MOTOR SHIPBUILDING.**—This article gives extracts from the returns of "Lloyd's Register of Shipbuilding" for the past month. Throughout the world there are at present actually under construction 189 motor ships of 750,000 tons d. w. c., or 454,502 gross tonnage. Of these 57 are being built in the United Kingdom, of gross tonnage 227,010, represent half the total tonnage being built. The proportion of motor ships to steam ships being built in this country is considerably less than abroad, though it is rapidly increasing. These figures do not include a large number of motor ships which have been recently ordered in this country and abroad, but the construction of which has not yet commenced. They also do not include vessels building in Germany, the number of which is considerable. Details are given in tabular form of the tonnage of motor ships being built in various shipbuilding centres in this country and abroad. (*Motor Ship*, London, Feb., 1921.)—*The Technical Review*, June, 1921.

## AERONAUTICS

**AIRSHIPS AND STEAMSHIPS.**—In pursuance of the policy announced in the House of Commons on the introduction of the Air Estimates, it was officially intimated at the beginning of last week that unless a firm offer to take over and operate the existing airships in this country for commercial purposes were received by August 1, the Air Ministry would discontinue all airship activities, and would hand the vessels, stations and material to the Disposal Board. It may be recalled that the government has offered to present, free of any charge, to a suitably constituted British commercial airship company the three airships *R-33*, *R-36* and *R-80*, the ex-German airships *L-64* and *L-71*, and the airship *R-37*, on which, when nearly completed, work was suspended. With the exceptions of the ex-German airships, these vessels are fitted with bow-mooring arrangements, while one of them—the *R-36*—is fully equipped for the carriage of passengers. The government is also prepared to make a free gift to the proposed company of all of its spare engines and other airship material and stores, to assist the company with all available information, to lend it for a period any airship specialists required, and to lease or sell to it the Cardington and Pulham air bases as they now stand. This offer, involving, we believe, the gift of over one million pounds' worth of material, has been before the country for some months, and has, we know, been the subject of much discussion among people likely to be interested in the commercial operation of airships. That no one so far has shown any inclination to do anything more than discuss it is a clear indication that, in the opinion of those concerned, the commercial operation of airships is unlikely to yield a sufficient return in the present state of the art and in the prevailing conditions affecting transport services in general. Is that view justifiable, and, if so, on what particular point or points connected with the operation of an airship service can be established?

Assuming—and it is a large assumption—that there is a public awaiting the advent of the commercial airship service, we may endeavor to obtain some guidance as to the commercial prospects of such a service by comparing the qualifications and performance of the existing passenger airship *R-36* with those of an ocean-going passenger steamship. It is not easy to select the particular marine vessel that may justly be compared with the airship. A steamship of the size and speed of the *Mauretania* is well known, under present conditions, to be uneconomical, and as a basis of comparison may be expected to show the airship in a too favorable light. On the whole, we are of the opinion that a steamship of the size and speed of the *Carmania* is probably the least exceptionable standard that can be adopted. That vessel is certified for 1995 passengers, and carries a crew numbering 513. Allowing her four weeks for the round voyage to America and back, and assuming that she runs all the year round and on each trip carries 100 per cent of her capacity, she is capable of transporting 51,870 passengers per year. The airship *R-36* is fitted with accommodation for 50 passengers and carries a crew of 28. With her speed of 65 miles an hour she ought to perform the round trip in seven days. Running with full capacity all the year round, she should thus be capable of carrying 5200 passengers per year. It therefore appears that so far as passenger-carrying capacity is concerned, ten airships of the *R-36* class are equivalent to one *Carmania*. Total horsepower of the engines of these ten airships would be 15,700; that of the main engines of the *Carmania* is 21,000. The aggregate crews of the ten airships would be 280; the crew of the *Carmania* numbers 513. In both these important respects, therefore, economy is distinctly on the side of the airship. This result is, we feel, surprising, for economy in any respect is not generally associated with aerial transport. Stated generally, it means that for the same total passenger-carrying capacity over a given period of time, the airship, on the same average factor of passenger load-

ing, is 25 per cent more economical in power expenditure than the steamship, and 45 per cent more economical in the matter of crew. This very favorable result must not, however, be accepted at its face value; it has to be tempered by several considerations. In the first place, it has to be observed that the higher the speed of a vessel the greater is the strain thrown upon it and its crew. It is not impracticable to run the *Carmania* voyage after voyage at four-week intervals with the same crew. But in the case of the airship the time in port is reduced in proportion to the increased speed on the trip, and would be far too short to effect running repairs and to rest the crew. On the London-Paris air route, we believe, it is not found practicable or desirable to fly back the aeroplane leaving on a Monday before the following Friday, or even the Monday of the next week. The trans-Atlantic steamship service could be maintained at least for a time by means of one *Carmania*. The corresponding airship service could not, it is certain, be maintained for any time whatever by means of the ten airships indicated by our calculation. Four additional airships would absorb all the economy in the matter of power expenditure, but it may be doubted whether anything short of 100 per cent reserve of craft and crew would be sufficient to meet the conditions. In the second place, the question of upkeep has to be considered. There are elements in this matter which it must be admitted are distinctly in favor of the airship. There is, for instance, the fact that the total airship carrying capacity need not be reduced, at any instant, for the purposes of drydocking by more than 10 per cent, whereas with the steamship service nothing less than the whole can be withdrawn. On the other hand, in the matter of engine upkeep, there can be no doubt on which side an overwhelming advantage lies. At present not more than 30 to 40 horsepower per cylinder can be developed in an aero-engine. The ten airships required to provide the equivalent of the passenger-carrying capacity of the *Carmania* would thus have between them 400 cylinders, at 800 valves, 100 magnetos, and a corresponding multiplicity of fuel and water pumps, radiators, sparking plugs, etc. It must be admitted that by comparison the engines of the *Carmania* are simplicity itself. Even to-day, in spite of the improvements that have been effected in the construction of aero-engines, the limit of running time between complete overhauls does not by much exceed 200 hours. Thus in the present state of development the engines of the airship service would require to be completely overhauled at the end of every second round trip. Actually, for the ten airships, the separate engine overhauls required would work out at the rate of 1,300 per year. Another important item in the upkeep bill would be the replacement of the hydrogen lost on the voyage, an item against which we have nothing to put in the case of the steamship service. Taking the loss at as low a rate as 5 per cent of the capacity per round trip, the annual replacement quantity required comes out at no less than 55 million cubic feet per year for the ten airships. There is thus indicated the provision of hydrogen generating plant capable of producing on the average 150,000 cubic feet per day.

Even from an outline analysis such as we have presented above features emerge which clearly suggest the need for the utmost caution before a definite opinion is formed as to the commercial prospects of the airship. Our analysis, we know, is very short of being complete, but so far as it goes it fails either to prove or disprove the case for such craft. Some will, no doubt, hold that the apparent economy of engine power and crew shown by the airship is of much importance than the apparent lack of economy in upkeep. Others, probably, will heartily disagree with that view. For ourselves, we would urge that the question should be looked at as a whole and apart from the free gift from the government of the existing airships and material. Capital cost will have to be considered sooner or later if the service established is to remain in force successfully. Then, too, we should consider the airship not solely as a pas-

senger-carrier, but also or alternatively as a means of transporting goods. The question of terminal charges should also be brought within the scope of the comparison. In these and other matters the advantage seems at times to be on the side of the airship and at times against it. At other it is next to impossible to form a sound judgment where it lies. Thus, in the matter of terminal charges, the economy of ground *personnel* rendered possible by the use of mooring masts seems to place the advantage with the airship. In the matter of the carriage of goods the reverse appears to be the case. Thus, even the *Mawretania*—a less commercially efficient vessel than the *Carmania*—can carry 1000 tons of goods apart from her passengers' luggage. In the same proportion the *R-36* airship should carry nearly 30 tons of freight in addition to her passengers. Actually, when fully loaded with her 50 passengers, she cannot take anything beyond 2½ tons of personal luggage. On the matter of capital cost we have no data to guide us, for all the airships so far constructed in this country have been built more or less on an experimental basis. On a production basis we can only rely on estimates, and therefore introduce an additional element of uncertainty into our calculations. It may be added, however, that from inquiries we have made it would appear that in the matter of capital cost the balance of advantage would probably fall on the side of the airship service. Altogether, then, the commercial prospects of the airship are at present hard to determine, so hard, in fact, that we shall not be surprised if the allotted period goes past without the receipt by the government of the offer it desires for its surplus airships and material.—*The Engineer*, June 10, 1921.

**THE LIMITATIONS OF AERIAL BOMBING.**—Naval officers point out that there have been appearing in the press with increasing frequency erroneous statements respecting the cost of battleships as compared with aircraft. It is also claimed that aerial bombs are more destructive than gun projectiles, because such bombs contain a larger percentage of explosive than armor-piercing shells of the same size. The statements most frequently made with respect to costs are that 1000 airplanes can be constructed for the cost of one present-day battleship; that each plane can carry a bomb of sufficient power to sink a battleship; and that the airplane requires a personnel of only two or three men, whereas the battleship requires 800 or more.

In the first place present-day cost of battleships, due to lower prices, is less than \$45,000,000; but granting the cost to be that sum, and that such a battleship could be used for the first line for a period of 15 years, and the second line for 10 years, at an annual up-keep cost of \$1,000,000, the cost of the battleship for 25 years would be \$70,000,000, or \$2,800,000 yearly. Granted that 1000 planes can be built for \$45,000,000—which, on account of the diversified types required by complete naval air force, seems hardly possible, inasmuch as planes of the larger type cost considerably more than \$45,000 each, including their equipment—it should be borne in mind that the life of a plane in service is approximately two years. Hence, the entire cost of the planes must be again spent each succeeding two years, or 12½ times during the life of a battleship; and inasmuch as not less than 50 per cent on the average, of the first cost of a plane is required to keep it in commission for two years, the total cost of 1000 planes for 25 years would be \$843,750,000, or \$33,748,000 per year, a sum sufficient to keep in commission 12 battleships of the present-day type.

Furthermore, in the matter of personnel, naval officers do not agree with the printed statements. A battleship such as contemplated would have a crew of 1500 officers and men instead of 800, while in the case of airplanes, for every man in the air there is required approximately 20 on the ground. On this basis, 12 battleships would require 18,000 officers and men, and 1000 airplanes, on the basis of one man in the plane and 20 on the ground,



would require 21,000 personnel. To be perfectly fair in the matter, it may be considered that the personnel of the two would about cancel each other in cost, inasmuch as highly skilled mechanics are required on battleships and aircraft alike. In the case of landing fields and hangars for 1000 aircraft, we may also consider that the expense is canceled by docks and navy yards required for the repair of battleships. That brings the case down to a comparison of material cost, and, as above stated, 1000 aircraft stretched over a period of 25 years, which is the extreme life of a battleship, would equal the cost of 12 such battleships.

Regarding the statement that aircraft could each carry a bomb sufficiently large to destroy a battleship, it is not believed that at the present day this can be done. Bombs have not been developed to such an extent that they are armor-piercing, and after landing on the deck of a ship their destructiveness would be local. The experiments on the U. S. S. *Indiana* with a large bomb filled with T. N. T. which was exploded on her deck, causing considerable damage to her old-style upper works, has been used as an illustration of what bombs can do, and statements have been made that if the bomb were destructive when laid on the deck, it would be much more so if dropped from an airplane. This is erroneous. The destructiveness of T. N. T., unconfined, has a certain potentiality which is not increased by the mere dropping of the T. N. T. from a height. *It is necessary for the projectile to pierce the armor of the ship and explode inside of her hull.* This cannot be done by thin-walled aerial bombs subject only to the impulse of gravity. There must be acceleration beyond the force of gravity to cause the shell to pierce armor and the shell must be of the armor-piercing variety; consequently, the weight of the shell wall reduces the amount of T. N. T. which it may contain, reducing the destructiveness of the bomb.

It is believed that the actual facts should be given the public. Erroneous comparisons which only bring out one side of the argument do not help the cause of aeronautics but do more harm than good.—*The Scientific American*, July 2, 1921.

## ENGINEERING

THE TEACHINGS OF EXPERIENCE.—It has been noted as curious and characteristic that a committee appointed before the war by the German Government to report on specifications for steel bridges did not include amongst its members a single engineer having experience in the behavior of structures under traffic. The committee was constituted entirely of professors and designers of structural steelwork, all no doubt being well versed in the art of computation. Such an equipment is, however, far from adequate to successful design, as has been repeatedly demonstrated in practice, a notable instance being the failure of the giant cranes supplied to Panama. Computation must, in short, be constantly checked by an unceasing study of the behavior in service conditions of structures and engineering products generally. Such studies are even more important in the case of moving machinery than in that of structures. In the latter case the loads and stresses are generally reasonably well defined and are static rather than dynamic. When stresses are dynamic we meet with singular anomalies. Turbine designers, for example, tell us that they have found it advisable to limit the working stress on rotor shafts to some 5000 pounds per square inch, although the component in question is very simple in form and the torque transmitted is almost ideally steady. It is not, therefore, surprising that builders of high-speed engines were at times almost driven to declare that no rational rule could be found for proportioning their crankshafts. In the case of slow-speed machinery failures have been less mystifying, but it has been generally recognized that in all cases an empirical element entered into their design. It was this consideration that gave such value to those reports in which Mr. Michael Longridge was accustomed to describe the investigations into

machinery failures made by him in his capacity as chief engineer to the British Engine, Boiler and Electrical Insurance Company. This annual commentary on power plant pathology was extremely valuable to the designer, who thus obtained an authoritative statement as to what had actually happened in accidents, of which he might possibly have heard rumors, or even been supplied with some particulars by the workmen engaged on the repairs. Particulars thus obtained are, however, commonly very apt to be misleading as the purveyor of them is seldom content to report his actual observations, but having formed his own theory as the cause of a breakdown, colors his communications accordingly.

The discontinuance of Mr. Longridge's reports was a distinct loss to engineering literature, and the hiatus has not yet been filled. Though there are other societies engaged in the insurance of machinery not one of their engineers has ventured to play the part of "Elisha" to Mr. Longridge and take up the mantle dropped from his shoulders.

Mr. Stromeyer's annual memoranda to the Manchester Steam User's Association, highly interesting as they are, cover a much narrower field, being concerned almost wholly with the construction and behavior of boilers and steam pipes. In the latest of these memoranda, Mr. Stromeyer discusses at considerable length the value of hydraulic tests. Such tests appear very convincing to those lacking practical experience, and it appears that in some countries, such as Russia, yearly tests of this kind had to be applied under official supervision to every boiler in service. From the standpoint of the official the practice had no doubt much to commend it, as a properly-conducted boiler inspection is at best an unpleasant job; whilst a government inspector superintending an hydraulic test need neither remove nor protect his uniform. Moreover, from the owner's standpoint the preparations for such a test involve much less expenditure of time and trouble than does the preparation of a boiler for a proper inspection. Where, however, such an inspection is possible an hydraulic test is at the best superfluous, often misleading, and at times actually harmful. Mr. Stromeyer quotes many instances in which disastrous explosions have occurred very shortly after the application of what was thought to be a satisfactory hydraulic test. In these cases he holds that quite probably the test was a contributory cause to the final failure, having extended pre-existing cracks so that they have afterwards become through fractures, under the "breathing" of the material concomitant to actual service.

With new material there is less danger of such *sequelae*, and most boiler builders like to apply the test to new boilers, though it is quite possible that the satisfaction with which they regard a favorable issue has little logical foundation. As Mr. Stromeyer points out, no practical man thinks of submitting ship's structure to any acceptance test, though we may note that at the *Titanic* inquiry one of the counsel engaged seemed to think the omission a reflection on the builders, not realizing its absolute impracticability. In ship construction reliance is of necessity placed on careful design and workmanship, yet the stresses to which ship structures are subjected are much higher than are admitted in boiler practice. Mr. Stromeyer claims accordingly that the hydraulic test should be abandoned in the case of boilers, and in this he is certainly logical, although we are not inclined to give an unqualified assent to all his contentions. If we understand him correctly he takes the view that an occasional application of an excessive load will permanently diminish the working life of a structure subject to fluctuating stresses, so that the application of one hydraulic test may do as much harm as thousands of repetitions of normal working pressures. We are inclined to think that experience hardly bears this out. Locomotive boiler shell plates, for instance, are bent cold and not subsequently annealed. The material has thereby been undoubtedly subjected to very excessive stresses, yet experience seems to afford no reason for believing

that the working life of such boilers would have been increased had cold bending been dispensed with. Again, many bridges are apparently subjected to occasional excessive stresses due to the change of temperature between summer and winter, yet there is no evidence on record of a collapse attributable to this.

An interesting point raised in the report is the action of superheated steam on cast-iron pipes and fittings. Failures due to this are becoming increasingly common and are no doubt attributable to lack of experience with superheated steam. It was, we believe, Outerbridge who first called attention to the "growth" of cast-iron at high temperatures. The matter has been experimentally investigated by Professor Carpenter, who has confirmed the fact previously discovered by steam turbine builders that the phenomenon depends largely on the composition of the iron, being due to the oxidation of the silicon. Mr. Stromeyer reports that many failures have occurred with cast-iron bends and valves at temperatures considerably below the limit noted in Professor Carpenter's experiments, and he makes the very probable suggestion that the metal of a pipe being stressed, chemical action occurs more readily than it otherwise would do. It is, in fact, well recognized that the corrosion of non-ferrous metals may be greatly hastened by stressing the material, and it is a fair presumption that cast-iron follows a similar rule. As already mentioned, much depends on the composition of the iron and some engineers claim to have produced a growth-free cast-iron, whilst others have turned to steel.

We note that the Manchester Steam Users' Association is revising its code of instructions to boiler attendants, and a draft of their new issue is included in Mr. Stromeyer's memorandum. Many of the points dealt with are elementary, but cannot be neglected on that account since it frequently happens that both stokers and owners are lamentably ignorant of the first principles of boiler management. One piece of advice in this code is likely to arouse the ire of smoke abatement enthusiasts, who are accustomed to declaim that smoke means waste. The actual fact is that unless smokeless fuel be used the greatest efficiency is obtained when there is some light smoke. With ordinary coal a complete absence of smoke means that an excessive amount of air is passing through the flues and carrying away with it an abnormal amount of heat. Dense smoke is, of course, equally uneconomical.

We note one curious slip of the pen in the memorandum where, on page 11, the remark is made that "the higher the pressure the greater the difference of temperature for equal differences of steam pressure." Of course, the exact reverse is the case, but at times an author's pen, with the inmate malignity of many inanimate objects, takes control, and leads him to say the exact opposite of what he had in his mind. Such slips often escape correction in proof because the author reads what is in his mind and not what is on the paper.—*Engineering*, June 10, 1921.

**PETROL ENGINE EFFICIENCY.**—The whole subject of the efficiency of petrol engines was brought during the war into great prominence on account of the application to fighting aeroplanes, in great numbers and high powers, of this type of prime mover. This led investigators thoroughly to review the thermodynamic conditions which govern performance in the hope of finding some modifications of the cycle which would provide higher powers and greater economy. There are only two obvious ways of increasing the power output of a reciprocating engine, namely, either by increasing the mean effective pressure on the piston, or by an augmentation of the piston speed. So far as piston speeds are concerned, the limit is reached when the inertia forces of the reciprocating masses stress, to within a reasonable percentage of their elastic limits, the best high-tensile steel available for such parts as the connecting rods and the bottom end bolts. Reduction in the weight of reciprocating masses, the use of aluminum pistons, &c., have increased this limit, and possibly higher speeds can still be successfully

sustained, although the margin for improvement in this particular direction cannot but be extremely small.

As regards increasing the m. e. p., the safe limit is reached when the heat flow attains to a figure above which troubles are encountered. Recently we dealt very fully with this question in connection with large marine Diesel engines in our article on "Tendencies in Marine Oil Engine Practice," and it is interesting to find this point again so fully emphasized, where the smaller petrol type of engine is concerned, in the paper on "Some Experiments on Supercharging in a High-Speed Engine," read by Mr. Harry Ricardo, B. A., at the Institution of Automobile Engineers on the 12th inst. It is well known that if, with a petrol engine, the mixture strength be reduced, the thermal efficiency more nearly approaches that of the standard air cycle. As the mixture strength is decreased the maximum temperature is reduced. In ordinary practice, the weakening of the mixture of petrol and air below a figure of from 85 to 90 British thermal units per cubic foot, is not possible. Mr. Ricardo again enunciates his theory of stratification of the combustible charge, and discusses means whereby the mixture in the way of the sparking plug is made of sufficient strength to ensure ignition and support combustion, which will heat up and cause expansion on cooling of the remaining air entrapped in the cylinder. In a series of tests which were carried out during 1913-14 there was used a highly efficient single-cylinder vertical engine. The power output of the engine was controlled entirely by the quantity of fuel separately admitted through the suction valve, so that, at all times and under all conditions, the full air charge was taken into the cylinder, and it was found possible to reduce the mean mixture strength from the normal mixture strength of 85 British thermal units per cubic foot, down to 10 British thermal units with perfectly regular running. It was found further that the engine could be started at all times, even on the coldest day, on the first pull over, and that when running light with an indicated m. e. p. of only about 14 pound per square inch, the exhaust was almost inaudible, the speed of the engine remaining absolutely uniform, and the indicator diagrams extraordinarily consistent. On opening the needle valve and increasing the fuel, the engine would immediately accelerate even from the lowest speed of 120 r. p. m. The results of efficiency obtained approximate very nearly to the theoretical limiting efficiency, and at a mixture strength of 10 British thermal units per cubic foot were almost 80 per cent of the theoretical. The gain in efficiency by working with such rare stratified charges, enables a consumption of fuel per indicated horse-power per hour of approximately 0.37 pound to be maintained, from 20 i. h. p. up to 60 i. h. p., rising to 0.45 at 120 i. h. p., thus proving conclusively the correctness of the basis of the theory.

The second part of the research work described fully in this paper concerns the retention of the idea of stratification to reduce the temperatures of the cycle, together with supercharging to bring up the horse-power output, and a special engine was constructed for this purpose, containing the well-known Ricardo supercharging piston. The cycle of operations was as follows: During the suction stroke the piston drew from the carburetor a charge of petrol vapor and air of a normal proportion. Towards the end of the stroke the ports round the lower end of the cylinder were uncovered and a charge of air, compressed in the crosshead chamber to a pressure of about 12 pound per square inch, entered the cylinder. Simultaneously with the opening of these supercharging ports, the main inlet valve in the cylinder head was closed. This supplementary air for supercharging from the crosshead chamber raised the pressure of the cylinder contents to about 5 pound per square inch above atmospheric pressure, and assisted at the same time towards stratification by forming a layer above the piston. The actual indicator diagram of this part of the cycle closely approximates to the theoretical aimed at. In this way at the end of

the suction stroke the contents of the cylinder consisted of about 70 per cent of combustible mixture of normal strength (viz., about 95 British thermal units per cubic foot) and about 30 per cent of air, the normal mixture being concentrated in the neighborhood of the sparking plug. The mean mixture density of the whole of the cylinder content was therefore about 66 British thermal units per cubic foot. On the exhaust stroke supercharging similarly took place, since the underside of the piston operated as a two-cycle air pump, and the second supply of cool air entering through these ports assisted in lowering all the temperatures of the cycle. Careful analysis of the various losses was made by motoring round the petrol engine. The total frictional losses, including windage, were equivalent to a mean pressure of 11.5 pound per square inch on the main piston when running supercharging. The fluid pumping losses in the cylinder were 3.5 pound per square inch., and those in the crosshead chamber 4.5 pound. The object of these tests was to obtain high outputs with low temperatures and with maximum economy, which at that time was the problem confronting designers of motors for aeroplanes. Quite early in these trials it was found that the liability to detonate was the limiting factor. Very little was then known on this subject.

Reference at this stage may be made to the paper by Mr. H. T. Tizard read before the North-East Coast Institution of Engineers and Shipbuilders, on the 11th inst., on "The Causes of Detonation in Internal-Combustion Engines." It is now generally known that the cause of this phenomenon, sometimes called "knocking," "pinking" or "detonation," in an internal-combustion engine is not in any way mechanical in nature. The influences of the shape of the combustion head and of the nature of the fuel are alone sufficient to dispose of this idea. It can perhaps be said with safety that detonation occurs when the rate of rise of pressure in the cylinder exceeds a certain unknown limiting amount. Mr. Tizard gives a considerable amount of information in regard to the importance of the nature of the fuel on the tendency to detonate, it being well-known that liquid hydrocarbons of the paraffin series such as heptane, for instance, show the greatest tendency in this direction. Maximum flame temperature also has an important bearing on the subject perhaps only secondary to the nature and quality of the fuel employed. However, the figures given in this interesting technical research, indicate that in the high compression engine, the compression temperature approaches very nearly to the ignition temperature before the spark passes, and it is worth recalling in confirmation, that when high compression aero engines are switched off, it often occurs that they continue to run a considerable time by preigniting the charge.

Mr. Ricardo, with his engine, carried out a number of alterations to overcome detonation:—the fitting of intercoolers between the supercharging chamber under the main piston and the ports in the main cylinder walls, altering the timing of the cylinder head exhaust valve, and using the Ricardo masked valve for the inlet of the mixture. The result of these modifications, as debated, is interesting. The final solution by which the best results were achieved, shows that the stratification of the charge of mixture and air, instead of being carried out by means of air from the supercharging chamber, is very much more efficient when cooled exhaust gases are used for this purpose, detonation also being eliminated by this means up to the highest power achieved. It was therefore arranged that exhaust gases should be used for the supercharge. The top of the piston was made concave further to encourage the supercharging air or gas to form a layer above the main piston. Detonation was checked even at compressions of 5.1 to 1 and up to 6 to 1, at which latter figure, however, so much gas had to be added to the supercharge, that the maximum power output was decreased. During normal running at 2000 r. p. m., the maximum brake horse-power was 20.6, with 99 pound per square inch brake mean effective pressure. The fuel consumed per brake horse-

power hour was 0.535 pound and the indicator thermal efficiency was 30.9 per cent. By supercharging the brake horse-power was raised to 29.6 and the maximum brake mean effective pressure to 141 pounds per square inch, while the fuel consumption was reduced to 0.47 pound and the indicator thermal efficiency was increased to 33.7 per cent. Whilst these figures are in no way remarkable, as admitted by the author, in the light of present-day knowledge of the subject, it must be remembered that the engine upon which this work was carried out, is by no means a new one, having been designed seven years ago, and that the combustion head with valves in a side pocket is not the form to give either the best power or the highest economy. There is no doubt, however, that the improvement made and the figures given indicate that this line of research, if further pursued, should result in extraordinarily high efficiencies. It is hoped that further researches, which are understood to be under way, will in due course bear the fruit which they promise. The subject is one of particular interest where aeroplane engines are concerned, since this method of stratification and supercharging tends very successfully to correct the reductions in power to which normal petrol engines are subject at very high altitudes.—*Engineering*, May 27, 1921.

**GRAPHIC CALCULATION OF THE CRITICAL SPEED OF SHAFTS.**—The author refers to the lengthy and tedious calculations required for determining the safe speed of shafts having cranks and other revolving weights attached, and describes a method adopted during the war in connection with shafts in German submarines where whirling speeds approaching 7000 per minute were used.

The deflection caused by each revolving mass is plotted and the amplitudes determined by means of a polar diagram and a funicular polygon. Small adjoining masses can by this means be treated as one mass. A curve is then drawn through the points thus determined when the whirling stress in the shaft at various speeds can be read off.

The weight of the balancing mass which varies inversely with the number of revolutions must be determined next. By plotting the number of revolutions as abscissa and the deflective strains found from the first diagram as ordinates a descending curve is obtained which gives the balance weight required for any given number of revolutions.

Special diagrams are shown for finding the amplitude of the internal vibrations of the shaft itself, whilst three tables give the formulæ used for determining the moments of inertia of the crank, crank\*arms, crank pins, and other vibrating masses on the revolving shaft.

The result of the graphic calculations are very exact and in close agreement with the results from actual tests. (Fr. Sass, *Zeitschrift des Vereines deutscher Ingenieure*, Jan. 15, 1921.)—*The Technical Review*, June 14, 1921.

**SINGLE-COLLAR THRUST BEARINGS.**—The principle of the single-collar bearing lies in the fact that a rocking pad, which is pressed against a lubricated surface in motion, takes a position as to form a wedge between itself and the surface. This wedge is filled by the lubricant and no contact between the pad and the surface takes place, even if high pressures are exerted. With multiple collar bearings of the general fashion there is always a certain amount of contact between the gliding surfaces, as these lie parallel one to the other. In annular bearings, the shaft is always a little smaller than the boring. Therefore there is only contact in one line, when the parts are at rest. When moving, the lubricant is drawn through this line of contact, and the contact disappears, so that there is only oil friction. This difference between thrust bearings and annular bearings made the thrust bearing much inferior to the annular bearing, and the drawback has been overcome by the single-collar bearing, where

all direct contact between gliding parts has been eliminated. The figures for friction and permissible pressure of different kind of bearings are given as follows:

	Annular bearings	Multiple collar thrust bearings	Single collar thrust bearings
Coefficient of friction.....	0.004-0.010	0.020-0.030	0.001-0.0015
Permissible pressure lb. per sq. in. ....	.....	.....	.....
Normal conditions.....	200-300	40-60	200-500
Special conditions if well lubricated	700	120	800

The experience made with marine single-collar bearings led to the adoption of pivoted and adjustable supports of the pads instead of rocking edges. Instead of adjusting each pad, devices have been introduced to distribute the pressure uniformly on all pads. The center of pressure on each pad has been found to be about 0.58 of the total length of the pad from the entering edge. In order to have a good slope of the lubricating wedge the support should be placed at about 0.66 of the total length of the pad. But it has been also shown that a good rounding of the entering edge of the pad draws the center of pressure nearer to this edge; therefore, if a bearing is used for an engine running ahead and astern, the point of support can be placed at the middle of the pad, if both edges are well rounded. A good many different constructions of single-collar bearings are shown, such as are used for general merchant marine use, for ships of high power, for turbines, reciprocating steam-engines and motors, also for men-of-war and a special construction which has been used for German *U*-boats. Details of cooling arrangements, stuffing boxes, and methods of lubrication, are given. (Dr. Ing. Commentz, *Werft und Reederei*, Jan. 22, 1921.)—*The Technical Review*, June 14, 1921.

#### CURRENT NAVAL AND PROFESSIONAL PAPERS

The Strength of Submarine Vessels. *Engineering*, May 27, 1921.

Submarine Warfare. *Journal of the Royal Artillery*, May, 1921.

Searchlights Against Naval Targets. *Journal of the U. S. Artillery*, July, 1921.

Research in the Foundry. *Engineering*, June 27, 1921.

The Disposition of China. *National Service*, July, 1921.

The Relationship of the Press and the Army in the Field. *The Journal of the Royal Artillery*, June, 1921.

The Application of Radio to Navigational Problems (W. H. G. Bullard). *Journal of the Franklin Institute*, June, 1921.

The Essentials of an Engineering Education. *Mechanical Engineering*, June, 1921.

# NOTES ON INTERNATIONAL AFFAIRS FROM JUNE 10 TO JULY 10

PREPARED BY

ALLAN WESTCOTT, Professor, U. S. Naval Academy

---

## UNITED STATES

**PEACE RESOLUTION ADOPTED.**—Following agreement upon a compromise peace resolution by the House and Senate Conference Committee, the House on June 30 passed the resolution by a vote of 263 to 59. The resolution on July 1 was passed by the Senate by a vote of 38 to 19 and sent to the President for his signature.

The compromise resolution begins as follows:

“Joint resolution terminating the state of war between the Imperial German Government and the United States of America and between the Imperial and Royal Austro-Hungarian Government and the United States of America.

“That the state of war declared to exist between the Imperial German Government and the United States of America by the joint resolution of Congress approved April 6, 1917, is hereby declared at an end.

“Section 2.—That in making this declaration, and as a part of it, there are expressly reserved to the United States of America and its nationals any and all rights, privileges, indemnities, reparations or advantages, together with the right to enforce the same, to which it or they have become entitled under the terms of the Armistice signed Nov. 11, 1918, or any extensions or modifications thereof; or which were acquired by or are in the possession of the United States of America by reason of its participation in the war or to which its nationals have thereby become rightfully entitled; or which, under the Treaty of Versailles, have been stipulated for its or their benefit; or to which it is entitled as one of the principal allied and associated powers; or to which it is entitled by virtue of any act or acts of Congress, or otherwise.”

Sections 3 and 4 make identical provisions with regard to peace with Austria-Hungary. Section 5 provides that all property of the German or Austrian Government or their citizens in the possession of the United States shall be retained until all claims against those governments shall be satisfied.

**BORAH DISARMAMENT AMENDMENT PASSES HOUSE.**—On June 29, following an appeal from President Harding to Congress for an expression of opinion favorable to limitation of armaments, the House by a vote of 330 to 4 adopted the Borah Amendment to the Naval Appropriations Bill requesting that the President invite Great Britain and Japan to a conference on reduction of naval expenditures. The amendment reads:

“That the President is authorized and requested to invite the Governments of Great Britain and Japan to send representatives to a conference



which shall be charged with the duty of promptly entering into an understanding or agreement by which the naval expenditures and building programs of said Governments—the United States, Great Britain and Japan—shall be reduced annually during the next five years to such an extent and upon such terms as may be agreed upon, which understanding or agreement is to be reported to the respective governments for approval.”

**BILL TO REFUND ALLIED DEBT.**—Washington, June 23.—The Administration bill to enable the refunding of the obligations of the foreign governments to the United States, amounting to more than \$10,000,000,000, was introduced in the Senate to-day by Senator Penrose, Chairman of the Finance Committee. The bill is intended to clothe Secretary of the Treasury Mellon with sweeping authority to refund the obligations of the foreign governments and to adjust claims of the United States against foreign governments. It is broad enough to permit the Secretary of the Treasury to receive bonds and obligations of “any foreign government” in substitution for those now or hereafter held by this government.

Senator Penrose introduced the bill at the request of President Harding, who in turn acted at the instance of Secretary Mellon. Senator Penrose gave the measure his indorsement and announced that the Finance Committee would give a public hearing to Secretary Mellon and Treasury experts next Wednesday morning at 10.30.—*N. Y. Tribune*, June 23, 1921.

Washington, June 23.—The debts of foreign governments to the United States, as shown in tables accompanying Secretary Mellon's letter to the President, are:

Country	Amount owing
Great Britain .....	\$4,166,318,358
France .....	3,350,762,938
Italy .....	1,648,034,050
Belgium .....	375,280,147
Russia .....	192,601,247
Poland .....	135,661,660
Czechoslovakia .....	91,179,528
Serbia .....	51,153,160
Rumania .....	36,128,404
Austria .....	24,055,708
Greece .....	15,000,000
Estonia .....	13,999,145
Armenia .....	11,959,917
Cuba .....	9,025,500
Finland .....	8,281,926
Latvia .....	5,132,287
Lithuania .....	4,981,628
Hungary .....	1,685,835
Liberia .....	26,000
Total .....	\$10,141,267,585

**DUTCH REFUSE OIL CONCESSIONS.**—The Hague, June 23 (Associated Press).—The Dutch Government to-day made public its reply to the American Government's note of May 27 protesting against the policy of the Netherlands with respect to the exploitation of the Djambi oil fields in the Dutch East Indies.

The Dutch Government, the note said, was unable to admit that its bill passed by Parliament closing the Djambi fields to participation by Americans in the oil industry, was contrary to the principle of reciprocity. This theory, it declared, arose from the supposition that after Djambi there would be no more oil fields in the Dutch Indies to exploit. Moreover, the Dutch Government objected to its policy toward foreign nations being

represented as less liberal than that of the United States. The contrary, the note said, was rather the case.

In any event, the note declared, a country pursuing a policy of carrying out real reciprocity could not obtain its object by decreeing unilaterally some sort of régime depriving subjects of countries not adopting identical measures of rights connected with the matter concerned.

**JAPANESE IN UNITED STATES.**—The racial composition of the population of the United States in 1920, as announced recently by the Census Bureau, shows the country to contain 94,822,431 white persons, 10,463,013 negroes, 242,959 Indians, 111,025 Japanese, 61,686 Chinese and 9,485 others. The Japanese race exceeded by far the rate of growth in the last ten years of all other classes.

Unofficial estimates of the increase in the number of Japanese in the United States, particularly on the Pacific Coast, were borne out in the official tabulation, which revealed a rate of expansion of 53.9 per cent during the decade of 1910-1920. California absorbed 30,596 of the total growth of 38,868 Japanese in this period. On Jan. 1, 1920 there were 71,952 Japanese in California. The remainder of the increase was distributed largely in the States of Washington, where 17,388 now make their home; Oregon 4,151 and Utah, Colorado and New York with between 2,000 and 3,000 each.

The white population showed only a 16 per cent expansion for the decade and the negro 6.5 per cent. The Indian and Chinese groups dwindled 8.6 per cent and 13.8 per cent respectively.

#### UNITED STATES AND LATIN AMERICA

**MEXICAN OIL DECREES ENFORCED.**—On July 1 President Obregon's recent decrees became effective which repealed the law of 1917 and put in force increased export duties on petroleum. According to a statement made by the Standard Oil Company, these taxes amount to practically 100 per cent of the value of the product. The Standard Oil Company suspended operations following the enforcement of the decrees, and it was expected that other companies would do the same. According to a provision of President Obregon's decrees, companies closing down without justification must indemnify employees.

The Mexican Chamber of Deputies on June 29 dropped discussion of Article XXVII of the Mexican Constitution relating to oil concessions, indicating that no changes in the law would be made during this session of the chamber. Two American naval vessels, the cruiser *Cleveland* and gunboat *Sacramento*, arrived in Tampico on July 8, as a protection to Americans in the event of trouble over the shut down of oil operations, but they were subsequently ordered to their regular stations.

**PANAMA APPEAL DISREGARDED.**—Washington, June 30.—After consideration of the appeal presented by the Garay Mission from Panama, Secretary Hughes has decided that the United States cannot recede from its position that the White award in the boundary dispute between that country and Costa Rica must be accepted.

Senor Narciso Garay, Foreign Minister of Panama, who headed the mission, called at the State Department this afternoon and it is understood that he was then told of the decision.

Senor Garay, in his presentation of Panama's objections to the White award, suggested that a league of American nations be formed and asked

to mediate the dispute between Panama and Costa Rica. If this plan proved impracticable, it was suggested that the United States might bring pressure to bear upon Costa Rica to accept the Panama view. A third proposal made by Garay was that Panama and Costa Rica get together through the good offices of the United States and reach a new understanding. All these suggestions seemed not feasible, in the opinion of Mr. Hughes.

The United States gave Panama two months to accept the White award. The time limit will expire July 2 and it is expected that an announcement of acquiescence will be made soon. If no announcement is made acquiescence may be indicated by the appointment of a commission of engineers to co-operate with a similar commission of Costa Rican engineers in delimitation of the boundary.

**NICARAGUA WOULD JOIN FEDERATION.**—Tegucigalpa, Honduras, July 3.—The Federal Council of the Central American Republics, comprising representatives of Salvador, Guatemala and Honduras, has given out a communication from the Nicaraguan Foreign Office, in which Nicaragua urges that the signatories of the Compact concluded recently at San Jose, Costa Rica, take action toward a settlement of the obstacles which have prevented Nicaragua from becoming a member of the Union. Nicaragua proposes that the members of the union name conditions to form a basis for negotiations.

Nicaragua's step comes as a complete surprise, as that country flatly rejected the Central American Treaty and retired from the San Jose conferences. Nicaragua explained that she could not agree to Salvador's demand that Nicaragua abrogate the Bryan-Chamorro treaty with the United States, on the ground that the treaty violated the Constitution of the Central American Federation.—*N. Y. Times*, May 7, 1921.

**REASSURANCE TO SANTO DOMINGO.**—On June 28 the U. S. State Department issued a supplementary explanation of the recent proclamation regarding the withdrawal of American military forces from the Dominican Republic. The explanation points out that the Dominican delegates to negotiate a treaty are to be selected by the Dominican Congress as soon as it is elected; and that the stipulation that all acts of the Military Government shall be ratified before withdrawal is essential to insure recognition of financial obligations by the new government. The validating stipulation does not mean, however, that the regulations of the Military Government shall be continued as the law of the republic.

### GREAT BRITAIN AND IRELAND

**ATTEMPTED NEGOTIATIONS WITH IRISH LEADERS.**—Following the royal opening of the Ulster Parliament, Premier Lloyd George on June 25 sent letters to the Ulster Premier Sir James Craig and to Eamon de Valera, President of the the Sinn Fein Irish Republic, making "a final appeal in the spirit of the king's words for a conference with representatives of Northern Ireland and Southern Ireland to explore to the utmost every possibility of settlement." Sir James Craig, after summoning the Ulster Cabinet, accepted the invitation and was in London on July 5. Mr. de Valera made a non-committal preliminary reply on June 28, stating that he wished first to hold a conference of Irish leaders in Dublin. At this conference, opened at the Mansion House in Dublin on July 4, de Valera and Arthur Griffith, the founder of Sinn Fein, were present, and also four

Southern Unionists. Later Lord Middleton, one of the Unionists at the Conference, went to London. General Smuts came to Dublin on July 5 and entered into negotiations with de Valera.

**DE VALERA AGREES TO CONFER.**—On July 8 Mr. de Valera sent the following letter accepting Premier Lloyd George's invitation to a conference:

"Sir: The desire you expressed on the part of the British Government to end the centuries of conflict between the peoples of these two islands and to establish relations of neighborly harmony is the genuine desire of the people of Ireland.

"I have consulted with my colleagues and received the views of the representatives of the minority of our nation in regard to the invitation you have sent me. In reply I desire to say that I am ready to meet and discuss with you on what basis such a conference as that proposed can reasonably hope to achieve the object desired.

EAMON DE VALERA."

The British authorities in Ireland declared a truce to begin on Monday July 11.

**BRITISH IMPERIAL CONFERENCE.**—The Imperial Conference of British Premiers was opened on June 20 by Premier Lloyd George. In his speech he paid tribute to the faithfulness of Japan as an ally and emphasized the importance of a satisfactory settlement of problems in the Pacific and Far East. Referring to disarmament he declared, "We are willing to discuss with American statesmen any proposal for the limitation of armaments that they wish to set out." General Smuts in a strong speech on June 21 emphasizing the need of world peace said, "the most fatal mistake of all would be a race of armaments against America." Lord Curzon on June 23 gave a full statement of the main lines of British foreign policy.

**ANGLO JAPANESE TREATY.**—Later sessions of the Imperial Conference, held behind closed doors, were devoted chiefly to the question of renewal of the Anglo Japanese Alliance. Arguments were advanced both for and against renewal, the Canadian premier speaking against and the Australian premier in favor of its continuance. In the meantime, according to notice given to the League of Nations by both powers, the treaty unless renewed would lapse on July 13. Arrangements were made with Japan, however, by which opportunity was afforded before definite renewal for fuller consultation with the dominion governments and also with the United States. Premier Lloyd George announced in Parliament on July 7 that he was awaiting replies to inquiries directed to China and the United States, but expected to make a full statement on the question by July 10.

**POSSIBLE CONFERENCE OF PACIFIC POWERS.**—London July 8 (Associated Press).—Great Britain, it was stated here to-day in a quarter usually possessed of reliable information is believed to have made overtures to the United States, Japan and China on the possibility of a conference to discuss the whole Eastern situation.

If this is correct, it is pointed out, it might explain what Mr. Lloyd George, the Prime Minister, meant when he stated in the House of Commons that he was awaiting replies from America and China before making a statement to the House Concerning the Anglo-Japanese treaty.

Official circles declined to comment on the nature of any communications with the United States, China or Japan, but it was said in those circles that it would be reasonable to assume that these countries would be fully sounded before Great Britain would show her hand.—*N. Y. Times*, July 9, 1921.

### ITALY

CHANGE OF CABINET.—The Giolitti Ministry resigned on June 27 following a vote in the Chamber on the Government Foreign Policy in which the government was supported by the narrow margin of 234 to 200. Opposition came from both extreme Nationalists and Socialists. Signor Bonomi, President of the Chamber, was requested to attempt the organization of a new cabinet, and on July 4 announced a ministry drawn entirely from parties of the center. Signor Bonomi takes the post of Premier and Minister of the Interior, and the Marquis della Torre becomes Minister of Foreign Affairs.

### LEAGUE OF NATIONS

COUNCIL MEETING AT GENEVA.—The thirteenth session of the Council of the League of Nations met at Geneva on June 17 and closed on June 28. Previous to the meeting, a note was sent to the United States calling the attention of that government to its failure to act on the invitation of the League to send American delegates to attend the discussion of Class A and B mandates.

VILNA DISPUTE UNSETTLED.—M. Paul Huymans, the Belgium representative, offered a settlement of the dispute between Poland and Lithuania on the basis that Vilna be made an autonomous district under an international military commission, the Polish troops evacuating the city and turning its protection over to a force of 5000 local militia. The two powers concerned, however, were unable to agree upon these terms, and the settlement is therefore left over until the meeting of the League Assembly in September.

ALAND ISLANDS TO FINLAND.—After a hearing of rival claims the League of Nations Council, confirming the report of the commission of which the American Abram I. Elkus was a member, on June 24 decided that the Aland Islands should remain under the sovereignty of Finland, but that they should be neutralized under guarantees to be agreed upon between Finland and Sweden, the two nations contending for control.

INTERNATIONAL COURT.—The League Council in June invited Messrs. Elihu Root, John Bassett Moore, Oscar S. Straus, and Judge George Gray to act as a committee to name four persons (not more than two Americans) as candidates for judges of the proposed international court of justice. The final choice of the eleven judges of the court will be made by the Assembly of the League in September. It is said that the two American candidates, if named, will certainly be chosen.

## AUSTRIA

SCANDINAVIAN BANKERS OFFER AID.—Paris, June 23,—A powerful group of Scandinavian bankers has come to the rescue of Austria and has agreed to provide the credits necessary for the rehabilitation of that country if the Allies will forego their indemnity claims on the Vienna Government for 20 years. Great Britain and France already have agreed to withhold their demands for that length of time, but Italy has not yet assented and is holding out primarily, according to reports here, in order to drive a better bargain with the Allied Powers. Italy wants a larger share of the German indemnity under the Treaty of Versailles than has been agreed upon and now is seeking to use the Austrian situation as a lever to gain her ends.

Italy's share of the entire German indemnity is 10 per cent. She thinks this should be augmented at the expense of the shares of other Allies if the Rome Government is willing to delay collection of its claims on Austria.

The Scandinavians decided to undertake the restoration of Austria after they had heard the report of a Danish banker, Glueckstadt, who investigated the situation. The plan they have worked out provides for the retirement of the paper money now in circulation in Austria and the issuance of new currency in limited amounts. The bankers demand liens on the country's internal revenues as a guarantee for the credits granted and insist upon other measures, all of which are acceptable to the Austrian government in its present plight.

With the growth of a policy in both England and France of not standing in the path of reconstruction in Europe, it is believed here that Italy will fall in line and will assent to the postponement of her Austrian claims. It is regarded as hardly likely that the Allies will yield to Italy any greater share of German indemnity moneys.

French acquiescence in the Scandinavian reconstruction scheme is in direct line with Premier Briand's recently announced policy of favoring assistance for both Germany and Austria wherever possible in order to assure the reconstruction of the continent. The French Premier believes that European peace depends upon the stabilization of international affairs.—*N. Y. Times*, June 24, 1921.

AMERICA ASKED TO POSTPONE CLAIMS.—Paris, July 1.—The Council of Ambassadors addressed to-day to the Government of the United States a note asking if America would agree to postpone for 20 years her claims against the Austrian Government. These claims, amounting to some \$20,000,000, relate to food relief advances.—*N. Y. Times*, July 1, 1921.

## FRANCE

LEIPSIK MISSION RECALLED.—Paris, July 8.—On the ground that the German trials of German war criminals are a mockery the French Government has withdrawn its mission to the Leipsic court, thus washing its hands of the procedure, and has notified the Allied Governments of its action.

It is understood that the French Government will ask the Allies to return to the Treaty plan and demand that Germany hand over the accused men for trial by Allied tribunals. It is not the purpose of the French Government to obtain the trial of some six or seven hundred accused Germans, but it believes that at least four or five prominent offenders should be punished for the sake of principle.

This move by the French Government was taken after the acquittal of General Stenger, accused by the French of having given an order to take no prisoners, and after insults to the French mission at Leipsic.—*N. Y. Times*, July 9, 1921.

## GREECE AND TURKEY

**CONSTANTINOPLE THREATENED.**—On June 19 the Allied Powers sent an offer to Greece to attempt mediation between the Greeks and Turkish Nationalists. King Constantine's Government found it impossible to surrender its aggressive policy in Asia Minor and still retain prestige. The offer was refused, but the long-prepared-for Greek offensive was indefinitely postponed.

Great Britain declared continued neutrality in the Greek-Turkish conflict, but notified the Turkish Nationalists that any attempt against Constantinople would be resisted by the Allies. A Greek squadron of 25 vessels was permitted to operate in the Black Sea cutting off supplies from Russia. On June 28 the Greeks evacuated Ismid on the railway only 56 miles east of Constantinople, thus making possible a Turkish advance toward Constantinople, and opening up a situation calculated to involve the powers controlling the straits.

**ATTITUDE OF ALLIES.**—Paris, June 30.—With the opening of the new Anatolian war between the Greeks and the Turkish Nationalists and following the evacuation without a fight of Ismid by the Greeks yesterday, the French Government, it is understood, to-day sent a note to the British Government asking what action London proposed if Kemal's troops marched on Constantinople, now held by British and French troops, with British and French warships in the roads.

The situation is just this: The Allied ships can prevent any passage of Kemal's men over into Constantinople. There is no question of that. But should the Allied garrison in Constantinople endeavor to block a movement by Kemal from Ismid toward the straits opposite Constantinople they would run grave danger of defeat. In these circumstances the French are inclined to believe the time is ripe for an understanding between England and France as to what they intend to do in the face of a possible attack.

There are a good many reasons for believing Kemal will not now try to capture Constantinople, because to do so against British and French resistance might force both nations, or at least England, to help the Greeks. However, possession of Constantinople is one of the planks of Kemal's platform, and it is possible, though not considered here strongly probable, that extremists might push an attack.

Tonight the *Temps* makes the highly important statement that at the discussion during the recent London conference of revision of the Sèvres Treaty the British Government agreed to a possible eventual evacuation of Constantinople by Allied troops with the establishment on the end of the Peninsula of Gallipoli of a sort of allied Gibraltar which would control the Straits. The *Temps* asks if the British Government is in that frame of mind now, for that would make a great difference should Kemal's generals think they could take the city.

The *Temps* says the French Government believes the Allies should firmly notify Greece that they wash their hands of the whole new war and that Greece must shoulder the entire responsibility alone since King Constantine will not agree to mediation. The French also wish a decision by the Allies that neither side may use any territory held by Allied troops as a base of operations. This naturally is aimed at the Greeks.—*N. Y. Times*, June 30, 1921.

## REVIEW OF BOOKS

---

“Professional Questions and Answers for Naval Officers.” By Lieutenant F. W. Wead, U. S. Navy. Price \$3.00. (George Banta Publishing Company.)

An exceptionally concise treatment by means of questions and answers for professional examinations for naval officers from ensign up to and including the rank of lieutenant commander. This compilation should, it is believed, prove beneficial to temporary and reserve officers when preparing for qualification for permanent appointment—also for officers of state naval units and for commissioned officers of the Shipping Board personnel.

The subjects treated are International Law, Military Law, Strategy and Tactics, Navigation, Ordnance and Gunnery, Seamanship, Electricity and Radio, and Steam Engineering. Their treatment is so concise as to preclude the use of the booklet as the sole means of preparation. One should be chary of appearing before the Examining Board with a too meagre background.

The booklet should therefore be regarded as an aid in preparing for examinations. The value of the compilation is dependent in a large measure upon the manner of using the booklet. In this light it is suggested that the use of the booklet should not lead one to desist from the usual thorough preparation with its attendant wide reading. With such a background the booklet may be profitably used for a quick review of the various subjects on the “night before” taking up the various subjects before the Examining Board.

For many officers the preliminary preparation for practical navigation is slow and tedious. The booklet offers no assistance here. Perhaps its inclusion in so concise a treatment would be impracticable and has been considered by the author. Yet, in all fairness to prospective users, the omission of practical navigation should be noted.

The booklet aims at brevity and conciseness and meets these conditions in an exceptional manner. As pointed out its use, with proper background of study, should qualify as a decided time saver in the preliminary preparation and should be of especial value for the “night before” brushing up.  
S. E. H.

“Handbook for Naval Officers.” By Commander F. V. McNair, U. S. Navy. Price \$4.00. (New York: D. Van Nostrand Company, 1921.)

The 1921 edition differs but little from the 1920 edition. In revision the chapters on steam engineering have been strengthened.



For those professional subjects such as military law, international law and seamanship which change but very slightly, if at all, from year to year, the treatment is of value. It is manifestly difficult for a book of this nature to keep fully abreast of subjects such as engineering, radio, fire control and gunnery, which are steadily undergoing a process of evolution. Aspirants should therefore carefully follow published articles in service journals and study departmental bulletins having to do with innovations of professional matter, subject to change.

Many officers because of the nature of their duties become rusty in practical navigation. To such the preliminary preparation for practical navigation is both slow and tedious. For this study there are no better text-books than Bowditch or Muir's *Navigation*, especially the 1918 edition of the latter. The problems given in this handbook are worked out in detail. The value of such problems would be enhanced were tabular extracts from the almanac to be included, thus affording practice in picking out the proper values and coefficients as must be done during the examination. Muir's *Navigation* does incorporate such data for the problems which it works out. The advantages gained from the inclusion of similar tabular data in this handbook should outweigh any difficulties since by selecting problems from the same calendar year, but one almanac need be consulted.

The handbook does not pretend to teach principles—and for complete knowledge of any one of the subjects treated, the student must necessarily seek treatises on the various specialties.

In preparing for a session with the Examining Board there is no "royal road" to success. The value of aids to preparation is dependent largely upon the manner of using them. After having made sure of a proper background with the usual thorough preparation, this handbook will be found a valuable digest of information and as such, it will be of material aid to the initiated for brushing up and to the uninitiated, may serve as a guide to study and practice.

S. E. H.

"A Manual of Marine Engineering." By A. E. Seaton. Price \$10.00. (New York: D. Van Nostrand Company.)

The purpose of this book, as stated by the author in the original preface in 1883, is "to supply the existing want of a manual showing the application of theoretical principles to the design and construction of marine machinery, as determined by the experience of the leading engineers and carried out in the most recent successful practice."

As regards the reciprocating engine, the book fulfills its purpose. It is a comprehensive treatment of the evolution of the reciprocating engine to its present form in the British Mercantile Marine and Navy, with occasional references to the installations and practices in other countries where a difference from British design exists. As regards the turbine and internal combustion engine, it presents enough of the fundamental ideas and details of these engines to enable the engineer to understand their essential char-

acteristics, and it puts him in such a frame of mind that he has a desire to acquire knowledge of the more recent developments not treated in this work.

The method of treatment is to show the historical steps and changes through which the machinery and its appurtenances have passed and the reasons why they are in their present forms.

The subject matter includes the thorough treatment of the following: resistance of ships, boilers, propellers, materials used in engineering, oil and lubricants, tests and trials, the fitting of the machinery into the ship, numerous tables of the performance of various ships, 60 pages of rules—Lloyd's, British Admiralty, British Board of Trade, etc.—governing the inspections, supervision, tests, strength or capacity of various materials and parts of the engineering plant. Practically every phase of marine engineering affecting design is dwelt upon and even the cost of some engineering materials before the World War is included.

The details of minor parts are not explained, but formulas for the size and strength of the main parts and the reasons for their shapes and forms are thoroughly presented. The cuts of a good many figures are considerably worn, but the general assembly and arrangement of the parts can be understood. A few names of parts are different from those used in the United States.

The exhaustiveness of the manual can be realized when it is known that there are 969 pages in it. To some who read it, the historical references and the numerous tables of results of trials of vessels may be wearisome. Whether there is unnecessary minuteness in the presentation of some of the subject matter will depend upon the stage of development of the engineering knowledge of the reader. In any case, to a real student of marine engineering, everything in it will be interesting and most of it will be profitable.

With a little resourcefulness, an engineer could probably design and build a marine engineering plant on the information, rules and formulas contained in the manual. He will acquire many ideas about the proper management of machinery because he will know and understand the purpose of all parts of it.

Inspectors of machinery, engineer officers of vessels building and overhauling, and all marine engineers, mercantile and naval, who need or desire to have a thorough grasp of their profession in its broader aspects should have some such book as this at least as a reference book. It will surely do for them what the author hopes it may do—tend to make clearer some of the technicalities of marine design and construction and help forward the application of *scientific investigation* to those problems which the marine engineer is called upon, day by day to solve.

J. S. B.

## SPECIAL NOTICE

### NAVAL INSTITUTE PRIZE ARTICLE, 1922

A prize of two hundred dollars, with a gold medal and a life-membership (unless the author is already a life member) in the Institute, is offered by the Naval Institute for the best original article on any subject pertaining to the naval profession published in the PROCEEDINGS during the current year. The prize will be in addition to the author's compensation paid upon publication of the article.

On the opposite page are given suggested topics. Articles are not limited to these topics and no additional weight will be given an article in awarding the prize because it is written on one of these suggested topics over one written on any subject pertaining to the naval profession.

The following rules will govern this competition:

1. All original articles published in the PROCEEDINGS during 1921 shall be eligible for consideration for the prize.

2. No article received after October 1 will be available for publication in 1921. Articles received subsequent to October 1, if accepted, will be published as soon as practicable thereafter.

3. If, in the opinion of the Board of Control, the best article published during 1921 is not of sufficient merit to be awarded the prize, it may receive "Honorable Mention," or such other distinction as the Board may decide.

4. In case one or more articles receive "Honorable Mention," the writers thereof will receive a minimum prize of seventy-five dollars and a life-membership (unless the author is already a life member) in the Institute, the actual amounts of the awards to be decided by the Board of Control in each case.

5. The method adopted by the Board of Control in selecting the Prize Essay is as follows:

(a) Prior to the January meeting of the Board of Control each member will submit to the Secretary and Treasurer a list of the articles published during the year which, in the opinion of that member, are worthy of consideration for prize. From this a summarized list will be prepared giving titles, names of authors, and number of original lists on which each article appeared.

(b) At the January meeting of the Board of Control this summary will, by discussion, be narrowed down to a second list of not more than ten articles.

(c) Prior to the February meeting of the Board of Control, each member will submit his choice of five articles from the list of ten. These will be summarized as before.

(d) At the February meeting of the Board of Control this final summary will be considered. The Board will then decide by vote which articles shall finally be considered for prize and shall then proceed to determine the relative order of merit.

6. It is requested that all articles be submitted typewritten and in duplicate; articles submitted written in longhand and in single copy will, however, receive equal consideration.

7. In the event of the prize being awarded to the winner of a previous year, a gold clasp, suitably engraved, will be given in lieu of the gold medal.

By direction of the Board of Control.

H. K. HEWITT,  
*Commander, U. S. N., Secretary and Treasurer.*

# United States Naval Institute

## Proceedings



The writers only are responsible for the contents of their respective articles

### CONTENTS

	PAGE		PAGE
The Results and Effects of the Battle of Jutland.—Frost . . . . .	1325	Discussion . . . . .	1417
The Engineering Officer-Personnel Problem.—McClintie . . . . .	1355	Secretary's Notes . . . . .	1420
Discipline.—Fenner . . . . .	1371	Professional Notes . . . . .	1423
Approximate Altitude and Azimuth.—Kielhorn . . . . .	1387	Notes on International Affairs . . . . .	1476
Gunnery and Turret Design.—Leary . . . . .	1393	Review of Books . . . . .	1485
Speeding up Communications.—Tisdale . . . . .	1413	Information Index . . . . .	1422

Copyright, 1921, by J. W. Conroy, Trustee for U. S. Naval Institute

Entered at the Post Office at Annapolis, Maryland, as Second Class Matter

# WORLD'S ONLY MAKER

Moulded High Frequency High Tension Insulators

POTENTIALS 1,000 ← TO → 1,000,000 VOLTS

Medal and Diploma  
received at  
World's  
Columbian  
Exposition,  
Chicago, 1893



REG. U.S. PAT. OFF. & FOREIGN COUNTRIES.

INSULATION  
MADE IN AMERICA

Louis Steinberger's Patents

Medal and Diploma  
received at  
World's  
Fair,  
St. Louis,  
1904

**ARRIVED**



**AIR-GAP TYPE  
INSULATORS**

PATENTED

Radio Frequencies  
Radio Telegraph  
Radio Telephony  
X-Ray Apparatus

Damped or Sustained  
Voltages

Air Gap  
1/4" and Upward

Maximum Dielectric  
Strength

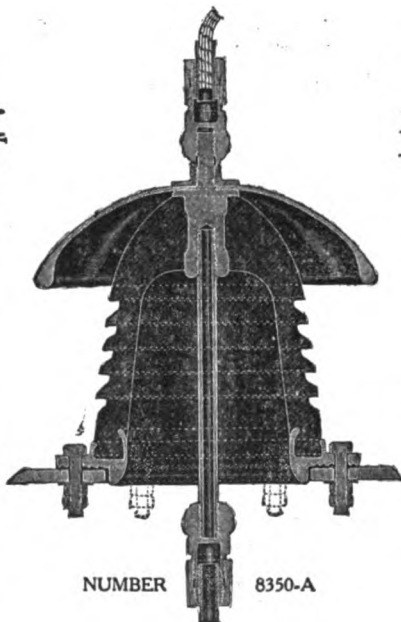

NUMBER 8350-A

**ARRIVED**



**AIR-GAP TYPE  
INSULATORS**

PATENTED

Audio Frequencies  
Transmission Lines  
Sub Station Bushings  
Transformer Bushings  
Oil Switches  
Circuit Breakers, Etc.

Air Gap  
1/4" and Upward

Maximum Mechanical  
Strength

**MINIMUM DIELECTRIC LOSS  
MINIMUM WEIGHT**

**MINIMUM COST  
MINIMUM PHYSICAL DIMENSIONS**

Materials so proportioned that:

**MAXIMUM ELECTRIC STRESSES FORMED IN AIR**

EXTENSIVE TESTS under sustained radio frequency operation show:

**NO DETECTABLE HEATING**

**ARC-OVER ESTABLISHED IN AIR**

"ELECTROSE" Insulators are standard with United States Navy and Army and Wireless Telegraph and Telephone Companies.

"ELECTROSE" is made in a number of grades for various requirements, each grade possessing special characteristics.

"ELECTROSE" Insulators—Best in the World for High Frequency Currents, Power and Transmission Circuits.

SOLE MANUFACTURERS

60-82 Washington St.  
66-76 Front St.

27-37 York St.  
1-23 Flint St.

Brooklyn, N. Y., America



Please mention the PROCEEDINGS when writing advertisers

# United States Naval Institute Proceedings

PUBLISHED MONTHLY  
EDITED BY F. M. ROBINSON



U. S. NAVAL INSTITUTE  
ANNAPOLIS — MARYLAND

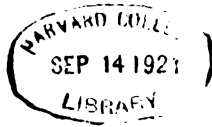

*Naval Department*

COPYRIGHT, 1921  
By J. W. CONROY  
TRUSTEE FOR U. S. NAVAL INSTITUTE

**The Lord Baltimore Press**  
BALTIMORE, MD., U. S. A.

*The writers only are responsible for the contents of their respective articles*

## CONTENTS

---

THE RESULTS AND EFFECTS OF THE BATTLE OF JUTLAND. By Lieut. Commander Holloway H. Frost, U. S. Navy.....	1325
THE ENGINEERING OFFICER-PERSONNEL PROBLEM. By Commander W. S. McClintic, U. S. Navy.....	1355
DISCIPLINE. By Captain E. B. Fenner, U. S. Navy.....	1371
APPROXIMATE ALTITUDE AND AZIMUTH. By Lieut. Commander L. V. Kielhorn, U. S. Navy.....	1387
GUNNERY AND TURRET DESIGN. By Commander H. F. Leary, U. S. Navy .....	1393
SPEEDING UP COMMUNICATIONS. By Lieut. Commander M. S. Tisdale, U. S. Navy .....	1413
DISCUSSION .....	1417
SECRETARY'S NOTES .....	1420
PROFESSIONAL NOTES .....	1423
NOTES ON INTERNATIONAL AFFAIRS .....	1476
REVIEW OF BOOKS .....	1485
INFORMATION INDEX .....	1422



# OFFICERS OF THE INSTITUTE

---

## *President*

REAR ADMIRAL BRADLEY A. FISKE, U. S. NAVY

## *Vice President*

REAR ADMIRAL HENRY B. WILSON, U. S. NAVY

## *Secretary and Treasurer*

COMMANDER F. M. ROBINSON, U. S. NAVY

## *Board of Control*

REAR ADMIRAL BRADLEY A. FISKE, U. S. NAVY (*ex officio*)  
REAR ADMIRAL HENRY B. WILSON, U. S. NAVY (*ex officio*)  
BRIGADIER GENERAL GEORGE RICHARDS, U. S. M. C.  
CAPTAIN JOHN HALLIGAN, JR., U. S. NAVY  
CAPTAIN T. L. JOHNSON, U. S. NAVY  
CAPTAIN J. A. FURER (C. C.), U. S. NAVY  
CAPTAIN JOHN DOWNES, U. S. NAVY  
COMMANDER J. O. RICHARDSON, U. S. NAVY  
COMMANDER F. M. ROBINSON, U. S. NAVY (*ex officio*)

# PAST PRESIDENTS

---

ADMIRAL DAVID D. PORTER, U. S. NAVY, 1873  
REAR ADMIRAL JOHN L. WORDEN, U. S. NAVY, 1874  
REAR ADMIRAL C. R. P. RODGERS, U. S. NAVY, JAN. 1875-JAN. 1878  
COMMODORE FOXHALL A. PARKER, U. S. NAVY, JAN. 1878-JAN. 1879  
REAR ADMIRAL JOHN RODGERS, U. S. NAVY, JAN. 1879-JAN. 1882  
REAR ADMIRAL C. R. P. RODGERS, U. S. NAVY, JAN. 1882-JAN. 1883  
REAR ADMIRAL THORNTON A. JENKINS, U. S. NAVY, JAN. 1883-OCT.  
1885  
REAR ADMIRAL EDWARD SIMPSON, U. S. NAVY, OCT. 1885-OCT. 1887  
REAR ADMIRAL STEPHEN B. LUCE, U. S. NAVY, OCT. 1887-OCT. 1898  
REAR ADMIRAL WM. T. SAMPSON, U. S. NAVY, OCT. 1898-OCT. 1902  
REAR ADMIRAL H. C. TAYLOR, U. S. NAVY, OCT. 1902-OCT. 1904  
REAR ADMIRAL C. F. GOODRICH, U. S. NAVY, OCT. 1904-OCT. 1909  
REAR ADMIRAL RICHARD WAINWRIGHT, U. S. NAVY, OCT. 1909-OCT.  
1911



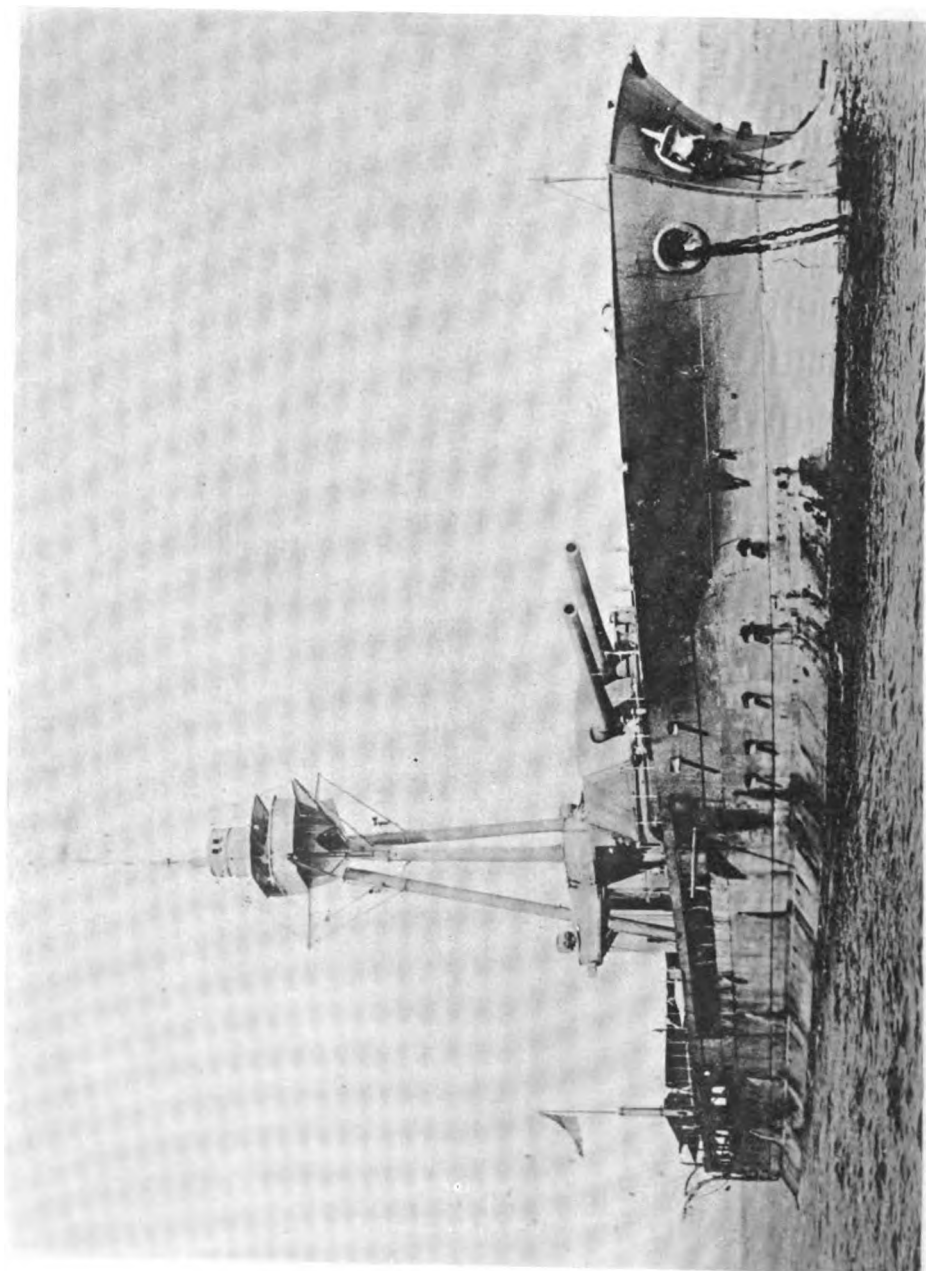

H. M. S. ABERCROMBIE (BRITISH MONITOR). This is a protection against submarine attack.

# UNITED STATES NAVAL INSTITUTE PROCEEDINGS

---

---

Vol. 47, No. 9

SEPTEMBER, 1921

Whole No. 223

---

---

[COPYRIGHTED]

U. S. NAVAL INSTITUTE, ANNAPOLIS, MD.

---

## THE RESULTS AND EFFECTS OF THE BATTLE OF JUTLAND

By LIEUT. COMMANDER HOLLOWAY H. FROST, U. S. Navy

---

### I. THE MILITARY SITUATION BEFORE THE BATTLE

In order to determine what the results of the battle of Jutland were, it is necessary to establish the salient features of the military and naval situations in Europe before the battle.

At the beginning of June, 1916, the general military situation was very favorable for the Allied Nations. The year of 1915 had been an extremely successful one for the Central Powers. On the eastern front the Russians had been pushed back with heavy losses and crushing defeats; Bulgaria had entered the war and Serbia had been overrun, while the British and French were being decisively repulsed at the Dardanelles. On the western front and in Italy the various allied offensives, although gaining a little ground and some prisoners, were generally favorable to the Central Powers.

At the beginning of 1916 the Central Powers, as the result of their successes of 1915, had sufficient reserves to attempt other offensives. The Germans prepared a powerful drive on Verdun; the Austrians made ready for an attack in the Trentino; the Turks pushed the siege of Kut-el-Amara and prepared defensive positions to hold off relieving armies.

It is somewhat of a remarkable coincidence that each of these three offensives ran the same course; each commenced with striking successes; each ended in virtual failure.

At Verdun very important successes were gained on the first days; gradual progress was made for several months. By May it had become a great battle of attrition. Its final results were decidedly unfavorable for the Germans.

At the middle of May the Austrian offensive commenced. After important initial successes, it also was checked, and ultimately the Italians regained a considerable portion of the ground lost.

In April the Turks succeeded in taking Kut-el-Amara, but were unable to make any further advance, due probably to the death of Field Marshal von der Goltz, and the arrival of important British reinforcements.

The Central Powers had meanwhile been able to maintain the Russian front despite very heavy attacks on the German part of the front during March. The Macedonian front was stationary. The Russians had broken through the Armenian front, but this was a local success only and could have little effect on the more vital campaigns.

Thus, the three great offensives of the Central Powers had failed, and in failing had practically consumed the entire strategic reserves of their armies. The Allied Nations, with a great superiority of numbers and equipment, seized the initiative on all fronts and prepared for a simultaneous concentric attack, which all supposed would soon bring about a decision.

In France elaborate preparations were made for a great attack astride the Somme River; the Italians made ready for a new Isonzo battle; the Russians were concentrating enormous forces, well equipped with fresh stores of material, for a powerful drive at many points along a wide front; the Saloniki front was being built up in preparation for an advance into Serbia; in Mesopotamia the British were getting ready on a large scale for a campaign toward Bagdad; finally, Roumania had about decided to enter the war on the side of the Allied Nations, thus greatly lengthening the eastern front and throwing a fresh and well-equipped army into the heart of Hungary for the *coup-de-grace*.

The mere beginning of these numerous campaigns brought the removal of the chief of the general staff of the German field army

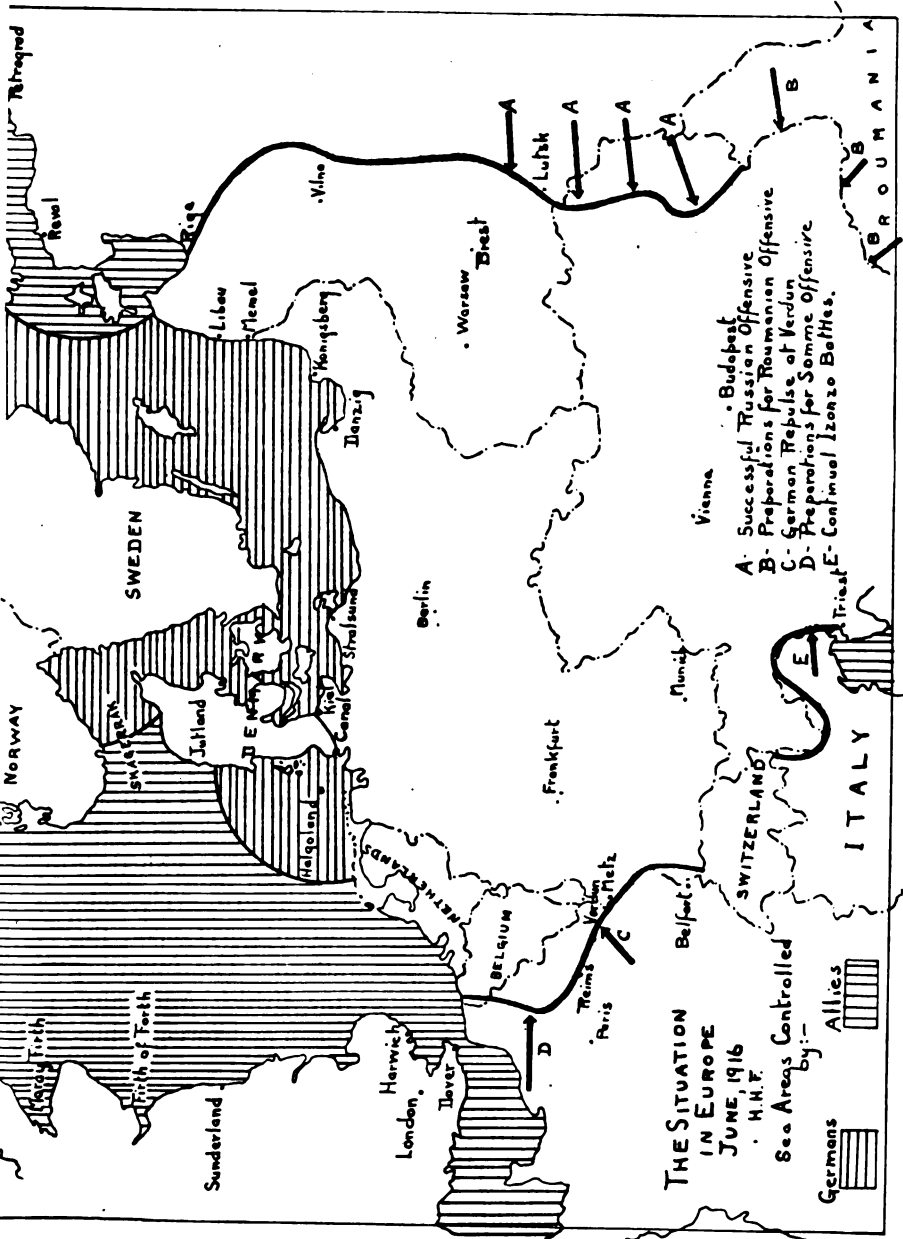

THE SITUATION IN EUROPE JUNE, 1916  
 H. H. F.  
 See Areas Controlled By :-

 Germans  
 Allies

- A. Successful Russian Offensive
- B. Preparations for Roumanian Offensive
- C. German Repulse at Verdun
- D. Preparations for Somme Offensive
- E. Continual Isonzo Battles.

and the appointment to that position of supreme importance of Field Marshal von Hindenburg. Upon taking up his position of first quartermaster general, Ludendorff described the situation as follows:

The circumstances under which the Field Marshal and I had been summoned to take supreme command were *extremely critical*. Whereas we had hitherto been able to conduct our great war of defense by that best means of waging war—the offense—we were now reduced to a policy of *pure defense*.

## II. THE NAVAL SITUATION BEFORE THE BATTLE

In 1915, while the Germans were taking the offensive on the eastern front, they were also taking the offensive on the high seas by means of the submarines operated from bases in Germany, Belgium, Austria and Turkey. This offensive, as admitted by von Tirpitz, was somewhat premature, as the Germans were really not ready in February, 1915, for its execution. Therefore, the damage caused to Allied and neutral shipping in the first months of the campaign was comparatively small. As the output of submarines increased and their crews became more skilled, the shipping sunk by them increased, as the figures for the third quarter of 1915 show. However, the damage to shipping was kept at about a constant figure for the last two quarters of 1915 and the first two quarters of 1916, due to the restrictions placed upon the submarine commanders by the German Government as a result of the strong protests of neutral nations, which culminated in the promise of the Germans to carry out cruiser warfare with their submarines, after the *Sussex* incident in March, 1916. The submarines, therefore, did not have an important effect upon the course of the war before the battle of Jutland. The following table, taken from the official report of the British Admiralty, March 21, 1918, shows the total loss of British and foreign shipping by enemy action and marine risk:

Year	Quarter	Gross tons
1915.....	First .....	320,447
	Second .....	380,419
	Third .....	529,481
	Fourth .....	494,373
1916.....	First .....	524,195
	Second .....	522,289

The High Sea Fleet during the year 1915 had limited its operations to controlling the Baltic, the Cattegat, a part of the Skagerrack and a small sea area off Helgoland, which permitted the submarines to gain deep water before being subject to enemy attack. The command of the Baltic permitted trade with Norway and Sweden, which was, however, subject to occasional attack by British submarines. In May the German army captured Libau, which the German naval units used as an advanced base. The supplies for the German army in Courland were transported from German Baltic ports to Libau. Ludendorff states that this line of supply was of the "utmost importance." In August, 1915, a German naval advance into the Gulf of Riga and a landing attack at Pernau were defeated by the Russians. The retention of the Gulf of Riga by the Russian fleet had an important effect in the halting of the advance of the German army in the Riga sector. The Russians also held the Gulf of Finland, where Reval and Kronstadt were used as naval bases.

The British Navy, having in 1914 swept the German cruisers from the high seas, consolidated its position in the North Sea during 1915 for the purpose of maintaining its command over it, and of preventing German merchant shipping and naval units from making passage between the high seas and German ports. The British government gradually commenced to exert decisive pressure upon Germany by adding to the contraband list and placing the most severe restrictions on the trade of the neutral nations adjacent to Germany.

The British also were forced to commence the building up of a great anti-submarine organization to meet the German submarine offensive. As soon as it was demonstrated that the German submarine campaign would be checked by the protests of the neutral powers, British construction of merchant vessels was allowed to decrease to about one-third of peace-time figures. During 1915 Lord Fisher had commenced a large emergency naval building program, including vessels specially designed for use in the Baltic and against the Belgian coast.

In the early part of 1916 Admiral Scheer, who became commander-in-chief of the High Sea Fleet, decided upon an active offensive-defensive campaign with the fleet as a substitute for the submarine campaign; as the submarines could not operate very favorably against trade at that time, due to the restrictions placed



on their methods of operation, a number of them were assigned to operate in conjunction with the fleet whenever it put to sea.

On February 11, 1916, Scheer commenced the execution of his campaign with the High Sea Fleet by sending the light cruiser *Rostock* with the destroyer flotillas II, VI, and IX on a raid off the Dogger Bank. This force succeeded in sinking the British sloop *Arabis*.

On March 5 three dirigibles bombed the Humber area and the High Sea Fleet advanced into the approaches to the Channel and returned without making contact with any important British force.

On April 24 six Zeppelins bombed the coastal towns and the German scouting force bombarded Lowestoft and Yarmouth, supported by the whole High Sea Fleet. Contact was made with the Harwich force, which kept out of effective gun range. The *Seydlitz* was mined during this cruise.

Finally, on May 31, Admiral Scheer commenced an advance into the Skagerrack, which developed into the battle of Jutland.

The British forces were well disposed along the eastern coast of Scotland and England to meet the offensive of the High Sea Fleet.

The battle fleet, with its accompanying cruisers, light cruisers and destroyers, was at Scapa. The battle cruiser fleet, with light cruisers and destroyers, was at Rosyth. The mission of these two forces was to scout for and bring to action the German battle fleet whenever it put to sea. Thus, on April 25 they very nearly were able to intercept the High Sea Fleet, and on May 31 they were able to bring it to action.

In addition to these main forces the following less important forces were stationed along the eastern coast of Scotland and England for the purpose of enforcing the blockade, preventing bombardment of coastal cities and, in general, of controlling the sea area along the coast against the attacks of enemy light cruisers, destroyers and submarines:

- (a) The tenth cruiser squadron, based on the Shetland Islands.
- (b) Light forces based at Scapa, Moray Firth and Firth of Forth.
- (c) The third battle squadron and third cruiser squadron, based at the Thames.
- (d) The Harwich force.
- (e) The Dover patrol.

The Grand Fleet at Jutland had a superiority over the High Sea Fleet of approximately 1.75 to 1, or of 7 to 4.\*

In addition to the ships actually present the Germans had one battleship, first line, in commission—the *König Albert*—as against four battleships, first line and one battle cruiser for the British—the *Royal Sovereign*, *Queen Elizabeth*, *Empress of India*, *Dreadnaught* and *Australia*.

As a final reserve, the opposing navies had the following large ships, which had been laid down since 1900:

Class of ship	Great Britain	Germany
Battleship, second line .....	16	11
Cruiser, second line .....	23	1

The following ships were building and nearing completion:

Class of ship	Great Britain	Germany
Battleship .....	2	2
Battle cruiser.....	2	1
Cruiser .....	3	0

The British cruisers each carried four 15-inch guns and had speeds of 35 knots. Their armor was very light.

Therefore, the British had a reserve of 12 large modern ships as against 4 for the Germans. Back of these there was a further reserve of 39 large second line ships as against 12 for the Germans.

In addition, the other Allied Nations had powerful navies which were largely available as reserves for the Grand Fleet.

The French had 7 battleships, first line, and 10 very good battleships, second line; Italy had 5 battleships, first line, and 4 of the second line. Russia had 4 battleships, first line. On the other hand, Germany's allies had weak naval forces. Austria had 2 battleships, first line, and 6 of the second line. Turkey had 1 battle cruiser.

The total naval strength of Great Britain's allies therefore amounted to 16 ships of the first line and 14 of the second, while Germany's allies had a total of 3 ships of the first line and 6 of the second. This omits all cruisers, light cruisers and destroyers; in all of these classes the Allied Nations were greatly superior.

\* In the article "The High Sea Fleet at Jutland" the number of German destroyers was estimated as 77 and their aggregate displacement as 60,300 tons. A letter from the German Admiralty to the writer gives 65 destroyers present with an aggregate displacement of 62,203 tons. 32 were with Hipper and 33 with Scheer.

Let us now see what the probable result of an action between the two fleets would be. In order to give the benefit of doubt to the Germans, we will assume that they were slightly more efficient, ship for ship, and that their fleet would be handled somewhat better than the Grand Fleet. Nevertheless, admitting these advantages, it still seems evident that they had only a remote chance of coming out of a fleet action with losses as small as those of the British. It would require a most extraordinary combination of skill and luck if the Germans were to inflict losses in the ratio of 7 British units to 4 of their own. Nevertheless, the British could well afford to receive losses in this ratio, even to the total destruction of both forces engaged, unless they were influenced by considerations of future difficulties with the United States or one of their allies. This was the maximum success the Germans could have won in a battle fought to a decision.

In this extreme case, even, the British had such reserve strength as to assure them the continued control of the North Sea.

This control might have been somewhat less effective than before, because the Germans might gain the following advantages:

- (a) A better exit of their submarines from German ports.
- (b) Better opportunities for raids on the trade between England and Norway.
- (c) Better chances for successful raids on the English coast.
- (d) An easier passage for raiders between Scotland and Norway.
- (e) A lessening of the British anti-submarine effort, due to the necessity to reinforce the Grand Fleet with vessels previously engaged in this duty.

It will be at once seen that these possible advantages would give the Germans no decisive benefit, and, in fact, the situation would soon reduce to that which obtained before the battle; probably it would be even more favorable to the British.

It has been generally recognized at the Naval War College that in a naval battle the damage inflicted is not merely in proportion to the numbers engaged, but in proportion to the square of these numbers. Having this in mind, it would seem that the British could expect to inflict two or three times the losses they received and had almost a certainty of coming out of the battle with less losses than the enemy. This meant that, if they could come to

close action, they could expect to wipe the German fleet from the board.

The destruction of the German fleet would have had the following results:

(a) The German submarines would have been mined in, and the great submarine campaign would have been greatly decreased in effectiveness.

(b) A great part of the British Navy could have been demobilized and the building of naval units and merchant shipping stopped, thus releasing personnel and material for the armies.

(c) The British Navy could have penetrated into the Baltic and controlled that sea area.

(d) The German Baltic coast could be attacked, thus drawing troops from the land fronts.

(e) The British Navy, working with the Russians, would probably have held together the Entente Alliance.

(f) England could have supplied Russia through the Baltic.

(g) These measures, together with the other successful allied offensives on land would, in all probability, have decided the World War in 1916.

### III. THE MATERIAL AND PERSONNEL LOSSES OF THE BATTLE

It has been definitely and finally determined that the following vessels were sunk in the battle, or as a result of damage received in it:

BRITISH		GERMAN	
Ships	Displacement	Ships	Displacement
<i>Queen Mary</i> .....	26,350	<i>Lutzow</i> .....	26,700
<i>Indefatigable</i> .....	18,800	<i>Pommern</i> .....	13,200
<i>Invincible</i> .....	17,250	<i>Wiesbaden</i> .	
<i>Defense</i> .....	14,600	<i>Elbing</i> .	
<i>Warrior</i> .....	13,550	<i>Rostock</i> .	
<i>Black Prince</i> .....	13,350	<i>Frauenlob</i> .....	17,150
<i>Tipperary</i> .....	1,430	<i>V-4</i> .	
<i>Turbulent</i> .....	1,100	<i>V-27</i> .	
<i>Fortune</i> .....	965	<i>V-29</i> .	
<i>Ardent</i> .....	935	<i>S-35</i> .	
<i>Shark</i> .....	935	<i>V-48</i> .....	3,680
<i>Sparrowhawk</i> .....	935		
<i>Nestor</i> .....	890	Total .....	60,730
<i>Nomad</i> .....	890		
<b>Total</b> .....	<b>111,980</b>		

The British total losses in vessels sunk were greater than the German in the ratio of 1.84 to 1. If we were to exclude the second line ships from the total, the British losses would be 70,480 and the German losses 44,815; then the British losses would be greater in the ratio of 1.59 to 1.

Commander Bellairs gives the personnel losses as follows:

	British	German
Officers killed.....	343	172
Officers wounded.....	51	41
Men killed.....	6104	2414
Men wounded.....	513	449
Total .....	7011	3086*

The British personnel losses were greater than the German losses in the ratio of 2.27 to 1. These losses were even more disadvantageous to the British because they lost two rear admirals with their entire staffs and six captains as against the three captains lost by the Germans.

The damage to ships which did not sink may be indicated by the hits received and the personnel losses caused by the hits. In the case of battleships, battle cruisers and cruisers only heavy caliber hits are counted, all small caliber hits and shell splinters being omitted. In the case of light cruisers all hits of every caliber are counted.

#### DAMAGE TO BATTLESHIPS, BATTLE CRUISERS AND CRUISERS

BRITISH			GERMAN		
Name	Heavy hits	Casualties	Name	Heavy hits	Casualties
<i>Lion</i> .....	12.....	44	<i>Derfflinger</i> .....	19.....	179
<i>Princess Royal</i> ..	9.....	70	<i>Seydlitz</i> .....	21.....	149
<i>Tiger</i> .....	4.....	62	<i>Moltke</i> .....	4.....	38
<i>New Zealand</i> ....	1.....	None	<i>Von der Tann</i> ..	4.....	47
<i>Indomitable</i> ....	1.....	None	<i>Markgraf</i> .....	5.....	17
<i>Barham</i> .....	6.....	59	<i>Grosser Kurfurst</i>	8.....	33
<i>Malaya</i> .....	7.....	96	<i>Konig</i> .....	10.....	65
<i>Warspite</i> .....	27*....	Unknown	<i>Kaiser</i> .....	2.....	None
<i>Colossus</i> .....	2.....	5	<i>Helgoland</i> .....	1.....	None
			<i>Holstein</i> .....	1.....	10
Total .....	69		Total .....	73	

\* The German Admiralty states that 2545 were killed or missing and 494 wounded.

\* Unofficial report.

The number of heavy hits received by the Germans was therefore greater than those received by the British in the ratio of 1.14 to 1. In addition, the British had the *Marlborough* torpedoed, while on the German side the *Seydlitz* was hit by a torpedo and the *Ostfriesland* mined.

## DAMAGE TO LIGHT CRUISERS

BRITISH			GERMAN		
Name	All hits	Casualties	Name	All hits	Casualties
<i>Southampton</i> ...	20*	89	<i>Frankfurt</i> .....	4	21
<i>Dublin</i> .....	13	Unknown	<i>Pillau</i> .....	1	26
<i>Chester</i> .....	20*	81	<i>Stettin</i> .....	2	35
<i>Castor</i> .....	10	35	<i>München</i> .....	5	25
<i>Calliope</i> .....	1	21	<i>Hamburg</i> .....	4	38
<i>Canterbury</i> .....	1	None	—	—	—
<i>Galatea</i> .....	1	None	Total .....	17	
<i>Falmouth</i> .....	1	None			
Total .....	67				

The British therefore suffered greater damage to their light cruisers than did the Germans. The British also had more destroyers damaged.

In a final consideration of the losses it must be borne in mind that a ship sunk represents a damage many times more serious than one which is so badly damaged that it is just able to get into port before sinking. None of the ships sunk were replaced during the whole war by vessels of their type commenced after the battle; on the other hand, the *Derfflinger* and *Seydlitz*, which were damaged far more than any other ships, were ready after six months of repairs, while all the other ships, both British and German, were ready within two and one-half months from the date of the battle.

Furthermore, to build new ships requires a great amount of expensive material and the services of numerous skilled workmen; to repair ships but little new material is needed, and the personnel, while fairly numerous, is needed for a very much shorter period.

The personnel losses, particularly in officers, represent a very serious loss to a naval service.

Giving due weight to these considerations, it seems fair to estimate the British losses as approximately 1.75 times as great as the

\* Estimated.

German. In other words, the losses were in proportion to the forces engaged. Thus, at the end of the battle the British still held the superiority over the Germans which they had before it was fought.

#### IV. THE MORAL EFFECTS OF THE BATTLE

The moral effects of the battle must be considered under two headings:

(a) The effect upon the navies.

(b) The effect through the civil population, the armies and the population of the neutral nations.

Neither Jellicoe nor Beatty in their official reports claimed a success or victory. Jellicoe sent a message of congratulation to Beatty as follows:

Please accept my sincere congratulations on the action of the forces under your command under the difficult and disadvantageous conditions of light and weather which existed for you. The heavy losses, which I deeply deplore, appear to be largely due to these conditions, and your ships inflicted very severe damage to the enemy, although the great defensive strength of their ships saved more from becoming total losses. Words cannot express my deep sympathy with relatives and friends of the gallant officers and men who have gone under.

These are not the words of an admiral who has won a battle.

The message of the King to the fleet does no more than mention the "gallantry of the officers and men," and state his "confidence in the valor and efficiency of the fleets."

In his official report Admiral Jellicoe says:

The disturbing feature of the battle-cruiser action is the fact that five German battle cruisers engaging six vessels of this class, supported after the first 20 minutes, although at great range, by the fire of four battleships of the *Queen Elizabeth* class, were yet able to sink the *Queen Mary* and the *Indefatigable*.

Again the Admiral writes:

The experience and results of the action, particularly the knowledge we now have of the speed of the enemy's third squadron, must exercise considerable influence on our future dispositions and tactics. It will, for instance, not be advisable in future to place our fifth battle squadron in a position removed from support.

Finally this interesting statement is made:

The German organization at night is very good. Their system of recognition signals is excellent. Ours is practically nil. Their search-

lights are superior to ours, and they use them with great effect. Finally, their method of firing at night gives excellent results. I am reluctantly compelled to the opinion that under night conditions we have a great deal to learn from them.

These statements demonstrate the following facts:

(a) The British battle cruisers were not capable of engaging the German battle cruisers under equal conditions. There is reason to believe that this was the opinion of those who served on the British battle cruisers.

(b) The fifth battle squadron, according to the opinion of the commander-in-chief, was capable of operating only with the fleet. This to a great extent threw away the advantages of its high speed and weakened the position of the battle cruisers still more.

(c) The British would not risk a general engagement at night and probably would not even attack with destroyers. A striking example of this occurred on August 19, when Commodore Tyrwhitt gained contact with the High Sea Fleet at nightfall. "The conditions," writes Jellicoe, "for night attack proved to be unfavorable, and at 7.30 p. m. the commodore reported that he had abandoned the pursuit."

While these facts doubtless made certain of the British forces less eager for battle, it is certainly a fact that the entire Grand Fleet would have welcomed another fleet action under equal conditions in the open sea. It is also a fact that the battle exposed the many deficiencies of the British ships and material, which were made good with great energy. It is probable that the morale of the Grand Fleet, all things considered, was as good after the battle as before it, and particularly after the depressing effects of the losses had worn off.

Let us now examine the situation from the German point of view.

In his official report Scheer claimed a success. His very interesting summary reads as follows:

The success obtained is due to the fact that our squadron and flotilla leaders were filled with zeal for battle, and realized the object of the undertaking, and to the excellent work performed by the ships' companies, who were imbued with the greatest martial ardor.

Its achievement was only rendered possible by the quality of our ships and armament, the fact that the peace training of the units was conscious of its object, and by the conscientious training carried out by the individual ships.



The large amount of experience gained will be exploited with the greatest care.

The battle has proved that in building up our fleet, and the development of the individual types of our ships, we have been guided by correct and strategical views, and that we should, therefore, continue on the same lines.

All arms have borne their share in this result; the decisive factor was, however, the long range heavy armament of the *larger vessels*. It caused the greater part of the known losses inflicted on the enemy, and it enabled the flotillas to carry out a successful attack against the enemy's Main Fleet. The above observation in no way detracts from the merit of the flotillas, whose attack on the enemy battlefleet was finally successful in enabling us to break away completely from the enemy.

The *large war vessel*, battleship and cruiser, is and remains, therefore, the foundation of sea power, and should be further developed by enlarging the caliber of the guns, increasing the speed and perfecting the armor above and below the water.

These paragraphs show that Scheer was completely satisfied with the personnel and material of his fleet. While Jellicoe expressed satisfaction with his personnel, he criticized very severely the material development of his fleet in many respects.

The Austrian Naval Attaché to Berlin visited the fleet immediately after it returned to port and made an official report to the Austrian Admiralty. This report has every evidence of accuracy, and has the advantage of not being a public statement written for propaganda purposes. His report confirms the opinions of Admiral Scheer. In addition he makes the following comment upon the morale of the High Sea Fleet :

The fleet is absolutely *enthusiastic* and intoxicated with victory; the terrible incubus, the dread which weighed on everybody, namely, that the war should end without a meeting of the two fleets, has vanished. . . . The entire fleet down to the last sailor has faith in its strength and in the possible conflicts of the future.

Despite the satisfaction of the Germans with the result of the battle and the temporary enthusiasm of their personnel, they realized that the numerical superiority of the British and their advantages of position would prevent the High Sea Fleet from ever gaining the command of the sea. Admiral Scheer admitted this and therefore urged the resumption of unrestricted submarine warfare. This not being approved at that time, he continued his campaign with the High Sea Fleet in the North Sea in a manner similar to its operations before the battle; in fact his operation against Sunderland on August 19 was the most ambi-

tious of his sorties into the North Sea. There is no evidence that the morale of the German commander-in-chief or that of his fleet was lowered by the battle of Jutland.

It is true that the morale of the fleet became bad in the latter part of 1917. The reasons for this were as follows:

(a) After January, 1917, unrestricted submarine warfare was commenced. This drew the best officers to the submarines; picked men were also taken from the fleet for the submarines. The morale of the submarines was good to the very end.

(b) All the navy yard facilities were used for the building and repair of submarines, and the material condition of the fleet deteriorated.

(c) As all the submarines were used against trade, none could be assigned to the fleet for combined operations, as was the case in 1916.

(d) For these reasons, it was not considered advisable to operate the fleet as aggressively in 1917 and 1918 as in 1916. The enforced idleness, the lack of food, and the pernicious activities of the Independent Socialists then combined to undermine the morale of the German Navy. It is not considered that the results of the Battle of Jutland contributed to this condition.

It now remains to consider the moral effect of the battle upon the civil population and armies of the belligerents, and upon the neutral nations.

In the German army the effect of the battle was favorable. Before the action there was doubtless a feeling that, while the troops were suffering terrible losses in battle, the fleet was remaining safe in port. The battle dispelled this feeling and doubtless encouraged the army, which at this time was being tested to the very limit.

Throughout Germany there had doubtless been some dissatisfaction at the lack of action on the part of the fleet, which had cost such enormous taxes before the war. The battle brought home the uses and accomplishments of the fleet, and as the Germans worked their propaganda very skillfully, the effect through their country was certainly very favorable. "That it gave the German people," writes Commander von Hase, "new strength and confidence, and contributed greatly to their prestige, there can be no question."

It is considered that the German Admiralty made a mistake in concealing the loss of the *Lutzow*. Admiral Scheer states that this was not done at his request, saying: "Unfortunately the secrecy observed produced the impression that it was necessary to enlarge our success to that extent." The Germans had good reason to be proud of the accomplishments of their fleet, without concealing any of its losses.

In the Allied Nations and among the neutrals the effect was particularly disadvantageous. This was partly due to the very high reputation which the British Navy had maintained through hundreds of years of history, and the fact that the German Navy was a new development and had never been tried in a fleet action. These considerations led the neutral nations to expect a complete victory, or at least that the German losses would be much heavier than the British. Therefore, the first startling German accounts had a tremendous effect upon public opinion. These impressions were increased by the admission by the British of the greater part of the German claims.

Then, to counter the unfavorable situation, the British used two lines of propaganda. The first was to blame the results of the battle upon the unfavorable weather condition. This proved a most unfortunate line, for people familiar with naval history remembered what Hawke had said and done at Quiberon Bay. Here this famous old admiral reported that he saw the necessity he "was under of running all risks to break the strong force of the enemy." Following the French fleet, he entered the bay in a gale just as darkness was coming on. Being warned by his sailing master, who protested strongly against his entering the bay, Hawke replied: "You have done your duty in warning me; now lay us alongside the French commander-in-chief." Also it might have been recalled that mist prevented Calder from capturing more than two ships from Villeneuve in the battle off Cape Finisterre in 1805, and that Calder had been censured by a court-martial of his brother officers.

The second course of action was to claim that the German losses were very much greater than they actually were. In addition to the true losses, the British claimed certain or probable losses of three battleships, one light cruiser, four destroyers, and one submarine. The German claims, although also exaggerated, were modest in contrast with these. Doubtless this line of propaganda

had some effect, but the very necessity for using such methods had a bad effect upon those who could not be convinced that the British claims were true.

Taken all in all, the battle of Jutland had a favorable moral effect for the Germans and was a very heavy blow at British naval prestige.

#### V. THE EFFECTS OF THE BATTLE UPON THE COURSE OF THE WAR

As it was known that many of the vessels of the High Sea Fleet were severely damaged, the Grand Fleet did not put to sea during the month of June. This period was utilized to effect important repairs and to carry out certain alterations proved necessary by the battle. Practically all the repairs were completed by the first week in July. The *Chester* rejoined on July 29 and the *Marlborough* on about August 5.

During the month of July the Grand Fleet put to sea but once, and this time for an exercise cruise of three days in the vicinity of the Shetlands. On the night of the 24th the *Warspite* and *Valiant* collided in Scapa Flow and had to be docked.

On August 18 the Grand Fleet started on a sweep into the southern part of the North Sea.

When the High Sea Fleet arrived in port on June 1, all damaged ships were sent to navy yards or private shipbuilding companies to repair their damages. By the middle of August all the ships were ready for service except the *Derfflinger* and *Seydlitz*. The new battleship *Bayern* joined the fleet.

Admiral Scheer then put to sea with the intention of carrying out his original plan of a raid on Sunderland. During the 18th there were numerous contacts between the German submarines and the units of the Grand Fleet; the light cruiser *Nottingham* was sunk as the result of three torpedo hits; the *Falmouth* was hit by four torpedoes before sinking; on the other hand the battleship *Westfalen* was torpedoed by a British submarine, not, however, being seriously damaged. In the late afternoon the two fleets were nearly in contact, but Scheer refused action and succeeded in withdrawing just in time. In fact, the Harwich force did make contact with him and was in a position for a night destroyer attack. The British refused to attack, because, as Jellicoe reports, "the conditions for night attack proved to be unfavorable."

In this operation, the Germans declined a day action and the British one at night. Neither fleet was willing to engage, except under conditions which were favorable to it. The actual losses of the British were heavier than those of the Germans, and the success of the German submarines had a very decided moral effect upon the British. This is shown by the following statements of Admiral Jellicoe:

The experience of August 19th showed that light cruisers, proceeding at even the highest speed, unscreened by destroyers, ran considerable risk from enemy submarines. The enemy's submarine commanders were no doubt increasing in efficiency, and risks we could afford to run earlier in the war were now unjustifiable. Representations were made to the Admiralty to the effect that it was considered that in the future light cruisers should be screened by at least one destroyer per ship.

The ease with which the enemy could lay a submarine trap for the fleet had been demonstrated on the 19th of August; what had constantly puzzled me was that this had not been done very frequently at an earlier stage in the war. Since, however, it had been attempted and with some success, there seemed to be every reason to expect a repetition of the operation, and it was clear that it was unwise to take the fleet far into southern waters, unless an adequate destroyer force was present to act as a submarine screen for all ships. If the circumstances were exceptional and the need very pressing, it would be necessary to accept the risk. There was general agreement on this point between the flag officers of the fleet and the Admiralty.

This decision made the German control of the North Sea area off Helgoland considerably more secure, gave the German submarines a safer exit from their bases and made it practically impossible for the High Sea Fleet to be brought to action. In accordance with this principle none of the battle squadrons of the Grand Fleet ventured much to the southward of Scapa Flow while Admiral Jellicoe remained in command. The battle cruiser fleet made several cruises toward the Skagerrack, and the light cruisers made reconnaissance off the German minefields. The British submarines maintained a patrol off Horn Reef, and in the Skagerrack.

On the other hand, Admiral Scheer planned additional sorties into the North Sea. However, he apparently was not willing to risk a fleet action during these operations, for the one planned for September was cancelled because the weather was not suitable for dirigible scouting. In October an operation with the High Sea Fleet into the center of the North Sea was carried out, but the attempt to attack trade between England and Norway was without result, and no contact was made with the British forces.

Scheer's naval campaign with the High Sea Fleet had been practically checked, and the status at the end of 1916 was almost the same as at the beginning. His operations had a favorable moral effect throughout the world, and they had reflected great credit upon him and the High Sea Fleet. Nevertheless, nothing had been accomplished to break the British blockade; all that could be done was to maintain the present situation in the North Sea and the Baltic; the maintenance of this situation was of great importance for the Germans, and the offensive operations of the High Sea Fleet in 1916 had rendered the defensive position of Germany more secure.

After the results of the battle of Jutland had been carefully analysed, Scheer in his report of July 4, had stated the following opinion:

Should the future operations take a favorable course, it may be possible to inflict appreciable damage on the enemy; but there can be no doubt that even the most favorable issue of a battle on the high seas *will not compel England* to make peace in *this* war. The disadvantages of our geographical position compared with that of the Island Empire, and her great material superiority, cannot be compensated for by our fleet to a degree which will enable us to overcome the blockade instituted against us, or to overpower the Island Empire herself, even if all our submarines are available for military purposes.

A victorious termination of the war within reasonable time can only be attained by destroying the economical existence of Great Britain, namely, by the employment of submarines against British commerce.

This opinion had been constantly gaining ground in the German Navy and in the Government. It is shown by a statement made by Scheer in November, 1916:

The dangers which threaten our *U*-boats on these expeditions are so great that they are justified in demanding the utmost support that the fleet can give them in time of need. On no account must the feeling be engendered amongst the crews that they will be left to their fate if they get into difficulties. Fear of loss or damage must not lead us to curb the initiative in naval warfare, which so far has lain mostly in our hands. To us every *U*-boat is of such importance that it is worth risking the whole available fleet to give it assistance and support.

From now on the main mission of the High Sea Fleet became the support of the submarines; they, instead of the capital ship, became the chief weapon used in the German offensive on the High Seas. From now on the Germans made their attack directly on British trade and not on the Grand Fleet. In the last quarter of 1916, the shipping losses increased over 100 per cent.

Admiral Jellicoe was fully alive to the situation. He considered that the Germans would not risk a fleet action for some time, but he was greatly concerned with "the ever-growing danger of the submarine to our sea communications, and the necessity for the adoption of the most energetic measures to deal with this danger." To meet this danger he was called to the Admiralty to become First Sea Lord.

On land the war had been a rapid succession of reverses for the Central Powers. In Galicia the Austrian army had completely collapsed before the Russian attacks; almost one-half million prisoners were taken, and it was only by throwing in all the German reserves that even a semblance of a front was maintained.

General Ludendorff paints the picture on the eastern front with most vivid colors:

Those were terribly anxious days. We gave up everything we had, knowing full well that if the enemy were to attack us no one could help us. And that is just what happened. On July 16 the Russians, in enormous force, poured out from the Riga bridge-head west of the Dvina and gained ground at once. We went through a terrible time until the crisis was overcome, thanks to the valor of the troops and the careful handling of affairs by the Headquarters Staff of the Eighth Army, which was compelled to use single battalions and batteries as reserves. These battles were not over yet at the end of July, when there were sure indications that the attacks at Baranovici and along the whole course of the Stockod would be resumed. We awaited these with a sinking heart, for our troops were exhausted and had long fronts to defend. The Austro-Hungarian troops had lost all confidence in themselves, and needed German support everywhere.

On July 1 the Allied attack on the Somme commenced with initial successes and developed into a grinding battle of attrition. The Allies, having a great superiority in numbers and enormous advantages in artillery, could afford such a battle better than could the Germans. As the battle progressed through August and September, the German losses became heavier and heavier, the divisions more and more exhausted and it was really with the utmost difficulty that the front was maintained.

On August 1 the Italians broke through the Austrian positions, took Gorizia and captured a large number of prisoners.

On September 1, to cap the climax, Roumania entered the war and commenced the invasion of Hungary with a fresh and well-equipped army. On the 7th an Allied offensive on the M.

donian front commenced; this resulted in the ultimate capture of Monastir by the Serbians.

Professor George H. Allen thus describes the situation :

The central empires quivered under the terrific pressure both on the east and west and there was imminent danger that the Galician front would collapse. In the midst of the Battle of the Somme the Germans were compelled to transfer reinforcements from the west to restore the wavering Austro-Hungarian lines. From the beginning of the Russian offensive on June, 4th until the middle of September as many as sixteen infantry divisions appear to have been shifted from the western to the eastern front; while seven Austro-Hungarian divisions were transferred from the hard pressed Italian front, and two divisions were contributed by Turkey. Time will probably reveal further evidence of the intensity of the crisis.

Can there be any doubt but that British naval forces controlling the Baltic and operating in combination with the Russian armies would have brought the war to an end during the last months of 1916?

As it was the Central Powers gradually consolidated their positions on all fronts, concentrated what slight reserves they could make available, and overran Roumania. Thus for the time, their defensive positions were secure. But war cannot be won without attacking. Where were the Germans to attack? On all the land fronts, the Allied Nations had a great superiority. The attack must be made on the sea. Here the Germans still had the submarine weapon. In desperation, like a gambler playing his last card, Germany announced the decision to make use of this last instrument of war which gave hopes of compelling their enemies to sue for peace—the submarine. "The strategic offensive," writes Scheer, "passed definitely to the navy on February 1, 1917. U-boats and the fleet supplemented each other to form one weapon which was to be used in an energetic attack on England's might. Our fleet became the hilt of the weapon, whose sharp blade was the U-boat."

Here we see the paradox of the nation with the greatest army standing on the defensive on land, and the country with the greatest navy forced to the defensive at sea.

The submarine offensive was the important event of 1917. Many authorities have told how near the submarine came to winning the war for Germany. "The danger which confronted the British peoples was never so great in any previous period as it was



during the year 1917 when the submarine menace was at its height." (Jellicoe.)

It is doubtful whether there is any case in history where a navy as weak in comparative fighting strength as was the German, and as poorly based as regards strategic position, has accomplished such important results, by means of methods, however, which the great majority of nations have considered as inhuman and contrary to the principles of international law.

The submarine accomplished the following results in 1917:

(a) Encouraged the armies and civil population of the Central Powers by giving them hopes of ultimate victory.

(b) Brought Great Britain to the verge of starvation and depleted the stocks of fuel oil to such an extent that the operations of the Grand Fleet were limited. "So many vessels were sunk," writes Admiral Jellicoe, "that our reserve of fuel oil became perilously low. Instead of a reserve of some five or six months we were gradually reduced to one of about eight weeks, and in order to economize expenditure of fuel it actually became necessary at one time to issue directions that the speed of oil burning warships was to be limited except in cases of the greatest urgency. Such an order in war time was a matter of much gravity."

(c) Caused a great material loss to the Allies by the sinking of merchant shipping and the loss of cargoes. The tonnage, according to British official reports, lost by Allied and neutral nations was as follows:

Year	Quarter	Gross tonnage
1916.....	Third .....	592,039
	Fourth .....	1,159,343
1917.....	First .....	1,619,373
	Second .....	2,236,934
	Third .....	1,494,473
	Fourth .....	1,272,843

(d) Compelled the Allies to dissipate their energies in building merchant shipping at the expense of their military efforts. The increase of British tonnage built is shown by the following table:

Year	Quarter	Gross tonnage
1916.....	Third .....	124,961
	Fourth .....	213,332
1917.....	First .....	246,239
	Second .....	249,331
	Third .....	248,283
	Fourth .....	419,621

(e) Forced the Allied Nations to build up great anti-submarine organizations, composed of numbers of ships and personnel many times those employed by the Germans in the submarine campaign. The British alone had 3395 auxiliary patrols in commission in British and Mediterranean waters.

(f) Operated very effectively against the lines of communications to the Allied forces on the Macedonian front and greatly limited their operations.

(g) Reduced Italy to a very precarious situation and strongly influenced the collapse of the Italian armies on the Isonzo front.

(h) Enabled the Germans to hold the western front. In a conference on July 13, 1917, General Ludendorff stated:

The superiority of our western opponents in war material, particularly in guns and ammunition, was so great last year that if it had gone on increasing—*i. e.*, by the unrestricted import from America and the maintenance of the enemy's war industries at their highest level—we should have been faced with serious dangers on the western front in 1917. These dangers could only have been diminished by the unrestricted submarine campaign. *If it had not begun no one could say whether we should now still be holding firm on the western front.*

The decision of the Germans to use submarine warfare, on the other hand, brought the United States into the war; and this ultimately decided the war in the favor of the Allied Nations, after the submarine campaign had failed to gain the decision for Germany. There is no evidence to support the German claims that the United States would have entered the war merely to come to the assistance of the Allies, and without the provocation afforded by the submarine campaign.

The effectiveness of the submarine campaign was made possible by the failure of the British to win a decisive victory at the battle of Jutland. Such a victory and a subsequent move of the British into the Baltic would have decreased the results of the submarine campaign in the following ways:

(a) Closed the Cattegat to German submarines, thus shutting off one of their two lines of advance into the North Sea. Even as late as the Fall of 1917, Admiral Jellicoe stated that a British advance into the Baltic was "not impossible," notwithstanding the fact that the entire High Sea Fleet was then in being. Such an operation could not, of course, have been carried through under these conditions, as it would have left the Germans with a superiority in the North Sea.

(b) Prevented German trade with Sweden and thus decreased the supply of material for constructing submarines.

(c) Damaged by bombardment or aircraft attack shipyards on the Baltic coast engaged in the construction of submarines.

(d) The heavy personnel losses which the High Sea Fleet would have suffered would have prevented the submarines from obtaining picked personnel from this source.

(e) The passage of the submarines to and from the North Sea via Helgoland would have been more difficult, as minefields could have been laid comparatively close in to the German bases and would have been more effective than the barrages laid between the Orkneys and Norway. It is not considered that the German bases could have been completely blocked, for, as Commander von Hase points out, "the submarine warfare had been conducted from Flanders without the fleet under much more difficult conditions than those in the North Sea."

(f) A great part of the destroyers, light cruisers, sloops, minesweepers, trawlers, submarines and patrol vessels of various types, which had been operating with the Grand Fleet, could have been assigned to anti-submarine operations. As it happened, these forces were increased. Efforts to obtain destroyers for anti-submarine operations were vetoed by the commander-in-chief, Grand Fleet and the Admiralty. "Those who argued then," wrote Admiral Jellicoe, "or who have argued since, that we should have reduced the number of destroyers with the Grand Fleet will not, I think, meet with any support from those who served in that fleet, *especially from the officers upon whom lay the responsibility for countering any move of the High Sea Fleet.*" Referring to a later date he says: "The Admiralty was pressed to weaken yet further the Grand Fleet destroyer force in order to extend the convoy system, *but did not consider such a course justified in view of the general naval situation.*"

(g) A great part of the capital ships of the Grand Fleet could have been placed out of commission, and their personnel and the energy expended in their upkeep could have been used in anti-submarine operations. As an alternative, these ships could have been kept in commission and used directly against the enemy forces, in the same way the Federal naval forces in the Civil War, having no Confederate fleet to consider, were employed.

(h) The four great battle cruisers of the *Hood* class, whose construction was commenced just after the battle of Jutland, would not have been required, and merchant ships or anti-submarine craft could have been built in their place.

The second great event of the year 1917 was the collapse of Russia. This was caused by the following:

(a) The terrible losses suffered by the Russians in 1914, 1915 and 1916.

(b) The general inefficiency of the Russian Government, which practically broke down in 1917.

(c) The intrigues of the Bolshevists, assisted by German propaganda.

(d) The rout of the Russian Army in Galicia in July, 1917.

(e) The German Riga offensive in September, 1917.

(f) The operation of the High Sea Fleet in October, 1917, which resulted in the Germans gaining the command of the Gulf of Riga, and the capture of Oesel and Moon Islands at its mouth.

Many of these causes of the Russian collapse can be traced to the failure of the British to make the most of their opportunities at Jutland. Had the British been able to control the Baltic, they would probably have been able to have prevented this great disaster to the Allied arms, or, at least, to materially delayed it.

Direct communication would have enabled the Allies to bring diplomatic pressure upon Russia to much greater effect than was actually done. Supplies for the Russian Army would not have had to be sent through Archangel. Allied propaganda would have been more effective. Allied troops could have been sent in to reinforce the Russians at important points, such as at Riga. The presence of a British fleet in the Baltic would have greatly encouraged the Russians, and lowered German influence in Sweden, Norway, Denmark and Finland. It would have cut the German sea communications to Libau, have prevented the Riga operation, and rendered impossible the naval attack on Oesel Island. In addition, the German expedition to Finland in 1918 would have been prevented. All these advantages would almost certainly have kept up such Russian resistance as would have prevented the German concentration on the west front for their great 1918 offensive.

It has been shown how the Germans reached their high-water mark in the spring of 1916; then the tide had turned in favor of the Allies and they had come within an ace of winning the war in the fall; a naval victory had been all they needed to gain the decision.

In the winter of 1916-1917 the Germans had started to gain ground. In 1917 the Germans had continued to make progress, the effectiveness of the submarine campaign, the collapse of Russia, and terrible defeat of the Italians on the Isonzo marking the stages of their advance. In the fall of 1917, they regained the offensive rôle on the western front at the great counterattack at Cambrai. The submarine campaign having failed to win a decision, the German leaders concentrated all their forces on the western front for a final great campaign.

But while the year 1917 had certainly revived the fortunes of the Central Powers and had by outward successes greatly encouraged the civil population, two great and almost unseen influences were slowly but surely exerting their pressure, and building up forces to meet the great German offensive which was threatened.

The first was the steady and remorseless pressure of the British blockade of the Central Powers. As the internal resources of Germany became more and more exhausted, the pressure of the blockade became more and more heavy; it affected not only the military operations of the Germans, but ground down the morale of the civil population by privations and starvation. Germany could hold out only for a short period more, sufficient for one great attack to be made, and even this attack could not be made with its full effectiveness.

The second influence was the rapid and most effective preparation of the United States. In 1917 the United States had not been able to throw important military forces into the fighting lines. Naval forces had reinforced the Grand Fleet, and thus definitely prevented the Germans from ever again contesting the command of the North Sea with surface craft; other naval units had contributed to the gradual breaking up of the submarine offensive. But the principal contributions of the United States in this year were unlimited financial aid and indispensable morale encouragement. These were to play their part in meeting the first blows of the German 1918 offensive; the new American army, being rapidly formed and transported to Europe, was to contribute the

force which finally turned the scales and, in combination with the British and French Armies, to win the final decision.

During 1918 the German Navy still continued the offensive with the submarine weapon, with, however, constantly decreasing effect. The High Sea Fleet made a few raids into the North Sea, but generally limited its operations to a successful support of the submarines. When Hindenburg and Ludendorff, with supreme courage, threw all their reserves against the western front, it is difficult to see why the Germans did not use their battle cruisers, at least, on a raid into the Atlantic at the same time. Had they been able to prevent the sailing of American transports for even two weeks in the spring of 1918, the German Army might have won the war. Nevertheless, the fact that the High Sea Fleet was in being compelled Great Britain to retain 300,000 troops at home to guard against a German landing attack in England. In this way the High Sea Fleet contributed to the success of the great German attack on March 21, 1918.

In the last days of the war, when the German Army was hopelessly beaten, the commander-in-chief of the High Sea Fleet planned a submarine trap in the North Sea, similar to the operation of August 19, 1916. There was no chance that this would have resulted in any important success for the Germans. The mutiny of the German bluejackets, which prevented its execution, therefore had no material effect upon the war, notwithstanding the terrible disgrace it brought to the German Navy.

## VI. SUMMARY OF THE EFFECTS AND RESULTS OF THE BATTLE

Having passed in review the course of the war after the battle of Jutland, we are now in a position to estimate its results. At the time of the battle two salient points of the strategical situation could have been recognized by the British and German leaders. These were:

(a) The Germans had a very little chance of winning a fleet action and any fleet action they might be able to win would not materially improve their strategical position, or have an important effect upon the naval campaign.

(b) The British had very favorable chances of winning a fleet action, and such a victory would improve very materially their

strategic position, and would have a decisive effect upon the naval campaign, if not upon the entire course of the war.

Therefore, it should be regarded as an extraordinary piece of good fortune for the British if a fleet action could be forced upon the Germans. This good fortune was further increased on the 31st of May by two factors which increased enormously the advantages of the British:

(a) The visibility conditions greatly favored the British, a fact which the British commander-in-chief states he knew at the time.

(b) The German fleet was on two separate occasions in the most extremely unfavorable tactical positions with reference to the British fleet.

A striking proof of these disadvantages of the Germans is demonstrated by the fact that the High Sea Fleet scored a total of two hits on the British Battle Fleet, inflicting five casualties.

Despite all the conditions in favor of the British, the Germans suffered far smaller material losses.

The moral results of the battle were favorable to the Germans throughout the world. The battle was a great blow at British naval prestige and tradition.

In judging the effects of the battle on the later course of the war, it is our opinion that the battle had no effect in favor of either the British or the Germans. It left the strategical situation as it found it.

After the action the pressure exerted by both the British and German Navies increased.

The blockade of the British Navy eventually helped to win the war in 1918, in conjunction with the Allied armies.

The German Navy came within an ace of winning the war with the submarine, assisted in the downfall of Russia, helped the defeat of Roumania, played its part in the rout of the Italian Army on the Isonzo, and gave the German Army a splendid chance to win on the western front.

We know the Allies won the war in 1918. But the present situation is only temporary. In ten years from now, who will be the real victor? Only the future can tell.

A victory in 1916 would have been a different victory than the victory in 1918.

## VII. THE LESSON OF THE BATTLE OF JUTLAND FOR THE UNITED STATES NAVY

It would not be suitable for us to endeavor to point out the lessons of this naval battle, when this was done one hundred and thirty years ago by our first great naval commander, Paul Jones. Every American naval officer could do nothing better than to learn by heart the following remarkable statement:

De Grasse had more ships, more men, and more guns than Graves had. His ships were better found and sailed faster, either ship for ship, or measuring the maneuvering power of the fleet by the slowest or dullest of all, than the ships of Graves. In my judgment, there has never been an occasion in all the naval wars between France and England when the opportunity was so distinctly and overwhelmingly on the side of France as in those few October days in 1781, off the Capes of the Chesapeake—when France actually had, for the moment, command of the sea. Now, my dear Kersaint, you know me too well to accuse me of self-vaunting. You will not consider me vain, in view of your knowledge of what happened in the past off Carrickfergus, off Flamboro Head, and off the Liman in the Black Sea, if I say that, had I stood—fortunately or unfortunately—in the shoes of de Grasse, *there would have been disaster to some one off the Capes of the Chesapeake*; disaster more lasting than an orderly retreat of a beaten fleet to a safe port. To put it a little more strongly, *there was a moment when the chance to destroy the enemy's fleet would have driven from me all thought of the conjoint strategy of the campaign as a whole.*

### APPENDIX.

#### NEW INFORMATION CONCERNING THE BATTLE OF JUTLAND

On 31 March the writer sent ten questions to the German Admiralty concerning the battle of Jutland. On 9 June, the answers were supplied by Commander Groos, writing for Vice Admiral v. Mantey of the Naval Archives Section of the German Admiralty:

1. Q. How many German torpedo boats took part in the battle?
  - A. Sixty-five German torpedo boats took part in the Skagerrack battle.
2. Q. How many were with Admiral Hipper?
  - A. Of these, 32 torpedo boats were with Admiral Hipper.
3. Q. What was the total displacement of all the torpedo boats?
  - A. Total displacement of torpedo boats—62,203 tons.
4. Q. What was the distance from Admiral Hipper's scouting line of light cruisers and torpedo boats to the *Lutzow* at 4.00 p. m., German time?
  - A. Twenty nautical miles.



5. Q. About how many hits did the German battle cruisers receive before Admiral Scheer arrived, at about 6.45 German time?
- A. The German battle cruisers received 11 hits (shell) and 1 torpedo hit up to 6.45 German time.
6. Q. How many hits did the German battle cruisers and the first division of battleships receive while pursuing Admiral Beatty to the northward from about 6.45 p. m. to about 8.00 p. m., German time?
- A. About 15 hits. These are subject to correction and it is difficult to determine what part of the total hits should be attributed to the different phases of the engagement.
7. Q. When was the *Seydlitz* torpedoed?
- A. *Seydlitz* was torpedoed 6.57 German time.
8. Q. Are the number of hits received by German ships, as given in my table on page 1767 of the enclosed pamphlet (The High Sea Fleet at Jutland) correct? If not, please inform me of errors.
- A. The actual number of hits received is as follows:
- Derfflinger*, 28, of which 9 were of small caliber.  
*Seydlitz*, 23, of which 2 were of small caliber  
*Moltke*, 4, of which none were of small caliber.  
*König*, 15, of which 5 were of small caliber.  
*Markgraf*, 5.  
*Kaiser*, 2.  
*Grosser Kurfürst*, 9, of which 1 was of small caliber.  
*München*, 5, all of small caliber.
- The others correspond to the table.
9. Q. What were the exact losses of killed and wounded in the High Sea Fleet?
- A. Losses among German crews in the battle:
- |                         |      |
|-------------------------|------|
| Killed and missing..... | 2545 |
| Wounded .....           | 494  |
10. Q. How many German torpedo boats, in addition to those sunk, were damaged by gunfire?
- A. Losses of German destroyers in the battle:
- |                         |   |
|-------------------------|---|
| Sunk by gunfire.....    | 3 |
| Sunk by torpedoes.....  | 2 |
| Damaged by gunfire..... | 6 |

NOTE: German time is two hours ahead of G. M. T., the time used in British accounts.

[COPYRIGHTED]

U. S. NAVAL INSTITUTE, ANNAPOLIS, MD.

---

THE ENGINEERING OFFICER-PERSONNEL PROBLEM

By COMMANDER W. S. McCLINTIC, U. S. Navy

---

HISTORICAL SUMMARY

Engineering officer-personnel in the navy has existed under three distinct systems. First was the old engineer corps prior to 3 March, 1899. Under this system, the engineering officers formed a corps of their own and both operating engineers and those charged with the more expert work of design and construction were members of this corps. This system provided satisfactory engineers, but was the source of so much friction, jealousy, and lack of co-ordination and co-operation between the deck and engineer forces that it was abolished, and its members transferred to the line.

Next came the period of amalgamation. It was not absolute amalgamation, because there remained some officers of the old engineer corps who did not qualify for the general duties of the line and continued to perform engineering duty only, although they were actually transferred to the line by law. Under this system the operating engineers came both from regular line officers and from former members of the engineer corps. The designing engineers came principally from members of the former engineer corps. With the decrease in number of these officers, due to death, retirement and resignation, and also with the inclination of some of them to avoid engineering duty, there eventually arose a shortage of expert engineers for design and construction work. There was no shortage of operating engineers under this system. This was understood to be one of the duties of all line officers which they must be prepared to perform.

Under the amalgamation system, however, the shortage of experts became serious, and this led to the Act of 29 August,

1916, which contained a provision permitting the assignment of line officers to engineering duty only. This is the system under which we are now operating. Under this system, the major portion of operating engineers have to come from the regular line officers, while the necessary experts are supposed to be provided from those assigned to engineering duty only. The purpose of this section of the law was to provide expert designers, etc., and not to provide satisfactory operating engineers, who were already being supplied under the system in effect before the passage of this act.

It cannot be denied that this act has resulted in providing some experts, but how has it affected the supply of operating engineers, who have neither the talent to become experts, nor the inclination to limit their entire naval activities to engineering?

The following discussion is intended to show that, in attempting to cure one evil, this provision of the Act of 29 August, 1916, brought about a worse evil: *i. e.*, a scarcity of operating engineers. That this scarcity exists cannot be denied, and it is worrying not a few officers who have the welfare of the service at heart. With the large increase in the number of ships in the navy, especially of destroyers and submarines, the demand for operating engineers has assumed tremendous proportions. Those officers who have spent much time at sea within the past two years, will testify to the difficulties that have been encountered, not only in obtaining competent operating engineers, but in creating any enthusiasm or willingness among the younger officers to perform engineering duty or to receive engineering instruction.

#### ENGINEERING CONDITIONS BETWEEN 3 MARCH, 1899, AND 29 AUGUST, 1916 .

With the passage of the Act of 3 March, 1899, the officers who had formerly belonged to the engineer corps became line officers. Those who qualified for the general duties of the line performed both deck and engineering duty; those who did not qualify for the general duties of the line performed engineering duty only. While all officers of the old engineer corps were transferred to the line by this act, still certain ones, either through choice or otherwise, did not qualify for the general duties of the line, and consequently, in accordance with the same act, were restricted to the performance of such duty "as is per-

formed by engineers in the Navy." Needless to state, at the time of the passage of this act, such duty "as is performed by engineers in the Navy" was engineering duty and that duty only. This condition was theoretically, although not materially, changed by the Act of 30 June, 1914, as will be indicated later.

Therefore, subsequent to 3 March, 1899, and prior to 29 August, 1916, the navy had no officers whose entire time was devoted to engineering, except those members of the old engineer corps who did not qualify for the general duties of the line. A considerable number of the old engineers who qualified for the general duties of the line, did, of course, actually perform considerable engineering duty. With the passage of time, however, from the natural causes of death, retirement, resignation and promotion, there came a time when those who had qualified for the general duties of the line began to avoid engineering duty, for fear of being discriminated against in assignments to sea duty. Also, the remaining number of those who did not qualify for the general duties of the line became so small as to be insufficient to fill the requirements of the Bureau of Engineering for design, construction, installation, repair and inspection work.

The postgraduate course was started in 1909, and a small number of younger officers were given special courses in various branches of engineering. This should have proved an adequate measure if it had been started soon enough. There are inherent reasons why it must operate slowly. The course at the school is for two years. Upon graduation it is necessary for the graduates to acquire considerable practical experience, before they can be considered qualified as experts for design work, etc. Even then, only a part of them will qualify. Thus it necessarily takes several years before any considerable number can become available.

When the postgraduate school was started, the shortage of experts was already being felt, due to the natural decrease in the numbers of the old engineer corps who continued to perform engineering duty only. Before the output of experts, as a result of the establishment of the school, became appreciable, the shortage appeared serious. It does not seem unreasonable to suppose that if the postgraduate school had been started in 1899 instead of 1909, and thus had time to get into full operation, the flow of experts would have started soon enough and been sufficient to fill all actual

requirements and the conditions would not have arisen which brought about the passage of that section of the Act of 29 August, 1916, which provides for the assignment of line officers to engineering duty only.

In casting about for a more speedy remedy than the postgraduate school, for what was considered to be a serious situation, the pendulum swung back toward a separate corps. It did not swing all the way back to its position prior to 1899, but approached that position.

#### ANALYSIS OF THE ACT OF 29 AUGUST, 1916, AS IT AFFECTS ENGINEERING PERSONNEL

The Naval Appropriation Act of 29 August, 1916, contained the following provision:

Officers of the line of the Navy not below the grade of lieutenant may, upon application, and with the approval of the Secretary of the Navy, be assigned to engineering duty only, and that when so assigned and until they reach the grade of commander, they shall perform duty as prescribed in section four of the Personnel Act approved March third, eighteen hundred and ninety-nine, and thereafter shore duty only as now prescribed for officers transferred to the line from the former engineer corps, except that commanders may be assigned to duty as fleet and squadron engineers: Provided, That when so assigned they shall retain their places with respect to other line officers in the grades they now or may hereafter occupy, and also the right to succession to command on shore in accordance with their seniority, and shall be promoted as vacancies occur subject to physical examination and to such examination in engineering as the Secretary of the Navy may prescribe: Provided further, That the number of officers so assigned in any one year shall be in accordance with the requirements of the service, as determined by the Secretary of the Navy. . . .

It is my understanding and belief that the primary purpose of the framers of this law and of the Congress which passed it was to create a group of officers in the higher grades, limited in number, who would be especially well qualified in engineering knowledge and who could perform duty as designers, builders and inspectors of engineering material. Officers who could satisfactorily perform this duty have to possess engineering knowledge superior, or at least in addition, to that required of an operating engineer and this law was framed with the purpose of permitting officers to acquire this knowledge. It was not the purpose of

the law to provide a large number of operating engineers at sea, although, of course it was not intended to prevent this. Presumably, the law was not intended to discriminate against any class of officers or to grant any unnecessary privileges to any group of officers.

Let us analyze the provisions of the law, however, and see what has been and what will be the consequences of these provisions.

First, let us take the only qualification required of a candidate. An officer "of the line of the navy not below the grade of lieutenant may, upon application, and with the approval of the Secretary of the Navy, be assigned. . . ." No severe qualifications required here. No examination, no exceptional knowledge of engineering required to be demonstrated; no qualification for the general duties of the line other than that he shall have attained the rank of lieutenant! All that is necessary is to attain the rank of lieutenant in the line, make application, receive the approval of the Secretary of the Navy, and become an expert engineer for life! Unless very carefully guarded against, it seems inevitable that sooner or later, practically all applicants are going to be from those officers who have just reached the grade of lieutenant. An ensign, upon graduation from the Naval Academy, is going to make up his mind pretty soon whether or not he will apply for this duty. If he decides to apply, is it not natural for him to use every effort within his power to perform engineering duty while in the grade of ensign and lieutenant junior grade, simply because this will best fit him for his future work? Upon reaching the grade of lieutenant he applies. If his first application is not approved, he will probably not again apply. If his application is approved, to all intents and purposes, forever thereafter he performs engineering duty only. Where and when will he acquire the experience which will fit him for or impress upon him the necessity for that close cooperation between all departments which is required? The answer is that he will not get it, except insofar as his duties during his career as ensign and lieutenant (j. g.) have been such as to inculcate it. Unless the law is administered in such a way that future assignments to this duty come from officers of the grade of lieutenant commander and above, preferably above, this group of officers will eventually consist of officers who have practically no knowledge of the general duties of the line, and will become very closely akin to the old engineer corps.

The above criticism does not apply to a large percentage of the officers now composing the group. Upon the passage of the act of 1916, the first assignments to this group, under the act, were not all drawn from those who had just become lieutenants, but were selected from officers who had been performing the general duties of the line for a number of years. The result is that a large proportion of them have the necessary qualifications for performing the general duties of the line, and do appreciate the necessity for the close cooperation and team work required between the deck and engineer departments. As indicated above, however, it is believed that this condition will soon cease to exist, and the majority of the officers in this group will not be so qualified.

Omitting for the moment the next provision of the law about the kind of duty these officers shall perform at sea, it is next noted that after reaching the grade of commander they shall perform "shore duty only as now prescribed for officers transferred to the line from the former engineer corps, except that commanders may be assigned to duty as fleet and squadron engineers." Presumably, this provision was for the purpose of permitting the Bureau of Engineering (Steam Engineering at that time) to obtain the fullest use of the services of these officers for design, construction, installation, repair and inspection work in the shore establishments, and also because it was not deemed proper to send them to sea as engineer officers of ships after they had reached the grade of commander. Presumably also, it was the intention to limit their shore duty to some form of engineering duty, but a study of other laws shows that the wording of this law does not accomplish this.

In interpreting the above provision, and specifically that part of it which reads "shore duty only as now prescribed for officers transferred to the line from the former engineer corps," it must be remembered that officers transferred to the line from the former engineer corps consisted of two classes: first, those who qualified for the general duties of the line, and were, therefore, eligible for any duty at sea or on shore; and secondly, those who did not qualify for the general duties of the line, and were, by the Act of 3 March, 1899, eligible only for engineering duty, whether at sea or on shore. This in itself is sufficient to show that the above quoted provision of the law does not, with certainty, accomplish what presumably was intended, because part of the old engineers were eligible for any kind of duty. But, to go still further, refer to

the Act of 30 June, 1914, passed over two years before the Act of 29 August, 1916. We find in the Act of 30 June, 1914, the following provision:

That officers who now perform engineering duty on shore only . . . shall be eligible for any shore duty compatible with their rank and grade to which the Secretary of the Navy may assign them.

This, then, made those officers who, under the Act of 3 March, 1899, did not qualify for the general duties of the line, eligible for any duty whatever on shore, within the discretion of the Secretary of the Navy; and completely wiped out all restrictions of law on the kind of duty which former officers of the engineer corps could perform on shore. It, in effect, repealed Section 5 of the Act of 3 March, 1899, which was the section that provided that those officers of the old engineer corps who did not qualify for the general duties of the line, should perform engineering duty only, on shore only, after reaching the grade of commander. Therefore, when the Act of 29 August, 1916, was passed, the provision about the kind of duty which officers assigned to engineering duty only under the act should perform on shore meant nothing whatever. There were no restrictions before, and legally there are none now. Under the law they are eligible for any duty on shore. The requirements of Article 163, Navy Regulations, 1920, is not law. The implication in this article of the Regulations that the Act of 29 August, 1916, required them to perform engineering duty only, when on shore, is misleading and incorrect. The article may have the force of a regulation but it is not law.

While the above conclusion seems to be incontrovertible, yet it is believed to be true that the general impression is that officers assigned to engineering duty only are eligible for engineering duty only, when on shore. Certainly, it has been the custom in the past to so assign them, unless an assignment as industrial manager of a navy yard is considered to be an exception.<sup>1</sup> In fact, Article 163 of Navy Regulations, 1920, requires it. Assuming that they are so assigned, what will be the result? Sooner or later every desirable engineering shore billet will be filled by these officers who cannot be sent to sea.

The inevitable consequence of this condition will be that the young officer will, whenever possible, avoid engineering at sea

<sup>1</sup>This article was written before the present head of the Post Graduate School was ordered to that duty.



unless he expects to apply for engineering only, because, when it comes time for him to go on shore, he knows that he cannot get any shore job for which engineering at sea will have fitted him. This condition exists now to a certain extent, and it is going to become harder and harder to obtain willing operating engineers at sea, except those who intend to apply for engineering duty only.

Another unfortunate feature of this understanding of this provision is that some officers may be under the suspicion of having applied for engineering duty only primarily because they prefer to live on shore. This, of course, is a perfectly natural preference, and it is conceivable that an officer's inclination and willingness to perform engineering duty may be largely influenced by it, but it will not necessarily produce expert engineers.

The third provision is "that when so assigned they shall retain their place with respect to other line officers in the grade they now or may hereafter occupy." Thus, they are not removed from the line and made into a separate corps. They remain line officers, in name, and their commissions read like any line officer's. There is no criticism of the intent of this provision, except insofar as it may be inconsistent with the requirements of other provisions of the law. Is it a good thing to give an officer a commission which is identical in wording with the commission of any line officer and then limit the duty and authority which can be performed under that commission? Insofar as this provision attempted to avoid the formation of another corps, its motive was good; but bad laws sometimes spring from good intentions—the essential thing is to get inherently good laws which, in operation, will work for the good of the service.

The fourth provision of this section of the Act of 29 August, 1916, is that officers assigned to engineering duty only shall retain "also the right to succession to command on shore in accordance with their seniority." No loss of prestige here. Insofar as the exercise of command on shore is concerned, the law makes no change whatever in the status of line officers assigned to engineering duty only. As stated above, under the discussion of the second provision, the law does not require that the shore duty performed by these officers be confined to engineering duty. They are eligible, insofar as the law is concerned, for the position of Chief of Naval Operations, Superintendent of the Naval Academy,

President of the Naval War College, or any other important military and administrative assignment.

The fifth provision is that they "shall be promoted as vacancies occur, subject to physical examination, and to such examination *in engineering* as the Secretary of the Navy may prescribe." It should be noted that their professional examination for promotion is limited absolutely to engineering.<sup>3</sup> Although, by the fourth provision above noted, they still retain their right to command on shore, yet, at no time after being assigned to engineering duty only, are they ever required to show, by examination, that they possess the slightest knowledge of even the first principles of the art of command, navy regulations, military law, naval customs or discipline. The recommendation of the selection board on their cases "shall be based on their comparative fitness for the duties prescribed for them by law," whatever that means. Upon promotion they become extra numbers in their grade.

The sixth provision is "that the number of officers so assigned in any one year shall be in accordance with the requirements of the service as determined by the Secretary of the Navy." This is a very elastic limitation. Who knows how many are going to be added this year or next? Much depends upon the personality of the Chief of the Bureau of Engineering, on his view of the situation, and on his ability to convince the Secretary of the soundness of his views. A glance at the Navy Register of 1 January, 1920, the latest one available, shows that at that time there were 63 line officers assigned to engineering duty only, in addition to 13 members of the old engineer corps who did not qualify for the general duties of the line. The numbers in all other branches, both line and staff, are regulated by law. Why not this one? The larger the number assigned to this duty, the greater will be the tendency to look upon engineering as a thing apart from the duties of regular line officers; the less will be the inclination of unrestricted line officers to seek engineering duty or instruction, and the greater will be the reluctance of commanding officers to assign them to such duty. Certainly the need for expert engineers for design, construction, installation, repair and inspection work, can be de-

<sup>3</sup>General Order No. 49 has been issued since this article was written. In the opinion of the author, that part of General Order No. 49 which requires that engineering only officers be examined professionally on other than engineering subjects, is illegal and cannot be sustained.

terminated within reasonable limits. Having been determined, no more than this number should be assigned to this duty. This provision, without any limitations as it now stands, is pernicious and capable of maladministration.

Referring back now to a point temporarily passed over in the early part of this discussion, we shall take up the subject of the kind of duty which these officers can perform at sea. For convenience, we will call this the seventh provision of the law, although it comes second in the actual wording. It is "that when so assigned (to engineering duty only) and until they reach the grade of commander, they shall perform duty as prescribed in section four of the Personnel Act approved March third, eighteen hundred and ninety-nine . . . except that commanders may be assigned to duty as fleet and squadron engineers." The parenthetical entry is mine.

For convenience, section four of the Act of 3 March, 1899, is quoted:

SEC. 4. That engineer officers transferred to the line who are below the rank of commander, and extending down to, but not including, the first engineer who entered the Naval Academy as cadet midshipman, shall perform sea or shore duty, and such duty shall be such as is performed by engineers in the navy; Provided that any officer described in this section may, upon his own application, made within six months after the passage of this act, be assigned to the general duties of the line, if he passes the examination now provided by law as preliminary to promotion to the grade he then holds, failure to pass not to displace such officer from the list of officers for sea or shore duty such as is performed by engineers in the navy.

It is believed that this seventh provision of the law is the cause of more dissatisfaction with it than any other. The other provisions have been mentioned simply to point out their merits or evident defects. Their defects can probably be remedied; by legislation, if need be. But this provision, which governs the privileges which these officers enjoy and the restrictions to which they are subjected, while serving at sea, is not capable of such a satisfactory solution.

It is not clear to some officers of the service whether or not officers "assigned to engineering duty only" in accordance with the Act of 29 August, 1916, are eligible under the law to succeed to command afloat; and whether or not, when on duty as head of the engineering department on board ship, they are eligible to stand day's duty, as required by regulations in the case of the other

heads of departments. As a matter of fact, the two duties require the same eligibility, because, if they are eligible to stand day's duty, when all seniors leave the ship they must be eligible to command. Otherwise the acting executive would be senior to the commanding officer—an absurdity. The question of eligibility is somewhat complicated by the unfortunate wording of Article 1003 (6) of the Navy Regulations, 1913, reprinted, without change of intent, as Article 150 (7) of the Navy Regulations, 1920.

Personally, I can see only one interpretation in accordance with the laws above quoted, and that is that an officer "assigned to engineering duty only" in accordance with the Act of 29 August, 1916, is not eligible at sea to succeed to command, to stand day's duty or, in fact, to exercise any authority whatever, outside of his own department. In my opinion, an ensign of the line, not assigned to engineering duty only, would exercise command over any officer so assigned when afloat. Any other procedure would appear to be illegal.

In reply to a request from the Commander-in-Chief, Atlantic Fleet, for an interpretation of Article 1003 (6), Navy Regulations, 1913, the Judge Advocate General rendered an opinion which was approved by the Secretary of the Navy on 29 May, 1920, and which may be read in full in Court Martial Order No. 76, 1920 of 31 May, 1920.

The following is quoted from the Judge Advocate General's opinion:

As above indicated, it would be clearly inconsistent with law to authorize a line officer who is restricted by law to the performance of engineering duties only to exercise military command afloat. . . .

Article 1729 (4) Navy Regulations, 1920, is to the same effect; and, indeed, is probably based on the Judge Advocate General's opinion.

Notwithstanding the above opinion and regulations, however, there are officers who believe the opposite to be the true interpretation of the law; and I understand that there is at least one battleship in the Atlantic Fleet upon which the engineer officer, who is an officer "assigned to engineering duty only," rotates with the other heads of departments on day's duty.<sup>2</sup> What would happen, and who would be held responsible, in case of disaster, while

<sup>2</sup> April, 1921.

this officer were acting as temporary commanding officer, would be an interesting legal question.

Entirely aside from the legality of the procedure, however, is the question of its *desirability*. Let us assume, first, that the present opinion of the Judge Advocate General and the provisions of the Navy Regulations will govern, and let us analyze the resulting situation.

*First.*—The “engineering only” officers, being interested primarily in engineering, and being limited absolutely in their duties to the engineering department, will become more and more absorbed in that particular feature of the ship, at the cost of their interest and enthusiasm for the ship as a whole. Cooperation, teamwork and ship’s spirit will suffer.

*Second.*—The “engineering only” officers will often find themselves subject to the orders of their juniors in rank, and frequently to their inferiors in ability. It may be argued that these officers should appreciate this possibility before they apply for the assignment. True enough, but this will not soothe the feelings of some of them under the above conditions. This has already been the cause of some officers regretting that they ever applied for, or were assigned to, this duty. The desire to command is inherent, and is not lightly put aside. One cannot foresee all the possibilities of the future. Ill feeling will result, and the drifting apart mentioned above will be accelerated.

*Third.*—On no ship will the other heads of departments desire to have an “engineering only” officer as engineer officer, because this will require the other heads of departments to stand all the day’s duty. In other words, it works against the popularity of this class of officers, and engenders a spirit of class distinction and discrimination which is exceedingly detrimental to a united service.

Now let us assume that the “engineering only” officers are not restricted in their right to command at sea, or that, if they are, the restriction could be removed by legislation. The following would appear to be reasonable deductions, if such conditions existed:

*First.*—Within a few years we would have officers succeeding to command at sea who are in no sense qualified to do so. It is undoubtedly true that a large percentage of the officers assigned at the present time to engineering duty only are officers who have had sufficient general training to qualify them for the performance of the general duties of the line and for exercising command.

Still, the law is such that this condition will probably not continue. The law makes the rank of lieutenant the lowest rank eligible for assignment to engineering duty only. As a matter of fact, a large proportion of those who have been assigned, have been of a rank higher than lieutenant so that, undoubtedly, for the present, most of them have had the experience which qualifies them for the exercise of the general duties of the line. This condition was brought about by the fact that prior to 29 August, 1916, there was no such thing as "engineering duty only" except for certain officers of the old engineer corps; and, with the passage of the act, the first increments to this group came largely from officers who had had considerable all round general duty. These are the officers whom we have at sea now. It seems that, of necessity, this condition will rapidly change with the promotion of the officers who are now in the lieutenant commander's grade. Looking into the future, will it not necessarily be true that, with the law on the statute books and well understood by everybody, the future additions to this organization will be composed largely of younger officers who have just reached the grade of lieutenant? These younger officers will make up their minds early in their careers that they will apply for assignment to engineering duty only and, consequently, so far as lies within their power, will perform the duty which will best qualify them for the performance of their special duty, after they are assigned to engineering duty only. If this is the case, it certainly seems reasonable that the average officer of the future, who is assigned to engineering duty only, will not have had the experience necessary to qualify him for the general duties of the line, or for exercising command at sea. As above stated, they are not examined for promotion on anything except engineering subjects. The result under this second assumed interpretation of the law, therefore, would be that, within a few years, we should have officers succeeding to command who are in no sense qualified to do so; and it would then be necessary, but extremely difficult, to reverse the policy.

*Second.*—They already retain their right to command on shore; they choose the duty which they are to perform; they are examined for promotion, only in engineering; upon reaching the grade of commander they perform shore duty only, and thus occupy practically all the desirable engineering shore billets. If they should also be given the right to exercise command afloat—the inherent

right of the unrestricted line officer—they would become a privileged class, indeed.

It seems apparent, therefore, that no matter which interpretation is placed upon this seventh provision of the law, it is not going to work for the best interests of the service.

#### CONCLUSIONS

It is evident from the foregoing study, that the provisions of law which authorize the assignment of officers to engineering duty only were loosely drawn, and that they do not accomplish what was evidently intended and desired.

It was intended and desired to avoid friction, jealousy and lack of cooperation between the deck and engineering forces. The law has fostered these to a large degree.

It was intended and desired to avoid discrimination against or humiliation of anyone. The law so works as frequently to incur both.

It was intended and desired to avoid the formation of any "close organization" or "special privilege" group. The law has created the latter to an unusual degree.

It was intended and desired to limit those officers assigned to engineering duty only, and who had reached the grade of commander, to the performance of engineering duty only, on shore only. The law does not impose any restriction whatsoever on the duty which they perform on shore.

It was intended and desired to provide a limited number of expert engineers in the higher grades, for design work, etc. The law has accomplished this at the cost of enthusiasm or willingness on the part of the younger line officers to perform engineering duty at sea, with the inevitable result that the navy is lamentably short of skilled operating engineers.

#### SOLUTION

With the provisions of the Act of 29 August, 1916, in effect, the navy is not getting the required number of skilled operating engineers. *These are the navy's greatest engineering need at the present time.*

The primary purpose of this paper is to invite service attention to the subject, and to point out as clearly as possible the peculiar

requirements of the Act of 29 August, 1916. To many, there will appear to be one obvious solution, but the subject must be considered from all angles. It is only by thought and discussion in the service, that a satisfactory solution of the problems confronting it will be arrived at. The following points are submitted, therefore, as a basis for discussion; and should be considered in seeking a satisfactory solution of the problem of obtaining and maintaining an efficient engineering personnel, whose primary thought will be "the good of the service":

(a) The requirements of the service for operating engineers have got to be met by the average line officer not restricted to engineering duty only. If this is not the case, and the operating needs are to be met by wholesale appointments to the engineering only group, then we, in effect, revert to the old engineer corps, already tried and found wanting.

(b) Real amalgamation will remove all causes of friction, jealousy, hurt pride, or special privilege which are fostered under the present law, between those officers of the line who are restricted to engineering duty only and those who are not.

(c) Real amalgamation will impress upon line officers the necessity for looking upon engineering as a part of their regular duties which they must be prepared to perform.

(d) If enthusiasm for or willingness to perform engineering duty can be created among the younger line officers, the problem of providing sufficient operating engineers will take care of itself. Of course, there must be a realization on the part of commanding officers that a fair proportion of the officers on board must be assigned to the engineering department. It is folly to expect that the engineering department can be run efficiently if other departments have all the choice in the assignment of officers. If the engineering department is discriminated against, either in numbers or quality of officers assigned, it can reasonably be expected that poor results will be obtained. The percentage of officers assigned should be based on the stations to be manned in action, on the routine work required for upkeep and division duty, and on the necessity for a reasonable number standing watch. On first class ships it would seem that a watch in four is the lowest which should be required in the engineering department.

(e) Real amalgamation, *especially with the aid of postgraduate courses*, will always provide a certain number of officers who are



better qualified along particular lines than the average officer. Those officers particularly qualified in engineering should be the ones assigned for design, construction, installation, repair and inspection work in engineering where the duty is beyond the capacity of the average officer. This method is followed, either with or without postgraduate courses, in all other branches of line activity, notably in ordnance and navigation.

(f) Real amalgamation will impose a certain limit on the complexity of the machinery design, in that it must be operable by the average officer. The designer, being himself a seagoing officer, will appreciate the necessity for simplicity and ruggedness of design.

It would appear that the repeal of that section of the Act of 29 August, 1916, which provides for the assignment of line officers to engineering duty only, and the consequent return of all the officers to the performance of the general duties of the line, should be the first steps towards solving the problem. Whether or not there is any middle course is open to discussion, but the disadvantages of forming a special group should be carefully considered. At any rate, it must be remembered that all line officers of equal rank, at sea, should be in exactly the same status as regards the exercise of authority and the enjoyment of privileges.

[COPYRIGHTED]

U. S. NAVAL INSTITUTE, ANNAPOLIS, MD.

---

## DISCIPLINE<sup>1</sup>

By CAPTAIN E. B. FENNER, U. S. Navy

---

In the consideration of abstractions it is of first importance to get clearly before our minds a definite idea of the subject under discussion, consequently it is well, first, to find out what discipline is. After all the talk on this subject for the past six years, and particularly to naval officers, such an inquiry may appear pedantic; but it is more than likely that, if each of you were to write out a definition of discipline, no two would exactly agree and many would differ fundamentally.

Suppose we start with what seems to be a very wide spread popular notion of the meaning of discipline, as gleaned from articles in the public press of the whole country, from very yellow dailies to very blue weeklies and monthlies. I have read scores of such articles, and from them would construct a definition somewhat as follows: Military discipline consists in the giving of unnecessary orders in the most irritating way possible by totally incompetent individuals who have obtained in some underhanded manner the legal right to wear an officer's uniform. It is silly of course, and the mere existence of our army and navy through voluntary enlistments for over a hundred years should prove its folly; doubtless does so prove it to people who think. Boys from 17 to 20, however, have never been noted for careful and logical thinking, so that the sort of propaganda against military discipline that is embodied in my popular definition falls upon more or less fertile ground both among men already in the service and in those who contemplate enlisting.

Another more insidious form of anti-military propaganda preaches that military life requires a harsh and brutal discipline

<sup>1</sup> A lecture delivered before officers at Mare Island Navy Yard, October, 1920.

and consequently that harshness and arrogance in military officers are to be expected—in fact are necessary. If such an impression be wide spread, and apparently it was and is, then upon the vast expansion of our military forces made necessary by actual war, many of the young men from civil life, made officers overnight, will conscientiously try to be “hard boiled”; and thousands of other young men, serving as recruits under them and having practically no contact with the small nucleus of trained regular officers, will leave the service more than ever convinced of the correctness of their preconceived ideas, thus completing the vicious circle of error. From what I have read about our vast national army, when only one officer in forty was a regular, I am convinced that much, if not most, of the disciplinary friction was the direct result of a thoroughly well-intentioned effort on the part of young civilians in uniform to live up to the story book type of bucko mate that, if it ever did exist in the regular services, has been deader than Pharaoh for more years than my knowledge of the service covers. The converse of this trouble was observable among other equally conscientious young men who had made up their minds that, come what might, they would not become arrogant militarists and who, to carry out their determination, never gave an order without apologizing for it.

It is on this account that such ideas, however silly, become important and it rests primarily with the officers of the regular service, so to understand and teach the true meaning of discipline, that such erroneous notions shall die.

There are many other false ideas of discipline, but perhaps we have spent enough time on what it isn't and would better progress to what it is. We naturally turn first to the dictionary, but dictionaries record usage and usage varies as may be seen from a list of synonyms of discipline taken from Webster: instruction, training, culture, correction, chastisement, punishment. Obviously, if these are all proper synonyms for discipline, it must be a very chameleon of a word. One of the best dictionary definitions is as follows: “Discipline; severe and systematic training, especially with a view to right conduct or prompt and effective action.” In general, it is safe to say that the one underlying idea of the varying synonyms and definitions of the dictionaries is that of the control of individual instinct or desire by some kind of authority. The variations in usage result from differing ideas as

to the means of attaining such control and these means of attainment divide themselves into three broad classes, material, mental, and moral, so that we have the discipline of law or force, with material reward, usually money, for well doing; the discipline of public opinion, with the applause of the community as a reward; and the discipline of conscience, with self respect as a reward. Each of us is under the influence of one or all of these compulsions in practically every act of a civilized existence; without such discipline civilization would cease to exist and men would become beasts.

The more thoughtless, ignorant or brutalized a man is, the more the law's "you must," with punishment in the background and dollars in the foreground, are necessary to insure right conduct and strong effort; but there are very few of us who never need it. Would the sign board along the road saying "Reduce speed to 15 miles" invariably be respected if there were no fear of speed traps and subsequent penalties? Which would produce more teachers, the offer of \$10,000 a year salaries or the desire to do good?

With the average man, public opinion when definitely and strongly expressed, is probably the strongest incentive to well-doing or at any rate to doing the thing that public opinion approves. Every decent man despises a thief, and probably this universal feeling has more to do with keeping down thievery than fear of a definite punishment. Sometimes, often in fact, public opinion is strongest on customs whose violation involves no moral turpitude whatever. Which of you would walk up Fifth Avenue with a beaded bag in one hand and a pretty pink parasol in the other? There would be no harm in it, but public opinion demands a certain uniform for men which may be varied a good bit, but never beyond the limits laid down. Why do men like to see D. D., or LL. D., after their names? Because it means that some recognized body has considered them worthy of honor and public opinion gives a value to the symbols.

Last of all and by far the finest and most efficient instrument of discipline for high-grade men is that which comes from within. We may call the impelling motive conscience or honor or self-respect or a sense of duty or a dozen other names but, whatever we call the motive, it is that which drives upright men along the strait path with greater force than all the external compulsions

of the world, the flesh and the devil. For men in whom this internal urge is strong, there is no greater reward than the satisfaction of a job well done.

To recapitulate, we have three lines of operation in inculcating discipline, six if we take both negative and positive sides of each: physical punishment and material reward; popular praise and popular censure; conscience and self-respect.

So far we have considered discipline in general as applied to everyone, now it is time to specialize on military discipline and to look into the reasons for the aversion to it so commonly met with. Partly, even largely, this aversion is due to the total lack of comprehension of the subject already dwelt upon; which, to a great extent, must always exist in a thoroughly non-military nation like our own. Partly, also, it is due to a dislike of all restraint which is very noticeable among our individualistic fellow-countrymen. Partly, however, it must result from differences in the civil and military methods of applying that "training for right conduct or for prompt and effective action" which, as an end, must be approved by all reasonable people. Do these differences in method exist; what are they; are they unavoidable? To answer these questions we must look into the six disciplinary compulsions I have mentioned and see to what extent each one applies both in civil and in military life.

#### MATERIAL REWARD AND PUNISHMENT

Most material things can be bought for money, so that material reward and money reward are practically synonymous. Under present conditions we certainly can offer a good living to all men who will make the navy their life work and by judicious promotion can keep the financial factor always a real incentive for good work. You will, however, all agree that no naval officer or man who devotes his effort single-heartedly to his profession can ever attain wealth, so that the glitter and lure of great possessions, one of the mightiest driving forces in civil life, is totally lost to us. Few men ever attain wealth, but fewer still, in all probability, fail to see it ahead in their young day-dreams.

Punishment, on the other hand, is always available in a military service. It must be used to a considerable extent in controlling a crowd of irresponsible youngsters, full of ginger and, very prob-

ably, away from home restraints for the first time in their lives. Punishment is simple, often it is effective and always it is easier to apply in military than in civil life.

#### POPULAR PRAISE AND POPULAR CENSURE

Popular opinion in matters of morals and conduct is a plant of slow growth. It isn't always right or reasonable, but usually it directs the people along those paths that years, generations and even centuries of experience have found to lead to success for the individual and comfort for the community. The one essential to sound and valuable public opinion, however, is a thorough understanding of the conditions under which people have lived and worked, not for a day or a year, but for many years. "Honesty is the best policy" is a bit of crystallized public opinion that would never have been formulated from a few observations; the temporarily successful rascals are too numerous and too conspicuous. Long continued observation, however, shows the general truth of the proverb. Again, public opinion is most effective when the individual realizes that he and his connections are well known and that his acts are observed closely by that portion of the public whose opinion decides his standing in the community. A young man, or an old one, in his home town is far more careful of his conduct than he would be in some distant city or foreign country where public opinion ignores his existence as an individual.

Popular praise usually sees only the actor in the spotlight of wealth or of newspaper fame. In time of war the soldier or sailor has the front page; he is a person of first importance to the community and, on the whole, the disciplinary effect is good so long as the interest lasts, although there is too much emotionalism in this interest to make for steady development. In time of peace there is practically no public interest in the service men and, in war or peace, there is never in this country an intelligent public opinion on military affairs based on a thorough understanding of the aims and needs of the services. Indeed, such an intelligent public opinion on military life and training as exists on civil affairs is an impossibility anywhere. The man in business decides on a plan of operations, tries it out next week in full view of his neighbors, fails or succeeds; and his experience immediately adds so much fairly accurate knowledge to the foundation on which in-

telligent public opinion is built. The military man decides on a plan of operations and then, so far as actual experiment is concerned, he waits for the next war which may occur in his lifetime, more probably in that of his son. If the plan continues to live in the minds of a few specialists it is the best that can be hoped for and its success or failure will be merely one isolated military fact so far as the public consciousness is concerned, without any known connection of cause and effect.

It seems then that military discipline has little hope of assistance from public opinion either in the way of censure or praise except in time of war. Since, fortunately, the peaceful years of our country so much exceed in number the warlike ones and since our disciplinary work of preparing for war must nearly all be done, if we are to succeed, before war comes, we must regretfully give up public opinion as an aid to military discipline except in so far as we can create a public opinion within the service, which is entirely possible with fairly long enlistments, but desperately difficult when we keep the men only a year or two. It may be said in passing that, one of the chief functions of the Naval Academy and of our training stations is to make a start in the creation of this service public opinion.

#### CONSCIENCE AND SELF-RESPECT

As the internal compulsion of conscience is by far the loftiest of all impelling motives toward upright conduct, so, also, is it the slowest of growth. If conscience began to develop only after entry into the service we should have a hopeless task in our training. Fortunately, however, most fundamental military virtues are universally recognized as virtues without the military prefix and we can benefit by every bit of moral training a young man has received before enlistment, provided the special needs and aims of military life are properly presented to his intelligence, and provided again that a reasonable degree of intelligence exists, which it does with 90 per cent of our men. The very lack of material reward as an incentive to well-doing may be of assistance in the development of sense of duty, for in the pursuit of financial success dollars are apt to obscure the light of conscience. Again, in a service where financial competition is wiped out, we are apt to get a clearer view of the intrinsic merits of the job itself; and we know that when we do a good piece of work people, in the service

at any rate, won't look wise and wonder how much we got out of it. This certainly makes for self-respect; in fact it may make for excessive self-respect and is doubtless responsible for many of the accusations of snobbery against military men.

It would appear then that conscience and self-respect are at least as powerful motives in the service as out of it, perhaps more powerful, always provided we make the effort and have the time to adapt general moral training to the specific needs of a military life.

From this rather hasty survey of the disciplinary means at our disposal it is evident that punishment, conscience and self-respect, all of them the more austere driving forces, are readily available in a military life; while material reward, public praise and public censure, the more emotional and usually the less distasteful types of moral compulsion, are comparatively lacking. This situation, I believe, is the basic reason, and a genuine reason, why people in civil life, and a good many in military life as well, dread and dislike military discipline. Add to such a feeling the mistaken idea that punishment is our *only* means of procuring "right conduct or prompt and effective action," which mistaken idea is much fostered by the use of the word disciplinary when punitive is meant as in "disciplinary measures," disciplinary barracks," etc., and it is no wonder that discipline has a very bleak sound in most ears. If we can get rid of this last positively false notion, the necessary austerity of military discipline will frighten no one who understands it.

So far we have discussed the nature of discipline and of the means to its acquirement; now a few words must be said on the mental and moral conditions we are trying to establish by the use of these disciplinary tools, and something as to the concrete methods of applying our theories of discipline. Doubtless there are many valuable by-products obtainable from a military training, such as respect for authority, patriotism, knowledge of various trades and so on. The one logical reason for the existence of an American Navy, however, is that our government may be protected from forcible outside interference in the elaboration and execution of its policies; in other words, the navy is a war engine pure and simple and we succeed or fail as officers in direct proportion as our engine functions or fails to function under the



war conditions; that is, under conditions of physical hardship, mental excitement and moral disruption conducive to emotional insanity. Our pacifist friends often point to the state of society during and after a war as evidence of the evils of military training. They say military training precedes war, demoralization follows it, therefore military training produces demoralization; as well say that sanitary measures precede epidemics and death follows, therefore sanitary measures produce disease and death. Military discipline aims so to teach control of man's natural instincts that pain, fear, excitement and every other disruptive emotion will glance off his moral trench helmet and leave him still a reasonable human being ready to act intelligently whether on orders from without or initiative from within. Naturally, with most men, this is an ideal impossible of attainment, but it has been attained by some great military characters and every step by which we approach it is a step toward our goal.

The various forms and conventions of military life have been devised through 50 centuries of study by the greatest minds the world has produced for the production of this moral result and may fairly be presumed to be good if not the best measures for the production of the desired result. At any rate, a discussion of naval and military laws and regulations is too broad to go into now and we must confine ourselves to a consideration of the best means of bringing non-military young men into a state of mind which accepts contentedly and intelligently the kind of life that is governed by those laws and regulations.

It will be well, perhaps, to keep to our original classification of means and to start with:

#### PUNISHMENT

It goes without saying that, to be effective, punishment must be just, but that isn't enough; the man being punished must recognize the justice of the punishment if it is to be of real corrective value. It takes time and patience to explain without undue preaching the why of every report, but the officer who does so will find that he has fewer and fewer reports to make. It will be found that at least nine-tenths of the cases that come to the mast are the result of infractions of regulations that were made for the protection and well-being of the men themselves. If a man

overstays his liberty some one else must do his work ; if he fails to look out for his clothes, he is apt to lose them, or some one else must pick up after him, perhaps some one else will be suspected of theft ; if, as a cook, he fails to keep things clean, or to prepare food properly his shipmates suffer. A hermit living in the midst of a wilderness can do about as he pleases and no one would care, but in a military life, and particularly in the navy, we live so close together that every act is bound to affect our shipmates and it takes a great many rules on apparently petty subjects to prevent the friction that results from such crowded conditions. A boy on the farm if he feels grouchy can go out in the woods until he gets over it ; on board ship he must stick it out in the crowd and until he is able to exercise self-restraint, the restraint must be applied from outside if other people are to have any peace and quiet at all. All these things are obvious enough, but men don't stop to think of them and an officer can do much by bringing up such subjects before his division. Keep this need for added consideration and courtesy on account of crowding before men's minds ; remember it yourselves when some one shows a burst of temper, very possibly due to crowd irritations, and many a punishment will be made corrective if not rendered altogether unnecessary.

Another very common class of offenses that brings men to the mast is a failure to recognize the government's property rights. Men waste food, break up gear, lose their identification tags and so on. Each individual loss seems trivial and the government is rich, but if you impress upon the waster what would be the loss when multiplied by a hundred thousand, he will be well on the way toward reformation and the punishment assigned will be recognized as just.

I do not hold the theory that punishment should be kept for wilful evildoers exclusively. Some people will continue to be careless until they find that the results of carelessness in the shape of punishment are more unpleasant than the necessity for taking thought. The one idea that should be impressed on every person in the naval service, however, is that punishment is assigned for the correction of the individual and still more for the protection of the community ; never for revenge nor from caprice. If that idea is thoroughly believed by the service at large we shall have gone as far as we can, for there is no immediate prospect of a

golden age in which a wholesome fear of the laws' penalties can be dispensed with entirely.

#### REWARD

The man who works only for the material reward involved isn't apt to be a very safe reliance at times when the reward offered looks small compared with the effort, hardship or danger involved in the work. We must have higher motives than this to produce men who will be faithful under all the difficult conditions of military service. On the other hand, "The laborer is worthy of his hire" and it is right that men should look forward to proper recompense for their efforts.

In times past it has been difficult to convince men in the navy that they were getting such recompense; now, however, the service offers a great deal in the way of financial independence for life to the average man who sticks to it for 16 or 20 years. The benefits of the new pay system for enlisted personnel, particularly in regard to reserve and retired pay have been presented to the service at large most convincingly by the Bureau. Those who heard the advantages so lucidly stated and saw the illustrative charts were much impressed, but such impressions fade quickly in the minds of young men whose ears are better attuned to the tales of easy money on the outside. There is also the constant stream of new recruits to be considered, so that, if an understanding of and belief in the financial attractiveness of the naval service are to be maintained, the officers on ships and at training stations must keep the feeling alive by thorough study of the system and frequent explanation of the whole subject, particularly to newcomers and to the man about to be paid off, with a pocket full of money and the feeling that "the world is his oyster."

Promotion is another kind of reward that is a valuable aid in disciplinary matters, but it is to be used with discretion if we are not to produce the type of man who tries to shift constantly from job to job or from ship to ship in the pursuit of possible ratings. Character should count for quite as much as professional ability when men are promoted to positions involving added authority and responsibility. We have all seen the petty officer who knows his job thoroughly, but causes dissension and discontent wherever he goes.

Cash prizes for marksmanship, etc., are useful, though they are of worth chiefly in inspiring emulation and interest rather than for intrinsic value.

Special privileges in the way of liberty or temporary relaxation of discipline, special "spreads" in recognition of good work may also be classed as material rewards and are useful, always provided the rewarding is not carried to such an extent that it is expected every time any one does his simple duty.

To sum up, reward and punishment are both essential to the maintenance of military or any other discipline, but when you find a man who can be reached in no other way than by hope of reward or fear of punishment, better get rid of him. A discipline which depends solely on these impelling forces is absolutely certain to break down under strain, as that of the Russian Navy did when the officers ceased to inspire fear.

#### PUBLIC OPINION

It has already been shown that we are largely debarred from the use of ordinary public opinion as a disciplinary force when we are dealing with the special conditions of military life. It is a tremendous force in all communities and will grow up in all communities that have any permanence; but, as any one knows who has had dealings with schools or other large aggregations of boys or young men, it is entirely possible that the public opinion which grows of itself, like Topsy, may be so warped that the evil in it is equal to the good. That kind of public opinion is a menace to military organizations. Because of the suspicion and distrust of military discipline that is so prevalent, service public opinion is more than apt to glorify the man who successfully evades or resists such discipline and this brand of service opinion is, in too many cases, upheld by people outside the service.

Public opinion can be created, but here we meet another difficulty, for such opinion must in large measure be produced by an appeal to the emotions and emotionalism is as nearly as may be the direct opposite of discipline which is the control of instinct and emotion, by rule and authority. The solution is that we use emotional stimuli to produce a state of mind that will consent to rigid restraint when these restraints are necessary to the accomplishment of an object. For example, the strong emotions aroused

by athletic contests furnish the motive in a football team for the rigid restraints and hard work of training and practice.

The first step in the creation of a valuable public opinion in the service is to break down the feeling that no one knows or is interested in the individual and hence that his conduct makes no difference if he can avoid punishment. When he feels that he is a necessary part of his division and a well-known member of the ship's company, much has been accomplished, and if, in addition, he believes his division to be the best in the ship and his ship the best in the fleet, the problem is practically solved. Competition is without doubt the quickest and easiest method of obtaining the result provided the competitive spirit does not degenerate into ill-natured jealousy which is destructive to a broad service spirit and hence kills any service-wide public opinion which we wish to create.

Genuine interest tactfully expressed by officers in a man's work or play is of the utmost value in forming good public opinion. Credit publicly given when credit is due helps, but don't be too effusive, or you will merely embarrass the man, and give a handle to those who may accuse him of bootlicking. The thing to strive for is a condition aboard ship where the men themselves will admire and express their admiration for the sailor who is a good man-o-war's man.

Among officers, particularly those who have spent four years together at the Naval Academy, there is a widespread acquaintance throughout the service that is a great help in producing navy spirit and navy opinion as distinguished from ship spirit and ship opinion. Officers also are more apt to know the proud history of our navy, and its honored traditions, which should form the foundation of all our service opinion. About the only obvious and universal evidences of common training and common navy customs that the enlisted man sees are the uniform and the salute which is reason enough in itself for our most earnest effort to have both uniform and salute respected. Try to impress it upon the men that the civilian identifies the military man by uniform and salute and is far more apt to respect the clean and correct uniform and the snappy salute, than the slovenly uniform and the sloppy salute that looks as if it were given only because the saluter is afraid to neglect it entirely. Above all let there be no failure on the part of the officer to wear his uniform properly

and to return every salute punctiliously. There have been far too many such failures of late and one such undoes the work of weeks of precept and training.

#### CONSCIENCE AND SELF-RESPECT

Probably the necessary first step in creating a seaman-like conscience and awakening a seaman-like self-respect lies in arousing a man's interest in some phase of his work. All the methods of arousing service public opinion are of assistance in this for a man's own interest in any subject is very dependent on the interest of his fellows in the same subject. Praise for a piece of work well done, no matter what its nature, may be the turning point in a man's service career. I have seen a recruit mess cook of the messiest sort, praised by his captain for a good looking table at Saturday inspection, take a new grip on life with this little boost to his self-respect and from that day start on a course of honest effort that gave him a rating within the year.

Rousing a man's interest by finding a job that is congenial is often of the greatest value. We cannot constantly shift men from job to job and have the ship's work go on, nor can any amount of shifting satisfy a discontented temperament, nevertheless much may be done in that direction if you take the trouble to know your men. After the service conscience is well-developed men will do distasteful work from a sense of duty; if they are utterly disgusted in the beginning, the conscience may never develop.

By many people self-pity is mistaken for self-respect and a more serious error would be hard to find, for the man who indulges in self-pity becomes a whiner than which nothing is more contemptible. The antidote for self-pity is an honest pride and every effort should be made to develop such pride without allowing it to degenerate into stupid egotism. Pride makes for truthfulness and honorable dealing, self-pity for lying and shiftiness; the mast gives plenty of examples of each from day to day.

Cooperation, taught by precept and example in the every day work of the ship, is the best of schools for the development of a service conscience. Everything said under the heading of punishment on the subject of cooperation and fair dealing with shipmates applies with double force when dealing with moral discipline. Most of our young men believe in fair-play and, if you can con-

vince them that the comfort and success of their shipmates depends in no small measure on their efforts, you have gone far on the road to a well-developed service conscience. The importance of each individual doing his own job well no matter how unimportant it seems can be exemplified in endless ways. One of the most striking and effective examples was the substitution of a green man for a trained one in the least important station of a well-drilled turret's crew. The time of loading was about doubled and the members of the crew saw the point and commented on it without a word from the turret officer.

Constant nagging about truth, honor and duty will do more harm than good, nevertheless we must not be afraid to mention such subjects at suitable times. Above all try to make men feel that you confidently expect to find truth, honor and loyalty in them and, as a rule, the qualities will appear. Confidence begets loyalty and truth just as surely as suspicion and distrust beget deceitfulness.

Finally, let me urge again that we keep constantly before the men the idea that discipline is the one essential to reasonable comfort under crowded shipboard conditions. It is so concrete, so obvious, that every recruit can accept the fact without long experience. Once the necessity for discipline even to a limited extent is brought home to him, we have a foundation upon which to build our structure of habitual, intelligent and self-respecting discipline that is the ideal for our American Navy.

In looking over what I have written on this subject of discipline, I was somewhat surprised to find that the words obey and obedience do not appear once. The failure to use those words was entirely accidental; but not, I think, without significance. To the non-military man discipline means nothing but forced obedience to the will of others; to me, who has lived under military discipline for 25 years, obedience to duly constituted authority is so reasonable and natural that I never think of it at all. Far from finding obedience humiliating, it is merely a part of the job like the steering of the ship or the firing of the furnaces. One's mental and moral independence is in no way weakened by submitting his acts to a discipline in which he believes, even though some of the individual requirements may not appeal to his judgment. The true

sailorman sums it up by saying "It's all in the day's work" and shows his pride and self-respect by doing the day's work to the best of his ability.

If self-respect is no enemy of discipline, egotism very decidedly is and it is injured egotism that produces complaints both long and loud of the awfulness of military discipline. The man with too much ego spends all his time feeling sorry for himself and growling about a lack of consideration from his superiors; but it is a rule, never broken so far as my experience goes, that such a man placed in a position of authority is harsh and overbearing to his subordinates. The reason is the same in both cases, he sees only his own side of the matter.

Paradoxical as it may seem, the navy is, in the best sense of the word, a socialistic organization whose motto might very well be "From every man according to his abilities, to every man according to his needs." Like every other socialistic body it will founder on the rock of selfishness unless, through military discipline, we can blot out petty and unessential individualism for the good of the service.





[COPYRIGHTED]

U. S. NAVAL INSTITUTE, ANNAPOLIS, MD.

---

APPROXIMATE ALTITUDE AND AZIMUTH

By LIEUT. COMMANDER L. V. KIELHORN, U. S. C. G.

---

It is the purpose of this article to show the practical value of a little used spherical projection for the determination of azimuths of heavenly bodies with sufficient accuracy for plotting positions by the Marcq St.-Hilaire method, for finding approximate altitudes so that a sextant may be set and the bodies picked up on the horizon, and for identifying stars and planets.

Fig. 1 is a stereographic projection of the celestial sphere on the plane of the horizon for Latitude 40. The projection of the zenith of the observer is at the center of the diagram. Passing through this projected point are two straight lines at right angles to each other, representing the projection of the meridian and the prime vertical of the observer, the extremities of which mark the north, east, south and west points. The curved lines intersecting at the pole are hour circles and are plotted for each 10-minute interval from the central meridian, marked negative east of the meridian and positive west of the meridian. The circles at right angles to the hour circles are diurnal circles and are shown for each five degrees of declination. For convenience these circles may be called declination circles.

It will thus be seen that the projection is a map of the heavens for the latitude of the observer with the observer's position at the center and that any heavenly body may be projected upon it having given its declination and local hour angle as coordinates, provided it is above the visible horizon. The direction of the body's plotted position from the center of the diagram is the azimuth of that body and the bearing may be read off directly on the graduated arc forming the periphery. A straight edge passed through the center of the diagram and the plotted position will facilitate the reading of the azimuth. Thus, by reference to the diagram (and

to Fig. 2) a star whose hour angle is three hours west of the meridian and whose declination is 15 degrees north, bears  $250\frac{1}{2}$  degrees. When the sun has an easterly hour angle of six hours and a declination of zero a glance will show that it is in the horizon,

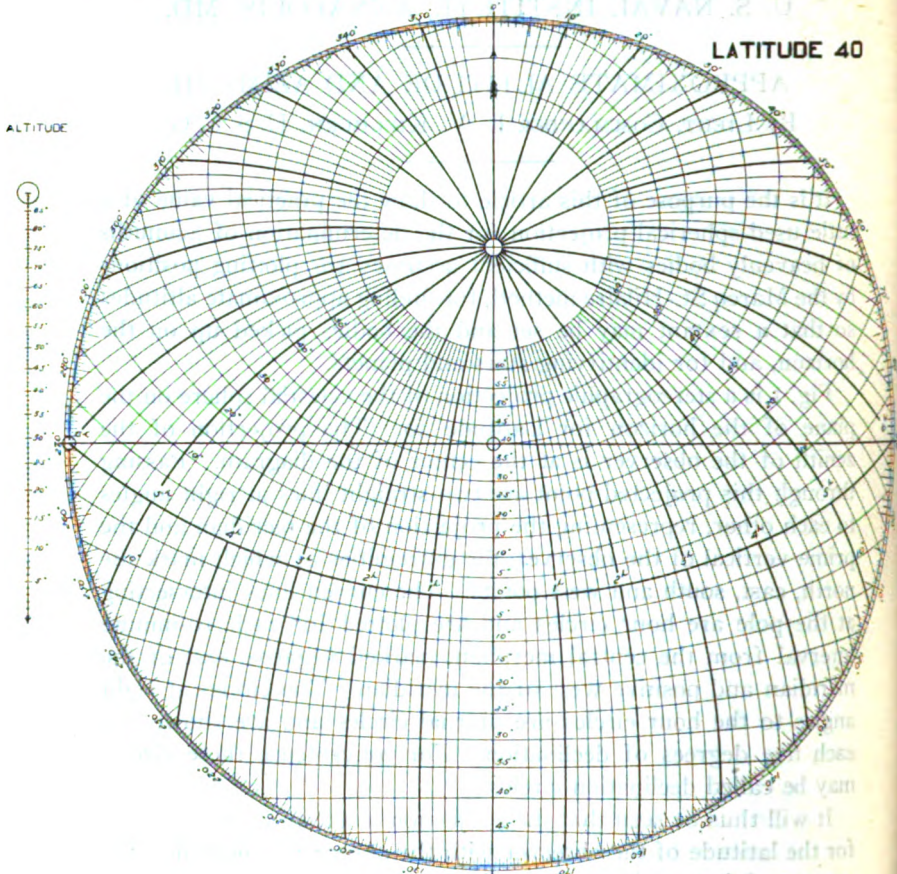
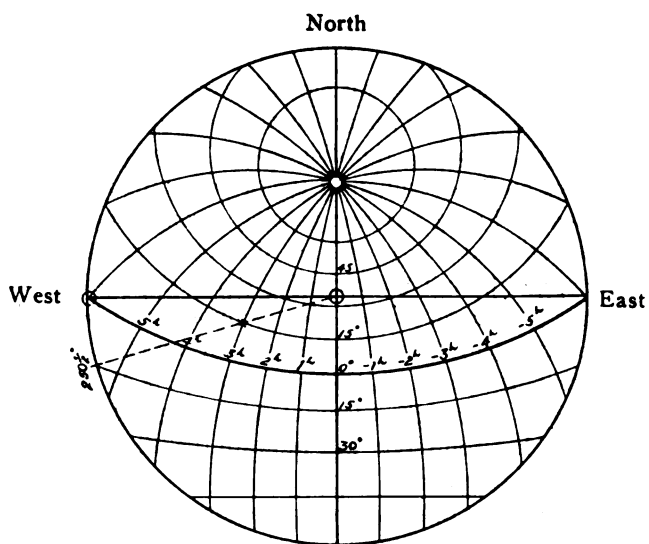

FIG. 1.

bearing 90 degrees. When this same body has easterly hour angle of three hours (and the same declination of zero) it will bear  $122\frac{3}{4}$  degrees. Let us follow the diurnal path of a body whose declination is 15 degrees north: It will be in the true horizon when its hour angle is  $(-)$   $6^{\text{h}} 52^{\text{m}}$  and will bear  $70\frac{1}{4}$  degrees. It will cross the prime vertical when its hour angle is  $4^{\text{h}} 48^{\text{m}}$  and



South  
FIG. 2.

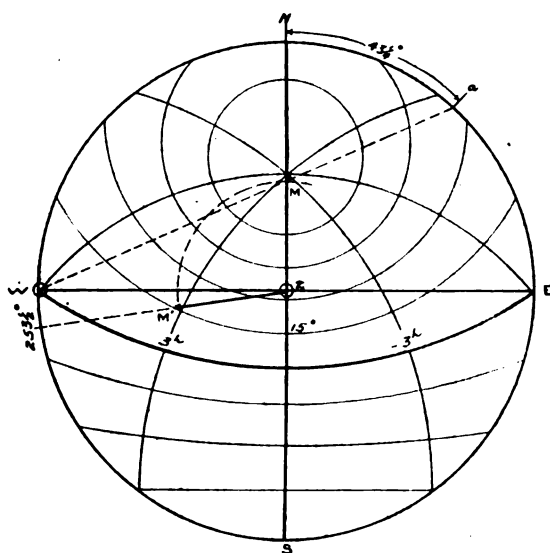

FIG. 3.

will cross the meridian, bearing south, when its hour angle is zero. It will again cross the prime vertical at  $4^{\text{h}} 48^{\text{m}}$  and be in the western horizon at  $6^{\text{h}} 52^{\text{m}}$ .

To find the altitude of a body plot its position on the diagram for the latitude of the observer and measure its distance from the center. With the center of the diagram as a point of origin lay off this distance on the meridian of the observer toward the north point as shown by Fig. 3. A line passing through the west point and the northern extremity of this distance, extended to the horizon circle, will permit the altitude of the body to be read off directly on the graduated circle. For example, let a body have a declination of  $16\frac{1}{2}$  degrees north and an hour angle of  $3^{\text{h}} 7^{\text{m}}$  west. Plot its position  $M'$  (Fig. 3), take the distance  $ZM'$  as a radius and lay off  $ZM$ . A straight edge passed through  $W$  and  $M$  and extended to the horizon circle will indicate the altitude, which in this case is  $43\frac{1}{2}$  degrees.

It will be found that this approximate determination of altitudes is of considerable aid in making star observations during evening twilight. Select a watch time, say, of 10 minutes after sunset (for a latitude of 40 degrees) and find roughly (to the nearest minute) the corresponding local sidereal time. Then look up the right ascensions and declinations of the brighter stars expected to be the visible at that time. Apply the right ascensions to the local sidereal time to determine the local hour angles. With the local hour angle and the declination of each star as coordinates plot the positions on the diagram and find the altitude and azimuth of each star. With the sextant set to the approximate altitude and the pelorus clamped to the predetermined bearing the star should be found on the horizon at the time selected. I have found it possible to get a round of stars in this way before any one of them was easily visible to the naked eye. The resulting accuracy of such observations under such favorable conditions well repays for the three or four minutes preparation. In the tropics, where the duration of twilight is short and where the time taken to find the star and to bring it down to the horizon can ill be spared, this "wrinkle" is of especial value. If for any reason the observation at the time selected cannot be obtained, the altitude may be changed slightly, increased if the bearing is east, decreased if west, in an amount depending on the interval and bearing, or if greater ac-

curacy is desired, the altitudes and bearings may be determined for two different times with but little additional work.

If the following example is followed closely the ease and rapidity of the work will be apparent:

On August 1, 1920, in Latitude  $40^{\circ} 00' N.$ , Longitude  $45^{\circ} 00' W.$ , it is required to determine the approximate altitudes and bearings of the following stars 10 minutes after sunset: Antares, Vega, Arcturus, and Altair.

	a	m
L. M. T. of sunset	7	10
		10
	<hr style="width: 50%; margin: auto;"/>	
L. M. T. of observation	7	20
R. A. M. S. August 1	8	39
Red. for G. M. T.		2
	<hr style="width: 50%; margin: auto;"/>	
Local sidereal time	16	1

## ARCTURUS

Declination  $19\frac{1}{2}^{\circ} N.$   
 R. A.  $14^h 12^m$   
 H. A.  $1^h 49^m W.$   
 Bearing (from diagram)  $237^{\circ}$   
 Altitude (from diagram)  $59^{\circ}$

## ALTAIR

Declination  $8\frac{3}{4}^{\circ} N.$   
 R. A.  $19^h 47^m$   
 H. A.  $3^h 46^m E.$   
 Bearing (from diagram)  $106^{\circ}$   
 Altitude (from diagram)  $31^{\circ}$

## VEGA

Declination  $38\frac{3}{4}^{\circ} N.$   
 R. A.  $18^h 34^m$   
 H. A.  $2^h 33^m E$   
 Bearing (from diagram)  $80\frac{3}{4}^{\circ}$   
 Altitude (from diagram)  $60\frac{3}{4}^{\circ}$

## ANTARES

Declination (—)  $26\frac{1}{4}^{\circ}$   
 R. A.  $16^h 24^m$   
 H. A.  $0^h 23^m E.$   
 Bearing (from diagram)  $174\frac{1}{4}^{\circ}$   
 Altitude (from diagram)  $23\frac{1}{2}^{\circ}$

Having made an observation of an unknown star or planet it may be readily identified by the diagram if its approximate bearing is taken also. Lay off the altitude of the star on the graduated circle. Let the straight edge of a sheet of paper pass through this point and the west point of the diagram, as shown by Fig. 3 and note where it intersects the central meridian. Take the distance from the center of the diagram to this intersection and

lay it off in the direction of the bearing of the star, with the center of the diagram as a point of origin. The extremity of the line is the plotted position of the body, and its hour angle and declination are at once determined. Apply the local sidereal time to the hour angle to find the right ascension, and reference to the nautical almanac will complete the identification. An example may be more to the point.

On May 1, 1920, at  $10^{\text{h}} 00^{\text{m}} 00^{\text{s}}$  G. M. T. ( $7^{\text{h}} 38^{\text{m}} 05.2^{\text{s}}$  L. S. T.) in Latitude  $40^{\circ} 00' \text{ N.}$ , Longitude  $75^{\circ} 00' \text{ W.}$ , a bright star was observed through a break in the clouds at an altitude of  $43^{\circ} 15'$ , bearing  $253\frac{1}{2}^{\circ}$  true. What is the star's name?

Solution: Referring to the diagram and to Fig. 3, lay off the altitude of the star  $Na$  ( $43^{\circ} 15'$ ) and let the straight edge of a sheet of paper pass through  $W$  and  $a$ , intersecting the central meridian at  $M$ . With  $ZM$  as a radius and  $Z$  as a point of origin lay off  $ZM'$  in the direction of the star's bearing  $253\frac{1}{2}^{\circ}$ ).  $M'$  will then indicate the declination of the star, which in this case is  $16^{\circ} 30' \text{ N.}$ , and its hour angle, which is  $3^{\text{h}} 7^{\text{m}}$ . Subtracting the hour angle from the local sidereal time gives  $4^{\text{h}} 31^{\text{m}}$ , its right ascension. Reference to the nautical almanac identifies this star as Aldebaran.

The projection shown by Fig. 1, while designed to be used for Latitude  $40^{\circ} \text{ N.}$ , may also be used for the corresponding parallel of south Latitude, the only change necessary being to shift the azimuth scale 180 degrees.

As the projection is sufficiently large when constructed with a diameter of eight inches a set made for each degree or for each 2 degrees, covering 60 degrees of either north or south Latitude, forms a small convenient pamphlet, an advantage which, with its wide range of usefulness, will commend itself, it is hoped to the navigator.

The author has constructed for his own use a set of these projections, a blue-print copy of which he will be pleased to send any officer who would like to give them a try-out.

[COPYRIGHTED]

U. S. NAVAL INSTITUTE, ANNAPOLIS, MD.

---

## GUNNERY AND TURRET DESIGN

By COMMANDER H. F. LEARY, U. S. Navy

---

*Naval gunnery* is the science and art of using guns at sea.

As a *science*, it deals with the motions of projectiles, elucidates the laws which govern their deviations; determines the probability of their attaining the objects aimed at and calculates their effect.

As an *art*, it is concerned with the actual handling of guns and studies how to obtain accurate and rapid fire from a single gun and how most effectively to combine the fire of a number of guns.

It is the art of gunnery which should principally concern the naval officer, the highest object of whose ambition it should be to make the fire of the guns under his command, whether a single gun, a turret, a ship's battery, or the combined batteries of a squadron, the most effective possible.

The *theory* of gunnery, except in an elementary way needs but the attention of the specialist; the *practice* of gunnery is essential to the efficiency of every naval officer, and may almost be said to be his proper life-work.

It is the gun which is the determining factor in naval actions, and to the gun everything else should be subordinated in the design, construction and tactics of warships. The other features of men-of-war have no *raison d'être* except in so far as they serve to bring the guns into action and to maintain them there. Protection to buoyancy and stability is merely for keeping the battery afloat, and protection to guns and men is merely for maintaining the battery in operation under hostile fire; coal endurance and speed are merely for extending the battery's field of action. All these things give endurance and power to the battery. The essential object of the officers and men too, from the commander-in-chief down, is to use the ship's batteries. The fighting efficiency is measured by their ability to do good work with the guns which they control. They may one and all be at the highest point of efficiency in every other branch of their profession, skilled in seamanship, and in navigation, linguists, well versed in military and international law, and all these things may avail them nothing in that decisive hour of battle, for which their lives should be a preparation; *then* it will depend primarily upon their skill in gunnery, upon how effective the gun fire of the ship or of the squadron is, whether



they shall triumph or go down to merited and perhaps even disgraceful defeat.

The efficiency of every warship in the last analysis is the efficiency of her battery, and it is the highest duty of every officer on her, and above all her commanding officer, who is responsible for her efficiency, not only to see that the best possible results are obtained from the material on board, but also to see that defects in material and equipment are remedied, and that any possible improvements are recommended for adoption. Of course there will always be defects in our ordnance material, but they can only be remedied and improvements made through the co-operation of the officers who are using them with those who control their design and construction. If we are to hope for steady progress towards perfection our Bureau of Ordnance must be ready at all times to make changes which are real improvements, and at the same time those afloat, while unremitting in urging improvements must do their utmost with what they have, and not assume the attitude of the poor workman who blames his tools for his bad work. There will always be questions in ordnance about which there is difference of opinion, even among those best qualified to pass opinion, but the freest possible discussion, and honest constructive criticism of ordnance designs and gunnery methods cannot but lead to marked improvement.

It may be well to start with a short summary of the progress of gunnery in our navy, in order to show how from year to year the requirements have progressed and the demands for improved material have produced the changes desired and have led to the adoption of our present equipment. The Ordnance material and methods in use at the time of the Spanish war were for that day considered excellent, and it is doubtful if at that time our turrets or methods were surpassed in the British, French, or German navies. After the Spanish war, however, in considering the lessons learned and the needs in ordnance and gunnery, for our modern navy, a marked change took place. Officers in our service began to realize that the types of target practice then in vogue, and the general battle conditions which our material should be called upon to meet were not in accord; that the practices did not create sufficient interest on the part of officers and men, did not test the ordnance material to the extent necessary, nor were the practices so difficult as to create a demand for improved equipment. It is interesting to note that in March, 1900, the commanding officer of the *Amphitrite* submitted to the Bureau of Navigation recommendations regarding a uniform system of gunnery instruction based on the experience of that vessel as a gunnery training ship and it is quite remarkable to note the many

points considered at this time which are now current practice in gunnery training. Based on these recommendations, the Bureau of Navigation issued General Order No. 9 of September, 1900, covering gunnery instructions for cruising vessels. This was the first real start on systematic gunnery training. About this time, Admiral Sims, then a lieutenant who was on the Asiatic Station, recommended sweeping changes in the methods of gunnery training then in force, based on information obtained from methods being tried out by the British. He, in conjunction with several officers of that station, made alterations in gun sights, bought telescopes, and requested a new system of target practice, based on his ideas of the proper methods for gunnery training. A strong appeal was made to the Navy Department to institute some such system of target practice for the whole navy. This was done by President Roosevelt; and Admiral Sims was appointed as Director of Target Practices. There was a great deal of opposition on the part of a number of the officers to such radical changes; a great many thought then, and there are some who now think, that it is unnecessary to have competition in order to produce efficiency. In 1903 Professor Alger wrote his prize essay on "Naval Gunnery," an extract from which is quoted at the beginning of this article. In March and April, 1903, the Atlantic fleet took up this new system of target practices and held them off Pensacola, Fla. On board the old *Texas* (San Marcos) Captain Nulton, then gunnery officer, developed a fire-control system and various schemes of checking sight setters, sending ranges, spotting and analyzing results; and, strange as it may seem, the methods of analysis now in use in the fleet are not very dissimilar from these early efforts. At the first target practices, held off Pensacola and on the Asiatic station, the results were very good considering the material. It was shown, however, that changes would have to be made in methods of handling our ammunition, graduating sights, and in the systems of obtaining and transmitting the range. During the following years, everyone was keyed up on the subject of gunnery. Gunnery instructions were issued in 1905, explaining in detail the new system, showing how the training should be conducted and giving the principles of the elementary fire control then necessary, and how the practices should be conducted.

As the result of several years work it was demonstrated that turret arrangements were not safe; this was evidenced by the *Massachusetts* explosion in an 8-inch turret in 1903; the explosion in the after 12-inch turret of the *Missouri* in 1904; an explosion in the 13-inch turret of the *Kearsarge* in 1905, and again on the *Georgia* in 1907 (8-inch turret). It began to look as if the navy could not hold a target practice without some terrible casualty. Everyone in the fleet was doing his utmost to make his turret, battery and ship shoot fast and hit. Some mistakes were of course made in the handling of material, but on the whole it cannot be said that the unfortunate accidents were wholly the fault of the personnel. We learned by bitter experience, and it is most fortunate that the efforts made by a few misguided officers to have the practices abandoned were not successful.

The explosion on the *Missouri* brought about the installation of the gas ejector system, flame shutters between the turret chamber and handling room, and the two-stage turret hoists fitted on all ships from the *Michigan* class on. It became known what a "flare-back" might do. The accident on the *Massachusetts* brought about precautions in regard to opening the breech plug, and improved designs of firing locks; that on the *Kearsarge* called attention to the danger of exposed switches in the turret in rear of the breech; in fact, the present "Safety Precautions" were built up on lessons learned in those days, and to those of us who followed the game each precaution has its own history.

In 1907 at the time of the cruise around the world, a Turret Board was ordered to make a thorough investigation into the defects and needs of the navy, regarding turret design and construction. General recommendations were laid down which should guide the Department and Bureau of Ordnance in the design and operation of turrets. These continued in effect, being revised from time to time, until the recent revised Turret Board's report of 1919. It is rather surprising to see that in the period of 10 years, from 1907 to 1917, the general principles of turret design and construction had not changed as much as one would expect. The developments led to the introduction of the two-stage hoist and three-gun turret, but the general requirements remained much the same. It may also be noted that after the investigations made by the Turret Board in 1907, and due to the various precautions put into effect, and the modifications made to nearly all turrets,

but few accidents have happened. Meeting the demands of the fleet, the officers in the service themselves devised and superintended the manufacture of improved sights, breech mechanisms, and turret gear; and also outlined the methods necessary adequately to serve and control the guns. The "Ship and Gun Drill Book" was prepared by a board of experienced turret and battery officers. In 1913 the "Gunnery Instructions" were revised and the manual now in use (1920) is based mainly on this work.

The fact that the above results were not all done earlier is not considered as a criticism upon the officers in the service prior to 1900, nor of the ability, desires, or work of the navy at that time. With the small amount of money and lack of attention given to the navy during this period by Congress, and the few new ships authorized for a more modern navy there was not the opportunity or incentive to make such strides as have existed since then. So from the Spanish War up to the present time the navy has expanded in every direction, and the forms of gunnery exercises have kept pace with the world's leading navies; ever making greater demands for improved methods and material. Especially since the beginning of the last war, the service has constantly had before it the question, "Are we equipped with the best material and using the best methods that can be *used for action?*"

Just because a ship does well at target practice is no absolute criterion of her readiness for battle, and in the battle efficiency inspection begun in the fleet by Admirals Fletcher and Badger, and perfected by Admirals Mayo and Grant, many ships were found that were not entirely ready for battle; and it was found that not all the material in use was sufficiently adequate in type or quality successfully to compete with the British or German navies in a modern naval engagement. After much argument in 1915, rules were formulated to open fire at long range (18,000 yards). This change was urgently recommended by Admiral Fletcher, then commander-in-chief of the fleet, and put in the Rules by a committee from the fleet, of which Captain Kearney was the head, as fleet gunnery officer. The results were most gratifying; since then the fleet has felt confidence in its ability to open fire at the maximum range of its guns, and turret designs were changed to give increased angles of elevation of  $30^{\circ}$  for vessels of the *Tennessee* class and  $40^{\circ}$  for the 16-inch 50 ships cali-

ber. The recent improvements in design have included the adoption of a quick-acting breech mechanism for turret guns in which the motion of translation of the plug has been eliminated, and the closing is effected by an air cylinder, very little power being required as the weight of the breech block is taken by counter-balance springs. All turrets since the *Michigan* have been fitted with chain rammers, which are a material improvement over the old telescopic rammers, with their wire cables, which were a frequent source of casualties. In all new designs, the powder and shell supply to the guns has been separated, and the vertical reciprocating shell tube is now the standard in all modern turrets, the powder supply being either by a reciprocating car or a conveyor type hoist. The design of gun trunnions has been improved materially of late and is now considered as being entirely satisfactory as regards reduction of friction and self-lubricating features. The period during the war has witnessed the general introduction of the director system of firing, and this system, for both main and broadside batteries, has now been adopted as the primary system, as opposed to the old system of pointer fire. The advantages are many and well known, and due to the extreme difficulties of target designation, and of seeing the target at long ranges, and through smoke, splashes from enemy shorts, etc.: the use of aloft directors has become general. The demands of concentration firing, aeroplane spotting and use of kite balloons have also added some minor changes. The increase in battle ranges has led to the adoption of the pneumatic recoil and counter recoil system, as the spring designs were unsatisfactory for returning guns to battery at the high angles necessary. It is believed that the above covers in a general way the features of importance, that have been brought out by gunnery development, and we will consider the question of turret design in general terms.

About 12 years have elapsed since the construction of the dreadnought was decided upon, and this period has witnessed the developments in the design and armament of capital ships, which may be taken to cover the progress of modern armament, as the revolutionary changes introduced at that time furnish a definite starting point. The plans of this type of ship introduce a new governing principle into battleship armament, which has become known as the "all big gun," or "single caliber" armament in

contradistinction to the previous type of armament. The former policy of installing a mixed battery with generally four guns of the heaviest type, and a large number of intermediate and secondary guns, was due to the erroneous belief that it was not advisable to increase the number of heavy guns due to the large increase of weight involved, and the low rate of fire from these guns. The intermediate guns by their great volume of fire, were considered more effective against the personnel and upper works of the enemy, thus silencing his fire. It has been definitely established as a result of target practice, that the heavier the projectile the more accurate the shooting will be, and as the standard of gunnery efficiency is "*rapidity of hitting*," the "all big gun," "single caliber" ship has become recognized as affording the maximum of effectiveness. Additional reasons for this type are: the amount of armor that can be installed on a ship being limited, it is impossible to assign sufficient weight adequately to protect a long broadside of intermediate guns against the fire of heavy guns; also the presence of smaller guns reduces the rapidity of fire, hence the effectiveness of large guns due to the interference in the fire control arrangements. Modern vessels are now being successfully armored against the fire of small guns and the personnel will be behind this armor; thus the small gun will be useless except for defense against torpedo attack. The high state of development to which gun and torpedo fire have been brought has also led to an increase in the probable future battle ranges, again militating against the use of small guns. The selection of the caliber and type of gun for the primary armament of a battleship is a problem still open to great controversy. At the present moment there exists a fairly strong current of opinion in favor of increase of caliber, as shown in the armament of the most recent ships of the principal naval powers. This general change of opinion which has taken place relative to primary armament is to be attributed in part:

- (a) To the increase in battle ranges.
- (b) To the improvements in ship protection.
- (c) To the practice of filling armor piercing projectiles with high explosives.

The increase in battle ranges and the improvements in armor both necessitate an augmentation in the striking power of the

battery. There are several ways of accomplishing the desired result:

- (1) By an increase in the caliber of the gun.
- (2) By an increase in the weight of the projectile.
- (3) By changing the shape of the projectile to obtain better ballistic qualities.
- (4) By increasing the initial velocity.

(1) It has been demonstrated by actual firing that a gun of larger caliber, having a moderate initial velocity is able to fire a far greater number of accurate rounds than a gun of smaller caliber having a high velocity. Thus, since for the same velocity, at the same range, the penetration increases with the caliber, for a given penetration, the greater the caliber the lower the velocity, and the longer the life.

(2) If the weight of the projectile is increased, while the initial velocity remains the same, a greater amount of energy is obtained by an increase in the weight of the charge and an increase in the maximum pressure, which means an increase in the erosion of the gun equivalent to a diminution in accuracy and in the life of the gun. An increase in weight of projectile with a lower muzzle velocity may give better penetration at long ranges, but the loss in danger space must also be considered. An increase in the angle of fall also increases the cross-breaking stresses of the projectile on impact with vertical armor.

(3) By changing the shape of the projectile, a very material increase in range with corresponding increases in flatness of trajectory and in danger space, and finally in striking velocity and penetration, are obtained, especially at long range. By changing the radius of the ogival head from  $2\frac{1}{2}$  to 7 calibers, the striking velocity has been increased by fully 30 per cent. The value of this change cannot be emphasized too strongly, for it is a gain in the true sense of the word, since it increases the value of a gun 30 per cent without any cost whatever; the charges, the velocity, and the pressure being the same for a long pointed projectile as for a blunt pointed one, the gain being entirely due to the reduction in the resistance of the air to the projectile in flight.

(4) By increasing the initial velocity, the striking energy of the battery can be increased, but in this case as well as that of the increase in weight of the projectile, the gain cannot be obtained without increasing the charge, the maximum pressure, and the

erosion, consequently, not without shortening the life of the gun. If, however, the same muzzle energy of the gun is used, the heavier projectile will show better than the lighter, high velocity one, especially at the longer ranges.

The practice of filling A. P. projectiles with high explosives is now universal. The general tendency at the present time is to require projectiles not only to perforate the heaviest armor now existing, but also to carry a large charge of high explosive. If a large projectile has a penetrating power greater than the heaviest armor, it is clear that the capacity of the shell cavity can be increased more than proportionately to the increase of caliber. Thus the larger the caliber, the greater the shell cavity, the heavier the bursting charge, and the greater the efficiency of the projectile.

As before stated, it has been proved by actual firing that the heavier the projectile, the more accurate the shooting; consequently, from the viewpoint of accuracy, penetration, and effectiveness, the caliber of the gun in the primary armament should be as large as possible. Now, the larger the caliber, the heavier the armament; and the greater the space required for its installation on board ship, where these two factors, weight and space, are always limited; consequently, as in most engineering questions a compromise must be made to determine the "smallest big gun" that will fire a projectile that not only penetrates at *battle ranges*, the heaviest armor afloat, but also carries a sufficient quantity of high explosive to insure the desired effect *behind the armor*, all this with a reasonable margin of assurance and no more.

The most advantageous composition of battery, as regards the caliber, having been determined, it remains to decide upon the arrangement of the battery, in order to obtain the greatest arc of fire, or maximum fire efficiency from each gun. As the ahead-and-astern fire is necessarily limited and must always be less than the broadside fire, it follows that main engagements will tend to use broadside fire in order to have the maximum number of guns in action; and, as a gun that fires on either broadside is equal to two guns that fire on one side only, the endeavor is to place all, or as many guns as possible, on the center line, due regard being paid to obtaining the greatest height above the water line consistent with maintaining the proper stability of the vessel. Great care is also necessary to avoid "interference" between guns due



to the blast effect, etc. Superposed turrets, which increase the number of guns are objectionable, as they are too cramped to furnish proper ammunition supply, and add materially to the height of the enemy's target. It was the recognition of the above principles by American designers, in the plans for the *Michigan* and *Delaware* classes of vessels that first led the way to the now accepted designs for vessels of this class. The most conspicuous result of the adoption of the "all big gun" principles has been the intensified competition between naval powers for the possession of the largest and most powerful units, the result being an expansion of dimensions aimed at increasing the actual or proportionate power of the broadside by adding to the number of guns available on the beam. The first vessels built on these principles for Great Britain, Germany, Japan, and the United States, all had eight guns bearing on the broadside, but with differences in the aggregate power required to produce the broadside. The *Michigan* class obtained it with a total armament of eight big guns, having four twin turrets on the center line. The original dreadnought needed ten guns, having only three turrets on the center line and two abreast on the beams. The German and Japanese had six twin turrets to produce an 8-inch broadside, two turrets on the center line, the other four being placed in pairs abreast. The "beam fire efficiency" of the various types—the relation of broadside to the total armament—was, therefore, 100 per cent for the United States, 80 per cent for the British, and 66.6 per cent for the German and Japanese. The United States design undoubtedly *was*, and *is*, the most efficient, and has been consistently followed ever since by its Navy Department. All other powers have come to the center line arrangement for their capital ships, the differences being merely in the number and caliber of guns adopted for the primary armament. The American practice is that the controlling factor in battery arrangement is the number of turrets and not the number of guns, and it is believed that the four 3-gun-turret-arrangement presents the best all around solution of the problem.

To sum up, the general conditions governing the primary armament of the modern capital ship are as follows:

- (1) The greatest weight that can be allowed to the armament.
- (2) The number of guns required.

- (3) Their disposition within each turret (twin, triple, quadruple).
- (4) The disposition of the turrets (superposed, etc.) affecting the weight of armor carried.
- (5) The weight and number of rounds of ammunition carried.

It is evident that for similar types of guns and turrets, the larger the caliber of the gun, the larger will be the turret and the greater the ammunition weights; and although modern design has done something to reduce the ratio it is still very large.

In one respect, the theoretically perfect arrangement of guns of a fleet would be to have them mounted in single turrets widely separated. Then damage to one gun would not put another good one out of action, but to do this would necessitate a ship of enormous size, and other vital characteristics would have to be surrendered. Economy of space could not be obtained in a single gun turret and all machinery and other mechanical equipment necessary for the control and service of the battery would be required in complete sets for each gun; whereas, in the case of more than one gun in a turret, a certain part of this mechanical equipment can serve all guns in the turret. Upon the other hand the theoretically perfect arrangement for director firing would be to have all guns on a ship in one turret in one mounting. With one ship engaged such an arrangement would invite defeat owing to the chance of all guns being put out of action by one shot. But if several such ships were engaged the effect on the outcome of the engagement is reduced as the number of ships engaged (within reasonable limits) is increased.

In general, the developments in turret design have progressed from the use of a single gun in a turret, to a maximum of four guns in a turret. It may be accepted that this development is based upon sound principles and follows a corresponding increase in the size of the navies of the principal powers. The primary objects to be accomplished in the design of a turret are accuracy and rapidity of gun fire, and efficiency and reliability of all mechanical features of the turret, combined with the maximum possible protection against damage by the enemy's gun fire. The details of gun and mount should be worked out to eliminate excessive dispersion, and to avoid any increase in dispersion, caused by any progressive, permanent deflection in metal which is placed in

stress, by the forces resulting from the discharge of the guns. The various machines installed for use in the service of the guns should be designed with a liberal factor of safety to insure continuous operation, over an extended period of time, and should be simple in design to facilitate upkeep, and to avoid the necessity of too much mechanical skill and experience on the part of the personnel. Protection is similar to insurance against accident and should be the maximum which can be obtained without undue sacrifice of accuracy of gun fire and mechanical reliability.

In the consideration of alternate turret designs it is accepted that all of the best conditions cannot be found in one design but that the design chosen must be superior in most of the important requirements.

The most important subjects that require consideration in connection with turret designs are:

- (a) Accuracy of fire.
- (b) Rapidity of fire.
- (c) Simplicity and reliability of operating machinery.
- (d) Strength and reliability of turret structure.
- (e) Size of barbettes and dead weight of turrets.
- (f) Protection of gun, mounting, and personnel.

From the constructor's point of view it has been practically demonstrated that the weight of installation *per gun* is the least for a 3-gun turret, and increases in both directions from this number, due to the fact that the space occupied by that portion of the three guns contained inside the turret pan, is bounded very nearly by a square, which is the largest rectangle which can be inscribed in a circle. It is also true that the least weight is required for designs where all guns are carried in one slide as one supporting and one elevating system is sufficient for all.

From an Ordnance point of view the size and weight of turrets are not of great importance. Extra weight is conducive to rigidity, and consequently accuracy and consistency in the performance of the gun, while the size of the turret affects the target area presented to the enemy, but from the point of view of ship construction they both materially affect the design of the ship, and must be kept within reasonable bounds.

As stated above, the greater the number of gun emplacements, the greater the difficulty of putting all guns out of action. Recent

designs have varied between two and six emplacements per ship, and ideas recently seem to fix upon four as a happy mean between the two extremes. Two turrets forward and two turrets aft permit a most satisfactory design of the ship as a whole, and should be sufficient when it is considered that the total number of emplacements involved in the action is equal to four times the number of ships engaged. It also provides the ideal arrangement for fire control purposes, such as divided fire, etc. The abandonment of the 6-turret ship for one with four turrets naturally brought up the question of placing more guns in a turret to make up the same total number of guns; and it is believed that the practicability of this alternative, coupled with the economy of turret weights per gun, constituted the principal arguments in favor of the latest design of battleships carrying four turrets with three guns in each.

Another factor was introduced at the same time, however, which also materially affects the problem; namely, the size of gun used. This increase involves the following:

Greater damage done by one hit obtained at a cost of:

Greater turret weights per gun,

Greater size of turret,

More powerful operating machinery,

Greater ammunition weights to be handled and stowed, and

Greater cost.

*All provided a reduction in the number of guns is not made.*

From the 12-inch to the 14-inch no radical changes were made in the methods of handling ammunition and serving the guns, consequently the character of turret machinery was generally the same, but of an increased capacity in the larger turrets. In stepping up to the 16-inch, however, the proper handling of the heavy ammunition weights involved a certain change in type as well as power of machinery, which in general resulted in more space being required for such machinery. In following the old rule that the turret pan should be only large enough to accommodate the guns in recoil position, the proportionately greater space required by the other turret gear resulted in a more crowded turret, with less space left for the crew. Operating space was thus sacrificed to obtain a gun of greater caliber, without either reducing the number of guns, or materially increasing the size and weight of turrets.

In commenting upon the details of turret designs as they stand to date, the following points are made for comparison between the triple slide and the separate slide mountings:

(1) *Accuracy of Fire.*—In the tests and target practices so far held there is nothing to show conclusively that the accuracy of guns individually mounted is any greater or less than that of guns mounted in one slide. It may therefore be assumed that about the same accuracy of hitting, as far as present data and experience show, can be obtained by either type of mounting, as it also appears that either type permits of sufficient rapidity of fire to meet battle conditions. However, any change in gun alignment due to settling of turret structure can be corrected in the single slide mounting and not in the triple slide.

(2) *Simplicity and Reliability of Machinery.*—With the separate mounting, each gun elevates individually, unless the elevating system is cross connected. Three complete elevating sets are required and these three sets must be interconnected by a system of clutches, gears, valves, etc., which requires considerable care and knowledge on the part of the personnel properly to operate it. The system when interconnected also depends for accuracy upon that of the triangle established by the centers of gun trunnions, centers of trunnions to oscillating bearing, and centers of connection of elevating screws to the slides, as well as on the accuracy of the screw thread cut on the elevating screws. With this system, the adjustment of the three guns in the same horizontal plane can be effected; and, if the machine work on the various parts, as well as the work of installation, is accurate, then the three guns will elevate and depress parallel to each other; until damage to the system, due either to internal causes or enemy shell fire, introduces an error in the relative position of trunnion centers, oscillating bearing centers, or other parts of the system. This gives the maximum of flexibility to the system and *enables one gun to be kept in operation after the failure of its own elevating gear.* In the triple slide type of mount, the ability to elevate each gun separately is sacrificed to obtain accuracy of elevation for the three guns which must move through the same vertical angle at all times under the control of one elevating screw. *Any derangement of this elevating system, therefore, affects all three guns alike.* On the other hand, since the oscillating weights are tripled, the

elevating motors must be greatly increased in size to maintain the same rapidity of movement and handle any unbalanced forces due to blowing off a muzzle, etc. With independent slides, the damaged gun may be cut out.

With guns separately mounted, it is necessary to provide a sight for each one and the only practicable location for these sights is underneath the guns, unless the distance between guns is materially increased in order that room may be provided for a pointer's station between the guns. Such an increase in distance between guns would amount to at least 6 feet total and would necessitate a corresponding increase in the size of the turret. The guns at the high elevations now required ( $40^\circ$ ) interfere with the sight setter and pointer, and the movement of the telescope eye-piece is so great that the pointer is materially handicapped in his work of laying the gun *for pointer fire*, unless movable pointers' seats are installed. Alternative control stations are very desirable to cover cases where minor casualties place the stations in operation out of action. Three independent stations require accurate adjustment of the sighting appliances of each, but once adjusted give additional insurance. For director fire it is not necessary to have the guns cross-connected, and each gun can be independently laid not only more accurately but faster, as the motor is only handling the load of accelerating one gun, and it is believed the guns should be normally handled this way. In the case of the latest triple slide design, the work of adjusting guns with sights is simplified as the adjustment consists in aligning two sights attached to the same slide with the guns therein. It is desirable to provide, as far as possible, auxiliary means for accomplishing all the various functions involved in the service of the guns, but in the case of guns independently mounted, this can only be obtained in many cases by the installation of duplicate equipment for each gun, or, as is the case with the elevating gear, by the introduction of a cross-connecting system in order to make use of any, or all, of the three electric motors in elevating the guns, and this cross-connecting system requires considerable space in the turret for its installation.

On the other hand, the separate installations permit of correcting each gun's angle of elevation for erosion and should thus materially reduce the pattern.

The design of machinery for the three guns must be a compromise in order to secure the third gun; this has already been pointed out in the case of sights, and exists also in the case of elevating gear, which, in general, must be arranged in line with the gun and underneath it, rather than in an athwartship plane; and also in the case of shell and powder hoists where interference is experienced either with the right or left gun depending upon whether the hoists for the center gun are constructed right or left handed. Another important influence on the weight of the total gun mounting is the extent to which the alternative systems of power and hand working are employed. Furthermore, the question of perfect balance means increased weight over a design where these considerations are not weighed too carefully.

The ammunition handling machinery must be capable of rapid movement, and the methods of bringing ammunition from the hoists into the guns must be simple and expeditious, and necessitate only the minimum of fatigue to the crew, while maintaining a continuous supply over a protracted period. These requirements in design involve the question of the choice between hydraulic and electric prime movers. Reliability is the first consideration. It is essential to obviate any chance of derangements by shock or direct impact, and, as far as possible, from the shattering effect of high explosive shell bursting in the vicinity of turret gear and machinery.

(3) *Size of Barbette and Dead Weight of Turrets.*—Other things being equal, the size of barbettes for guns separately mounted must necessarily be greater than that for guns mounted in one triple slide for the simple reason that distance between gun centers must be greater to provide space for the inner trunnions. This involves a greater target to be presented to the enemy's fire, or, if the same size barbette is used in both cases, then the turret carrying the three guns in one slide will be a more roomy turret.

Size of barbette and weight of turret go hand in hand and any appreciable reduction in size, when it is realized that a 16-inch 3-gun-turret complete weighs approximately 2000 tons, means a reduction in weight which materially assists the naval constructor in producing a better design of ship. It is believed to be very difficult to design a turret structure for a triple slide which will

be as rigid as the structure for a turret mounting single slides, also the distribution of the load on the turret roller path is more satisfactorily provided for in the case of independent slides and the turret pan can be more substantially braced and tied.

If sufficient diameter of barbette is selected, shell and powder hoists can be provided for each gun in both types of turrets, but in the case of the triple slide design the advantage obtained by a smaller barbette must be given up.

(4) *Distance between Guns.*—Various turret designs in the past have involved various distances between centers of guns. On the first tests of the triple slide arrangement it appeared that the accuracy of flight of the projectiles was possibly impaired by interference between shells in flight. This interference appeared to be a serious defect, and considerable experimentation was conducted using *delay action coils* to produce successive firing of the three guns. Tests of the mount using these coils at the proving ground indicated that an improvement in dispersion was effected. Later on, in service, this delayed action idea was apparently overdone; and inaccuracies developed due to the fact that the guns were mounted on a movable platform, and fired generally on the middle of the roll, at which time the angular movement of the ship was at its maximum. Also, experimental firings showed that the variations in ignition and inflammation of the powder were much greater than those introduced by the delay coils. This resulted in the abandonment of the delay action coil, with the result that smaller dispersion was obtained. Greater separation of the guns in addition to giving less blast interference provides a stronger front plate for the turret in the single slide design, and this feature is well worth considering.

It is believed that imperfections in the design of projectiles, variations in the amount of recoil of the gun at the instant the projectile leaves the muzzle, and the question of rigidity of the mount have more effect upon the dispersion than the distance between guns. In a special firing of a 3-gun turret, when the wing guns only were fired, the patterns were substantially the same as those from a regular 2-gun turret.

(5) *Safety Features.*—It is evident that separating bulkheads cannot be installed in the turret utilizing the triple slide. This may be considered a loss of protection from the enemy's gun fire.



On the other hand, the advantage obtained shows up in the greater facility of control of the personnel as all are in one compartment.

As far as known, foreign navies do not use separating bulkheads, which goes to show that there is not universal agreement as to their necessity. They take up a certain amount of valuable space in the turret, which tends to increase the congestion already existing. They are not entirely flame proof under all conditions, as openings must be provided for access and transfer of ammunition in case of breakdown, where one gun has to be served from the hoists of another. These disadvantages are incurred for the advantage of additional safety and also to meet the requirements of all the Departmental Turret Board reports, and to prevent demoralization of personnel in action, which is believed to be a necessity for service of guns in battle. A great advantage from a structural point of view is also obtained in the case of the separate slide design by the fact that the roof of the turret can be well supported. This increases the protective efficiency of this type of turret, as the roof derives considerable support from the bulkheads and stanchions which can be installed.

In the case of a hit on the turret front plate, the port clearances are necessarily so small that a fragment might easily jam the single slide. One possible advantage to the triple slide type might be derived from having the sight line come out through the side plate of the turret, whereas in the case of the guns separately mounted the sighting arrangements are provided through the lower part of the gun port. This is a doubtful advantage, however, as movement of the front plate would probably entail a certain displacement of the side plating with the result that the trunnion types of sight might well be placed out of action. When the question of sealing the gun ports to keep out water and protect the lenses of sights from spray is considered, the trunnion type of sight on the triple slide possesses considerable advantage over the other arrangement. In the case of a rammer jamming in a gun, it is evident that the separate slide type of mounting is superior, since the fire of the other guns would not be affected unless the elevating gear is cross-connected, in which case the clutches and other devices for cross connection would have to be thrown to operate the guns individually.

The reasons leading to the adoption of the separate slide may be summarized as follows :

It is self-evident that the chances of victory in battle lie with that side whose armor and armament is so disposed as to enable it to inflict the maximum damage upon its adversary, and, at the same time, minimize the damage it receives itself. This broad principal demands that each gun shall be so mounted as to enable it to deliver throughout the battle, the most rapid, accurate and uninterrupted fire possible; moreover, it further demands that the armor protection be so disposed as to reduce the effects of hostile hits to a minimum and to restrict such damage as may be unavoidable to the immediate vicinity of the hostile hit. It is evident that to mount guns in such a manner that the rapidity, accuracy, or duration of fire of one gun is in any way dependent upon the operation or condition of adjacent guns is a violation of this fundamental principle that cannot be justified upon grounds of simplicity, compactness or target practice results.

It is not difficult to imagine many ways in which one well-placed hit could totally disable a single slide turret, nor is it difficult to imagine many casualties of a minor nature, in themselves, that would more or less seriously affect the volume of fire. The fire of three guns is entirely dependent upon one elevating screw and its accessory mechanisms. The jamming of one gun, even by a shell fragment lodged in a port opening, interrupts the fire of all three guns; the failure of one gun to return to battery, or a jammed rammer will cause a similar interruption of the fire of all three guns. With the three guns mounted in separate slides, a minor casualty will affect the fire of only one gun and it is difficult to imagine a hit so well placed as to disable more than one or possibly two guns.

The curve of total trunnion pressures for a three-gun turret, using guns from 12-inch to 18-inch caliber, takes the form of a hyperbola which has a considerable shoot upward beyond the point corresponding to a caliber of 16-inch. This shows that the advantage gained begins to drop off rapidly beyond this point, since the necessary strength required to hold the gun in the ship involves a corresponding rapid increase in size and weight of turret. Also, the handling appliances for the ammunition increase rapidly in size, and capacity, thus requiring more space for their installation and further decreasing the relative advantage obtained in mounting three guns in a turret.

The above discussion points most forcibly to the great necessity of simplicity and ruggedness in turret designs. The mental and moral strain of battle reduces the ability of the personnel much more, (when cool headedness and careful training in the intricacies of turret machinery are required), than is the case when simple duties are to be performed which do not require care, knowledge and good judgment on their part. At best, turret

machinery must be more or less complicated to perform the various services required. In its simplest form it will tax the brains of the average man, and if he is taxed beyond his capacity, then disaster is sure to follow.

The preceding discussion shows the conflicting requirements to be met in turret design, and the ever-present conflict between operational simplicity and numerous demands for alternative systems, the resulting plans being as usual the best possible compromise after assigning the proper weight to all the various factors considered.

[COPYRIGHTED]

U. S. NAVAL INSTITUTE, ANNAPOLIS, MD.

---

## SPEEDING UP COMMUNICATIONS

By LIEUT. COMMANDER M. S. TISDALE, U. S. Navy

---

The recent cruise of the fleets has undoubtedly convinced everyone in any way connected with communications, or dependent upon them, that the efficiency of present-day communications is almost a direct variable of the speed of handling traffic *within* the ship. A great deal of attention has been given to ship to ship traffic, and the routing systems within the ships are thorough as regards keeping of accurate records, and fairly satisfactory as regards eventual delivery. But there is too much lost motion in getting the received dispatch to the acting authority.

To obviate this slowness the following simple system has proved satisfactory.

The receiving station, whether bridge or radio room, copies the message in triplicate when it is being received. Two of these *rough* copies are sent to the communication office as soon as the sender has signed off. The receiving signalman or operator notes the time of receipt on the rough copy by the letter "TOR" followed by a time group. Upon delivery to the communication office the yeoman on watch on the desk notes the receiving data on his communication sheet, places the office time of receipt (OTOR) on the rough copy and sends it immediately to the duty officer. The duty officer indicates what time it was given to him by a time group after the letters "DTOR." If the subject matter is urgent the duty officer causes action to be taken at once without further red tape. If not urgent he indicates that the message is to be written up for routing to officers concerned, or that it is to be filed without being written up, depending on the context.

This scheme gives a complete record on the rough copy of each message. If any undue delay occurred it is simple to fix the responsibility and to take the necessary steps to prevent a recurrence.

Each night, the yeoman having the mid watch compiles the data from the messages of the preceding day and has it ready for examination and—if necessary—investigation by the communication officer or a designated assistant the next morning. The delay between TOR and DTOR is averaged each day and transferred to a curve of routing efficiency. This shows at a glance the general progress that is being made in improving the speed of communications within the ship. The work involved is small, the results considerable. Each element in the traffic chain knows that if he errs it will be known the following morning at the latest. This causes a corresponding effort to avoid mistakes and delays.

Clocks in receiving stations and in the communication office must be set daily and the duty officer must see that his watch is in agreement with the clock in the office; otherwise the check is of no value.

Any tendency on the part of personnel to "fake" a little on their times noted will be quickly discovered; unless the whole chain decides to fake at the same time. No difficulty has been experienced in this regard.

The following curve shows the efficacy of this system. It was decided to use this system on February 17 of this year. On that date the average delay was over 32 minutes. It seems reasonable to believe that that was the usual delay prior to starting the check. In other words, the usual delay in getting a message from the bridge to the acting authority was some half hour. Allow another half hour for getting the reply back through the same channel, plus whatever time it took to prepare the answer and you get a perspective of some of the reason for the slowness of our communications. There will be occasional bad days with any system but this checking insures fewer of them in that it shows when they occur and allows steps to be taken to reduce them to a reasonable minimum. The average has now dropped from 32 minutes to a little over 8 for the entire month of April, and the majority of the later days have been in the neighborhood of 6 minutes. The lowest spot on the curve is 2½ minutes. At present it is impossible to maintain that pace for a monthly average but it at least is a good target; and 8 minutes is better than 32.

The checking is automatic and the labor involved is not noticeable. The benefit is sure.

U. S. NAVAL MESSAGE

TOR 1648  
 OTOR 1650  
 DTOR 1652 MRS (Do)

DELAY SHEET							APR 28 1921
ORIGIN	OFFICE No	REF No	TOR	OTOR	DTOR	DELAY	
CBF	2028	1622	1648	1650	1652	2	
						4	
						3	
						ave 3+	J.R. Hase

ROUTING EFFICIENCY CURVE

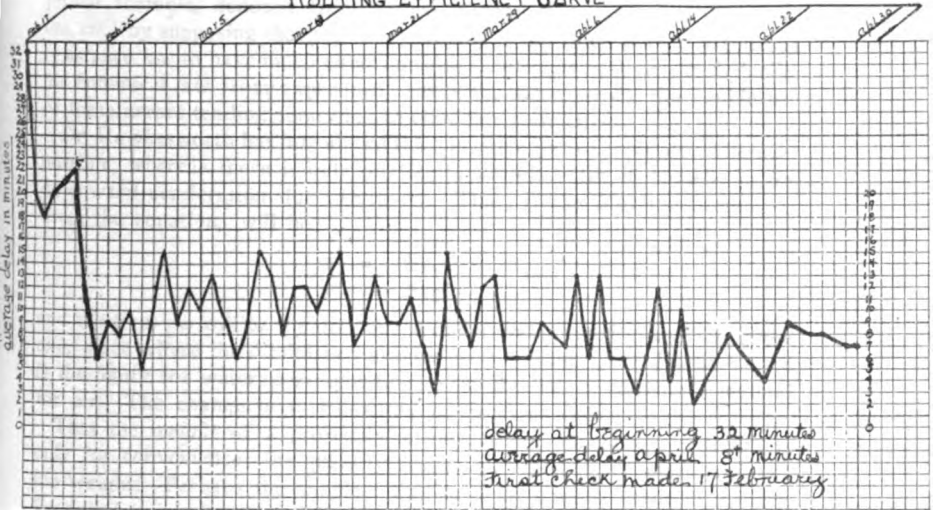



## DISCUSSION

### Under-Water Trajectories

SEE PAGE 207, WHOLE No. 216)

J. J. ARNAUD, Master Computer, Ordnance Department, U. S. Army.—Having recently been required to compute for the Ordnance Department, U. S. A., the time required for drop bombs, striking the surface of the water with a given velocity, to penetrate to various depths, the present writer investigated the article on "Under-Water Trajectories," by Dr. Alan S. Hawkesworth, Bureau of Ordnance, Navy; published in the U. S. NAVAL INSTITUTE PROCEEDINGS, February, 1921.

Certain manifest errors in theory in that article compelled the discarding of Dr. Hawkesworth's methods. In the various trials that followed, it was found that, for the small depth of water penetration used, a *very* large change in the ballistic coefficient produced *very* little change in the time to penetrate. The present writer can only account for the apparent verification of any of Dr. Hawkesworth's figures (by "Lieutenant Schuyler's empirical formula, deduced from an experiment at Indian Head," p. 210, *loc. cit.*) by supposing that the time involved is too short for an erroneous resistance law to have much effect: or else Lieutenant Schuyler, in deducing his empirical law from experiment, made the same errors, the double use of these errors tending somewhat to eliminate their effect.

Dr. Hawkesworth has introduced the buoyant effect of the water wherever possible, whereas there is only one legitimate place for it, namely, in the downward acceleration due to gravity. Thus, if the Moulton Method is used, the equations will be:

$$\begin{aligned}x'' &= -E_w X', \\y'' &= -E_w y' - g_w,\end{aligned}$$

and the term  $g_w$  will be the diminished under-water gravity, and this is the *only* place where the diminished gravity should occur. The  $E_w$  here used is the figure for water, corresponding to the  $E$  used, in Moulton's method for air. The change in this quantity is discussed below.

That the *weight* of a projectile is used in the formula,  $C = w/id^2$ , is only for convenience; the quantity really concerned is the mass, and not the weight. Perhaps the simplest way to point out the error in using a "reduced weight" in the  $C$  for water, would be the following *reductio ad absurdum*: Computing the  $C$  for a hollow shell whose weight in *vacuo* equals the weight of an equal volume of water, we should find, by Dr. Hawkesworth's method,  $C = 0$ . Such a shell, if projected into water at any velocity however great, would be instantaneously stopped. It is beyond the



present writer to say what would happen to a shell whose specific gravity is *less* than that of water, since one whose specific gravity *equals* that of water would be unable to penetrate an inch!

Dr. Hawkesworth states (p. 212), that, in companion graphs of resistance in air and in water, "those in water, would be 'telescoped' down, with ordinates only  $1/925$  times the size of those in air. Nor need we be concerned here about the breaks or 'stop points' in Mayevski's function, nor even consider the change of retardation at the critical point of the velocity of sound in the medium—in this case in water—since the flattening of our graph is so excessive, being but  $1/925$  of its previous air value, that any and all such influences are practically negligible."

Dr. Hawkesworth here forgets that it is the *ballistic coefficient*,  $C$ , which he reduces to  $1/925$  of its air value; and that  $C$  enters into the *denominator* of the value of  $R$ . Hence any such reduction in  $C$  would *magnify* all ordinates by 925, and would therefore make any breaks, such as the Mayevski points, or the "kink" in the Moulton  $R/v^2$  near the velocity of sound, of *enormous* importance. The valid reason for the non-existence of any kink in the water-resistance has escaped his notice. He fails to note that the higher velocity of sound in water (about 4 times that in air) would move any such "kinks" beyond the velocity acquired by our projectiles at present. Or further, that, since water is only slightly compressible, no wave of very great condensation will precede a projectile traveling through water, as does occur in air; and that therefore a graph of the true  $R/v^2$  for water will show only a hardly appreciable kink near the velocity of sound *in water*.

Dr. Hawkesworth nowhere takes account of viscosity. It is certain that this consideration will materially alter the resistance. Indications are that, when the relative viscosities of air and water are considered, and the functions,  $B = R/\rho v^2$ ,  $\rho$  being density, are tabulated both for air and for water, the  $B$  for a given velocity in water will be equal to the  $B$  for about ten times that velocity in air. This appears to be verified only for low velocities.

The subject is now being investigated by the Technical Staff of the Ordnance Department, U. S. A., and in the absence of perfect information, empirical tables are being constructed using the square law,  $R = av^2$  the  $a$  being so taken that the air ballistic coefficient may be used. Experiment seems to indicate that the square law is approximately correct throughout, but any variations in any particular region can be taken up in the pseudo-constant,  $a$ . Accordingly, the tables under construction give to argument,  $v$ , the values of  $a = R/v^2$ . These will only approximate the true resistance, but, as before stated, for short trajectories, the results will be within the allowable limit of error. A few minor errors in Dr. Hawkesworth's article such as calling  $w_1/W$  the specific gravity (middle of p. 208), may be passed over without mention.

#### Reply to Mr. J. J. Arnaud's Criticism of "Under-Water Trajectories"

ALAN S. HAWKESWORTH, F. R. S. A.—My paper was on the loss of velocities suffered by armor piercing projectiles, entering the water at high

velocities of around 2000 ft./sec.; so that your complaint that the equations were not in a form, suitable to obtain the few feet per second travel of bombs dropped in water, is surely confusing two widely different problems. Take the quite parallel conditions in air; you would hardly demand that a 3000 ft./sec. range table should give you the path of a bomb dropped from an aeroplane?

A paper now in the hands of the "U. S. Naval Institute" correctly gives the equations of bodies falling through any resisting medium, air, water, or any other. Wherein I show that, assuming, for the moderate velocities of fall, the resistance of the given medium is proportionate to the square of the velocity; or  $R = kV^2$ ; with  $k$  as a determinable constant of resistance;  $W$  the weight in pounds of the falling body;  $g$  the gravity coefficient in ft./sec.<sup>2</sup>; while  $V$  is the velocity in ft./sec. attained in falling through  $S$  feet in an elapsed time  $t$  seconds; then

$$V = \sqrt{\frac{W}{k}} \tan hgt \sqrt{\frac{k}{W}}. \quad \text{And } S = \frac{W}{kg} \log_e \cos hgt \sqrt{\frac{k}{W}}.$$

From which it follows that as the time  $t$  increases without limit; so also must  $\cos h$ , and the space fallen through. But  $\tan h$  approaches unity; and the velocity similarly asymptotically approaches a limiting velocity of  $\sqrt{\frac{W}{k}}$ ; fixed for the given falling body, and the resisting medium.

In your criticism that I should have used mass in place of weight, your thought has stopped half way. The only conception we have of "mass," which we conceive as unalterable, is weight divided by gravity; these two latter being alterable in the same ratio; and indeed being two ways of conceiving the same earth attractions. A body in water or air, or any medium, which displaced its own weight of that medium; while it would have the same mass as before; would yet have zero weight; and zero gravitational attraction. So that it could not fall at all.

And this consideration also answers your "reductio ad absurdum." The ballistic equations of Siacci, Ingalls, Moulton, etc., are not designed to solve problems dealing with either infinite or zero weights, in air, or in water. Anymore than one could reasonably ask them to solve the negative weight problems connected with balloons.

With regards to the breaks in the Mayevski functions; if one plots these, one obtains a series of quite disconnected and different curves. And for air resistance, the said discontinuities are quite serious; but are carefully smoothed out, in the calculated tables of Ingalls, and Alger, etc. But for water, the ordinates of the stated resistance graph are but .001 of those in air; so that the said discontinuities become negligible. Your statement that the break at the velocity of sound [with an implication that this is the only break] would be "greatly exaggerated" in water is thus the opposite to the fact; and is merely such a slip as we are all liable to make.

U. S. NAVAL INSTITUTE  
SECRETARY'S NOTES

**Membership** Life, regular and associate, 5496.  
New members, 13. Resignations, 7. Deaths, 3:

Captain A. Crenshaw, U. S. N.  
Brig. General J. W. Ruckman, U. S. A.  
Mr. C. E. Loud.

Practically the whole service receives the benefit of the PROCEEDINGS yet many officers, who read it monthly, are not members and therefore contribute nothing to the support of the Institute. Members are requested to urge non-members to join. Publication costs are now so high that the Institute is carrying a loss. The cost, per member, however, decreases with an increase in membership.

**Dues** The annual dues (\$3.00) for the year 1921 are now payable.

Regular and associate members of the U. S. Naval Institute are subjected to the payment of the annual dues until the date of the receipt of their resignation.

**Discussions** Discussion of articles published in the PROCEEDINGS is cordially invited. Discussions accepted for publication are paid at one-half the rate for original articles, or about \$2.25 a page.

**Address of Members** To insure the delivery of the PROCEEDINGS and other communications from the U. S. Naval Institute, it is essential that members and subscribers notify the Secretary and Treasurer of every change of address, without delay.

**Book Department** *The Institute Book Department will supply any obtainable book, of any kind, at retail price, postage prepaid.* The trouble saved the purchaser through having one source of supply for all books, should be considered. The cost will not be greater and sometimes less than when obtained from dealers.

The Boat Book, 1920, and the Landing Force and Small Arms Instructions, 1920, are now ready for issue. The price of the former is 50 cents per copy, and of the latter \$1.00 per copy.

In the latter part of the summer, the Institute will publish two books, bearing the following titles: "The Aircraft Hand Book," by Lieutenant Albert Tucker (C. C.), U. S. Navy, and "Composition for Naval Officers," by Professors Stevens and Alden, Dept. of English, U. S. Naval Academy.

The prices of these books will be announced later.

The Seaman's Hand Book, containing much valuable information for enlisted men, particularly those of the deck force, has been added to the Institute's publications. This excellent little book is retailed at 65 cents per copy.

The attention of readers of the PROCEEDINGS is invited to the classified analytical index for numbers 101 to 200 inclusive, which is noticed under "Publications." This is a most complete index, which has been prepared at considerable expense in order to make readily available the information contained in both the articles and the notes of these issues. Only a limited number of copies are being printed. Price, bound in cloth, \$2.35; bound in paper, \$1.85.

The Institute desires articles of interest to all branches of the service, including the Reserve Force. Attention is invited to the fact that the submission of articles is not limited to members, and that authors receive due compensation for articles accepted for publication.

All articles and discussions submitted by persons belonging to the navy for publication in the PROCEEDINGS must be in duplicate, one copy being signed by the author, which will be submitted to the Navy Department when the original is published, as required by General Order No. 46, of May 20, 1921.

The attention of authors of articles is called to the fact that the cost to them of reprints other than the usual number furnished, can be greatly reduced if the reprints are struck off while the article is in press. They are requested to notify the Secretary and Treasurer of the number of reprints desired when the article

is submitted. Twenty copies of reprints are furnished authors free of charge.

Authors of articles submitted are urged to furnish with their manuscript any illustrations they may have in their possession for such articles. The Institute will gladly co-operate in obtaining such illustrations as may be suggested by authors.

Original photographs of objects and events which may be of interest to our readers are also desired, and members who have opportunities to obtain such photographs are requested to secure them for the Institute.

Whole Nos. 6, 7, 10, 13, 14, 15, 17, 144, 146, 147, 173. Notice 215 and 217 of the PROCEEDINGS are exhausted; there are so many calls for single copies of these numbers that the Institute offers to pay for copies thereof returned in good condition at the rate of 75 cents per copy.

ANNAPOLIS, Md., August, 1921.

#### INFORMATION INDEX

	PAGE
ADVERTISEMENTS, INDEX TO.....	1
PUBLICATIONS, U. S. NAVAL INSTITUTE.....	(2)
SPECIAL NOTICE .....	1505
TOPICS FOR ESSAYS .....	1506

# PROFESSIONAL NOTES

PREPARED BY

COMMANDER F. M. ROBINSON, U. S. NAVY

## GENERAL ARRANGEMENT

VESSELS BUILDING.	}	France .....	1423
NAVAL POLICY.		Germany .....	1429
MATÉRIEL.		Great Britain .....	1435
PERSONNEL.		Japan .....	1439
MERCHANT MARINE.		United States .....	1441
AERONAUTICS .....			1451
NAVIGATION AND RADIO .....			1466
ORDNANCE .....			1468
MISCELLANEOUS .....			1473
CURRENT NAVAL AND PROFESSIONAL PAPERS.....			1475

## FRANCE

**FRENCH NAVAL POLICY.**—The adoption of the French naval program is an event that calls for more than passing notice. Its significance lies not so much in the actual provision made for augmenting the fleet as in the fact that France, our neighbor and good friend, has at length mapped out a definite line of naval policy based upon definite principles of strategy. Before turning to the program itself we think it proper to remark that this initial step towards the restoration of French sea power will be heartily welcomed by all thoughtful people on this side of the Channel. The insidious attempts of mischief-makers to represent France as the spiritual home of militarism, and to assign to her the menacing rôle which Germany had played for the half century preceding the war, have met with little or no success. Reasonable folk in this country see no objection to France making herself sufficiently powerful by land, sea, and air to discourage would-be aggressors. They perceive, indeed, that French preparedness will be one of the strongest guarantees against a new war in Europe. Nothing would be calculated to give greater encouragement to the German "revanche" fanatics—who apparently include the major part of the German nation—than the spectacle of France neglecting to consolidate the military position which she occupied at the close of the war. The cardinal necessity for the Republic is, of course, an adequate and efficient army behind a favorable frontier. Those desiderata having been attained, France does well to turn her attention to the sea. The war brought home to her the vital importance of keeping open the sea routes. She is not yet wealthy enough to build the great ships that alone are competent to dominate the great ocean spaces, but she hopes, by the judicious expenditure of available funds, to secure her communications in the Mediterranean, which to her is the naval zone of immediate importance.

The salient features of the new program were recently explained by our Paris correspondent. No battleships are to be built, for the simple reason that they are not for the moment within reach of the national purse. It is clear, however, that French naval opinion as a whole remains loyal to the great ship, and would gladly build mastodons were it not

for their prohibitive cost. We gather from comments in the press that had it been deemed absolutely essential to provide a new battle squadron the money would have been found by hook or by crook. That this heroic step has not been taken is due to the circumstance that France has a pre-war dreadnought squadron, which still ensures her a slight superiority in armored units over Italy. Not that there is any occasion for or prospect of real naval rivalry between the two Latin Powers, but it is only natural that French strategists should keep an eye on the progress of naval affairs in Italy, to whom, also, the Mediterranean area is of primary importance. Where France is conspicuously weak is in the small, swift ships and the submersible vessels which are likely to develop their maximum potency in such waters. She has no modern light cruisers, no big flotilla leaders of the latest type, in which high speed is found conjoined with powerful offensive qualities; and her submarine flotilla, though imposing enough on paper, contains but few boats which are up to the high standard established by war experience. These deficiencies will be made good in part by the Guist'hau program, which has passed the Chamber of Deputies by a handsome majority. It authorizes the construction of no fewer than 66 units, not counting the conversion of the ex-battleship *Béarn* into an aircraft-carrier. To the lay mind one ship is much the same as another, and it is therefore not surprising to find the program described in one of our daily papers as "the most sweeping naval project sprung upon the world since the great American bill of 1916."

Nevertheless, the description is absurd. The Guist'hau plan is modest indeed by comparison with the Japanese program which was adopted a year ago, and it is overshadowed by our own estimates for the current year. It authorizes the construction of six armored cruisers, each displacing 8000 tons; twelve 2400-ton leaders or small scouts, the same number of 1400-ton destroyers, and 36 submarines, about equally divided into coastal and long-range types. With the exception of our *Elizabethan* class, the new cruisers will be the largest, fastest, and most heavily armed ships of their type in existence. Details are lacking, but they are credited with a battery of 7.6-inch guns and a speed of at least 33 knots. Although some doubt the wisdom of building cruisers too large and costly to be risked in minor enterprises, yet too weak to fight a heavy ship, the new vessels are certainly a great improvement on last year's design, which was to have displaced only 5200 tons. As regards the big leaders and destroyers, the value of such craft for Mediterranean operations is self-evident. France found herself sorely handicapped during the late war by her shortage of fast sea-worthy destroyers, and evidently does not intend to be caught napping again. There are no sensational features about the submarine program. The largest boats will be approximately equal in size to our *L* class, and forecasts of a huge submersible-cruiser type have not been fulfilled. French experts say that a well-designed boat of 1100 tons can do everything a submarine is meant to do, and that it is sheer extravagance to build larger submarines at the present stage of development. Our experience with the big *K* boats seems to bear out this theory.—*The Naval and Military Record*, 6 July, 1921.

NAVAL TOPICS.—Frenchmen do not trust Germany, and neither will any Englishman trust her who is acquainted with her past history and actual aspirations and possibilities. In a booklet, communicated to the Chamber, M. Rouchon-Mazerat, a high Admiralty official, shows that Boche land is entitled under the clauses of the Versailles Treaty to commence, within the next few years, eight ships of 10,000 tons and eight of 6000 tons, which, he thinks, will have no point in common with the old *Braunschweig* class, but will be of the ultra-rapid armored cruiser type, and constitute, of course, a deadly danger for France's lines of communications with her colonies. These disquieting views Minister Guist'hau corroborated. With 16 up-to-date commerce-destroyers and, potentially, the first aerial fleet

in the world, Germany will be, a few years hence, even without the help of Bolshevist Russia, in a position to openly tear to shreds the ill-framed Treaty that terminated the war won by Foch and his French and British lieutenants and since lost by ignorant or Utopian politicians.

It is a matter of tradition that "La Grande Marine Anglaise" always occupies a large place in the naval debates of the French Parliament. Despite the tremendous growth of the American fleet (*a fait nouveau* the importance of which is not overlooked), the British Navy remains for Gallic opinion a model and a guide, even when it is indulging in "semi-naval holidays" as it has been doing for the last few years. The partisans of economy and retrenchment, especially those amusing Socialists who are submerging the Chamber under their "naval" verbiage, though voting *par principe* against the Budget de la Marine, have been urging that, since England is openly giving up the "trident de Neptune," it is a conclusive proof that the naval weapon has lost its former superlative worth, and, therefore, impoverished France ought to renounce, once for all, any pretension at sea power, and, at the same time, strange to note, they were particularly violent in their denunciation of "l'impérialisme Anglais," their sympathy going solely to poor innocent and peaceful Boche land, to the disgust of the vast majority of the Chamber, which is resolutely pro-British. The Breton député Le Bail, after stating that a powerful fleet was necessary to France, "*dans l'intérêt de nos alliances*," pointed out with conviction that Great Britain was to-day, and would be to-morrow, the Queen of the Seas, because "*elle jouit d'une situation incomparable qui la fait sans égale*," and she combines superior shipbuilding capabilities and superior quality of personnel. To the député Berthon who was deriding General de Castlenau on account of the "exaggerated" idea the latter had of the war-rôle of the Republican Navy, Minister Guist'hau retorted that without the French command of the Mediterranean the great British Armada, with all its power and efficiency, would have been unequal to the task of matching the forces of the Triple Alliance.

Once more the Minister of Marine deplored the scant justice awarded by public opinion to the achievements of the navy. Daily *communiqués* tied public attention to the fare and work of the "poilus" and Tommies fighting on French soil, whereas poor Mathurin, nightly and daily, without respite, tossing and fighting on the stormy element in the midst of deadly perils, interested only a few; no *communiqué* for him; and so, in the simple mind of ignorant "populo," he was doing nothing. At these unpalatable reminiscences Député Le Bail felt his Breton blood boil, and he gave to the amazed Chamber an account of a day's work by the Brest patrols under the gallant Admiral Schwerer, who usually hoisted his flag in a 50-ton patrol-boat and supervised the conveying of over 100 ships per day in the spring and summer, 1918. He recalled that Brest Arsenal, during the six weeks between March 1 and April 15, 1918, repaired 135,000 tons of Allied and neutral shipping, one thousand workmen being exclusively employed in British ships.

It is certain that the next 8000-ton cruisers of the *Bouvet* class will be extremely remarkable ships, Chief-Constructor Doyère being reputed for original and thorough work. They will be for their size the best armed and most powerfully engined ships in the world, as their motor-power will approximate 100,000 horsepower to ensure a speed of at least 35 knots, which is satisfactory so far as it goes. Still, the launch of the 10,000-ton *Efingham* comes as a timely reminder that it is as well not to claim too much for the *Bouvets*, and not to expect M. Doyère, despite all his inventive genius, to obtain out of 8000 tons as much offensive and defensive qualities as British constructors are getting out of 10,000 tons. The *Efingham* will be slower, but she has good chances to be the best all-round cruiser for robustness, reliability, sea-keeping capacity, and especially for defensive power. And yet M. Denise, a good-intentioned and patriotic député



but obviously unprepared for the responsible functions of "*Rapporteur du programme naval*," hoped and prayed for a reduction of the projected displacement from 8000 to 7500 tons, little aware of the insurmountable difficulties he was thus placing in the way of those whose ambitions and efforts aim at giving France, in the cruiser line, the superiority for quality which is alone worth investing in. Number without individual superior strength is little more than make-believe, as the Boches have learned to their cost, and it would be wiser to build five cruisers of 10,000 or 11,000 tons, capable of mounting heavy calibers and of outclassing all rivals, rather than six 8000-ton *croiseurs légers* that will be merely equal, if not inferior, to rivals already floating. Moreover, this French practice of compulsory limitation of displacements by incompetent *députés*, who have in view merely the financial side of the shipbuilding question, never worked satisfactorily; it is bound to lead to the sacrifice of essentials. In all battleships and cruisers anterior to the *Jean Bart* type, for instance, the fighting value was depreciated more or less, by the cramped-up condition of the turrets. It is only with 25,000-ton *Normandies* that really roomy, comfortable gun quarters were introduced into the French Service; but, as ill-luck would have it, to no avail, it having been finally decided to condemn the 60 or 70 per cent completed *Normandies*, which thus become so much waste of genius, time, and money (170 million francs for materials alone). Still, if "much can be got out of little" on the lines advocated by M. Harpagon, the bold originator of the *Normandie* type is the likely man to achieve a miracle of that magnitude.

Député Denise referred to the deep-rooted belief that French ships are faster at sea than rivals in other navies with the same paper speed, the reasons being that Gallic constructors make a liberal allowance for motor power, which is true—compare the 23-knot ships *Quinet*, 14,000 tons and 39,803 horsepower; *Minotaur*, 14,800 tons and 28,650 horsepower; the 12,600-ton *Michelet* and *Roma*, the French developing 30,000 horsepower and the Italian only 20,000 horsepower, and yet put down on paper as having the same speed. Think of the *Dante*, which is claimed to do 21 knots with 21,000 horsepower, whereas the *Voltaire*, of similar displacement, requires 29,000 horsepower to maintain the same rate of speed. Besides, it is a fact that trials in the French Navy are far more exacting and more conscientiously supervised than anywhere else. The crossing of the Atlantic at 13.5 knots by the 17-knot *Gaulois*, at 16 knots in rough weather by the *Lepard* division (the 18-knot *Liberté*, *Justice*, and *Vérité*) are performances unique for pre-dreadnoughts.

Still, British speed war records exceed all others, and were the source of the success of the dashing *Beatty* and of the tenacious *Sturdee*. Some French ships also did very well, and Austrian cruisers, though nominally much faster, had several times to thank the proximity of Cattaro for their timely escape from the deadly grip of the reliable *Quinets*. At the same time, a few turbine battleships gave some trouble. At the outset of the hostilities, for instance, the *Mirabeau* (18,500 tons, 19.73 knots on trial) refused to exceed 15 knots, despite much coaxing. The sea speed of ships has little to do with the nominal figures carefully noted in naval pocket-books; neither can the motor power be altogether accepted as a true criterion of speed. Experience shows the speed problem to be extremely complicated. Once there was a race, from Toulon to Indo-China, between the 14-knot battleship *Redoubtable* and the 20-knot 4000-ton cruiser *Chasseloup-Laubat*, and the slow but robust and roomy battleship won easily. Again, the 24-knot *croiseurs-corsaires* *Chateau Renault* and *Guichen* caused enthusiasm when running on their trials, but later gave rise to bitter disappointment. Robustness, good fuel, and trained personnel are what matters most.—*The Naval and Military Record*, 6 July, 1921.

SAFE COMMUNICATIONS.—For the first time since the armistice, the French Navy has carried out—though with skeleton battle squadrons and

flotillas—tactical exercises on something like realistic lines, and having for theme a vital problem of sea warfare; and it is remarkable that the Atlantic, and not the Mediterranean, witnessed that interesting preliminary contest in which took a part the 24,000-ton *Bretagne* and *Provence* (the *France* having temporarily quitted the Fleet for Constantinople), two dozen destroyers and submersibles, and as many aerial craft, from Rochefort and Lorient. Though the combatants were few, the action spread over a pretty large area, off the Loire estuary, Belle-Ile, and Quiberon, and lasted some 50 hours, being marked by surprises, instructive incidents, and no less instructive accidents.

Of course, with so small, and in some respects inadequate, a force it would have been pretentious to try and give a mimic representation of the great objective problems of to-morrow, and officially Admiral Salaun's modest ambition was to provide for his crews "*un exercice de recherche, d'attaque et de défense*," as well as to test the conditions of training and the radius of action of the coastal flotillas, the latter question being of special interest at the moment when the whole "*défense des côtes*" organization is being reconsidered and revised by Admiralty authorities. But, in reality, things passed off just as if a hostile force en route from the Mediterranean for the Channel (or the reverse) were being intercepted by French Atlantic flotillas; thus a study of the problem of safe communications that governs sea warfare. Admiral Salaun's game was to pass, leaving as few feathers as possible in the hands of his assailants who had to find him, lay ambushes across his route, attack him both from the air and from under water, pursue and harass him through the night, and bring him to grief by all means. Had the game developed as it would have done under war conditions, the battleships keeping well off to sea and using the recent devices to conceal their course, no contact and no combat would have taken place. The admiral had to lend an obliging hand to his puny antagonists and to go some way to meet them. Despite this fact and the exceptionally favorable weather, coastal seaplanes and dirigibles practically failed in their scouting mission, and were *hors de combat* before the concluding phase of the hostilities.

Thus came a timely lesson (coming after the Cherbourg and Mediterranean experiments) that can only spur the energetic Minister of Marine to action. Dashing and even enterprising aviators the Marine Française possesses in pretty large numbers; a practical aerial policy, a program *d'ensemble* framed by practical men, and a reliable robust type of "*hydravion autonome*" for independent oversea cruising are the urgent desiderata of to-morrow. It is only when such projects have become reality and the Guist'hau program has been constructed that the Gallic Navy will be in a position to control the Bay of Biscay routes and to spread out a few hundred miles at sea the offensive radius of action of the Brittany coastal flotillas, for the question of safe communications is primarily one of speed and range.

Of course, it would be a negative policy for France to limit her naval ambitions to the cutting or control of Atlantic and Mediterranean Sea routes by means of offensively equipped strategic points *d'appui*. As the war has shown, she is, just as much as England is, in need of safe oversea communications to enable her lasting out and ultimately winning in the coming conflict for which revengeful Boche land is secretly preparing. Once she has been isolated from her vast colonial Empire, France is merely a nation of 38,000,000 people confronted by one of some 70,000,000, with superior industrial capabilities, and it must not be forgotten that disarmament, even if it were real (which is very far from being true), does not mean Boche powerlessness when the sole Spandau arsenal, with its plant and reserve of materials unique in Europe, is in a position to turn out in a few months the armament of a huge army in guns and machine guns. France would thus have reasons to welcome the British proposal to limit, by an international arrangement, the rôle of submarines, and, especially, to

absolutely forbid piracy on Boche lines. In 1918-19 on the morrow of the armistice, the bulk of the French naval opinion was with England on the matter, and Constructor Laubeuf, writing in *Le Yacht*, and while strongly asserting the right and intention of France to keep on building submarines, stigmatized the Boche pirates and their barbarous methods of warfare. France felt then sure that stern chastisement would be meted out to the cowardly murderers of the sea and of the land, as proclaimed by the British Premier; and, of course, that grand act of justice would have served as "*un exemple*" for centuries to come, and deterred would-be baby-killers better than any international arrangement on paper can ever do.

Since then, unfortunately, Frenchmen have had their eyes opened to unpalatable reality by the negative support the Allies are giving to their claims for reparations and by the Leipzig comedy. They have learnt that sentiment and generosity do not pay, and with bitter regret they remember the many but useless proofs of pacifism, humanity, and disinterestedness which they have given to the world, viz.: Premier Viviani's withdrawing French troops ten kilometers from the German frontier; Messimy, War Minister, refusing Professor Turpin's deadly inventions on a plea of humanity; the terrible Vincennite gas poison being delayed in use for like motives, etc., and to crown all, Premier Clemenceau accepting a promise of permanent alliance with England and America as a substitute for the immediate financial and territorial reparations which he had the power to enforce, and allowing the defeated Boche army to preserve its armament instead of dealing with it as was done to the fleet, in the sensible British way—with the result that "innocent" Germany is to-day being pitied and "imperialistic" France being denounced!

No wonder the French national sentiment should have got exasperated. Since striking force and "*capacité de nuire*" are the only things that count and the only solid foundations for the national security, sentimentally inclined France must relinquish her generous feelings and renounce no weapon of offense, all the more so as she is more than able to hold her own in the "savant" and scientific warfare of to-morrow. France has lost through the savage mode of warfare inaugurated by the Boche more innocent victims (children and women) than all the Allies put together; her population has diminished by 2,200,000 (recent census). Torpedoes and aerial bombs will less and less discriminate between non-combatants and bona-fide belligerents; chemical warfare will work extermination over massed, dense centers of population. What is submarine piracy compared with this frightful outlook? France is for the suppression of war, but if war is forced upon her, she may be trusted not to lag behind in the use of the most terrible weapons.

It is no secret, as the successive *Rapporteurs du Budget de la Marine* have published full particulars about it, that up to quite recently the "*artillerie de côtes*" only included obsolete 9.4-inch guns with a range of about 9000 yards. German battle-cruisers, but for the English fleet, could have bombarded Cherbourg and other Channel ports with impunity so far as the coastal artillery was concerned. A new armament of 12 and 13.4 inches will henceforth arm the most important points along the French coast, and, as the Türingen experiments show, the firing efficiency at extreme range (18,000-24,000 meters), with aerial control, will be adequate against the most powerful battleships, pending the completion of the 18-inch and super-cannon batteries that are in preparation. These efficient coastal batteries, combined with aerial and mining organizations, will prove sufficient to keep a prudent enemy at a respectable distance from the French coast. The chances of safe landing which the Boches had in 1914 they will never find again. But "*défense des côtes*" nowadays means very much more; it means for France, by virtue of her geographical situation, the control of the most important European sea routes. This strategic advantage, in these days of long-range submarines and seaplanes, Great Britain is alone to share with France.—*The Naval and Military Record*, 20 July, 1921.

**THE STATE OWNED FLEET.**—The liquidation of the merchant fleet owned by the State is still under discussion, and another report has been drawn up for the Commission of the Merchant Marine by M. Morinaud, who is perhaps more severe in his judgments upon the incompetence of the State as a shipowner than his predecessors. M. Morinaud experienced great difficulty in finding out what the State working of the fleet cost the country, for accounts were practically non-existent, but he ascertained that the loss up to the end of February last had exceeded 550 million francs, and that, too, during a period when freights were extremely high. In a previous report it was learned that the losses had continued at the rate of a million francs a day, although it is understood that considerable economies have been carried out since. The government was urged to get rid of the fleet at the beginning of the present year, and had it done so the operation would have been carried out under fairly satisfactory conditions.—*The Engineer*, 1 July, 1921.

### GERMANY

**THE GERMAN NAVY.**—The semi-official *Marine Rundschau* has furnished some interesting particulars of the manner in which Germany intends to employ the small naval force allowed her by the Peace Treaty. She has now, it may be recalled, six battleships, six light cruisers, twelve destroyers and two torpedo-boats, but no submarines. This force is equally divided between the North Sea and Baltic, in spite of the fact that the *Rundschau* says that the pressure is no longer in the North Sea but in the Baltic, "where the situation created by the separation of the province of East Prussia draws the fleet to the East, and the flag must be shown to those Germans who have been cut off from the Fatherland, and in relation to whom difficulties may yet arise." In the North Sea there will be the battleships *Braunschweig* (flag), *Elsass* and *Schlesien*; the cruisers *Hamburg*, *Arcona* and *Amazon*; and the second flotilla of six destroyers and six torpedo-boats. In the Baltic there will be the battleships *Hannover*, *Hessen* and *Schleswig-Holstein* (the last two to join later), the cruisers *Medusa*, *Thetis* and *Berlin*, and the first flotilla. Most interesting of all in one sense is the news that a 6000-ton cruiser is building or about to be built at Wilhelmshaven. Germany may be a third-rate naval Power, but she is evidently determined to be a very efficient one all the same.—*Army and Navy Gazette*, 23 July, 1921.

**GERMANS BUY SWEDISH SHIPS.**—Germany, taking advantage of the world lull in shipping business and while European harbors are congested with idle crafts, will seek to rebuild her merchant marine, by buying or leasing trade ships from owners of merchant fleets in the Scandinavian countries.

The Department of Commerce was advised yesterday of Germany's plans to take over several Swedish ships, in a cablegram from American trade commissioner Klath, at Copenhagen. Commissioner Klath's message gave no detail of Germany's plan, but officials assumed that Germany now expects to secure a price advantage by purchases at this time.

The shipping situation in most of the principal European countries continues much depressed, according to cablegrams to the Department of Commerce. Officials said there may be significance in reports from Great Britain that improvements in shipping rates give promise of larger business in the future.—*The Washington Post*, 8 August, 1921.

**GERMAN SHIPBUILDING.**—Reports just to hand from Germany indicate a marked revival in the shipbuilding industry. It is true that the obligation to build 200,000 tons a year for Allied Powers, as laid down in the Peace Treaty, is a handicap, but in view of the plethora of shipping, it is becoming a question whether the Allies will wish to insist on the fulfilment of this obligation. The total capital now invested in twenty-six of the principal shipbuilding companies is, according to a return published in *Schiffahrt-Zeitung*, 230,000,000 marks, loan and mortgages total 61,000,000

marks, and reserve funds 52,000,000 marks. The process of amalgamation with the shipyards and the steel trades is not yet concluded, and this policy is regarded as opening up a prospect of simplifying, cheapening and hastening the system of series building which German shipyards have adopted for practical, as well as economical reasons.—*The Engineer*, 1 July, 1921.

**FIRST GERMAN CONCRETE SHIP.**—The first concrete ship built for the new German mercantile marine has been named the *Gotaalf*. She is 118 feet long, 28 feet beam and has a depth of 15 feet. She is of 800 tons dead-weight and 1300 tons displacement.—*Nautical Gazette*, 30 July, 1921.

**GERMAN ENGINEERING COMBINE.**—Fusion of engineering interests in Germany continues. It is announced that the Dusseldorf Machine Works, which are now being re-organized with a view to undertaking the construction of locomotives and rolling stock, is to be amalgamated to a certain extent with the A. E. G., Krupps, Lincke-Hoffmann, and other well-known engineering enterprises. With the object of facilitating export trade, the Wolff interests, whose headquarters are at Cologne, will be included in the new combine.—*The Engineer*, 22 July, 1921.

**GERMANY.**—A new use for the many unfinished submarines which Germany had left on her hands at the close of the war has been discovered by the Germania Yard at Kiel. This yard has just launched two oil tankers, the *Ostpreussen* and *Oberschlesien*, for Herr Hugo Stinnes, both of which were fabricated from the discarded hulls of U-cruisers. The method of constructing the *Ostpreussen*—as described in *Schiffbau*—was to take two of the pressure hulls and join them together in parallel, fitting bow and stern sections to maintain a ship-shape form, and building a superstructure upon the double-hulled vessel thus evolved. Each pressure hull had a maximum diameter of 5.75 meters and a length of 77 meters, the dimensions of the completed ship being as follows: Length over all, 87.4 meters; extreme breadth, 12.3 meters; moulded depth, 7.6 meters; dead-weight capacity, 3000 tons. The ship is propelled by two Diesel engines, originally built for a submarine, but altered to less power and a lower consumption of oil. As modified, each engine develops 700 brake horsepower, and the collective drive of 1400 brake horsepower gives the ship a speed of 10 knots. This method of construction has much to commend it, especially for oil tankers, as submarine hulls possess an uncommonly high degree of water and oil tightness. The *Oberschlesien* was built in precisely the same way, and it is expected that further oil tankers will be ordered after the same pattern.

In May last an American paper published a dispatch from its Berlin correspondent purporting to disclose the "secret" of the destruction of H. M. S. *Hampshire* with Lord Kitchener on board. The story went that on May 29, 1916, the German submarine *W-75*, Commander Kurt Veitzen, had laid 34 mines in the vicinity. Four days later—i. e., three days before the *Hampshire* was lost—a mine-sweeper came to grief in this field. This information either failed to reach Admiral Jellicoe or was overlooked by him in the confusion consequent upon the action off Jutland, for he ordered the *Hampshire* to steer a course west of the Orkneys, in the assumption that no German U-boat had been operating so far north. The latter part of this story is practically confirmed by Lord Jellicoe ("The Grand Fleet," pp. 423-424), but the Berlin correspondent has been wrongly informed as to the identity of the boat. The fatal mines were laid by *U-80*, belonging to the first group of ocean-going submersible mine layers built in Germany. These craft—which must not be confused with the small UC mine layers designed for coastal work, though subsequently developed into a sea-going type—were ten in number, *U 71-80*. They displaced 755 tons and had a cruising radius of 8000 miles at 7 knots. The armament consisted of two torpedo-tubes, one 4.1-inch gun and 38 mines, which were expelled

from tubes at the stern. The type was considered rather a failure owing to the low surface speed of  $10\frac{1}{2}$  knots. *U-80* herself was a lucky boat. She was in service for two years and nine months, during which she is said to have planted upwards of 500 mines in British waters, and in spite of many narrow escapes she survived the war, being among those surrendered to the Allies. A sister boat, ex-*U-79*, is now under the French flag as the *Victor Réveille*.—*The Naval and Military Record*, 6 July, 1921.

**SUNK HOSPITAL SHIP.**—Leipzig.—The trial opened to-day before the Supreme Court of the submarine Lieutenants Boldt and Dittmar, in connection with the sinking of the hospital ship *Llandovery Castle*, and the firing at open boats.

The indictment alleged that Commander Patzig (who disappeared when he was listed for trial), after the ship had been torpedoed, ordered the crew below, and, with the two lieutenants, remained on deck and fired on the life-boats.

Boldt and Dittmar were first cross-examined, but declined to say if their superior officer had recognized the *Llandovery Castle* as a hospital ship. They both denied the charges.

An officer of the torpedoed ship named Chapman said that failure to recognize it would be impossible. He admitted that the ship was going to Liverpool, and did not sail on the route allowed by the German Government.

Witness graphically described the sinking of the vessel. All the lights failed, and the wireless apparatus was put out of order by the first torpedo. All the boats were got off successfully. The boat in which he was answered signals from the submarine, which approached them and nearly ran them down. The commander, with a revolver in each hand, ordered him aboard the submarine, where he gave proofs that the attacked vessel was merely a hospital ship. He was then sent back to his boat, which the submarine again nearly rammed. The commander fired two revolver shots and the submarine fourteen shots over the boat, which escaped.

At the second day's hearing of the *Llandovery Castle* case, in which Lieutenants Dittmar and Boldt are being tried on charges of shooting at survivors of the hospital ship, Walter Popitz, a petty officer belonging to *U-boat 86*, which sank the ship, was called to give evidence.

He described how the *Llandovery Castle* was sighted and how she was bearing the regulation lights for hospital ships. He said the submarine followed her, as they always suspected hospital ships, especially as they were a danger to submarines, adding: "We knew from German newspapers that the English abused hospital ships."

In answer to a question by the president witness said there was nothing suspicious about this ship. The prisoner Dittmar and he (the witness) tried to persuade Lieutenant Patzig, the commander of the submarine, who has absconded, not to attack the *Llandovery Castle*. Patzig not being an autocratic man, and being always willing to discuss things.

Popitz went on to say that the submarine dived and fired two torpedoes, and then came to the surface and waited to see if there was anything about this particular ship to justify their suspicions of the abusive use of hospital ships.

At this point the president asked Popitz why the submarine did not try to investigate before attacking.

Witness replied that was impossible. He saw three or four life-boats with people on board and several men swimming in the water, as though some boats had capsized. Witness then went below. Directly afterwards all the crew were ordered to go below and stay there. There was a general feeling that something unfortunate had occurred. Half an hour afterwards, Popitz deposed, they heard firing, and formed the impression at the time that life-boats were being fired at. So far as he knew, there was no enemy ship in the neighborhood.

The president asked witness whether the second explosion they heard on the *Llandoverly Castle* sounded like munitions.

Popitz answered: No. It was the boilers exploding.

Two days later, said Popitz, Patzig called the crew together and said: "Whatever has happened I take on my conscience before God, and I want you to say nothing about it."

On prisoner's counsel asking a question about Petty Officer Meissener, the president interposed, remarking that Meissener was dead and could not be brought into the case.

Counsel persisted in his inquiry about Meissener, whereupon the president became angry, and said, "I don't think a dead man will be held responsible."

In answer to questions, Popitz said it was early when the *Llandoverly Castle* was first sighted, and they followed her for several hours, and at dusk it was noticed that she was lighted like a hospital ship. She was not taking a zig-zag course.

Popitz on first appearing at the witness stand declared he could not remember anything, but on the president insisting that he must tell what occurred he gave his testimony very clearly.

It is inferred from what Popitz says about all the crew being below when the submarine was firing that the guns must have been manned by Patzig and the prisoners under trial.

Lieutenants Dittmar and Boldt have each been sentenced to four years' imprisonment, but without hard labor, the public prosecutor demanded.

Dittmar and Boldt were charged with murder in the first degree by firing upon life-boats carrying survivors of the British hospital ship *Llandoverly Castle* after it had been torpedoed.

This case differed from all previous trials at Leipzig, in that proceedings were taken at the instance of the German prosecutor. The British Government only demanded the trial of the commander of the submarine, Lieutenant Patzig, who has since fled from Germany and is believed to be at Danzig. The public prosecutor, however, asked to have all the British evidence and after examining it he ordered Lieutenants Dittmar and Boldt to be arrested and tried.—*Army and Navy Gazette*, 23 July, 1921.

**STIRRING UP STRIFE.**—Several German papers, we are told, described Boldt and Dittmar after their conviction as "U-boat heroes." We know now what "hero" signifies to the German mind! This and countless other instances of the shameless, morbidly revengeful spirit which appears to animate the greater part of the German people constitute a warning too serious to be ignored. They are forcing us to regard them as bitter enemies who will lose no opportunity of revenging themselves for the absurdly inadequate penalties they have incurred at our hands. From high to low the same spirit prevails. The "intellectuals" are fed with tirades from the professorial "old gang," who are far more bellicose and loquacious to-day than before the war; while the Anglophobe sentiments of the masses are lavishly catered for by the gutter journals. One result of this organized provocation to mischief was seen at the German port of Geestemünde early this month, when the Grimsby trawler *Keelby*, which had put in to coal, was stoned by a mob, who smashed everything breakable, injured one of the crew, and directly caused the loss of the vessel by compelling the master to navigate her out of the harbor stern first, where she grounded, receiving damage that led to her foundering a few hours later. We assume that more will be heard of this incident, the facts of which we have taken from Lloyd's list of marine casualties. So long as this sort of thing goes on—as go on it will unless the Mad Mullahs of Germany grow weary of preaching the doctrine of hatred—there can be no real peace in Europe. Germany alone can stop the mischief, and thus pave the way to that resumption of normal and not unfriendly relations which it is obviously to her interest to promote. The British are not an unfor-

giving people, and they would be glad enough to see the first symptom of returning sanity among the German people. But they are still looking for it.—*The Naval and Military Record*, 27 July, 1921.

**BRITISH AND GERMAN WARSHIP DESIGN.**—When the Director of Naval Construction read his "Notes on Some Features of German Warship Construction" at the Institution of Naval Architects last March, and spoke somewhat critically of German designs and naval matériel in general, it was evident to all who know how extremely sensitive to criticism our late enemies are that they would not take this adverse judgment lying down. They have now delivered their counter-attack in the form of a long article published in *Schiffbau* from the pen of Geheimer Oberbaurat Dr. H. Bürkner, formerly chief of the Shipbuilding Division of the Marine-Amt, whose position corresponded, therefore, to that held in England by Sir E. T. d'Eyncourt. Dr. Bürkner shows himself to be an able advocate. His case for the defense is the more convincing because it is put with restraint and courtesy. He takes each paragraph of Sir Eustace's paper and comments upon it, and while his article is far too long for textual reproduction, I propose to deal with his principal points, for he gives us many new and interesting facts about German naval construction.

Sir E. d'Eyncourt observed in his paper that the Germans had the advantage over us of larger docks, which enabled them to build broader ships with greater initial stability. Dr. Bürkner writes: "This disability would certainly have been removed had the British constructors sufficiently emphasized the need of larger docks, for it is inconceivable that the leading naval power would have hesitated to provide such docks, however great the cost, if they had been considered indispensable. As regards Germany, the decision to increase the metacentric height by approximately 100 per cent was taken when the first dreadnoughts (*Nassau* class) were planned. This was a decision the boldness of which Sir Eustace will doubtless appreciate. When he argues that we, owing to our broader docks, had a freer hand than he or his predecessors he overlooks the fact that we on our side were no less handicapped by the shallowness of our coastal waters."

Mr. Goodall, R. C. N. C., who read a paper on the *Baden*, spoke of this vessel as indicating the latest German ideas on battleship design. Dr. Bürkner writes: "The *Baden* was unfortunately the last German capital ship to reach completion, but later designs had been produced, *i. e.*, the *Baden's* improved sisters, *Sachsen* and *Württemberg*, and the battle cruisers of the *Mackensen* and *Ersatz Yorck* classes, armed respectively with 14-inch and 15-inch guns. As Sir Eustace alludes with pride to the *Hood* as the last word in British construction, it would be of interest to compare this ship with the German capital ship design got out in 1917. I am, however, not authorized to give the details necessary for such a comparison.

The *Baden* was not in any case our supreme effort in the development of the battleship type, although war experience did not reveal the necessity of modifying our principles of construction, either fundamentally or in important detail. It is true that after the Battle of Jutland we did not have to carry out in our ships such far-reaching alterations as the British found it expedient to make in theirs.

"Sir Eustace d'Eyncourt refers to the *Baden* as an 'interesting ship,' but adds that she was designed as soon as Germany heard of the *Queen Elizabeth* class, of which she is a 'fairly close but inferior copy.' That is a pure myth. Except in the caliber and disposition of her guns and in the general arrangement of her external armor the *Baden* exemplifies totally different ideas of construction. In point of fact, not even in respect of her artillery can we admit her to be a copy of the *Queen Elizabeth*, for the caliber and arrangement of her guns were approved by the Kaiser on January 6, 1912, after endless discussion, and at that time no news as to the *Queen Elizabeth* had reached Germany beyond the rumor that a heavier



British gun than the 13.5-inch was contemplated. Sir Eustace surely does not suppose that we had knowledge of the *Queen Elizabeth's* armament, etc., nine months before she was laid down. The *Baden* class was, in truth, developed out of the *König* class in all essential features except armament, and the latter was decided on in the first days of 1912."

Dr. Bürkner contends, on the other hand, that the armor protection of the *Queen Elizabeth* was modelled after that of the German *Kaiser* class, which had been begun at the end of 1909; and, further, that we adopted German ideas in restoring the 6-inch secondary armament in the *Iron Duke* and later types. He deals next with the statement that the *Baden's* speed is inferior to the *Queen Elizabeth* and her protection inferior to that of the *Royal Sovereign*. As regards protection, he writes: "The *Royal Sovereign* is inferior to the *Baden* in defence above and below water excepting only the 2-inch armor deck in the citadel, and even this deck would offer small resistance to A. P. shell with good delay-action fuses owing to its high position, pronounced slope, and want of coal protection. The corresponding arrangement in the *Baden* consists of a 1.1-inch steel deck, a 1.1-inch and 3-inch splinter bulkhead, and bunkers filled with coal. Sir Eustace mentions that the *Baden* steamed three knots less on trial than the *Queen Elizabeth*, and that she suffers from the drawback of mixed firing. The creation of a fast battleship division had repeatedly been discussed in Germany, and was a pet idea of the Kaiser's but it had been dropped at the time when the *Baden* was designed. Unless we had sacrificed fighting power or increased dimensions beyond the permissible limit it could only have been realized by adopting oil only, and this was objectionable on two grounds—first, because it was impossible to guarantee an adequate oil supply in war time, and, secondly, because coal afforded excellent protection against shellfire, mines, and torpedoes, whereas oil fuel required protection itself. Consequently, we contented ourselves in the *Baden's* case with a speed no higher than that of the preceding *König* class. But what practical value was derived from the *Queen Elizabeth's* margin of speed is shown by Admiral Jellicoe's Jutland dispatch, in which he says: 'The fact that the 5th Battle Squadron (*Queen Elizabeths*) was unable to increase its distance from the German ships (*König* class) when steaming at their utmost speed, comes as an unpleasant surprise.'"

According to Sir E. d' Fyncourt, the *Baden* and most of the more recent German capital ships are subdivided more minutely than the British in some parts, but less so in others, so that the arrangement as a whole does not make for any greater safety in case of accident or flooding than in the British ships. To this Dr. Bürkner remarks that, since the plans of the *Queen Elizabeth* and *Royal Sovereign* are unknown to him, he cannot express an opinion, but, as regards the earlier ships, he is able to give a comparison of the sub-division of the rival types based on plans of the *Emperor of India* and *Princess Royal* which fell into German hands during the war. They are contrasted below with the *König* and *Derfflinger*, ships of corresponding size and date:

Sub-division below the armor deck, given in percentages of total space:

	König	Emp. of India	Derfflinger	P. Royal
Small compartments less than 300 cbm...	75	70	65	49
Medium compartments 300-1000 cbm....	25	7	28	9
Large compartments more than 1000 cbm.	0	23	7	44

The above table shows that the number of small compartments (double bottom, passages, etc.) is practically the same in the British and German ships. While, however, the German ships have many more medium compartments, but practically no large ones, in the British ships the latter occupy from one-quarter to one-half of the total space below water. "This disparity," writes Dr. Bürkner, "is so great that it cannot be brought to harmonize with the lecturer's assertion. A comparison above water would be equally advantageous to the German ships." He adds that if damage

to the armor deck of the *Princess Royal* caused one of the main engine-rooms and its adjoining wing compartments to be flooded the ship would assume a list of 17 degrees, whereas corresponding damage to the *Derfflinger* would produce a heel of only  $9\frac{1}{2}$  degrees.—*The Naval and Military Record*, 20 July, 1921.

### GREAT BRITAIN

**NATIONS AND THEIR NAVIES.**—While plans are in process of formulation for an international conference in Washington to consider the question of placing a limitation upon armaments, the British House of Commons has voted approval of the government's plan to construct four battle cruisers, to be completed by 1925. These ships will carry 16-inch guns and will be of the fastest and most powerful type.

It is explained that the addition of these vessels to the British Navy is a replacement of four battleships that are now obsolete. However, the substitution of four ultra-modern battle cruisers, carrying the heaviest armament known, for four out-of-date ships, is more than a replacement. It will amount to a very decided increase in the naval strength of the empire.

The British Government has proposed this addition, and commons has approved it, upon the theory that the vital interests of the nation demand that the navy be maintained as the strongest of any in the world. Officials declare that in view of the building programs of the United States and Japan, this status cannot be held by England without the increment just authorized. In fact, they profess that a much greater addition should be made, and would be made except for a desire to avoid the appearance of inconsistency in entering into competition with other powers for naval supremacy on the eve of the disarmament conference.

Little fault can be found with the determination of the British Government to conserve the vital interests of the empire according to its own lights. On the contrary this is a policy which some members of the American Congress might emulate to advantage. Taking the utterances of English statesmen at par value, they stand ready to co-operate with the United States and other great powers for a limitation of armaments; that is, an agreement first to cease additional construction, and later possibly to reduce existing armaments. They seem to assume that any limitations agreed upon will recognize the proportionate naval strength of the various powers as it exists at the time of the agreement, and that idea appears to be prevalent generally.

Appropriation for continuing the building program of the American Navy were voted over the opposition of a considerable peace faction in Congress, which demanded a cessation of construction in view of the announced intention of the President—supplemented by a formal, though unnecessary, authorization in the naval bill—to inaugurate a movement looking to limitation of armaments. Appeals to this contingent to support the government's policy to keep on with a consistent program, originally adopted in 1916, until an international agreement could be reached, fell upon deaf ears. They insisted that the United States should set an example to the world of its sincerity by slowing up, and there are Representatives and Senators who even now would have the Navy Department stop building operations, although Great Britain and Japan are proceeding to increase the strength of their navies pending the time when a limitation agreement shall be made.

However, it is the opinion of a strong element in this country, and has been since the close of the war, that the long coast line of the United States and the great and growing foreign trade make it imperative that this nation should have a navy second to none in the world. Whether or not it may be regarded as desirable to compete with Great Britain for equality of naval strength, if not for supremacy, every intelligent American is ready

to concede that this country should have a navy adequate to protect its interests under all circumstances. It may be added that many of those who were opposed to a naval increase were at the same time opposed to a reduction of the relative strength of the United States in comparison with England and Japan. The existing status can only be maintained by following a rational policy of additions, such as that just authorized by the House of Commons.

America cannot stand still and do nothing, with England and Japan constructing new ships, unless she sacrifices her position as the second naval power in the world and surrenders all hope of taking or sharing first place. Every keel authorized by Congress should be laid promptly, and work should not be permitted to lag in any respect. Like England, this country should consider her national interests as paramount, and like her, too, America must be the sole judge of those interests. In doing this no American, official or private citizen, need abate any of the ardent hope which he cherishes for the successful outcome of the approaching disarmament conference.—*The Washington Post*, 5 August, 1921.

**CAPITAL SHIP DESIGN.**—Nothing authoritative is likely to become generally known regarding the design of the capital ships which are to be built for a long time to come. We may, indeed, be permitted to learn general details as to tonnage, guns and speed. But the various new features which it is safe to predict will be embodied in these vessels as the fruits of the experience of the war will be kept secret as long as practicable. Nor is there any ground for dissent from this principle. For whilst it is true that at the present time there is no rivalry of naval armaments in the sense that existed between this country and Germany before the war, yet so long as the nations continue to build fighting ships they are really in competition.

From the length of time it would take, and the cost it would involve, according to Admiralty computation, to extend existing dockyard slips sufficiently to receive the new keels, we may infer that, so far from any reduction of displacement, as had been suggested, the vessels are likely to prove bigger than anything yet built. It is also regarded as certain that they will possess a very high speed, and an unprecedentedly wide radius of action.

As to whether the new vessels will be battleships or battle-cruisers, in their official definition, this seems to have become a really immaterial point. For the fact is the two types have nowadays become so merged that it is not easy to differentiate between them. Thus the *Hood* is easily the most powerful ship in the British Navy alike in her aggressive and defensive qualities. Whilst she is in reality a super-battleship, she is classed as a battle-cruiser merely by virtue of her speed.

The original idea of the battle-cruiser was a vessel of a lower fighting value than a battleship, in consequence of the sacrifice in armament and armor necessitated by the demands of a much higher speed. The *Inflexible* group, which were the first of the new type, although only 700 tons less in displacement than the *Dreadnought*, carried eight 12-inch guns as against ten, and were only armored with a belt of 6-inch Krupp steel, tapering to 4-inch, as compared with the 11-inch and 6-inch broadside of the *Dreadnought*. But then they had turbines developing 41,000 shaft horsepower, as compared with the 27,500 shaft horsepower of the *Dreadnought*. Their extra speed of five knots was regarded as well worth the price of reduced fighting power and we find this same principle relatively maintained in successive types down to the *Lion* class.

With the advent of the *Queen Elizabeth* class it was believed that the two types had become merged, and that no more battle-cruisers, as such would be built. The vessels of this group added to the most formidable aggressive powers which had ever yet materialized the same rate of speed as the *Inflexible* class. The war, however, brought new ideas—

or more strictly speaking, a reversion to the earlier idea—on this subject, and the *Repulse* and *Renown* were built. These vessels, of 26,500 tons, are the fastest capital ships ever constructed, not excluding the *Hood*.

But their protective qualities were hopelessly out of proportion to their 15-inch armament. Their broadside belting only consisted of 6-inch-3-inch armor. The *Repulse* has been reconstructed at an expenditure of more than half her original cost. It was only a logical sequence to the reasoning which produced these vessels to turn out the *Courageous* type with no broadside belting at all. Jutland emphasized the immeasurable tactical value of very high speed, and the *Hood* was the result. We shall probably henceforward see only one type of capital ship constructed, embodying in the highest degree all the qualities of the battleship, coupled with the great mobility of the battle-cruiser.—*The Naval and Military Record*, 27 July, 1921.

THE NAVY'S "BIG FOUR."—According to present arrangements the specifications for the new battleships will be ready in about a month from now, and tenders will then be invited from the several firms which are in a position to undertake such work. After the contracts have been awarded some months must elapse before building operations can begin, and it is therefore doubtful whether the keels of any of the vessels will be laid much before the end of the year. As their construction is to occupy three years they will presumably be passing into service about the beginning of 1925. Replying to questions in the House of Commons last Thursday, the Prime Minister made it plain that the execution of the battleship program will not be affected by the forthcoming Washington Conference. This disposes of rumors to the contrary which had been circulating in London. Mr. Lloyd George availed himself of the opportunity to repeat the disclaimer contained in the First Lord's memorandum on the Navy Estimates, that "in making this long-delayed beginning with the replacement of obsolete ships the government neither commits itself to nor contemplates any building 'programs' in answer to those of any other Power." Used in this connection the term "program" is given a somewhat sinister import, though it is quite certain that there is nothing sinister about our building project for the current year. If the capital ship is to remain the principal unit of naval power, four new vessels of this type represent the irreducible minimum needed to maintain the British Navy in its relative position of strength. They will be our only genuine post-Jutland ships, whereas America will have 16 and Japan at least 12 capital ships designed and laid down subsequent to the Battle of Jutland.—*The Naval and Military Record*, 27 July, 1921.

U-BOATS SUNK.—Ex-German submarines *U-135* and *161*, which under the terms of the Peace Treaty had to be destroyed or rendered unfit for further service, were at 5 a. m. on Thursday towed from Devonport by the tugs *Retort* and *Rover*, accompanied by the *Adamant*, depot ship of the Second Submarine Flotilla, and submarines *L-21* and *52*.

Fine weather prevailed, and the craft proceeded to a point about 60 miles south of the Eddystone Lighthouse, where the sinking of the U-boats by gunfire from the 4-inch guns of the submarines was ordered to take place.

Shortly before dusk that night it was reported that the operations had been completed and the vessels were returning to port.—*The Naval and Military Record*, 20 July, 1921.

BIG-GUN SUBMARINES.—Submarine *M-3* has been completed to full crew at Portsmouth, and is to join the First Submarine Flotilla of the Atlantic fleet. She is the first craft of her class to be attached to a seagoing fleet for regular service. Other boats of the same type are to replace the *K* submarines in the flotilla, which are all to be withdrawn from regular

commission. When the reorganization of these forces is complete, the Atlantic fleet will have only *L* and *M* submarines affiliated to it.

The *M* boats have been described, more picturesquely than accurately, as submarine-battleships, owing to the fact that they are armed with a 12-inch gun. In addition, they carry the usual torpedo armament. Designed late in the war, they were intended to act as independent units rather than in flotilla formations. In a fleet action their heavy weapon would be of comparatively small value, since they would have to expose themselves on the surface for an appreciable spell to fire, thereby presenting a big target to enemy fire. Indeed, the rôle of the submarine acting with a battle fleet is likely to remain restricted to underwater attack. But many situations may arise during the course of a sea war in which the sudden appearance of a vessel armed with a 12-inch gun, and of a tolerably high rate of surface speed, might effect a decisive result.—*The Naval and Military Record*, 20 July, 1921.

**PAUSE IN DEVELOPMENT.**—We appear to have come to a pause in the development of the submarine, alike in size and armament. The disaster to *K-5* was attributed to the fact that she dived too deep, owing to her great length and displacement, and doubtless this loss has exercised a very definite influence upon the whole question of submarine design. But probably a still stronger reason for the lull in progress, not only in this country, but in the United States and Japan, is uncertainty as to the tactical value of the giant submarine.

More than two years ago Sir Eustace d'Eyncourt pointed out that there were no mechanical difficulties in the way of building submersible battleships, but that it was not worth while. Sir Percy Scott succeeded in stirring up and maintaining a "stunt" upon the subject, but when it came to be submitted to an expert tribunal they upheld the views of the Director of Construction. The general conclusion in naval circles is that the submarine has passed the zenith of her possibilities against surface craft: that she can never be as formidable in the future as she has been in the past.—*The Naval and Military Record*, 20 July, 1921.

**NAVY'S OIL FUEL.**—In an order issued last week, the Admiralty notify that Mexican oil fuel may be used in all battleships and battle-cruisers fitted with heating coils, and should be supplied to these vessels on every possible occasion (except for use in Diesel engines) in preference to any other description. Arrangements are being made to carry out trials with Mexican oil in light cruisers and destroyers, with a view to extending further use of this oil.

In another order the Admiralty direct that in order to conserve the more fluid descriptions of oil fuel and those which do not increase greatly in viscosity under conditions of prolonged storage, a mixture of 50 per cent Persian and 50 per cent Mexican oil fuel should be issued to the fleet during the warmer months whenever such descriptions of fuel are available.

This mixture is to have priority in supply over all other mixtures during the period April 1 to September 30, except in the case of supplies: (a) For use in Diesel or semi-Diesel engines. (b) To vessels proceeding to any area where sea temperatures of 50° F. or below are likely to be encountered. (c) To battleships and battle-cruisers which burn Mexican fuel unmixed so far as heating coils admit.

This Persian-Mexican mixture should be utilized before any other stocks on board H. M. ships and any quantity remaining on board H. M. ships due to pass into the reserve fleet should be returned to store before vessel passes into reserve.—*The Naval and Military Record*, 20 July, 1921.

**RECONSTRUCTING THE JUTLAND BATTLE FOR THE "MOVIES."**—The recent war has been thoroughly recorded for posterity. There is no doubt about

it; for books, documents, photographs and motion pictures are available on practically every detail of the great conflict.

The latest contribution to the rather voluminous motion picture records of the war is an ingenious film depicting the naval Battle of Jutland, and recently produced in England. The stirring battle was reconstructed with infinite care and accuracy by means of miniature battleships, and animated for the motion picture film in the manner generally followed in producing trick pictures. The reproduction of a moving bird's-eye view of the Battle of Jutland for the films proved to be an immense task, we learn from *The Illustrated London News*. The work was carried out according to track charts prepared by Sir George Ashton, by a British film company, on a board measuring 8 feet square. The model ships were made in three sizes—4-inch for close-ups, 2-inch for medium shots, and 1-inch long for long shots. Ships, "sea" and "sky," were painted in shades of gray. Gunfire and explosions were produced by blowing smoke through pipes. For each picture each model had to be moved only 1/16 of an inch. There are sixteen pictures to every foot of motion picture film, hence the passage of the Grand Fleet across the North Sea required 90 feet of film, and 80,000 separate movements by hand of the models. That of the German fleet required 60,000 movements.—*Scientific American*, 16 July, 1921.

## JAPAN

JAPAN AND THE ALLIANCE.—Japanese papers do not appear to have been greatly impressed by the eloquent plea of Mr. Hughes, the Premier of Australia, in favor of renewing the alliance. Until lately, they declare, he was just as eloquent in opposing it, and they ascribe his change of heart to the discovery that a navy strong enough to protect Australia if the alliance lapsed would cost too much money to build. But when it comes to denouncing inconsistency, our Japanese friends should remember that they lay themselves open to the same charge. A correspondent reminds us that the present enthusiasm in Japan for the alliance is strangely at variance with that country's attitude during the war. In 1915 the journal *Yamato*, after deriding Britain's military powers, wrote of the Germans as being inspired with "sound, excellent, and noble ideals, closely approaching the Japanese people and their bushido spirit. Seeing," it added, "that Japanese civilization is fashioned after the German rather than the English model, why should the Japanese hesitate to admire and emulate Germany's strong points?"

At the same period, Major Miwa, a Japanese military correspondent, wrote slightly of the British troops, and declared that they had to be bribed with luxuries to join the colors. This was at a time when we had recruited far more than a million volunteers! In December, 1915, when Germany was apparently having things all her own way, Prof. Tatebe Tongo, of the Tokyo Imperial University, was writing in this strain: "As the national ideal of England is individualism and selfishness, so the guiding principle of England in international affairs is also individualism and selfishness. Such nations as Japan and England can never continue long in alliance." The British, he added, were a race of effeminate, with whom Japan could not afford to keep company. "Is it not time," he demanded, "to talk about separation?" Other writers joined in condemning the alliance as obsolete and worthless, and the government, which maintains a strict hold over the press, did not see fit to intervene. We recall these facts, not to cast doubt on the sincerity of Japan's friendship for us, but merely to show that in her case, as perhaps in our own, altruism is not the only factor which dictates foreign policy.—*The Naval and Military Record*, 20 July, 1921.

AN ANGLO-YANKO-JAPANESE TRIANGLE.—Within the triangle formed by a naval agreement between Britain, Japan, and America "there would be nothing in the world which could not be done," according to the *London Times*, and its remark is warmly indorsed by various Japanese newspapers. Among these is the *Tokyo Jiji*, which interprets it as meaning that the co-operation of Japan, Great Britain, and America is the first requisite of world peace, and it maintains that such co-operation premises a naval disarmament agreement between the three countries. Then it will be possible to arrive at an understanding with America regarding the object of the Anglo-Japanese alliance, which is to insure the peace of the Far East, and this important *Tokyo* daily says that "at the same time the hypothetical enmity between the three countries can be rectified, with the result that their peoples will enjoy greater happiness and all mankind will be freed from the excessive burdens of armaments." The *Jiji* proceeds:

"Let us then turn attention to the *New York World* which says that unless America abandons the ambition of establishing the world's first navy, there can be no hope for a naval agreement and consequently no permanent peace will come to the world. This shows that the idea of promoting the world's peace on the basis of a naval agreement between Japan, Great Britain, and America is supported by an influential body of opinion in America also. Even when the situation is considered theoretically, a disarmament agreement and co-operation for peace are only two sides of one policy, and it is natural that an agreement between the three countries for the restriction or reduction of naval armaments should have a close bearing on their co-operation in the cause of peace. There is no doubt that the agreement should be based on that co-operation."

Some say it is useless to talk of an armament agreement among the three countries unless a triple *entente cordiale* is first established. In fact, a naval agreement under the present international relations, they say, is "putting the cart before the horse." This plea is admitted by the *Jiji* to be reasonable, though it believes it is overstepping the mark to hold that the proposal for a naval agreement without the *entente cordiale* is an empty dream, and it adds:

"In our opinion the highest object to be kept in view by the three countries in co-operating for their own peace and for the peace of the world is the very agreement for the prevention of armaments competition between themselves. There can be no other matter which requires more urgently to be made the basis of the tripartite co-operation. Even granting that there is a more urgent objective than a naval agreement, the latter will continue to demand the earnest and sincere efforts of the governments and peoples of the three countries. Nay, since an armament agreement signifies the restriction or reduction of armaments on the basis of mutual trust, it itself is an important instance of co-operation, and therefore such an agreement will automatically have the effect of bringing about broader co-operation between the three countries. In view of the fact that the wishes of the governments of Great Britain and America and the desires of their governments regarding an armament agreement have already been demonstrated and the matter is now entering upon the stage of action, it is wide of the mark to say that the co-operation of the three countries and an armament agreement are in the relation of the principal and the auxiliary or to point out the questions pending regarding Yap and Mesopotamia and say that it is of no use to talk of an armament agreement under the existing circumstances. While urging people holding such opinions to reconsider their points of view, we would advise the government and people to make greater efforts for the realization of a naval agreement between the three countries.—*The Literary Digest*, 6 August, 1921.

UNITED STATES

NAVY DEPARTMENT—BUREAU OF CONSTRUCTION AND REPAIR

VESSELS UNDER CONSTRUCTION, UNITED STATES NAVY—DEGREE OF COMPLETION,  
AS REPORTED JULY 31, 1921

Type, number and name	Contractor	Per cent of completion			
		Aug. 1, 1921		July 1, 1921	
		Total	On ship	Total	On ship
<i>Battleships (BB)</i>					
44 California	Mare Island Navy Yard	99.	99.	98.	98.
45 Colorado	New York S. B. Cpn.	77.1	75.2	75.4	73.5
46 Maryland	Newport News S. B. & D. D. Co.	Dec. 7	20-21	99.5	99.3
47 Washington	New York S. B. Cpn.	68.8	62.4	67.3	60.8
48 West Virginia	Newport News S. B. & D. D. Co.	59.3	51.3	57.	48.2
49 South Dakota	New York Navy Yard	32.8	26.5	32.2	25.7
50 Indiana	New York Navy Yard	31.2	24.	29.8	22.7
51 Montana	Mare Island Navy Yard	26.6	18.8	26.1	17.3
52 North Carolina	Norfolk Navy Yard	36.1	27.1	35.8	26.6
53 Iowa	Newport News S. B. & D. D. Co.	28.3	24.7	26.3	22.6
54 Massachusetts	Beth. S. B. Cpn. (Fore River)	10.4	3.9	8.6	3.0
<i>Battle Cruisers (CC)</i>					
1 Lexington	Beth. S. B. Cpn. (Fore River)	23.1	13.8	21.1	12.3
2 Constellation	Newport News S. B. & D. D. Co.	12.5	10.3	11.5	9.
3 Saratoga	New York S. B. Cpn.	25.6	16.9	24.2	15.4
4 Ranger	Newport News S. B. & D. D. Co.	2.2	.9	2.	.8
5 Constitution	Philadelphia Navy Yard	10.4	5.9	9.2	5.2
6 United States	Philadelphia Navy Yard	10.2	5.7	9.2	5.2
<i>Scout Cruisers (Light Cruisers CL)</i>					
4 Omaha	Todd D. D. & Const. Cpn.	93.9	85.7	93.	84.7
5 Milwaukee	Todd D. D. & Const. Cpn.	91.3	83.	90.5	82.1
6 Cincinnati	Todd D. D. & Const. Cpn.	86.2	78.8	84.4	77.9
7 Raleigh	Beth. S. B. Cpn. (Fore River)	63.2	45.6	59.7	41.5
8 Detroit	Beth. S. B. Cpn. (Fore River)	63.7	46.1	59.8	41.6
9 Richmond	Wm. Cramp & Sons Co.	69.	51	67.	45.
10 Concord	Wm. Cramp & Sons Co.	65.	45	64.	42.
11 Trenton	Wm. Cramp & Sons Co.	50.	32.	47.	30.
12 Marblehead	Wm. Cramp & Sons Co.	46.	28.	45.	27.
13 Memphis	Wm. Cramp & Sons Co.	40.	25.	39.	24.
<i>Auxiliaries</i>					
Fuel Ship No. 18, Pecos	Boston Navy Yard (Oiler AO 6)	99.	99.	97.2	97.
Repair Ship No. 1, Medusa (AR 1)	Puget Sound Navy Yard	66.	50.3	63.6	48.1
Dest. Tender No. 3, Dobbin (AD 3)	Philadelphia Navy Yard	66.3	66.	64.8	64.5
Dest. Tender No. 4, Whitney (AD 4)	Boston Navy Yard	30.6	24.5	28.9	21.9
Sub. Tender No. 3, Holland (AS 3)	Puget Sound Navy Yard	21.5	5.5	20.2	4.2
Aircraft Tender, Wright (AZ 1)	Tietjen & Lang	87.	....	80.	....
<i>Patrol Vessels</i>					
Gunboat No. 22, Tulsa (PG 22)	Charleston Navy Yard	70.3	52.1	69.2	50.5

In addition to the above there are under construction 4 destroyers, 4 fleet submarines, and 37 submarines.

Authorized but not under construction or contract 12 destroyers, 7 submarines and one transport.



OUR LATEST BATTLESHIP, THE "MARYLAND."—When the super-dreadnought, the U. S. S. *Maryland*, steams out of Hampton Roads early in November and points her clipper bow toward the sea for her official government trials, the nation will hail a new pride of the navy and the navy itself will acknowledge a new Queen of the Seas.

The *Maryland* is in every respect the latest completed achievement of American naval architects. Carrying eight 16-inch guns, the largest ever mounted in a battleship, she will be the most powerful fighting vessel in the world. These mammoth guns, located in four turrets of two guns each, fire a shell weighing 2100 pounds for an extreme distance of more than 20 miles. The guns are over 60 feet in length and for each full charge approximately 480 pounds of powder are required.

The secondary battery, consisting of fourteen 5-inch guns, is carried for use against torpedo-boats, submarines and other smaller craft. The ship has also four 3-inch anti-aircraft guns, a 3-inch landing gun, six .30 caliber machine guns and two under-water 21-inch torpedo-tubes for firing the largest and longest range torpedoes.

The *Maryland* possesses all the latest provisions for protection against torpedo attacks. It is claimed by naval architects that it would require several hits by torpedoes to sink the ship by an under-water attack. The crew and vital parts will be protected by armor plate so thick that only the largest caliber shells, fired at moderate range could get through.

Displacing 32,600 tons, this fine warship, electrically driven, will have a speed of 21 knots and a cruising radius of 10,000 miles. She will burn oil, her fuel capacity being approximately 1,400,000 gallons.

The *Maryland* is 624 feet long and has a beam of 97½ feet. There will be 67 officers in the ship's complement and more than 1400 men in her regular crew.

This most modern of warcraft recently completed her builders' trials with a perfect record. For 33 continuous hours at sea off the Virginia Capes, she was put through all sorts of tests, bringing into play the greatest possible stress on all parts of her machinery and equipment; but not the slightest trouble was experienced. In fact, naval officials declared she operated more like a boat that had been in service four or five years, so readily and easily did she respond in the tests.

Captain Charles F. Preston, who has been assigned to the command of the *Maryland*, and was aboard during the preliminary trials, is most enthusiastic over the perfect performance of the new electrically-driven ship. "Never on a warship that pleased me more in my 36 years with the navy. She's a wonder in every respect, the best warship in our navy and the most powerful in the world," he declared; "I am highly pleased and satisfied with her electric equipment. There is practically no vibration and sometimes I actually looked out to sea to learn if we were under power, so quietly and smoothly did her machinery operate."

Like her prototype, the *New Mexico*, pioneer electric warship of the world, the *Maryland* is electrical throughout. Her main propulsion machinery consists of two Curtis steam turbine generators, each designed to develop 11,000 kilowatts at a speed of 2030 revolutions per minute to drive the ship 21 knots. These supply power to four 7000-horsepower General Electric induction motors, directly connected with the four propellers and turning at 170 revolutions per minute. The motors, among the largest ever built, are 12 feet in diameter, weigh 62 tons, and the 28,000 horsepower thus available for propulsion purposes is enough to supply power to a city of 100,000 population.

The two turbine generators, supplied with steam generated by oil-burning boilers, can be run independently. Either is capable of driving the ship up to a speed of about 17 knots. The power generated by them is used for no other purpose than propelling, electrical current for other needs being generated by six 300-kilowatt turbine generators,

Virtually every electrical appliance used afloat and ashore has been installed in this new battleship. The electrical equipment includes radio telegraph, loud speaking telephones, ordinary telephones, gyroscope compass, steering gear, anchor windlass, capstan, boat cranes, winches, air compressors, air heaters, turret training, turret gun elevating, ammunition hoists, gun firing, range signaling, powder testing oven, common deck fans, ice machines, laundry equipment, carpenter shop, lighting, visual signals, motion pictures, sterilizer in operating room, potato peeler, ice cream freezer and other kitchen utensils, bake ovens, irons for laundry and tailor, storage batteries, motor boat ignition, etc.

It is probable that no ship built by any nation in the past has been so thoroughly equipped for the comfort and convenience of the crew.

A completely equipped hospital will be maintained on board with navy surgeons to look after the health of the crew and a dentist to look after the men's teeth. A chaplain will be assigned to the ship to hold regular church services and to devote his time to spiritual welfare of the officers and men.

The *Maryland* is third in order of completion of the electrically-propelled battleships for the navy. She was built by the Newport News Shipbuilding and Dry Dock Company and the electrical equipment was designed and manufactured by the General Electric Company.

The ship was launched on March 20, 1920. Her chief characteristics are:

Length .....	624 feet
Beam .....	97½ feet
Draft .....	30½ feet
Weight .....	32,000 tons
Speed .....	21 knots
Number of propellers .....	4
Shaft horsepower .....	30,000
Oil capacity .....	1,400,000 gallons
Oil-burning boilers .....	8

Three more battleships of this type are being built: the *West Virginia* to be ready for her trial trips in 1922, the *Colorado* and the *Washington*. In addition the navy is building six 43,000-ton, 60,000-horsepower battleships and six battle-cruisers, the latter rated at 180,000 horsepower each, which makes the propelling machinery six times as powerful as that of the *Maryland*. Both of these types of warships will carry 16-inch guns and will be electrically driven.

Production of the electrical machinery for several of these vessels is now progressing under the direction of W. L. R. Emmet, who advocated the principles of the electric drive as long ago as 1909, was instrumental in its adoption by the government and designed the first electric drive installed by the navy on a battleship, now working so successfully on the U. S. S. *New Mexico*.—*The Scientific American*, 16 July, 1921.

THE SEAPLANE TENDER U. S. S. "WRIGHT."—It is now expected that the U. S. S. *Wright*, the new seaplane tender for the navy will be placed in commission about August 15, 1921. She will take the place of either the *Aroostook* or the *Shavmut*, now being used for that purpose in the Pacific and Atlantic Fleets. The vessel is named in memory of Wilbur Wright.

Arrangements were made with the U. S. Shipping Board late in 1919 for the Navy Department to take over one of the Emergency Fleet Corporation's type B ships, Hull No. 680, then building at Hog Island for the Shipping Board, and to convert the vessel into an aircraft tender for kite balloons and seaplanes for the U. S. Navy. The hull was launched at Hog Island on April 28, 1920, and contract for the conversion work was let to Tietjen and Lang Dry Dock Company, of Hoboken, N. J., on June 30, 1920.

The conversion work now being executed by Tietjen and Lang Dry Dock Company includes additions, changes and alterations necessary to fit and complete the vessel in every respect for sea service, including provisions for the stowage of six kite balloons, for the inflation and housing of kite balloons aft in a balloon well, for the necessary hydrogen generating plant for balloon inflation, for hydrogen stowage and for efficient repair plants for the balloons and seaplanes.

The vessel is being arranged for flying operations of kite balloons and as a tender for seaplanes, carrying spare wings and other spare parts.

The quarters are being arranged to accommodate the ship's own complement and officers, and officers and personnel assigned to the care and operation of the kite balloons and seaplanes. Berthing and messing accommodations are being provided for the captain, one detachment commander, 28 wardroom officers, 20 junior officers, 12 warrant officers, 60 chief petty officers and 450 men. The chief petty officers will be berthed in pipe berths and the crew in hammocks. The hospital space will include: Operating room, treatment room, sick bay bath, isolation ward, surgeon's room, dispensary, isolation bath, sick bay, and dental office. The commissary space will consist of: Officers' and crews' galley, potato peeler room, bakery and bread room, cold storage, general mess issuing room and butcher shop.

There will be a barber shop and a fully equipped laundry. An aerological laboratory and pigeon coop are being provided; also a photographic laboratory, together with dark room, developing room, and printing apparatus. A hydrogen generator of large capacity, constructed to use salt water for cooling, a number of hydrogen compressors, a large number of hydrogen flasks and an air blower for the kite balloons and two balloon winches will be installed for use in the flying operations and inflation of balloons.

The repair facilities will consist of the following: Wire assembly shop, tool issuing room, blacksmith, foundry, sheet metal and coppersmith shop, carpenter and pattern shop, machine shop and motor erecting shop, electrical work shop, fabric and dope shop. Two balloon winches are being fitted for use in flying operations of balloons.

A large space forward is provided for wing section stowage, and a large hatch in the weather deck for the purpose of getting the wing sections below. Space will also be available for the stowage of spare parts for kite balloons and seaplanes, for boatswain stores, supply department stores, canvas and awnings, lumber, pipe, bar, plate, and metal racks, engineer's stores, electrical stores, chemical stores, officers' stores, etc.

The battery will consist of four 5-inch 51 caliber guns, two forward and two aft, also two machine guns. Ammunition stowage is provided for the regular allowance of ammunition for these guns. The principal dimensions, etc., of the U. S. S. *Wright* are as follows:

Length over all.....	448 ft.
Length between perpendiculars.....	448 ft.
Breadth molded.....	58 ft.
Draft.....	31 ft.
Displacement (normal).....	14,240 tons
Speed (about).....	15 knots

—*Aerial Age*, 20 June, 1921.

FORD MAY ACQUIRE BIG NITRATE PLANT.—Secretary Weeks announced last night that he would ask Congress for authority to accept a proposal by Henry Ford for acquiring the government nitrate plant at Muscle Shoals, Ala., if the offer was found to be "substantial." The proposal, which was transmitted by Secretary Hoover yesterday, was on his desk, Mr. Weeks said, adding that he would begin the study of its terms at once.

Mr. Ford offers to buy the nitrate plant, equipment and lands for \$5,000,000 and lease for 100 years the Wilson and No. 3 dam, when com-

pleted, at an annual obligation of \$1,500,000. He proposes to convert the works into a fertilizer plant, the profits of which would be limited to 8 per cent and to keep it in readiness for the manufacture of explosives by the government in time of war. If acceptance of the offer is found advisable, Mr. Weeks said, he would ask Congress for authority to sell the plant and lease the dams and for an appropriation to complete the electric installation on them. This work is estimated to cost \$28,000,000 and on this sum Mr. Ford proposes to pay interest at the rate of 6 per cent and to amortize the entire cost of both over a period of 100 years.—*The Washington Post*, 15 July, 1921.

**LAUNCHING OF DREADNOUGHT.**—The Navy Department has designated Thursday, September 1, as the date of the launching of the superdreadnought *Washington* at Camden, N. J. The giant vessel will dip the water at 2.15 o'clock in the afternoon.

Miss Jean Summers, 10-year-old daughter of Representative John W. Summers, of Washington, who will christen the battleship with a bottle of water taken from the rivers and lakes of her native state, has been notified of the launching date and she now is arranging her party.—*The Washington Post*, 8 August, 1921.

**A NEW NAVAL PROGRAM.**—Naval conservatism gasped when the *Ostfriesland* went down. And well it might! Minds that had controlled our naval policy and building program, resisting every modern conception, obstinately clinging to five-year-old ideals, were suddenly jarred into a partial realization of their folly. But extreme conservatism always dies hard. Like the doomed paralytic, it may survive several strokes. Obstinacy often grows with inevitable defeat staring it in the face. The bomb of progress and common sense must blow it to smithereens before it will cease to harp upon its one lone ancient chord!

The advent of the *Monitor* in the Civil War wrought a change in naval architecture, nothing more. It simply introduced the turret into the battleship, where it still remains as the one salient element of power in the dreadnought of to-day. But the sinking of a destroyer, a cruiser and a battleship by bombs alone will exert an influence upon warfare afloat and ashore vastly more far reaching in its consequences than the invention of the *Monitor*. It will not only force a change in battleship design, but it introduces a new and dominating force—a veritable navy of the air.

The airplane carrier has suddenly forced itself upon the navy as a capital ship. Its three principal weapons—the bombing plane, the mine-laying plane and the torpedo plane—which are interchangeable, have a range of 100 miles or more, while the guns of a dreadnought or battle-cruiser have a maximum effective range of only 15 miles, and even this cannot be attained without the aid of airplanes to note and report the fall of their shell!

Will conservatives now contend that a 2000-pound bomb or a 21-inch torpedo or a heavy mine will not sink, or at least disable, a dreadnought or battle-cruiser? They must not forget that the British dreadnought *Audacious* was sunk by a mine or a torpedo; that the *Hampshire*, with Kitchener on board, was sunk by a mine; that 62 of the 142 British men-of-war lost in the World War were victims of the submarine; that our cruiser *San Diego* was sunk and our battleship *Minnesota* was disabled by a mine.

Moreover, we must realize that the airplane will soon carry a 4000-pound bomb, and the plane as well as the submarine may easily carry a 30-inch torpedo with a charge of 1500 pounds of T. N. T. Will the battleships and battle-cruisers of the 1916 program survive these charges of high explosives? Remember the *Ostfriesland*!

It is folly to claim that the aviator cannot hit a battleship under way. The airmen declare that it is easier to hit a moving ship than one that

is anchored. They know what they are talking about and they assert that anti-aircraft guns will not deter them. They will use poison gas and smoke screens against the ship's gunners and will choose their own time to attack.

It must be remembered that a ship in battle, with her magazines filled, her boilers and engines, steering gear and fire control in operation, is far more vulnerable and may be more easily sunk or disabled than an armored hulk at anchor. One bomb may wreck her steering gear or fire control and make her useless.

Furthermore, the mine may be laid as a barrage ahead of a fleet. The fleet may be fenced in with mines, and torpedo planes may attack from a safe distance ahead.

The writer has spent his life in contact with and in training young officers and men of the navy. Knowing the mettle and absolute fearlessness of these young men, he believes that if they are told to go and put a 2000- or 4000-pound bomb, mine or torpedo on board or under an enemy ship, they will do it. And it is reasonable to suppose that there are young men in foreign navies who will do the same thing. They will choose their time and they will do it. The fact is that sinking or disabling meat-of-war with bombs, mines or torpedoes is easier than to put them out of action with guns. The \$45,000,000 big-gun ship is too expensive and too vulnerable. It can be sunk by an airplane carrier 100 miles away—80 miles beyond the reach of its guns.

A new naval program may be briefly outlined to meet modern conditions and to prevent waste of hundreds of millions of dollars.

We now have 18 dreadnoughts, counting the *California* and *Maryland* just completed. The *Colorado*, *Washington*, *West Virginia* and *South Dakota* are well advanced and should be completed. This will provide a battleship force of 22 powerful dreadnoughts. This is enough.

The *Indiana*, *Montana*, *North Carolina*, *Iowa* and *Massachusetts* are from 8 per cent to 29 per cent completed. Construction of these ships as battleships should cease and plans should be made to transform them into airplane carriers, armored or otherwise, as may be deemed best. These carriers could remain with the battle fleet to supply its protective and spotting planes while the faster carriers are sent ahead to attack the enemy.

There are six battle-cruisers from 5 per cent to 15 per cent completed. Construction upon these ships as cruisers should cease and they should be transformed into carriers. To be sure, there are many who emphasize the need of battle-cruisers. If these ships were well advanced it might be well to complete them. But they are not. It is submitted that the carrier can perform all the functions of a battle-cruiser.

In this connection it must be borne in mind that the people and Congress simply will not give us the money to complete all the ships of the 1916 program and in addition several hundred millions for carriers. We must make a choice. If we want carriers we must surrender something that we do not need.

It has been proposed to build one or two carriers. This is not enough. It will not secure command of the air. It will leave our fleet helpless—powerless. We need eight carriers. It is only by transforming capital ships that we can get them. It is the only alternative.—*New York Tribune*, 31 July, 1921.

THE U. S. PACIFIC CONCENTRATION.—There is now but little doubt that the policy of the new American Administration is to concentrate the bulk of its naval forces in the Pacific. This, however, may be done gradually and without either a formal announcement or a sudden transfer of whole formations from one coast to another, since either step would undoubtedly lead to much comment, irresponsible and otherwise, and create in Japan an impression which American statesmen are sincerely anxious to avoid.

Nor, irrespective of political consequences, may it be deemed expedient to mass in the Pacific a fleet comprising nearly all the effective units of the U. S. Navy. Most of the dockyard and base facilities necessary to keep a very large fleet in a state of high efficiency and readiness for immediate action have yet to be built. Various projects, conceived on a grand scale, have been mooted for the enlargement of existing bases on the western coast and the creation of additional yards at strategic points, but very little has been done up to now to give effect to these plans. Consequently, if the Atlantic and Pacific Fleets were suddenly merged into one and based at San Francisco, Bremerton, or Hawaii, the dockyard resources of the Pacific Coast would be wholly inadequate to maintain such an armada. Including the private dock (Bethlehem Union) at San Francisco, and the new one at Hawaii, there are only five dreadnought docks available for American ships in the Pacific, and it is doubtful whether more than three of these could take the battle cruisers now under construction.

It is probable, therefore, that the process of concentration will be limited for the time being to the replacement of older vessels by those of the latest type. It will not have escaped attention that the Navy Department is sending every new capital ship to the Pacific as soon as its trials are finished. The *New Mexico* was transferred to that ocean in 1919 as flagship; the *Tennessee* left for the same destination last May, and it is stated that the *California*, completing at Mare Island, will also join Admiral Rodman's flag before the end of the year. Finally, the American service papers say that all four ships of the *Maryland* (16-inch gun) class have been provisionally assigned to the Pacific, as also have four of the battle cruisers. By midsummer, 1924, it is hoped to have on the western coast a fleet of 12 battleships and four battle cruisers, none more than seven years old from the date of launch. But if this scheme is to be realized it will be absolutely essential to develop the Pacific base facilities without delay. American naval officers, who are under no illusions as to the war value of a fleet without proper bases in the approximate fighting zone, are hopeful that Mr. Denby will have more luck than his predecessor in inducing Congress to vote money for the docks, repair plant, and fuel depôts which are so urgently needed.—*The Naval and Military Record*, 6 July, 1921.

PREPAREDNESS FOR WAR.—In an effort to get some definite idea as to what the leading nations are doing regarding armaments of the future, the *New York Herald* instructed its correspondents at Washington, London, Paris and Berlin to make inquiries and report. Here are some of the facts they ascertained:

The United States is proceeding with unabated zeal to develop her equipment to the last word as a guarantee of her future security from aggression or invasion. There has been no attempt on the part of the officials entrusted with this preparedness program to attempt concealment, so that the country knows just what is going on all the time. The greatest stress, however, is in the development of big guns, poison gas and tanks, with an idea of ultimate motorization of all transportation. Among the available accomplishments, the United States has:

1. Radio control of submarine torpedoes.
2. Aerial torpedo for use in naval warfare.
3. Superguns for land and naval warfare.
4. Diphenylchlorasine, a sneezing gas. Also clothing protected against gas.
5. Airplane carriers to go with battle fleets.
6. Three-seater triplanes with eight machine guns and 37-mm. guns for ground attacks.
7. Tractors with automobile wheels for good roads and caterpillar treads for cross-country travel.
8. New tank (details not yet revealed).

In addition to the above, the United States has projected:

1. Railway guns and tracks to protect every mile of coast line.
2. Liquid poison, three drops of which will kill a person on contact.
3. 3000-pound air bombs.
4. Illuminating projectiles for lighting up water areas to disclose submarines.

To carry out this program the Aberdeen Proving Grounds are considered the best in the world. The Chemical Warfare Service is carrying on its developments at Edgewood, not far from Baltimore, Md. The report of the Secretary of the Navy shows that the United States will surpass all others as a sea power with the completion of the present naval program, many ships being almost ready for delivery.

Great Britain is more secretive about her armament programs for the future, but it is a known fact that England is better armed to-day than at the time of the Armistice. When the Armistice was signed the British had planes ready to bomb Berlin, gases that could be projected a half-mile, irrespective of the wind and 2000 absolutely new tanks waiting to be let loose on the enemy to make him cry for mercy.

Some of the new weapons which Great Britain has added to her armament are:

1. Superairplanes of the V-Handley-Page type with a 3000-mile cruising radius, and carrying 1800-pound bombs.
2. One-man tanks and supertanks superior to those actually used in the war.
3. More deadly gases.
4. Means of exploding ammunition dumps by electricity from protected points in rear.
5. Sunken concrete towers to support submarine nets.
6. Floating magnets to divert enemy submarines from their course.

In addition to these, England has proposed:

1. A noiseless machine gun.
2. Electrocutation of enemy troops.
3. Submarine torpedo to carry a ton of T. N. T.
4. "Flying man-o-war." A superseaplane of 30,000 horsepower.
5. Flying destroyer with steel wings.
6. Bomb-proof roofs for docks and piers.
7. Use of the deadly powers of the X-ray.

France, too, in spite of the great losses she suffered in the war, has not been slow in developing her equipment for the next war. The armistice found France in a better position to carry on the war than at any time in the previous five years. With this as a nucleus, she intends to keep the vigil so that she will never again be surprised by her secular enemy, Germany. France now has in the way of new equipment:

1. Turbo-cannon giving longer ranges than the Big Bertha.
2. Submarine tanks capable of traveling submerged, crossing rivers, etc.
3. All-metal airplanes surpassing any hitherto used in warfare.

France also proposes to develop:

1. Huge rockets filled with explosives and oil to set fire to airplanes.
2. Shells propelled by a series of explosions to keep them in flight and which will give them a range of over 100 miles.
3. Gigantic aerial bombs and planes for the purpose of destroying whole cities.

Even Germany which is supposed to be disarming in accordance with the terms of the treaty of Versailles, is awake to the issues of the day and proposes a huge armored submarine which will withstand depth charges and the fire of the smaller craft. Had this been perfected in time, it would no doubt have had considerable bearing on the trend of the war.

Another German idea was the crewless ship, steered by wireless and designed to attack the Grand Fleet. However, with the exception of the Big Bertha, the German war inventions were of a less startling nature than those suggested and perfected by her adversaries. Nevertheless,

credit should be given the German chemists for their ingenuity in supplying the elements necessary in carrying on the war. From the air they extracted nitrogen, from glycerine coal tar, while other substitutes too numerous to mention were derived from the various sources.—*National Service*, August-September.

GOVERNMENT FLEECE UNDER PRESENT CHARTERING SYSTEM.—In an address to representatives of the press on Monday last, Chairman Lasker of the Shipping Board scored the present method of allocating government ships as follows:

“The boats are being operated to-day in the following shocking manner: An operating company is allocated a number of boats. They are allowed a commission of five per cent flat on gross revenue. The boat can lose all kinds of money—the taxpayers pay the losses, but the operator makes money just the same, because he gets his five per cent commission.

“If the operator carried not a single ton of cargo he lost no money, for the government paid for the operation of the ship from one end of the world to the other. The result hardly needs telling, but here are typical instances given:

“A steamship which was half-way across the Pacific turned back to the west coast for a cargo which would net the operator \$4500. The cost to the government for the detour was \$8000. Another line which had its own vessels in addition to government ships carried cargo in the Shipping Board vessels eastbound across the Atlantic, but filled the holds of its own vessels westbound where the cargoes were hard to obtain. A single ship of that line made five round trips and in all that time brought only 40 tons of cargo to the United States.

“It is nobody's fault that the present system prevails. Those boats were built when American operators had no experience and a system had to be developed to get them moving, and as long as times were good the system did not work out so badly, but anybody can see that a system whereby the operator has nothing at stake and the government loses and he wins is a system that makes for inefficiency.

“We must grin and bear that system for some months to come, because to establish such a charter system as will be developed by our new Vice-Presidents of the present Board is a matter almost as difficult, in a minor way, as it would be to negotiate the Peace Treaty of Versailles. It is a highly technical matter and must be approached with the greatest care. Out of 9000 voyages made since the present system took effect, only 3000 have been accounted for.”—*The Nautical Gazette*, 6 August, 1921.

JAPANESE SHIPPING PASSING THROUGH THE PANAMA CANAL—During the fiscal year ending June 30, 1921, 136 Japanese vessels passed through the Panama Canal carrying 767,608 tons of cargo. Their aggregate net tonnage under the Panama Canal rules was 613,245. One Japanese vessel passed through the Canal four times during the year, 11 three times, 25 twice, and 49 once only.

The following table shows the number of vessels under the Japanese flag which have passed through the Canal in either direction during each of the last seven fiscal years, or since the Canal was first opened to traffic on August 15, 1914:

Year	Atlantic to Pacific	Pacific to Atlantic	Total
1915	4	2	6
1916	19	5	24
1917	54	18	72
1918	33	20	53
1919	47	40	87
1920	84	34	118
1921	86	50	136
Total	327	169	496



It is remarkable that in each of the years covered by the table more Japanese vessels passed through the Canal from Atlantic to Pacific than in the opposite direction. For the entire seven-year period the proportion is nearly 2 to 1. A similar preponderance of vessels in one direction has been noted in studying other features of Canal traffic. It is apparently due to the fact that cargo steamers in the trade with the Orient commonly find it more profitable to move from port to port around the world, going out via Suez and returning via Panama, or vice versa, than to turn back over the same route followed in the outward voyage.

The principal Japanese steamship companies that passed vessels through the Canal in 1921 were: Osaka Shosen Kabushiki Kaisha with 38 vessels; Nippon Yusen Kabushiki Kaisha with 26 vessels; Kokusai Kisen Kabushiki Kaisha with 25 vessels; Toyo Kisen Kabushiki Kaisha with 10 vessels; and Mitsui Bussan Kaisha with seven vessels. The remaining 30 vessels in the list of 136 were distributed among 13 other owners.—*The Nautical Gazette*, 6 August, 1921.

WORLD'S MERCHANT TONNAGE AT CLOSE OF FISCAL YEAR.—Lloyd's Register for 1920-21 has just made its appearance and contains as usual full particulars of all sea-going vessels of the world in 100 tons and upward. The following table shows the number and gross tonnage of the vessels belonging to each of the principal maritime nations in June last:

Flag	No. of ships	Tonnage
United Kingdom .....	9,034	19,571,554
Australia and New Zealand.....	615	693,937
Canada .....	961	1,134,111
India and Ceylon .....	190	197,360
Other Dominions .....	633	473,827
United States .....	5,551	17,026,002
Argentine .....	209	167,154
Belgian .....	256	551,031
Brazilian .....	402	499,325
Chilian .....	124	113,447
Chinese .....	122	163,037
Cuban .....	50	58,553
Danish .....	708	964,464
Dutch .....	1,069	2,225,787
Esthonian .....	90	41,183
Finnish .....	330	198,352
French .....	2,044	3,652,249
German .....	1,255	717,450
Greek .....	362	599,929
Italian .....	1,271	2,650,573
Japanese .....	2,033	3,354,806
Latvian .....	90	53,342
Norwegian .....	1,880	2,584,058
Peruvian .....	68	87,167
Portuguese .....	284	206,847
Rumanian .....	37	73,973
Russian .....	465	412,459
Spanish .....	828	1,165,541
Swedish .....	1,353	1,160,211
Uruguayan .....	54	85,886
Other Countries .....	304	218,765
Flag Not Recorded .....	417	782,264
<b>Total .....</b>	<b>33,206</b>	<b>61,974,653</b>

The sea-going steel and iron steam tonnage owned by the principal maritime countries is shown below (000 omitted) :

Country	Tons gross		
	1914	1921	Difference
United Kingdom .....	18,877	19,288	+411
British Dominions .....	1,407	1,950	+543
United States .....	1,837	12,314	+10,477
Austria-Hungary .....	1,052	Nil.	—
Denmark .....	768	866	+98
France .....	1,918	3,046	+1,128
Germany .....	5,098	654	-4,444
Greece .....	820	576	-244
Holland .....	1,471	2,207	+736
Italy .....	1,428	2,378	+950
Japan .....	1,642	3,063	+1,421
Norway .....	1,923	2,285	+362
Spain .....	883	1,094	+211
Sweden .....	992	1,037	+45
Total abroad .....	23,637	34,929	+11,292
World total .....	42,514	54,217	+11,703

The following comparison between the two years as regards the division of motive power is of interest :

	1914 Percentage total gross tonnage	1921 Percentage total gross tonnage
Sail Power only .....	7.95	5.05
Oil, etc., in internal combustion engines.	0.47	2.0
Oil fuel for boilers .....	2.62	20.65
Coal .....	88.96	72.30
	100.00	100.00

In 1914 there were 3668 sea-going steamers of 4000 tons and above each; there are now 5209.—*The Nautical Gazette*, 6 August, 1921.

### AERONAUTICS

**THE NEW MENACE TO SEA POWER.**—A few months ago, it is recalled, Josephus Daniels, then Secretary of the Navy, volunteered to permit General Mitchell, of the Air Service, to drop all the bombs he pleased on a vessel which the Secretary himself would steer. But since four types of German war-vessels—submarine, destroyer, cruiser, and dreadnought—were sunk by airplanes flying at an altitude of from 1200 to 4000 feet in the past few weeks, declares the *Newark News*, "we shall have to take off our hats to General Mitchell and his officers; the Air Service has made good." "The high priests of capital ships *über alles* have found that even a dreadnought can be sunk from the air," notes the *Norfolk Virginian-Pilot*, whose editor had the advantage of being at the scene of the tests. "No guns in existence could have sunk the *Ostfriesland* short of many hours' firing, and no guns could have scored the hits which the airmen scored with their bombs," asserts the *New York Evening Mail's* correspondent at "the front," Clinton W. Gilbert; "here was a ship which required years to build, and cost \$40,000,000, yet it was sent to the bottom of the sea by six bombs carried by machines costing less than \$25,000 apiece."

"But battleships are not made obsolete by the recent bombing tests off the Virginia Capes," contends the *Washington Post*. The battleship, however, is no longer the "backbone of the navy," or the nation's first line of defense, thinks Raymond G. Carroll, writing in the *Philadelphia Public Ledger*, and Arthur Brisbane unequivocally asserts, in the *New York American*, that "to build \$40,000,000 battleships is a stupid waste of money, done only to please shipbuilders." "Officers of the navy hate to see the battleship go, and struggle to retain it," he goes on, "but you must also remember that drivers of hansom cabs disliked to climb down from their high perch when the taxicab came in."

Other editors take a middle ground in discussing the tests. "The only good navy is a three-plane navy, strong in airplanes, ships, and submarines," is the conclusion reached by the *New York Globe* and a dozen other papers, while still others urge Congress to add a couple of aircraft-carriers to the navy or convert some of our cruisers for that purpose. Japan and England, they point out, have not been backward about building such ships. But the chief value of the tests is the knowledge that airplanes can sink capital ships, and that the navy will not be safe until it possesses ample protection against such attack, believes the *Philadelphia Bulletin*.

"The question as to what was proved by the demonstration will be discussed by the military and naval experts of the world for some time to come," notes the *Brooklyn Eagle*, "but one theory—the theory that the battleship is impregnable—has been knocked sky-high, or, rather, sunk without trace."

The first victim of recent tests off the Virginia Capes was the *U-117*, a former German submarine. Twelve bombs weighing 163 pounds each were dropped by navy seaplanes, with the result that the vessel sank within 15 minutes. The next experiment was with the old *Iowa*, upon which 80 dummy bombs of cement were dropped. These were dropped by navy and marine-corps fliers, and as the former battleship was controlled by radio and sent on a zigzagging course, and as the dummy bombs were not equipped with wind-vanes and therefore turned over and over, few direct hits were made, although at least half of the bombs fell within the danger zone. The airmen proved, however, that they could locate an incoming "enemy" battleship. A former German destroyer, the *G-102*, was next attacked by army airmen, who first dropped fragmentation bombs upon her deck to "clear them and put the anti-aircraft guns out of commission"—50 per cent of which registered direct hits—then sank the destroyer within 20 minutes with bombs weighing 300 pounds each. The former German cruiser *Frankfurt*, however, was not so easily vanquished. Fifty-seven 250- and 300-pound bombs made little or no impression on this armored vessel, so a division of army Martin bombers, carrying twenty-one 520- and 600-pound bombs, were ordered to attack. They found it necessary to use only 11 of the bombs, however, and in ten minutes the *Frankfurt* was beneath the waves. Throughout the tests many bombs failed to explode; they were "duds."

It was the *Ostfriesland* type that "could not be sunk," said naval officers. And great was their jubilation, say the correspondents, when 52 bombs, weighing from 230 to 600 pounds, 13 of which made direct hits, were dropped on the vessel with a resulting damage only to her superstructure. The next day five Martin bombers dropped five 1000-pound bombs on the former German dreadnought, making three direct hits, but the "pride of the German Navy," as she was called after the battle of Jutland, refused to go down. Six more Martin bombers then dropped a 2000-pound bomb apiece upon the helpless *Ostfriesland*, or, rather, so near her that the concussion, in the opinion of General Mitchell, would open her armor-plates, which were ten inches thick at the water-line. Four of these bombs, in the opinion of one correspondent, "answered quickly and dramatically the question as to whether an airplane could sink a battleship; the dreadnought sank in 25 minutes."

"The question really at issue," declares the *Omaha Bee* after the evidence is all in, "is whether money is being wasted in building \$40,000,000 battleships." The *Washington Herald*, the *Philadelphia Inquirer*, the *New York Globe*, the *Norfolk Virginian-Pilot*, the *Philadelphia Public Ledger*, the *Indianapolis News*, the *New York Tribune*, the *Dallas News*, the *Kansas City Star*, the *New York Herald*, the *Richmond News Leader*, and several others believe that the money of the people is being wasted. "It has already been proved that the bombing airplane has the eyes to spy out the enemy, the wings to overtake him, and the weapons with which to wipe him out," notes the *New York World*. We should, therefore, provide the navy with more airplanes and at least two airplane-carriers, maintain the *Newark Evening News* and the *Washington Post*. "These vessels will be costly, but they will carry in their holds and upon their landing-deck the fate of both the aerial and naval forces, and thus they are indispensable," maintains the latter paper. As for planes, "a thousand can be built for the cost of one dreadnought, and they are four times as speedy as a battle-ship," points out the *Passaic (N. J.) Herald*.

"But what then?" asks the *Boston Herald*; "we have not ascertained what would happen in a real battle." Furthermore, says this paper, "the vessels destroyed in the tests were at anchor and undefended." "There are also clouds and smoke-screens to interfere with bombing airplanes," notes the *Pittsburg Ledger-Dispatch*. Others class the airplane with the torpedo and the submarine, which were heralded as the destroyer of the battleship. But means were taken to offset their attacks, and the navy will invent a method of nullifying bombing attacks, other editors believe. "Whatever form of destructive engine is developed, some form of protection will be evolved against it," thinks the *Chicago Tribune*. "There is nothing magical or omnipotent about the airplane," argues the *Adrian Telegram*; "it is simply one more new weapon. If opposing nations did nothing new, any nation armed with a new weapon could conquer the world. If airplanes can destroy warships, it simply means that every warship will have to have a bodyguard of airplanes." "Only aviation enthusiasts," announce that the day of the capital ship is over, concludes the *Baltimore News*.—*The Literary Digest*, 6 August, 1921.

• DEPTH BOMBING FROM THE AIR.—The United States Navy is to be congratulated upon the success which attended the recent elaborate air-bombing tests, extending over a period of several weeks, in the course of which several submarines and destroyers, a modern scout cruiser, and a 22,000-ton dreadnought were sent to the bottom. These ships were allocated to the United States as our share of that portion of the surrendered German fleet which was not sunk at Scapa Flow or was salvaged subsequently to that sinking. These ships were allocated with the understanding that they were to be completely destroyed before the close of August, 1921. The navy decided that they would destroy them under conditions which would stimulate, to some extent, the conditions of actual warfare. The plan of operations contemplated first, an attempt to destroy the ships by bombing from the air, and secondly, should the bombing fail to put them down, an attack by gun-fire. Should both of these efforts fail in the case of any ship, a wrecking crew was to be sent aboard and the vessel was to be sunk by high explosives placed within her hull. Many months ago, when these plans were formulated and before the discussion as to the relative value of bombing planes and battleships had grown to its present dimensions, the Navy Department, in a fine spirit of co-operation with the army, requested the Army Air Forces to join them in these bombing attacks. We wish to take this opportunity to contradict the popular impression, which unfortunately the daily press has done so much to develop, that there was any spirit or rivalry or fierce competition between the two

forces. As a matter of fact, the army greatly appreciated the opportunity thus presented, and the co-operation between the two was marked by good sportsmanship and perfect military co-ordination.

If we wish to get a true perspective of these experiments, we must bear in mind and it should be emphasized at the very outset, that the conditions under which the bombing was carried out were purposely made as favorable as possible for the attack. It should be understood that never again, except in the event of extreme carelessness and neglect, will any airplane force be able to fly, at its own chosen height and in its own chosen weather, across a fleet of anchored ships which has no defense whatever against the enemy. If you were to ask any of the bombers of the attacking air force he would bear out the above statement and tell you that from his point of view he had every possible condition in his favor.

To particularize, we may mention, first, that the most successful approach to the target is one that is made with the target dead to windward, and in every case during the three days that we were witnesses of the bombing, the attack was made up the wind. In an actual engagement such freedom of choice would not be possible.

Secondly, each flight of planes was permitted to pass over the target and withhold its bombs, if the captain did not consider that the position was ideal for releasing the bombs; in fact, a flight would sometimes pass two or three times across the target before it had made the necessary corrections and considered itself in the best possible position. This, of course, would be impossible in actual battle, where the opposing enemy craft would be in the air and a barrage of anti-aircraft shrapnel would be built up against the attack.

Thirdly, the attacks were made only in favorable weather. Low-lying clouds, a heavy haze and the approach of twilight were sufficient to call off the operations. In wartime, of course, the attacking force would have to take its chances of adverse wind and weather and poor visibility.

Fourthly, the targets were anchored—a point of immense advantage to the bomber, when using his sights from the plane above. In an actual fight battleships would be moving from 17 to 25 knots an hour, cruisers from 25 to 35 knots, and the quick helm, which characterizes all modern warships, would enable a ship to make a change of course as soon as she saw the bombs let loose by the enemy. Zigzagging may well prove to be one of the most effective defenses against aircraft bombs, particularly against those which are launched from high altitudes.

Lastly, there were no opposing craft in the air. The fast fighting scout is master of the heavy bombing machine and, unless the latter is protected by her own scouts, she will be sent down before reaching the target.

Having cleared the air by the above statement of the favorable conditions under which the attacks were made, we hasten to state that the work done against the *Frankfurt* and *Ostfriesland* was excellent. The army and navy bombers are to be congratulated. Due largely to the fact that they were working off an old stock of English bombs, a large percentage of the navy shots proved to be "duds," and consequently their work did not make such a dramatic showing as that of their confrères of the army. We remember one navy flight which let fall half a dozen bombs that formed a beautiful pattern around and on the *Frankfurt*; but not one of these bombs detonated. Without having the exact figures at hand, we think it is safe to say that fully 50 per cent of the bombs either made direct hits upon the target or dropped sufficiently near to have a damaging effect upon the submerged hull of the ships. When we remember that air bombing is, even to-day, a comparatively new art, and that the sighting instruments are considered to be in the experimental stage, we feel justified in predicting that before many years have passed, bombing from the air, even at much greater altitudes than

the 1500 to 1700 feet employed in the recent tests, will take on something of the accuracy of gun-fire. It should be remembered, furthermore, that about the last man to play safe in warfare is your air pilot. After seeing a single 2000-pound bomb crushing in the underbody of a battleship as though it were an eggshell, it is certain that under the stimulus of a great battle, upon which the fate of a nation depends, there will be found many an airman who will not hesitate to dive down at 200 miles an hour, until he is within point-blank range, and place his bomb in just the right position alongside the enemy to sink him, and sink him quickly.

During the tests of July 18th against the *Frankfurt*, which we witnessed from aboard the battleship *North Dakota*, at a distance of 1800 yards from the target, it was clearly demonstrated that however much destruction bombs of 250 to 600 pounds' weight might work if they made direct hits upon the ship, they would not suffice to sink her. It was easy to determine a direct hit from one alongside the ship. In the former case there would be an enormous burst of dark-brown smoke, centered in which would be a huge splotch of red flame 50 feet in diameter in the case of the larger bombs, which would be followed a few seconds later by the snappy, snarling report which is characteristic of high explosives. Sometimes, at the burst, the surrounding water would be flecked with the splash of fragments of shell and the shattered woodwork of the ship's decks. More often, when the smoke had cleared away, it would be impossible to detect any material damage, even through the most powerful glasses. The most dramatic hit and the one with immediately visible results was made by a 600-pound bomb which passed through the super-structure deck of the *Frankfurt*, amidship, and by the force of its explosion lifted the deck and bent it over the side of the ship. As we looked at this through the glass, our thoughts went back immediately to the sinking of the *Maine* and to the remarkable way in which the foredeck was lifted up and curled back upon the super-structure in the great explosion at Havana. The bombs failed to penetrate the protective deck of the *Frankfurt*, and apparently did no great harm to the shell plating of the ship above water. They failed to start any serious leaks during the first several hours of bombing, and this in spite of the fact that the later bombs dropped were of 600-pound weight. So well did the cruiser stand up under this attack that it began to seem doubtful whether she would be sent down before the day was over. The fatal blow was delivered on the starboard bow and not far from the ship's hull. The detonation was heavy, the hammer blow of it being felt through the water by our ship which at the time was over 2000 yards distant. There was a big upheaval of water which fell mainly across the ship, and when it had rained off, it was seen that the bow was steadily settling and the stern rising above its normal flotation mark. Twenty minutes after the fatal bomb had crushed in the side of the *Frankfurt*, she disappeared.

The program of the attack upon the dreadnought *Ostfriesland* called for bombing first with 300-pound and then with 600-pound bombs. If these failed to sink the ship, she was to be bombed with 1000-pound bombs. If she were still afloat, an attack with a specified number of 2000-pound bombs was to be made. If she survived these, the *Pennsylvania*, flagship of the Atlantic fleet, was to try to put her under with salvos of 14-inch shells at a distance of not less than 18,000 yards or nine nautical miles. If the resistance of the ship was equal even to this final test, a squad from the *North Dakota* was to go aboard, place large charges of T. N. T. on her bottom and sink her. The confidence in the modern system of anti-torpedo and anti-mine internal construction was such that there were a large number of officers and men of the fleet who believed that, battered as she might be in her upper works the *Ostfriesland* would succumb only to the well-placed salvos of the *Pennsylvania*.

To get the full significance of the sudden destruction of the *Ostfriesland*, it should be clearly understood that in respect to internal subdivision she was a well-protected ship, completed in 1911. Since the surrender to the German fleet, expert officers of the British and our own navies have made a thorough examination of German battleship construction, and it is agreed that in underwater subdivision as a protection against mine and torpedo, the Germans were somewhat ahead of contemporary ships. The *Ostfriesland* is by no means out of date, as may be judged from the fact that she was a contemporary with the latest of the British 12-gun and the earliest of the British 13.5-gun dreadnoughts, and also with our own dreadnoughts *Utah*, *Florida*, *Arkansas* and *Wyoming*. Within her outer shell she had longitudinal bulkheads, including one armored bulkhead of a tough, ductile steel, designed to bend without breaking under the impact of high explosives. Such at least was the design, and as far as we know she was built accordingly. At any rate, the *Ostfriesland* has it to her credit that in the flight back to Germany after the battle of Jutland, she struck a mine and nevertheless reached port under her own power. A sister ship is credited with having received during the same battle the blow of four 15-inch British shells, in addition to being twice torpedoed. This vessel also reached port. An important feature in her construction, which is of great importance in considering the quick sinking of the vessel, is that her bulkheads were not pierced by watertight doors; in other words, communication from compartment to compartment was "up and over." It is the consideration of these facts which leads us to believe that the 2000-pound bomb which was detonated a few feet from her port quarter must have opened up a section of the underbody of the ship far greater than would have been blown in by the detonation of a torpedo or a mine.

The bombing of the *Ostfriesland* was set for Wednesday and Thursday, the 20th and 21st of July. Due to unfavorable weather conditions, the first attack did not start until noon. It was carried out with 600-pound bombs which were well placed, some of them aboard and some not far from the ship. After two direct hits, the destroyer *Harding*, from which we observed the test, steamed in alongside the *Ostfriesland*, and even from the distance of 100 yards, it was impossible to note any external effects from these explosions. They had penetrated the upper decks and burst above the protective deck—which, of course, they failed to affect. On reaching the scene of operations on the morning of the 21st, it was noticed that the *Ostfriesland* was about two feet down at the stern, and it was evident that a slow leak had been developed by the bombing of the previous afternoon. During the early morning of the 21st, attacks were made by five army Martin bombers, which dropped 1000-pound bombs. These failed to make any appreciable difference in the submersion of the ship. It had been intended to try the penetrative effect of 14-inch naval shells dropped from naval bombers, but, due to a change of program, five Martin bombers and a Handley-Page machine came out from Langley Field carrying 2000-pound bombs. Orders had been given to endeavor to place these outside of the ship and as near to her hull as possible. The work of destruction is believed to have been done by two of these half-dozen bombs—namely the fourth and fifth. One of these landed close in on the port side of the vessel, not far aft of amidships, and the second close in on the port side of the stern.

The destroyer *Harding* was about two miles distant from the stern and directly in line with the longitudinal axis of the ship. The delayed-action fuse of the second bomb must have worked admirably and have burst the bomb well down below the surface; for it lifted and dropped upon the ship an enormous quantity of water, which, from our point of observation, completely hid the vessel from sight. As the finer mist disappeared we noticed that a perfect Niagara of solid water was pouring

down from the bridge, the conning-tower, the after turret and the quarter-deck. When this had fallen clear, there appeared all around the water-line at the stern of the vessel and well up toward amidships, a white line of foam boiling around the vessel, broken occasionally on both sides of the stern by bursts of foaming water.

There was but one interpretation of this phenomenon. It meant that not only the port side, but also much of the bottom of the ship must have been broken in and that this disturbance was caused by the escape of vast volumes of air from the wrecked underbody as the water rushed in. Immediately, the great ship began to list to port, turning steadily over as the afterbody of the ship submerged. When the bow of the vessel struck the bottom some 300 or 350 feet below the sinking was arrested, and the ship seemed to hang for a few moments before the stern took the final plunge and disappeared. Just after she had gone down, the Handley-Page bomber flew over the circular patch of still foaming water, and dropped the last of the 2000-pound bombs, thus sounding taps over this marine burial.

It is not to be wondered at if, to the lay mind, this majestic spectacle should have had but one immediate meaning, and express itself in the all-too-common phrase: "That seals the doom of big battleship construction." As a matter of fact, it means nothing of the kind. Naval and military men knew perfectly well that 1000 pounds of T. N. T. detonated near the side of such a ship as the *Ostfriesland* would be pretty certain to send her down. Whether it would have done the same to the flagship *Pennsylvania*, which floated not far away, is a mooted question. Subdivision has made wonderful strides in the last ten years. That bomb might possibly have sunk the *Pennsylvania*. It is certain that it would have put her out of action for the time being.—*The Scientific American*, 6 August, 1921.

**BATTLESHIPS WILL SOON BE THINGS OF THE PAST.**—The President ordered the recent experimental attacks by flying machines on battleships. He has given time and work to the important fact that war in the future is to be settled in the air. His orders have caused the making of huge 6000-pound aerial bombs and other experiments in air fighting. This is the only fighting, except submarine fighting, that will play any important part in future wars.

This country created the flying machine and this country can be made invulnerable, safe from all attack, by the flying machine. The President will see to it, for his mind accepts new ideas.

In 50 years there has been no news as important to this country as that describing the destruction on Thursday of the German fully armored dreadnought *Ostfriesland*. The great battleship was sent to the bottom in 25 minutes by two bombs. They did not touch her, simply fell in the water near her and destroyed her by the impact of the water itself forced against steel armor with sufficient force to open the seams and sink the boat.

The *New York Times*, reporting the destruction by two inexpensive bombs of a ship that cost millions, quoted General Williams:

"The bombs that sank her will be heard around the world."

The *Times* asks: "Is the battleship obsolete?"

It is *indeed* obsolete, as has been said in this column many times during the past two years.

To build \$40,000,000 battleships is a stupid waste of money, done only to please shipbuilders that want money. The entire engineer and mechanical intelligence of this country should be devoted to flying machine construction.

The President is to be especially congratulated upon the fact that army and navy arsenals under his control are manufacturing bombs three times as great as the 2000-pound bombs that sank the German dreadnought. These bombs carry each 4000 pounds of T. N. T.



This country should have as quickly as possible 4000 first-class flying machines to carry the mails in time of peace and drop bombs upon the enemy in case of war. Five thousand flying machines would make any attack by a foreign fleet preposterous. The 5000 machines *honestly* built, without aid from grafting \$1-a-year patriots, would cost less than *one* \$40,000,000 battleship and could destroy a thousand such ships, if possible to build so many.

The battleship has gone by, a joke. The President *knows* it. Under his direction the postmaster general, Mr. Hays, can and will produce and use flying machines that will take care of national protection with a good fleet of submarines to back them up.—*Seattle Weekly News*, 29 July, 1921.

**AIRPLANE BOMBING OF IDLE SHIPS.**—Those army and navy aviators are not making even half a test in their bombing of the old German warships. When their experiments have been completed and the sum total of the things done is made public, we shall really know little more about the actual practicality of that form of wartime attack than before the "demonstrations" began.

For, be it noted, the "enemy" is not taking any part in these "attacks." The aircraft find it an easy matter to sail about over the undefended vessel of the sea and drop bombs in its direction. There is no real practice in avoiding the foeman's anti-aircraft fire, yet this would be the vital phase of any undertaking to sink a battleship from the air in time of actual combat. Everything is in favor of the aerial "attacks" in the present experiments, yet not more than 25 per cent of the bombs dropped have proved effective. How much smaller would be the percentage of hits in the event of the assaulting party being met by fire from the battleships—easily better directed and therefore more dangerous to meet?

In a conflict between sea and air forces, the advantage will always be with the former. It presents a better target to the attacking party than does aerial craft, to be sure, but at the same time it can far more skillfully fight back. The airplane must be always moving at high speed, and over an ever-changing course, in the effort to avoid the guns from the water. Thus the airman's own accuracy of aim is weakened. The more successful he is in escaping shots from below, the less will be his own chance of scoring against that enemy. The latter, having a far greater deck surface on which to operate, can concentrate many guns upon the enemy in the air.

None of these actual phases of real warfare have had to be encountered in the tests off the Virginia Capes save in merest theory. The attacks have been made under the most favorable circumstances possible. It is not much of a hazard to say that, under necessity of protecting themselves from ever-present danger of destruction from below, the airmen would have been able to accomplish a little against the battleships of the sea. The "eyes of the navy" are not yet particularly vampirish.—*The St. Louis Times*.

**THE BOMBING TESTS.**—The navy tests which were held off the Atlantic capes terminated July 21 with the bombing and sinking of the ex-German battleship, *Ostfriesland*. There was considerable good-natured rivalry between the man-o'-war's men and the air service respecting the merits of battleships and aircraft, out of which grew the popular belief that the tests would determine whether or no the battleship must yield to the airship as a warfare weapon and the former, in the near future, be consigned to obsolescence.

But whatever the views of the rival factions, the fact remains that both sides are now pretty well agreed that we cannot yet dispense with battleships and that the airship has proved itself to be a valuable auxiliary in the defense of our coasts.

Secretary of War Weeks, remarking on the ideal conditions which prevailed, and the fact that the ships were moored, declared: "This all means that the value of the aeroplane as an offensive weapon was not absolutely proved. The delayed explosion seemed to be the most effective and the development apparently will be in the perfection of bombs that work on the depth charge principle and are able to pierce warships below their heaviest armor line." General Menoher, chief of the army air service, said: "I have always contended that the bomb did constitute a very grave menace to the capital ship and that extraordinary precautions had to be taken to meet the menace." Secretary Denby stated that "scientific conclusions of the utmost value undoubtedly will result from the series of tests," and Assistant Secretary Roosevelt summed it up saying: "The aeroplane has proved its value as an auxiliary of the navy. They will be extremely useful in the future for information work and in harassing the enemy. I do not believe that they spell the doom of the capital ship. That has been predicted three times in my lifetime. The torpedo, the submarine and the aeroplane all have been hailed as weapons to make dreadnoughts useless. What I think will happen will be steps by the navy to meet the new form of attack. Aviation will have to be developed in conjunction with the fleet."

It seems that the best form of aeroplane attack on battleships would be a combination of direct hits which would demoralize the personnel of the ship, together with shots laid close to the hull for the purpose of sinking. In the case of the *Ostfriesland* a heavily armored vessel, these outside shots seemed to be the most effective. Of course, it is to be borne in mind that in all these tests the targets were stationary, and the effect of anti-aircraft gunfire could not be determined. Atmospheric conditions were perfect.

That aeroplanes can terribly harass an approaching enemy fleet was demonstrated to the entire satisfaction of every witness of the tests, and this in itself supplies a powerful plea for perfection of the air service. In addition, it is made apparent that the government should encourage in every way in its power the development of the aeroplane industry in order that America, where the plane was invented, may take its place in the lead, instead of trailing France, Great Britain and Germany as at present.—*The Marion Star*.

"THE NAVY THAT FLIES."—An airplane can sink a battleship. Three 2000-pound bombs sank the *Ostfriesland* in 25 minutes. Two of these bombs striking alongside ripped her steel seams and she opened up and sank like a wet paper box.

She cost \$30,000,000, or would cost that to-day. The planes that sunk her would cost \$20,000. The Republic of Andorra could afford a war plane that could destroy the battleship *Pennsylvania* or a super-Hood!

The tests off Norfolk have one sure result—there will be intense activity on the part of every principal power in designing and building fleets of "bombers." Here is a means of defense within reach of the most pauperized political group calling itself a country.

The important question is, What will we do about it? We were the inventors of the submarine and the airplane. Holland's submarine was developed abroad. The airplane saw its greatest development outside of America.

Granting that the nations fail to disarm or that disarmament is partial only, will we, if attacked in the future, as in the last war, spend and waste hundreds of millions on abortive aerial programs conceived in ignorance and executed in haste?

There is danger that we will conceive the idea that by a sort of a winged T. N. T. miracle off the Virginia Capes we are from this day on immune

from foreign attack. Our first mistake is that the battleship has become obsolete over night. Our second is that, if a hostile fleet approaches, all that will be needed is to send up a few planes laden with bombs and about 100 miles off the coast blow the said foreign fleet into steel shreds.

Which is hardly the way it would work out! In the first place, the battleship is likely to undergo certain revolutionary changes and perfect itself in means of defense. Also, such hostile fleets would approach carrying a fleet of "wasp planes" on its deck. It would not take many of these to be superior to our entire present plane equipment. Small single-seater fighting machines these are; a dozen of them can ride on an ordinary battleship, and an airplane carrier will "mother" a hundred of them. The big, lumbering, well-nigh defenseless bombers will be brought down with the same ease and dispatch that they were on the West Front.

No, the problem of defense is not solved. The idea is born. The job now is to get on with it. Our problem is a defense problem and the tests off the Norfolk base have given us our clue. On a purely defensive problem we have an enormous advantage if we will build ourselves an adequate flotilla of bombers and protect them with fast and agile combat planes.

We have been building battleships for defense, since they and the submarine were the only tried methods of keeping possible hostile fleets from our shores. The tests off the Virginia Capes have established the airplane as a new, if not the most dominant, factor in the equation. Certainly as a defensive weapon they must be given strong consideration.

With the battleship proven vulnerable, the obvious thing to do is lessen the pressure on big ship building and use that pressure on developing aircraft. Three modern battleships cost \$120,000,000. With \$100,000,000 of this amount we can begin to get somewhere with an adequate airplane coast defense. Battleships, in building, should be so modified that they can carry a complement of air fighters.

We shall need to spend this money with craft and cunning. We don't want to follow in our footsteps of the Great War and spend \$600,000,000 for next to nothing in results.

Immediately, the government should start a program of experimentation with "bombers" and combat planes to protect the "bombers" while they work. There are several questions to be cleared up, one of these being whether or not the Martin "bomber" now in use is the best for the purpose. Students of the inventor of the biplane, Octave Chanute, assert that the biplane is wrong for "bomber" types; that it offers a larger target than the triplane; that it depends on a single set of control surfaces, where these should be in duplicate, and that its structural strength and ability to withstand shell or machine-gun fire is not sufficient. This "school of airmen" hold by the triplane and quadruplane as the better "bomber" types.

These are technical questions, but they are of interest to the public that pays the bills. These and others can best be solved by building aerial "bombers" of many designs and giving them rigorous tests. Automatic planes, small airplanes of the types proposed, can be made to fly at suitable altitudes without an aviator aboard as targets. When these are subjected to bursts of high explosives and machine-gun fire, to "air shock" and shrapnel, we will know more about anti-aircraft gunnery as well as the best type of plane.

It will be necessary to encourage private initiative. Somehow things do not get themselves done in "bureau land." We have Wright, Curtiss, Martin and others of known ability who should be assured of encouragement and support. We repeat that the mistakes made in the Great War should be taken to heart.

The tests off Norfolk mark the beginning of an epoch. Experimentation should go on. We need to know more, much more, but we have been

given a glimpse. The bombs that sank the *Ostfriesland* are echoing around the seven seas.—*The Philadelphia Ledger*.

"Plane to fly like a bird" is the caption of a story appearing in *Engineer and Iron Trades Advertiser*, of Glasgow, of April 19. According to the story, the new "pulsating" wing of the Austrian scientist, Professor Raimund Nimfuhr, promises a vista so wonderful that our whole conception of the place of aircraft in the scheme of transport may have to be altered.

The basis of the theory, it is stated, has just been investigated by experts of such reputation as Herr Schwengler, chief of the Zeppelin works, and Herr Skopik, head of the designing staff of the Fokker works, and both believe that Nimfuhr is going on the right lines.

To come to details, the Nimfuhr principle is to imitate mechanically the methods of nature in the wings of birds and insects. The Nimfuhr "pulsating wing" relies upon an extraordinary rapid vibrating or stroke action upon the cushion of compressed air which is formed in flight beneath a sustaining plane.

The actual Nimfuhr wing as constructed for a full-sized machine will, it is understood, be hollow with a flexible membrane on the under side. By pneumatic mechanism this membrane is set pulsating or vibrating with such rapidity that waves of atmospheric pressure are generated which, it is intended, will not only sustain but also propel the machine. There is also a system whereby the extremities of the wings can be extended or contracted by pneumatic action to produce results such as are obtained by birds in stretching or folding their wings. Another feature is an automatic stabilizer, in which disturbances of balance set in motion levers which counteract, by their movement of the wings, any tendency of the machine to lose its equilibrium. Experts are looking forward to the building of the full-sized machine on this principle.

Even more significant, it is pointed out, is the interest financiers are taking in the promise the Nimfuhr method offers of so reducing the power necessary to drive aircraft that aerial transport can be made cheaper than earth transport. If Professor Nimfuhr's claims are substantiated in large-scale work, it is calculated that a trans-ocean craft built on this principle, and carrying several people, would be so economical in power that passengers could be carried by air between Europe and America cheaper than in a steamship.—*Aerial Age*, 18 July, 1921.

**THREE HUNDRED AND TWELVE MILES AN HOUR CLAIMED FOR HELICOPTER.**—The Hague.—Dutch agents here are exploiting a new helicopter invented by a German named Hanschk which, it is predicted, will revolutionize aviation.

The helicopter makes 500 kilometers (312½ miles) an hour, can ascend and descend vertically, remain stationary in the air and cannot fall, it is claimed.

Hanschk declares he could fly to New York in one day, and is convinced that, if financed, he could win the \$1,000,000 prize for a flight around the world.

Colonel Williams, chief of the British Aviation Commission, who saw a model in Berlin, considered it a most wonderful invention and expressed amazement.

Allied restrictions prevent Hanschk from constructing his invention in Germany now, but during the war the German War Ministry forbade Hanschk to offer it to any foreign country, although unable to use it as the adoption of the helicopter would have meant reorganization of the flying corps.—*Aerial Age*, 18 July, 1921.

**SOW SEA MINES FROM AEROPLANE.**—Washington.—Another new war development that has just been perfected is a plan whereby the ocean can

be strewn with contact mines by the use of aircraft. The plan has been tried by American Navy experts and found to work perfectly. The result is that mine laying may become a matter of a few hours' work when an emergency arises, instead of days being required to close up lanes of navigation menaced by enemy ships.

The experiments were conducted in Chesapeake Bay. The mechanism, which was invented by Charles Lee, a mechanical engineer of Portsmouth, Va., consists of the usual mine, an anchor, cable and silk parachute. The plane carries the mine to the point desired, and when it is dropped the parachute eases it into the water. The instant the mine strikes the water, the parachute is released, and it floats away to sink from sight in a few minutes, leaving no trace to give the enemy warning of the proximity of danger.

According to the experts, a fleet of aeroplanes, each carrying a supply of mines, can be sent over the area it is desired to mine, and there drop the mines at regular intervals. The whole area can be mined within a very short time, and the planes be away before being sighted by enemy ships and their mission discovered. This, according to the navy experts, is one of the best and quickest means yet discovered of protecting a coast against enemy craft. The fields can be mapped for the protection of home craft as easily as it can be done with the usual method of laying mines from ships.

Another important development in the matter of aviation has been reported to the government experts from Pittsburg. It is the discovery of the alloy used by Germany in the manufacture of the frame-work of the big Zeppelin dirigibles. This formula has been long sought by both American and British scientists, and it was one point in which Germany was far ahead of the rest of the world throughout the war.—*Aerial Age*, 18 July, 1921.

INTERESTING NIGHT FLYING EXPERIMENTS.—Aviation experts are still following the example of pioneers like Wilbur Wright in learning from birds how to fly. Now they are taking hints from that stunt-flying expert, the bat, in order to make night flying safer, and experiments already show progress.

Bats can avoid obstacles they cannot see. Experimenters in England blindfolded several bats and release them in a room which was crossed by many wires and divided from another room by a grid containing holes just big enough for a bat to fly through. The bats never touched the wires, and flew through the holes with ease.

The experiment revealed the bat's secret. He emits a continuous note, often inaudible to man's ears. This sound bounces back from any barrier, conveying such accurate information to his sensitive ears that he can map out the space in front of him without any uncertainty.

It is now thought the aeroplane may do the same thing. Instruments are being devised so sensitive that they will record visibly and before the airman's eyes the progressive increase of such sounds as ground or any other object is approached. Information would be supplied equally well in the dark or in mist, and since sound travels twelve to fourteen times faster than the fastest plane, the warning would come in plenty of time to avoid accidents.—*Aerial Age*, 18 July, 1921.

FIRST AIR DEFENCE STATION ON U. S. COAST COMPLETED.—The first complete modern aerial coast defense station has just been finished at New Dorp, S. I., and will be turned over officially to the United States Army Air Service as a unit in the national defense next week. It will be designated Miller field and is completely equipped for handling land as well as seaplane patrol aircraft.

It is on the old Vanderbilt estate and covers approximately 450 acres. For seaplane purposes the new field is complete in every way. It has a frontage of 1750 feet along the ocean, which is protected by a huge pier at one end, and a concrete ramp at the other, the two breakwaters forming a haven for the seaplanes, as well as affording smooth water for taking off and landing.

The beach is equipped with a marine railroad for hoisting seagoing aircraft ashore either for repair or housing. For land machines the field is so arranged that they can alight in any direction, according to the direction of the wind. The field itself is rectangular in shape, and is surrounded by the permanent buildings that form part of the station. Aeroplanes have a clear running space of 3200 feet in one direction and 1625 feet in the other.

The station is named in honor of Captain James E. Miller, who was killed in action near Corbeny, France, on March 8, 1918. Captain Miller was a member of the 95th Aero Squadron.

In addition to complete facilities for handling all types of aircraft, the new station is equipped with an independent wireless transmitting and receiving station. There is also a radio direction finder that will enable aircraft to locate the station in foggy weather, and guide them in their coastal patrol work.

It was constructed upon plans completed in the closing stages of the war, and its cost came out of appropriations made for war purposes. The function of turning the station over to the Army Air Service from the constructing quartermaster's department will be informal. The new station will be under jurisdiction of the commander of Mitchell Field, L. I.—*Aerial Age*, 18 July, 1921.

**NAVY'S AIRSHIP LARGEST IN WORLD.**—Some idea of the size, speed and carrying power of the new navy dirigible, *ZR-2*, may be gained from figures made public yesterday by the Navy Department. The giant airship, built in England originally as the British *R-38*, will leave her hangar at Howden, England, August 25, for her transatlantic flight to the United States.

The largest airship ever constructed, the *ZR-2*, has 500,000 cubic feet greater capacity than the German Zeppelin *L-71*, built late in the war period for the avowed purpose of bombing New York. The total length of the *ZR-2* is 700 feet, her greatest diameter 85 feet, and height from the bottom of suspended cars to the top of the bag is 92 feet. She is approximately 2,720,000 cubic feet in capacity and has a lifting power of about 85 tons gross, and a disposable lift of approximately 45 tons, which consists of gasoline, oil, crew, cargo and armament.

The ship is installed with six 350-horsepower Sunbeam Cossack motors, which generate a full speed of 75 miles an hour. The cruising speed of the craft is 50 miles an hour. She carries 10,400 gallons of gas, which gives a cruising radius of 6000 miles at full speed and about 9000 miles at cruising speed. The propellers are equipped with reversing gear which enables the ship to check speed at will or even fly astern.

Control of the dirigible is situated on what is similar to the bridge of the ship. The captain directs the course exactly as does the captain of a seagoing vessel.

The communication system consists of engine-room telegraphs, ship's telephones and voice tubes. The ship is equipped with a radio set with a sending radius of about 1500 miles.

If *ZR-2* were to land in front of the Capitol in Washington, there would be just 25 feet of the Capitol building extending beyond the nose and tail of the ship. If she were stood on end by the Washington monument, the tail of the ship would be 150 feet higher than the top of the monument.

If the outer cover were spread on the ground, it would cover a 4-acre plot. The gas bags which contain the hydrogen gas are lined with gold-beater's skins. There is but one gold-beater skin to each cow that is slaughtered. There are 600,000 of these skins used in lining the gas bags of *ZR-2*.

The structural strength of the ship depends a great deal upon piano wire used as stays and braces. If all the piano wire used in *ZR-2* were put end to end in one string, it would be 60 miles long.

The crew consists of a captain, executive officer, navigator, engineer officer, radio officer, meteorological officer, three watch officers, sixteen mechanics and ten riggers. The crew's quarters are located in the keel-way. The quarters are equipped with comfortable chairs, tables, benches and a Victrola with a good assortment of records. The bunks are placed along the keel-way at varying intervals. Each bunk has, in addition to a good mattress and blankets, a fur-lined sleeping bag.

Each power car is equipped with a cooking arrangement, which consists of a lead from the exhaust pipe of the motor to the cooker. The hot exhaust flames are brought in contact with the bottom of the vessel in which the food is being cooked. The hot food is served on the tables in the crew dining rooms.

Navy officers are much worried about how long they are going to be able to operate the *ZR-2*, the great rigid airship bought from England and due to arrive in the United States the latter part of this month. They are afraid they are not going to have money enough to keep the airship going very long and at the same time keep up the airplanes with the Atlantic and Pacific fleets.

There are no accurate estimates as to what it is going to cost to operate the *ZR-2*, since no warship ever has been in the possession of the government. It is known, however, that the cost of maintenance will be great, since it is necessary to have a crew of 500 men to get it in and out of the hangars alone. The other expense comes from the fuel and the helium and hydrogen used in the great body of the craft.—*The Washington Post*, 8 August, 1921.

**THE "L.F.G.-V3A" FLYING BOAT.**—The *L.F.G.-V3a* flying boat is a rigid truss monoplane passenger machine, produced during 1920 by the Strelund Works of the Luft-Fehrseng-Gesellschaft (L.F.G.) at Berlin. The power-plant consists of a 150-horsepower Benz 6-cylinder engine and recently a 185-horsepower B. M. W. 6-cylinder engine (Bavarian Motor Works). The hull is of very great span, and no side-floats (auxiliary-floats) are used. The hull, the enclosed cabin, the ailerons and the tail (tail-plane, elevators, fin, rudder) are of duralumin metal construction. The ailerons, the elevators and the rudder are of the balanced type. Three or four passengers can be carried. The main dimensions, weights and performances are the following:

Engine	..... 150 h. p. Benz or 185 h. p. B.M.W.
Span	..... 14.45 m.
Length	..... 3.50 m.
Height	..... 2.35 m.
Wing area	..... 30 sq. m.
Airscrew diameter	..... 2.70 m.
Weight empty	..... 9.70 kg.
Weight loaded	..... 14.70 kg.
Total load	..... 500 kg.
Wing loading	..... 49 kg. p. sq. m.
Power loading	..... 10.9 kg. p. h. p.
Speed	..... 150 km. p. h.
Fuel capacity	..... 218 ltr.
Range	..... 600-650 km.

**NEW ITALIAN AIRSHIP.**—Italy has ordered the construction of a new big semi-rigid airship by the Department of Aeronautical Construction.

The main features of this new airship are as follows:

Volume .....	42,000 cm.
Length .....	160 m.
Width .....	25 m.
Height .....	27 m.
Engines.....	12 Spa, 200 h. p. each—total h. p., 2,400.
Maximum speed .....	110 km. per hour
Normal speed .....	85 km. per hour
Range .....	5,600 km. normal speed

In addition a small semi-rigid airship for the training of pilots will be built to the following specification:

Volume .....	1100 cm.
Length .....	40 m.
Width .....	8.50 m.
Height .....	13 m.
Engines .....	2 engines, 35 h. p. each
Maximum speed .....	75 km. per hour
Range .....	500 km. with 4 passengers on board

The price of construction will not exceed that of an automobile *de luxe*.  
—*Aerial Age*, 8 August, 1921.

**DENBY WANTS 30 MILLION FOR PLANE CARRIERS.**—Washington.—Recommendation that approximately \$30,000,000 be appropriated for construction of two aeroplane carriers will be made to Congress in the near future, Secretary of the Navy Denby announced July 25. A measure embodying such a proposal is pending before the House Naval Committee, and it is understood that the Naval Secretary will urge its speedy enactment.

Coincident with Mr. Denby's announcement, Senator King, Democrat, Utah, introduced a bill which would provide for conversion of the battle cruisers *Saratoga*, *Lexington* and *Constellation* into aeroplane carriers, and for stoppage of construction work on the battleships *South Dakota*, *Indiana*, *Montana*, *North Carolina*, *Iowa* and *Massachusetts* and on the battle cruisers *Ranger*, *Constitution* and *United States*.

Secretary Denby said he had decided on his forthcoming recommendation even before the recent bombing tests, but that the results of those tests had convinced him that the navy needed more aeroplane carriers. Senator King, addressing the Senate in behalf of his bill, said that the bombing tests had demonstrated conclusively that "too much importance" had been attached to capital ships and too little attention devoted to aircraft and submarines.

Secretary Denby indicated that in his opinion it would be wise to construct two new aeroplane carriers, one for the Atlantic fleet and the other for the Pacific forces. Two carriers were provided for in the current naval appropriation bill as it passed the Senate, but the House refused to accept the provision and it was stricken out.—*Aerial Age*, 8 August, 1921.

**NEW RULES PROHIBIT ARMY "STUNT" FLYING.**—Washington.—Aroused by the fatal accidents occurring as the result of aeroplanes doing "stunts" over holiday crowds, the War Department has issued general orders restricting flying over towns and prohibiting "stunt flying" over crowds except under unusual conditions. Practically the same general rules apply to lighter-than-air craft.—*Aerial Age*, 8 August, 1921.



**MANUAL ON NAVY AVIATION.**—In order that line officers of the navy may have an opportunity to study aviation, the Bureau of Navigation has approved the plan for the compilation of a manual on the general subjects of aviation, organization, activities, aeroplanes, engines, equipment, use aboard ship, and other details. When this manual has been compiled and approved, it will be issued to the line officers of the navy, and thereafter questions on aviation based upon the general subject as treated in the manual, will be part of the examination of line officers. The plan is now under way, but it is not expected that either the manual or the questions for examination will be ready for issue much before the first of next year, or possibly later. A tentative series of questions was submitted to the Bureau of Navigation as an outline of the subject which should be covered in the new manual.—*Aerial Age*, 8 August, 1921.

**AERIAL PATROL OF SEA LANES.**—Acting Secretary of the Navy Roosevelt has asked the House Committee on Naval Affairs to include in the Legislative Naval bill for 1921, a proviso "that naval aviation shall have cognizance of the aerial operations necessary to gain and exercise command of the sea and of such stations and craft as are necessary to insure adequate aerial patrol of the sea lanes for these purposes." Under existing law dividing aerial responsibility between the two services, the navy is not charged with keeping open the sea lanes for coastal shipping. This, says Mr. Roosevelt, "is an integral part of the navy's duty and was the major work it performed in aviation during the late war. The navy's development of aircraft is towards types that can perform this duty. In war time the navy will have to and should do this work and the army will not have suitable planes for it, and, moreover, the army will be occupied on its legitimate function, the land defense. It is extremely desirable as a matter of national policy that Congress fix responsibility by law for the defense of the United States in conformity with the approved plans of the War and Navy Departments as promulgated by the Joint Board."—*Aerial Age*, 8 August, 1921.

#### NAVIGATION AND RADIO

**A VOYAGE OF RESEARCH.**—The little vessel, the *Quest*, of some 200 tons net, which is to sail in August under the command of Sir Ernest Shackleton, will undertake scientific research among the lesser-known islands of the Atlantic and Pacific Oceans and the uncharted seas of the Southern Polar regions. A full hydrographical survey is to be made and the equipment of the vessel includes a specially constructed seaplane. It is hoped that the result of this voyage of exploration and discovery may be to clear up the many doubts which have arisen about certain portions of the Antarctic regions, and it is understood that a special search will be made for the islands of Tuanati and Dougherty. The latter might, it is thought, prove a useful site for a wireless station to bridge the gap between New Zealand and South America.—*The Engineer*, July, 1921.

**STEERING BY WIRELESS.**—Perhaps the most important feature of the recent airplane bombing tests off the Virginia Capes was one to which hardly any attention was paid at the time. It was the maneuvering of the battleship *Iowa*, far out at sea, without a man on board. The ship was steered by wireless from the coast.

This, as the *Elmira Star-Gazette* says, marked a big step in one of the most remarkable developments of modern transportation. Small vessels have been steered in this way before, but it appears to have been the first time the process was applied to a craft as big as a battleship, and also the first time the mechanical maneuvering was done at so great a distance.

The application of this new art to future warfare is obvious. If warships can be directed accurately by wireless, their fighting possibilities are greatly augmented, because they can be sent against a fort or a hostile fleet without any risk whatever to human life. Torpedoes can be steered in that way, and small craft loaded with ammunition can be used as torpedoes, and sharp-prowed craft can be used to ram large craft. It may be possible eventually to handle a battleship or cruiser similarly in all of its fighting operations, steering it and aiming and discharging its guns and torpedo tubes by wireless, besides using the vessel itself as a ram.

The process can be applied to aircraft, too. Therein, perhaps, are its greatest possibilities. Aircraft offer the greatest menace to warships, but air-fighting is extremely risky for the flyers. If an endless process of bombing planes can be sent over a hostile fleet, flying straight and dropping their missiles without any human operator to suffer fear or death, what chance will the warships have?

We may even see battles between purely mechanical aircraft, eventually, or between rival fleets of wireless-directed aircraft. That would be the logical end of the present armament tendencies.—*The Courtland Standard*.

**WEATHER BUREAU OFTEN FURNISHES CLUE TO DISAPPEARANCE OF SHIPS AT SEA.**—Widespread interest has been aroused by the disappearance while at sea of ten or more vessels and their crews within the last few months. This strange vanishing without trace at first led to the circulation of the wildest reports. One ascribed the loss of these vessels to a pirate ship, another to an oil-fired submarine chaser, while from Paris came the story that an insane man in a U-boat—a regular twentieth century Captain Kidd—was to blame. All these yarns were exploded by officials of the United States Weather Bureau, which proved that the vessels were lost in severe storms.

*Knowledge Quite Recent.*—This is only one example of the useful work performed by the marine meteorological branch of the Bureau. One hundred years ago little was known of the laws that govern weather conditions on either land or sea, and only experience taught the mariner that in certain regions of the ocean the winds were fairly steady from a given direction, while in other regions they were much less to be depended upon.

During the early half of the nineteenth century, especially in the 20 years following 1830, many of the mysteries of wind movements were at least partly solved. Observations made in log books of vessels that passed through identical tropical storms were brought into relation with each other by students, and thus the whirlwind motions of the disturbances, or "meteors," as they were then called, were established.

It was M. F. Maury, an officer of the United States Navy, who finally invited the "co-operation of American shipmasters in making daily, in all parts of the ocean, as they pursue their voyages to and fro, a series of meteorological observations."

More than 1000 American vessels responded, and in the early fifties, from the materials obtained, Maury constructed his "wind and current" charts. Maury believed that in studying the winds, "we must look to the sea for the rule, to the land for the exceptions," and so thoroughly imbued was he with the value of taking weather observations correctly at sea that in 1851 he urged the holding of a conference of nations to take up the question of "establishing a universal system of meteorological observations for the sea as well as for the land." The marine conference at Brussels in 1853 followed, with representatives from ten governments attending. An international form on which to record observations at given hours was devised, and suggestions were made toward standardizing and correcting to precision all recording instruments in use.

*Value Quickly Realized.*—When the first of Maury's charts appeared, showing the normal condition of wind and weather over the oceans of the world, the marine interests were quick to realize their value, and by referring to them many a shipmaster was enabled to shorten the duration of his voyage considerably. In those days, when most of the commerce of the world was carried in sailing vessels, and the few steamers were of comparatively low power, the study of marine meteorology in relation to sailing routes was perhaps of more importance than it is at present, when many of the cargo carriers are of high power and large tonnage and ply back and forth between ports with the regularity of railroad trains.

It must be remembered, however, that even at this day a very large proportion of the world's ocean freight is carried by tramp steamers of from 1000 tons to 4000 tons, and of low power, while much of our coasting trade is carried on in sailing vessels and auxiliary schooners. To masters of vessels of these classes a study of the pilot charts should prove of value in enabling them to choose the most favorable route between ports; this being especially true in the unfrequented waters of the world.

*Have Wireless Apparatus.*—As large numbers of vessels are now equipped with wireless apparatus and the percentage is increasing yearly, the captains are enabled to receive weather reports from each other, as well as the official forecasts, when they are within range, thus enabling them to locate with more or less accuracy the approximate center and probable movement of any marked disturbance. In fact, from observations sent by radio, some synoptic weather maps have been made at sea and used in local forecasting.

There is one feature of marine meteorological work that has not been exploited to any great extent; yet from a purely commercial standpoint is as important as any. This might be called marine climatology, and consists in furnishing information regarding the weather conditions on any given date or period of time in the past at a certain locality.

Requests are constantly being received from ship owners and law firms for information of this sort. For example, a letter was recently received stating that a schooner sailed from a north Atlantic port on a certain date for the West Indies and had not been heard from since; and the owners requested a report on the weather conditions along the coast of the south Atlantic states and in the West Indies about the time the vessel should have reached certain points. In investigating a circumstance of this kind it might be found that the vessel must have encountered a tropical hurricane, or the records might show no unusual weather of any kind, in which case the disappearance of a vessel would be numbered among the many mysteries of the sea.

It sometimes happens that a vessel arrives at her destination with the cargo in a bad condition, and then the question arises between the consignee and the owner as to whether the damage was caused by carelessness or could not be avoided owing to the unusual heavy weather encountered. Reports received from other vessels in the neighborhood indicate the true state of the weather experienced during her voyage, and evidence compiled from these reports is frequently given in court, thus enabling a just decision to be arrived at.—*The Nautical Gazette*, 30 July, 1921.

## ORDNANCE

**SHORE BATTERIES VS. BATTLESHIPS.**—During the past year, the U. S. Battleship ex-*Massachusetts* was dismantled by the Navy Department and was turned over to the Chief of Coast Artillery for use as a target for Seacoast Artillery. The old *Massachusetts* was laid down in 1891, launched in 1893, and put into commission in 1896. She was partially reconstructed in 1905. She had a displacement of 10,288 tons; water-line length, 358

feet; beam, 69 feet, and draft of 28 feet. Her main belt armor (Harvey) was 18 inches to 15 inches, 17-inch bulkheads, 3-inch deck, 17-inch barbettes. All of the armament and the serviceable fixtures worth salvaging were removed before the vessel was towed to Pensacola Harbor to serve as a target, but the armor was left intact.

In December, 1920, the *Massachusetts* was grounded on a sand shoal about 4000 yards off Old Fort McRae and almost half mile from the ship channel leading into Pensacola Bay. The ship was placed so that when she rested on an even keel on the sand the depth of water was equivalent to her normal draft, and so that her port main-belt armor was exposed to the fire of the guns in the coast defenses of Pensacola. Shortly after the vessel was grounded a heavy storm caused her bow to swing about the stern as a pivot through an angle of approximately 60 degrees and gave her a list to seaward of  $15\frac{1}{2}$  degrees. The new presentation of the ship prevented the attack of belt armor from the shore guns.

Prior to the grounding of the ship the Coast Artillery Board drew up a program of firings to be conducted against her. The program was approved by the proper authorities and the necessary ammunition and equipment sent to Fort Barrancas for conducting the firing tests.

The program included firing from a 12-inch gun fixed battery with armor-piercing shot and shell; a 12-inch fixed mortar with deck-piercing shell, both inert and explosive; a 12-inch railway mortar with deck-piercing shell, and from a 12-inch railway gun with 12-inch armor-piercing shell. In addition, 3-inch and 5-inch star shells were to be tested at night.

Early in January the Coast Artillery Board, consisting of the following officers: Maj. F. H. Smith, C. A. C., president; Maj. Quinn Gray, C. A. C., Maj. J. H. Pirie, C. A. C., Maj. L. B. Bender, Signal Corps, members, and Maj. W. B. Hardigg, Ordnance Department, temporary member, proceeded to Fort Barrancas to supervise the firings.

The program was gotten under way as soon as the weather permitted, the first firings being made from the 12-inch fixed mortar with 1046-pound shells. Three hits were obtained, one entering the forward stack at its juncture with the superstructure, emerging below the berth deck and tearing a rent of about 30 square feet area in the stack at the point of egress, continuing its way through the boiler room, and, so far as could be determined, entirely through the hull. The other two fell between the stacks on the port side of the center line of the ship. These rounds also perforated the ship.

The next series was fired from the 12-inch fixed gun battery at short mid-range. Five hits with A.P. shells were made—three forward, one in main belt and one aft. The hits forward wrecked the forward compartments on the berth deck, cutting the bulkheads and arching up the main deck, wrecking the anchor-chain locker and starting a fire in some timber work left in the vessel. The hit aft wrecked the ammunition-handling facilities of the port 8-inch turret, completely wrecked the water-distilling installation of the ship, and distorted the plates, turret barrette and base of cage mast. The shell bursts cut dozens of unprotected communication lines and did considerable superficial damage. The hit on the main belt was at a very unfavorable angle and caused practically no damage.

Armor-piercing shot were next fired from this battery. The main belt was presented at such an oblique angle that no hits were placed in it. Three hits were placed in the forward turret and two in the superstructure. The hits on the turret were not fair hits; the first, being a very oblique hit at the top of the turret, cut a groove in the turret armor and passed to sea. The second ripped open the main deck for a distance of about 12 feet and struck the turret casemate at an oblique angle. The armor plate struck was slightly displaced. The third hit cut open the berth deck, passed through the supporting beams for a distance of about 18

feet, and caused a considerable displacement of the armor plates struck when the projectile "key-holed" without penetration. In the superstructure, one shot cut through practically the entire width of the bridge deck, the other penetrated the forward stack and cut the main deck for a distance of about 30 feet, doing slight damage to ammunition hoist on the starboard side. The projectile burst and did superficial damage to thin plating about the barbette of after 8-inch turret.

Firings from the 12-inch railway mortar were next made. Weather conditions were unfavorable, and as the range was considerable from this piece, some trouble was encountered in the range adjustment. When visibility improved, however, the fire was adjusted, though a 50-mile gale was blowing aloft. Two hits were placed between the smoke stacks, one to port and one to starboard side of center line. The hit to port perforated the ship, while the hit to starboard burst just inside the belt armor. The decking on the berth deck was blown up over a considerable area. The presence of water rendered it impracticable to determine the damage below decks from this hit.

Additional firings from 12-inch fixed mortar were then made. Two hits were placed between the stacks near the center line of the ship. These projectiles penetrated below protective deck and presumably perforated the hull of the vessel.

Firings were next made from the 12-inch railway gun. Two hits forward were made before the firings were suspended. One hit burst on the main deck, the slope of which was but little different from the angle of fall of the projectile. This hit blew a large hole in the main deck and did some superficial damage. The other entered the side of the vessel just forward of the collision bulkhead, penetrated this bulkhead, which was practically detached from the sides of the vessel due to previous shell bursts, penetrated the berth deck and burst near the orlop deck, which was submerged. The detonation of this projectile opened up the seams in the side of the vessel at the orlop deck for a distance of about 20 feet, blew up the berth deck-plates over the area of the detonation, put an additional arch in the main deck and opened up a seam several inches wide between main deck and side plates of vessel for a distance of about 20 feet.

In addition to the firings from the large caliber guns, star-shells were fired over the vessel from 3-inch batteries at about 4500-yard range and from a 5-inch gun at about 6000-yard range. The shell functioned well, and when properly placed, the ship stood out boldly to observers at ranges under five thousand yards, but at greater ranges and when the line of vision from the observer to the star did not pass through or very close to the vessel, the vessel was not clearly outlined.

The purpose of the tests conducted was to determine the effectiveness of seacoast ammunition from reserve supplies against the vessel, and to confirm or to cause changes in certain policies of design of seacoast ammunition, and to determine the relative value of several types of seacoast defense weapons.

The shifting of the vessel due to action of the wind and waves prevented the attack of the main belt with any hope of perforation, so that the question as to whether the armor or projectile of two decades ago overmatched was not settled. The projectiles allotted for this part of the test were made shortly after the close of the Spanish-American War.

The firing of the high-angle weapons clearly indicated that vessels of the *Massachusetts* type have no adequate armor defense against this type of attack.

The long-range firings indicated that a large angle of fall is a great advantage in the attack of armored vessels.

In general, the firings against the old battleship confirmed conclusions drawn from the information gleaned from study of reports of damage

done by gun-fire during the World War. We can now feel more fully assured that the policies laid down for future design and supply of sea-coast guns and ammunition are sound. Furthermore, it was shown that war vessels in an attack on our land defenses are exposed to speedy destruction as soon as they come within range of the curved-fire guns.

During the past three years great progress has been made in the design, manufacture and testing of armor-piercing projectiles. American manufacturers have produced 12, 14 and 16-inch projectiles which have passed, satisfactorily, tests under specifications requiring penetration of armor-plate in condition for effective detonation at angles of impact up to 25 degrees from normal.

The ballistic qualities of these projectiles have also been so improved that, at the present time, it is possible to say that America can produce, and has produced, armor-piercing projectiles which are, so far as is known, the best in the world.—*Journal U. S. Artillery*, 21 July, 1921.

**SUBMARINES.**—In outlining an up-to-date program for a modern navy we must not forget submarines. We must remember that the submarine nearly won the World War for the Germans against the navies of the civilized world. It is absurd to say that the submarine was conquered. It was not. The listening device has strengthened it. New types have been developed—cruiser submarines, fleet submarines and mine-laying submarines. We must have these types. Without them our navy cannot fight a winning war.

The worn-out ideas of 1916 must give way to the demonstrated naval truths of 1921.—*The New York Tribune*, 31 July, 1921.

**ERA OF THE SUBMARINES.**—Admiral Reinhold Scheer, who succeeded to the command of the German High Sea Fleet early in 1916 and retained this post for more than two years, leaving it in the summer of 1918 to take over the Marine Secretaryship from Admiral von Capelle, has occupied his leisure since the war in writing on the strategy and tactics of the late campaign. His book, the "High Sea Fleet in the World War," is a useful contribution to naval literature, though its historical value suffers from the author's lack of objectivity and his striving to make propaganda. Many articles from the pen of Admiral Scheer have recently appeared in the German press, and while most of these, too, are tainted with propaganda, they are not without interest from the technical point of view. The following extracts summarize the reflections of Germany's foremost flag officer on the future of naval strategy, with special reference to the submarine:

"Now that it has become possible to achieve the principle of submersibility, naval warfare enters upon an entirely new phase. The old conditions have gone, never to return; they have been superseded by new conditions, among which is the control of the air by dirigibles and planes. The British naval authorities have themselves assisted in the development of the submarine, and in so doing have undermined the predominance of the British fleet. There is no doubt but that submarine warfare stands only at the beginning of its development; on the other hand, surface ships have practically reached the limit of their evolution. They have grown to extraordinary dimensions, but have not thereby rendered themselves less vulnerable, and they are objects of such great value that, as the strategy of the war showed, they are more to be protected than used. And so this policy of outwitting the other Powers by forcing them to build ships of tremendous size and cost has turned against its own originators. Only a few nations could afford the luxury of these giant ships, and England was always able to keep her lead over these few rivals. All the minor naval powers sank into insignificance; Britain's control of the seas seemed secure.

"The submarine upset all these calculations. The world is losing its dread of the British Navy as an instrument of war, just as it is coming to realize Britain's vulnerability in respect of damage to her sea-borne commerce. At the opening of the war Britain's first care was to avert a panic arising out of the danger to food imports. Sir Julian Corbett's book shows what herculean efforts were made to protect the ocean routes from German cruiser raiders in the Atlantic and Indian Ocean. Commerce protection became the decisive factor. Now, how much more difficult would have been the position of Britain had her enemy possessed 20 or more submersible cruisers, equal or superior in speed to our light cruisers, and sent them into the Atlantic! They would have been able to avoid attack by diving, and the bunkering difficulties under which our cruisers labored would have been absent. For the chief strength of our submarines lay in their extensive radius of action, which is due to their being able to seek safety by diving, instead of having to flee at high speed, involving heavy fuel consumption when attacked by superior forces. Particularly favorable would be the position of a country engaged in naval warfare against Britain which had outlying insular bases in the strategic areas—an asset that Germany did not enjoy.

"The disabilities of the submarine are now well understood, and the first of these is low speed. It is only when one recalls the limited number of submarines we had at the outbreak of war—viz., about two dozen—and that thereafter the expansion of our flotilla had to be more or less improvised, with scarcely any time for improvements which are usually the fruit of prolonged research, that their real achievements can be appreciated. It was necessary above all to add to their number and shorten the building period. For this reason, and because we counted on a speedy ending of the war, a considerable number of small boats were built. Owing to their restricted radius of action these little craft were selected for operations in coastal and British waters. This, however, happened to be the area where counter-submarine tactics were most potent, and the work of our boats was consequently rendered more difficult. It was only towards the end of the conflict that we obtained submersibles of 1200 to 2000 tons which were able to keep the sea for three months. Moreover, the surface speed was raised from 12 knots to 18, and the submerged speed from 7 knots to  $9\frac{1}{2}$ . And now we have heard that the British had already built submarines with a surface speed of 24 knots. Science will undoubtedly find means of developing the submarine still further, with the object of enabling it to act not only as a commerce destroyer, but as a unit capable of taking part in a fleet action. We need only remember the advance which has been made in the speed of steam-driven surface ships over the early representatives of this type. It should be noted also that counter-operations will become less effective in proportion as the submarine develops more formidable powers of attack, higher speed, and greater handiness."

I may interpolate here some remarks made by Admiral Scheer on another occasion apropos the evolution of the submarine. He then recorded his firm conviction that a type will be reached which shall be able to remain at sea for at least eight months, to serve as a tactical unit of the battle fleet, and to be armed with guns sufficiently powerful to fight destroyers and even light cruisers. His belief is that these future submarines will be so large and so heavily armed that the necessity for rapid submergence will no longer exist. Submarines of this improved type will, he thinks, be auxiliaries of the utmost value to a battle fleet, though he does not concur with Admiral Sir Percy Scott that the submarine can wholly replace the battleship.

Admiral Scheer is averse to a further increase in the dimensions of capital ships, and he regards as Utopian the idea that battleships of a tonnage approximating to the present-day scale can ever be given the faculty of submergence. Nor does he consider it necessary. On the other hand,

it is easily possible, he contends, to enlarge the submarine cruiser to the point at which its habitability will be practically equal to that of big surface ships and its guns can be served with full effect—and this without nullifying its character as a submersible, whose primary weapon is the torpedo. Predicting in outline the effect of such development on naval strategy, he continues:

"As the submersible warship grows in power and efficiency the value of the surface ship will decline. The present conception of 'command of the sea' will lose its meaning. For a superior battle fleet is not sufficient in itself to defeat an adversary who is conducting a war on commerce with submersible cruisers. However strong the battle fleet may be, it cannot protect trade so long as the enemy's submarine strongholds remain undestroyed. During the late war Britain was not successful in this respect, despite her great superiority over the German fleet and her favorable geographical position *vis à vis* our bases in Flanders and the Heligoland Bight. Anti-submarine operations, to be really effective, must be carried right into the enemy's coastal waters, where the attacker is at a great disadvantage owing to the distance from his own base and the proximity of enemy submarine harbors.

"On the high seas the fast submersible cruiser will have little to fear from counter-tactics. It will render large oversea naval and military operations practically impossible, since no great fleet could traverse wide stretches of ocean and afford adequate protection to its communications when numerous enemy submarines of almost unlimited endurance and high speed were at large.

"In a fleet action the function of the fast submarine will be to understudy the destroyer and attack the enemy line. The fact that submarine attacks may be delivered at any moment without warning is bound to influence gunnery conditions and fleet tactics in general. Finally, great battle fleets are no longer able to fulfil their chief function, which is the protection of commerce. Every power which can defend its own coast will be able to take part in this submersible warfare, without being forced to fight an action for the command of the sea. Predominance in size and numbers of capital ships has ceased to imply strategical predominance in the naval sphere."—*The Naval and Military Record*, 13 July, 1921.

### MISCELLANEOUS

**THE SPERRY GYROSCOPIC STABILIZER.**—In our issue of May 6 last we gave on pages 550 and 556 a description and illustrations of the gyro-wheels forming part of the installation of a Sperry gyroscopic stabilizer which was being built for installation in the American liner *Huron*, each of these wheels weighing finished 100,000 pounds. We now learn that an installation of this kind is to be fitted by the Admiralty to a flotilla leader, and that the equipment will be built in this country by the Metropolitan-Vickers Electrical Company, of Trafford Park, Manchester. The results of this installation will be regarded with much interest. We may add that the photographs of the large rotors which we reproduced on page 556 of our issue of May 6 were taken at the South Bethlehem Works of the Bethlehem Steel Company, Pennsylvania.—*Engineering*, 15 July, 1921.

**ARE WE READY FOR WHOLESALE MURDER?**—Are civilized nations at war prepared to adopt weapons that will enable them to wipe out an army of a million men in a few hours or to annihilate whole cities? Our chemical-warfare service assures us that the United States now possesses the means of doing this very thing. What are we going to do about it? The editor of *The Scientific American* (New York) expresses his belief that the world at large is not ready to go the Germans several points better in disregard of the humanitarian laws of war. All poison-gas warfare should be declared unlawful, he thinks, by international agreement of



some sort. Unless something of this kind is done, the next war, he believes, will make the last one "restful, by comparison," and will "wipe out mankind at a rate which will turn many a flourishing capital into a deserted village." The development of highly destructive weapons, he points out, has never yet prevented nations from making war, and if these horrors are to be averted either war itself must be made impossible, or the nations must get together on this point, if on no other. He writes:

"Mr. Chairman, the Chemical-Warfare Service has discovered a liquid approximately three drops of which, when applied to any part of the skin, will cause a man's death. Much smaller amounts than this, or even vapors from the liquid, cause very severe, slow-healing burns."

"If the reader applies to the Government Printing-Office, at Washington, he can get therefrom a copy of the 'Hearings at the Third Session of the House Naval Affairs Committee,' and he will find there that the words above quoted form part of a statement by Mr. Bradner, Chief of Research of the Chemical-Warfare Service. Mr. Bradner goes on to remind the committee that the world war showed it to be possible for an airplane to fly within a hundred feet of enemy troops and machine-gun them with impunity; and he goes on to state that if, instead of carrying machine guns, the attacking planes were equipped to carry a tank of this liquid (Lewisite) for discharge from nozzles similar to the ordinary street-sprinkler, it would fall like rain, killing everything in its path.

"Then he becomes more specific and tells us that one plane, carrying two tons of the liquid, could cover a stretch of country 100 feet wide by seven miles long in one trip, and that it could spray down enough of the liquid gas to kill every man in that area simply by the action of the gas upon the skin. Then, a little later, he becomes even more specific and tells us that, during the Argonne offensive, the entire First American Army of a million and a quarter men occupied an area of approximately 40 kilometers long and by 20 kilometers wide. If, he goes on to say, Germany had possessed 4000 tons of this material and, say, 350 planes properly equipped for spraying, our entire First Army would have been annihilated in from ten to twelve hours.

"Now, 4000 tons seems like a big lot of gas; but we already possess at the Aberdeen Proving Ground a huge poison-gas factory (Edgewood) which was capable, at the armistice, of producing 200 tons of gas per day, and it would be a simple matter by enlargement and duplication to put this country in a position where it could produce several thousand tons of gas for the supply of our armies and keep the supply going indefinitely. Yes, the future war will be so horrible as to make the late war restful by comparison. Short as it will inevitably be, it will last long enough to wipe out mankind at a rate which will turn many a flourishing capital into a deserted village, and many a fair campagna into a Sahara of lifeless desolation—for this gas, remember, is as fatal to vegetation as to human life.

"All this talk, however, about the poison-gas war of the future is based on what we dare to believe is an altogether unwarrantable assumption—namely, that the devil's own disregard of the humanitarian laws of war, initiated by the Germans at Ypres, is to be accepted and practised by the world at large. If, in the forthcoming meetings on disarmament, or of the suggested 'Association of Nations,' or the League, or what-not, it be accepted that poison-gas warfare is lawful, we dare to believe that this sanction will be given in the face of the protest of that undoubtedly large majority of men who believe that honor, chivalry, and human kindness are not quite dead in our midst, and that the monstrous horror of the first gas attack at Ypres should not be the yardstick by which we measure our future military conduct.

"It has been urged that the free use of gas will make future wars so frightful that no nation will dare to provoke a conflict. The answer to

that assumption is that, in the past, the development of new weapons of great destructive power has never prevented a nation from rushing into war."—*The Literary Digest*, 16 July, 1921.

#### CURRENT NAVAL AND PROFESSIONAL PAPERS

Internal Combustion Engines in Marine Service. *Journal of the Franklin Institute*, July, 1921.

Fuel Problems of the Future. *The Engineer*, 1 July, 1921.

Tomorrow's Airships. *Scientific American*, 30 July, 1921.

Motor Control Equipment—Protective Features. *Power*, 2 August, 1921.

Ships Propellers. Notes on results of experimental research regarding "cavitation" as affecting propulsive efficiency. *Engineering*, 8 July, 1921.

Description of a demonstration of Foamite Firefoam recently held at Camden, N. J., for the benefit of the Imperial Japanese Naval Commission.

# NOTES ON INTERNATIONAL AFFAIRS FROM JULY 10 TO AUGUST 10

PREPARED BY  
PROFESSOR ALLAN WESTCOTT, U. S. Naval Academy

---

## CONFERENCE ON DISARMAMENT AND FAR EAST

**PRESIDENT HARDING PROPOSES CONFERENCE.**—On July 10 the U. S. State Department issued the following announcement of negotiations undertaken for a conference on limitation of armament and the settlement of problems in the Pacific and Far East:

The President, in view of the far-reaching importance of the question of limitation of armament, has approached with informal but definite inquiries the group of powers heretofore known as the Principal Allied and Associated Powers, that is, Great Britain, France, Italy and Japan, to ascertain whether it would be agreeable to them to take part in a conference on this subject, to be held in Washington at a time to be mutually agreed upon. If the proposal is found to be acceptable, formal invitations for such a conference will be issued.

It is manifest that the question of limitation of armament has a close relation to Pacific and Far Eastern problems, and the President has suggested that the powers especially interested in these problems should undertake in connection with this conference the consideration of all matters bearing upon their solution with a view to reaching a common understanding with respect to principles and policies in the Far East. This has been communicated to the powers concerned, and China has also been invited to take part in the discussion relating to Far Eastern problems.

Favorable replies were at once received from France, Great Britain, Italy, and China, and later from Japan. In the Netherlands the feeling was expressed that in view of that nation's large possessions in the East Indies, she should also have been included among the nations invited, but the American Government felt the necessity of keeping the conference small enough to work effectively. After further inquiries, Armistice Day, Nov. 11, 1921, was suggested as a suitable date for opening the conference, and this date was accepted by the nations concerned. The Soviet Government issued a protest because of the failure to include the Siberian Republic, and declared that it would not be bound by any decisions reached by the conference.

**JAPAN SEEKS TO LIMIT SCOPE.**—To Japan the plan of a conference, not only upon disarmament, but upon Pacific questions as well, apparently came as a surprise. Her first reply was favorable as regarded disarmament, but requested information as to the scope and nature of subjects to

be discussed in connection with the Pacific and Far East. In reply, the American Government on July 23 suggested that Japan should not press for an immediate decision as to the subjects to be discussed, but should leave the precise agenda of the conference for later adjustment. Japan's final acceptance on July 27 was expressed as follows:

The Japanese Government have taken note of the contents of the American memorandum of July 23, received through the American Chargé d'Affaires, in reply to the Japanese memorandum of July 13, on the subject of a conference on the limitation of armaments to be held at Washington.

It has been brought to the knowledge of the Japanese Government that the Government of the United States is willing to proceed with exchanges of opinion regarding the agenda prior to the meeting of the conference and that it considers it advisable to adjust in that agenda the nature and scope of the Pacific and Far Eastern questions to be discussed at the proposed conference. The Japanese Government, on that understanding, are happy to be able to inform the American Government that it is their intention gladly to accept an invitation for a conference which shall embrace the discussion of the Pacific and Far Eastern questions.

The Japanese Government have been made aware through the communications and the published statement of the American Government and the conversations between the Secretary of State and Baron Shidehara that the propositions of the American Government to discuss the Pacific and Far Eastern problems is based on the close bearing they have on the question of the limitation of armaments, which is the original and principal aim of the conference, and that therefore the main object of discussing these problems is to reach a common understanding in regard to general principles and policies in the Pacific and the Far East. Desiring, as they do, to contribute to the establishment of an enduring peace and to the advancement of human welfare, the Japanese Government earnestly hope that the proposed conference may attain the expected results, and their ideals may therefore be brought nearer to realization.

In order to ensure the success of the conference, the Japanese Government deem it advisable that the agenda thereof should be arranged in accordance with the main object of the discussions as above defined, and that introduction therein of problems such as are of sole concern to certain particular powers or such matters that may be rewarded accomplished facts should be scrupulously avoided.

**YAP CABLES TO UNITED STATES.**—Washington, July 29.—Secretary Hughes has written a letter to President Harding on the subject of communications facilities in the Pacific, in which, in addition to dealing with the needs of that situation he asserts his belief that it is probable the cable from Guam to Yap will be allocated to the Government of the United States.

The Secretary is hopeful that there will be an early and mutually satisfactory settlement of the controversy that existed for some time over the disposition of the former German cables radiating from the Island of Yap.—*N. Y. Times*, 30 July 1921.

**PRELIMINARY CONFERENCE ABANDONED.**—Following Great Britain's acceptance of the conference invitation, the difficulty arose that the premiers of Australia and New Zealand, who were deeply concerned in the settlement of eastern questions, would be unable owing to the meeting of their parliaments to attend a conference held in the autumn of this year. Inquiries were therefore made as to the possibility of a smaller preliminary conference, but the United States did not view favorably the idea of two

separate meetings. The surmise was made that Japan desired the earlier smaller gathering in order that certain Pacific questions might be settled before the general meeting. The British version of these negotiations for an earlier conference was given as follows in a summary issued by the Imperial Conference of Premiers:

"In accordance with the suggestion which was believed to have been made by the United States Government that the conference on disarmament should be preceded by conversations or consultations between the powers principally concerned in the future of the Far East and the Pacific, the Imperial Conference, anxious that for the Anglo-Japanese agreement there should be substituted some larger arrangement between the three great powers concerned, namely, the United States, Japan and Great Britain, and holding the firm conviction that the later discussions on disarmament, to which they attached transcendent importance, could best be made effective by a previous mutual understanding on Pacific questions between these powers, discussed these preliminary conversations or consultations, which the United States Government had in principle agreed should be held in London.

"When it transpired that there was some misunderstanding as to the nature of the suggested preliminary conversations, the British Government, in a desire to remove any possible misconception and to meet what it believed to be the United States view, volunteered to attend a meeting on the other side of the Atlantic, at which the agenda of the Washington conference could be discussed.

"Premier Lloyd George, Marquis Curzon and the Dominion Premiers were prepared to attend such a meeting, if invited by the United States Government. Japan also had signified her willingness to attend. The United States Government, however, did not favor the idea, which accordingly was dropped.

"At no stage was it suggested that the result of such consultation should either anticipate the work or tie the hands of the Washington conference. On the other hand, the Imperial Conference made the proposal because it was anxious to remove every possible obstacle from the path of the Washington meeting, which it desired to see attended with complete success."

ANGLO-JAPANESE PACT CONTINUES INDEFINITELY.—It now appears that the Anglo-Japanese Treaty will continue indefinitely, until formally denounced by either power. Premier Lloyd George's statement in Parliament on July 11 summarizing the work of the Imperial Conference explained the situation thus:

"The object of our discussion was to find some means to limit the danger of heavy naval expenditure in the Pacific and remove those evils which tend to limit the development of our legitimate interests in the Far East. We had to ascertain our position in regard to the Anglo-Japanese agreement in view of the decision of the League of Nations. We had to consider the position of the agreement. There was some doubt as to whether the agreement had lapsed.

"The question was referred to the Lord Chancellor, and he, with the law officers of the Crown, came to the conclusion that the agreement remained in existence for one year after it had been formally denounced. It follows, therefore, that the Anglo-Japanese alliance remains in force until it is denounced, and will only lapse at the expiration of twelve months after notice of denunciation has been given.

"It is the desire of the British Empire and of Japan that the agreement should be brought into complete harmony with the Covenant of the League

of Nations, and where the one is inconsistent with the other the terms of the Covenant shall prevail. Notice to this effect has now been given to the League."

### MEETING OF SUPREME COUNCIL

**ALLIES DIVIDED OVER SILESIA.**—During the latter part of July serious differences of policy developed between Great Britain and France regarding the settlement of the Silesian question. On July 20 the British Government proposed an immediate meeting of the Supreme Council. The French Government objected to a conference at that time, stated that it intended to send more troops to Silesia, and suggested that Great Britain do the same. The idea of independent action on the part of France was sharply opposed by Great Britain.

London, July 28.—A situation of serious difficulty in the relations between Great Britain and France has arisen out of the discussions regarding Upper Silesia. The French Government has addressed to London a note in which the British position is described as an "unfriendly attitude" and a reply has been drafted in which it is stated that persistence in the French policy may provoke a rupture of the Entente between the two countries which contributed to the allied victory in the war.

Reception of the French note created consternation in British diplomatic circles. Conversations which had been carried on between the Foreign Office here and the Quai d'Orsay had not conveyed any suggestion that the different points of view in regard to Upper Silesia could not be brought into harmony by frank discussion. Britain wanted an early meeting of the Supreme Council. France held that before the Supreme Council made its decision on Upper Silesian partition questions, allied troops should be reinforced so as to preclude the possibility of that decision being disputed by the local populations or, as the French plainly suggested, by German volunteer forces.

The British idea was that trouble, if there was trouble, would be more likely to arise from Polish dissatisfaction with the decisions of the Supreme Council, but on the whole it was held here to be improbable that there would be any serious opposition. Free and frank discussion of the problem was, it was thought, calculated to clear the air.

The French note received this morning put a different complexion on the affair. It was couched in language which London has not been accustomed to hear from Paris.

A Cabinet Council was summoned. The Dominion Premiers were invited to attend, seeing that their countries had valorously responded to the call which went forth to the world when German militarism menaced the continent of Europe. The Dominion Premiers were of one mind with regard to the present situation, where a new militarism threatens the continent. The British Empire will not march with France if it is a question of creating in Europe a new régime of force.

**COUNCIL MEETING ON AUGUST 8.**—The difficulties of the Allies were finally settled by agreement upon a meeting of Supreme Council on August 8. France in the meantime promised not to send reinforcements to Silesia without the consent of the Allies, and Germany, in response to an Allied note of Aug. 3, agreed to permit the transport of troops across Germany upon the joint request of the three Allied European powers.

## GERMANY

LIGHT PENALTIES AT LEIPSIK TRIALS.—Following the protest and withdrawal of French representatives early in July, the Leipsic Court continued the trial of war criminals accused by Great Britain and Belgium. The Belgian Government expressed great dissatisfaction at what was regarded as the complete travesty of justice in the proceedings. In the British press the view was expressed that, considering the unprecedented character of the trials, the light penalties were not to be regarded as wholly inadequate or without moral effect.

PEACE NEGOTIATIONS WITH UNITED STATES.—It was announced in Washington on July 19 that the American Commissioner in Berlin had been requested to make inquiries of the German Government as to a suitable method of reopening diplomatic and commercial relations. A proclamation of peace by President Harding, according to press reports, was regarded as an appropriate first step. Such a proclamation, it was thought, would have no effect in restoring German property seized in America, at least not without further action by Congress.

## GREAT BRITAIN AND IRELAND

IRELAND CONSIDERS BRITISH TERMS.—In accordance with previous arrangement, Mr. Lloyd George and Mr. Eamon de Valera met in London on July 14, to discuss possible terms for a settlement of the Irish question. Later conferences were attended also by Premier Craig of Ulster, who left London, however, on July 18, stating that Ulster would insist upon a status separate from southern Ireland.

Mr. de Valera on July 21 was given a brief written statement, said to contain not more than nine or ten heads, setting forth the definite proposals of the British Government. It was understood that these offered substantially self government for Ireland similar to that of Canada and South Africa, with only reservations of a naval and military character due to the closeness of Ireland to the center of the Empire. Upon his return to Ireland Mr. de Valera submitted these terms to Sinn Fein leaders, by whom in subsequent weeks they were given close scrutiny. British papers stated on Aug. 2 that the terms would probably be acted upon by a full meeting of the Dail Eirann, or Irish National Assembly, for which purpose the 36 members of that body in prison would be released. Upon his return to South Africa, General Smuts wrote to Mr. de Valera strongly approving the British offer and urging its acceptance:

The *Daily Chronicle* commenting this morning (July 23) on the report that the British offer of dominion home rule to Ireland reserves control of the army, navy and air force in Ireland, says the reservation "corresponds to geographical necessity which renders it necessary for the strategic defense of the British isles to be planned, controlled and maintained as a whole. We have difficulty in believing that it should offer any stumbling block to intelligent Sinn Feiners who except from directly anti-British motive could have no ground to prefer a petty Irish army and navy under separate control."

The outstanding crux of the problem, *The Chronicle* goes on, seems still to be in the relations of southern Ireland and northern.

"If southern Ireland," it says, "gives up the idea of controlling northern Ireland by force to enter a single Irish polity there can be peace to-morrow on the broadest basis of liberty for South and North alike and with the fairest hopes of their eventual voluntary reunion. If on the other hand counsels of force prevailed, not only would the immediate hope of peace vanish, but ultimate mutual reconciliation of North and South would be pushed away into far remoter future."

**BRITISH NOTE ON OIL RESTRICTIONS.**—A final British memorandum on the control of oil in all British dominions was sent to the United States Government on April 21 and published on July 5 in a British White Paper. The memorandum states that Great Britain is second only to the United States and (in normal times) Russia in oil consumption, 90% of her navy being at present oil fired, her imports of oil in 1920 amounting to 3,368,000 tons, of which 68% came from the United States and a total of 98% from foreign countries. In Canada and Trinidad oil concessions are restricted to national companies, and the same is true in Egypt, but elsewhere throughout the British Empire, according to the memorandum, there are no handicaps on foreign concerns. Of the Mesopotamian and Palestine mandatories, it is said that "while there was no intention of discriminating against non-British interests, account must be taken of legitimate rights acquired by British companies before the war." The memorandum points out that the United States is taking a chief share in the development of Mexican oil fields and is sure to play a leading part in the opening up of Central and South American fields.

## RUSSIA

**SOVIET WILL DISREGARD CONFERENCE ACTION.**—Riga, Latvia, July 22 (Associated Press).—Soviet Russia's note of protest against the failure to extend her an invitation to the Washington conference on Far Eastern questions, handed to the American Chargé at Stockholm yesterday, declares that the Moscow Government will not recognize any decisions reached at a conference at which it is not represented.

The note, which was signed by M. Tchitcherin, the Soviet Commissary for Foreign Affairs, protests also against the lack of an invitation for the Far Eastern Republic. The Soviet Government reserves complete freedom of action, it declares.

The Soviet note was sent not only to the United States, but also to Great Britain, France, China and Japan.

**RELIEF CONDITIONED ON RELEASE OF PRISONERS.**—In response to the appeal of Maxim Gorky of the Russian famine relief committee, Herbert Hoover as head of the American Relief Association sent a note on July 25 declaring that American relief in Russia would be granted only upon the release of all American prisoners and the fulfillment of other conditions. For the purpose of securing a written agreement to this effect from the Soviet authorities, Mr. W. L. Brown, the European Director of American Relief, started for Riga on July 31. It was calculated that the American relief body could care for 1,000,000 starving children and invalids.



A demand for the release of American prisoners was also made by Secretary of State Hughes through the American Consul at Reval, as follows:

"The American Government is advised that, despite the repeated efforts of Dr. Nansen on its behalf to secure the release of the American prisoners in Russia, they are still held in a most serious plight.

"In the name of humanity the American Government demands of the Soviet authorities that these prisoners be at once released. It is manifestly impossible for the American authorities to countenance measures for relief of the distress in Russia while our citizens are detained."

**PRISONERS RELEASED.**—The Soviet Government issued several statements to the effect that it had made no appeal for aid. On August 6, however, it was confirmed that the 7 or 8 American prisoners held at Moscow had been released and would at once be sent across the border.

**RUSSIAN FAMINE CONDITIONS.**—A statement issued by the U. S. Department of Commerce on Aug. 1 declared that the famine in Russia was most acute in the Volga valley north of the Caspian Sea, but that production in various parts of Russia had been cut down 50% or more. The total grain production for Soviet Russia in 1921 will be 4,320,000 bushels, as against 7,614,000 in 1920, and the potato and oil seeds crops are cut in half. In northern Russia the shortage of food is chiefly due to the general decadence of agriculture and the breakdown of transportation from the south and east. "Industry in general has decreased over 90 per cent."

## ITALY

**PROPOSED PAPAL STATE.**—Rome, July 17.—On the eve of the reopening of the Chamber when the Cabinet will present its program to Parliament the possibility of settling the vexed Roman question seems even nearer than with the former Cabinet. In the new Administration the Catholic Party has great influence, there being three Ministers and several Under Secretaries of State belonging to that party. One of the most important portfolios is entrusted to a member of the Catholic Party, the Ministry of Justice, which deals with all relations between Church and State and has under its jurisdiction all ecclesiastic affairs.

Many say that question might be solved according to the plan suggested by Cardinal Bourne, according to which the Pope would receive a tract of land on which he would have all rights and prerogatives of a king. The Cardinal stated that many lords and land owners in England possess large estates where they practically reign supreme. Why should not the Pope be treated in like manner?—*N. Y. Times*, 17 July, 1921.

## BALKANS AND NEAR EAST

**BALKAN ALLIANCE AGAINST GREECE.**—Paris, July 10.—A sudden change in the Near Eastern kaleidoscope has switched the center of interest from Asia Minor to Thrace. The cause of the trouble is a Turko-Bulgarian plot to evict the Greeks from the territory north of Constantinople allotted to them by the Treaty of Sèvres.

It is learned from a trustworthy source that it is anxiety about this region, far more than fear of a Turkish advance upon Constantinople from Ismid, that motivated the British naval concentration at the Turkish capital and the troop movements reported from Malta. Assurances of

Bulgarian support also are said to be the reason Mustapha Kemal suddenly imposed impossible conditions for a meeting with British representatives which he himself had requested a few days before.

It is a matter of common knowledge in the Near East that both the Turks and Bulgars are bitterly dissatisfied by the attribution of Thrace to the Greeks. The former claim that it puts their capital at the mercy of a hostile advance and the latter that it imposes an intolerable hardship by cutting them off completely from the sea. Accordingly, both parties have been intriguing most busily the last weeks. The quarter in which their activities have been directed has been Serbia, which not only possesses the best fighting force in the Balkans, but is inspired by keen personal hostility to King Constantine and the schemes he is believed to entertain to dominate Constantinople.

Between the Serbs and Bulgars Macedonia has always been a bone of contention, but months ago the Bulgarian Foreign Minister, Dimitrioff, paid a visit to the Serbian capital to propose a solution of the problem. The plan suggested was that Macedonia should become an independent State whose port-way capital should be Saloniki. Nor was this all. Serbia and Bulgaria, both of whose nationals bulk large in the Macedonian population, should form a sort of triple confederation with the new State—perhaps actually a federation under one central government. In either event there was to be no tariff barriers between the three neighbors, and thus Bulgaria would obtain the free access to the sea which she so ardently desires.

Evidently this plan, which is reported to have found high favor in Serbian eyes, could only be carried out at the expense of the Greeks. It was therefore found desirable to enlist the support of the Turks by offering them Adrianople and Eastern Thrace.—*N. Y. Times*, 10 July, 1921.

**SUCCESSFUL GREEK OFFENSIVE AGAINST TURKS.**—The Greek offensive against Turkish Nationals in Asia Minor, which was started in the middle of July, resulted in a general pushing back of the Turkish forces. It was reported on July 26, but apparently without foundation, that Mustapha Kemal had made peace overtures through the Allies. The Turkish losses at that date were said to amount to about 60,000 killed, wounded, and prisoners.

#### LATIN AMERICA

**PANAMA APPEALS TO ARGENTINA.**—Following Panama's appeal to Argentina and other South American states in the matter of her boundary dispute with Costa Rica, the U. S. Government on July 18 addressed a memorandum to Argentina setting forth its reasons for considering the White award binding, and the duty of the United States to see that Panama fulfilled her international obligations. Panama in a note to the United States made public on July 25 urged that her dispute be referred to the Hague Tribunal.

**MEXICO INVITES CLAIMS DELEGATES.**—Mexico City, July 13 (Associated Press).—All countries whose nationals have suffered damages from Mexican revolutions have been invited by President Obregon to appoint delegates who will meet Mexican representatives and form a permanent commission to pass upon claims. The invitation was issued in the form of a Presidential decree promulgated last night, and it will be sent to all interested nations by the Foreign Office.

President Obregon's decree is regarded in official circles here as a most important step in the President's reconstruction program and as indicating

a sincere desire on the part of the Government to set Mexico's house in order.

The Mexican Claims Commission has made no recent announcement of the amount of the claims filed with it, but late last year the total was given as more than 32,000,000 pesos, of which more than 20,000,000 pesos represented claims for foreigners.

Tampico, July 13 (Associated Press).—Resumption of operations in the Tampico district by oil companies is expected in official circles here. Drilling permits are being granted daily by the Government, and some companies have continued work during the past troublesome month without discharging a single man. It was declared yesterday by a Government official that the situation here was not a local problem, but was the outcome of world conditions. He said that the new taxes placed on petroleum exports had but secondary influence on operations in this district.

General Arnulfo R. Gomez, commander of the Mexican military forces in the oil region, expressed regret yesterday that the United States cruisers *Sacramento* and *Cleveland* sailed from Tampico, as he had planned to entertain the officers of the warships, with whom he had a cordial meeting.

The General further stated he was fully prepared to protect the lives and interests of North Americans, as well as those of any other nationals.

## REVIEW OF BOOKS

---

"The Plattsburg Movement: A Chapter of America's Participation in the World War." By Ralph Barton Perry. pp. X, 275. Price \$2.50. (New York: E. P. Dutton & Co.)

"The book," says the author, "is primarily an account of one of the aspects of America's preparation for war." As most people know, while the National Government in 1915 and 1916 was still holding—as many believed, fatuously—to the idea that America could keep out of war, those interested in the Plattsburg camps, led by General Wood, were doing their best to prepare for what they believed was inevitable. And as some people also know, there was a close relationship between the Plattsburg camps and the Officers' Training Camps which came into existence upon America's entrance into the war. But few, it is safe to say, are aware that out of 20,000 men who attended the Plattsburg camps 1913-1916, no less than 18,000 when the crisis came entered the Army or Navy, nearly all as officers; and still fewer know that it was the Military Training Camps Association, comprising the men who had been interested in and attended the camps previous to 1917, that rushed to the support of the Army staff officers and others upon whom devolved the organization and recruitment of the Officers' Training Camps, 1917. Haste was imperative, yet the General Staff had no detailed plans in readiness, and it was without the personnel required for organizing the camps. The Military Training Camps Association was busy everywhere. Its most effective co-operation was in the East, and yet what it did in the Central Department is shown by the following:

"When the camps were announced the Department Commander, General Thomas H. Barry, found himself without funds and without the necessary recruitment personnel. He telegraphed to Washington without result. Thereupon the Training Camps Association obtained from business offices in Chicago seventy clerks and stenographers, with the necessary desks and typewriters. Within eighteen days over 75,000 applications were received in the various headquarters of this Department alone."

When the second series of Officers' Training Camps was ordered in June, 1917, the War Department turned over to this civilian organization, the Military Training Camps Association, the entire charge of the printing and distribution of 250,000 copies of the circular of announcement and application blank. It is not strange that those attending the first and second Officers' Training Camps voted unanimously to join the Military Training Camps Association. The work of the Training Camps Association soon became national, and local committees were organized through the efforts of Departmental and Divisional headquarters in 1300

cities, and nearly 900 of these were engaged in active work on the date of the Armistice.

As a complete record of the work of the Military Training Camps Association Professor Perry's book leaves nothing to be desired. The author gives with careful detail the numbers attending each camp, the official letters, the resolutions, and the legislation attempted and secured.

Yet the book brought to the writer of this review, who attended the Plattsburg camp of September, 1916, a feeling of disappointment. The Plattsburg Movement was more than figures, letters, resolutions, and statutes. It was chiefly men, who though keenly alive in their own profession or business, were as awkward as the greenest West Point or Annapolis plebe when thrown into a military organization. No one realized this more than they did. In moments of relaxation they bubbled over with merriment on recalling their blunders. Yet they realized that if war should come it was out of such material that officers must be made. And they surprised the regular officers in charge of their instruction by the terrific earnestness with which they threw themselves into their new life, going it hard all day long and not infrequently volunteering for drills in the evening and on Sundays. Of this the book says next to nothing.

The book fails because it gives the statistics but not the spirit of Plattsburg. It gives the history of the Military Training Camps Association, but not of the Plattsburg Movement in a large sense, to quote the sub-title, as "A Chapter of America's Participation in the World War." Thus it frequently makes mention of Mr. Grenville Clark, President of the Association, and Mr. Arthur F. Cosby, Executive Secretary, as well as other officers. But what of the men who attended the first series of Officers' Training Camps, two of whom were commissioned colonels, 235 majors, 3,722 captains, etc.? Who of this number distinguished themselves in action and received merited decorations? There is assuredly no test of a splendid organization, like that born at Plattsburg, equal to that of actual service in the field and at the front. Yet not a single career, nor a single name is here given. And the inspiration that comes from a simple record of those who proved themselves ready to give their all, and of some who made the supreme sacrifice is absolutely lacking.

C. S. A.

"Sea Power in the Pacific." By Hector Bywater. Price \$5.00. (New York: Houghton, Mifflin Co.)

(Editor's Note:—It must be remembered that the opinions and remarks contained here are not those of the reviewer. His effort has been simply to reduce a volume of some three hundred pages to a form in which its essential points may be easily grasped, and he has endeavored throughout to reproduce the ideas and opinions of the author, Mr. Bywater.)

This, the most important recent estimate of the situation in world politics which concern the Pacific, an excellently detailed account of the naval power and the capacity for carrying on war of Japan and the

United States, has just come from the press of the Constable Company in London. The author is a very prominent writer on naval and international subjects in England, an associate of the Institute of Naval Architects and will need no introduction to those familiar with his frequent articles in *The Naval and Military Record* and *The Engineer*. His regular contributions to these papers are noted for their detailed accuracy and his estimates and figures in the present volume may be expected to be of the most dependable sort. The book is remarkable for the extent to which the author has investigated the data for his conclusions and the accuracy he has attained in his search. Probably no time could be more opportune for its arrival than that immediately preceding the disarmament conference, which has every likelihood of becoming a world event of the first importance.

In the opening chapter the author calls attention to the complete alteration in the political and military outlook which has occurred since the German fleet surrendered at Scapa Flow. The world in general, and Great Britain in particular, has become used to regarding the North Sea as the center of gravity of international consideration and the necessity now exists of schooling those unacquainted with the rapid alteration of international affairs to the view that the center of interest has become definitely lodged in the Pacific, and that all other questions of an international nature are distinctly subordinate to those which may lead to trouble in the Far East. The elimination of all actual competition in Europe has left Great Britain in a position to organize her naval policy on lines that are of Imperial instead of local importance, and in the author's discussion of this relief from European competition at sea, it is astonishing to find that so short a time ago as 1900 the French were the possessors of the Navy against which the English most guarded. That is but 21 years ago, and since then the Russian fleet has come up and gone down, the German fleet rose to be the second of importance in the world and now ceases to exist, and the French fleet has sunk, both relatively and actually, to an inferior position.

Previous to the war, a fever of battleship building swept over Europe. It began with Germany's bid for sea power. As she continued to enlarge her navy, so Great Britain took extra strides to remain comfortably ahead of her. Under the promptings of the Germans the Austro-Hungarians took in hand the construction of heavy men-of-war and the Italians followed suit, having in mind the possible opposition of the Austrians and also, as one of their premiers expressed it, the intention of making Italy a most desirable ally in case one were required. Alarmed by the Italian expansion and not unaware of the threat which the German navy made to her channel ports, the French also joined the race and even Russia, in 1908 and 1909, surprised the world by the extent of the naval program to which she gave her attention. Likewise, Turkey and Greece and the smaller nations took to building ships, until the period between 1900 and the outbreak of the Great War saw what was undoubtedly the greatest era of warship building in the history of the world.

Now the reasons for the maintenance of large European fleets have ceased to exist. Austria is no longer a power; the German strength on the sea has been reduced to impotence; the Turkish naval force was surrendered at the conclusion of her participation in the war and France, prevented by reasons of economy from maintaining herself among the first navies of the world, has adopted a program apparently aimed at assuring her naval superiority in the Mediterranean. Were Great Britain forced to consider only her home islands, she could reduce her navy even farther than she has already done, but the Imperial Conference in London has made evident to the public what was long ago very plain to diplomats and military people, which is, that she must be prepared for active defense of any of her dominions and possessions. This means that questions which concern Canada and Australia and New Zealand and Hongkong and Singapore are matters of the first importance to her, and are demanding reasons for the maintenance of her force on the water. It has become an axiom of British statesmanship that the defense of the Empire means the defense of the lines of communication, and she may be depended upon to go to any means to insure these being kept in her hands.

In the first chapter the author goes into a comparison of the British and American navies as they will exist in 1924, or when our building program is completed. He compares the *Royal Sovereign*, as the best type of British ship in their possession at present, with our new *Indiana*, and with the following results: *Royal Sovereign* displaces 25,750 tons, being thus somewhat smaller than our *Nevada* class. She has a speed of 22 to 23 knots and carries eight 15-inch guns, fourteen 6's and four torpedo tubes. Her thickest armor, 13 inches, is over the water-line and the main gun positions. Her full broadside amounts to 15,360 pounds. Our new *Indiana* is to displace 43,200 tons, her designed speed is 23 knots. She is to carry twelve 16-inch and sixteen 6-inch guns and will have two torpedo tubes. Her maximum armor will be 16 inches and her broadside weight 25,200 pounds. From any viewpoint the supremacy of the *Indiana* is overwhelming.

The *Hood* is also compared to our *Lexington* class of battle cruiser, to her disparagement. The British ship displaces 41,200 tons with a speed of 31 knots and an armor of eight 15-inch and twelve 5.5-inch guns. Her broadside weight is 15,360 pounds. The *Lexington* is to displace 43,500 tons with the designed speed of 33 knots and an armament of eight 16-inch and sixteen 6-inch guns, with a broadside weight of 16,800 pounds. Mr. Bywater calls further attention to the fact that the disparagement is more than appears from the figures, due to the superiority in effect of the 16-inch 50-caliber gun over the 15-inch British gun of 42 or 45 calibers.

The relative condition of the navies of Great Britain and the United States in 1924 (providing the former does not construct any more battle-ships, but will turn out 4 battle cruisers of the *Hood* design, and providing also that the United States completes her 1916 building program), is detailed at length, but with an apology to the author, I will regroup the ships here in the characteristics which the United States Navy has des-

igned for vessels of the first class. In 1924 this condition will be as follows:

	Great Britain	United States	Japan
Battleships, 1st line.....	*23	†21	†12
Battle cruisers, 1st line.....	*10	†6	†12
Light cruisers, 1st line.....	45	10	19

\* 13.5-inch guns or better. † 14-inch guns or better.

#### GROWTH OF THE JAPANESE NAVY

The increase of naval expenditure in Japan since the Russo-Japanese War is shown to have been very rapid. The appropriations for 1906 were three times their amount in 1905 and thereafter the curve of expenditure mounted steadily. "Due to the peculiar budget methods practiced in Japan it is extremely difficult to total the various appropriations for naval service," but in 1918 the total was estimated at \$125,000,000, a 30 per cent increase over the previous year.

In 1920 a sum of \$250,000,000 was asked for the navy. In the discussion in the *Diet* in July 1920 concerning the new program, the Minister of Marine informed the members that the building list for which he was preparing involved 4 battleships, 4 battle cruisers, and 12 cruisers and smaller craft, for which the cost would be \$340,000,000, which expense, however, was to be spread over several years. No other nation to-day is spending any such proportion of her income upon national defence as are the Japanese. They are aiming at the creation of what they have long called their "8:8:8 Fleet" and that means 8 battleships and 8 battle cruisers of the largest and strongest type, none of which are more than 8 years old, and it is apparent that this will be a most homogeneous and powerful force of vessels, able to overmatch another force superior to it in numbers, but inferior in the fact that its units are less uniform in power, design and age.

Before the American Pacific Fleet was created the Japanese were in undisputed superiority in the Pacific. Following the Anglo-Japanese agreement, the British withdrew their heavy fleet from Chinese waters and took it to the North Sea where it was needed to protect them against the Germans. Recently a very modern and effective British Fleet has made its appearance in the Far East, headed by the *Hawkins*, a large, fast, armored cruiser, completed in 1919 and carrying seven 7-inch guns. She leads a force composed of 4 light cruisers, each of 5000 tons displacement, and a submarine flotilla of 12 British "L" boats. All of these vessels are of the latest and most effective classes. There is also a force of 5 mine-sweeping sloops and the usual equipment of gunboats in the Chinese rivers. The Americans are represented in the East by a squadron distinctly inferior to those of the Japanese and the British, and Mr. Bywater assumes that the first step in any trouble between the Japanese and the Americans will be the complete destruction of our vessels there, who have neither the armament to stand and fight, nor the speed with which to run away.



## DOMINION FORCES

The recent discussions in London during the Imperial Conference made it evident that the British scheme of naval defense considers the formation of local squadrons by each of the dominions, these forces to have sufficient strength to guard their own harbors and to take care of sudden forays upon their local lines of communication. The heavy British Fleet is to move into whatever quarter of the world it is required for the defense of The Empire. In this regard, the Australians have a force composed of the battle cruiser *Australia*, 5 light cruisers, a destroyer leader, 11 destroyers and 6 large modern submarines of the British "J" type. New Zealand maintains only one light cruiser in operation: the *Chatham*. The invitation to maintain the battle cruiser *New Zealand* in her home waters was declined on the ground of national economy. Canada, farther north, keeps in commission the light cruiser *Aurora*, 2 destroyers and 4 small submarines of a strength about equal to our "K" boats. In this connection Lord Jellicoe, after his tour of the British Dominions with a view of analyzing the naval situation, submitted a scheme for the maintenance of a Far Eastern Fleet, to be composed of the vessels of the Royal Navy, the East Indian Squadron and the Australian, New Zealand and Canadian forces. He recommended that its strength should be 8 modern battleships, 8 battle cruisers, 10 light cruisers, 40 destroyers, and 36 submarines, whose total cost of maintenance per year was projected at \$100,000,000, of which sum the dominions would be expected to contribute three-fifths.

## THE GROWTH OF ILL FEELING IN THE PACIFIC

In chapter two there is taken up in detail the whole matter of the friction between the Japanese and the people of the United States. Previous to the Spanish-American War the relations between Japan and America were of the warmest, but with our acquisition of the Philippines and Guam and Hawaii, there arose a distinct antagonism from the Island Empire. Various subsequent questions, mainly those dealing with China and immigration, have combined to supply material for trouble makers on both sides of the Pacific. The idea of territorial propinquity which may have brought out the Japanese protest concerning the Philippines could hardly be expected to operate in the case of Hawaii, which is 4400 miles away from Japan, and her protest over America's occupation of that group of islands led many observers to conjecture that she planned for herself the supreme dominion of the Pacific and viewed with alarm the passing of any of the islands into the possession of another country.

The immigration question in California is treated in full, but this matter has been so thoroughly done for the American public that it is not thought necessary to review the affair here, except to point out that one of the main objections to the presence of the Japanese is the fact that their low wage standard deprives American workmen of employment and that our Government will have the distinct backing of the American labor forces in any opposition they may raise to continued Japanese immigration or to

the maintenance of the Japanese workmen which are at present in this country.

Probably less well known to the American public however, are the discriminatory actions which the Japanese practice against foreigners in their own country, the same ones in a great many cases to which they object when operated on their own nationals abroad. For example, Japan does not allow foreigners, as individuals, to acquire landed property in the islands; they cannot become owners of ships flying the Japanese flag and such interest as they may attain in ship concerns is subordinate by law to Japanese control. Foreigners may not hold stock in national, agricultural or industrial banks, nor engage in mining operations, nor become members, shareholders, nor brokers of the exchanges, nor members of the Chambers of Commerce. They may not hold public office of any kind nor become members of the Japanese bar. Foreigners are not permitted to enjoy the franchise in Japan; they cannot engage in agriculture; foreign physicians and surgeons cannot practice in the country unless they have passed an examination in the Japanese language, both written and oral, before a board composed of native doctors. Under Japanese laws rebates may be granted by Japanese steamship companies on all goods belonging to Japanese merchants, by means of which they are enabled to undersell foreign competition, and Mr. Bywater states that it is recorded that the cases of litigation between foreigners and natives heard before Japanese courts have always shown an overwhelming proportion of judgments in favor of the Japanese. Regarding the questions of immigration, the Japanese maintain against the Koreans and Chinese precisely the same wall which the Californians wish to erect against them, and for exactly the same reasons. Chinese laborers are debarred from Japan on the grounds that they have a lower standard of living and that their participation in labor with the Japanese workmen will introduce unfair competition, and Korean workmen are permitted in Japan only under conditions which will protect the Japanese workman.

#### THE OPEN DOOR

The growth of this policy is very distinctly traced. In 1900 Russia took advantage of the Boxer Insurrection to move her troops into Manchuria and upon the termination of that trouble she neglected to leave. From that time on the Japanese prepared to bring the matter to the decisive point which they foresaw would have to be met, and this eventuated in the war of 1904 and 1905, from which they emerged a brilliant victor. The items of the peace treaty pledged both parties to leave Manchuria except in the case of the Liao-Tung Peninsula, where Japan succeeded to the rights which were formerly in the possession of Russia. Otherwise the administration of Manchuria was to go back into Chinese hands. It appears, however, that Manchuria simply changed one owner for another, for in succeeding years the Japanese secured from the weak Chinese Government concession after concession, allowing them to extend their railways throughout Manchuria with the result that the whole district came under their control. Foreign trade was admitted only upon conditions

which would not injure the sale of Japanese wares and this Japan was able to do because she controlled the sole means for distribution in the province. With an eye to preventing possible competition, Japan concluded with China an agreement whereby the latter renounced the right to build any railway in the regions transversed by the South Manchurian line (Japanese) or of granting concessions to anyone else to build other railways in the district served by the Japanese lines.

The author states that no positive action was taken in the matter of the gradual spread of Japanese supervision until 1908, when the American Government proposed "to guarantee to China the integrity of her Manchurian province by neutralizing the South Manchurian railway." It was proposed to lend China a hundred million dollars with which to repurchase the railway. This money was to be raised by a loan, jointly subscribed to by various powers, and not by the United States alone. The Japanese objected to this suggestion with such warmth that an alternative scheme was suggested, providing for the construction of a line to parallel the South Manchurian Railway and to destroy its monopoly in transportation. Mr. Bywater remarks that the only reason that an international crisis did not develop at this time was that the English bankers, who were to participate with the American bankers in backing the loan to China, withdrew from the agreement.

#### THE TWENTY-ONE DEMANDS

In 1915, when the world was concerned with the Great War, Japan suddenly presented to China her famous 21 demands. These related to Shantung, the Yangtse Valley, Fuhkien Province (on the mainland opposite Formosa), South Manchuria, and Eastern Inner Mongolia. Some of the 21 demands were communicated to the other nations of the world, but the most serious of them were concealed and China was warned not to make them public. They did become public, however, and were of a nature so broad and imbued with such an assumption of supervision on the part of the Japanese that they were received everywhere with distinct opposition and the great powers moved to secure their withdrawal. The secret articles of the Chinese Note were as follows:

"(1) The Chinese Government shall employ influential Japanese advisers in political, financial, and military affairs.

"(2) Japanese hospitals, churches, and schools in the interior of China shall be granted the right of owning land.

"(3) Inasmuch as the Japanese Government and the Chinese Government have had many cases of dispute between Japanese and Chinese police, the settlement of which caused no little misunderstanding, it is for this reason necessary that the police departments of important places in China shall be jointly administered by Japanese and Chinese, or that the police departments of such places shall employ numerous Japanese, so that they may at the same time help to make plans for the improvement of the Chinese police service.

"(4) China shall purchase from Japan a fixed amount of munitions of war (say 50 per cent, or more) of what is needed by the Chinese Govern-

ment, or there shall be established in China a Sino-Japanese jointly operated arsenal. Japanese technical experts are to be employed and Japanese material is to be purchased.

"(5) China agrees to grant Japan the right of constructing a railway connecting Wuchang with Kiukiang and Nanchang, another line between Nanchang and Hanchow, and a third between Nanchang and Chaochou.

"(6) If China needs foreign capital to work mines, build railways, and construct harborworks (including dockyards) in the province of Fuhkien, Japan shall be first consulted.

"(7) China agrees that Japanese subjects shall have the right of missionary propaganda in China."

In 1918 Japan induced China to enter into an agreement for common military and naval defense. It provided for their military co-operation, standardization of their war plans, their transport systems, their communications and military codes. It was written into the proposal that the agreements and stipulations contained in it should not be published either in Japan or China, but should be treated as a naval secret. This agreement was to terminate upon the conclusion of peace between the Allies and Germany, but in the autumn of 1920 the Peking Government is reported to have requested the Japanese to remove the troops in China which they had installed there under the pretext of the articles of the agreement. The author draws the conclusion that the action of Japan in China during the last twenty years leads to but one interpretation and that is that she is determined to secure all of the great native wealth of that empire to herself and to prevent the competition of any other nation if this can possibly be accomplished.

The efforts of the Chinese Consortium—a group of British, French, and American bankers—to induce the Japanese bankers to participate in the loan to China under a policy of mutual rights as distinct from that of individual monopolies, were met originally by great opposition on the part of the Japanese, who claimed that it was their right to develop the railways in Manchuria alone, and to refuse interest to any other power concerning their supervision. However, the efforts to come to a mutual understanding among the bankers are said to have met with distinct success and the British and American members have come home to compliment the Japanese upon their willingness to agree with them. Mr. Bywater has his own opinion concerning this, however, and expresses it as follows: "Exactly how far this scheme of joint financial control over the economic development of China will extend is not yet clear; but that Japan seriously intends to concede the principle of the equality of international interests in that country is difficult to believe in view of her past record. Such a concession would be absolutely opposed to the policy she has consistently followed since 1905, and it is possible that international finance takes too sanguine a view of the future."

#### THE POWER BEHIND THE THRONE

In describing the background against which the foreign policy of Japan is based, the author calls attention to the composition of the Japanese

electorate and of the Government. Japan has the outward appearance of a constitutional state whose institutions are modeled upon those with which we are familiar. As a matter of fact, it is remarked that the people have no real voice in other than purely domestic affairs and that in the Diet, which consists of an upper and a lower house, there is very little actual executive authority, and like the old German Reichstag, it comes closer to being a debating society than the principal feature of the executive branch. In the last forty years the Diet has been dissolved by the Emperor eight times for resisting and disagreeing with the government program. The real power is said to center in the *Genro*, or Elder Statesmen, whose number is given as five. It is generally assumed that all the outstanding features of Japanese policy are developed by this small body of powerful men and they are credited with the Japanese seizure of the Korean court and government in Seoul in 1894, of which action the Chinese War was the direct result.

The strength of the Japanese in the past has been that one which has stabilized all the old empires, and that is ignorance; the fact that the people were so poorly educated and so narrow in their experience with other nations that there was no considerable opposition to the theory that the emperor or king was divinely appointed and that the highest type of performance as a citizen was to blindly follow his wishes. As in every country in the world, the growth of popular education has brought on disturbances which have as their result the increasing independence of the private citizen and, since only a certain amount of authority can rest anywhere, the result has been a reduction of power in the hands of those who formerly held it all, and that is the nobility. There has been severe agitation for the extension of the franchise in Japan for the last 20 years and demands for a more powerful voice in the determination of government affairs have increased remarkably since the World War, so much so, that a series of ruinous strikes have lately occurred in the country and recent newspaper despatches from Japan tell of several of the large shipyards being in the hands of the workmen, with rampant indications of a socialism verging strongly upon the Russian sort.

#### THE CURE FOR LOCAL DISCONTENT

In 1894 Japan was in the midst of great unrest due to the increase of local taxation, and the China war, occurring either by fortune or by design at that time, brought all parties in the country to an enthusiastic concord. Just preceding the Russian War a similar condition existed in Japan and Mr. Bywater calls attention to the fact that discontent and the demands of the common people have never been so strong and insistent as they are at present; that a diversion of the people's minds from their local trouble has been persistently accomplished in the past by getting them excited over some question outside the country and that this maneuver is taking form at the present time in violent newspaper attentions to every event which may be interpreted as an unfriendly American action toward the Japanese. He leaves the conclusions to the reader.

It is interesting in the discussion of the expense of construction to see that Americans have been generally mistaken in the widely-held impression that our vessels cost us more than those built abroad. He finds that we have uniformly built ships similar to the British vessels at a cost slightly less than theirs. The *Utah* of 21,825 tons, and costing £1,701,100 is compared with the *Colossus* of 20,000 tons, built the following year at a cost of £1,730,000. So the battleship *Texas* of 27,000 tons cost less than the *King George V* which is 4000 tons lighter. The *Pennsylvania*, 4000 tons heavier than the *Queen Elizabeth*, cost about £100,000 more than the British ship but the *Pennsylvania* was built two years after the *Queen Elizabeth* went on the stocks.

The author goes thoroughly into the question of dockyards for the cleaning and repairing of large men-of-war and in this he finds us particularly crippled for operations in the Pacific. Lord Jellicoe called attention to the fact, in a speech after the War, that a graving dock is not a very spectacular affair; that no smoke comes out of the stack and no bow wave goes up from the front, but that one of them is distinctly more important to a fleet than any floating unit could ever be, and lasted longer and cost less to make. It is quite natural, however, and it is the case, that this very lack of being spectacular has prevented the popular mind from being easily attracted toward it, whereas it is not so much of an effort to canvas votes for a battle cruiser or some fast destroyers.

Concerning the Pacific docks, the title of the "Premier Yard" is given to Mare Island. Attention is called to the fact that the dredgers must be kept continually at work to make it available for the new ships. The developments at Bremerton are spoken of and there is mention also of the plans for a first class fleet base in San Francisco Bay, and the destroyer, submarine and aircraft stations at San Diego, San Pedro, at Tongue Point (on the Columbia River) and at Ediz Hook (State of Washington), but the whole Pacific dock equipment is said to be distinctly unable to respond to the demands which active service would put upon it. Going to the insular possessions in the Pacific, the question of dry docks is shown to be even less well provided for. In the whole of the Pacific as distinguished from the mainland of America there is but one dock capable of taking a dreadnought. We have at Pearl Harbor a new dock, a thousand feet long and 138 feet wide at the entrance. The only other docks which exist are at Cavite and Olongapo and these would be of no use to a modern heavy ship.

Hawaii is called the "Key to the Eastern Pacific," and with this, and a base in the Alutian Islands and one in the Canal, the strategy of that portion of the ocean is assumed to be well taken care of. This is particularly so as the distance from Japan to the American coast renders an active attempt to make a frontal attack with troops beyond the bounds of probability, and it is assumed that even light raiding forces would not be exempted from constant danger in the Eastern Pacific, excepting, of course, in a case of long-range, modern submarines.

The Board of Inspection which visited Pearl Harbor in 1919 reported that the docking, repairing and magazine accommodations would be entirely

insufficient for the needs of the Pacific Fleet in time of peace and even more insufficient if the whole American Fleet were gathered here for an offensive purpose. The proposals for improvement included building two concrete piers, 1800 and 1000 feet long respectively, a large foundry, machine and boiler shops, magazines, an oil fuel depot and a harbor railway; the building of another dry dock similar to the present one; the development of complete submarine and aviation bases and the dredging of a sufficient area in the present anchorage to allow for the comfortable berthing of eight dreadnoughts. It was also advised that the Government co-operate with the civilian authorities of Honolulu to develop the merchant harbor there in order that it might be utilized in time of war. In reviewing the extensiveness of these improvements, Mr. Bywater remarks that *they are matters of really primary importance, that they are much more in demand than a new battleship would be, that they would add more tactical efficiency to the fleet than a whole division of battleships, and that all the alterations together would cost less than one such vessel.*

#### GUAM

The real burden of the author's review of all the elements in the situation is that Guam is the most important of our possessions in the Pacific, with the possible exception of Hawaii, and that even if Hawaii were secure beyond any threat, its possession alone would in no way insure our ability to maintain our position in the Philippines or in any of the waters within several thousand miles of Japan. It is apparent that since Honolulu is 4400 miles from the Japanese coast our fleet could in no case be expected to emerge from its harbor and conduct blockading operations near Japan, nor could the fleet be expected to leave Honolulu and, upon arrival near the Japanese coast, find their opponent willing to emerge during the short period which our fleet could maintain itself there and join battle, when mere waiting would force the invaders back to their bases.

Various objections are advanced to building up Manila to be our real point of strength in Asiatic waters. For one thing, it is among islands which furnish a great number of available points of invasion and the most practical means of absolutely preventing a successful attack—that is, the maintenance of our full fleet in Manila—would be not only translated as a distinctly unfriendly move but would be a matter requiring the greatest expense in the transportation of supplies and the upkeep of the ships. On the other hand, Mr. Bywater points out that Guam may be prepared for a fleet base with relatively small expense. A combination of dredging, with outlying breakwaters, will provide anchorage in any magnitude desired. This island of course is barely self-supporting in even the essentials of food, and oil and cold storage, docking and repair facilities would have to be constructed before the fleet could find the harbor of any tactical value. However, the defense would in no way be as difficult to maintain as that of Manila. It could be made absolutely sure by local employment of heavy coast defense guns, mine-fields, and a strong

force of submarines and aircraft so that it would not require the steady presence of the fleet there, but could be securely protected, to furnish an arriving point for the main body of our forces in their progress toward the Asiatic Coast. Once the fleet were in Guam, it is pointed out that this is even a better "point d'appui" than anything in the Philippines and that the tenure of the latter islands by any force based in Japan would be practically impossible with a superior enemy force located at Guam.

This superiority the Americans possess at present and it is projected that it will be maintained. In the further discussion of dockyard necessity Mr. Bywater points out that if none existed in Guam, or if that island were in the hands of an enemy, *any vessel seriously injured in combat near the Asiatic Coast would almost certainly founder before it could be withdrawn as far away as Honolulu*, or failing in this, it would succumb to the attacks of aircraft, following destroyers and long range submarines which would undoubtedly accompany the remnants of a retreat. In a dozen places in this interesting volume the author comes back again and again to the demanding necessity for docking facilities in the Pacific and especially the primary importance of a great fleet establishment at Guam, with every facility for the dry-docking, supplying and repairing of all the vessels which would compose the sea-going force.

The author has a distinct criticism of our present fleet composition and of our building program. It is true, he thinks (and this is confirmed by the statements of the British Admiralty, our own Navy Department and the Japanese Naval Office), that the strength of the power at sea still remains in the heavy battleship and that while auxiliary types are required in sufficient numbers, they are useless unless the backbone of the fleet is there. In this regard, however, he makes it evident that while the backbone is necessary, there must be some arms and legs to the fleet, too, and proceeds to call attention to the fact that the necessity which we have always been under of using heavy, old, armored cruisers, or light destroyers, for the scouting and reconnoissance work which fast and sturdy light cruisers should do still exists, and that even our moderate program for turning out 10 of these craft will leave us distinctly inferior to both the Japanese and British in scouting ability. Even if the claims of aircraftmen are acknowledged *in toto*, we yet remain behind both nations in scouting equipment. The Japanese are fast at work upon their aircraft carrier *Hosho* and the British, as we already know, have had several modern and capable aircraft carriers in actual operation for several years. He says that "if naval policy were governed solely, or even mainly, by practical consideration of tactics and strategy, the Americans would now be constructing battle cruisers and fast light cruisers to the exclusion of every other type, for it is certain that the want of such ships would most seriously handicap the fleet in any war-like operations." At present the British have 45 modern light cruisers and the Japanese eight. We are credited with none. In the building programs Great Britain is completing four of a very strong type, of which the *Hawkins* is one. The Japanese are constructing eleven in addition to their present equipment of eight, and we have ten under construction—the *Omaha* class.



The Japanese naval officer is described as being of a most ardent and zealous disposition. The author scouts the idea which grew up during the Chinese and Russian Wars that he is possessed of any more bravery or audacity than his brothers in other navies, or that any one nation has a lien on courage, but it is pointed out that they take their work in the most serious and thorough mood; that their course of instruction in school and aboard ships as young officers is of the most exacting sort and that the older officers themselves persist in the study and discussion of their work to the exclusion of almost any other subject. He recounts the case of a number of Japanese officers in England awaiting the completion of some vessels which the British were building for them. They were persistently at work as long as anyone remained in the yard, and on holidays and after working hours their idea of having a good time was to keep themselves busy with blue prints and sketches, or if the vacation were more extended, to go by train to visit some other dockyard all day and play war games at night. It is said that the restrictions guarding the entrance of the cadets into the officer branch of the Navy are such that only those of a very good social class are admitted and that these are practically restricted to the old Military Clan. In this regard, however, the recent demand in Japan for popular participation in governmental activities has broken down the barrier which once prevented boys of other than the finest social classes from entering the Navy and it is said that this career is gradually opening to boys of less prominence. This holds good in both the Army and the Navy to a small extent, but it is remarked that the old Military Clan still have things very firmly in their grasp in Japan and yield to the popular demand in just so large a measure as will placate it.

An excerpt from the proceedings of the Imperial Diet during the discussion of the last naval program is reproduced here as an example of the fact that the representatives in Japan are becoming very outspoken in their discussion of the government policy and that the progress of their Navy Department in securing the passage of legislation for building programs is impeded by much the same hurdles which prevent our own plans from running down a straight course. A member of the Diet interpellated the representative of the Admiralty as follows:

"For how long a period will the requirements of the Navy be covered by this Bill?"

"Admiralty reply: 'No definite answer can be returned to that question. The program now before you is the minimum consistent with our needs to the end of 1924. It is considered wholly adequate by the Imperial Navy Department, especially as regards the number of cruisers and submarines, these being types to which special importance is attached. Developments in the naval policy of foreign states cannot be ignored by us.'

"A Member: 'Does this program take cognisance of current naval expenditure in the United States and England?'

"Admiralty reply: 'Yes; it was not prepared until the extent of current naval expenditure by those two Powers was known to us. Any sub-

stantial additions which may be made by either of them would compel us to reconsider our own Budget.'

"A Member: 'Are we, then, building warships against the United States or England or both?'

"Admiralty reply: 'No: against neither. The Navy Department deprecates such suggestions. But it is obvious that our own program must be influenced by what is being done abroad. I am asked in what relation our Navy will stand to that of the United States when all the new construction authorized here and in America is afloat. The answer is, approximately, as 1 to 2; that is to say, we shall be about as half as strong as the United States in capital ships. That ratio would be disturbing, and perhaps inadmissible, but for certain corollary factors, such as our superiority in cruisers, our proportionately larger personnel, and our more advantageous position.'

"A Member: 'The political outlook must indeed be grave if the Navy Department feels warranted in demanding £68,000,000 for new warships at a time of such pronounced economic stress. The Committee would welcome a more detailed explanation of the Department's reasons for this heavy demand.'

"Admiralty reply: 'The program is dictated by requirements of strategy. It was not drawn up without earnest consideration or without due allowance being made for the country's financial situation. Every nation must, however, be prepared to make sacrifices if it desires to be safe from foreign aggression.'"

#### JAPANESE BUILDING FACILITIES

Taking up the matter of dockyards and building slips in the possession of the Japanese, the author calls attention to the enormous increase of Japanese building resources which was occasioned by the war. They are much better supplied with means for docking and repairing their fleet in case of a conflict in the Western Pacific than any other nation would be and the author points out that we have no accommodations of that kind at all. The table supplied by him shows that at present there are dockyards in Japan and the following capabilities:

- "Dockyards capable of building hulls, machinery, and equipment for every type of warship, including dreadnoughts and battle-cruisers..... 4
- "Dockyards capable of building hulls and machinery for warships up to and including cruisers.... 4 (or 5)
- "Dockyards capable of building destroyers, submarines, minelayers, and smaller craft..... 10

"The resources tabulated above were available at the end of 1920, but two or three years hence they will have been greatly enlarged, and by that time the position may be as follows:

"Dockyards able to build	Dreadnoughts	..... 9
"	" Light-cruisers	..... 7
"	" Destroyers	.....12
"	" Submarines	.....10

"The five additional yards that will probably be able to construct dreadnoughts and battle cruisers by 1922, if not before, are the Asano, Mitsui, Suzuki, Uruga, and Yokohama establishments. Some of the smaller firms, which are quite capable of constructing destroyers and submarines, are not yet able to manufacture the machinery for these vessels. In regard to oil-engines for submarines, the total Japanese capacity in 1919 was estimated at twelve complete sets per annum, viz., four sets for large ocean-going boats, and eight sets for coastal submarines; but the present total is probably much higher. Motors suitable for propelling submarines are built in the Government shops at Kure, Yokosuka, and Sasebo, and also by five private companies: Mitsu Bishi, Kawasaki, Uruga, Suzuki, and Asano."

Attention is called to the popular belief that Japanese shipbuilders are considerably behind American or European ones in technical knowledge or in the items of workmanship which go into construction. This is called a fallacy; Mr. Bywater remarks that they have never been content to be subservient imitators of designs initiated abroad, but that they have always shown distinct boldness and originality in their conceptions of ships and equipment, and that the quality of work turned out by the government yards has always been distinctly high. The Japanese destroyers which served on anti-submarine and escort work in the Mediterranean were highly praised by foreign observers, and subsequent to their return home proceeded to attain speeds in excess of their trial performances, and this was in spite of their having been on continuous service under the most exacting war conditions.

"In addition, the Japanese evolved their own system of armor and under-water protection for large ships as a consequence of experiments made during 1917, 1918, and 1919, at the cost of about \$3,000,000. They have developed their own water-tube boiler, which is said to have a higher steaming efficiency than any foreign type, and have proceeded to manufacture the heaviest ordnance and equipment, with their own modifications in rifling, breech mechanism and mounting. Her submarines are said to be not copies of European or American submarines at all, but to have been designed with a distinct eye for her own local requirements, and she has been credited with substantial improvements in naval explosives, projectiles, torpedoes and mines."

#### STRATEGY IN THE PACIFIC

Under this head attention is called to the separation of the American Navy into two fleets which occurred in 1919 and which resulted in our putting a strong force in the western ocean. This division of force has been persistently criticized because it was contrary to the root principle of all military axioms, and the writer notes that it was only attempted after two conditions were fulfilled; first, that each of the two units is strong enough to carry on a first-class engagement with any possible enemy; and second, that the Panama Canal is now constructed, which allows the two fleets to be merged when the necessity arises. He has

one warning remark to make on this point, however, which is to the effect that it is an experience which is very common, that no force has ever been found to be effective in war which was not trained under a single command during the days of peace. Concerning the assumption that the Canal would be maintained in a useful condition during hostilities, the defenses of that waterway are described in very accurate detail and the conclusion drawn that they are thoroughly adequate. The chance exists, of course, that a vessel loaded with explosives might get into the Canal and blow herself up while in a lock, but the memory of the rigorous inspections which preceded the passage of any vessel through the Canal during the late war will reassure any who are made apprehensive by the recount of how simple an operation this would be.

In reviewing the situation which would probably exist in the case of an outbreak of war with Japan, the author assumes that the American naval command would be faced by the necessity of coming to a decision as to whether it intends to wage an offensive war against the enemy, or to conduct a purely defensive operation designed to protect the American mainland from invasion. In the latter case it is assumed that no difficulty will be had. With Honolulu as an outpost and the whole Pacific between the enemy's coast and our own, the possibility of a sustained, frontal attack by a Japanese Fleet is scouted as being absurd. It is made apparent that the sensible thing for the Japanese to do would be to stay at home and await the attack in waters which are close to their bases and fuel supplies. If it be assumed that we could occupy a dignified position by remaining at home ourselves, it has only to be pointed out that Japan has no possessions near our coast and that we have Guam and the Philippines within easy reach of her; that neither of them is defended by a force which would tax her fleet's strength to reduce; that our small cruiser force in the Asiatic would probably be eliminated in the first week of trouble and that with the downfall of Guam and the Philippines, the situation would be such that it could hardly be expected that American national pride would allow a termination of hostilities in that condition. If the matter were ended at that point, it would certainly be adjudged that this had been a defeated nation.

*It is therefore perfectly evident that an offensive campaign would be forced upon this nation, whether we wished it or not* and this means, of course, that our Fleet would be obliged to move over-seas to the locality of the enemy's home bases. It is 4400 miles from Honolulu to the Japanese coast, and without going into any particulars of fuel consumption and the necessity of fast speed and zigzagging in various areas to escape submarine attack and of the long return home after a fight, it is apparent that Honolulu is too distant for any base of operation of surface ships in the vicinity of the Asiatic mainland. A few long-distance submarines might arrive there, but it is apparent that that is not enough; that the tactics of conflict would necessarily be bent toward bringing the Japanese main fleet to a victorious action or, failing in this, to blockading the Japanese coast to such an extent that the islands could be starved into submission.

## A BASE IN THE EAST

The existing defenses of the Philippines and Guam are detailed by the author, and it is assumed that their reduction by Japanese forces within two weeks of the declaration of war would be matters of perfect assurance. In Guam there is practically nothing to withstand a heavy bombardment. Public declarations from our own writers have repeatedly asserted that the overwhelming of the weak forces in the Philippines would be a matter of ease, and have made it evident that these islands must be defended by the fleet or not at all. It becomes further evident that this fleet must have a protected base in either the Philippines or Guam where it may be stationed previous to a war, or to which it can be sent, with a perfect assurance of its being guarded in port after its arrival. The first condition, which would presume that our main fleet be kept in the Philippines, is one that may be dismissed. Its fuel and food and transfer of personnel would be matter of such heavy consideration, and its presence would be such an apparent offense to the Japanese, that it is not economical of time to consider it.

The author calls attention to the great number of possible landing places which the islands in the Philippine group have and the fact that Guam, on the other hand, may be easily and thoroughly defended with heavy coast defense artillery, mine fields, and local forces of submarines and aircraft. The ability of submarines and aircraft to defend a shore base which has no fear of an attack from the rear has certainly become almost an axiom in the last few years, and the defense of Guam as compared to that of the Philippines would seem to be a much simpler affair.

On the assumption that the Philippines have succumbed to attack and that a first-class base at Guam remains to harbor our main fleet upon its arrival, the reader is led to consider the progress of the American Fleet across the Pacific from Hawaii. The zeal of the Japanese at the Peace Conference in securing the supervision of the former German islands north of the equator is easily explained by the flanking position which these islands occupy along the only route of transport from America to the Orient and the knowledge that there are many spots in these islands which can be quickly and easily converted into excellent centers of operation for aircraft and submarines. The line to Guam is flanked by the Marshall Islands, some 1500 miles to the east, and these contain the harbor of Jaluit, in which the Germans had begun a base for naval operations before the Great War. The Caroline Islands come next, to the west, with harbors at Pulap and Ponape. To the north of Guam lies the Marianne group, with an excellent base at Saipan. There are in addition, to the west of Guam and lying directly along the route between it and the Philippines, Yap and the Pelew Islands, the latter containing a good harbor at Anguar, where the *Emden* coaled before setting out on her raiding expeditions. It is assumed that in spite of the experience which the United States derived from the transport of a huge army to Europe during the late war, the losses attending the transfer of our fleet and landing forces to Guam would necessarily be of a considerable amount, but that the

main force would, with any reasonable bit of luck, get through, and once in Guam (providing it were properly fortified), this fleet would be perfectly safe to rest, re-fuel, and prepare for further operations from that base. Without Guam, the whole operation is assumed by the author to be perfectly futile.

Mr. Bywater shows to what extent the accumulation of the Japanese population in the big cities and in their lately-grown manufacturing establishments has caused a shortage in the crops which used to supply the people; the fact that she now imports about one-fifth of her rice crop from British India and South China, and that the mobilization of the army would still further withdraw men from the productive branches and include them in those forces which eat supplies without sharing in their production. With Guam in the hands of an enemy who is superior to them in main fleet composition, in other words an enemy so strong that the Japanese main fleet would be unable to defeat it in a major engagement, the continuation of transport or merchant shipping lines from the Japanese Islands to the Philippines and South China would be greatly endangered. It is to be assumed that cruiser operations (and our notorious shortage in these ships is pointed out as a reason why we would not secure the greatest benefits from the situation), would either stop the traffic south of the Japanese Islands or lead to the defense of the sea lanes by such Japanese forces as would eventually bring to two fleets into conflict. In this event, as the Japanese Fleet as constituted at present is several knots faster in most of its units than ours, it may be assumed that they would endeavor to fight at as long a range as possible in order to avoid the withering punishment of our much superior broadsides. *If we were not in possession of Guam, and had to return clear to Honolulu subsequent to an engagement, it is apparent that their strategy would be to avoid a decisive engagement; to inflict what damage they could without being overwhelmingly battered and to take advantage of their superior speed to retire upon the bases near them in their own islands. After the termination of a heavy battle in Japanese waters we would be left to return some forty-four hundred miles across the ocean, harassed by aircraft, following submarines, and light cruiser and destroyer forces which would pick off all the wounded and crippled ships. It is also apparent that vessels which were holed at all badly could not be successfully towed nor could they propel themselves to Honolulu without almost a certainty of succumbing on the way. With Guam in our possession, however, as a thoroughly equipped modern base, we would probably have to return no farther to our own center of operations than the Japanese would to theirs, and with the Japanese unwilling to come to a final decisive engagement, their lines of communication (and that means their sources of food and trade), would inevitably be surrendered.*

The financial situation in both countries is detailed, with the evident superiority in the favor of the United States and the author goes to considerable extent to demonstrate that the Japanese Islands can neither support a long, heavy warfare financially, nor can they support them-

selves for an extended period with the food they grow at home. He approaches the subject from many angles and from all the sources which contribute in any way to the carrying on of a war, and the answer in every case is "Guam." *He calls attention to the fact that we have built and are building a splendid fleet, but that however powerful it is, if there is no safe base in the East to which to direct it and in which it may repair, dock and replenish its fuel, it is an absolute inutility; that the strategy of the Pacific and its great distances will render it of no use in spite of its powerful equipment, and that for distinctly less than the cost of several dreadnoughts, Guam and the line to the East may be made absolutely safe to us.*

In the end it may be said that this book is a most illuminating discussion of the political and strategical situation which is now occupying the attention of the world. As in every case where a civilian goes about a discussion of affairs of war, the details are taken up in the most evident and convincing form. It was intended for civilian consumption and does not need a trained military mind to understand. On the other hand, naval and military men will find it a most comprehensive and plainly-expressed review of the irritating features existing between the two countries, the possibilities of conflict, and the very likely form which that conflict would take.

J. M. C.

"A Text Book of Oceanography." By J. T. Jenkins. Price \$6.00. (New York: E. P. Dutton & Co.)

The book is designed primarily as a text book of oceanography for students in institutions of learning, especially in Great Britain and Ireland since many of the pertinent illustrative features are drawn from the literature of oceanography in relation to the seas surrounding the British Isles. This volume possesses a range of usefulness extending far beyond the classroom, for, besides presenting phases of oceanographical interest to the biologist, the chemist, the geologist, and the physicist, and besides serving to show the conspiring interests of the cognate sciences in the field of oceanography, it has a predominant value to the seafarer. Fully one-half of its contents is devoted to the discussion of the currents and tides, and the rest is a brief summing up of the outlines of the present state of knowledge in relation to the physical geography of the sea, in which are often reflected the advancements that have proceeded from the lately conducted investigations of the International Council for the Exploration of the Sea.

L. H. C.

# United States Naval Institute Proceedings

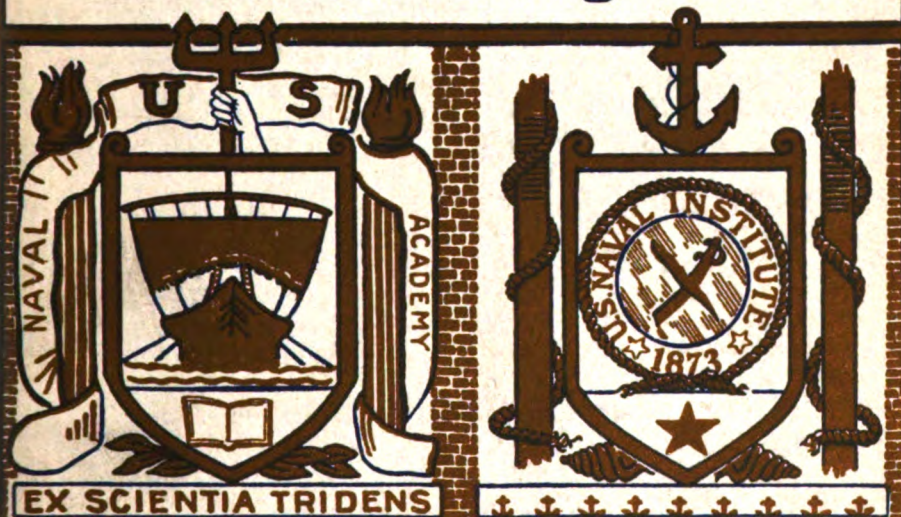

The writers only are responsible for the contents of their respective articles

## CONTENTS

	PAGE		PAGE
Onward and Upward.—Knapp . . . . .	1509	Rigid Airships.—Fulton . . . . .	1565
Aerodynamics.—Hunsaker . . . . .	1519	Graphical Solution of Problems In Nautical Astronomy.—Manierre . . . . .	1593
Disarmament and Foreign Trade.—Fiske . . . . .	1539	Discussion . . . . .	1605
Probability and Accuracy of Gun Fire.— Kinkaid . . . . .	1543	Secretary's Notes . . . . .	1609
A Combined Staff.—Scammell . . . . .	1553	Professional Notes . . . . .	1612
The Super Navy. The U. S. Navy.—Schornst- heimer . . . . .	1559	Notes on International Affairs . . . . .	1667
		Information Index . . . . .	1611

Copyright, 1921, by J. W. Conroy, Trustee for U. S. Naval Institute

Entered at the Post Office at Annapolis, Maryland, as Second Class Matter



OCT 19 1921  
LIBRARY

# WORLD'S ONLY MAKER

**Moulded High Frequency High Tension Insulators**

**POTENTIALS 1,000 ← TO → 1,000,000 VOLTS**

Medal and Diploma  
received at  
World's  
Columbian  
Exposition,  
Chicago, 1893



Medal and Diploma  
received at  
World's  
Fair,  
St. Louis,  
1904



REG. U.S. PAT. OFF. & FOREIGN COUNTRIES.  
**INSULATION  
MADE IN AMERICA**

Louis Steinberger's Patents

**ARRIVED**



**AIR-GAP TYPE  
INSULATORS**

PATENTED

Radio Frequencies  
Radio Telegraph  
Radio Telephone  
X-Ray Apparatus

Damped or Sustained  
Voltages

Air Gap  
¼" and Upward

Maximum Dielectric  
Strength

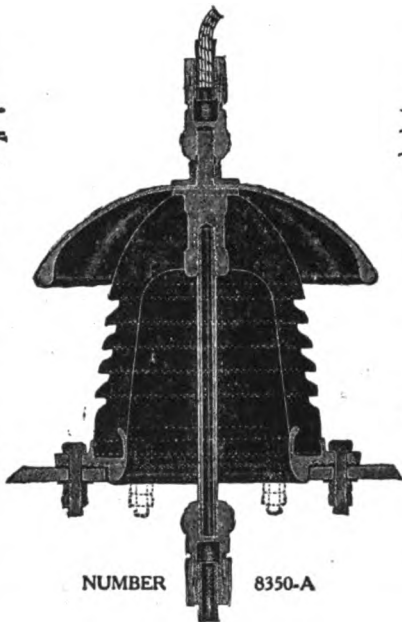

NUMBER 8350-A

**ARRIVED**



**AIR-GAP TYPE  
INSULATORS**

PATENTED

Audio Frequencies  
Transmission Lines  
Sub Station Bushings  
Transformer Bushings

Oil Switches  
Circuit Breakers, Etc.

Air Gap  
¼" and Upward

Maximum Mechanical  
Strength

**MINIMUM DIELECTRIC LOSS  
MINIMUM WEIGHT**

**MINIMUM COS  
MINIMUM PHYSICAL DIMENSION**

Materials so proportioned that:

**MAXIMUM ELECTRIC STRESSES FORMED IN AIR**

EXTENSIVE TESTS under sustained radio frequency operation show:

**NO DETECTABLE HEATING**

**ARC-OVER ESTABLISHED IN AIR**

"ELECTROSE" Insulators are standard with United States Navy and Army and Wireless Telegraph and Telephone Companies.

"ELECTROSE" is made in a number of grades for various requirements, each grade possessing special characteristics.

"ELECTROSE" Insulators—Best in the World for High Frequency Currents, Power and Transmission Circuits.

SOLE MANUFACTURERS



60-82 Washington St.  
66-76 Front St.

27-37 York St.  
1-23 First St.

**Brooklyn, N. Y., America**

Please mention the PROCEEDINGS when writing advertisers

# United States Naval Institute Proceedings

PUBLISHED MONTHLY  
EDITED BY F. M. ROBINSON



U. S. NAVAL INSTITUTE  
ANNAPOLIS — MARYLAND

COPYRIGHT, 1921  
By J. W. CONROY  
TRUSTEE FOR U. S. NAVAL INSTITUTE

*The Lord Baltimore Press*  
BALTIMORE, MD., U. S. A.

*The writers only are responsible for the contents of their respective articles*

## CONTENTS

---

ONWARD AND UPWARD. By Rear Admiral H. S. Knapp, U. S. Navy...	1500
AERODYNAMICS. By Commander J. C. Hunsaker (C. C.), U. S. Navy..	1519
DISARMAMENT AND FOREIGN TRADE. By Rear Admiral Bradley A. Fiske, U. S. Navy (Retired).....	1539
PROBABILITY AND ACCURACY OF GUN FIRE. By Lieut. Commander T. C. Kinkaid, U. S. Navy.....	1543
A COMBINED STAFF. By Captain J. M. Scammell, Inf. R. C., U. S. Army .....	1553
THE SUPER NAVY. THE U. S. NAVY. By Graser Schornstheimer....	1559
RIGID AIRSHIPS. By Lieut. Commander Garland Fulton (C. C.), U. S. Navy .....	1565
GRAPHICAL SOLUTION OF PROBLEMS IN NAUTICAL ASTRONOMY. By Charles E. Manierre .....	1593
DISCUSSION .....	1605
SECRETARY'S NOTES .....	1609
PROFESSIONAL NOTES .....	1612
NOTES ON INTERNATIONAL AFFAIRS.....	1667
INFORMATION INDEX .....	1611

## OFFICERS OF THE INSTITUTE

---

### *President*

REAR ADMIRAL BRADLEY A. FISKE, U. S. NAVY

### *Vice President*

REAR ADMIRAL HENRY B. WILSON, U. S. NAVY

### *Secretary and Treasurer*

COMMANDER F. M. ROBINSON, U. S. NAVY

### *Board of Control*

REAR ADMIRAL BRADLEY A. FISKE, U. S. NAVY (*ex officio*)  
REAR ADMIRAL HENRY B. WILSON, U. S. NAVY (*ex officio*)  
BRIGADIER GENERAL GEORGE RICHARDS, U. S. M. C.  
CAPTAIN JOHN HALLIGAN, JR., U. S. NAVY  
CAPTAIN J. A. FURER (C. C.), U. S. NAVY  
COMMANDER JOHN DOWNES, U. S. NAVY  
COMMANDER J. O. RICHARDSON, U. S. NAVY  
COMMANDER F. M. ROBINSON, U. S. NAVY (*ex officio*)

## PAST PRESIDENTS

---

ADMIRAL DAVID D. PORTER, U. S. NAVY, 1873  
REAR ADMIRAL JOHN L. WORDEN, U. S. NAVY, 1874  
REAR ADMIRAL C. R. P. RODGERS, U. S. NAVY, JAN. 1875—JAN. 1878  
COMMODORE FOXHALL A. PARKER, U. S. NAVY, JAN. 1878—JAN. 1879  
REAR ADMIRAL JOHN RODGERS, U. S. NAVY, JAN. 1879—JAN. 1882  
REAR ADMIRAL C. R. P. RODGERS, U. S. NAVY, JAN. 1882—JAN. 1883  
REAR ADMIRAL THORNTON A. JENKINS, U. S. NAVY, JAN. 1883—OCT.  
1885  
REAR ADMIRAL EDWARD SIMPSON, U. S. NAVY, OCT. 1885—OCT. 1887  
REAR ADMIRAL STEPHEN B. LUCE, U. S. NAVY, OCT. 1887—OCT. 1898  
REAR ADMIRAL WM. T. SAMPSON, U. S. NAVY, OCT. 1898—OCT. 1902  
REAR ADMIRAL H. C. TAYLOR, U. S. NAVY, OCT. 1902—OCT. 1904  
REAR ADMIRAL C. F. GOODRICH, U. S. NAVY, OCT. 1904—OCT. 1909  
REAR ADMIRAL RICHARD WAINWRIGHT, U. S. NAVY, OCT. 1909—OCT.

1911



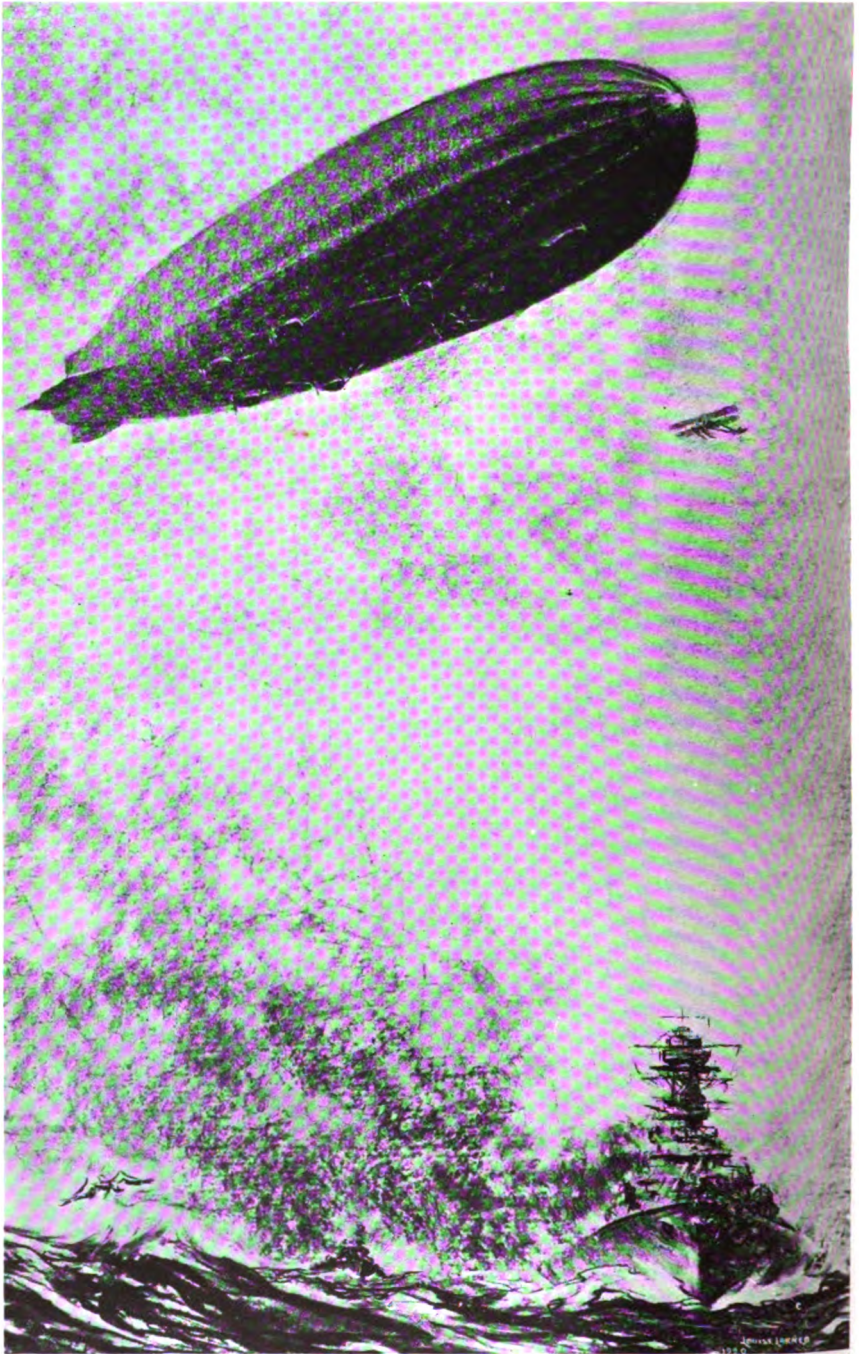

SKETCH OF RIGID AIRSHIP OPERATING OVER THE SEA. (Navy Dept. Photo)

# UNITED STATES NAVAL INSTITUTE PROCEEDINGS

Vol. 47, No. 10

OCTOBER, 1921

Whole No. 224

---

## SPECIAL NOTICE

Supplementing the Special Notice regarding address, which appeared in the last issue of the PROCEEDINGS, the Institute wishes to further inform its members and subscribers that the Bureau of Navigation has discontinued issuing the monthly *Navy and Marine Corps Directory*.

This fact makes it imperative that you respond to this Special Notice, and cooperate with the Institute, by detaching this blank, and returning it with your correct address. This refers, especially, to those who failed to do so, upon receipt of No. 223.

Name .....

Address .....

.....

.....

to automobile torpedoes having a range of thousands of yards; from vessels restricted to the surface of the sea to those that operate under water or in the air; from loss of communication when beyond sight and hearing to assured communication over hundreds, even thousands, of miles. Truly! by comparison with conditions in the early days of my service this is a material advance staggering to contemplate.



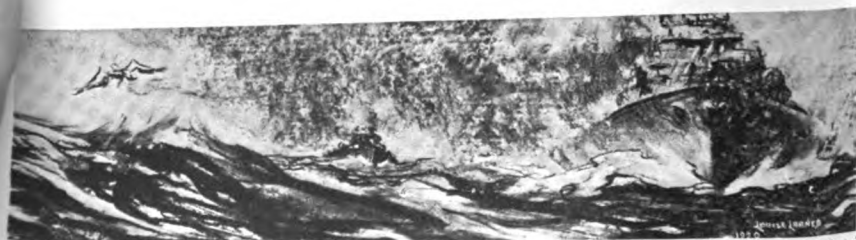
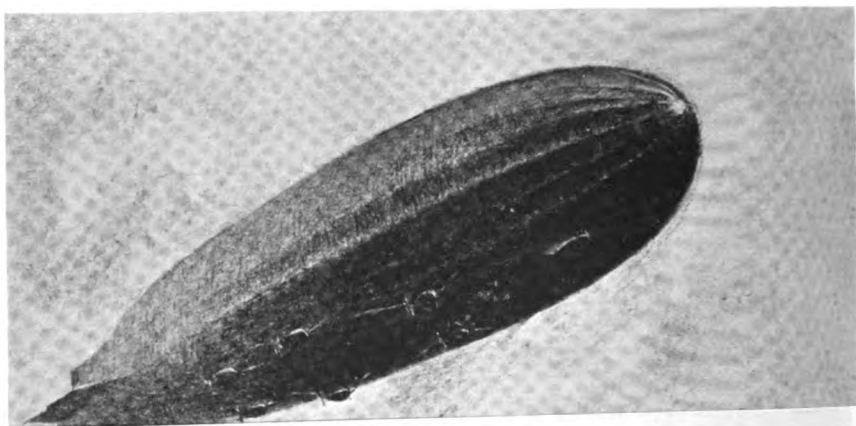

SKETCH OF RIGID AIRSHIP OPERATING OVER THE SEA. (Navy Dept. Photo)

# UNITED STATES NAVAL INSTITUTE PROCEEDINGS

---

Vol. 47, No. 10

OCTOBER, 1921

Whole No. 224

---

[COPYRIGHTED]

U. S. NAVAL INSTITUTE, ANNAPOLIS, MD.

---

## ONWARD AND UPWARD

By REAR ADMIRAL H. S. KNAPP, U. S. Navy

---

In the leisure days of retirement it is a natural impulse to look back over the incidents and tendencies of one's active service. In reviewing since retirement the forty-two years of my own service I have been particularly impressed with the development of thought in the United States Navy. Those years cover a period of remarkable material advance and achievement in human history as well as in the more limited way of naval history. It is a very wonderful time in which to have lived. Speaking of the navy alone: we have advanced from wood to steel in construction; from compound through triple and quadruple expansion engines to turbines, and now to electric drive, or to oil engines in particular cases; from speeds that tramp steamers now attain to speeds rivaling those of express trains on land; from smooth-bore guns to 16-in. rifles, with 18-in. guns under discussion; from spar and towing torpedoes to automobile torpedoes having a range of thousands of yards; from vessels restricted to the surface of the sea to those that operate under water or in the air; from loss of communication when beyond sight and hearing to assured communication over hundreds, even thousands, of miles. Truly! by comparison with conditions in the early days of my service this is a material advance staggering to contemplate.

But it is not so much to this material advance, stupendous as it is, that I would draw attention as it is to the evolution of naval thought. It so happens that my active service coincides almost exactly with the period of life of the Naval Institute, in the pages of whose PROCEEDINGS has been mirrored the naval thought of the day, to a great extent if perhaps not entirely. To the readers of the PROCEEDINGS through the years since the Naval Institute was founded there has been apparent a change in the general character of the articles that have appeared. The navy was at a very low ebb in its material when the founders, a group of far-seeing officers devoted to the service, conceived the idea of the Institute and made it a reality. Very naturally, stress was laid in those early days upon remedies for the discouraging material conditions then existing. Ships, armament, motive power and equipment were far behind even those times, and officers were concerned to get material worthy of our great nation and suitable to uphold its interests should occasion arise. How best to use what we did not have could not be expected to hold the attention of officers as against the more urgent question of getting adequate means with which to do anything. It was a time when material things held the stage.

In passing, however, I pause to express my admiration for, and feeling of great indebtedness to, the officers of the generation immediately preceding my own, who kept alive the spirit of the navy in that deadening time after the Civil War before the rehabilitation of the navy had begun. Using the means at hand, hoping almost against hope for better days, those officers maintained the discipline of the service, preserved its traditions and ideals, and kept it in readiness for better days if and when they should come. To them we owe the fact that the soul of the navy was not moribund when better days did come, and the navy's debt of gratitude to them should never be forgotten.

The founding of the War College was an epochal incident in the history of the navy. It would be untrue to say that the subjects for the study of which the college was established had not had attention before it was founded. There always had been officers who looked beyond the thing to its use—beyond the organization to its mission. Such officers were, however, self-taught; their opinions were individualistic, formed by their own interpretation of political and naval history or their own predispositions for or against given methods in using the material of the navy in war.

without having the advantage of any save incidental discussion with others. Opinions so formed might or might not be sound; certainly they could not be held to be as well-founded as if they had been subjected to intelligent discussion and criticism. Moreover, it was the few whose natural tastes led them in that direction who gave the broader aspects of the profession much thought or who had any very fixed views regarding them. For the many it was the material *things* of the navy that were obvious and so obviously bad as to fix attention to the exclusion of much consideration of their use. There was no service body of opinion—no doctrine—in this latter direction, and no agency to demand attention to it and assist officers in its study. Indeed! many experienced officers believed that there was no need for any such agency. Apparently they believed that strategy, tactics, and, speaking generally, the broader subjects upon which officers should be well instructed, needed no special study under competent direction, with the enlightenment that comes from discussion with others pursuing the same subjects, but that correct ideas about them would be imbibed like mother's milk as a result of everyday, routine experience. Young officers of this generation, to whom the War College is a fixed and natural institution, can have little notion of the bitter opposition it experienced in its early days from officers high in the service—men of established reputations for ability, moreover.

Fortunately these reactionary sentiments did not prevail and the War College survived, growing from small beginnings to its present acknowledged and undisputed place in the preparation of officers for the higher duties of their profession. The principles of warfare in general, and of naval warfare in particular, as deduced from an analytical study of history, their application to strategy, tactics and the cooperation of land and sea forces, the methods to analyse problems and reach conclusions, the question of security and information, including sea scouting, the formulation of clear-cut orders, psychology, international law, naval policy, national policy—such subjects are now studied, studied together, by groups of officers having no other duties. Their discussions clarify the subjects in hand, and tend to make conclusions sound because reached after consideration and criticism from many points of view. Since the founding of the War College it has slowly but surely come to pass that these subjects are not strangers to the

thought of the great body of officers, and there is now a service doctrine that embodies a general, instructed opinion.

This marks a great advance in the thought of the navy—in its professional culture. Moreover, it has not been accomplished at the expense of thought on material things. Indeed! I believe that never has keener thought been given than now to material of the navy, the importance of which needs no argument. Thought on other and higher phases of our profession has simply been superimposed upon thought on material alone, a result that follows the law of culture. The navy is professionally more cultivated now than formerly because its general field of thought has been broadened.

If the professional period be characterized by the prevailing trend of thought, that since the War College came into being may be described by the word intellectual to differentiate it from the material period that preceded. Reference has been made in an earlier paragraph to the Naval Institute and to its PROCEEDINGS. While the PROCEEDINGS is in no way an official publication it undoubtedly does serve in a general way as an index of the thought of the navy. Those who have read it since it was first published will agree that the evolution of professional thought outlined above has been manifested in its pages. With the advance of professional culture in the navy there has been a corresponding advance in the interest, breadth and value of the articles that have appeared in the PROCEEDINGS.

There is another evolution in naval thinking that has impressed me greatly, more especially during the recent past, and which is in large measure the inspiration of this paper. It is not an evolution due to any discovery, nor is it one having as fixed a date of beginning as was the establishment of the War College for what I have called the intellectual period. It is rather an evolution due to an awakened consciousness of the truth that man is greater than his creations, or than his management of them; and that the study of men and of the way to influence and manage men—leadership, in a word—is the highest duty of a naval officer. When we speak of "The Service" we refer to men and their attributes and not to things, whether consciously or not. The officers of the service set its tone, which will be high or low as the officers are of high or low character. The enlisted men are what their officers make them; yes, and the junior officers are what their seniors make

them. This is true in the active sense of what officers require of those under their command, and is no less true in the passive sense of the example they set. Those are no idle words in the articles for the government of the navy that open Article 1: "The commanders of all fleets, squadrons, naval stations and vessels belonging to the navy are required to show in themselves a good example of virtue, honor, patriotism, and subordination." Nor does the fact that the injunction specifies certain officers detract from its moral binding force upon all officers, for all officers have men under their command. The traditions of the service are the legacy of the right-minded officers who have lived before us, and those who carry on have the high responsibility of personally living up to them and of ensuring their maintenance by those whom they command.

The awakened consciousness of which I have spoken is shown by measures directed by the department; it is shown no less by the character of many articles appearing in the PROCEEDINGS. Such matters as training, morale and leadership are receiving increased attention. They are the "visible outward tokens of inner spiritual grace," and the quotation is made in no spirit of levity. The navy has a spiritual side and it is well that its existence should have recognition. In my sense of the words that spiritual side includes everything bearing upon men—the welding of officers and men of the service into the most perfect instrument possible to accomplish the purposes for which the navy exists. Training, education, character building, the inculcation of the spirit of team-work, the breeding of confidence in the support of one's neighbor, the infusion of the belief that we cannot be beaten, the cultivation of the spirit that was voiced by the French at Verdun in those famous words "They shall not pass"—all these are spiritual things. Men win battles. The finest ships are inert things unless men drive them; and men are poor things unless the spirit be high that drives them. Great intelligence at the top is not sufficient; it will not prevail unless the spirit behind it be firm and unshakable, nor unless it be backed by trained, disciplined, determined men of high morale.

The development of men, of ourselves first and then of those whom we command, is the highest work of naval officers; and it is spiritual work as differentiated from preoccupations with material, or even with the intellectual side of the profession of which I have

spoken. To find the spiritual side of the profession receiving increased attention, as I believe it is, is a most heartening thing. The successful development of men has its roots deep down in character. To say in other words what has already been said, the source of the spiritual conceptions of the navy resides in the officers, and no stream rises higher than its source. It is manifestly of the utmost importance that officers hold and maintain in themselves the highest conceptions if they can hope to inculcate them in others. The obvious consequence is that the very first field of an officer in the development of men is to be found in himself; that his first concern is to build well his own professional and personal character. Leaving aside considerations of personal honor that naval officers share with decent men, and without which no one is fit to hold a commission, the officer of high professional character will be proficient in his immediate duties, will study constantly to fit himself for the higher duties that await him, and day in and day out will strive for the qualities in himself that make for success in the leadership of men. He cannot ignore the material with which he has to work, nor the intellectual consideration of how the material of the navy is to be used; still less can he ever forget that his life-work is with men—that his choice of a profession entails his occupying a position of leadership of men, and that he can never be a success unless he is a worthy leader.

No officer is a good officer, whatever his abilities and accomplishments, if he cannot "handle men," to use the time-honored naval expression. The ability to handle men is admittedly a greater natural gift with some than with others, but it is fundamentally a question of character and it may be cultivated by all. If it is not cultivated—and attained—an officer is to that extent a failure. Men have no use for an officer who does not know his own business thoroughly; such an officer lacks character because any officer can know his business thoroughly if he tries. Men have no use for an officer who is not just, and the failure to be just betrays a lack in character that can be and should be corrected. Some officers are hampered in their relationships with men by faults of temperament; if they do not overcome those faults they are wanting to that extent in character. It is needless to multiply illustrations. If my thesis is correct that character underlies the handling of men, then every officer must cultivate leadership by cultivating his own character, and no officer need be a failure at it. Some will always

be better leaders than others, as is true in every human activity, but all can be reasonably good. If any officer lacks the character to reach such a reasonable standard he should leave the service, voluntarily or involuntarily.

Just here in the writing of this paper the current number of the PROCEEDINGS has arrived. It contains two articles out of six on matters pertaining to spiritual things, one on leadership and one on loyalty. Loyalty is one touchstone of character, not the only but a very important one. No military character is worthy unless it can stand the test of loyalty—loyalty to the ideals and traditions of the service; loyalty to the duty in hand; loyalty to the seniors who prescribe that duty; and, a thing never to be forgotten, loyalty to the juniors, officers and men, who carry that duty out. This last sort of loyalty has a direct application to the training of men (and by men I mean all men, commissioned or enlisted), which is second only to his duty to train himself. To instance one very obvious thing, nothing excites more contempt than the sort of disloyalty that seeks to shift to the shoulders of a junior blame that belongs to one's own. But "loyalty down" means far more than this. The object of training is not merely to have men acquire manual dexterity in the performance of special duties or to make them live their service life in conformity with established rules. It is all this, no doubt; but more than this, it is to inspire men with the desire to do these things, a concern of the spirit. True loyalty down will not leave an officer content to get perfection in drill and obedience to regulations on the part of juniors. It will by example, by precept, by patience, by justice, by the decent treatment due to his own respect for the manhood of his juniors, and by commanding their respect for his own character and attainments, lead him to cultivate their will and spirit to a high sense of duty and loyalty so that because of him, yes! for love of him, they are finer and better men, whether of society in general or of the service in particular.

Example is probably the most potent influence an officer can exert; if this be a platitude it will bear repetition. Leaving aside the bearing upon "loyalty up," can an officer feel that he is manifesting loyalty down if he is unshaved or slack in uniform himself while insisting that his juniors be tidy in these respects? if he demands perfection in a drill of which he does not know every detail himself? if he is harsh in language or manner to subordinates



in a way that he would resent if manifested toward himself by a senior?—to mention only a few things in illustration. There can be only one answer. "Do as I say and not as I do" is a rule of conduct one hears occasionally, but spoken at all seriously it is a confession by the speaker of his own shortcomings and betrays a failure in loyalty up to his duty and his seniors, and in loyalty down to his juniors. Every consideration of what I call the spiritual side of the profession leads back to the high responsibility of officers to "show in themselves a good example."

The word "morale" has appeared in the PROCEEDINGS of late with increasing frequency. Morale has nothing to do with material things and very little to do with intellectual attainments. It is essentially a matter of the spirit, a resultant of spiritual qualities. The word ordinarily applies to bodies of men rather than to individuals, as when we speak of the morale of the service. It is a composite, however, of the individual morales of its personnel, a weighted mean of those individual morales where the greater weights are given to the higher positions in the naval hierarchy. Like all averages it can never equal the greatest individual value. What every officer can and should do is to attempt to raise the average by setting for himself personally the highest ideals and standards, and then by studying in every way to raise the morale of those under his immediate influence. It is especially important in our navy that this be kept consciously and constantly in mind because of the fact that our service is one of short enlistments in which the proportion of reenlistments is relatively small. The ranks are constantly being diluted by men whose service morale is low, if only because unformed, and thus the average is reduced.

The preparation of this paper was interrupted by my attendance at the graduation ceremonies at the Naval Academy, where the main thought of the last few paragraphs was the theme of Mr. Secretary Denby's address to the graduates. What had been in my mind so much during the preceding weeks found confirmation in the words of a man singularly qualified to pronounce judgment. I have never been an enlisted man; Mr. Secretary Denby has been an enlisted man as well as an officer, and in both the navy and the marine corps. With the knowledge gained by an educated man of the viewpoint of both enlisted men and officers, his words on such a subject carry a weight far transcending the respectful attention that would be given in any event to the man holding his high office.

These reflections have been the result of a backward look upon more than forty years of active service, but they are combined with a confident look forward to the future. I believe in the service to which it is my honor to belong—in its high ideals, its high standards of character and attainment, and in its spirit of progress. I left active service with an intense pride in the navy which I may be forgiven for expressing to my brother officers. It was not my fortune to have any part in actual war operations, but I saw officers about me doing distinguished service in other and unusual fields while eating their hearts out with the desire to be at the front. The duty in hand never suffered because of that natural desire and the disappointment that it could not be gratified. Later, in the trying times after the Armistice, I was in a position to observe officers on duty in Europe, and my respect was unbounded for the spirit in which duties of all kinds were undertaken, as was my respect for the manner of their performance. Many of those duties were unusual, quite out of the range of a naval officer's ordinary activities, and demanding a high degree of responsibility, often greatly out of proportion with the rank of the officer to whom they fell; but they were done, and done well.

The navy is on the upgrade. This is not said in unreflecting optimism, for I do not believe that all that is is best; but I have little patience with the growlers who declare that the service is going to the dogs. I know that the navy is a better establishment now than when I first put on its uniform. It is better in material, far better; in its instructedness in the methods of using that material and, speaking generally, of accomplishing its mission it is incomparably advanced; and it is giving attention more than ever to what seems to me the all-important spiritual side. Moreover, the navy works much harder now than then, which surely is no sign of a deteriorating spirit. I do not believe that the evolution of the service has stopped. So, if these words carry any message, it is one of hopeful confidence that the course of the service in the future will be onward and upward,—in material, in intellectual instructedness and in the higher spiritual qualities without which material and intelligence are incomplete.

The navy has a soul; and, like the soul of John Brown, the navy's "soul goes marching on."



[COPYRIGHTED]

U. S. NAVAL INSTITUTE, ANNAPOLIS, MD.

---

## AERODYNAMICS<sup>1</sup>

By COMMANDER J. C. HUNSAKER (C. C.), U. S. Navy

---

A series of lectures on different aspects of aeronautics has been arranged, of which this is the first. As I am to prepare the way, I shall discuss only the principles of aerodynamics, the fundamental science built up by generations of patient experimenters and only in our own time turned to practical use. The succeeding lecturers will instruct you in the various kinds of aircraft and their operation. To-night, let us consider the nature of the air itself which supports all things that fly in it. A good deal is known and more is unknown. However, enough is now known to permit man to fly.

The use of steam was ushered in by the 19th century, and conditions of life on our planet have been profoundly changed. We may well wonder whether the conquest of the air will as profoundly affect life during the 20th century. Certainly in the naval service, new ideas are already crowding upon us.

### THE OCEAN OF AIR

We live near the surface of separation between the ocean of water and an even deeper ocean of air extending above us. These oceans are in many respects similar. In each, there are the twice daily tides and great currents circulating in definite courses, *e. g.*, the trade winds and the prevailing westerly winds.

We know a little about the top of the sea and the bottom of the air. To explore the sea below or the air above, we make soundings. Soundings show that the sea is colder as we go deeper and the air colder as we go higher. Both oceans receive their heat from the sun at their surface of separation.

<sup>1</sup> A lecture delivered before the first class of midshipmen, March 11, 1921.

Deep sea fish live at enormous pressure and burst if brought to the surface. In a similar manner men live at the bottom of the ocean of air under the enormous pressure of 15 lbs. per sq. in. or about 1 ton per sq. ft. A man's body has about 20 sq. ft. of surface, so that each of us is supporting at all times 20 tons. We do not feel this weight because we are adjusted to it, but when the pressure is partly relieved as when we go up a mountain or up in an airplane, the effects are painfully evident.

The atmosphere extends for an indefinite distance but becomes very thin after a few miles. Men have gone up about 6 miles in airplanes and sounding balloons have been sent up about 14 miles. The cirrus clouds we see in fine weather are about 9 miles high. Meteors that blaze in the night are heated by friction with our atmosphere. The evidence from the spectrum of meteors is that the atmosphere is mainly hydrogen at the top.

The principal difference between the oceans of air and water is that the sea is substantially of the same composition at all depths, while the atmosphere is a mixture of gases in different proportions for different altitudes. As we go higher there is less oxygen. This aggravates the sickness caused by diminished pressure. At 15,000 ft. men begin to feel "mountain sickness" and above 20,000 ft. it is usual to require an oxygen breathing outfit.

Figures 1, 2, 3 and 4 show in very condensed form the principal characteristics of our atmosphere.

#### PHYSICS OF THE AIR

Air at sea level weighs about an ounce to the cubic foot or 1000 cu. ft. of air weighs 80 lbs. Since 1000 cu. ft. of hydrogen weighs only 5 lbs., it follows, by the principle of Archimedes, that 1000 cu. ft. of hydrogen has a lift or "buoyancy" in air of 75 lbs. This is the basis for the lift of balloons and airships. The air in this lecture hall weighs about 5 tons. All types of aircraft (balloons, airships, dirigibles), which gain their lift by the buoyancy of a light gas are called "Lighter-than-air," and the regulation of their movements by releasing gas or ballast is called "Aerostation." I know of no aerostation in nature but the fish's bladder regulates his buoyancy in water (ballast tank of a submarine) in an identical manner.

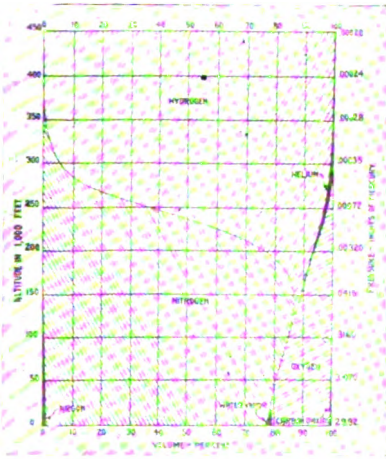

FIG. 1.—Constituents of the Atmosphere.

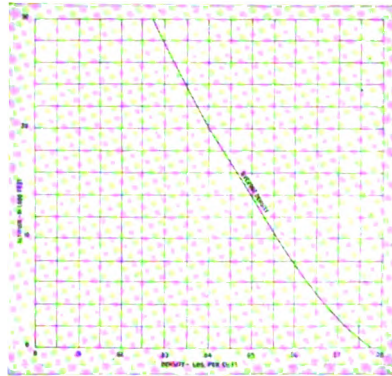

FIG. 2.—Average Temperature Variation.

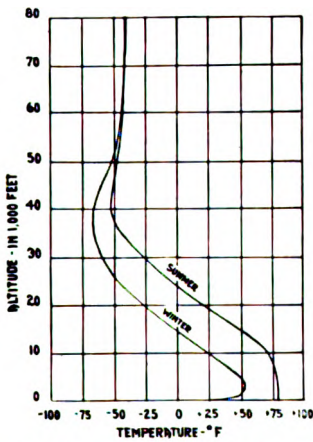

FIG. 3.—Average Density Variation.

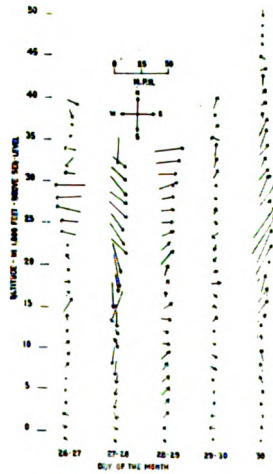

FIG. 4.—Actual Distribution of wind in "Calm" Weather. (Typical Case.)

Birds, insects, kites, parachutes and airplanes gain lift, not by any inherent buoyancy, but by the dynamic reaction obtained by beating down the air. Air is dense and by throwing it down we gain a momentary lift. To sustain a weight in the air, a mass of air must be continuously deflected down. The regulation of the movement of such "heavier-than-air" craft is "aviation." The fundamental laws and principles of aviation are embraced in that branch of applied science known as "aerodynamics."

#### AERODYNAMICS

Aerodynamics is the study of the motion of air and its dynamic effects. The phrase, "air in motion," implies motion relative to something serving to fix axes of reference. For our purposes, it is useful to consider only air moving relatively to a solid object such as an airplane. By the principle of relative motion, we know and may verify that it is immaterial whether the airplane fly steadily at 100 miles an hour through still air, or whether it fly at the same "air speed" into a steady wind of 100 miles per hour. In the latter case, to an observer on the ground the airplane appears to be stationary. However, the force of the wind striking the wings is the same in either case, and at night, or above clouds the aviator would not know whether or not he is making any speed over the ground, "ground speed."

Without making an excursion into the mathematics of the modern theory of relativity, we may accept for aviation, whose speeds do not approach the velocity of light, that the relative air speed may be used in accordance with Newton's laws regardless of "ground speed" or the motion of the earth in space.

#### SOUND WAVES

Air, at the ordinary levels where life can be sustained, is under such a great pressure, or head, that it behaves like water. That is, it is practically incompressible. For example, the pressure of the air on the bow of an airship is 12.5 lbs. per sq. ft. for a velocity of 70 miles per hour. This is only about one half of one per cent of the barometric pressure, and for practical purposes the compression of the air at ordinary transportation speeds is negligible. For projectiles and rockets, however, velocities above the velocity

of sound in air are realized, *i. e.*, over 740 miles per hour, and compression becomes important. Sound waves are produced from the point and rear edge of a bullet and represent a definite transfer of energy from the moving bullet into compression waves in the air. This loss of energy means resistance to motion.

Fig. 5 shows a photograph of a bullet making sound waves. The sound wave is a compression wave of air, and is visible in the photograph because the compressed air has a changed refractive index. In the case of this bullet, the velocity is greater than the velocity of sound, so that the waves of sound trail behind the bullet in a conical sheet resembling in section the bow wave of a ship, instead of spreading on a spherical wave front resembling in

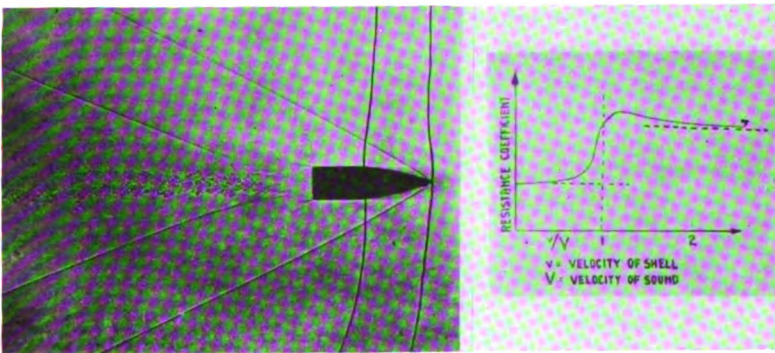

FIG. 5.—Sound Waves in Air. The Heavy Vertical Lines Are the Wires of a Chronograph Cut by the Bullet.

section the circular waves produced by dropping a stone into a pond. It is of curious interest to observe that when a man hears the scream of the bullet, the missile has already passed him. In other words, a man cannot hear the bullet that hits him.

#### DENSITY RESISTANCE

The air is under such a great head that there can exist no voids or holes in it. Were such a hole created, air would flow in with the velocity of sound to fill it up. Nothing short of a high velocity bullet can produce true cavitation in air. But since air has density it must be pushed aside to permit the passage of a moving body. The work of pushing aside the air is manifested as resistance to motion,



and the resistance of a body is greater the more violent this shoving away of the air. Consequently, a body is easy to drive when it parts the air gently and allows the air to close in smoothly behind as it advances. A body of bad form leaves behind it a large wake more or less turbulent. Momentum imparted to the air represents work done on the air and a resistance to motion. This resistance depends on the shape of the body and is represented by an expression of the form:

$$R_d = adAV^2$$

where  $a$  = a coefficient for a given geometrical form,

$d$  = density of the air,

$A$  = the cross sectional area of the body,

and  $V$  = relative velocity.

$R_d$  is called "density resistance" because due to the density of the air.

#### VISCOSITY RESISTANCE

Air besides having density has viscosity. It is sticky and tends to adhere to a solid body moving through it. A fluid shear or viscous drag is thus set up giving rise to a "viscosity resistance" represented by an expression of the form:

$$R_v = b \left( \frac{\mu}{d} \right)^{0.5} A_s^{0.75} V^{1.5},$$

where  $b$  = a coefficient for a given geometrical form,

$\mu$  = the coefficient of viscosity for air,

$A_s$  = the area in shear, or outer surface of the body,

$V$  = relative velocity.

True viscous resistance is only found for extremely slow motion. Ordinarily, in water or air, where there is discontinuity of velocity, as where moving air is in contact with air at rest, the flow is unstable and the surface of discontinuity breaks up at once in vortices or eddies. There is then an abrupt change in resistance caused by the energy lost to these eddies. Density resistance is in practice always found in addition to viscosity resistance, and the exponent of  $V$  even for a thin plate moving edgewise lies between 1.5 and 2. "Skin friction" is the term applied to such a combination of viscous drag with small "friction" rollers or eddies peeling away from the skin of the body. Such friction rollers can be

clearly seen by looking over the side of a vessel moving in smooth water. The steady flow of viscous fluids in pipes at a certain critical velocity breaks into turbulence. The internal shearing forces are in unstable equilibrium.

The instability of discontinuity I can illustrate by the sensitive flame. This gas jet is adjusted to give a long silent jet of flame. The flame distinguishes the moving gas from the still air around it. There is discontinuity of velocity at the boundary of the flame. This enveloping sheet of discontinuity is unstable, as is shown by a shrill whistle which causes it to break down. The flame breaks down and roars when jarred by the sound.

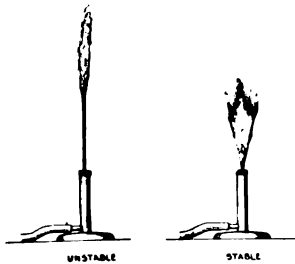

FIG. 6.—Sensitive Flame Before and After Shock Caused by a Whistle of High Pitch.

#### DISCONTINUITY AND TURBULENCE

The path relative to a moving body of a particle of fluid is called a stream line. When the stream lines about a body are steady and continuous the fluid follows the contour of the surface of the body. If there be changes of form, the fluid must follow these changes. Since the fluid has mass, it cannot turn a sharp corner except under infinite pressure. When the body has curvature the fluid can follow the curve only provided the pressure at that place is sufficient to overcome the centrifugal force. Experiment shows that discontinuity commences where abrupt changes of form are made, and this discontinuity is unstable, breaking up into eddies.

Figures 7, 8, 9 and 10 show for air and for water, the surface of discontinuity beginning at the edge of a disc normal to a current which at a critical velocity proportional to the kinematic viscosity  $\frac{\mu}{d}$  of the fluid breaks down into eddies. Note that the nature of the flow is identical in water where the wake is made

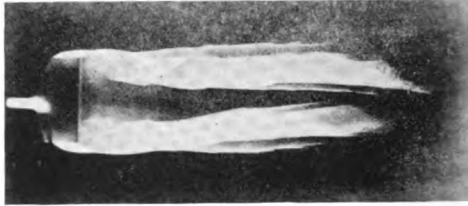

FIG. 7.—Water, Low Velocity.

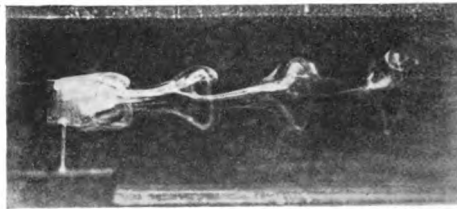

FIG. 8.—Water, High Velocity.

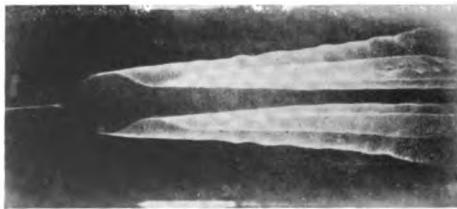

FIG. 9.—Air, Low Velocity.



FIG. 10.—Air, High Velocity.

visible by condensed milk spilling around the edges of the disc and in air where smoke is used for the same purpose.

### VORTICES

The surface of discontinuity is the mother of a family of ring vortices which form the wake. The propagation of these vortices is periodic and their kinetic energy represents a loss of energy and a resistance to propulsion. The fact that a vortex represents a definite amount of kinetic energy I can show by an experiment with a smoke box.

The box filled with smoke has a hole in one side. When the box, which is not stiff, is compressed slightly some of the smoke-colored air inside squirts out of the hole. But the hole, not being a turbine nozzle, has a sharp edge producing discontinuity and a

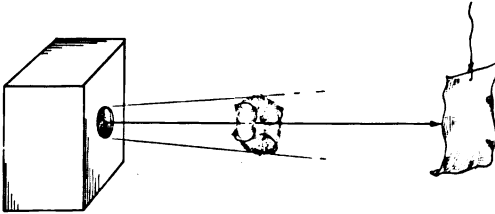

FIG. 11.—Smoke Box. Smoke Ring Strikes Suspended Paper, Bursts and Causes Sharp Reaction of Paper.

vortex. The surface of discontinuity is unstable, but the vortex ring is stable due to its rapid rotation. The vortex ring has a circular core about which the air whirls giving the ring as a whole a velocity of advance corresponding to the direction of the velocity of the air at the center of the ring. The vortex ring includes a mass of air with kinetic energy both of translation and rotation. So long as the air whirls, the ring is stable and acts like a rigid body. The impact of such a smoke colored vortex ring on a suspended sheet of paper indicates by the shock to the paper the fact that the ring is the embodiment of energy.

### RESISTANCE

Obviously, then, to design an airship to be easily propelled through air, we must avoid the formation of vortices in the wake. This means avoid any rapid change of curvature which might create an unstable surface of discontinuity.

Fig. 12 shows the enormous wake in the rear of a shape having a sharp change of curvature and Fig. 13 shows how greatly the condition is improved when the deflection of the fluid is more gently accomplished. Note that the fluid follows the contour of the body almost to amidships, but is unable to follow the curve of the side as it closes in to the stern. The after body is too blunt.

The solution of the problem has been found ages ago by the fast swimming fish. The trout has a head approximately parabolic and an almost flat side gradually tapering to the tail. The water presumably follows the contour of a trout's body without serious eddy making. Torpedoes, submarines and airships are fish shaped.

The airship model shows no eddy formation. It is unfortunate that we cannot make our ships and aircraft slippery like a fish to reduce or eliminate skin frictional resistance as well as the density resistance due to eddy making.

#### BERNOULLI'S EQUATION

Along any stream line, in non-turbulent flow, the pressure  $p$  and velocity  $v$  are related by Bernoulli's equation, neglecting compressibility:

$$p + \frac{1}{2}dv^2 = p_0, \text{ a constant.}$$

The constant  $p_0$  is the total head available, and the equation shows that when the velocity is high the pressure in the stream is low. At a point on the exact nose of an airship, a stream line is brought to rest and  $p = p_0$ . This is the maximum pressure possible to obtain and for 70 miles per hour is 12.5 lbs. per sq. ft. above atmospheric pressure. As the stream lines bend round the bows, the velocity increases and the pressure decreases so that it is below atmospheric. There is, therefore, a virtual suction over the curved parts of the airship when the velocity is high. The integral of all the suction and pressures is the net aerodynamic reaction on the body.

Bernoulli's equation is fundamental in hydraulics and ventilation as well as in aerodynamics. It is applied directly in the Pitot and in the Venturi tube for the measurement of velocity. The ancient paradox of the two balls illustrates the reduction of pressure with velocity. If I blow a blast of air between two suspended

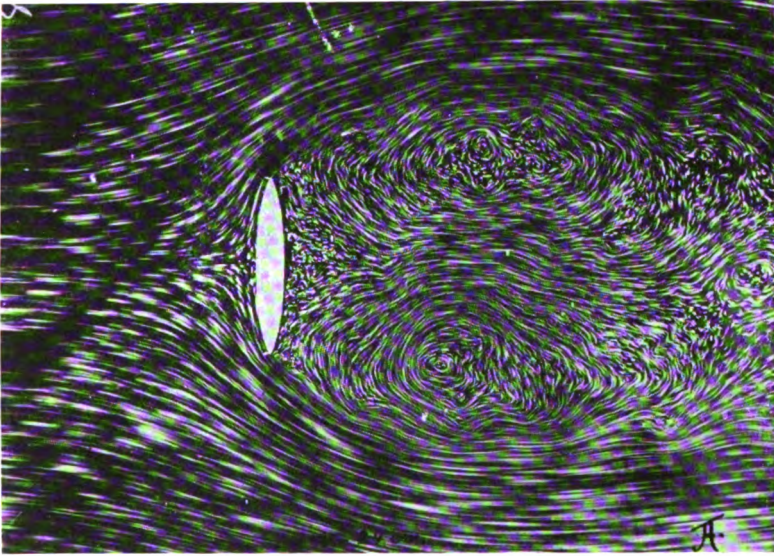

FIG. 12.—Twin Eddies in Wake. Note the Line of Discontinuity Enclosing the Eddies.

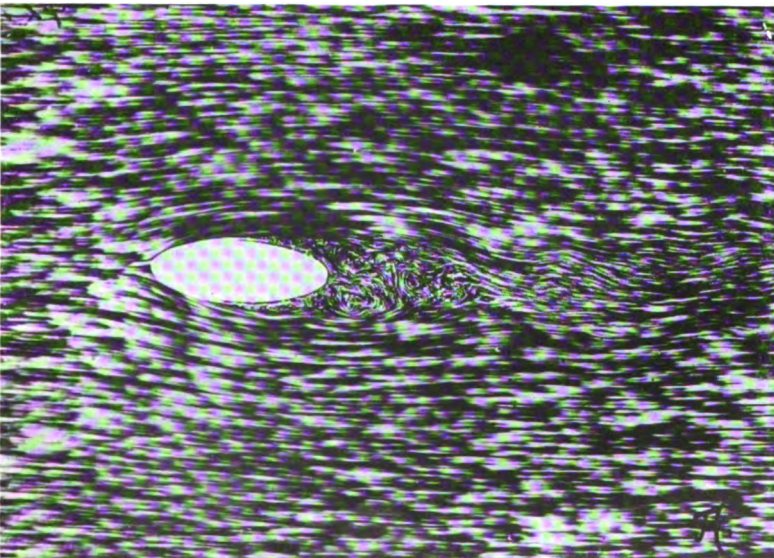

FIG. 13.—An Easier Form. Compare with Fig. 12 and Note the Enormous Decrease in Size of Eddies. True Stream Line Flow Holds Only as Far as Amidships.

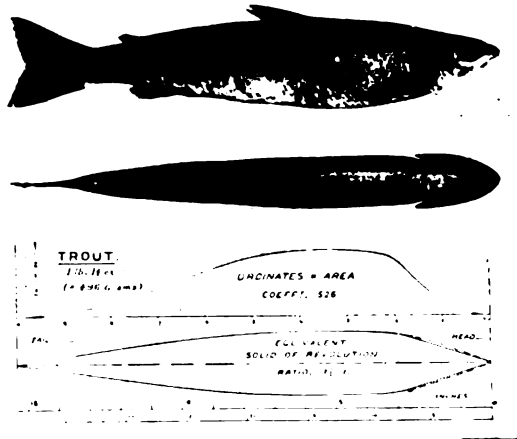

FIG. 14.—Sectional Areas of Trout. (After Lanchester.)

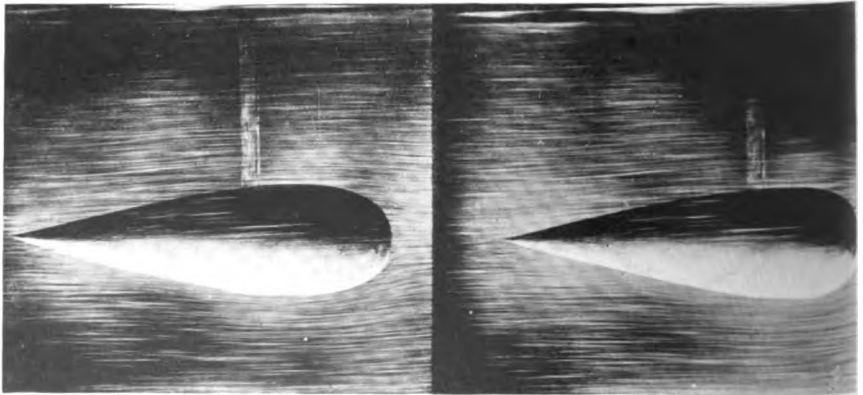

FIG. 15.—Stream Lines Relative to Airship Model. Note Absence of Eddies. (Stereoscopic View after Ahlborn.)

balls *A* and *B* which are about  $\frac{1}{4}$  inch apart, the blast of air, instead of blowing the balls apart as might be expected by "common sense," sucks them together until they make rolling contact. The balls rotate under the action of skin friction.

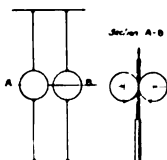

FIG. 16.—Showing How Two Balls Are Sucked Together by a Blast of Air Passing Between Them.

### MAGNUS EFFECT

When a base ball is thrown with a spin the air, being viscous, is speeded up on one side and slowed down on the other. As a result there is a decrease of pressure on the side where the relative velocity is higher and the ball tends to curve to that side. A similar explanation holds for the curved flight of golf and tennis balls. The force of the air on a cylinder held in a blast of wind has been found experimentally to be increased fourfold if the cylinder spins at 10,000 revolutions per minute and this force is now inclined 60 degrees to the direction of the wind.

As I throw ping pong balls from a trough lined with sand paper the balls will start off with a spin toward the sand paper side and should curve toward that side in flight. If I am skillful enough, a ball thrown to spin correctly will soar on a rising trajectory. If you tee a golf ball too high and the head of your club passes under the ball you may see such a soaring trajectory.

### AERODYNAMIC LIFT

An airplane wing resembles the wing of a bird and is designed to produce a net aerodynamic reaction which shall be in a direction oblique to the wind so as to give a large vertical component or lift for a given horizontal component or resistance. Symmetrical shapes in the wind obviously are subjected to a symmetrical distribution of pressures and suctions giving rise to resistance only.

An airplane wing is cambered upwards and inclined to the wind in such a manner as to present the lower side at a small angle of incidence. As a result of this unsymmetrical presentation the air striking the lower surface is slowed up producing positive pres-



sures over the bottom surface. Likewise, the air following the camber of the top surface is speeded up giving rise to suction over the top. The total lift of the wing is the algebraic sum of these suctions from above and pressures from below. A good airplane wing obtains two-thirds of its lift from suction over the upper surface. The exact curvature of the upper surface is, therefore,

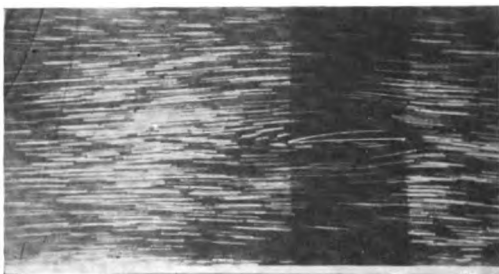

FIG. 17.—Flow Over a Wing at Small Angle of Incidence. (The Wing is Shown in Section. The Dark Vertical Band is a Shadow.)

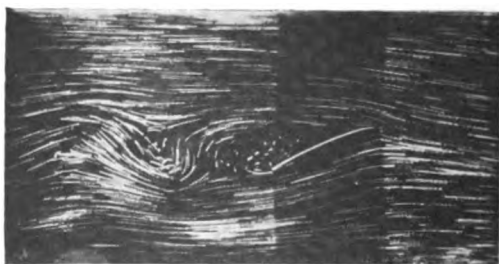

FIG. 18.—Flow Over a Wing at a Large Angle of Incidence. (Flow from Right to Left.)

of more importance than the form of the under surface, which may be flat.

Figure 17 shows an airplane wing at a small angle of incidence. The photograph is made in a water channel and the streaks are the paths of particles of illuminated sawdust during the period of exposure. Note how the streaks are longer above the wing indicating higher velocity. There are no apparent eddies made.

Figure 18 shows the same wing inclined at too great an angle. The lower side is effective in slowing up and deflecting fluid down-

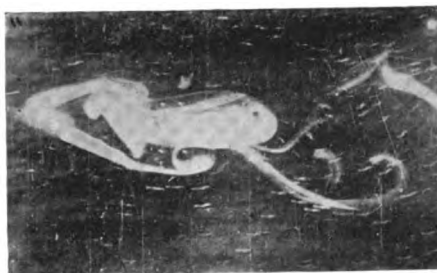

FIG. 19.—Eddy in Wake of Wing. Two Eddies Begin as Small Whirlpools. Flow is from the Left Visible by Condensed Milk in Water.



FIG. 20.—The Eddies of Fig. 19 have Expanded and Been Torn Away. The Direction of Stream Lines is Shown by the Short Bright Streaks.



FIG. 21.—The Two Eddies of Fig. 19 Become Detached and the Cycle is Repeated. Note Birth of New Eddy Behind Trailing Edge of Wing.

ward, and this surface is still giving a good lift. But the upper surface is so steeply inclined that the air cannot follow it but breaks away into violent eddies. The density resistance is very great and the wing is said to be stalled or to have reached a "burble point." The ratio of lift to resistance at small angles may be as high as 20 to 1, but at the critical angle this ratio may drop to 3 or 4 to 1. For this reason, airplanes must fly at angles of incidence less than this critical angle which is of the order of  $16^\circ$  for most wings. There is not engine power enough to fly at greater angles and the aeroplane stalls and dives if unluckily the safe limit is exceeded.

The formation of eddies by an airplane wing is a periodic phenomenon identical with the generation of eddies in the wake of any badly shaped body. Figs. 19, 20 and 21 are from a moving picture film taken to show the birth, growth and dissipation of the vortex behind the leading edge and alternately the corresponding but smaller vortex which forms at the surface of discontinuity at the trailing edge. The frequency of this eddy generation is such that dangerous vibrations can be set up in the wings of an airplane if the natural period of the structure happens to be right.

The lift of a wing is given by the pressures and suction on it. This is, however, merely the mechanism by which the reaction of the air is transmitted to the wing. Fundamentally, the lift is due to deflecting air downward; imparting downward momentum. If no air is deflected down there is no lift. Ultimately the weight of the airplane is transmitted to the earth, and were we able to measure so slight a disturbance of the barometer, we should find that the pressure is increased when an airplane flies over us.

#### AIRPLANE EQUILIBRIUM

An airplane in flight is in equilibrium when the aerodynamic reaction is just balanced by the weight of the machine and the thrust of its propeller, while the moments of these forces balance one another. Similarly, when the engine stops, the airplane must glide downward on an inclined path such that the component of gravity balances the resistance. Consider gliding as the simplest case, then Fig. 22 shows the balance of forces. The airplane will glide at an angle whose tangent equals the ratio of lift to resistance and at such a speed that sufficient lift is developed by the wings.

Thus for every angle of glide there is one and only one proper speed. Likewise, since the forces acting must have no moment for a given balance or center of gravity location, there corresponds a particular angle of glide for which the reaction of the air passes through the center of gravity. An actual airplane may glide at different angles and different speeds as the pilot may set his diving rudders or elevators. For every position of the elevators, corresponds one gliding attitude for which the forces are in equilibrium.

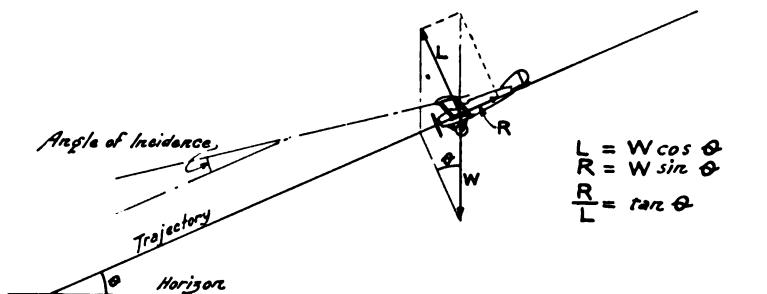

FIG. 22.—Balance of Forces in a Glide.

### AIRPLANE CONTROL

In flight an airplane is controlled or steered in three dimensions by means of the ordinary horizontal and vertical rudders of the submarine with the addition of a third control, the ailerons. Ailerons are flaps trailing behind the wing tips, which when turned up or down impress a rolling moment on the airplane. This completes the "three rudder" system of control necessary for controlled motion in three dimensions.

Since control is entirely aerodynamic, it follows that the airplane must preserve its velocity. Loss of normal speed due to any cause is immediately followed by partial or complete loss of control. An airplane must not only keep moving to stay up, but must move at its normal speed in order that control may be maintained.

### AIRPLANE STABILITY

The mathematical theory of airplane stability cannot be gone into here, but we can consider something of the general nature of

the problem, at least sufficiently to show that there is a problem essentially aerodynamic in nature.

An airplane is dynamically stable in flight if, when disturbed for any reason from its natural attitude of flight, it tends to return to that attitude without the intervention of the pilot. In other words, its equilibrium is stable.

A stable airplane may go through various oscillations in pitch, roll and yaw while getting back to equilibrium and the pilot by his control may intervene to limit the disturbance. However, if an airplane is too stable its motion may be so violent that the pilot has difficulty in controlling it. It may for example, carry so much weather helm as to make it unhandy for rapid maneuvering. What is desired is some stability but not too much.

A definitely unstable airplane is dangerous, no matter how the controls are operated as such a machine requires constant attention to keep it right side up.

Stability in three dimensions involves motion in pitch, roll and yaw. The motion involving pitching is called longitudinal and is two dimensional. The motion in yaw and roll is called lateral and is more complicated. To observe the general nature of the problem, let us consider only the simple case of the longitudinal motion.

### LONGITUDINAL STABILITY

It is evident that for the equilibrium in a given glide to be stable, there must be restoring or righting moments called into play when the airplane pitches. If the airplane wings and tail surfaces are correctly designed, an aerodynamic righting moment can be produced which is in every way analogous to the righting moments acting on a ship when it rolls. This righting moment is characterized by a metacentric height similar to the metacentric height of a ship. For small airplanes to be quickly maneuvered the metacentric height is 3 or 4 ft. For large seaplanes 12 to 20 ft. is usual.

The righting moment is caused by a shift of the line of action of the net aerodynamic reaction on the airplane as shown in Fig. 23. There the vectors represent the total force on a model airplane for different attitudes. Note that if the model stalls or presents its wings at a large angle, the resultant force vector shifts behind the center of gravity and lifts the tail. Similarly, if the model dives, the vector shifts forward and lifts the nose. There is one

stable attitude of equilibrium where the vector passes through the center of gravity.

To arrange the shifting of vectors in such a manner as to give an adequate restoring moment, but not too much, is a matter of design and involves many factors but principally the size and position of the horizontal tail surface or "stabilizer." The latter in accordance with Penaud's principle is inclined slightly upward.

Stability depends on the shifting of vectors relative to the center of gravity. It is of extreme importance to locate the center of gravity correctly. If too far back the vectors do not pass in rear of it until the airplane has already stalled and lost speed. The righting moment will then throw the airplane into a steep dive to

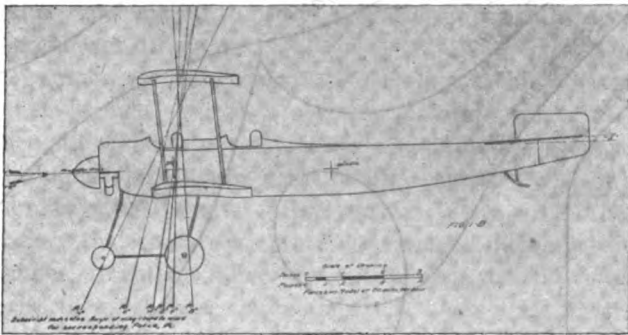

FIG. 23.—Vectors Representing Total Air Force at Different Angles of Incidence.

pick up speed. Such a machine, while stable, is very dangerous as it is likely to stall at a low altitude and then dive into the sea in spite of the pilot's efforts. Its natural path in space will look like a section of the Rocky Mountains.

Similarly, if the airplane is balanced too far forward, other troubles are introduced.

A righting moment implies, oscillations or hunting about the attitude of equilibrium. The inherently stable airplane may over-correct itself. To quench such oscillations it is necessary to provide damping surface on the tail. It is possible to arrange matters so that only a gentle undulation will remain.

This pitching motion of a plane is called the phugoid oscillation, and Lanchester has shown that depending on the balance and aero-

dynamic features, an airplane can take one of the paths in space shown in Fig. 24.

The series of paper airplane models which my assistant will launch from the gallery will exhibit these various types of motion.

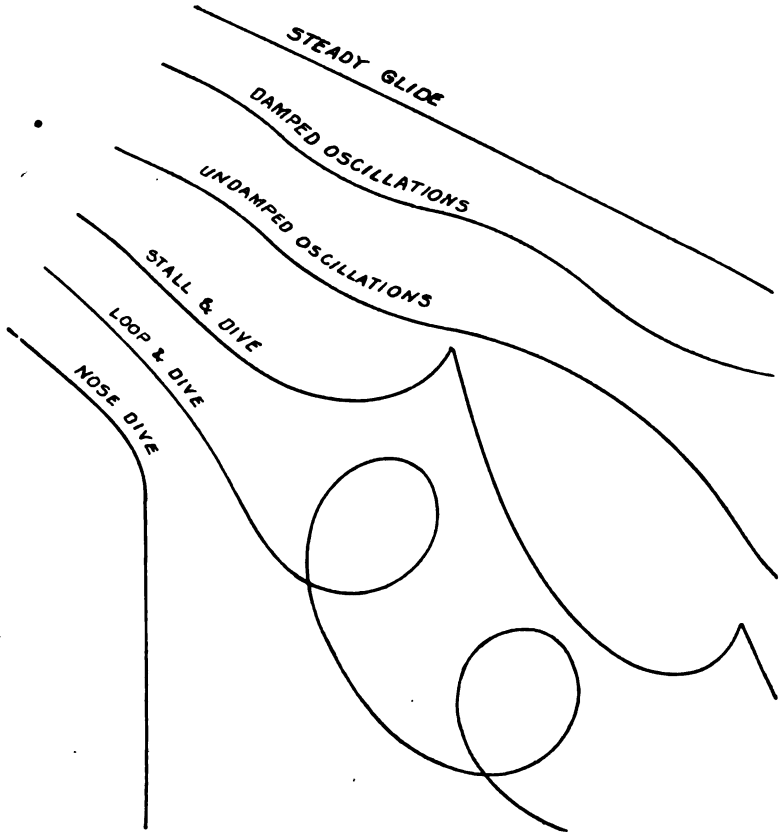

FIG. 24.—Various Possible Trajectories for a Gliding Airplane Depending on Balance and Stability.

The models are all identical but the center of gravity of each has been so adjusted by means of a small weight that the model will glide in accordance with one of the flight paths shown.

[COPYRIGHTED]

U. S. NAVAL INSTITUTE, ANNAPOLIS, MD.

---

## DISARMAMENT AND FOREIGN TRADE

By REAR ADMIRAL BRADLEY A. FISKE, U. S. Navy (Retired)

---

P. T. Barnum declared "the public like to be humbugged." This seems to be true; for, by merely substituting the word "disarmament" for the word "pacifism," William J. Bryan, Jane Addams and others are enabled to preach actual pacifism with success, and humbug hordes of people.

They employ the same arguments now in preaching disarmament that they formerly did in preaching pacifism. Their arguments rest actually, though not obviously, on one major premise which may be stated thus—"the world is different from what it actually is and always has been." If the world actually were different, if the nations that comprise it were not engaged in competition with each other, if nations were less selfish than the individuals who comprise them, if those individuals would moderate their desires, or if they could be made to moderate them by other means than force, then the pacifists, or disarmamentists, would be right.

But what kind of a world is this? What does the record of men's activities for more than 5000 years tell us? The most obvious fact is that men have produced a wonderful civilization.

But what is it that has spurred men to exert themselves to achieve this civilization? Obviously, the spur has been the necessity imposed on the individual men to "make a living"; for, except in the warm and moist countries of the tropics where little civilization has been achieved, men have had to work in order to obtain food, shelter and clothing. Unfortunately, some men have been able to get more than others. From this cause, fights have arisen throughout the life of the human race: men have fought for what they wanted, during hundreds of thousands of years; just as now two dogs will fight for a bone.

Now one of the most significant facts of history (and of daily experience) is that men and nations rarely fight merely to fight,



even if they seem to do so. Fighting is an exceedingly tiresome and exceedingly dangerous activity; and people do not resort to it without great cause. The usual cause is a desire to get something, or to keep something that some one else is trying to get. Sometimes, the immediate cause is anger: but that anger has usually been caused by an attack made to get some money, land or other possession. Sometimes, the possession is an immaterial one, such as reputation.

The expression "self-preservation" is usually supposed to mean preservation of one's actual life. But the instinct to preserve our lives carries with it the instinct to surround ourselves with all the safeguards possible, and to make our lives as comfortable and happy as we can. These ends are best served (in the eyes of most people) by "making money"; because money is the best single medium of exchange, and is more accurately standardized than any other of the material and immaterial objects that men strive for. As there are not enough of material and immaterial things to satisfy everybody, there is tremendous competition to get them. Wherever there is competition, there is apt to be strife; and wherever there is strife, there is apt to be fighting of some kind. Back of every fight, there can usually be found competition for some thing.

It is a commonplace remark that nations behave like individuals. It is a fact, but the fact is continually forgotten. If it were not forgotten, we should not hear foreign trade and disarmament advocated by the same people; because armament is the only means by which a nation can guard its foreign trade. The misleading expression "International Law" makes most people forget that no law exists among nations which can control their relations with each other; and it causes many of those wholly wrong conceptions of international affairs that the disarmamentists spread. Let us not forget for an instant that there is no law in existence that controls, or pretends to control, any nation in its dealings with any other. Every nation is an absolutely independent organization, owing allegiance to nobody but itself.

It will help us to clear our mental view, if we visualize nations as actual individuals, engaged in continuous competition with each other, without any enforceable law regulating their conduct; just as jealous of each other as the bitterest individual competitors in trade, just as willing to enter into agreements which promise

advantage to themselves, just as shrewd, and just as willing to violate those agreements, when opportunity offers an advantage for so doing. Imagine a city without any enforceable law compelling its merchants to carry out their agreements!

Now no organization capable of enforcing law has ever existed, except a tribe or a nation; and a tribe or a nation can enforce law within itself only. For this reason, no organization that could secure world peace has ever existed, except a world-dominating nation. The Egyptian, Assyrian, Babylonian, Persian, Macedonian and Roman empires were such organizations, and maintained peace for long intervals over the then known world. To that kind of peace, the name *Pax Romana* has been given. It was maintained by armament; and, so far as the experience of mankind during 5000 years of recorded history can teach us, *armament is the only agency that can maintain even the approximate state of peace that the world has enjoyed in modern times.*

Let us laud trade frankly for the benefit it has wrought; but let us realize, at the same time, that the efforts made by traders have not been wholly unselfish. The beautiful white sails of the Phoenicians must have made stirring pictures, as the vessels that bore them flew over the bright blue waters of the Mediterranean, and threw the salt spray over their bows; but the men who spread those sails did so mainly to "make money," wherewith to live and to let their families live. Furthermore, the people who bought the wares that the Phoenicians brought did not buy them in order to help the traders to make money. They bought them to satisfy their own desires.

This brings us to the crux of the whole matter; for, while it is the struggles of men and nations to make money (or its equivalent) that constitute the immediate cause of war, it is the desires of people to secure the things which only money can secure, that causes those struggles to make money. *Therefore, it is the desires of people for the things that money buys that constitute the bottom cause of war.*

It seems plain, however, that (at least in modern times) it is not the desire of people for mere food, or mere shelter, or mere clothing that causes wars; because these things are not hard to get. At least, they would not be hard to get, if people wanted nothing else, and concentrated their efforts on getting them. In this case, people would have little reason to live any but an agri-

cultural life, spread evenly over the land; few causes of strife would arise, and actually no wars, in the modern meaning of that word. It is the desires of people for fine apparel, for sumptuous houses, for the fruits and the products of foreign lands—for luxury, in a word—that sends ships over the seas, that compels men to work in mines and factories, that causes great cities to be built, that induces people to live among surroundings that are artificial, that creates appetities that are artificial, that makes many a man a mere getter of money.

It has finally produced a Machine of Civilization so complex that not one man in the world can understand it all. This machine is now going at a speed that seems to be increasing and to be going to increase; with no goal in sight, and with so many causes of derangement present, as to suggest the possibility of an accident some day. The Fall of Rome is an example of a complete smash up of a machine of civilization; and the present condition of Russia supplies a similar example, though in a less degree. Both show that *a state of civilization is not necessarily a stable or permanent condition.*

In such a chaotic state of affairs as exists at present, any advocacy of disarmament, even partial disarmament, seems, to say the least, inopportune. Disarmament cannot possibly lessen the chance of war, and the need seems obvious for more strength in each nation and not less. Nations, fundamentally, fight to get what their men and women want; no matter whether they be savages who use clubs, or highly civilized Christians who use airplanes. The cause of nations fighting is not the weapons that they fight with, but the desires that they fight to gratify.

Many of those who are calling loudly for disarmament are also calling loudly for increasing foreign trade. Clearly, the projects are incompatible.

[COPYRIGHTED]

U. S. NAVAL INSTITUTE, ANNAPOLIS, MD.

---

## PROBABILITY AND ACCURACY OF GUN FIRE

By LIEUT. COMMANDER T. C. KINKAID, U. S. Navy

---

The laws of probability and chance, as expounded in a treatise on mathematics, are based upon conditions which never actually obtain in connection with gun fire on board ship but, nevertheless, these laws have a definite bearing on salvo dispersion and it is essential that the officer controlling a battery firing at long range have a detailed knowledge of these laws and appreciate the effect of natural dispersion on the spread of salvos.

If it were possible to construct a perfectly designed gun, firing perfect ammunition, controlled by perfect equipment, and to eliminate the atmospheric and other outside influences on the flight of projectiles, the laws of probability and chance would play little part in practical gunnery. Successive shots from such equipment would fall in the same place and gunnery would be reduced to an exact science.

This is not the case, however. Perfect equipment cannot be made, and successive shots fired from the same gun at the Naval Proving Grounds under the most nearly similar conditions that can be produced do not fall in the same place but are seen to move, both in range and deflection, forming a pattern, the size of which depends upon the design of gun and projectile, the consistency of the propellant charge and the variation in atmospheric effect upon the flight of the projectile. If a great number of shots are fired, under as nearly as possible the same circumstances, it will be found that the impacts are grouped closely together around one point and are more and more widely separated as the distance from that point increases.

The point about which the impacts are grouped is called the *mean point of impact* and its co-ordinates are the average co-ordinates of all the impacts. The deviations of projectiles from their mean point of impact are closely analogous to what are called

“accidental errors” and they obey the same laws. Small deviations are more frequent than large ones; positive and negative deviations are equally probable, and are therefore equally frequent if the number of shots is great; very large deviations are not to be expected at all and when one occurs it is frequently due to some avoidable mistake. The average of the deviations from the M. P. I. of a large number of impacts is called the *true mean error* of the gun.

In practical gunnery, we are interested only in the effect of these deviations on the dispersion of shots in a salvo and in the variations which occur in the mean points of impact of successive salvos. When we consider the deviation of projectiles we are not dealing with definite numbers (as in dice throwing), but with values which may be anything whatever between certain limits and we cannot assign any finite measure to the probability that a deviation shall have a definite value because the number of values it may have is unlimited. We can, however, measure the probability that a deviation will fall between certain limits or that it will be greater, or less, than an assigned quantity.

If a large number of shots ( $y$ ) are fired under the same circumstances and ( $m$ ) shots are observed to fall 100 yards from the M. P. I., while the remainder ( $y-m$ ) fall more than 100 yards from that point, we say that the probability that a shot will fall within 100 yards of the M. P. I. is  $\frac{m}{y}$  and the probability that a shot will be more than 100 yards away is  $\frac{y-m}{y}$ . The probability that a shot will be less than 100 yards or more than 100 yards from the M. P. I. is  $\frac{m}{y} + \frac{y-m}{y} = 1$ ; that is, it is a certainty.

The probability curve is plotted with distances from the M. P. I. as abscissæ and the numbers of shots within those distances as ordinates, and, when the total number of shots is infinite, may be considered to consist of an infinite number of rectangles whose width is reduced to the infinitesimal  $dz$ . The width of each rectangle becomes the elementary area  $ydz$  and the whole area under the curve is  $\int_{-z_1}^{+z_2} ydz$ . The area under the curve between any two co-ordinates divided by the whole area measures the

probability that a deviation will be between those co-ordinates. The curve takes the form

$$y = \frac{1}{\pi D} \epsilon^{-\frac{z^2}{\pi D^2}},$$

where  $D$  = true mean error,  $\pi = 3.14159$ ,  $\epsilon = 2.71828$  and the factor  $\frac{1}{\pi D}$  has been introduced to make the whole area under the curve equal to unity,

$$\int_{-\infty}^{+\infty} \epsilon^{-\frac{z^2}{\pi D^2}} dz = \pi D,$$

thus obviating the necessity of dividing a partial area by the whole area whenever a probability is to be computed.

The plotted form which this curve takes is illustrated in the accompanying pattern analysis diagram, in which a true mean error of 200 yards has been assumed in order to bring out clearly the points illustrated. The curve is built up of a series of rectangles whose bases are the distances every 50 yards (one-fourth the error assumed) on each side of the M. P. I. and whose heights are the percentages of shots to be expected within those limits. The figures written in the corners of the rectangles represent the additional percentages for the additional 50 yards distant from the M. P. I. and are additive as the distance from the M. P. I. increases. This diagram also shows the maximum spread and maximum movement of the M. P. I. to be expected for 12-gun, 10-gun and 6-gun salvos, which will be discussed later. It also shows the 50 per cent zone for an infinite number of shots.

The probability that a single shot will fall more than four times the mean error from the M. P. I. is very small, and such rounds are very likely to have been fired under circumstances dissimilar to those of other rounds. The pattern, therefore, may be considered as eight times the mean dispersion. The probability that the deviation of any shot will be numerically less than any given quantity is

$$P = \frac{2}{\pi D} \int_0^a \epsilon^{-\frac{z^2}{\pi D^2}} dz,$$

where  $a$  is the limiting distance from the M. P. I. Values of  $P$ , with the ratio  $\frac{a}{D}$  as the argument, have been calculated and tabulated in Alger as follows, so that it is only necessary to know the

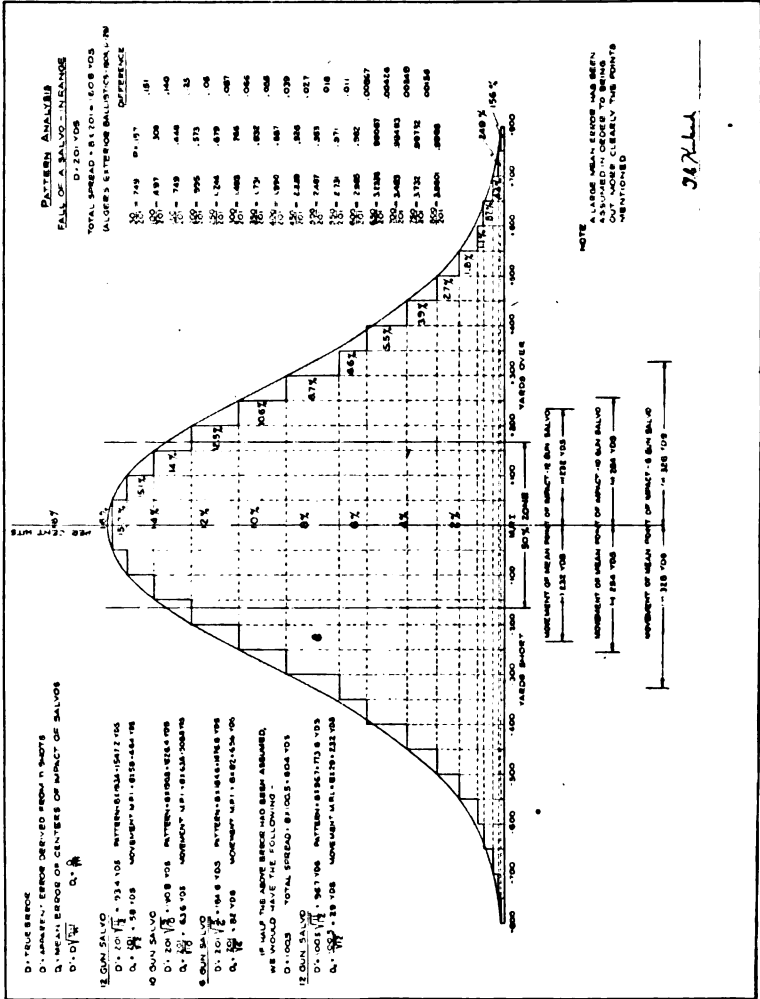

mean dispersion to pick out the probability of a single shot falling within certain limits.

PROBABILITY OF A DEVIATION LESS THAN  $a$  IN TERMS OF THE RATIO  $\frac{a}{D}$

$\frac{a}{D}$	$P$	$\frac{a}{D}$	$P$	$\frac{a}{D}$	$P$	$\frac{a}{D}$	$P$
0.1	.064	1.1	.620	2.1	.906	3.1	.987
0.2	.127	1.2	.662	2.2	.921	3.2	.990
0.3	.189	1.3	.700	2.3	.934	3.3	.992
0.4	.250	1.4	.735	2.4	.945	3.4	.994
0.5	.310	1.5	.768	2.5	.954	3.5	.995
0.6	.368	1.6	.798	2.6	.962	3.6	.996
0.7	.424	1.7	.825	2.7	.969	3.7	.997
0.8	.477	1.8	.849	2.8	.974	3.8	.998
0.9	.527	1.9	.870	2.9	.979	3.9	.998
1.0	.575	2.0	.889	3.0	.983	4.0	.999

As an illustration of the use of this table, taking  $a=200$  yards and  $D=100$  yards, we find that for  $\frac{a}{D} = \frac{200}{100} = 2, P = .889$ ; that is, for a gun whose mean error is 100 yards the probability of a single shot falling within 200 yards of the M. P. I. is .889. If  $P$  is the probability that the deviation of a single shot will not be greater than  $a$ , then evidently  $100P$  will be the probable number of shots out of 100 which will fall within the limits  $\pm a$ ; in other words,  $100P$  is the percentage of hits to be expected in an area  $2a$  wide with its center at the M. P. I. Thus, we see that the area in which 25 per cent of all shots may be expected to fall is  $\pm .4D$ ; the 50 per cent zone is  $\pm .846D$ ; the 75 per cent zone is  $\pm 1.445D$ . The half-width of the 50 per cent zone,  $.846D$ , is the probable deviation since it is the deviation which is just as likely to be exceeded as it is not to be exceeded.

If the M. P. I. falls a distance  $d$  from the center of the danger space of a target whose danger space is equal to  $S$ , then the percentage of hits to be expected from an infinite number of shots is:

$$\% \text{ hits} = 100 \times \frac{1}{2} \left[ P_1 \left( \text{for } \frac{a}{D} = \frac{d + \frac{S}{2}}{D} \right) - P_2 \left( \text{for } \frac{a}{D} = \frac{d - \frac{S}{2}}{D} \right) \right]$$



Thus, if  $d=200$  yards,  $S=100$  yards and  $D=100$  yards, we have

$$\frac{d + \frac{S}{2}}{D} = \frac{250}{100} = 2.5 = \frac{a}{D} \therefore P_1 = .954$$

$$\frac{d - \frac{S}{2}}{D} = \frac{150}{100} = 1.5 = \frac{a}{D} \therefore P_2 = .768$$

$$\begin{aligned} \therefore \% \text{ hits} &= 100 \times \frac{1}{2} (.954 - .768) \\ &= \frac{100 \times .186}{2} = 9.3 \text{ per cent} \end{aligned}$$

on a target whose danger space is 100 yards, if the M. P. I. falls 200 yards from the center of the danger space, the mean error of the gun being considered to be 100 yards. The same percentage of hits would be made whether the M. P. I. fell over or short.

The following table shows the percentage of hits to be expected, on a target whose danger space is 100 yards, from a gun whose true mean error is 100 yards for different locations of the M. P. I.:

PER CENT HITS FOR DIFFERENT LOCATIONS OF M. P. I. RELATIVE TO THE TARGET

$d$	Per cent hits	$T$
		<i>Formula</i>
0	31.0	Per cent hits $= 100 \times \frac{1}{2} \left[ P_1 \left( \text{for } \frac{a}{D} = d + \frac{S}{2} \right) - P_2 \left( \text{for } \frac{a}{D} = d - \frac{S}{2} \right) \right]$ $S = \text{danger space} = 100 \text{ yards.}$ $D = \text{true mean error of gun} = 100 \text{ yards.}$ $d = \text{distance of M. P. I. from center of danger space.}$ $P_1, P_2 = \text{probability of shots falling within limits given.}$
50	28.8	
100	22.9	
150	15.7	
200	9.3	
250	4.7	
300	2.05	
350	.8	
400	....	

It will be noted that the percentage of hits decreases rapidly as the M. P. I. is moved away from the center of the danger space. This reduction takes place more rapidly in the case of a pattern resulting from a small mean error than in the case of a pattern due to a large mean error. The following table shows the percentages of hits to be expected on a 100-yard danger space from an *infinite* number of shots fired from guns having mean errors of from 50 yards to 250 yards where the M. P. I.'s are various distances from the center of the danger space. If the fire cannot be regulated to bring the M. P. I. on the center of the danger space, it may be detrimental to have too small a mean error. From examination of the table we find that, if the M. P. I. is 50 yards from the center

of the danger space, a gun with a 50-yard mean error should get about twice as many hits as a gun with a mean error of 150 yards. If, however, the regulation of fire brings the M. P. I. within only 200 yards of the center of the danger space, the gun with a 50-yard error gets practically no hits, while the gun having a mean error of 150 yards should get about 12 per cent hits. The most efficient mean error, and therefore pattern, is directly dependent upon the ability to control the fire; that is, upon the relative positions of the M. P. I. and the center of the danger space of the target.

TABLE OF HITS FOR DIFFERENT MEAN ERRORS AND DIFFERENT POSITIONS OF THE M. P. I.

d yards	Per cent hits on 100 yard danger space				
	D=50 yards	D=100 yards	D=150 yards	D=200 yards	D=250 yards
0	57.5	31.0	20.9	15.8	12.7
50	44.5	28.8	20.3	15.5	12.5
100	20.4	22.9	18.3	14.6	12.1
150	5.5	15.7	15.3	13.3	11.4
200	.9	9.3	12.1	11.6	10.4
250	....	4.7	8.9	9.7	9.3
300	....	2.1	6.1	7.8	8.0
350	....	.8	3.9	6.1	6.8
400	....	.25	3.1	4.6	5.7
450	....	....	1.3	3.3	4.6
500	....	....	.7	2.2	3.6

d = distance of M. P. I. from center of danger space.

Heretofore, we have considered only shots fired from a single gun. If several shots could be fired at the same time from one gun, or if a salvo is fired from several exactly similar guns, the spread of the salvo, or the pattern, will have a certain relation to the number of shots in the salvo and to the mean error of the gun. The probability that a 12-gun salvo will make as large a pattern as an infinite number of shots is very small. The probable salvo limits are the limits outside of which no shot will probably fall. If the total probability *outside* of such limits is therefore unity, or less, it must be  $\frac{1}{n}$  for each of  $n$  shots in a salvo. The probability of falling *within* these limits is therefore

$$P = \frac{n-1}{n}$$

and for a 12-gun salvo, we have

$$P = \frac{n-1}{n} = \frac{11}{12} = .917$$

∴ from the table  $\frac{a}{D} = 2.17$  (corresponding to  $P = .917$ )

$$a = 2.17D = 217 \text{ yards,}$$

the total spread =  $2a = 434$  yards which is the *average* spread to be expected for 12-gun salvos fired from a gun whose true mean error is 100 yards.

The apparent mean error for  $n$  shots is

$$D_1 = D \sqrt{\frac{n-1}{n}},$$

and for a 12-gun salvo, we have

$$D_1 = 100 \sqrt{\frac{11}{12}} = 95.7 \text{ yards.}$$

The *maximum* pattern to be expected for a 12-gun salvo is

$$8D_1 = 8 \times 95.7 = 765.6 \text{ yards,}$$

and all 12-gun salvos should come within this limit.

If only a few shots are fired in a salvo, the M. P. I. of those shots does not necessarily coincide with the M. P. I. of an infinite number of shots and the M. P. I.'s of successive salvos would shift back and forth. The greater the number of shots in a salvo, the more nearly we may expect the M. P. I. of the salvo to coincide with the M. P. I. of an infinite number of shots. The error of the M. P. I. of a salvo varies inversely as the square root of the number of shots in the salvo and we have

$$D_0 = \frac{D}{\sqrt{n}}$$

where  $D_0$  is the mean error of the M. P. I. of the salvo. For a 12-gun salvo

$$D_0 = \frac{100}{\sqrt{12}} = 29 \text{ yds.}$$

The maximum movement of the M. P. I. for successive salvos is

$$8D_0 = 232 \text{ yards;}$$

that is, the M. P. I. of a 12-gun salvo may have an error of (+) or (-) 116 yards from the M. P. I. of an infinite number of shots. The average movement should be about (+) or (-) 63 yards.

The following table shows the patterns and movements of M. P. I. to be expected when salvos containing various numbers of shots are fired:

TABLE OF PATTERN SIZES AND MOVEMENTS OF M. P. I.  
*D* = 100 Yards

No. shots	1	2	3	4	5	6
	Apparent mean error = $D_1$	Maximum pattern to be expected	Average pattern in terms of <i>D</i>	Average pattern in yards.	Mean error of M. P. I. in terms of <i>D</i>	Max. movement of M. P. I.
1	.....	.....	.....	.....	1.00	800
2	70.7	565.6	1.69	169	.71	568
3	81.6	652.8	2.43	243	.58	464
4	86.6	692.8	2.89	289	.50	400
5	89.4	715.2	3.21	321	.45	360
6	91.3	730.4	3.47	347	.41	328
7	92.6	740.8	3.67	367	.38	304
8	93.5	748.0	3.85	385	.35	280
9	94.3	754.4	3.99	399	.33	264
10	94.9	759.2	4.13	413	.32	256
11	95.3	762.4	4.24	424	.40	240
12	95.7	765.6	4.35	435	.29	232
100	99.5	796.0	6.40	640	.10	80
1,000	99.9	799.2	8.00	800	.03	24

NOTES: Column 1:  $D_1 = D \sqrt{\frac{n-1}{n}}$ ; figures are rough.

Column 2: 8 times Column 1.

Column 3: Twice the value of  $\frac{a}{D}$  corresponding to  $P = \frac{n-1}{n}$  in table; considering the probability of going outside of limits as unity.

Column 4: *D* times Column 2.

Column 5:  $D_0 = \frac{D}{\sqrt{n}}$ .

Column 6:  $8D_0$  (8 times Column 5  $\times D$ ); the maximum error is one-half of the figure in this column (+) or (-).

The application of the foregoing theory to the firing of a battleship at sea is rather difficult and we are reduced to considering probabilities. The main battery of a dreadnought consists of from 8 to 12 different guns, in as many different mounts, in from 4 to 6 double or triple turrets with as many different foundations, and the whole structure of the ship is subject to hogging, and bending,

so that the shots are not fired under "similar circumstances." Also errors are introduced due to the oscillation of the guns about the center of gravity of the ship in rolling and pitching; sight setting, gun laying, ramming of projectiles, different temperatures of powder, different resistances in firing circuits and differences in bore-sighting all produce errors; and, finally, the errors of spotting and fire control take the M. P. I. off of the target. In addition, we should not forget that the number of shots fired is comparatively small and our reasoning must be based on the expected performance for only a few shots, not on the exact figures of the laws of probability and chance which are based on an infinite number of exactly similar rounds.

When a 12-gun salvo is fired from a ship, we know (assuming a mean error of 100 yards for the gun) that the maximum pattern to be expected from gun errors alone is 766 yards and the average 12-gun pattern should be 435 yards if no preventable errors (as distinguished from accidental errors) are present. If the spread of the salvo is 1000 yards, at least 234 yards (1000-766) and probably more of this spread is due to what we have called preventable errors and, if a large number of such salvos were considered, we would expect that 565 yards of this error was due to that cause, only 435 yards being due to accidental errors. We further find from the table that accidental errors may cause the M. P. I. of successive 12-gun salvos to move as much as 232 yards ( $\pm 116$  yards). Any movement greater than this is surely due to preventable errors, while a portion of this movement, the exact amount of which is indeterminate, may also be due to that cause.

A thorough understanding of the above probabilities and possibilities will be of great assistance to an officer controlling the fire of a battery. He should know the true mean error of his guns and from this can calculate the spread and movement of M. P. I. of salvos to be expected from accidental errors. He will have, from previous firings, data which will enable him to make a comparison between the theoretical spread and movement of M. P. I. and the spread and movement of M. P. I. actually obtained in firing. It is believed that such an examination will reveal the fact that preventable errors cause as much, or slightly more, spread and movement of M. P. I. as is caused by accidental errors. The information gathered from such an analysis, combined with observation of the fall of shots, will enable the control officer to correct the range in a systematic manner which is in accord with the laws governing the probability of gun fire.

[COPYRIGHTED]

U. S. NAVAL INSTITUTE, ANNAPOLIS, MD.

---

A COMBINED STAFF

By CAPTAIN J. M. SCAMMELL, Inf. R. C., U. S. Army

---

Due to the national situation in the United States, geographical and general, and to national policy, future wars of the United States must be expected to include operations overseas, both of attack and defense, which will require active coöperation and will be more or less successful as that coöperation is more or less complete.

This quotation is taken from an address delivered before the Army War College in 1907 by Admiral (then Commander) H. S. Knapp, U. S. N. Since that time our military and naval operations in the World War have conformed to the above prediction.

Victory crowned our arms; while the coöperation between General Pershing and Admiral Sims was more than harmonious—even cordial—a study of the evidence submitted before the Senate Investigating Committee proves that the absence of a common doctrine did much to weaken the effect of our participation, and that thereby the war was prolonged and treasure and lives uselessly expended. Thus the record of the Hearings of the Senate Committee enables us to verify the second part of Admiral Knapp's prediction.

Had we, instead of having Allies to establish for us our bridge-heads, had to force for ourselves a landing and to have protected our own communications, as the British were forced to do at Gallipoli, this absence of a common doctrine and of a common plan would probably have had equally disastrous consequences. To-day, considering the military weakness of Mexico, and not only the historic good feeling that has endured upon our northern frontier, but also the prevalence of a mutual conviction and determination that this cordiality must and shall continue to exist, the statement of Admiral Knapp takes on an even more intense form. We may accept as an axiom that all our future wars must be

combined overseas operations. And yet practically nothing has been done to define the relationship that should exist between the army and the navy in the problems of strategy, logistics, command and tactics involved in overseas operations.

Of this coöperation, in the same address above alluded to, Admiral Knapp said :

Neither the army nor the navy is self-sufficient, but each is the complement of the other in the national defense, and consequently coöperation, potential or actual, is always necessary.

This problem of coöperation has been solved in various times by various peoples in various ways. In antiquity there existed no distinction between military and naval command. Soldiers embarked upon ships and became sailors and marines. Brasidas was equally at home upon the quarterdeck of a trireme or upon the quarterdeck of a horse. Cæsar, better than any other, embodies the normal Roman conception of command in war ; he was neither a general nor an admiral, but a Roman Governor given military powers which he exercised brilliantly against the enemies of the republic when they made war on land, and with equal brilliance against them on sea if they took to salt water. Even as late as the time of Cromwell, generals commanded fleets as well as armies, and Blake was "A sort of a bloomin' cosmopolouse—soldier an' sailor too."

To-day the rule of all the powers, save the warlike but unmilitary Anglo-Saxons, is that expressed by General von Janson: "One man should be in command, naturally the senior officer."

This was also the rule in Great Britain until the royal power was broken. The English "Fear and dread of Kings" led to a deep suspicion of the military as a bulwark of tyranny—so deep that even to-day it is used as a bobby-jock in Parliament and Congress alike to hush the crying public: "The goblin of militarism will get you if you don't watch out." Of course it was the mercenary soldiery, and foreign mercenaries at that, which threatened the liberties of our fathers; de Vigny has shown how absurd it is to fear that an army which is the citizens can overthrow their own liberties, and yet of all the powers, we alone, the English and the Americans, do voluntarily retain the professional army. Thus it is purely because of historical influence, because originally it was desired to weaken the coöperation of the two services for political reasons, that to-day we retain the weakest type of command.

The disadvantages of this divided command are and have been acknowledged, studies have been made of how to minimize them and the first steps have been taken to overcome them.

Admiral McCully stated to the Naval War College in 1911:

When the two services have a clear understanding of each other's point of view, much will have been accomplished, but even then it will be only by mutual and unselfish concessions that fortunate results may be anticipated." . . . .

And that:

Coöperation between naval and military men . . . . can only be attained through decisions arrived at during peace, free from the friction and irritation that might ensue if required in the stress of an emergency, when action may be imperative.

Admiral Knapp expressed his conclusion that:

Coöperation has its foundation head at the seat of government, where operations will usually be planned and ordered. From there the spirit of coöperation should extend throughout the services to the last private and landsman.

It is doubtful in the extreme if there can be found any soldier or sailor who will deny the truth of any of the above statements. And yet to-day the number of those in either service who have had the opportunity or the leisure to study the problems of the other is small, and above all, there is no guarantee that any of these favored few will be those chosen for the supreme command when war is upon us.

A solution of these difficulties was proposed by Major W. W. Harts, U. S. M. C., in a lecture before the Naval War College in 1912. It included five points as follows:

I. Regulations should be adopted, perhaps by a joint board, as extensive as practicable, to be embodied in the official books of regulations of the army and navy, which will expressly outline the duties of each branch of the country's military forces and limit its sphere of action and authority in all joint operations whenever differences in jurisdiction are likely to arise.

II. Combined maneuvers involving embarkation and debarkation should be as frequent as practicable and the regulations above mentioned vitalized periodically by the results.

III. Provisions should be made for exchanging officers in time of war so that in all joint operations a selected officer of the navy should be found on the staff of the commanding general and similarly a representative of the army would be attached to the staff of the naval commander-in-chief.



IV. A standardization is desirable between the two services whenever practicable, including organization, ceremonies, badges, signals and equipments.

V. Several officers should be exchanged in times of peace in maneuvers, war college conferences and target practice. All subjects of defense involving both services should be examined by joint boards.

The interesting phase of the above proposals, as well as those of other writers, is that they implied but did not expressly advocate the organization which alone could have the influence and the authority to bring these consummations to pass. Major Robert E. Wyllie, C. A. C., in an address on "Coöperation between Army and Navy," in 1916, carried his arguments to their ultimate conclusion:

"In times of war," he said, "or of maneuvers, in all joint operations, the interchange of staff officers, and of observers, will be invaluable, and *all such operations should be planned and controlled by a combined General Staff.*"

The same year a committee met at the Naval War College by direction of the President of the College, Rear Admiral Austin M. Knight, to consider the subject of coöperation between the army and the navy. The committee was composed of the following officers:

Captain C. S. Williams, U. S. Navy.

Colonel J. W. Ruckman, C. A. C., U. S. Army.

Commander C. T. Vogelgesang, U. S. Navy.

Major G. C. Thorpe, U. S. M. C.

Lieut. Colonel John P. Haines, C. A. C., U. S. Army.

The first three signed the majority report. The last two signed minority reports which, "agree to all essential points of the report except that both favor placing the Coast Artillery under the Navy Department." Therefore we are justified in concluding that the following extract represents the unanimous opinion of the above committee:

## 2. THE IDEAL ORGANIZATION TO SECURE COÖPERATION

It is an axiom of war that all operations of forces, both naval and military, should be confined within the frame of a joint plan of operations, well conceived and definite in its scope. This of course implies a control higher than that of the individual commander of the naval forces and the commander of the military forces—a control properly vested in a great general staff composed of officers of both services and acting as advisers to the highest executive authority of the nation.

It is therefore the mission of a great General Staff in effect to direct the operations ashore and afloat. Such staff should therefore properly be composed of officers of the army and navy—the officers for this purpose must therefore be most carefully chosen. The most competent and intelligent naval officer will not properly fill his place on such a staff unless he is familiar with the conceptions of warfare on land, nor would the most competent and intelligent army officer properly fill his place on such a staff unless he were familiar with conceptions of warfare on the sea.

This report was approved by Admiral Knight on July 6, 1916, and by naval operations on November 23 of the same year.

This is the proposal which has been since put forth in England,<sup>1</sup> and which was referred by Lloyd George to the Imperial Conference.<sup>2</sup> It is a proposal which the organization of the Royal Air Force into a separate third service in the British Empire makes still more urgent. The awkward features of fighting two separate campaigns in the same theater of operations as disclosed by the Dardanelles Report, serves to indicate how still more embarrassing three separate campaigns might be.

Such a combined staff, the original plan of organization carefully worked out but regarded as provisional and to be modified through the lessons of experience, would be a powerful asset in many ways.

In the first place there would be gathered together officers capable of determining the proper relations between military and naval aviation; there would be found officers capable of determining such vexed problems as the relative value of battleships, torpedo-planes and submarines; and there would exist a body able to determine and initiate a common doctrine.

There an historical section could compile and classify, and a planning section utilize, the facts of history which would lead to a book of regulations laying down the tactical principals to be followed by each service in landing operations. A combined staff would give a simple organization rather than the present clumsy, expensive and inefficient machinery for ordering combined maneuvers to test and try out these regulations. Such a body could with equal ease and equal certainty prescribe the liaison officers to be

<sup>1</sup> "Imperial Strategy and a Combined General Staff," by Lieut. Col. J. C. Dundas, D. S. O., R. A., General Staff, in *The Journal of the Royal United Service Institution*, November, 1920.

<sup>2</sup> "Defense of the British Empire," by Major General Sir John Davidson, in *The Army Quarterly*, January, 1921.

<sup>3</sup> Editorial, *The Army Quarterly*, April, 1921.

exchanged. A combined staff would also provide a suitable source to which the President, the Secretary of War and the Secretary of the Navy could have recourse for advice. With such a staff, would it have been likely that, as happened at one period in the recent war, the War Department and the Navy Department would have different policies?

So radical a departure from our usual practice will doubtless take a long time to bring about. The public must be educated to support it, and perhaps too the army and the navy. There may be also prejudices and interests to be overcome. That it will come inevitably some day, cannot be doubted. Meanwhile, since the first step, the exchange of army officers to the Naval War College and of naval officers to the Army General Staff College, has already been taken, the next step, the exchange of observers and staff liaison officers ought to be demanded and ordered. Then, in case of war, we would have at least a substitute of some value and a source of mutual understanding and of coördination; and, when the combined staff becomes a reality, we shall have officers ready and partially qualified to serve upon it, and to devise a common doctrine.

[COPYRIGHTED]

U. S. NAVAL INSTITUTE, ANNAPOLIS, MD.

---

THE SUPER NAVY. THE U. S. NAVY

By GRASER SCHORNSTHEIMER

---

Egotism is in the makeup of all of us. From admiral to newspaperman there is that "I want you to know how important I am," idea firmly implanted into each individual personality.

I can make no excuse for it—they would not remedy the fault. I have it, my readers have it and the world has it. It is there and it exists. To merely acknowledge it and pass on is not sufficient. It must be taken into consideration in all our plans and it must not be allowed to run away with our just discrimination or sway our opinions.

Undeniably, Americans are braggers, and sometimes with little to brag about. Naval officers, civilians and all others are included in this. During the past year or so, this sort of thing has been working steadily to the detriment of the navy. It must be checked at once.

The American citizen has been harangued with America's super-superiorness to such an extent that he believes his country to be infallible, unbeatable and entirely indispensable to every other nation. Now this is all well and good from a patriotic standpoint, but its practical side reflects only supreme neglect of the more important functions of our national government.

Once before we have had a situation identical to the present one. Especially among navy men have I found that the lesson of this situation was well known, but somehow or other it has been neglected. Also, there exists a very decided tendency to brag and "ego" away its rightful effect. After the Civil War our navy, which was supposed to be the most powerful in the world, rusted to pieces on the stocks. Most of my readers know the details of this far better than I do. What I want to drive at is the underlying reason for it, that it may not happen again.

Most of the navy will answer me that it was the "lack of sufficient funds from Congress." Yes, that was the direct cause, but that is old stuff—just plain "passing the buck," for the real cause is much deeper.

As a newspaperman I have had to make rather a complete study of the psychology of Mr. Ordinary American Citizen, who happens to be in the great majority. Of late I have been writing almost exclusively for American naval expansion and I have run up against this trouble. I have located it and am taking this opportunity to bring it to light.

Advertising and press agenting the United States Navy as the most powerful and only infallible naval force in the world is responsible for the defeat of the General Board's program for new ships and for the exclusion of other essentials from our new naval appropriation bill. Our people have been led to believe that we have sufficient ships, planes and everything else—for didn't we build everything by the "millions" during the war and were we not ahead of everyone else by a terrific margin?

Hasn't it been said since the war that we are ahead of even England?

A year or so ago, a high naval officer wrote a magazine article in which he pointed out that our navy would be the most powerful in the world within a few years. This article was accepted as authority by almost every newspaper and news service in the country and it was widely copied. The only difference was that most papers rewrote it "*is* the most powerful." Hence the people accepted it and to-day they believe further naval expenditures are unnecessary and in Congress assembled, they refuse to be bled. I am dealing with the people through the columns of the newspapers every day and I am quite sure that this is their opinion, for I have tried my best to help change it, only to be thwarted by some totally unjust superlatives.

Since that article was published, England has decided to build four ships of more than 43,000 tons displacement, to carry eight 18-inch guns. These ships will undeniably maintain England's position as the first naval power. Also, the Japanese naval program is coming to light and from the details of the first eight ships of the new program it is to be seen that unless the latter six battleships of our 1916 program are completed we will be well on our way to the third naval position and if the information con-

cerning the latter eight ships of the Japanese program is at all correct, we will drop back to third place whether our big ships are completed or not.

But the American people stand convinced, by what has been more or less authoritatively published, that further naval appropriations are unnecessary. Not only this, but even the best informed imagine our 1916 program as totally complete. "It doesn't take six years to build a battleship," they say. Some may laugh at this because of its evident injustice, but only a short time ago I received a letter from one of the editors of a rather large inland paper, requesting me to get him some information as to "how well the *new* battleship *Indiana* did at the last target practice."

To-day, the people of the United States as a whole, can be interested in the navy. That is, they will take the trouble to read a navy news story if they see one, even in Kansas. The reason for this is that their sons found there was an ocean during the war, and they found it was a rather tough proposition. One must remember that 80 per cent of our voting population has never been aboard a battleship and the great majority of them never will. The navy will always be a vague dream to them. When asked to dig down into their pockets for extra taxes for the navy, which to them scarcely exists, they feel imposed upon, especially when they believe that the navy doesn't need the money.

Recently I visited one of our 1154-ton destroyers. She was at anchor in the Hudson. I came aboard as a casual visitor from an inland town, anxious to see one of these ships which performed so gloriously during the war. To my intense surprise I learned that we have the most powerful and best destroyers agoing. This rather aroused me and I asked concerning the new British flotilla leader *Shakespeare* and the destroyers of the *V* and *W* classes and about some of the Italian destroyers carrying 6-inch guns. I was observed with some surprise at this, but had I been the average civilian I represented myself to be, I would have most certainly left that boat confident that that particular vessel and all American destroyers in general, were the most wonderful boats of their type in the world. Now, as Mr. Ordinary Citizen from Oshkosh, I would say that the General Board's recommendation for flotilla leaders was all bosh and that the navy was powerful enough; being more powerful than any other navy. And I would base this opinion

on what I had personally seen and heard and I would stick to that opinion.

This same sort of talk, this super-superiorness stuff, is unquestionably handed out to the newspapermen. Now the newspaperman, as a general rule, cannot properly discount any statements handed to him. He isn't an engineer and he isn't properly informed on naval affairs. He is supposed to know everything and in fact he knows nothing well. To-day the newspapermen are getting to be parrots, or rather stenographers for the transmission of what somebody else says.

Only recently the new battleship *Maryland* went to sea for her builder's trials. Almost simultaneously, news statements from the various news services stated and proclaimed the advent of the world's most powerful warship. The British *Hood* was forgotten, or never heard of, the Japanese *Negato* and *Mutsu*, larger, faster, and firing a heavier broadside, were nothing alongside of the "most powerful ship in the world." They were not even considered, for if they had been the *Maryland* would not have been the "most powerful ship in the world." Yet all the people all over the country have been given the impression that we have the world's most powerful warship and that three ships just like her will be completed shortly. Now, in their opinion, why should we build more warships?

Another instance of just this is in the case of our battle cruisers, "the most powerful ships of their types in the world, when complete." Why is it that when these statements of recent date were given to the newspapermen that the Japanese *Akagi* class of four ships was not considered? Everyone in this country believes that we will have the most powerful battle cruiser squadron in the world when they are complete. Four of the tremendous *Akagis* and the four *Kongos* will make no difference, of course.

Another thing. Can any one explain to me why nearly every naval officer in talking for publication, considered all the ships of our 1916 program as complete after the lesson of the aftermath of the Civil War?

Because of this lesson I must refuse to consider any ship not 50 per cent complete as even "to be completed" during an indefinite period, unless I have positive knowledge of a Congressional appropriation which will actually complete them.

The newspaperman wants a big story. The bigger his stories, the more prestige he has in his office. Give him a finger and he'll usually take a whole hand. The naval officer he approaches for his story seems to think, judging from the printed stories, that it is unpatriotic not to make his subject the "greatest in the world." Personally, I have found this true. If I had swallowed some of the things told me about the navy, I would have most certainly printed some big stories, but after using a pinch of salt and a little just discrimination, I have used only what I believed to be right and fair.

A continuance of the use of superlatives on the part of those who give the interviews and talk to the people aboard ship or at a dinner, has but one result—that of an entirely inferior American Navy.





[COPYRIGHTED]

U. S. NAVAL INSTITUTE, ANNAPOLIS, MD.

---

## RIGID AIRSHIPS

By LIEUT. COMMANDER GARLAND FULTON (C. C.), U. S. Navy

---

EDITOR'S NOTE.—This article was submitted before the unfortunate *R-38* disaster. It contains, however, much information of current interest in regard to rigid airships.

The prospective acquirement of *ZR-2* (ex-British *R-38*) and the construction in this country of *ZR-1* mark the addition to the United States Navy of a new type of craft and make of current interest an outline of the characteristics of a modern rigid airship. A large amount of speculation has already been published as to the future possibilities of large airships both for commercial and military purposes. What, therefore, will probably be of most interest is a general description of rigid airships as they exist at their present stage of development, with an introduction consisting of a brief outline of some of the landmarks in their evolution up to the present.

A rigid airship is distinguished from other types by the rigid framework enclosing the lifting elements so that the gas pressure is not relied upon to retain the form of the ship, either entirely, as in the non-rigid type, or in part, as in the semi-rigid type.

### GERMAN DEVELOPMENT

Although construction of small airships of the non-rigid and semi-rigid types had been underway for a number of years in several countries, and a crude rigid type, which employed a petrol engine for the first time in an airship, was attempted by an Austrian named Schwartz in 1893-97, the first serious efforts to produce a rigid airship date from 1898 when Count Ferdinand Von Zeppelin, a cavalry general of Franco-Prussian War fame, and formerly Prussian Military Attaché in this country during the Civil War, employed two engineers, Kober and Kubler, to assist

him in the design, and formed a company for the building of this new type of airship he had long contemplated. He became so closely identified with rigid airship development that examples of the type became popularly, and later officially, known as "Zeppelins." His early work was contemporary with that of Santos-Dumont with small airships of non-rigid and semi-rigid types, who, while probably far from being the scientific student of airship construction that Zeppelin was, served to arouse popular enthusiasm by his dare-devil public performances in Paris and may be regarded as the inspiration of the increased activity in all airship work evident at this period.

Construction of the first rigid airship proved a formidable task, rivaling as the ship did in size and displacement a large ocean liner. This *Zeppelin I* while crude bore a close resemblance in principles of construction to those immediately succeeding her. The hull structure was an aluminum and wire framework built on the "keel girder system" followed in all the early Zeppelins up to *L-3 (LZ-24)* as distinguished from the "hull girder system" of modern ships. The backbone of the structure was a single longitudinal girder or keel of built-up section and strong enough to act as the main strength member, placed just below the hull proper. The sixteen transverse frames, each forming a 16-sided polygon, were erected vertically from equidistant points along the keel: apexes of these transverse frames were connected by longitudinal members running from end to end of the ship; a network of brace wires connected longitudinals and frames completing a light framework enclosing the gas bags and transmitting their "lift" to the keel girder. Two cars were provided, one forward, one aft. Also, four propellers driven by shafting from two engines placed inside the cars. The gas bags were made of cotton cloth proofed with a rubber solution and the outside cover was of linen stretched taut by the application of a shrinking solution comparable to our modern "cellulose acetate dope." The external appearance presented was that of a long pencil with rounded ends—a not very efficient aerodynamic shape. The ship was of 400,000 cu. ft. capacity; 416 ft. long; 38 ft. in diameter and weighed ten tons, including a useful load of about one ton. Two 16-horsepower Daimler benzine motors were used, and on her first trials held in the summer of 1900 a speed of 17 miles per hour was obtained. Stability and steerability were fairly satisfactory and the ship

became the prototype of all modern rigids. This ship was followed in 1905-08 by *Zeppelin II*, *III* and *IV* embodying progressive changes and improvements.

The interest of the whole German people in the large ships was at once very great and the first recognition of the military possibilities of the rigid airship appears to have been in 1908 when, after a demonstration flight of the modified *Zeppelin III*, witnessed by the Kaiser and on which the crown prince was carried as a passenger, Count Zeppelin was decorated as "the greatest German of the century." Soon afterwards this ship was taken over by the government and rechristened *Zeppelin I*—the first rigid airship to be taken into military service.

Four similar ships were soon ordered for the German Navy and this announcement at once prompted other inventors and designers to activity. Of these, Dr. Johann Schutte, of Danzig, a naval architect of considerable attainments stands out prominently. As will be seen he infused many principles of the ship-builder into airship construction to the lasting benefit of the latter. Aided by his financial backer, Lanz, the Luftfahrzeugbau Schutte-Lanz (Schutte-Lanz Co.) was established at Mannheim and became an active rival of the Luftschiffbau Zeppelin (Zeppelin Works) at Friedrichshafen. This rivalry between these, the only two rigid airship building plants in Germany, still continues although during the war the government apparently forced a pooling of design information, patent rights and ideas to their mutual advantage.

The Schutte-Lanz Company claims, and with considerable merit, they have contributed more than has the Zeppelin Works towards improvements in rigid airship design and that even their earliest ships included characteristics in advance of their time, as shown by their later adoption by all designers of rigid airships. The first *S-L* airship was designed in 1908-9 and completed in 1911. The ship displaced 724,000 cu. ft.; was 430 ft. long; 60.3 ft. in diameter; carried a useful load of 10,000 lbs., and made a speed of 42 miles per hour with two 250-horsepower Mercedes engines. The type was notable on account of its superior streamlined form compared with that of contemporary Zeppelins, in that the greatest diameter was placed in the first third of the length, giving the ship a fatter appearance. The slenderness ratio, or diameter-length ratio, was

1 to 7.1 as compared with 1 to 9 for existing Zeppelins. It is of interest to note that the slenderness ratio of subsequent German rigids has shown a gradually decreasing tendency until in their latest type to be flown it has reach 1 to 6.5. Other interesting features of the *SL-1* were its simple single control surfaces in contrast with the cumbersome box-type multiple control surfaces of the Zeppelins; elastic car suspension which is now almost universally adopted; propellers driven by simple spur gears; and the peculiar hull structure, a trellis framework composed of diagonal wood members running spirally around the ship from stem to stern with occasional transverse rings so that the external appearance of the hull before being covered was not unlike that of a battleship cage-mast turned to a horizontal position.

The second ship, *SL-2*, completed in early 1914 was larger than *SL-1*; 883,000 cu. ft. capacity; 473 ft. long; 59.7 diameter; useful load 17,600 lbs.; speed 55 miles with four 180 Maybach engines. She contained further features of improvement; an interior walkway for convenient communication and stowage of bulky materials, at the same time reducing the over-all height of the ship and improving its aerodynamic efficiency; also, the car arrangement was improved by placing a pair of wing cars farther away from the axis of the ship and closer to the hull, thus giving increased ground clearance and better propeller distribution. The automatic gas valves were placed in a low position with ventilation shafts leading up vertically from them. A similar system is used to-day. In preservation of the analogy to the sea-going ship, engine telegraphs and telephones were provided. Wood girders of triangular cross section were used, but the diagonal system of framework was abandoned as too complicated in favor of longitudinal members with main and intermediate transverse rings. The Schutte-Lanz Company continued to use wood for structural members almost to the end of the war when they were about to construct a ship of duralumin tubing. The glue in early ships appears to have been poor, and when Schutte-Lanz ships were used by the Navy joints opened up and caused trouble until a new method of fabrication was found which overcame the difficulty.

In 1909-10 the Deutsche Luftfahrt Actien Gesellschaft (German Air Travel Company) was formed, with the Zeppelin Works



FIG. 1.—Skeleton of *SL-1*. Gasbags Partially Inflated. Note Spiral Framework.

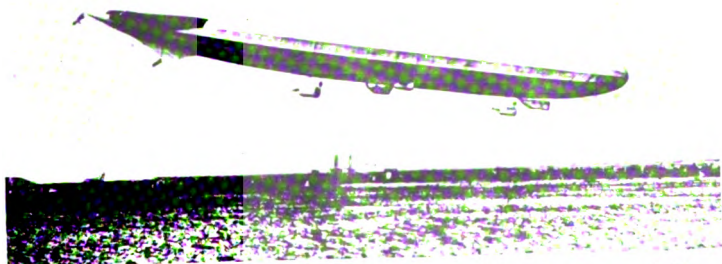

FIG. 2.—*SL-2*. Early Type of Schutte-Lanz Ship—Streamlined Shape and Monoplane Control Surfaces.

retaining an interest, to operate among a group of German cities, employing some older Zeppelins and the *Zeppelin V* which was to be constructed of a remarkably light but stiff alloy "electrometal" (probably duralumin). This company, in spite of discouraging damage to one or two ships in early operations was able to operate at a profit in addition to a subsidy from the government for the use of the ships in training army and navy airship crews. During the period of 1910-1914, over 37,000 passengers were carried in comfort and luxury on 1600 trips, a total distance of 325,000 miles without any fatal accident to passengers or crews. One ship, the *Victoria Luise*, is known to have made 200 trips in 250 consecutive days—a noteworthy record.

In spite of some disasters and financial difficulties, the Zeppelin Works continued to build ship after ship. By 1914 a total of 27 rigids had been completed in Germany of which 14 had been lost by various mishaps or dismantled as obsolete, leaving 13 in existence at the outbreak of the war—12 Zeppelins and one Schutte-Lanz ship. Besides remarkable improvements in general and detailed construction, the capacity of rigids had grown steadily from 400,000 to about 900,000 cu. ft.; their power from 32 to 840 horsepower; their speed from 17 to 55 miles per hour; their percentage of useful to gross lift from 20 to nearly 40.

German progress in rigid airships during the war is mainly a story of ever-increasing efficiency gained through constructional improvements to reduce weight as regards both hull and machinery. All that could humanly be expected was accomplished. Under the impetus of military necessity more technical improvements were effected during the four years of war than would otherwise have been accomplished in a decade. Even under stress of war conditions time was found to make systematic changes in a group of similar ships changing one variable only at a time. The results must have been very instructive.

At the outbreak of war only one ship, the *L-3 (LZ-24)*, was controlled by the navy as against 12 by the army, a fact that appears strange on first thought, but was probably because existing ships were not competent to carry out the exacting long patrols demanded by the navy. However, their usefulness to the navy had been realized and negotiations were already underway

with the Zeppelin Works and Schutte-Lanz Company for the construction of a number of superior ships. One-half of the next 64 ships built went to the army and the other half to the navy. Of the succeeding 43, 35 went to the navy, thus showing the trend of opinion as to their naval usefulness. Naval officers were found to be the most successful pilots as they brought with them, owing to their experience at sea, a quantity of knowledge useful in the navigation and handling of large airships. When they could be spared, officers with submarine experience were the most promising material.

Naturally the first war-period ships were built to existing designs, but improved designs were shortly forthcoming and soon it was the Admiralty that was most actively engaged on rigid airship construction. Along with the development of the airships themselves appeared a host of other problems that had to be solved. It was realized very early that the airship, being essentially a long-distance scout, would be useless on active duty without a reliable means of communication. A suitable radio was, therefore, installed and elaborate precautions taken to insure its continuous functioning.

Service opinion as to desirable performance characteristics obeyed its infallible rule and changed rapidly with the changing phases of the war. At one time stress was laid on endurance; at another great lifting capacity; at another high speed; at another high ceiling; but always reliability. It is interesting to note that all the German airships used Maybach engines built under control of the Zeppelin works. This was as much a matter of expediency as a tribute to the engines, although they are perhaps the best types of airship engines existing to-day. The size of the ships very soon increased to about 1,250,000 cu. ft. in the *LZ-40 (L-10)* and *SL-6* classes. It is around this capacity, which implies a useful load of 15 tons that the military value of the type begins to be approached, but does not become fully realized until capacities of nearly 2,000,000 cu. ft. are reached.

The first ships representing the combined thought of the Zeppelin Works, the Schutte-Lanz Company and the German Admiralty were those of the *L-30* class, the first of which was completed in 1916. On account of their large increase in volume to 1,940,000 cu. ft. they are sometimes referred to as "super-Zeppelins." In these ships the hull was of much improved streamlined form; single



control surfaces and balanced rudders were provided; and the gangway was placed inside the hull; all of these features being existing Schutte-Lanz practice. The five-car and six-engine six-propeller arrangement first used was a combination of Schutte and Zeppelin practice, but this was shortly abandoned and all propellers carried directly on the cars as in Schutte ships. A new type of structural arrangement was introduced in that the girders forming the sides of the main polygonal transverse frames were stiffened by the provision of a king post extending inwards. Intermediate longitudinals, lighter than the main longitudinals, were supported at main transverses on short posts projecting outwards in line of the extended axis of the king posts. *L-33 (LZ-76)*, the third of this class, and embodying minor improvements, was completed in

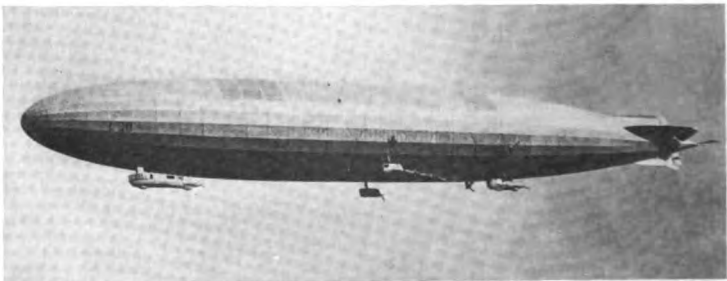

FIG 3.—*L-30 (LZ-62)*. First of the So-Called "Super-Zeppelins" Representing the Combined Ideas of the Zeppelin Works, the Schutte-Lanz Company and the German Admiralty.

September, 1916. Almost immediately she took part in a raid on London, was damaged by gun fire and forced to land almost intact in Essex. The British authorities were able to make a thorough scrutiny of the wreck and the results of this and other studies of Zeppelins are plainly evident in the designs then under preparation for the British *R-33* class.

As is natural to expect, losses were many during this period of intensive accumulation of knowledge of this new service. It is interesting to note in this connection that no German airship was lost during the war through structural failure and this fact is the more remarkable on account of the indeterminate nature of the structure and inexact state of the theory and method of calculations. The average pre-war life of a German rigid seems to have been about 16 months; the average life in war service about 14 months.

In considering these figures due weight must be given to the rapid evolution process underway and to the number of purely military casualties. A number of ships were disposed of as "obsolete" before they would otherwise have been deleted. The figures are not good evidence as to the probable life of a modern rigid airship. What this is, remains to be determined.

A great handicap in the use of rigids was lack of sheds and although construction of a limited number was started after some delay caused by doubt in the German mind as to how long the war would last, the shortage always existed and considerably throttled



FIG. 4.—1916 Type Zeppelin (*L-48*). One of this Class was Forced to Land in France and Became the Source of much Valuable Information for the Allies. Lower Half of Ship is Dark Colored for Night Operations.

the possible building and use of rigids. Before the war the navy had built one revolving shed housing two ships at Nordholtz, and German authorities still adhere to the revolving type of shed as the only solution to the perplexing problems of housing and handling rigid airships. It frequently happened with fixed sheds, in spite of docking rails, and other assisting mechanical devices, that cross winds prevented ships from leaving their sheds on the very occasions they were most needed. Perhaps 20 large sheds were constructed at various points, but the work of the more modern rigids was principally concentrated at Witmundshaven,

Alhorn and Nordholtz; also at Tondern until the sheds there, as well as several rigids, were destroyed by an airplane bombing raid.

In spite of shed limitations improvements in types and increases in size to secure higher speed and increased lift continued steadily. Sometimes a ship would be enlarged by the insertion of a section of parallel middle body and if the resulting ship was too large for her shed a bay window-like extension was provided to accommodate her. A very high degree of efficiency in the construction of rigid airships was attained. It is reliably reported that in 1918 the Zeppelin Works was able to turn out completed ships at the rate of one every six weeks. The reason for the much smaller number of Schutte-Lanz ships is easily found in this company's small plant and, until near the close of the war, its modest sized shed.

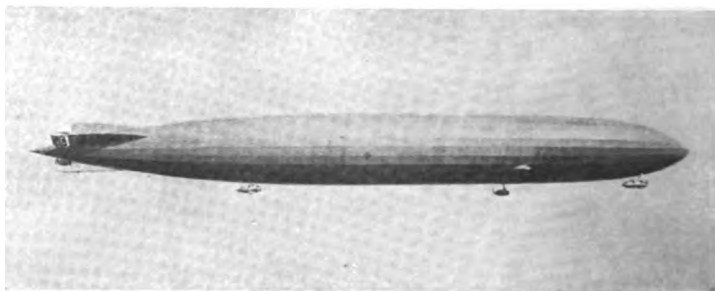

FIG. 5.—*L-57 (LZ-102)*. Large Zeppelin of Long Radius Type That Made Voyage to East Africa. 2,400,000 Cubic Feet; Speed 63 Miles Per Hour; 51 Useful Tons.

Then, too, the company was somewhat embarrassed by the difficulties connected with the transition from wood to duralumin as the chief building material.

The details of the German step-by-step war development can best be got by a glance at the chart referred to later. It will be sufficient to mention here that from 1916 changes in design were in detail only and not fundamental. The size of the ships increased to a maximum of about 2,400,000 cu. ft. in *L-71 (LZ-113)* which was singled out from the other two ships of her class to be lengthened and, hence, enlarged.

Conditions imposed by the Armistice caused an abrupt cessation of airship activity. Several airships were broken up before the Allies had an opportunity to intervene to save them, while building was immediately discontinued on seven more. The Armistice

Commission, which visited Germany in December, 1918, found a few rigids intact in their sheds, and others partially completed—notably *L-72 (LZ-114)*, one of the largest German rigids built, which has subsequently been completed and included in a group of seven distributed among the Allies—two to England; two to France; two to Italy; and one to Japan. The United States did not share in this distribution.

In spite of the unsettled state of internal affairs after 1918, the Germans, remembering their successful antebellum experience,

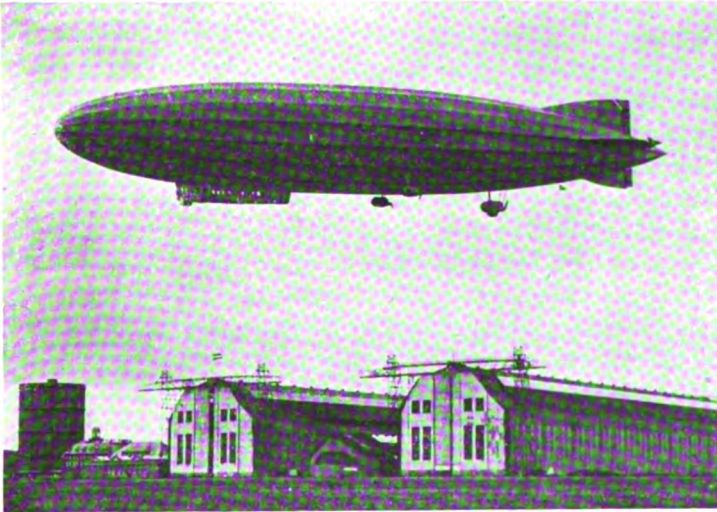

FIG. 6.—Passenger Airship *Bodensee* in Flight, 1919.

organized a regular passenger service between Berlin and Friedrichshafen employing two small, high-powered, fast ships—*Bodensee* and *Nordstern*—of 732,000 cu. ft. capacity. These ships were thrown together in about five months, a remarkably short time for a new design, and it is suspected that parts already fabricated for late-type Zeppelins were used in their construction. At any rate they incorporate some of the technical progress of the war, and are advanced samples of the art, except as to size. They are not, however, revolutionary as has been sometimes reported. This passenger service continued successfully throughout the summer of 1919 charging a fee of 400 marks for a 375-mile journey, including free luggage up to 30 lbs. It was finally stopped

by the Inter-Allied Control Commission and the ships recently turned over to France and Italy. This commission is still discussing the matter of replacement with Nordstern type ships the airship tonnage which should have been turned over to the Allies, but was destroyed after the fashion of Scapa Flow; also, the question of what disposition shall be made of the large rigid sheds in Germany.

It seems clear that the Armistice interrupted German plans to build much larger ships. The Schutte-Lanz Company was already building the largest their building sheds could accommodate, but larger sheds were underway and designs of correspondingly larger ships in preparation. The Zeppelin Works evolved about that time the design of the *LZ-125* class to be of about 3,500,000 cu. ft. capacity and nearly 800 feet long. This is the maximum size that could be built in the Friedrichshafen sheds. Except for size the design was similar to earlier ships. In spite of assertions to the contrary, work was never started on one of these large ships and the design appears to have been altered so as to be classed as a commercial ship and, as such, has been rather extensively advertised.

As illustrating the possibilities of large airships there may be pointed out a few of their accomplishments during the war. Many different kinds of reconnaissance and offensive expeditions fell to their lot varying with the progress of the war and taking them over the whole face of Europe—Russia, Asia Minor, the Black Sea, Galicia, Africa, France, Great Britain and Scandanavia. In the first years of the war a group of airships simultaneously patrolling the entrance of The Bight was sufficient to insure ample warning of enemy raids and to cause great annoyance to British submarines operating in the vicinity. The figure indicates the path some of the patrols took. A by-product of this work was the location and buoying of mine fields for the information of German mine sweepers and submarines. Airships were of outstanding importance to the operations of the High Seas Fleet and were able to keep it fully informed, a service which Admiral Scheer mentions with gratitude. In spite of unfavorable weather conditions in the North Sea area the co-operation and reconnaissance of airships were of vital importance to the German fleet. At Jutland ten (10) rigids were out, but were handicapped by the low visibility conditions which prevailed. They were able, however, to furnish some valuable information in the last phases of the battle. The

sortie of the German fleet in August, 1916, was accompanied by eight Zeppelins which, proceeding in advance, were able to guide the squadron and develop its attack.

It is reported\* that *L-40 (LZ-88)* came to a landing on the water and held up a steamer to examine its papers. Also that in 1917 near Horns Reef Lightship, *L-23 (LZ-66)* overhauled a Norwe-

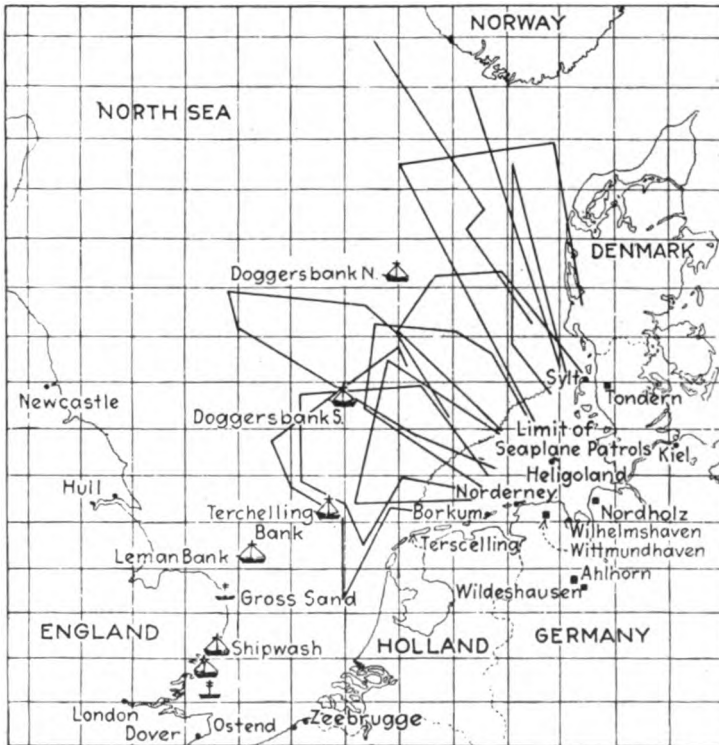

FIG. 7.—Routine Airship (and Seaplane) Patrols Maintained by Germany in the War.

gian bark, landed on the water close by, and put a prize officer on board who brought the bark safely to a German port. The risk to material involved in such exploits makes them hardly believable. *L-16 (LZ-50)* carried supplies to outlying German island provinces in the far North Sea which were in danger of famine. A rigid airship transported munition-making machinery from Aus-

\* Neuman, *The German Air Force in the Great War*.

tria over Bulgaria (while still neutral) to Constantinople. But the most remarkable voyage of any airship during the war was that of the enlarged *L-59* (*LZ-104*) on the initiative of the navy in the autumn of 1917 to carry 20 tons of medical supplies and munitions to troops in German East Africa and to bring back General Von Lettow. Starting from Jamboli, Bulgaria, the ship crossed the Mediterranean, flew diagonally across Egypt to Lake Victoria Nyanza where having accomplished more than half the journey she was recalled by radio from Nauen sent in the erroneous belief that the East African force had been captured. The ship returned safely to Jamboli after requiring 96 hours for the non-stop journey



FIG. 8.—Late (1917) Type Schutte-Lanz Ship. 1,978,000 cubic feet Capacity.

of about 4500 miles without benefit of meteorological service, and over an unexplored region. Captain Buckholt reported that he could have remained in the air comfortably for another 48 hours.

The airship raids on England and France are familiar to all. At first these attacks were delivered from 3000 ft., later increased to 15,000 to 18,000 ft. as the British system of defense was developed through anti-aircraft guns, powerful searchlights and airplanes. At these high altitudes unfavorable meteorological conditions appear to have caused more discomfort than did airplane or barrage attack. However, the Germans themselves realized that such raids, while having some moral effect, were not a proper function for large airships and this may account for their decreasing frequency during the later stages of the war.

TABLE I\*

## SUMMARY OF THE ULTIMATE DISPOSAL OF RIGID AIRSHIPS BUILT BY GERMANY

Disposition	Zeppelin	Schütte-Lanz	Totals
1. Dismantled—Obsolete .....	11	5	16
2. Dismantled—Army Airship Operations			
Abandoned .....	11	2	13
3. Shot Down in War .....	15 <sup>1</sup>	1	16
4. Hit by Gun Fire and Wrecked .....	17 <sup>2</sup>	0	17
5. Wrecked, Storm, Forced Landing, etc. . .	12	3	15
6. Wrecked, Bad Landings, etc. ....	11	5	16
7. Destroyed in Shed by Fire. ....	14 <sup>3</sup>	3	17
8. Destroyed While Handling on Ground. . .	4	0	4
9. Destroyed by Fire in Flight. ....	4 <sup>4</sup>	2	6
10. Turned Over to Allies .....	7 <sup>5</sup>	0	7
11. Wrecked Deliberately Since Armistice. .	7 <sup>6</sup>	0	7
12. Building Discontinued .....	6	1	7
13. Now in Commission .....	2 <sup>7</sup>	0	2
Totals .....	121	22	143

<sup>1</sup> One shot down by aviators.

<sup>2</sup> Two burned after wreck.

<sup>3</sup> Seven destroyed due to aviator's bombs.

<sup>4</sup> Two fell burning, cause unknown.

<sup>5</sup> Two each for England, France, Italy; one for Japan.

<sup>6</sup> All wrecked in sheds deliberately to evade Armistice conditions.

<sup>7</sup> *Bodensee* and *Nordstern*, LZ-No. 120, 121. Allied commission claims these as replacement for (6). Recently turned over to France and Italy.

## SUMMARY DIVIDING GERMAN RIGID AIRSHIPS INTO GROUPS ACCORDING TO OWNERS

	Zeppelin	Schütte-Lanz	Totals
Civilian .....	12	1	13
Army .....	40	12	52
Navy .....	63	8	71
Building Discontinued .....	6 <sup>1</sup>	1 <sup>2</sup>	7
Totals .....	121	22	143

<sup>1</sup> Naval airships.

<sup>2</sup> Army airships.

No fair appraisal of their worth can be made unless illustrations of airships' weaknesses are given. An inspection of Table I showing ultimate disposition of German rigid airships is illuminating in this connection. Sixteen were shot down in war, one by an aviator; gunfire was a contributory cause to seventeen more losses; fires, six of which occurred in flight, account for 23 more; while bad handling and landings, or forced landings, are responsible for 31 wrecks.

\* From compilation of data from German sources published in *Automotive Industries*, May, 1921.



The greatest drawback to the military use of airships is their vulnerability, but of those destroyed or damaged by gunfire the majority of the losses were on bombing raids prior to 1918, and in practically all cases the damage was done while flying at low altitudes—9000 feet and under. The Germans apparently realized the risk these raids entailed and, at first, accepted it. The later types with ceilings of 15,000 feet and more gave a better account of themselves. Only three cases can be found of fatal enemy damage to a rigid while operating with the fleet. By 1918 the British had developed a counter measure to Zeppelins in the form of fighting airplanes flown from turrets of battleships and, while this no doubt served to keep the Zeppelins at a more respectful distance, the loss chargeable to an aviator was accomplished by an airplane flown from a shore base.

The losses from fires in the air are few whereas, eliminating seven destroyed by bombs during air raids on Tondern and other bases, 10 were destroyed by shed fires. This number seems inexcusably high, but may have been partly due to hastily recruited and inexperienced crews. The same reason no doubt contributed to some of the losses through handling on the ground, although weather conditions would likely be the larger factor.

It may be concluded that forced landings are serious affairs and generally result in wrecks. The antidote is obviously to secure greater reliability and so reduce the chances of a forced landing. A notable example of a forced landing is that of *L-49* (*LZ-96*) in October, 1917, at Bourbonne Les Bains, France, after having been harassed by airplane gunfire in an attack on England. The immediate causes of the landing were exhaustion of personnel from operating at extreme altitudes and engine failure due to freezing. Efforts of the crew to fire the ship on landing were frustrated and the recovery of the ship's structure almost intact provided the source of much valuable design information for the Allies, and ourselves, for French engineers, with great thoroughness, carefully measured and recorded dimensions of each part, no matter how small. *L-49* was of the same form and dimensions as *L-33* previously shot down in England, but detailed refinements resulting in a considerably lighter weight, and a correspondingly greater useful load, had been made.

## BRITISH DEVELOPMENT

The average German will insist that all British rigid airships are belated copies of German types and may go even farther to say that the transatlantic voyage of *R-34* is, therefore, in reality a triumph of German skill and ingenuity. But this is not quite the case, for while several laps behind Germany until 1918, British talent has contributed a number of advancements to the art.

The first rigid to be built by Great Britain was the *Mayfly*, constructed by Vickers for the Admiralty and completed in 1911 but never delivered. The design represented the combined ideas of naval constructors and Vickers' engineers. In some respects the ship was ahead of her time. She was of fairly good form and had a better arrangement of machinery and propellers than did contemporary German ships. The "keel girder system" was used with duralumin for structural members. The ship was of 700,000 cu. ft. capacity and was powered by two 200-horsepower Wolsey engines. On her first trials she was moored by the nose to a floating mooring mast near a dock for three days and successfully weathered a small gale during that time. This is the first instance on record of the use of a mooring mast for large airships. After subsequent trials, due to a misunderstanding of orders, she was almost totally wrecked by being carried against the shed door while being housed. It is unfortunate the promising start made with this airship was not followed up vigorously so that good rigid airships would have been available at the outbreak of war, but instead interest and progress lagged.

At the end of 1913 all airships then in possession of the army were transferred to the navy, and from then until 1918, the responsibility for the development of airships, including rigids, rested with the Admiralty wherein an Airship Section was at once organized. Coincident with this revival of interest in airships, a contract was placed with Vickers for the *R-9*, of the same general design and size as existing German rigids. She was of 889,000 cu. ft. capacity; 526 ft. long; speed 45 miles per hour. Construction was started promptly, but proceeded slowly. In March, 1915, the Admiralty directed that work be suspended as it was then considered the war would end in a few months. However, the effective work of German rigids and the continuance of the war caused this decision to be reversed. After numerous design changes and

delays, *R-9* carried out successful flights in the spring of 1917, and subsequently gave very satisfactory service on patrol and as a training ship. During her life of two years and three months, she flew a total of over 2500 hours.

From 1915 rigid development was pushed with energy until after the Armistice. Besides Vickers, orders were placed with Armstrong-Whitworth, Beardmore and subsequently, with Short Bros., at Bedford. In some cases, sheds and building plants were up for these concerns practically at Admiralty expense.

The next class of rigids was the *R-23* class, four ships, constructed largely to Vickers designs and embodying a number of

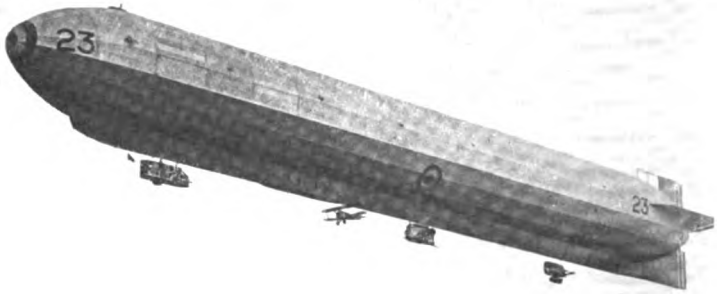

FIG. 9.—British *R-23* Carrying Fighting Airplane Which Was Released and Made a Successful Flight.

improvements, although still closely resembling their German antecedents. They had single rudders and in common with most British rigids were very staunchly built and heavy which involved a reduced useful load. They were 997,000 cu. ft. capacity; 535 ft. long; carried a useful load of 6 tons; and made a speed of 55 miles per hour with 1000 horsepower. All were not completed until 1918, something over three years behind equivalent German ships. However, they proved to be useful ships. *R-24* was subsequently used for mooring experiments and successfully remained moored out for 42 days in all sorts of weather. The *R-23X* class comprises *R-27* and *R-29*, ships slightly smaller but very similar to *R-23*, and notable for the omission entirely of a keel as such, thus becoming a pure hull girder type. *R-31* and *R-32* were wooden ships after Schutte-Lanz ideas. Casein glue was

used, but difficulties were encountered due to seams opening from dampness just as Schutte had found. *R-31* was shortly condemned and *R-32*, while enjoying a longer life, has recently met a similar fate. These ships were of 1,550,000 cu. ft. capacity, and were very fast, making 65 miles with five 250-horsepower Rolls-Royce engines.

On inspecting *L-33* in late 1916, it was realized that all the earlier British ships were useless except for training and the Admiralty promptly ordered several modern ones of the *R-33* class, based on the German *L-33*, but revised during construction, principally as to car and propeller arrangement, on later information got from an inspection of *L-49*. This class compares closely with *L-49*, but includes a number of minor improvements based on British experience. Their somewhat more rugged construction permitted only 45 per cent useful load as against 50 per cent for *L-49*. Two ships, *R-36* and *R-37* were to be similar to the *R-33* class, but larger by a ten meter section amidships.

Just after the Armistice, and during the construction of the *R-33* class, most of the Admiralty personnel engaged on rigid airship work were loaned and transferred to the Air Ministry. When the Air Ministry was first established rigid airship work remained under the Admiralty and the desirability of the change has not been proved by subsequent developments. There are many who hold to the idea that large airships are essentially naval and, therefore, should be designed and maintained as part of the fleet.

Armistice Day found Great Britain with six active rigids and four more under construction. Operating berths were available for 14 ships. With the reduction of military services to a peace basis, there came a general aircraft depression, particularly deep in regard to rigid airships; the number of ships in commission was reduced and the activities of those remaining were much curtailed. Completion of *R-33* and *R-34* was permitted and although too late for war service, these ships have given a good account of themselves. *R-33* has made several notable demonstration flights over eastern Europe and the Baltic and the transatlantic flight of *R-34*, 3600 miles in 108 hours, is still fresh in the minds of every one. This latter is the outstanding post-war achievement by any airship.

After *R-33* and *R-34*, British designers began to consider the production of ships of larger volume. They now had at their disposal considerable first-hand experience besides a mass of

data from inspection of German rigids and through intelligence sources. This is summed up in the *R-38* class, comprising three ships, two of which were canceled. She is not a copy of, but is related to the last German rigid to be completed (*L-72*). One distinct improvement is the replacement of the German type king-posted girders of main transverses by a full-trussed frame consisting of four girders forming an elongated diamond with a brace across the short diagonal. Although of increased volume, a larger diameter permits a more economical structure while giving a good streamlined form, which it is expected can be driven at a speed of nearly 70 miles per hour. Arrangements were made by the Air Ministry to take over the works of Short Bros. at Cardington (Bedford) as an experimental building establishment and to continue there under direction of Air Ministry officials experimental construction of this new design which was worked out in late 1918. On account of their small shed, Vickers could not build the later and larger type ships, so to avoid complications they were allowed to build a small ship, *R-80*, to their own designs. The ship is complete, but seems to fill no military purpose and is being used as a training ship.

Table II gives a summary of the disposition of British rigids as nearly as can be ascertained. Except for number one, called the *Mayfly*, the letter "R," evidently for "rigid," followed by a numeral has been used as a designating symbol. The apparent gaps in the series are filled by airships not of rigid type or by rigids that were assigned numbers but never completed. Why "*R-80*" was selected is not clear.

Ever since the Air Ministry took over the control of rigid airships there has been great discussion as to what policy should be followed. The net result is there appears to be no policy. Undoubtedly with a lean treasury, rigid airships are a big problem, but so long as they continue to serve as a hone of contention between Air Ministry and Admiralty little advance in the art may be expected. Attempt has been made to turn over to commercial concerns for operation some of the idle ships, particularly *R-36*, whose car arrangement was specially changed to suit commercial work. So far no concern has been found that will agree to the stipulated terms and the matter remains in the discussion stage. Meanwhile, *R-36* does such errands as regulating traffic to the Ascot Races and does it very efficiently.

In early 1921 *R-34* met with an unfortunate accident while on practice flight and was later broken up by a storm while attempting to place her in her shed at Howden. This was the last psychological straw to the already depressed British mind, and for a time it looked as though large airships would be abandoned entirely. However, the recently completed and very successful trials, with an improved type of mooring mast, have opened up new possibilities

TABLE II  
SUMMARY OF ULTIMATE DISPOSAL OF RIGID AIRSHIPS BUILT BY  
GREAT BRITAIN

Type	Remarks
( <i>R-1?</i> ) <i>Mayfly</i> .....	Wrecked, 1911.
<i>R-9</i> .....	Deleted, 1918.
<i>R-23</i> .....	Placed out of service.
<i>R-24</i> .....	Used for mooring experiments. Out of service.
<i>R-25</i> .....	Used for static tests. Out of service.
<i>R-26</i> .....	Placed out of service.
<i>R-27</i> .....	Burned in hangar.
<i>R-29</i> .....	Broken up in static tests.
<i>R-31</i> .....	Wood ship. Unsatisfactory. Placed out of service.
<i>R-32</i> .....	Wood ship. Broken up, 1920.
<i>R-33</i> .....	In service.
<i>R-34</i> .....	Wrecked in handling, 1921.
<i>R-36</i> .....	Adapted for commercial purposes. In service.
<i>R-37</i> .....	Under construction.
<i>R-38</i> .....	Under construction. Sold to U. S. A.
<i>R-80</i> .....	In service. (Training ship.)

SUMMARY.—14 completed. Three in service; two under construction; total 16.

NOTE.—*L-64* and *L-71* (German ships), turned over to Great Britain under terms of the Peace Treaty, are not in service.

and served to materially change this opinion. Signs of increasing optimism and activity are becoming apparent. If a satisfactory method of mooring out large airships can be found a long step forward will have been made and, apparently, this has been done.

As to their use during the war, 1914 found Great Britain with no rigid airships of any military value and in fact it was only after the good work of the German Zeppelins became increasingly evident that she was aroused from her lethargy and made frantic efforts towards a construction program. This lack of foresight has been

severely criticized although it can hardly be called lack of foresight, since Admiral Jellicoe and others appear to have realized the value of rigid airships to a fleet, but were unable to overcome the inertia of some of the councils in which they sat. One argument against building any was that to rival Germany would require too many ships. Another argument was their vulnerability as evidenced by the rather heavy losses of the Germans in raiding northern towns, forgetting that such bombing raids were not a legitimate function for fleet operating airships. When the country realized the extent of German developments the Admiralty had to bear the brunt of much criticism for their reactionary policy.

The slow development of the building program, if program it may be called, prohibited anything like large scale operations. This is particularly to be regretted as one can conceive with Britain's undisputed control of the North Sea, and thus able to protect her aerial scouts, rigid airships could have been of inestimable service to the Grand Fleet. As it was there is not much to be said of the accomplishments of British rigids during the war. Their work chiefly comprised (1) operations with the fleet or detached units; (2) anti-submarine patrol and searching for mines; (3) escort of shipping, though this was mostly done by small non-rigids. Rigids, if available, would have been used for long-distance convoys.

#### FRANCE AND ITALY

The history of rigid airship development in France and Italy is almost negligible. Most excellent work was done in France on small and medium-sized non-rigids and semi-rigids by Lebaudy, The Astra Co., Clement Bayard and the Zodiac Company. However, nothing in the way of rigids was attempted until the Zodiac Company, in 1913, completed the *Spiess*, a rather crude 575,000 cu. ft. rigid which was similar to the Zeppelin type, but was not a success. Further activity did not appear until the value of the Zeppelins to the Germans became apparent and their characteristics driven home by an inspection of *L-49*. It has already been related how this carcass was minutely inspected and recorded. The results formed the basis for a French design of rigid and at least one was about to be ordered from Schneider when the Armistice caused the scheme to be abandoned. Since the Armistice France has shown great nervousness as to the ultimate disposition of large German

rigids, their sheds, and building plants, and seems to prefer that future building be confined to the smaller sizes. Two late German rigids were turned over to France under Armistice terms and apparently these are being retained and scrutinized as samples, possibly with a view to their duplication. Quite recently the small *Nordstern*, a passenger ship, has also been confiscated and delivered to France. It is reported that it will be used for passenger service to Morocco.

Italy has built no rigids, but semi-rigids have been developed extensively. Semi-rigids have been built up to 1,200,000 cu. ft. capacity and the *Roma* of this type was recently purchased by our War Department. Two late German rigids, and at least one large shed, have been delivered under the terms of the Peace Treaty. Their disposition is uncertain, but it is rumored that at least one ship has been deleted through handling. A rigid design has been prepared and construction is being considered, but there are no funds.

---

There is included a chart (Chart I) illustrating some of the principal steps in the development of German and British rigids. The classification is more or less arbitrary and omits minor changes in types. It would be too cumbersome to illustrate all of the variations that are of interest. There is also included Chart II listing the general characteristics of German, British, and United States rigids subsequent to 1913—that is the war and post-war types. Again the classification is arbitrary and omits many variations. It may be considered as an elaboration of the latter part of Chart I. While these charts are believed to be fairly accurate the data from which they have been prepared emphasize the wide discrepancies likely to be met in comparing data on the same airship from several sources. There should be, but there is not, a recognized standard set of conditions to enable accurate comparisons to be made. For example, the endurance of an airship may vary one hundred per cent depending upon whether the bomb load, or cargo, is omitted and an equivalent weight of fuel carried (extra fuel tanks being generally installed for this purpose). Similarly, the cruising radius of an airship, like that of a surface ship, varies much with the speed and broadly speaking increases rapidly as the speed is decreased. With airships the full value of favoring and



BRITISH



R-1 1911  
 1 SHIP BUILT 3.2 USEFUL TONS = 17.0 %  
 700,000 CU.FT 19.2 GROSS TONS



R-9 1916-17  
 1 SHIP BUILT 3.2 USEFUL TONS = 12.5 %  
 683,000 CU.FT 25.6 GROSS TONS



R-23 CLASS - 1917-18  
 4 SHIPS BUILT 3.7 USEFUL TONS = 18.9 %  
 997,000 CU.FT 28.7 GROSS TONS



R-27 OR "R-23X" CLASS - 1918  
 2 SHIPS BUILT 8.4 USEFUL TONS = 29.4 %  
 990,000 CU.FT 28.6 GROSS TONS



R-31 CLASS - 1918  
 2 SHIPS BUILT 14.3 USEFUL TONS = 32.3 %  
 1,550,000 CU.FT 44.3 GROSS TONS



R-33 AND 36 CLASSES - 1919-21  
 4 SHIPS BUILT 27.5 USEFUL TONS = 48.49 %  
 2,000,000 TO 2,150,000 CU.FT 56.0 GROSS TONS



R-80 CLASS - 1921  
 1 SHIP BUILT 15.3 USEFUL TONS = 42.4 %  
 1,250,000 CU.FT 36.1 GROSS TONS



R-38 - 1921  
 1 SHIP BUILT 46.0 USEFUL TONS = 58.5 %  
 2,724,000 CU.FT 78.6 GROSS TONS

1 SHIP BUILT  
725,000 CU.FT

1 SHIP BUILT  
883,000 CU.FT  
TO 560,000

3 SHIPS BUILT  
1,144,000 CU.FT

4 SHIPS BUILT  
1,240,000 CU.FT

10 SHIPS BUILT  
1,370,000 CU.FT

3 SHIPS BUILT  
1,978,000 CU.FT

## LANZ



55 1311  
 $\frac{\text{USEFUL TONS}}{\text{GROSS TONS}} = 20.1\%$



3 1314  
 $\frac{7.8-10.2 \text{ USEFUL TONS}}{26.8-28.5 \text{ GROSS TONS}} =$   
 29.1-34.6%



5 1315  
 $\frac{\text{USEFUL TONS}}{\text{GROSS TONS}} = 39.8\%$



1915-16  
 $\frac{\text{USEFUL TONS}}{\text{GROSS TONS}} = 48.4\%$



1316-17  
 $\frac{\text{USEFUL TONS}}{\text{GROSS TONS}} = 48.5\%$



317-18  
 $\frac{\text{USEFUL TONS}}{\text{GROSS TONS}} = 50.0\%$

## ZEPPELINS



LZ-1 (EARLY TYPE)-1900  
 REPRESENTS 6 SHIPS  $\frac{1 \text{ USEFUL TON}}{10 \text{ GROSS TONS}} = 10\%$   
 400,000 CU.FT

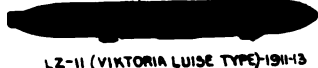

LZ-11 (VICTORIA LUISE TYPE)-1911-13  
 REPRESENTS 7 SHIPS  $\frac{6.1 \text{ USEFUL TONS}}{19.9 \text{ GROSS TONS}} = 30.6\%$   
 650,000 CU.FT



LZ-18 CLASS (LZ)-1913  
 REPRESENTS 4 SHIPS  $\frac{10.8 \text{ USEFUL TONS}}{28.8 \text{ GROSS TONS}} = 37.5\%$   
 950,000 CU.FT



LZ-25 CLASS (PRE WAR & EARLY WAR CLASS)-1913-14  
 22 SHIPS BUILT  $\frac{8.5 \text{ USEFUL TONS}}{24.0 \text{ GROSS TONS}} = 35.4\%$   
 792,000 CU.FT



LZ-40 CLASS-1913-16  
 35 SHIPS BUILT  $\frac{16.9 \text{ USEFUL TONS}}{38.3 \text{ GROSS TONS}} = 44.0\%$   
 1,250,000 CU.FT. (ABOUT)



LZ-62 CLASS-1916-17  
 17 SHIPS BUILT  $\frac{31.9 \text{ USEFUL TONS}}{58.9 \text{ GROSS TONS}} = 54.2\%$   
 1,940,000 CU.FT



LZ-95 CLASS (HIGH CLIMBING CLASS-21,000 CEILING)-1917-18  
 19 SHIPS BUILT  $\frac{39.7 \text{ USEFUL TONS}}{59.9 \text{ GROSS TONS}} = 66.2\%$   
 1,970,000 CU.FT.



LZ-104 CLASS (LONG RANGE CLASS-177 HRS, 1918)  
 5 SHIPS BUILT  $\frac{50.9 \text{ USEFUL TONS}}{73.4 \text{ GROSS TONS}} = 69.4\%$   
 2,420,000 CU.FT



LZ-120 CLASS-1919-20  
 2 SHIPS (RODENSEE & WARDENBERG)  
 PASSENGER SHIPS  $\frac{11.3 \text{ USEFUL TONS}}{24.1 \text{ GROSS TONS}} = 47.0\%$   
 796,000 CU.FT

CHART II—CHARACTERISTICS OF RECENT RIGID AIRSHIPS

Designating number or class	Number built	Naval ships included	Date delivered	Volume in cubic feet	Length in feet	Diameter in feet	Lift		Ceiling (estimated) feet	B. H. P. Total	Speed		Approximate endurance		Remarks
							Gross tons	Useful Gross percent			Full power (miles per hour)	Half power (miles per hour)	Full power (Miles)	Half power (Hours)	
GERMAN															
Zeppelin Works															
LZ-15	5	.....	Early 1913	686,000	466.48	7.20	6.9	33.0	5,000	495	45	36	avail. able.		Internal keel—monoplane rudders. "Hull girder" construction, Lengthened LZ-40 class. First Zeppelin to have side cars. First use of two engines driving one propeller. High climbing class.
LZ-18	1	L-2	Sept., 1913	950,000	518.54	4.28	10.8	37.7	6,000	720	49	39			
LZ-25	19	L-3 to 8	1914	702,000	518.48	7.24	8.5	35.5	6,600	630	44	35			
LZ-26	3	L-9	Late 1914	880,000	530.52	4.26	9.8	36.7	9,000	630	50	40			
LZ-40	35	L-10 to 19	1915	1,128,000	530.61	3.33	14.7	43.0	10,000	840	53	42	28	2,400	
LZ-51	17	L-20 to 24	1915-16	1,262,000	586.61	3.38	14.7	44.0	10,500	960	59	47	30	2,000	
LZ-62	1	L-30 to 41	1916-17	1,040,000	649.78	4.58	9.1	54.0	14,000	1,440	60	48	34,000	52	
LZ-91	2	L-42, 43	1917	1,060,000	645.78	4.59	4.35	50.5	15,000	1,200	61	48	4,100	69	
LZ-95	7	L-44, 46, 48, 49, 51, 52, 54	Late 1917	1,070,000	645.78	4.59	9.38	61.5	20,000	1,200	61	49	4,650	75	
LZ-100	10	L-53 to 65, except 54, 57, 59	1917-18	1,075,000	645.78	4.59	9.39	65.6	21,000	1,450	71	56	5,000	66	
LZ-104	2	L-57, 59	Late 1917	2,420,000	743.78	4.73	4.50	69.6	18,000	1,200	63	51	6,200	84	
LZ-112	3	L-70, 71, 72	1918	2,400,000	743.78	4.72	8.43	60.0	21,000	2,030	75	60	4,500	58	
LZ-120	2	Passenger	1919	796,000	425.61	3.24	11.3	47.0	10,000	960	80	65	1,700	22	
Schutte-Lanz															
SL-2	1	..	1914	968,000	512.59	7.39	10.2	34.9	5,000	840	55	44	2,900	52	
SL-3	3	2	1915	1,144,000	503.64	8.34	13.8	39.4	5,000	840	53	40	1,300	25	
SL-8	3	3	1916	1,240,000	532.64	8.37	18.3	38.4	6,000	960	57	45	1,600	27	
SL-10	10	2	1916-17	1,370,000	523.66	9.11	7.20	48.5	10,000	960	56	44	2,600	43	
SL-20	3	2	1917-18	1,978,000	650.75	2.80	0.34	58.0	16,000	1,200	63	50	4,300	68	
BRITISH															
R-9	1	R-9	1916	889,000	520.53	25.6	3.8	17.0	1,000	360	45	36	200	4	
R-23	4	R-23, 24, 25, 26	Early 1918	997,000	535.53	28.7	5.7	19.9	3,200	1,000	52	42	550	10	
R-27	2	R-27, 29	1917-18	990,000	539.53	28.6	8.4	29.4	6,800	1,000	54	43	1,100	14	
R-31	2	R-31, 32	Late 1918	1,650,000	615.65	6.44	3.14	32.3	8,000	1,250	65	51	1,600	25	
R-33	2	R-33, 34	Early 1919	2,000,000	643.78	7.58	0.27	48-49	14,400	1,250	62	49	4,000	60	
R-36	2	?	1921	2,150,000	672.78	7.62	3.0	49.7	15,500	1,400	65	52	4,250	66	
R-80	1	?	1921	1,250,000	530.70	36.4	15.3	42.4	12,000	1,000	60	48	2,600	44	
R-98	1	R-98	1921	2,724,000	695.85	5.83	0.50	60.2	21,000	2,100	69-70	55	5,000	73	
UNITED STATES															
ZR-1	1	ZR-1	.....	1,080,000	645.78	6.56	0.28	50.0	15,000	1,650	59	48	4,300	70	
ZR-2	1	ZR-2	1921	2,724,000	695.85	5.83	0.50	60.2	21,000	2,100	69-70	55	5,000	73	
Ex-British R-38.															

Weights are in 2240 lb. tons. Miles are statute miles.  
Useful tons includes (a) Fixed load—Crew, food, guns, and other fixed equipment.  
Full power and full speed taken together.  
Cruising, or half power, speed assumed about 80% of full speed.  
Fuel consumption may be taken at conservative figures—.55 gasoline + .05 oil = .6  
Gasoline measured at 15.5 lbs. per gallon.

head winds is evidenced and serves still further to make the endurance over the surface of the earth an uncertain quantity, and one that can only be approximated. Again, the total lift will vary with gas purity, fullness of bags and atmospheric conditions. Attempt has been made, however, to put all the data on one basis and so permit a fair comparison. No attempt has been made to indicate the armament or bomb loads carried, as these items varied with the nature of the expedition.

A word of explanation as to the designation of German rigids is desirable. The "LZ" number is the building number used by the Zeppelin works. Ships for the German Navy used the letter "L" (Luftschiff) followed by a numeral. The German Army used the letter "Z" (Zeppelin), but later used the "LZ" symbol, except that beginning with LZ-72, the numeral was 30 units ahead of the building number (LZ-42), evidently to mislead the Allies. Schutte-Lanz ships were built under the letters "SL" followed by a numeral. The army ships retained this designation, but the navy changed to "L" followed by a numeral indicating its sequence in the combined (Zeppelin and Schutte-Lanz) naval fleet.

(TO BE CONTINUED)



U. S. NAVAL INSTITUTE, ANNAPOLIS, MD.

---

GRAPHICAL SOLUTION OF PROBLEMS IN NAUTICAL  
ASTRONOMY<sup>1</sup>

By CHARLES E. MANIERRE

---

There are a number of problems which require only an approximate solution, and which if they can be quickly solved give convenient information to the navigator. Graphical solution is peculiarly suited to this form of problem. The experience of the writer is that for the N-shaped figures about to be described a unit value of 6 inches, and for the triangular figures a base length of 10 inches, is sufficient to give satisfactory results within less than a half degree.

Such figures for practical use need not be of larger scale and should be lettered as simply as possible, omitting the function name.

If one is told to lay his ruler across the N-shaped figure so that it cuts two of the lines marked "latitude" and "declination," respectively, and on the third line where the ruler intersects it he may read the hour angle of the body when on the prime vertical, he may consider so slight an effort worth doing, and so with a half-dozen other similar problems.

In Appendix D of Muir's Navigation will be found one of these N-shaped figures taken from an article by Captain de Aquino, in No. 126, p. 633, of the PROCEEDINGS of the U. S. Naval Institute. There is too much mathematics connected with this figure to make it attractive to the average navigator. The article itself was in part historical and it developed the fact that while the N-shaped figure could be used to solve right angled spherical triangles, using the middle part and two adjacent parts, there was also a figure consisting of two lines forming an acute angle, which angle was bisected by a third line, which lines when properly lettered could be used for solving right angled spherical triangles, when the parts

<sup>1</sup> Copyright, 1921, by Charles E. Manierre.

involved were a middle part and two opposite parts. A reference to this article will show that the formula for lettering this last mentioned figure was rather difficult. For some reason Captain de Aquino gave his attention only to the N-shaped figure and to its use for purposes not to be attained without considerable study.

The object of this article is to comment on the N-shaped figure--to describe a new triangular figure found suitable by the writer for solving right angled spherical triangles when a middle part and opposite parts are involved, and to indicate by figures how these should be lettered for use.

A reader may construct his own without much effort. In constructing the N-shaped figure he will have to lay off a natural tangent spacing from  $0^\circ$  to  $58^\circ$  so that the line shall be very nearly  $9\frac{1}{2}$  inches long between these two values. The unit value for such a scale is 6 inches and is comprised between  $0^\circ$  and  $45^\circ$ . As a cotangent scale the spacings are the same, but the markings will be complementary, viz.,  $90^\circ$  to  $32^\circ$ . In like manner mark a line with nat. cosine spacings from  $0^\circ$  to  $90^\circ$  and being in length 6 inches and be prepared also to letter the same spaces for hours and minutes from 0 hrs. to 6 hrs. For the triangular figures a 10-inch base may be spaced for sines and cosines by using a scale divided into  $1/10$  of an inch to be treated as  $1/100$  of the 10-inch unit and by referring to a table of natural sines for space values. If this be treated as the base line of a triangle, similar scales of any desired length may be made by intercepting the sides of the triangle by lines parallel to the base, which may be subdivided by lines drawn to the apex..

It is required in the N-shaped figures that the sides be parallel and that the unit length on both sides be the same, *i. e.*,  $0^\circ$  to  $90^\circ$  cosine will equal  $0^\circ$  to  $45^\circ$  tangent, in length. The diagonal is divided by lines drawn, or a ruler laid down, from each marked value on the tan or cot side to the upper end of the cosine line and the intersection is given the same value or the complementary value, as indicated in the figures herewith, or on the folder.

The diagonal is spaced symmetrically about its middle or  $45^\circ$  point so that the lower end may be lettered, though the values are not to be found on the side line. The non-essentials are, the distance which the parallel lines are apart or how far above the  $\cos 0^\circ$  point the  $\tan 0^\circ$  point may be.

In the triangular figures, except the rate of change figure, the inside parallel is spaced and lettered by lines from the base to the apex, the values given being the same as, or complementary to, those on the base.

The diagonal spacings are determined by lines from the left-hand end of the base through the values on the inside parallel, and here also the values marked are either the same as on the parallel or complementary, as indicated in the several figures.

The rate of change figure as used by the writer is a right angled triangle  $7\frac{1}{2}$  inches on the azimuth side with a base of  $9\frac{1}{2}$  inches, and the rate of change line parallel to the azimuth side and not quite 2 inches from it, but so located that it is 6 inches in length.

In constructing the rate of change figure the sine scale for Azimuth is first completed; then by using the apex of the opposite angle it may be transferred to the interior parallel with complementary markings for the temporary purpose of lettering the diagonal representing latitude, by lines drawn from the foot of the sine scale through the temporary cosine markings on the interior parallel. The intersected point on the diagonal being given the same cosine degree value. These markings on the parallel are then *replaced* by dividing it into 15 equal parts.

It is not essential that any of the triangles have any particular shape or that the inside parallel be at any special distance from the base. The effect of altering the relative dimensions is to expand or contract different parts of the scale. The writer found it convenient in the triangles other than rate of change to locate the inside parallel so that it has a length of 8 inches. He had much use for proportional dividers and found it convenient to duplicate his drawings by pricking through several thicknesses of paper with a needle the division markings, which were afterward inked for different purposes, the spacings being the same for all.

For study the figures may bear their tan, cot or cos values, but for use these are better omitted.

It will be noted that the unlettered side of the triangle could in all cases be omitted. It is only retained to give solidity to the figure.

Those who are at all interested in this subject will doubtless accept the figures herewith tentatively as correct and test one or more of them by problems otherwise worked out to a known solution. There may be others who will wish to be acquainted with the



method of constructing the figures, so as to produce them at will, and perhaps still others who will be interested in a further brief discussion of them.

This article will therefore deal first with the directions for use, then with the methods of reproducing the figures, and finally with a discussion of the subject.

With each figure will be found one or more formulas which can be solved by its use. The N-shaped figures are essentially the same as the one to be found in Appendix D of Muir's Navigation. The triangular figure is one suggested by the writer, as also the figure for rate of change in altitude. The N-shaped figure is for the solution of right angled spherical triangles where a middle part and two adjoining parts are involved as defined by Napier's Rules, while the triangular figure is to be used where the parts are a middle part and two opposite parts.

The directions for the use of Figs. I to V, inclusive, are simple. A straight edged ruler is so placed upon the figure as to intersect the lines lettered for the known quantities at their given values. The value of the unknown quantity will then be found at the intersection by the ruler of the third line. In most cases the result will be accurate within a half degree of arc. It will be found convenient to use the point of a needle or the dividers at the value located and to hold the ruler against this instrument while finding the second given value.

It will appear that in the triangular figure one side of the triangle is only drawn to give solidity to the figure and is ignored in the discussion of the subject. It will also be noticed that so far as the spacing of the two types of figures is concerned, all the figures of each type are duplicates and differ only in the lettering excepting, however, Fig. III, which is peculiar to itself although similar in general appearance to the other triangles. The parts of the other triangular figures will be described as the base, the diagonal and the inside parallel, or more briefly, the parallel.

Where two solutions are to be had from one figure the values assigned to the lines and shown in brackets will be used when so indicated in connection with the formula at the side of the figure.

It would be quite possible to letter a single triangle to cover all the problems except that shown in the rate of change figure, but such a triangle would prove confusing in use.

LETTERING AND EQUATIONS

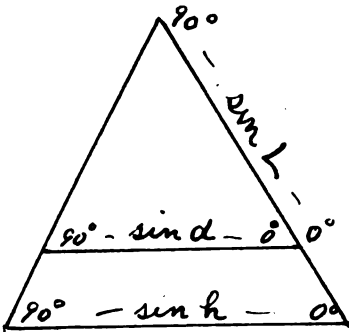

For Prime Vertical.  
To find  $h$ ,  
 $\sin d = \sin h \sin L$ .

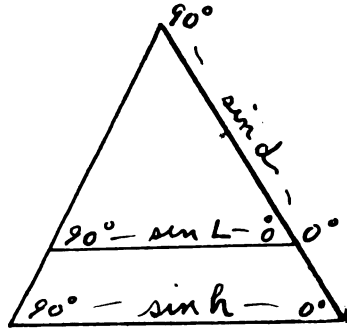

For Greatest Elongation.  
To find  $h$ ,  
 $\sin L = \sin h \sin d$ .

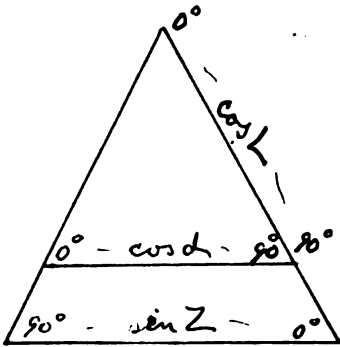

For Greatest Elongation.  
To find  $Z$ ,  
 $\cos d = \sin Z \cos L$ .

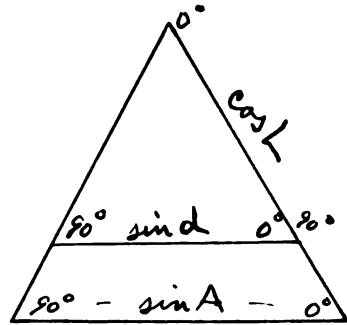

For Amplitude.  
To find  $A$ ,  
 $\sin d = \cos L \sin A$ .

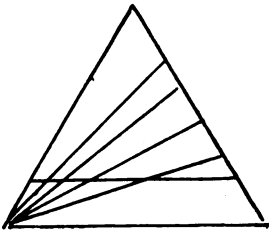

Method used in spacing the diagonal.

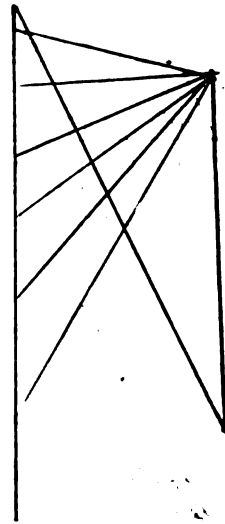
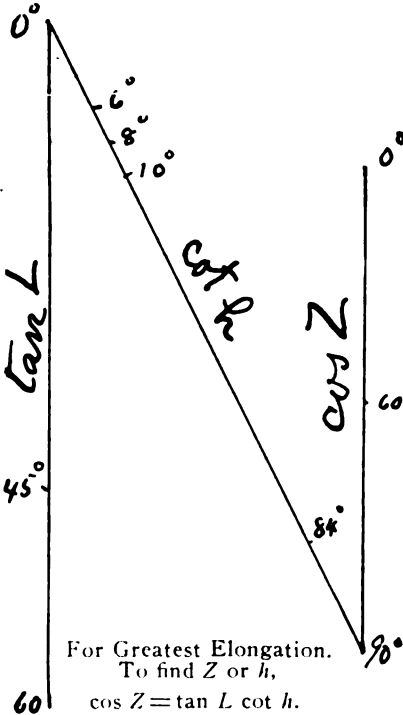
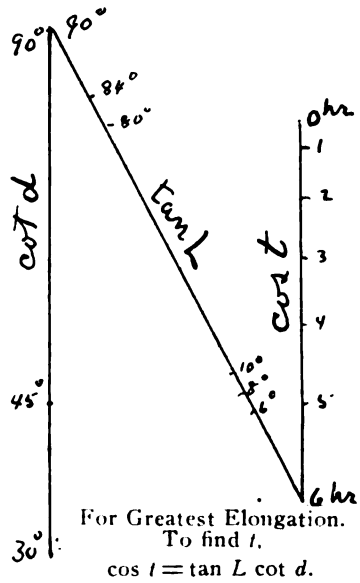
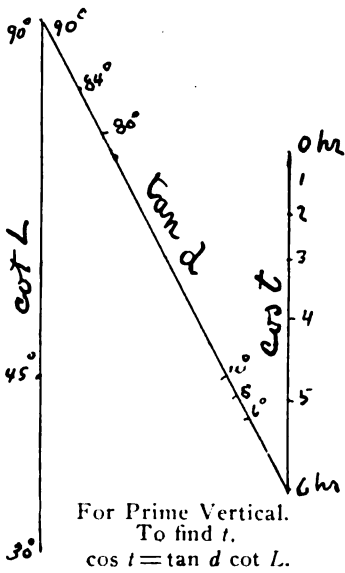

Method used in spacing the diagonal.

Fig. III is for use with approximate latitude and azimuth to determine the rate of change in altitude of any heavenly body and requires only that the ruler should be placed to intersect the diagonal at the given latitude and the given azimuth at the left of the figure, the rate being read from the middle line in minutes of arc.

Fig. VI, entitled "Azimuth," requires two alignments of the ruler, by the first of which a point on the parallel line is found, which for convenience may be called  $\theta$ , and which in the second placing of the ruler is deemed to be a known quantity. The line is not lettered because the value of  $\theta$  need not be known. Its position is held by the point of the dividers and the ruler revolved to the third known quantity. The four values in the formula are taken in pairs. Time and declination are first used in placing the ruler, and next altitude and  $\theta$ , the intersection of the ruler upon the diagonal being then at the value of the azimuth.

For example, declination  $30^\circ$ , hour angle 3 hours, will locate  $\theta$  so that for an altitude of  $45^\circ$  the azimuth will be found to be about  $60^\circ$ .

Although the azimuth is generally the unknown quantity, the figure is equally applicable to finding any of the other quantities if the azimuth is known. It will only be necessary to take first the pair of values consisting of the two known quantities, and having located  $\theta$  to use it and the remaining known quantity to locate the unknown.

The chief use of the figure is for finding the azimuth with  $t$ ,  $d$  and  $h$  as taken from the working of the St. Hilaire problem to lay down a position line or to check the compass readings.

Fig. VII is for use when approximate latitude and the hour angle and declination of a heavenly body are known and it is desired to obtain an approximate altitude for setting the sextant arc prior to observing. Latitude and declination may be taken to a quarter degree and the hour angle as determined for the time of observation within two or three minutes of time.

The use made of these quantities is indicated by the small figures on the right-hand side of the figure as shown on the folder the first of which indicates that with latitude and hour angle, the latitude being read on the base of the figure, sine  $\theta$  is found on the parallel. In the second small figure  $\theta$  is found as a cosine on the base and with latitude on the parallel, a second unknown quantity  $x$  is found

as a cosine on the diagonal. The numerical difference  $x$  and the polar distance of the body is taken as a cosine on the diagonal with cosine  $\theta$  again on the base, as the third alignment of the ruler. The only exception is when the hour angle is greater than 6 hours, in which case the numerical sum of polar distance and  $x$  is taken.

It is to be noted that where the arc, whether in time or degrees, exceeds 6 hours, or  $90^\circ$ , the supplement will give the same sine value, hours being subtracted from 12 hours and the given number of degrees from  $180^\circ$ .

Below Fig. VII on the folder will be found the working of the problem both for the sun and for a star.

Fig. VII may also be used to find the right ascension and declination of an unknown body whose altitude and compass azimuth have been observed and the time noted. This use of the figures requires four placings of the ruler. These are indicated by small figures just below Fig. VII under the word "Alignments." The interpretation of these small figures is similar to that just given. The first unknown quantity to be found is  $\theta$ . The second is  $x$ . The numerical difference of latitude and  $x$  is taken in all cases except where a perpendicular dropped from the body upon the meridian would fall below the elevated pole, in which case the numerical sum is taken. Using this difference the declination is found and then the hour angle. The hour angle is combined with the local sidereal time to find right ascension.

#### METHOD OF CONSTRUCTION

The triangular figures with the exception of the rate of change figure may be constructed with a triangle of any shape whatever, though the shape and size of the figure as shown may be deemed satisfactory. For certain purposes an increase in the space between the base and the parallel line and a change in the slope of the diagonal will serve to open out one end or the other of the spacing on the diagonal scale.

The base is divided according to the values of natural sines or cosines, the linear zero being at the foot of the diagonal and corresponding to zero degrees for a sine or  $90^\circ$  for a cosine scale. The parallel is similarly divided, either by an independent process or by intersecting values on the base by a line drawn from the apex of the triangle. The divisions and lettering of the diagonal are

determined by lines drawn from the left-hand lower corner of the base through the values indicated on the parallel line, which values are given to the division intersection if both the parallel and the diagonal represent sines or both represent cosines. If one is sine and the other cosine, complementary values are given on the diagonal. The degree values on the diagonal are also expressed as hour values at eight-minute intervals so as to avoid two separate space markings on the diagonal.

The rate of change figure may be constructed with a triangle of any shape. The method of construction has already been described.

The essentials of the N-shaped figure are two parallel lines intersected by a diagonal and the method of construction has been given.

It may be noted, however, that the product of tangent and cotangent of any arc is always unity when natural values are used. This fact makes the lettering possible.

It will be evident that the diagonal is not spaced according to its lettering. In fact it is symmetrically spaced about the  $45^\circ$  point. It is thus possible to space the end of it which joins the cosine line notwithstanding the fact that the corresponding points on the parallel line are far beyond the limits of the drawing.

#### DISCUSSION

The principle of the triangular figure may be illustrated by Fig. 1, in which the lines are divided  $\frac{2}{3}$ ,  $\frac{1}{2}$  and  $\frac{1}{3}$ . It will be apparent that the method of dividing the diagonal is such that each point on the diagonal may serve as an apex of a triangle having the base  $BC$ , which will also have an inside parallel diminished from the original length to a value equal to that given the point on the diagonal. This reduced parallel will be again subdivided so that  $\frac{2}{3}$ ,  $\frac{1}{2}$  or  $\frac{1}{3}$  of it remains if lines are drawn to the new apex from points on the base having these values. The result is that any fraction on the diagonal multiplied by any fraction on the base will give a product equal to the value of the point of intersection with the parallel as originally lettered. Instead of using numbers, arc degree values representing natural sines or cosines of the respective fractions are substituted with the result that two such degree values may be multiplied together and the degree value of their product read without the intervention of numbers. The natural sine value for example of  $\frac{1}{3}$  in degrees is approximately  $15^\circ$ ; of  $\frac{1}{2}$ ,  $30^\circ$ ; and  $\frac{2}{3}$ ,  $49^\circ$ .

The principle of the working of the N-shaped figure may be indicated by considering any single alignment, as, for example, Lat.  $42^\circ$ , Alt.  $46^\circ$ , as shown in Fig. 2. The corresponding value of azimuth will be very nearly  $30^\circ$ . The decimal value of each of these quantities is shown and the product of the other two will be found very nearly equal to that at  $30^\circ$  on the line  $AB$ . Note that the numerical value .8660 on  $AB$  is also the fractional part of  $AB$  as measured from  $B$ .

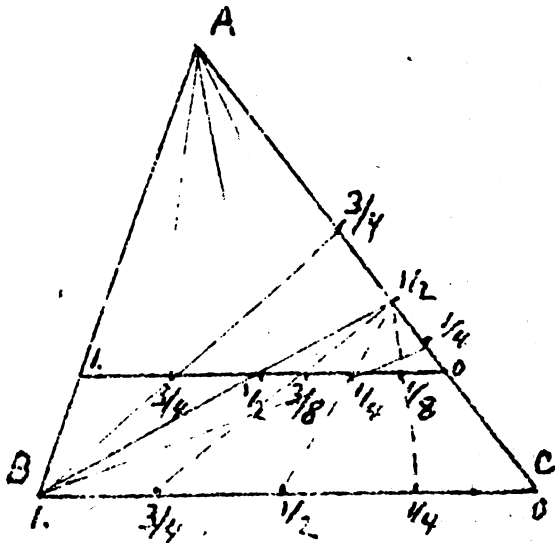

FIG. 1.

In the second figure an additional line is drawn from the unit point  $A$  to the point on  $CD$ , having the same degree value as at  $E$ , viz.,  $46^\circ$ , such line passing through  $E$ . It will be seen that two similar triangles are thus formed, having a common apex  $E$  and their bases parallel. One of these is the unit base  $AB$  and the other a base  $C-46^\circ$ , which has a linear value of 1.0355—the natural tangent of  $46^\circ$ . The product of this tangent value with the cotangent value of  $46^\circ$  indicated on the figures is unity.

Any line drawn through  $E$  will divide the two bases proportionately and the two bracketed distances will each bear the same ratio to the whole base of which they are a part. Inasmuch as 1.0355 on the left-hand base is reduced to unity by the multiplier

.9657, the same multiplier will reduce the  $42^\circ$  natural tangent value .9004 to its equivalent for a unit base which will be found to be .8660—the decimal value of  $30^\circ$  as found on  $AB$ . The same reason applies to all other lines intersecting the diagram through any value of  $E$  on the diagonal.

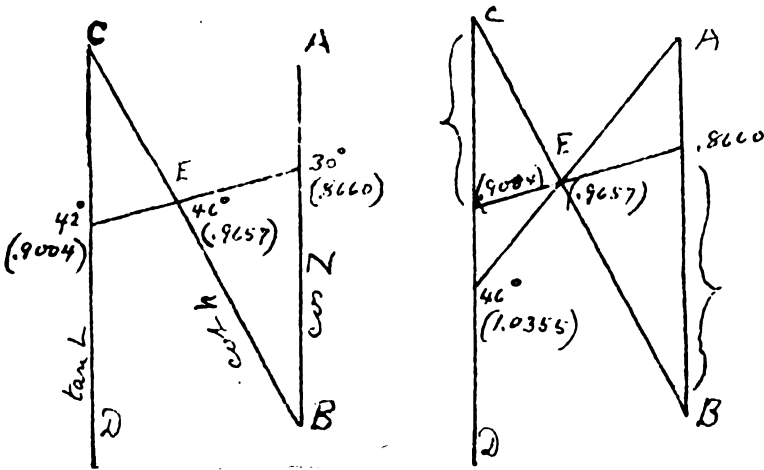

FIG. 2.

In other words, the figure may be deemed to be made up of an indefinite number of pairs of similar triangles, all of which have a common apex at different points of the diagonal, with the line  $CB$  constituting a side of each pair and  $AB$  constituting the base of one triangle of each pair.

The foregoing has been hastily prepared and the writer will be glad to have called to his attention any error that may be noted or any point not clearly stated.













## DISCUSSION

---

### Amalgamation and Specialists vs. Corps

(SEE PAGE 1209, WHOLE No. 222)

LIEUT. COMDR. KENNETH C. MCINTOSH (S. C.), U. S. Navy.—As the late Friedrich Nietzsche would have remarked, "Controversy is foreign to my nature." I have no doubt that there are many other officers who are going to make reply to the article named above, and probably more conclusively than I; but there may not be, and a few points brought out (if not *made*) are worthy of a voice from the other side.

Commander Fisher states baldly at the beginning of his thesis that the only reason for the establishment of corps is a desire for power on the part of some specialists, and declares that all authority now enjoyed by these segregated corps specialists has been in some way craftily stolen from the line, or commanding corps. Now it is a fact that every corps, not excluding the line, has its normal percentage of scatterwits; and I have during the past sixteen years heard the idea advanced that staff officers under certain conditions should have more absolute control than they now have; sometimes these recommendations being carried to the absurd limits which have apparently stirred up Commander Fisher to write about it. It is a rash proceeding at best, however, to judge the value of any large body of workers from the noise made by their inevitable foolish five per cent. There may be some staff officers who are rabid for "power"—I cannot think of any just at present, but I can remember some now happily no longer with us. But of the staff officers who are regarded by staff and line as efficient, I cannot think of one who has any other ambition than to be the best possible servant of the navy. To accomplish this ambition, a certain amount of administrative authority is at times requisite, but there is a vast difference between administration and command, a difference apparently unrecognized by Commander Fisher. In fact, the difference is so marked that in many cases I have personally encountered, the ability of the line officer in command has been actually diminished if not nullified by circumstances which forced an undue amount of administration and administrative duties on his already overloaded shoulders. As far as this administrative authority is concerned, it is necessary and desirable only for one reason, and that a compelling one—you cannot hold a man responsible for anything over which he has no authority. Would Commander Fisher expect the commanding officer to reconcile his ship's statement of differences from the treasury? The best answer to this assertion as to the "only reason for corps" is to deny it absolutely as erroneous. In my own case, which is the one about which I naturally know the most, there is no line officer who can truthfully state that I have ever attempted to usurp

one iota of his authority although there are many who have at times honored me with special duties entirely outside my normal ones involving a high degree of administrative authority and at times actual if not theoretical command. I do not base any assumption that I would amalgamate into a decent line officer on these circumstances, and I would combat anyone who attempted to use them as argument for amalgamation. I haven't time to be a good line officer, although I am an 8 to 10 knot navigator, was at one time one of the most successful spotters in the navy, have trained guns' crews who wore E on their sides, and have been powder division officer and have stood watch at sea and in port. I realize that these duties are but excrescences on the duty of the line, which is command and winning battles. That Commander Fisher is viewing only the similar excrescences of staff duties is witnessed by his remark about "specializing in disbursing pay."

The paper states that corps make for laziness in the line. Perhaps. But I have never seen a successful, lazy line officer. Nine times out of ten, when the line officer isn't actually working with his tools and his hands, he is studying how, or talking shop or thinking along his lines—in short he is putting all his time in on his profession. So are we of the staff. Naval duties are not stationary. The duties of my corps no more resemble their duties of fifteen years ago than a flying boat resembles an Old Town canoe. This very feature makes the three-year detail ridiculous. Is there any line officer who would contemplate leaving his profession for three years without qualms about the difficulties he will encounter on coming back? So with all of us. A supply officer whose detail ended in March, 1920, now back at line work would have a hard time. In March, 1923, when he returned to supply duties he would have a worse one, for the greatest bloodless revolution in history has taken place in the finances of the U. S. Government and every word, comma and semicolon in the Budget Act has an immeasurable effect on all fiscal branches. The accounting system has undergone changes no less vital, the store-keeping system has been overturned; and why? Simply in order that fiscal officers may be better and more economical servants of the country which in our case means the navy; and to the supply corps, "the navy" translates into all other corps, headed by the line, all enlisted men and civilian employees. I think I am able to learn new things with fair rapidity—average at least. It takes all my time keeping abreast of current advances in the art and science of my profession. If I left it for three years or one year, I could never get back to it satisfactorily.

The ranking officers of the supply corps are not, as the paper states, "doing administrative work similar to that performed by line officers," etc. They are doing administrative work which is far removed from that done by line officers or *ever* done by line officers: They are doing *commercial work adapted to military needs* and there is no conceivable psychology more unfitted to commerce than that of the kind of line officer who is a successful commanding officer. And the converse is also true—that is why no amount of study could make anything but a makeshift line

officer out of the truly successful staff officer—his mental processes swing in different orbits, around the common center, operations of the navy. And while the officers attached to the Bureau of Medicine and Surgery do not spend their days writing prescriptions, a little investigation will convince Commander Fisher that the senior officers of that corps at hospitals are doing a very great deal of "specialist" work as consultants and as operators.

Which brings me to the assumption of the article that all authority now exercised by the staff has been taken from the line. This can also be flatly denied, since the issuance of G. O. No. 53. No authority in any line which the line ever handled is now in the hands of the staff. The rendition of fiscal and financial returns by the commanding officer cited, ceased when the fiscal officer became an officer. The captain once rendered returns because the purser was *not in the navy nor the government service in any capacity* but was simply a civilian contractor.

A great many of the arguments used are now rapidly disappearing, for instance the accounting duplication. Naval accounting has got past the bookkeeping stage and is now a science as well as an art. There seems to be no obvious reason for the detail of an officer of the supply corps to each bureau—does it matter in which room your servant works, as long as your work is done? The "control of various appropriations" is a fleeting matter—soon the number and diversity of those appropriations will begin to melt away, and eventually, as sure as rent day, there will be but one navy appropriation with a few limiting provisos.

One thing which is forecasted is that the supply corps will soon and inevitably demand its own enlisted personnel. This is a rather startling conjecture to me at least. I have always had best results in training men who had been taught discipline first by the men who specialize in discipline—the line. Moreover, I would hate to think that the time will ever come when I will find it impossible to have a yeoman broken back to his former deck rating of sea. 2c., when he needed it, without discharge and reenlistment. An enlisted man who has been handled and brought up by good line officers is the only material really worth spending time on in supply departments afloat or ashore—but it takes more than an occasional three-year detail before an officer is fit to train him in a supply department rating.

Navigators, gunnery officers, engineers and first lieutenants have this thing in common, which is the logical reason for their all being line officers—their business is to get the ship into battle, to fight her in battle and to win the battle, and their every activity of discipline, cleanliness, shooting the sun or overhauling the condensers is toward that object. Pay, commissary, clothing, accounting, issue of supplies (not requisition, except as regards the final, legal form required by statute. *Tous autres chevaliers de la garde* must ask for what you want) are all different, from each other and from the dozen or more other unmentioned duties of the supply corps. BUT, they are all commercial and fiscal, and so must be together.

Paragraph 33 of the article reads: "No bureau wants to be the indirect cause of increasing the number of officers in a corps, centering in some



other bureau, and thereby decreasing their own relative authority . . .” Brothers, brothers! Are we like that? Most of us? *Any* of us except the fool five per cent? I had thought the Act of August 29, 1916 stepped on that really treasonous self-seeking between corps . . . . .

“The power to direct and control flows only to the man who by general experience knows how.” Right, a thousand times right! And the corrolary is that the man who tries to direct and at the same time retain cognizance of all the details better left to specialists cannot direct. The best commanding officer under whom I have ever had the honor to serve—and I have been unusually fortunate in regard to commanding officers—once told me that “the hardest thing about my job is to remember that I am no longer the executive, and when I was executive it is a wonder the engineer didn’t poison me for the way I interfered.” That particular commanding officer is the only line officer of my acquaintance who had studied supply work sufficiently to direct details—and he is also the only one who consistently and inevitably never did so direct the details but left them entirely to me, his specialist, saying nothing when things went right, “crawling my hump” if they were only right, instead of *best*. A specialty which demands all of one’s waking, working, studying time cannot be made a detail; and the specialist officer is like a virgin in one respect—he’s entirely specialist or he is none at all! The days are past when “getting by” will do in anybody’s job in the navy; and the man who must “get assistance from others who have”—which means, be educated by his yeoman—can never hope to do more than just barely “get by.”

“Line officers have, in the past, controlled the navy . . .” yes, and thank the Lord they still do! Never, I hope, will the main mission of “getting there fustest with mostest ships” be subordinated to any form of theoretical control! But when a line officer has to lose sight of his main mission, even for a brief period, he is as bad as the staff officer who loses sight of *his* mission—deadwood, a hybrid, a salary-drawer. Command us and we serve, gentlemen of the line. But when it comes to the comptroller, or the auditor, or manufacturing, or cost accounting or purchasing or storekeeping or transportation or chartering or curing dysentery or planning a balanced ration or locating raw materials or keeping within statutory limitations of appropriations and still getting the work done—unless you put in *all* your time at it, you must do it in something less than the best and most economical and efficient way. Your job is too vital to the nation to have its *non-fighting* details hamper your attention.

U. S. NAVAL INSTITUTE  
SECRETARY'S NOTES

**Membership** Life, regular and associate, 5487.  
New members, 9. Resignations, 9. Deaths, 7:

- Lieut. Commander B. A. Strait, U. S. N.
- Lieut. Commander E. W. Coil, U. S. N.
- Lieut. Commander V. N. Bieg, U. S. N.
- Lieut. Commander H. W. Hoyt, U. S. N.
- Lieut. M. H. Esterly, U. S. N. R. F.
- Ensign W. F. Cleveland, U. S. N. R. F.
- Mr. Paul Crocker.

Practically the whole service receives the benefit of the PROCEEDINGS yet many officers, who read it monthly, are not members and therefore contribute nothing to the support of the Institute. Members are requested to urge non-members to join. Publication costs are now so high that the Institute is carrying a loss. The cost, per member, however, decreases with an increase in membership.

The annual dues (\$3.00) for the year 1921 are now **Dues** payable.

Regular and associate members of the U. S. Naval Institute are subjected to the payment of the annual dues until the date of the receipt of their resignation.

Discussion of articles published in the PROCEEDINGS is cordially invited. **Discussions** accepted for publication are paid at one-half the rate for original articles, or about \$2.25 a page.

To insure the delivery of the PROCEEDINGS and other **Address** communications from the U. S. Naval Institute, it is essential that members and subscribers notify the Secretary and Treasurer of every change of address, without **of** **Members** delay.

**Book Department** *The Institute Book Department will supply any obtainable book, of any kind, at retail price, postage prepaid.* The trouble saved the purchaser through having one source of supply for all books, should be considered. The cost will not be greater and sometimes less than when obtained from dealers.

The Boat Book, 1920, and the Landing Force and Small Arms Instructions, 1920, are now ready for issue. The price of the former is 50 cents per copy, and of the latter \$1.00 per copy.

The latter part of October the Institute will have ready for distribution a new book entitled "Airplanes, Airships, Aircraft Engines" by Lieut. Albert Tucker (C. C.) U. S. Navy. The price of this book will be announced later.

The Seaman's Hand Book, containing much valuable information for enlisted men, particularly those of the deck force, has been added to the Institute's publications. This excellent little book is retailed at 65 cents per copy.

**Index to Proceedings** The attention of readers of the PROCEEDINGS is invited to the classified analytical index for numbers 101 to 200 inclusive, which is noticed under "Publications." This is a most complete index, which has been prepared at considerable expense in order to make readily available the information contained in both the articles and the notes of these issues. Only a limited number of copies are being printed. Price, bound in cloth, \$2.35; bound in paper, \$1.85.

The Institute desires articles of interest to all branches of the service, including the Reserve Force. Attention is invited to the fact that the submission of articles is not limited to members, and that authors receive due compensation for articles accepted for publication.

All articles and discussions submitted by persons belonging to the navy for publication in the PROCEEDINGS must be in duplicate, one copy being signed by the author, which will be submitted to the Navy Department when the original is published, as required by General Order No. 46, of May 20, 1921.

**Reprints of Articles** The attention of authors of articles is called to the fact that the cost to them of reprints other than the usual number furnished, can be greatly reduced if the reprints are struck off while the article is in press. They are requested to notify the Secretary and Treasurer of the number of reprints desired when the article is submitted. Twenty copies of reprints are furnished authors free of charge.

**Illustrations** Authors of articles submitted are urged to furnish with their manuscript any illustrations they may have in their possession for such articles. The Institute will gladly co-operate in obtaining such illustrations as may be suggested by authors.

Original photographs of objects and events which may be of interest to our readers are also desired, and members who have opportunities to obtain such photographs are requested to secure them for the Institute.

**Notice** Whole Nos. 6, 7, 10, 13, 14, 15, 17, 144, 146, 147, 173, 215 and 217 of the PROCEEDINGS are exhausted; there are so many calls for single copies of these numbers that the Institute offers to pay for copies thereof returned in good condition at the rate of 75 cents per copy.

ANNAPOLIS, Md., October, 1921.

#### INFORMATION INDEX

	PAGE
ADVERTISEMENTS, INDEX TO.....	I
PUBLICATIONS, U. S. NAVAL INSTITUTE.....	(2)
SPECIAL NOTICE .....	1674
TOPICS FOR ESSAYS .....	1675

# PROFESSIONAL NOTES

PREPARED BY

COMMANDER F. M. ROBINSON, U. S. Navy

## GENERAL ARRANGEMENT

VESSELS BUILDING.	}	France .....	1612
NAVAL POLICY.		Germany .....	1618
MATÉRIEL.		Great Britain .....	1625
PERSONNEL.		Japan .....	1631
MERCHANT MARINE.		United States .....	1633
AERONAUTICS .....			1640
NAVIGATION AND RADIO .....			1654
ORDNANCE .....			1663
MISCELLANEOUS .....			1665
CURRENT NAVAL AND PROFESSIONAL PAPERS .....			1666

## FRANCE

**CRUISER DESIGN.**—One of the most significant items in the new French naval program is the decision to build a larger type of cruiser than any planned during or since the war. It may be recalled that in 1918-19 M. Leygues, in the program he put forward as Minister of Marine, stated that the 1912 building plan had left France destitute of light cruisers for scouting and other duties, and he therefore proposed six vessels of 5000 tons, 30 knots speed, and armed with eight 5.5-inch guns. Then in 1920 M. Landry, the new Minister of Marine, adopted the six cruisers as part of a program which he framed, but a slightly larger displacement, 5200 tons, was scheduled for them. Now, under the vigorous administration of M. Guist'hau, the matter has entered upon a new phase, and sanction has been obtained for the construction of six armored vessels of 8000 tons with a speed of 35 knots, and armed with a new pattern of 194-millimeter (7.5-inch) quick-firing gun.

The explanation given of the decision to make this increase is that the Germans are about to begin a series of large, fast armored scouts of a nominal displacement of 6000 tons, which might easily outclass the 5200-ton vessels of the old French program. It is entirely natural that our Ally should not wish this to come about, but the fear would seem to be rather exaggerated. Under the Peace Treaty, Germany has the right to build cruisers up to 6000 tons, but only in replacement of ships allowed her under the Treaty, and as the latter include only six light cruisers it follows that she could not build more than that total even in the remote contingency that all were to be replaced at the same time. It seems more reasonable to conclude that the French Ministry of Marine has been influenced to a great extent by the new types evolved towards the end of the war in England and America, and now represented by the *Hawkins* and the *Omaha* respectively. With the launch of the *Effingham* on June 8 at Portsmouth, all four of the cruisers in the British series of 9750 tons, 30 knots, and seven 7.5-inch guns are in the water; and with the launch of the *Cincinnati*

on May 23 three of the ten American vessels of 7500 tons, 33½ knots, and twelve 6-inch guns are also afloat. Whether Japan is building such large light cruisers is uncertain. It was reported at the launch of the *Nagara* at Sasebo on April 25 that this vessel would be of 5770 tons, 33 knots, and armed with seven 5.5-inch guns.

If the French in their new cruiser design are chiefly concerned to follow the lead of Britain and America, they ought to know in their own minds what are the tactical uses to which their new cruisers will be put. The British *Hawkins* class was built for one purpose only, that of an ocean-going and ocean-keeping commerce protector, strong and fast enough to account for any such corsair as the *Emden*. The battle cruiser, originally built for such a duty, among others, was not utilized for it in the war on account of being more urgently needed elsewhere, but if she had been so used, in conjunction with light scouting craft, the commerce raiders could not have survived any more than did von Spee's squadron when the *Invincibles* were directed against it. There is no need now to repeat the *Hawkins* type. If this was done the ships would certainly attract to themselves other duties, they would be followed by larger craft abroad, to which in turn we might have to reply with still larger vessels—until in time the original conception was lost sight of. So there would be repeated the great mistake of the armored cruiser and large protected cruiser, which grew and grew to an extent probably never foreseen when they were originated in the nineties, but which did nothing of note in the war. It is unsound policy to go on building ships, each new type increasing in size and cost, without knowing the use to which they will be put in the event of war.—*The Army and Navy Gazette*, 27 August, 1921.

FRENCH NAVAL TOPICS.—Although the old gentlemen of the Senate, in their hurry to get out of Parisian heat and fever, forgot to vote the naval program, the business-like Minister Guist'hau is acting with as much decision and foresight as if that indispensable formality had been complied with, in the knowledge that "*le temps perdu ne se regagne jamais*" in the shipbuilding line, and that the value to France of the remarkable fighting units designed by the *Section Technique* depends for a great part on the speed and efficiency that will be produced by their construction. Orders have been given to conclude the *Thüringen*, *Prinz Eugen*, and *Béarn* experiments before the end of the current month, so that all practicable data may be embodied in the new vessels, and a "*rapport d'ensemble*" made upon the scientific progress revealed by the comprehensive tests now being carried out in Paris, as well as in the arsenals.

A new development in the redistribution of the French fleet has taken place with the appointment of Rear Admiral Lequerré (57 years of age) to command the recently-formed "*Division de la Manche et de la Baltique*." This distinguished flag officer, who has just relinquished the post of *Directeur Militaire du Personnel* at *Rue Royale*, will have under his orders a numerous though heterogeneous force, modest enough so far as up to dateness and ballistic power are concerned, but adequate for the purpose for which it is intended, viz., the possible blockade of the coasts of Bocheiland. It will comprise three 18,000-ton ships of the *Voltaire* class (*Voltaire*, *Diderot*, *Condorcet*) that received a few war modifications and improvements, and the *croiseurs cuirassés Hugo* and *Ferry* (yet good for 20 knots), together with over 40 destroyers and avisos, without mentioning the underwater and aerial craft of the Cherbourg center that are being placed on something like war footing. The above-mentioned battleships and cruisers will, for some little time yet, need the care and nursing of the Brittany arsenal if they are to make good the defects that have developed during the last two years of complete neglect which they spent in the Toulon naval cemetery. In waiting for possible emergencies, Admiral Lequerré will keep up the era of active training for war inaugu-

rated in the northern waters by Admiral Salaun; all the more so, as he will have the hearty co-operation of the Brest and Cherbourg *Préfets Maritimes*, Admirals Schwerer and Barthes, who have revealed themselves as true men of action and are alive, like most of their colleagues are, to the offensive rôle naval bases will play in future contests. The long spell of naval stagnation along the Breton and Norman coasts has come to the end. As commanded by sound logic, the *Marine Française* is henceforth to display its greatest training activity in the proximity of its chief recruiting centers.

This French naval concentration in the North, which is the sign of a new turning in the maritime policy of the republic (and also a proof of France's inflexible will that *Bocheland* be made to repair and to disarm), will have the effect of weakening France's position in the Mediterranean, and it is implicitly a mark of trust given to our "Latin sisters." The latest Ministerial declaration in Rome insists on the importance of maintaining the naval equilibrium in the Mediterranean, and the relative position towards France (which is something like equality of forces) which the Italian Navy has acquired as the twofold result of constructions made during the war and of the 1914-21 stagnation in French yards. The seven 24,000-ton battleships of Admiral Salaun will have a ballistic superiority over the dreadnought fleet of the peninsular navy, but the latter will enjoy distinct advantage for cruisers and *poussière navale*. At the same time, it is realized that since the war the constituting elements of the command of narrow European seas have been changed. Neither the gun nor the torpedo will rule Mediterranean waters. When strategic conditions are examined, and actual plans and preparations taken into account, the biggest factor to be considered will be that of the aerial bomb.

Moreover, for the present, at least so far as contests on the high sea are concerned, the Mediterranean supremacy is in the hands of Great Britain, who, besides controlling the gates and central passages of the Middle Sea, can at any time she pleases, array in Southern waters battle forces strong and efficient enough to throw into insignificance the united French and Italian squadrons. Armchair critics, as instanced by the recent confused debate in the Paris Chamber, are apt to forget that an important consequence of the suppression of the Boche armada has been to restore to the British fleet complete freedom of movements, and to make her the uncontested mistress of European waters, and especially of the Mediterranean, where the foresight of British admirals and statesmen made sure of the controlling positions of Gibraltar and Malta, without mentioning more recent strategic acquisitions.

The Italian Kingdom is competing hard with France in the game of governmental instability, and it looks as if the *Republique Française* would soon be in danger of losing her time-honored supremacy in that respect. The latest Roman Ministry has just made interesting declarations on naval policy—a point which, it will be remembered, was totally overlooked in the *Declaration officielle* made some eight months since by the Briand Cabinet. This shows naval questions to be more popular in Italy than they are in France, and no wonder, since the peninsula has, relatively to its area, a longer seaboard than France, and, besides, has no deadly peril to fear on land since the disruption of the dual monarchy. Italy is thus more at liberty than she ever was before to devote her attention and resources to forward her maritime welfare and strength. An amusing proof of the genuine interest the people of the peninsula entertain for the sea was recently afforded by the blazing indignation that swept like wild fire over the whole land at the rumor that the "perfidious" Paris Government had graciously presented the Belgrade Court with the battleship *Vedette*. Deductions were obvious; and the announcement was, in measure, true. Paris journals, and perhaps also the Paris Admiralty, sought an excuse in the fact that the "battleship *Vedette*" belongs to the

motor launch class of *cuirassés*, only carries one or two pop-guns, and is manned by a dozen warriors.

It is not surprising that, despite the oft-repeated affirmation in Parliament as to the command of the Western Mediterranean being the *raison d'être* of the *Marine Française*, many Gallic experts should persist in opposing a purely Mediterranean policy as being a foolish and even a suicidal course to adopt for France. Under the new conditions of warfare, they point out, the Mediterranean might easily turn out to be a naval mouse-trap, where the belligerent fleets would be imprisoned, and without influence on the ocean war game that alone will count in the end. They deride the prevailing notion that safe communications between France and Algeria depend mainly on the numerical and ballistic superiority of the Gallic fleet over the Italian, and sarcastically invite *les Méditerranéens* to examine anew the strategic possibilities of their favorite sea in the light of the exploits of Boche pirates, and, also in the light of recent submarine and aerial developments. The transportation of the *Corps d'armée d'Afrique* from Algeria to France, and the successful convoys the Paris Admiralty organized from Port Saïd to Marseilles, are valueless "precedents" that find their explanation in the bottling up of the Austrian fleet in the Adriatic, but that will never be repeated in Mediterranean warfare. The limited space between Corsica, Sardinia, Sicily, and the Balearic Islands has every chance of becoming a "no-man's land" so far as large surface ships and liners are concerned. The vulnerability of Toulon to aerial attacks and the precarious situation of a fleet that would be locked up in that cramped-up arsenal are further arguments against a policy of the Mediterranean concentration.

Indeed, the problem of safe communications between France (or any other power) and her colonies is not one that can safely be dealt with on superficial make-believe lines without taking into account the possibilities of the new methods of warfare as revealed by the war; as revealed also by recent scientific discoveries. Only those who choose to shut their eyes to these *faits nouveaux* can picture a state of affairs in which convoys could safely proceed along the direct route from Provence to Algiers or to Bizerta. The Atlantic route from the many ports of the Bay of Biscay to the several harbors now being created or enlarged on the Moroccan coast might be safer for obvious reasons. There now remain the submarine and aerial routes. Gentlemen of *La Zeune Ecole* trust to underwater *invisibilité* and apparent *invulnérabilité*, and on paper have already brought to life splendid fleets of *transports sousmarins*, although systematically ignoring the developments which mining blockade and aerial patrolling will receive in the contests of to-morrow. True, the submarine *Deutschland* safely reached neutral New York, but it is forgotten she would have no chance whatever of entering that harbor had it been screened by mine-fields of the latest type. As to aerial communications, it will not be so easy to intercept them; but then, compared with surface ships, the biggest airplanes now designed are nothing but mosquitoes, and along the aerial routes there can fly to France no reinforcements and supplies of any great importance. This is the conclusion of all *chercheurs*: true value and safety reside in the large capacious armored ship rendered as insubmersible as possible.—*The Naval and Military Record*, 10 August, 1921.

NAVAL PROPAGANDA.—In view of the success of the maritime manifestations at Havre, Rouen and Dieppe there can be no doubt that popular opinion in this country is solidly in favor of creating a more powerful navy, consolidating the merchant marine, and constructing the docks and other equipments necessary for the new fleets. Those manifestations followed upon the Congress on Inland Navigation at Rouen and on conferences by the *Ligue Maritime*, which carried out all arrangements. There were races of motor boats and gliders from Paris to the sea, and very high speeds



were accomplished by the Farman and Lambert Gliders, which appear to be forerunners of a type of craft that may be extremely useful for rapid transport on shallow colonial rivers. The President of the republic visited Havre, where he was shown the works in progress under the vast program of harbor extensions, for which it is hoped to raise the necessary funds by public subscription. That, indeed, was the object of the manifestations, for it is very difficult to get money from sources that are almost exhausted, and the only hope of success lies in giving a national character to the program which will enable Havre to cope satisfactorily with the present heavy traffic. The President passed in review a squadron in which the British and American navies were represented. He then went to Rouen and saw under construction the docks that are to make the town a distributing center for the inland waterways as well as for Paris, which, as soon as the work of deepening the Seine is completed, will regard Rouen as an advance port. Finally, the President paid a visit to Dieppe, where improvements to the fishing fleet claimed his attention, and he inspected the new steamer *Versailles*, which is to be put on the Newhaven-Dieppe service, and is expected to effect the crossing in less than three hours.—*The Engineer*, 5 August, 1921.

AIR AND SEA POWER.—In democratic countries like England and France, but specially in France, the spring of progress and efficiency in any branch of war preparation is to be found in the overwhelming demand of public opinion for a national effort in those directions. This means that before any great reform can be assured acceptance and to live, the education of the people must be effected and their consent obtained. Hence, the parallel campaigns now being made in France and in England in favor of aerial expansion. English experts, looking far ahead, are fully alive to the interdependence of aerial and maritime power, whilst Gallic military and aerial authorities who since the war have been so fond of living over again the contests of the world conflict and of fighting anew the battles with the improved weapons of to-day do not entertain the least doubt about aerial supremacy being for France a life-and-death matter, since it would enable her to ensure the maintenance of peace to which she is perhaps more attached than any other nation, for tangible and visible reasons.

The misfortune is that Jean Crapaud, our man in the street, or rather in the fields, feels on his robust shoulders the ruins of the devastating war, and the burden of a huge standing army and of a costly fleet; and not unnaturally he looks askance when patriotic députés, having an eye on Germany, earnestly propose saddling him also with a third *armée de l'air* and *Budget de la Guerre aéronautique*. The financial question, indeed, cannot be ignored. Our Republic—before the war the banker of the world—has been thoroughly depleted of her gold. Her national debt exceeds 320 milliard francs, her annual budget is 55 milliard francs, and her annual deficit some 20 milliard francs! This is only one of the aspects of the profits victorious and "Imperialistic" France has derived from the war.

And yet, as France means to live at all cost, aerial expansion may be looked upon as a necessity of to-morrow, and also as a certainty, for before many months have elapsed public opinion will demand it, as may be judged from significant symptoms. Not only is the Rue Royale Admiralty preparing a definite *programme d'aéronautique* on up-to-date and comprehensive lines, but aerial questions are prominent in the press and in the lecture halls. The great aeronautical inventor and constructor Michelin, Député Fonk, Baron de la Vaulx, and several others are touring our great cities and preaching the gospel of aviation to enthusiastic crowds. Ingenieur Ader, the originator of the first flying machine, is multiplying his appeals and warnings to Président Millerand and to Premier Briand, and his lurid pictures of Paris reduced in a few days to cinders by the possible German bombardments of to-morrow nobody derides, for most

Frenchmen have had a taste of what aerial bombardment means and instinctively feel what is in store for to-morrow. Admiral Guépratte, of Dardanelles fame, though a believer in the battleship, has again and again stated his opinion that he who commands the air will command the sea also and such views are shared by our leading admirals.

Numerous are the French partisans of a *Ministère de l'Air*, equal in importance to the War and Marine Ministries; but the truth is that both the army and navy want to have their own aviators. When Colonel Fabry recently proposed in the Chamber the creation of a unique *Ministère de la Défense Nationale*, englobing the land, sea and air service, ex-Minister Landry retorted that a reform of that sort would mean the end of the French Navy, that would fall under the sway of military men unacquainted with sea matters, and at all times ready to economize at the expense of the fleet.

Experience during and since the war has shown that the aviation service cannot be worked on economical lines, though avions may be termed economical weapons considering their tremendous individual capabilities. There is the incredible wear and tear to be contended with, and rapid evolution that causes *avions de chasse et de combat* to become obsolete after a few months' service. This explains why aerial machines cannot, as in the case of ships, be constructed long in advance and be stowed away in reserve for eventual use. So, the capabilities of the industrial plant, rather than the number of units actually ready, are the true criterion to the aerial possibilities of any power. Germany, in 1918, could easily turn out 2000 fully equipped avions per month. Her plant, if anything, has improved; she is believed to be well to the fore in the designing of gigantic sea and land bombers. France, that constructed over 50,000 avions in the course of the war, produced, in 1918, 2800 avions per month, and 4000 motors; but disorganization and waste have since brought her down below the level of Great Britain and even of Italy. To restore France to her former position, to make her potentially first by the use of foresight in the organization and utilization for war purposes of the aerial assets of the country is officially the program of both the Paris Admiralty and War Office. Considering the difficulties in the way, the task is well-nigh superhuman, even with stability and competence at the head, especially as Germany, being freed from the trouble and expense of keeping huge armies and fleets, will seek consolation in a supreme "commercial" fleet of the air.

Those experts who, patiently and methodically, and in the light of war experience, have tried to ascertain the aerial needs of the navy have come to conclusions rather unpalatable to gentlemen of *la jeune école* who have all along been regarding aviation as being *l'arme économique et efficace par excellence*. Fragile and short-lived are the best aerial weapons, and their rate of military utilization is extremely low. For instance, out of the 45 *avions de combat*, picked machines and picked aviators, which were entrusted with the aerial guard of Paris, only five could be relied upon to patrol at a time, and, moreover, postwar experiments with better machines have confirmed the view that aviation is for the present an essentially fragile and unreliable weapon, viz., the British raid from England to Egypt, the French Toulon-Bizerta and Toulon-Casablanca flights, without mentioning recent fleet exercises in England as well as in France. All-round robustness and seaworthiness are wanting; designs are always satisfactory on paper; the peculiar and hard requirements of sea service are the only point constructors overlook. The remedy will readily be found once constructors are required to be also practising aviators—and that day is coming. Our *ingénieurs d'aéronautique* are to be proficient in the handling of all types of flying craft.

The numerical strength of the aerial wing of the navy may be gauged from the fact that it will be expected to protect the coasts and colonies, as well

as the fleet at sea, besides providing a group of heavy bombers for offensive operations over European seas. The *aviation côtière*, that comprised 1200 units in 1918, will be none too strong with 2000 seaplanes, as its duties will be fivefold, viz., to nip in the bud all attempts at bombardment or landing, to meet and repel aerial attacks, to hunt down submarines, to escort coastal convoys and to take an active part in fleet actions taking place in close proximity to land (which is invariably the case in all great battles). A comprehensive task will also fall to the lot of the *aviation d'escadre* that is just now being reorganized on nominal lines; viz., it will have to scout, to beat off aerial opponents, to bomb hostile ships, and also to control long-range firing—all duties that will not be performed without the assistance of many seaplane mother-ships and without some numerical superiority. Here the English policy is seen to have been far-seeing and wise. But it is in her heavy *escadres autonomes de bombardement* that the aerial power of the French Navy will find its most telling expression. As shown by the Prinz Eugen experiments, the bombs have been found that will destroy swiftly and economically any ship provided they happen to fall on a vulnerable point, and, indeed, considering the frightful details Constructor Michelin gives us of the effects of the latest aerial shells, it will be sheer folly for enemy ships to keep within range of the said French bombs that only await robust and reliable *actions de bombardement* to carry them. Up to the present the success of heavy marine *hydravions* has only been moderate in practice, though on paper great strides have been made. In the recent overland endurance test a single machine competed, the old Farman *Goliath*. Constructor Breguet, however, is making 2000-horse-power machines for over-Atlantic flight, and next year, if expectations are realized, French industry will give the navy the heavy seaplane bomber which it so badly needs, possessing radius of action and all-round robustness.

The studies and experiments which have given rise to the problem of the aerial bomb have led to the belief that aerial offence is to a great extent dependent on chemical progress. Whilst there is a limit to the weight of steel and explosive matter to be contained in aerial projectiles, there is practically none to the destructive power of chemically-loaded shells that do not need to penetrate armor, to blind, asphyxiate, poison, disarm, and kill crews in the best-protected warships.—*The Naval and Military Record*, 27 July, 1921.

#### GERMANY

WARSHIP DESIGNS.—In alluding to the "somewhat complicated system of flooding" involved by the arrangement of compartments in German capital ships, and to the well-organized method of supervision which obtained, under a special officer, whose sole duty it was to look after the trim and safety of the ship, Sir E. d'Eyncourt said there was no doubt that this resulted at Jutland in the saving of some of the very heavily damaged German ships which would otherwise not have reached port. Dr. Bürkner (formerly Chief of the Naval Construction Department at the Marine-Amt) dismisses this as a legend, and declares that "none of our capital ships, excepting *Seydlitz* and *Leipzig*, suffered during the battle even the smallest loss of fighting efficiency through the inflow of water." This statement is at variance with German reports of the battle. Dr. Bürkner will find on inquiry that the *Derfflinger*, for instance, took in 3400 tons of water through damage on or below the water-line, and it would be absurd to pretend that this great volume of water had no effect on the ship's speed or maneuvering powers, both of which are elements of "fighting efficiency."

Sir E. d'Eyncourt thinks the Germans had considerable confidence in the stability of their powder, as their anti-flash precautions were far less elaborate than those taken in British ships. On this point, Dr. Bürkner writes: "The burned child dreads the fire, and after losing three battle-

cruisers at Jutland through inadequate anti-flash protection, the British constructors had every reason to try and improve upon their former methods. It is doubtful, however, whether structural measures alone can avert the danger of magazine explosions due to shell fire, mines, or torpedoes. A great deal depends on the manufacture of the powder, its packing, and stowage, and it was in this respect that long years of experiment had given us an undoubted superiority. Nevertheless, the magazine fires in *Seydlitz* at the Dogger Bank and in *Derfflinger* at Jutland showed us that we still had something to learn."

In his comparison of various British and German types, Sir E. d'Eyncourt said that the first British battle cruisers were commenced early in 1906, and that "the German reply to these was the *Blücher*, a ship of very inferior design." Hereupon Dr. Bürkner comments as follows: "The ship was in no sense a reply to *Invincible*, for England's decision to build dreadnought cruisers was known in Germany only when work on the *Blücher* had progressed so far that her armament and leading dimensions could not be modified. *Blücher* was simply a later development of the *Scharnhorst* class, and, within the limits of the design, a very successful ship. Her armor was far more extensive and no less thick—on the belt it was actually thicker—than that of the *Invincible*, and her underwater protection was not limited to the magazine spaces, as in the British ship, but was continued in way of all vital parts. *Blücher* had also a 5.9-inch armament, which the *Invincible* lacked, and her maximum speed of 25.8 knots, practically the same as *Invincible's*, made her the fastest large reciprocating-engined vessel in the world. The real though belated reply to *Invincible* was *Von der Tann*, and the Battle of Jutland proved the 'reply' to be quite satisfactory." One must admit the unfairness of comparing the *Blücher* with the *Invincible* class. She was probably the best and most powerful armored cruiser ever built, and much superior to the *Minotaur* or the U. S. S. *Washington*. The hammering she took at the Dogger Bank before going to the bottom revealed the staunchness of her protection.

Dr. Bürkner challenges the accuracy of the German speed figures given in Sir E. d'Eyncourt's table. According to the former, the trial speed of the various German battle cruisers was as follows: *Von der Tann*, 27.4 knots; *Moltke*, 28.4; *Goeben*, 28; *Seydlitz*, 27.9. As for the British vessels, the *Invincibles*, which antedated the *Von der Tann* by two years, made 25.3 to 26.2 knots; the *Indefatigable* (contemporary with *Moltke*), 26.7; the *Lion*, *Princess Royal* and *Queen Mary* (contemporaries of *Goeben* and *Seydlitz*) made 27, 28.3, and 27.8 knots respectively. Dr. Bürkner does not tell us whence he derived these British trial figures, and it would be interesting to learn whether they are correct. The *Derfflinger*, *Lützow*, and *Hindenburg* ran their speed trials during the war, when the deep-water measured mile, off Neukrug, could not be used owing to the danger of enemy submarines. The ships had, therefore, to be tried over the shallow mile in the Belt (114.8 feet deep), at much deeper draft than usual, and using inferior coal. All these unfavorable conditions naturally affected the speed results. *Derfflinger* developed 76,600 shaft horsepower, equivalent to 28 knots in deep water, though only 25.8 knots was actually recorded; *Lützow* worked up to 81,000 shaft horsepower, which should have produced 28.3 knots, and *Hindenburg* to 96,000 shaft horsepower, corresponding to 28.5 knots, the actual speeds being 26.4 and 26.7 knots respectively. It is claimed, therefore, that the German ships were not inferior in speed to their British contemporaries, though Dr. Bürkner admits that the former were handicapped by their limited use of oil fuel, and could not maintain the maximum trial speed for long periods.

Sir E. d'Eyncourt said in his paper that German battle cruisers have been often compared with much earlier British cruisers and referred to as

contemporary, when the German ships were designed after the British, with increased protection. Dr. Bürkner replies: "The plans for *Von der Tann* were prepared between August, 1906, and June, 1907; those for the *Moltke* and *Goeben* in the period April, 1907, to September, 1908; for the *Seydlitz*, March, 1909, to January, 1910; for *Derfflinger* and *Lützow*, October, 1910, to June, 1911; for *Hindenburg*, May, 1912, to October, 1912." He is indignant at the suggestion that British battle cruisers were designed for attack because of their superior speed, caliber, and weight of bow fire, and the German ships "for defence and a retiring action," because they developed a maximum fire aft. "It has already been shown," he writes, "that the best speed of the German battle cruisers was equal to the British. The choice of thick armor was far more an expression of the will to 'dash at the enemy' than was the British adoption of thinner plating, which necessitated keeping at long range, and the same is true of our selection of smaller caliber guns, whose efficiency falls off at long range more rapidly than that of heavier calibers. It is untrue that bow fire is emphasized in the British more than the German ships. As for the disposition of the five turrets in *Moltke*, *Goeben*, and *Seydlitz*, which permits a heavier fire aft than forward, this was governed solely by technical considerations. As the authorities demanded five turrets in each ship—a larger number than was carried by the battle cruisers of any other navy—it was necessary to superpose one of the turrets aft instead of forward in order to make room for the powerful machinery and boiler installation. No one thought of designing these for 'a retiring action.' It remained for British critics to make this suggestion, but they wisely omit to add that the *Neptune* and her sister battleships which have the same turret arrangement, were also built to fight a retiring action."

Turning next to Sir E. d'Eyncourt's remarks on German battleships, Dr. Bürkner writes: "Sir Eustace maintains that we generally followed in the British wake, and that, although the protection of the British ships may have been somewhat less, the German vessels had to meet the fire of heavier guns than the British did, so that relatively the protection was approximately equal. Everyone knows that Admiral von Tirpitz was repeatedly attacked before the war for keeping to smaller caliber guns. His policy was based on the assumption that our 11-inch and 12-inch guns had as good or better penetrative powers than the British 12-inch and 13.5-inch, and that our lighter guns could discharge three rounds a minute as against the British two, so that the greater volume of fire would compensate for the smaller effect of individual hits, and the weight thus saved could be applied to protection. It is true that the grounds for this decision were somewhat shaken by the unexpectedly long range at which the actions of the war were fought, but the Jutland battle did not in any way prove the principle to be wrong. Thanks to the excellent advantage that was taken of the higher rate of fire by our well-trained gunners and fire-control officers, the superiority of our guns and projectiles was exploited to the utmost in this battle."

In the further course of his article in *Schiffbau*, on the papers read by Sir E. d'Eyncourt and Mr. Goodall at the spring meeting of the Institution of Naval Architects, Dr. Bürkner demurs to the statement that Germany, generally speaking, followed England's lead in the development of the dreadnought type. This, he declares, is true only in so far as Germany, by gradually abandoning the broadside disposition of turrets in favor of an *en echelon* arrangement, and then, finally, adopting the center-line principle, did traverse the same ground that England had covered a year or two beforehand. This, however, was due not to any waiting for an English lead, but to the military demand that each squadron of eight ships, or at least each division of four ships, should consist of vessels homogeneous in general design and armament, to facilitate tactical maneuvers and the training of personnel. As under the Navy Law only two to three battle-

ships could be laid down per annum, the evolution of turret disposition was necessarily delayed, but as early as 1907, when the *Ostfriesland* design was under consideration, plans embodying respectively a diagonal and a center-line placing of the turrets were submitted by the Construction Department. As regards machinery, the adherence to reciprocating engines in the *Ostfriesland* class was due to the fact that three sets of these engines were found to occupy less room than a turbine installation would have done, and the final decision in favor of the former was taken after a careful survey of the advantages and drawbacks of the rival systems.

In every other respect, writes Dr. Bürkner, the statement that Germany followed England's lead must be contested. It is particularly untrue as regards armor; indeed, it would be more correct to say that in this feature Germany lead the way and England followed. For instance, the *Orion*, of 1909, was less extensively armored than the *Nassau*, of 1906; and it was not until the *Iron Duke*, of 1911, that England reached the ratio of armor weight to displacement which had obtained in the *Kaiser* class designed three years earlier. "Furthermore, the British copied us by re-introducing the 6-inch armament. Where they did not follow us in the low position of the armor deck, the heavy armoring of the conning-tower tube, the provision of splinter bulkheads in the upper part of the ship, and in the isolation of the case-mate guns by splinter screens."

In claiming for Germany the rank of pioneer in the development of underwater protection, Dr. Bürkner gives some new and interesting particulars of what was done in this direction before the war. As early as 1905 experiments were initiated to determine the best method of protecting a ship's vitals against attack below water, and these were continued up to the outbreak of war. They involved the use of explosives against various models, including a huge floating target of 1700 tons. "We never heard that any other navy went in for similar experiments on a corresponding scale."

The writer refuses to accept the bulge as an epoch-making innovation. In its latest development, he says, the bulge is in principle similar to the German outer torpedo bulkhead but it gives, if anything, less protection than the latter, because in order to reduce the resistance to the water it has to be fined down very considerably at the extremities. Of the German ships equipped with the modern system of sub-surface protection only the *Blücher* was sunk by torpedo. Nine others were damaged by underwater attack, but all survived, the following particulars being given: *Westfalen*, 1 torpedo; *Ostfriesland*, 1 mine; *Grosser Kurfürst*, 1 mine, 1 torpedo; *Markgraf*, 2 mines; *Kronprinz*, 1 torpedo; *Bayern*, 1 mine; *Moltke*, 2 torpedoes; *Goeben*, 5 mines; *Seydlitz*, 1 mine and 1 torpedo. In all but three of these cases the explosion occurred within the region of the torpedo bulkhead. Incidentally the list has a significance which Dr. Bürkner omits to mention. It shows that our destroyers and submarines took full advantage of their few opportunities for attacking German capital ships, and suggests that had the High Seas fleet spent more time at sea, the capacity of its units for resisting torpedo attack would have been put to a far severer test.

Dr. Bürkner challenges Sir E. d'Eyncourt to publish a list showing what British dreadnoughts received similar damage and how they fared. This is rather disingenuous, for Dr. Bürkner cannot be ignorant of the fact that the *Marlborough* was the only British dreadnought to be torpedoed in the war. The *Audacious* was mined, but whether her sinking was due to the leak caused by the mine, or to the mysterious magazine explosion which occurred some hours later, is a puzzle never likely to be solved. Had the German U-boats and destroyers exhibited a little more enterprise and hardihood, we might have obtained a better idea of the merits of the British system of sub-division. As it is, this point remains just as obscure as the tactical efficiency of the German battleships, which in the Battle of

Jutland were hurriedly withdrawn from action at the very moment when their offensive and defensive qualities were about to be put to a real test. Dr. Bürkner is on firmer ground when he questions the statement of Sir E. d'Eyncourt and Admiral Tudor that war experience had shown the capital ship to be less vulnerable to underwater attack than had been anticipated. "Both," he remarks, "have overlooked the peril which threatens the ship's hull through the development of the gun-torpedo."

The "somewhat greater metacentric height" which Sir Eustace attributes to German capital ships was, in fact, twice as great as that which had previously been accepted as the maximum consistent with seaworthiness. The German constructors certainly showed much boldness in this respect, notwithstanding which their ships proved remarkably steady. The worst experience they had was with the *Von der Tann*, which during a Biscayan gale in 1911 rolled 17 degrees. In no case were anti-rolling tanks fitted, the ordinary bilge keels proving quite effective.

Dr. Bürkner then proceeds to discuss in considerable detail the points of difference between British and German cruiser designs, to compare the respective building periods for typical types and classes, and to correct on more or less important points what he declares to be the inaccurate data presented by the British Director of Naval Construction. Although in certain places his comments are tinged with bitterness, the article as a whole is written in an impersonal and strictly technical style, and deserves careful study as the first and most authoritative exposition of German naval construction policy that has up to now appeared. In conclusion, Dr. Bürkner writes: "The development of man-of-war construction in Germany was not conditioned solely by the skill of the naval architects, or the efficiency of the national industry. The Navy Law, which alone made possible the steady growth of the German fleet, operated in some respects as a handicap on free technical development. The financial situation of the Empire, and the continual efforts of the Treasury to keep expenditure within the limits of the Navy Law, compelled us to forego experiments, and this omission might have resulted in the building of defective ships. For reasons both of domestic and foreign policy the creator of our fleet, Grand Admiral von Tirpitz, had to avoid the appearance of setting the pace in the evolution of types; while, on the other hand, the task of keeping abreast of British technical progress was rendered most difficult by the secrecy which the British naval authorities practiced with such success. Despite these drawbacks, German naval designers and builders can look back with satisfaction on their work, which in a few decades had reached a standard of quality equal, and in some respects superior, to that of the premier shipbuilders of the world. This fact cannot be eliminated by speeches such as those delivered at the Institution of Naval Architects on March 16."—*The Naval and Military Record*, 3 August, 1921.

WON'T LET SCHEER GIVE TALK ON JUTLAND FIGHT.—Following out its policy of squelching reactionary rhetoric the government has forbidden Admiral von Scheer, the last chief of the German High Seas fleet, to deliver an address on the Battle of Jutland in Constance, local workingmen's organizations having let it be known that they were determined to break up the meeting at which the Admiral was to speak. Government bars are also up against General Lettow-Vorbeck of East African fame, who is forbidden to deliver lectures or war talks until further notice. Local authorities have prohibited a talk before the Dresden Civic Council by Major Gen. von Wrisberg on the question of "war guilt," giving as their reason that "the ensuing discussion or demonstrations might tend to bring the Constitution into contempt or glorify the foes of the republican form of government."

The government war on uniforms has brought about some embarrassing incidents. In various parts of the country enthusiastic Republicans, pre-

sumably radicals, have caught lone members of the Reichswehr in uniform and proceeded to beat them. This has forced President Ebert to promulgate yet another ordinance, this time "in deference of the Reichswehr against attacks." The President writes:

"The recent political excitement is regrettable. It has led to various cases of members of the Reichswehr being attacked on the streets without reason. Unfortunately, no difference was made between uniformed members of the Constitutional army of national defence and supposedly provocative political foes. A soldier is a citizen in uniform, representative of the Constitutional armed force. To respect him as such is a commandment of self-respect for the people."—*N. Y. Times*, 7 September, 1921.

U-BOAT CAPTAIN SEEKS TRIAL.—The *Abendpost*, of Leipsic, to-day says that Lieut. Commander Patzig, who commanded the German submarine which sank the British hospital ship *Llandoverly Castle* during the war, and who is now in South America, has declared his intention of returning to Germany and surrendering himself for trial by the Leipsic court. The newspaper says that Patzig will surrender himself because he asserts that he, and not Lieutenants Ludwig Ditmar and Johann Boldt, was alone responsible for the act.

Both Ditmar and Boldt were sentenced to four years' imprisonment.—*N. Y. Tribune*, 7 August, 1921.

SHIPBUILDING IN GERMANY.—Many conflicting accounts have appeared in the British Press as to the position of the shipbuilding industry in Germany. It has been stated that the German shipyards are in a flourishing condition, that work is assured for a number of years to come, and that large profits are being made. The amalgamation of steel-works and shipbuilding yards, resulting in lower working costs through the delivery of materials to the shipyards ready for immediate erection in standard ships, has been emphasized, and attention has been drawn to the fact that most of the German shipbuilding companies have largely increased their capital.

The position is somewhat obscure, and the Germans are refraining, so far as possible, from publishing information which may lead the Entente countries to form estimates of the ability of Germany to pay the Peace Treaty indemnities. Following the revolution in 1918, conditions in the German shipyards were chaotic. The workmen got entirely out of hand and, among other things, abolished piece-work. Activities were impeded for want of materials, and great uncertainty existed as to the destination of ships building in connection with the conditions of the Peace Treaty. The London Conference of May, 1920, however, clarified the position, when it was decided that 245,000 tons of shipping then under construction were to be delivered to the Entente, and 100,000 tons would be allowed to remain in Germany. The position as regards supplies of materials has greatly improved; and German steel-makers are able to supply the requirements of their own shipyards, and, it is shrewdly suspected, to offer large quantities of materials for export through neighboring countries. The workmen are now reported to be working well and piece-work has been re-established.

There is undoubtedly a large amount of work in hand in the German shipyards at the present moment. Ship launches are of almost daily occurrence, the vessels ranging in size from 100 up to 12,000 tons; but if it is correct that the sale of the German mercantile marine in this country has glutted the market and, together with other causes, led to an unprecedented depression in British shipbuilding, is this not the cause of the present activity in German shipyards? Owing to the present depreciated value of the mark, German shipowners can work their ships and make a profit where British shipowners accepting the same freights would sustain heavy losses. With



this advantage and the determination of the Germans to reconstruct their mercantile marine, it is not surprising that German shipyards at the moment are reported to be full of employment while British yards are closing down.

That the German Government intends to make an effort to regain the position formerly held by its mercantile marine, and to render assistance to its shipowners to that end, is evidenced by the agreement concluded between the government and the shipowners in May, by which the government agreed to pay by way of compensation to the shipowners for the loss of their ships to the Entente twelve milliards of marks. These compensation payments are for the purpose of restoring the German mercantile marine to one-third its pre-war dimensions within ten years either by purchase or new construction, but at least 90 per cent of the vessels must be built in German yards. Two-and-a-half million deadweight tons are to be built within ten years from the 10th January, 1920.

Notwithstanding these factors, the Germans are not convinced that the shipbuilding industry in their country has a lengthy period of prosperity in view. The two and a half million tons of shipping to be constructed within 10 years under the compensation agreement represents only a small proportion of the total capacity of the German yards, which, in 1917, were estimated to have a post-war capacity of 750,000 deadweight tons per annum. Since that time existing yards have been enlarged, new yards have been commenced, and the Imperial dockyards turned over to merchant shipbuilding. No reliable estimate of the present capacity of the German shipyards is available, but it cannot now be far short of one million tons deadweight per annum.

Already difficulties are arising in connection with the compensation agreement. A building program was drawn up providing for the expenditure of the twelve milliard marks, but the ships now under construction involve an expenditure of double the sum allotted for this year. As a result, large numbers of shipyard workmen have been served with notices of dismissal. The men are now agitating for the period of the subsidy to be reduced, so that work can be proceeded with.

The condition of the Peace Treaty by which 200,000 tons of shipping were to be constructed annually for five years for the Entente to replace war losses, is not likely to be enforced during present conditions, and it is hardly conceivable that during the next few years British shipyards will not be able to supply all the tonnage that is needed for British and Continental shipowners. The Germans, therefore, have given up hope of any work under this condition of the Peace Treaty.

What emerges from the many statements which have appeared concerning the prospects of German shipbuilding is that the law of supply and demand, operating in Germany as in Great Britain, will decide whether the industry in Germany has a period of prosperity in front of it. German shipbuilders can build as cheaply as, or more cheaply than, British shipbuilders, and German shipowners can operate their vessels as economically as British. German shipyards can more than fulfil the contracts which German shipowners can place within the next few years, and, when a demand for ships once more arises, they will be keen competitors of British yards for foreign contracts. At the moment, however, the future of German shipbuilding is as uncertain as that of British, both of which depend on the recuperation of the industries of the world and the purchasing powers of all nationalities.—*The Shipbuilder*, August, 1921.

**A NAVY IN THE MAKING.**—The Germans have never taken very seriously the naval clauses of the Peace Treaty. They are convinced that these will become null and void with the passage of time, and if they have not already infringed them it is merely because the clauses in question have not yet begun to hamper the development of Germany's naval plans. Treaty or no treaty, it would be impossible for her to build many new warships at

the present time, and, this being so, she is indifferent to the embargo on dreadnoughts and submarines. Her immediate aim is to create the nucleus of a new staff and personnel organization which shall be capable of almost unlimited expansion when the proper time arrives. This was made clear during the recent debate on the supplementary estimates for the Reichsmarine. It transpired that the administrative and staff services at headquarters are absorbing no fewer than 1300 officers and officials—an extraordinary percentage for a navy whose total personnel may not exceed 15,000, including a maximum of 1500 officers and warrant officers, and whose main fleet is limited to six old battleships. Another significant fact that came to light was the extraordinarily large proportion of officers who have been assigned specialist duties, such as gunnery, torpedo, and navigation. In short, the German Navy as at present constituted is looked upon simply as a training school, as the nucleus of the real navy that is to spring into existence when financial and other circumstances permit. As an earnest of her future intentions Germany has just laid down at Wilhelmshaven a 6000-ton cruiser of a type specially designed for showing the flag in distant waters.—*The Naval and Military Record*, 3 August, 1921.

**NEW METHOD OF CONCRETE SHIP CONSTRUCTION.**—A new system of concrete shipbuilding developed in Germany in recent years dispenses almost entirely with wooden moulds. The ships are now built in a floating concrete dock whose walls correspond accurately to the shape of the hull to be constructed and provide the outer mould. Up to the present time, the system has been used only for the construction of river and canal barges. Wooden moulds are still used for the ends of the barge, being fitted on to each end of the dock, but no inner mould is required for any part of the vessel.

The concrete, which is a special mixture having a consistency sufficient to make it adhere even to vertical walls, is sprayed against the mould by means of compressed air. The effect of the spraying process is to press the concrete firmly against the mould, making it hard, strong and waterproof, and giving it an unusually smooth outer surface. By this method, walls can be built to the minimum thickness required, whereas by the old method of casting the concrete between moulds the walls usually were made thicker than was necessary for strength. The spraying system is also used for the construction of bulkheads and other interior walls.

The following advantages are claimed for the new method:

1. Simplicity, which makes possible an increase in the speed of construction. A river barge of average size, ranging from 800 to 1000 tons, can be built in six weeks.
2. Saving of wood otherwise required for moulds.
3. Saving of concrete, as the walls can be built to the minimum thickness.
4. Reduction in the weight of ships to a point only slightly greater than that of iron ships; concrete barges have about 90 per cent of the dead-weight carrying capacity of iron barges of the same dimensions.
5. Lower cost of production. The concrete barges are from 20 to 30 per cent cheaper than iron barges.
6. Less power required for towing barges of this type, owing to the fact that the smooth outer surface minimizes resistance and prevents fouling.
7. The existence of a substantial and permanent floating mould and the elimination of launchings.—*The Nautical Gazette*, 13 August, 1921.

#### GREAT BRITAIN

**NEW NAVAL CONSTRUCTION.**—In the House of Commons, last week, the shipbuilding votes of the Navy Estimates were agreed to, after a singularly interesting debate. Among the credits passed were those for laying down four capital ships to replace eight vessels which are becoming obsolete.

The necessity of building these ships was made clear by Mr. Amery, Financial Secretary to the Admiralty in his introductory statement. The Battle of Jutland, he explained, established a new and much higher standard of efficiency for the capital ship than had previously obtained, and other powers had not been slow to take advantage of the technical lessons taught by that engagement. Japan and the United States are both at work on whole squadrons of new ships, individually superior in fighting power to the finest vessels of the British fleet, with the possible and solitary exception of the *Hood*. In contrast with this marked activity abroad, heavy naval construction has been entirely in abeyance here for five years, with the inevitable result that our relative position at sea is steadily declining. Thanks to the exertions we made before and during the war, and no less to the fact that circumstances have delayed the carrying out of the American program, our battle fleet momentarily retains its premier position; but its margin of superiority is shrinking so fast that it will have disappeared in a year or two, and from then onward the balance of capital ship strength will be against us. As that is a contingency which the naval advisers to the government could not view with indifference, they felt it incumbent on them to urge the laying down of a minimum number of new ships, notwithstanding the grave financial sacrifice involved by that policy. The program is certainly not excessive; it is doubtful, indeed, whether it can be considered adequate. If there were any prospect of our becoming embroiled with a great naval power, the vote for new construction would be demonstrably inadequate. But since, happily, there are no serious clouds on the political horizon, the Admiralty has done well, perhaps, to limit its demand this year to four ships only. Twelve months hence the whole position will have to be reconsidered; but by that time the Washington Conference will have been held, and whether its issue be favorable or otherwise we shall be able to see ahead more clearly than is possible to-day.

In deciding to adhere to the capital ship as the principal unit of naval strength, the Sea Lords of the Admiralty have taken the only course that was open to them as trustees of the national safety. Those upon whom devolves the responsibility of defending a great empire cannot be blamed for hesitating to throw away well-ried weapons, antiquated as they may appear to some, until an effective substitute has been found. In ten or twenty years' time the capital ship as we know her now may be as obsolete as the three-decker. But it is the business of the Admiralty to provide for national and imperial defence by sea at any given moment, not merely at some remote period. That is a point too often overlooked by enthusiastic theorists in the realm of naval strategy. We may be—probably are—on the eve of revolutionary changes in methods of conducting warfare afloat, but few who have carefully followed the "great ship or —" controversy which has been waged since the Armistice will have the hardihood to assert that an absolutely convincing case has been made out on either side. On the whole, the balance of professional opinion has inclined toward the perpetuation of the capital ship, not because its limitations are unrecognized, but because it has so far held its own against all other claimants for supremacy. All who have paid the least attention to the subject are well aware of the possibilities that lie before submarines and aircraft. But whatever they may do in the future, the fact remains that they are not yet competent to replace the surface ship. As Viscount Curzon has opportunely reminded us, the Grand fleet was not prevented from going to sea on one single occasion by the operations of enemy submarines. That being so, who can confidently affirm that the existence of many British submarines and aircraft, unsupported by heavy surface ships, would deter a hostile battle fleet from putting to sea to attack our coasts or ravage our trade?

It is to be regretted that the Admiralty is not yet able to publish particulars of the four new ships, though there are no doubt sound reasons for its reticence in this respect. Still, on reading between the lines of Mr.

Amery's statement, it is possible to gain a rough idea of their essential features. Although described officially as "improved *Hoods*," it does not follow that they will be improvements on the arch-type in all respects. They are, as we know, to mount a heavier armament—16-inch as against 15-inch and as it is no longer a secret that the triple mounting is contemplated for these ships, they are evidently to be equipped with ten or twelve heavy guns apiece. The triple mounting, in addition to its tactical significance, has the advantage of economising weight, but however great the saving in that direction, it would not be such as to enable the designer to produce a vessel as fast and as well protected as the *Hood*, but carrying at least two additional big guns, on the same dimensions as that ship. This point deserves to be emphasized in view of Mr. Amery's remark that the dimensions of the new battle-cruisers "will be such as to keep within limits which will obviate the necessity of any larger docking or other accommodation being provided for them other than that already existing."

The *Hood*, it is well known, cannot be docked at Portsmouth or Devonport, and when in need of attention below the waterline, has to go to Rosyth, where the graving docks are just large enough to accommodate her. Now, it is clear enough that any ship designed to outclass the *Hood* alike in armament, protection and speed would have to be given increased dimensions. We conclude, therefore, that the *Hood's* successors will be inferior to her in some feature or other; and since the Admiralty's representative specifically refers to "improvements in the matter of protection and armament," the inference is that some sacrifice of speed has been accepted. Assuming this to be correct, it remains to be seen whether the official decision will be approved by students of naval warfare. Hitherto it has been a fundamental principle of British naval policy to design ships that are at least equal, if not superior, to foreign contemporaries, and any departure from this rule is certain to evoke criticism. It is not invidious to point out that whereas the *Hood* herself has a sea speed of approximately 31 knots, Japanese and American battle-cruisers now on the stocks are designed for 33 knots, if not more. It would, therefore be somewhat difficult to justify a lower speed in British battle-cruisers of still later design unless there are good grounds for the assumption that the tactical and strategic value of high speed in capital ships has been depreciated by war experience. In noting Mr. Amery's assurance that the new ships have been designed with an eye to existing dock accommodation we are unpleasantly reminded of one of the gravest indictments preferred by Lord Jellicoe with regard to our pre-war battleships. After emphasizing—in his book, "The Grand Fleet, 1914-16"—the disadvantage from which those vessels suffered owing to their narrow beam, which made them peculiarly vulnerable to underwater attack, he goes on to explain that "as each successive type of dreadnought was designed, our constructive staff were faced with the fact that if they went beyond a certain beam the number of docks available would be insufficient. . . . It was one of the reasons which led to the German ships being much better equipped to withstand underwater attack than were our own." And, he concludes, "it is devoutly to be hoped that this lesson will be borne in mind in the future, and adequate dock accommodation provided for the fleet." We venture to echo this hope, without feeling too confident that it will be realized. In times of financial stringency there is always a temptation to adopt compromises, even when they involve risk. If the Admiralty were told that it could have money either for new ships or for new docks, but not for both, it would, in present circumstances, almost certainly elect for ships. But, in view of Lord Jellicoe's revelations, some official assurance that the all-round efficiency of our new battle-cruisers is not to be jeopardized by considerations of false economy would be welcomed.—*The Engineer*, 12 August, 1921.

OUR NEW BATTLESHIPS.—Now that we are definitely committed to a program of naval construction which includes four capital ships, interest naturally centers upon the design of these new vessels. Are we to be asked to build super battle-cruisers of an improved *Hood* type, costing anything up to £8,000,000 to complete and more than half a million a year to maintain in commission? If not, what is the alternative?

Cost is the dominant factor to-day in governing our naval establishments. The country can only afford—and will only consent to pay—a certain amount for naval defence. Whitehall must do the best it can with the means at its disposal. It is to be hoped that, with the object of being *sure* of getting the best possible value for money expended, the government has taken to heart the advice given by Viscount Jellicoe in "The Crisis of the Naval War."

"Governments," wrote the gallant Admiral, "are, of course, bound to be responsible for the policy of the country, and policy governs defence, but, both in peace and in war, I think it will be agreed that the work of governments in naval affairs should end at policy, and that the remainder should be left to the expert. That is the basis of real economy in association with efficiency, and victory in war goes to the nation which, under stress and strain, develops the highest efficiency in action."

The *Hood* was the direct result of the more or less general capitulation of expert opinion to the speed fetish in the years immediately preceding the war. Until very recently most naval officers inclined to the opinion that an advantage of a few knots over an enemy was a sort of universal antidote to all the evils of warfare at sea. The earliest actions of the war—if we except the Falklands Battle, which was quite exceptional—tended to disprove this. Speed certainly is an advantage, but not when other essentials have to be sacrificed in order to obtain it.

This was realized by the Admiralty after the Jutland Battle and the plans of the *Hood* class, approved some two months previously, were modified accordingly. In order to give additional armor protection, the necessity for which was realized after the appalling losses sustained by our battle-cruisers, a reduction was made in the speed of the new ships. Yet the full lessons, not only of that fight but of the war as a whole, are only now being absorbed. It is obvious that our great battle-cruiser does not, in any way, represent the ideal capital ship. In fact we have already had it officially that if the Admiralty were preparing designs for a new ship they "would not design a *Hood*."

The *Royal Oak* class of battleship has the same main armament as the *Hood*, a more powerful secondary battery and much more efficient armor protection, yet is little more than half her size. Would it be to our advantage to have five improved *Royal Oaks* or three improved *Hoods*? Naval opinion has changed since it has had an opportunity to assimilate the facts revealed by the war. The sacrifice of speed in order to obtain greater smashing power and ability to receive greater punishment is now considered desirable on all hands.

It can be safely assumed that our four new capital ships will be real battleships and not battle-cruisers. They will embody the many lessons of the Great War. Increased gun power, increased armor and adequate protection against torpedoes and mines will all feature in their design. But they will probably be both smaller and slower than the "ideal" capital ship. If equal importance be attached to offensive, defensive and tactical qualities, the result, at the present time, would be a ship which the most wealthy power could not possibly afford in any numbers.

It is improbable that our new ships will exceed 30,000 tons displacement (nominal). On such a tonnage, in order to attain the speed of a battle-cruiser, it would be impossible to carry a sufficient armament and adequate protection. But if the speed be limited to about 23 knots, an extra turret

may be included in the design, mounting two (or more) 15-inch guns than the *Hood* and *Royal Oak* and bringing the total number of these heavy weapons up to ten, whilst enhanced protection may be provided. By the adoption of the triple gun turret, which, despite its several drawbacks, saves much weight and has given satisfaction in the Italian and American navies, it would be possible to mount even twelve heavy guns. That the caliber of the guns themselves will be increased is unlikely. We tried an 18-inch gun during the war and discarded it. Our 15-inch is the most powerful weapon in existence and much superior to the American 16-inch.

We can, then, reasonably forecast that our new battleships will be of about 30,000 tons, steaming at something like 23 knots and carrying either twelve 15-inch guns in four triple turrets or ten 15-inch in five twin turrets. They will have a powerful secondary armament, probably of 5.5-inch caliber, and battery of 4-inch anti-aircraft guns. Their armor protection will be very complete and of some 15 inches thickness on sides and big gun positions. They will probably have "bulges" to protect them from underwater attack, in addition to elaborate internal subdivision.

And—in another ten years they will be obsolete!—*The Army and Navy Gazette*, 30 July, 1921.

**THE CANADIAN NAVY.**—The statement that a training establishment for boys for the Royal Canadian Navy is to be established at Halifax on September 1st next is chiefly interesting by virtue of its symptomatic purport. Before the war Canada displayed an almost apathetic attitude towards the subject of naval defence. During the war she sent and maintained a magnificent army corps, but the service of her sons at sea, fine as it was, bore no sort of relative numerical proportion to her co-operation in the field. Now a change of spirit appears to be growing up in the Dominion.

There can be little doubt, we believe, that the unmistakable increase in national interest in naval problems in Canada is largely the result of the sea policy of the United States. We do not suggest that this is regarded with any sentiments of rivalry or distrust. But owing to the influence of contiguity it has brought home the meaning of naval defence to the people of Canada with a clearer perception than any material developments or academic discussions taking place thousands of miles away from their shores. The ships of the Canadian Navy have recently returned from a very extended cruise along the Pacific seaboard. Recruiting and volunteering for the Naval Reserve is said to be brisker to-day than during any peace period of Canadian history, which is good for that principle of imperial co-operation upon which our future naval policy must unquestionably be based.—*The Naval and Military Record*, 10 August, 1921.

**SUBMARINE MONITORS.**—It was a coincidence that the announcement that all the remaining monitors in the navy are to be sold was made about the same time that it was decided to utilize what have been hitherto called "submarine monitors" in the first flotilla of the Atlantic fleet. Yet the *M-3*, which has now been placed in commission for this purpose, bears a very different relation to other submarines than the monitors do to other warships of the regular types. The dimensions of the *M-3* are given officially as 303 feet long by 24½ feet broad, with a mean load draft of 15¾ feet. She is thus much smaller than the steam-driven vessels of the *K* type, but leaving out of account this exceptional class, the *M* type shows a consistent advance over all others in regard to size. Instead, however, of utilizing this extra weight for more speed or radius of action, the designers have put it into offensive power. One 12-inch gun and one 3-inch anti-aircraft gun are carried, as compared with two 4-inch or 3-inch guns in earlier types. Needless to say, this very considerable advance in gun-power places the *M* class well ahead of all others in any navy. But as

showing that the term "submarine monitor" is hardly appropriate, it may be pointed out that *M-3* has a surface speed of 16 knots, as compared with  $17\frac{1}{2}$  knots in the *L* type, and  $9\frac{1}{2}$  knots when submerged, as compared with  $10\frac{1}{2}$  knots. There is nothing like the big difference which obtained between the surface monitors and contemporary battleships, the former having speeds only half as fast as the latter.—*The Army and Navy Gazette*, 6 August, 1921.

**BRITISH FLEET EXPANSION.**—It is reported from London that the four battle-cruisers to be added to the British fleet will be armed with main batteries of ten or twelve 16-inch guns and will have a speed of 28 to 30 knots. Thus they would have an advantage of at least two guns over the six *Lexingtons* now under construction in this country. But the British cruisers will not be so fast by from three to five knots. They are to be heavily armored on deck and sides and further protected by torpedo-proof bulges; also stanchly compartmented to keep afloat under both shell and torpedo attack. The British ships are planned to be the most formidable of their type when they go into commission in 1924, at which time our six *Lexingtons* should be flying the American flag. On May 1 the *Saratoga* of this class was 22.4 per cent built and the *Lexington* 18.7 per cent. The most backward was the *Ranger*, 1.8 per cent.

It is not likely that the British cruisers will carry as many as twelve 16-inch guns, because the extra weight added to the heavy armor plate would compel a reduction of speed to less than 30 knots. Assuming 10 to be the number of guns decided on, these new cruisers would be inferior as fleet units to the American battleships of the *Indiana* class, which will have a displacement of 43,200 tons and be armed with main batteries of twelve 16-inch guns. This American class will probably be seven knots slower than the British battle-cruisers, but with extraordinary armor protection the Americans should be able to withstand tremendous shell and torpedo attack. It should be noted, however, that the latest British shell for 16-inch guns has greater penetrating power than the American shell, according to reports of a test made upon the hull of the former German dreadnought *Baden*.

The decision of the British Government to expand its fleet, somewhat stronger at the present time than the American fleet, signifies a purpose to keep abreast of the United States in sea power if limitation of armaments is not agreed upon at the Washington conference. In the debate in the House of Commons upon navy estimates in March, every speaker who urged the Government not to let the British Navy sink to second place was loudly cheered. The most popular sailor in the empire is Earl Beatty, not only because he fought in the Nelson style at Jutland, but because he stands for a navy as strong as any other. It has been said that "the British people will never consent to be ousted from the element which instinct, no less than history, teaches them to be the true source of their national safety and prosperity."

As sure as the sun sets on a disarmament conference that has not bound the nations to cease competition in the building of warships, Great Britain, the United States and Japan will go on spending the major part of the money they raise by taxation in preparations for war. The end of the rivalry would be financial collapse for more than one of them, perhaps for all three. But it is an expectation not unduly optimistic that the conference will be able to agree upon Pacific policies. In that case the problem of limiting armaments could be solved without difficulty.—*N. Y. Times*, 24 August, 1921.

## JAPAN

**JAPAN SCRAPPING OLD SHIPS.**—Pursuant to the decision taken at the Japanese Navy Department conference in May, Admiral Kato, the Minister of Marine, has now drawn up a program of economy which, it is hoped, will result in a considerable saving of expenditure without interfering with the carrying out of the "eight-eight" program. Within the next two years it is proposed to scrap four battleships, aggregating some 57,000 tons, two first and three second-class cruisers totalling 30,200 tons, and a number of coast-defense ships, destroyers, torpedo-boats, and auxiliaries. The old vessels marked down for the scrap-heap are the battleships *Shikishima*, the *Asahi*, the *Hizen*, and the *Mikasa*; and the cruisers *Asama*, *Tokiwa*, *Suma*, *Akashi*, and *Chitose*. Furthermore, the *Ikoma*, the *Ibuki*, and the *Kurama*, officially designated "battle-cruisers," are to be disrated to first-class cruisers; and the old armored cruisers *Yakumo*, *Adzuma*, *Idzumo*, and *Iwate*, together with the obsolete light cruisers *Niitaka* and *Tsushima*, will be placed in the category of "coast defence ships." The proposed measures of economy are much less drastic than had been anticipated, and even when they have been carried into effect the Japanese Navy will contain many vessels so limited in fighting value that their upkeep would not be considered worth while in the British service.

The mystery of the *Nagato's* wonderful foremast has now been solved. It is a heptapod, the trunk being supported by six powerful struts, carrying a series of searchlights, range-finder platforms, and director towers. The trunk of the mast is of such generous diameter that it contains an electrically-operated lift, running from the upper deck to the masthead, where the main armament director tower is situated. The mast was designed after many experiments had been made to determine the best form of structure for securing rigidity and reducing vibration to the minimum. It is said, and certainly looks, to be indestructible by shellfire, but the weight involved must be enormous.

Unofficial details of the new aircraft-carrier *Hosho*, building under the 1919 estimates, show her to be a vessel of some 9000 tons, with a speed of 21 knots. Her machinery will consist of geared turbines and oil-fired boilers, the smoke being expelled through horizontal ducts as in H. M. S. *Argus*, leaving the flying deck clear of obstructions. She is to have the largest possible accommodation for aeroplanes, accessories, etc., and will be fitted with the latest devices for facilitating the landing and recovery of aircraft. An armament of four 4.7-inch Q. F. and two A. A. guns will be mounted.

It is understood that practically all the armor-plate, amounting to about 7000 tons, which the Japanese Navy Department ordered from a Sheffield firm two years ago, has now been delivered. It is special curved armor for conning-tower and barrette protection. Hopes are cherished at Sheffield that further orders will be forthcoming from the same quarter, but in the meantime Japan is doing what she can to enlarge her own facilities for the manufacture of this material, and is buying machinery for the purpose. A 16,000-ton armor-plate bending press is said to have been acquired from a British firm for erection in the shops at Kure dockyard. As regards raw material, it is interesting to learn that Japan is making large purchases of the Swedish magnetic ore which found its way to the Krupp works at Essen in such quantities during the war. But with the big program of armored ship construction well under way, Japan will find it difficult to meet the heavy demand for armor from her own resources, especially as



the Muroran works—which have hitherto cooperated with the state factory at Kure in supplying this material—are finding it difficult to fulfill Admiralty orders owing to the narrow margin of profit thereon. The directors of the Muroran firm have been in negotiation with the Navy Department on this subject for many months past, but apparently without reaching an agreement. There is consequently some likelihood of British manufacturers coming in for a further share of business in connection with the “eight-eight” program. The Japanese papers state that two light cruisers of this program were to have been ordered in Great Britain last spring, but that the decision was revoked when it was found that the British firms demanded £20 per ton in excess of the highest Japanese tender for the work.—*The Naval and Military Record*, 10 August, 1921.

**JAPANESE SUBMARINES.**—Comment has been caused in naval engineering circles by the report that the Japanese Government has placed an order with Sulzer Bros. for Diesel engines to the value of £1,250,000, which are to be installed in the new super-submarines. Only bare details are available, but they indicate that the engines are to be of 4000 horsepower, and that it is intended to equip each of the new submarines with engines aggregating from 16,000 to 20,000 horsepower. A similar order, but for engines of a lower horsepower, has been placed with the same firm by the United States Government.—*The Engineer*, 12 August, 1921.

**METRIC SYSTEM IN JAPAN.**—The Board of Trade state they have now obtained a translation of the recent Japanese Law (number 71 of 1921), the object of which is the ultimate substitution of the metric system of weights and measures for the present Japanese system.

Among the provisions of the new law are:

*Article 1.*—The unit of measurement shall be the meter and the unit of weight the kilogram [these are substituted for the “shaku” and the “kwan”].

*Article 2.*—The meter shall be determined by the standard meter delivered to the Imperial Government in accordance with the Metric Treaty, and the Kilogram by the standard kilogram delivered to the Imperial Government according to the Metric Treaty.

*Article 5, Clause 2.*—This provides that weights and measures or standards of measurement not in accordance with the new law, or with Imperial Ordinances based on that law, may not be used in business transactions or for purposes of certification unless otherwise determined by Imperial Ordinances.

*Articles 6 to 14.*—In the old law these imposed certain restrictions on the manufacture and sale of weighing and measuring appliances, provided for the official inspection of such appliances, and set up regulations regarding the sale of goods marked with their net weight. In the new law these are all retained.

*Penalties.*—Among the penalty sections of the law, it is provided by Article 15 that persons infringing Clause 2 of Article 5 above are liable to a fine not exceeding 100 yen or a police fine.

*Supplementary Articles.*—The date of enforcement of this law shall be determined by Imperial Ordinance.

The weights and measures in common use hitherto may continue in use for such period as will be determined by Imperial Ordinance.

A copy of the law may be inspected at the Department of Overseas Trade (Development and Intelligence), 35, Old Queen-street, London, S. W. 1.—*Engineering*, 29 July, 1921.

UNITED STATES

NAVY DEPARTMENT—BUREAU OF CONSTRUCTION AND REPAIR

VESSELS UNDER CONSTRUCTION, UNITED STATES NAVY—DEGREE OF COMPLETION,  
AS REPORTED AUGUST 31, 1921

Type, number and name	Contractor	Per cent of completion			
		Sept. 1, 1921		Aug. 1, 1921	
		Total	On ship	Total	On ship
<b>Battleships (BB)</b>					
44 California	Mare Island Navy Yard..Com	m. 8-	10-21	99.	99.
45 Colorado	New York S. B. Cpn.....	78.4	76.8	77.1	75.2
47 Washington	New York S. B. Cpn.....	69.3	63.	68.3	62.4
48 West Virginia	Newport News S. B. & D. D. Co.	61.	53.4	59.3	51.3
49 South Dakota	New York Navy Yard.....	34.1	26.5	32.8	26.5
50 Indiana	New York Navy Yard.....	31.2	24.	31.2	24.
51 Montana	Mare Island Navy Yard.....	27.3	19.	26.6	18.8
52 North Carolina	Norfolk Navy Yard.....	36.5	27.1	36.1	27.1
53 Iowa	Newport News S. B. & D. D. Co.	29.	24.8	28.3	24.7
54 Massachusetts	Beth. S. B. Cpn. (Fore River)..	10.4	3.9	10.4	3.9
<b>Battle Cruisers (CC)</b>					
1 Lexington	Beth. S. B. Cpn. (Fore River)..	24.2	15.	23.1	13.8
2 Constellation	Newport News S. B. & D. D. Co.	13.3	11.1	12.5	10.3
3 Saratoga	New York S. B. Cpn.....	27.4	18.7	25.6	16.9
4 Ranger	Newport News S. B. & D. D. Co.	2.5	1.	2.2	.9
5 Constitution	Philadelphia Navy Yard.....	10.7	6.	10.4	5.9
6 United States	Philadelphia Navy Yard.....	10.4	5.7	10.2	5.7
<b>Scout Cruisers (Light Cruisers CL)</b>					
4 Omaha	Todd D. D. & Const. Cpn.....	94.6	87.2	93.9	85.7
5 Milwaukee	Todd D. D. & Const. Cpn.....	92.4	84.	91.3	83.
6 Cincinnati	Todd D. D. & Const. Cpn.....	87.1	79.5	86.2	78.8
7 Raleigh	Beth. S. B. Cpn. (Fore River)..	63.7	45.6	63.2	45.6
8 Detroit	Beth. S. B. Cpn. (Fore River)..	66.3	48.2	63.7	46.1
9 Richmond	Wm. Cramp & Sons Co.....	70.	59.	69.	51.
10 Concord	Wm. Cramp & Sons Co.....	66.	49.	65.	45.
11 Trenton	Wm. Cramp & Sons Co.....	50.	34.	50.	32.
12 Marblehead	Wm. Cramp & Sons Co.....	46.	30.	46.	28.
13 Memphis	Wm. Cramp & Sons Co.....	40.	25.	40.	25.
<b>Auxiliaries</b>					
Fuel Ship No. 18, Pecos	Boston Navy Yard (Oiler AO 6)	Com	m.	99.	99.
Repair Ship No. 1, Medusa (AR 1)	Puget Sound Navy Yard.....	68.	51.2	66.	50.3
Dest. Tender No. 3, Dobbin (AD 3)	Philadelphia Navy Yard.....	66.3	66.	66.3	66.
Dest. Tender No. 3, Whitney (AD 4)	Boston Navy Yard.....	32.8	28.1	30.6	24.5
Sub. Tender No. 3, Holland (AS 3)	Puget Sound Navy Yard.....	21.6	5.5	21.5	5.5
Aircraft Tender, Wright (AZ 1)	Tietjen & Lang.....	90.	....	87.	....
<b>Patrol Vessels</b>					
Gunboat No. 22, Tulsa (PG 22)	Charleston Navy Yard.....	70.6	53.4	70.3	52.1

In addition to the above there are under construction 4 destroyers, 4 fleet submarines, and 37 submarines.

Authorized but not under construction or contract 12 destroyers, 7 submarines and one transport.

**"CALIFORNIA" IN COMMISSION.**—The battleship *California* was placed in commission at the Mare Island Navy Yard yesterday in the presence of a large gathering of naval officials and visitors.

The keel of the ship, which is the first dreadnought to be turned out by this navy yard, was laid October 25, 1916. All work on the *California* was suspended during the war to give precedence to the building of destroyers. She was launched November 20, 1919. The *California* carries 1400 enlisted men, all California men.—*The N. Y. Times*, 12 August, 1921.

**SUBMARINE "S-51" LAUNCHED.**—The *S-51*, last of the submarines now under contract for the United States Navy to be built here, was launched from the ways of the Lake Torpedo Boat Company to-day.—*The N. Y. Times*, 21 August, 1921.

**WORK ON BATTLESHIPS CUT.**—Curtailement of naval building due to decreased appropriations will materially slow up work on new battleships and battle-cruisers, it was said to-day at the Navy Department. There is \$53,000,000 available for the work, against \$115,000,000 requested, and it has been apportioned about evenly between purchase of materials and building charges after conference with builders and materials contractors.

A partial suspension of work at plants fabricating material for the ships already had taken place, it was said. Officials did not estimate when the vessels could be completed at the present rate.—*The N. Y. Times*, 17 August, 1921.

**NAVAL PROGRAMS.**—The American people have about \$40,000,000 invested in the new battleship *Washington*, just launched at Camden. This investment was made to protect the lives and property of the people who furnish the money to pay battleship bills. It could not be spent to better purpose if other nations continue to build big battleships. But it could be better spent in the ways of peace under an international agreement for disarmament.

Great Britain, Japan and the United States have the greatest naval programs planned at the present. The British navy's fighting ships are counted at 1,588,442 tons, those of the United States at 779,173 tons and of Japan at 340,596 tons. The United States has new ships planned that will total 842,109 tons, Japan 328,460 tons and Great Britain 76,890 tons. If these programs are carried out, Great Britain will have 1,665,332 tons, the United States 1,621,282 tons and Japan 669,056 tons. Thus the strength of the American Navy will be almost as great as that of the British Navy, ship for ship and ton for ton.

According to current history, France is maintaining 800,000 soldiers under arms, Japan 600,000, Great Britain 300,000, Italy 300,000 and the United States 150,000. Thus it will be seen that this country has put the army on a peace-time footing, but its naval program is ambitious. There is considerable doubt about the disarmament conference being able to curtail the programs and the effect of such an agreement as the diplomats reach may not be felt by the people for some time, but if it means less spent for war preparation something will have been accomplished.—*The Indianapolis News*.

**SECRECY SHROUDS FLEET PRACTICE.**—Beginning September 6, the American fleet in the Pacific will begin its fall maneuvers under a complete veil of secrecy. Never since the war has so much obscurity been thrown about fleet movements as will govern this practice routine. No reason is assigned for the new order of fleet practice, although the reason for it is assumed to lie in the necessity of trying out new units of the fleet under novel conditions.

The fighting strength of the navy is acknowledgedly now in the Pacific. The fleet has the latest equipment in aircraft, in radio systems, range finders, and will specifically seek to find a proper balance between the

different units, such as the battleship, the submarine of wide cruising area, the aircraft subsidiaries and other features of a thoroughly equipped fleet.

The bombing experiments which were tried on the Atlantic coast this summer will be tried out under other conditions in the practice maneuvers in the Pacific. It is earnestly desired to know just what relations the aircraft and the battleships are to bear to each other in the future.

The maneuvers will include various strategic enterprises carried out under the stimulation of war conditions.—*The Washington Post*, 6 September, 1921.

**LIMITATION IS NOT DISARMAMENT.**—President Harding in his speech at the War College said that the time may never come, or the time will never come, when the United States can do without an army. That was a natural enough statement to make on such an occasion, but the significance went beyond the occasion, and no doubt the President intended that it should.

The Washington conference of nations interested in the limitation of armament and the adjustment of Pacific controversies is being misconceived widely in the United States as to purpose. Part of this may be deliberate and political. Some may be sentimental and pacifist, and in it all there is a large element of carelessness. To speak of the "disarmament conference" is to use a term which does not fit the purpose of the conference at all.

It may fit the purpose of politics, Wilsonian Democrats and the league of nations advocates may endeavor to create a false impression in advance by using this term. The purpose is not disarmament. Consequently the result obtained, even if it is the best hoped for, will not be disarmament. Politics by misrepresenting the purpose in advance may afterward assert that the result was failure. President Harding probably is aware that the purpose is being misrepresented.

It is not expected that the United States, Great Britain or Japan will put effective battleships out of commission. It is not expected that as the result of the conference there will be a reduction in armies. Great Britain and the United States have their armies down to the bone already, and Japan, France, Italy, etc., will continue to be guided by what they regard their peculiar national needs.

If armies and navies were reduced, the process might be called disarmament, even if all arms were not thrown away, but the purpose of the Washington conference is not that. It is broadly to reach an agreement which will stop dangerous, competitive military preparations.

Particularly it is to reach an agreement which will stop the rivalry in the building of battleships.—*The Chicago Tribune*.

**AIR MENACE TO THE NAVY.**—In all the discussions in connection with the recent bombing tests against the German ships, attention has been given almost exclusively to arguments as to whether or not the modern battleship is doomed in a contest with air forces.

It is natural, perhaps, that this point should monopolize thought. Nevertheless it is important to note that the battleship is menaced not only by direct attack from air forces, but that its existence is, perhaps, threatened more seriously by the probability that its protecting screen of light cruisers and destroyers, as well as its supply and fuel ships, may be bombed, gassed, torpedoed or mined off the sea! In such a case what can the battle fleet do? Even if the air forces of the enemy leave it untouched, is it not powerless when it loses control of the air and thereby finds itself robbed of all scouts, all protection against submarine attack, all supplies and fuel? Under such conditions will somebody answer the important question—what can a battle fleet do and where can it go?

One of the most important auxiliary forces of the battle fleet is the destroyer flotilla, whose function it is to protect the battleship against submarine attack, to threaten the enemy with torpedoes, to embarrass him with smoke screens, and to do scouting duty in company with cruisers of all kinds. These are important defensive and offensive functions. Has the advent of air forces imperiled the existence of the destroyer? Can it be counted on to accomplish in the future the mission that has been assigned to it in the past? If so, it must prove its ability to defy and fight off attack from the air. Can it do this? Is it reasonable to expect such a thing?

Consider for a moment the weakness of the destroyer against air attack. Its upper deck is thin, and so also is its side and bottom plating. A 100-pound bomb will penetrate its deck, and the same bomb exploding in the water near by will unquestionably open its seams and send it to the bottom or put it out of action in a few minutes. This was proved by the recent experiments.

The upper deck of a destroyer is encumbered with many depth charges and torpedoes containing high explosives that may be detonated by an explosion near by. Nearly half the length of the ship is given to engines and boilers quite unprotected by armor, and very vulnerable to bombing. Even the magazine is at the mercy of attack from above.

For use against air attack the destroyer has two anti-aircraft guns. A casual inspection will show that these guns have a very limited field of fire—smokestacks, masts, superstructures and bridges interfere with them. The destroyer rolls and pitches violently in a seaway. Under such conditions the gunners cannot shoot with accuracy. The airmen do not fear these guns. In the recent gun attack by destroyers on a German target the commanding officer signaled that the motion of his ship in a smooth sea at a speed of 30 knots made it impossible for him to hit the target. If this motion interfered with the accuracy of his 5-inch guns it would still more embarrass his anti-aircraft guns. And yet it is admitted that high speed is necessary to escape air attack. It is not too much to say, therefore, that the structural weakness of the destroyer and its inability to successfully fight the airplane have sounded its doom. It is absurd to say that the bomber cannot hit a fast zig-zagging ship. The air man will come down so close that he cannot miss. He may not sink the destroyer, but he will at least put it out of action. Air forces will dominate in battle with destroyers.

If we admit the vulnerability of the destroyer to air attack, what manner of ship must replace it in the duty of protecting the battleship and in the use of torpedoes, small guns and depth charges, or mines—for these are the weapons that are carried by the destroyer?

It would appear that the destroyer must be converted into a submarine—in other words, it must dive to escape the air man. The submarine uses the identical weapons carried by the destroyer—small guns, mines and torpedoes. To be sure a German submarine was recently destroyed by bombs. But it must be remembered that she was lying helpless on the surface. No submarine or submersible will remain on the surface in the face of an air attack. A submarine can dive in less than a minute, and in such a case the air man is checkmated—he cannot hit an invisible target.

The submersible which replaces the destroyer must have high speed on the surface. In this there will be a sacrifice—a compromise. It cannot have as great speed as the present destroyer, but it may be fast enough to accompany the battle fleet. It must surrender some speed to gain submersibility and escape destruction.

The extreme vulnerability of destroyers and light cruisers to air attack presents an unfortunate and perplexing situation, especially for the United States Navy. We have 300 modern destroyers. They were built for use against German submarines, but, unhappily, the Daniels administration so

delayed their building that only eight of the new ones were used in the World War. They cost about \$600,000,000.

Previous to the recent bombing tests, the writer considered these destroyers a powerful asset. But in the light of recent happenings their usefulness in modern war is questionable. They will be of little value if our enemy commands the air. Under those conditions destroyers cannot live.

This brings us up against a stone wall of truth. A surface fleet in the year 1921 must control the air. Battleships, cruisers, destroyers, colliers, tankers and supply ships cannot long exist upon the sea against an enemy that can cruise at will in the air above and subject surface ships to a continuous rain of bombs, torpedoes, mines and poison gas. The unarmored ships will be destroyed with ease, leaving the dreadnought at the mercy of submarine attack, as well as helpless against air attack.

Such is the unhappy condition of the United States Navy to-day. Conservatism and shortsightedness at the Navy Department and in Congress have deprived our battle fleet of the modern weapons—aircraft and submarines—that are most essential in naval warfare. We have spent \$1,500,000,000 on battleships and surface vessels that are in themselves helpless in modern war.—*The N. Y. Times*, 28 August, 1921.

**GEORGETOWN WILL TRAIN SEA EXPERTS.**—For the first time on record the profession of shipping is to be included in the curriculum of an American university. Georgetown is introducing the innovation with the college year just about to open. The course will be given at the "school of foreign service," which is the only one in the United States as a branch of a university and giving full-fledged degrees. Graduates, presumably, will be enabled to aspire to the degree of "doctor of shipping."

The new course will be under the direction of Dr. Roy S. MacElwee, dean of the school of economics, who was formerly director of the bureau of foreign commerce at the Department of Commerce. It will include the following basic subjects:

*Subjects in the Course.*—Ocean transportation (history and organization), ports and terminal facilities (worldwide in scope), steamship office management, wharf management and warehousing, steamship classification and elements of construction, steamship operation, marine insurance, export packing and ship stowage, shipping legislation, admiralty law, railroad law, railroad traffic and rates.

The avowed object of the Georgetown course in shipping is to train a generation of young Americans scientifically equipped to tackle ocean-carrying problems, just as colleges and universities now train lawyers, doctors and newspaper men. Experienced and practical shipping men will act as instructors, or as occasional lecturers.

*In Shipping from Boyhood.*—Among them is W. L. Bull, assistant to the Vice-President of the Emergency Fleet Corporation, who began his career as a boy with the Mallory Line and was an official of that organization until the war, having passed through every stage of the shipping industry in managerial capacities. Another instructor will be A. H. Haag, who also has had a varied experience, having been associated with the Newport News Shipbuilding and Dry Dock Company and later with the United States Shipping Board as chief constructor.

Discussing the new shipping course, Dr. MacElwee said:

*A West Point in Shipping.*—"It is often said the United States cannot hope to compete successfully with British mercantile marine because of Britishers' centuries of experience and tradition as transoceanic carriers. We cannot, of course, begin where the British began. We must do our best to operate as soon as possible on terms of equality. That, it seems to Georgetown University, can most effectively be achieved by systematic instruction in the fundamentals of shipping in all its varied branches. We shall teach, in other words, what the British have done and how they did it.

"It is ignorance of basic principles that is responsible, to a large degree, for the inability of Americans to attain that eminence in the world shipping trade which it is easily within our power to reach. Capital alone will not suffice. If America had had a West Point or an Annapolis of shipping in operation for years before the war, we would have been ready to meet the shipping emergencies of the situation with far greater skill than we did and at incalculable money-saving to the country. It is in the hope of educating and breeding a race of American shipping experts that Georgetown's new venture has been instituted."—*The Washington Post*, 11 September, 1921.

**DRASTIC AMERICANIZING POLICY TO BE INAUGURATED BY SHIPPING BOARD.**—Under the new policy of the Shipping Board, Americanizing is to be the keynote in all departments of service. Officers and crews are to be all American. Foreigners are to be dropped from office staffs in foreign countries as well as in the United States. At present the American merchant marine includes many British officers and men, especially in the engine rooms. In the London offices of the board there are British employees, and in ports all over the world aliens are utilized. The intention is to substitute Americans.

*Six Thousand Employees.*—The employees of the Shipping Board and the Emergency Fleet Corporation number more than six thousand at present, and those who are looking toward economical as well as efficient operation of the board and the corporation appear to be convinced that half that number can do the work. The reduction will be made gradually, after thorough investigation and study. One of the first blows will probably be directed at the London office of the Shipping Board, where a large majority of the employees are British. The new board will try to get along with fewer employees and have them all Americans. If the board has to raise salaries in order to establish an all-American force in London, this will have to be done. The same plan will be adopted elsewhere.

The most important changes contemplated, however, are those that have to do with the crews on vessels in which the Shipping Board has complete or part ownership. Some of these ships are being operated for the board and others are being paid for in installments. After the Board gets reports on the crews of all these vessels, it will begin its drive to Americanize the merchant marine from top to bottom, from captain to deck hand.

Various obstacles have thus far prevented the establishment of 100 per cent American crews. During and after the war period it was necessary to use a larger percentage of foreign seamen. Foreigners were also authorized to officer American ships, receiving what is known as "red ink licenses." Some of these are still in effect, but in the near future they will be cancelled. The majority of the holders are British, particularly the engineers. The percentage of American engineers is extremely small. The board, however, is determined to put American engineers in charge as soon as possible.

Many of the vessels operated by private companies depend upon foreign port officers in various parts of the world. While this is often necessary, it is believed that the board will be able to put Americans in a number of ports where the interests of American vessels are now in the hands of foreigners. American shipping men are confident that by doing so the board will be adding materially to the business of American ships. The board fully anticipates that complaints will be received from various operating companies over the demand that certain officers in foreign ports be replaced by Americans, but the board will insist upon the desired changes.

Vigorous opposition to the Shipping Board's new policy of Americanizing ships is expected to be made by the International Seamen's Union. As its name suggests, this organization is international in character and officials of the board who have been investigating it assert that not more than 50 per cent of its membership is American. For some time past the union

has been manning ships from its own lists and supplying a majority of foreigners. The system will be fought by the Shipping Board, which takes the ground that under all conditions American seamen are entitled to take precedence over foreigners in getting berths on American ships.

The Shipping Board, moreover, is eager to draw young men to the American merchant marine, believing that there are plenty who are ready and willing to go to sea under proper conditions. With the present large pay of seamen on American ships, and officers and crew entirely American, the merchant marine would eventually be manned by a force superior to that of any other country, while a much higher grade of efficiency would be attained.

The Americanizing policy of the Shipping Board has been strongly endorsed by the American Steamship Owners' Association, which has taken an active interest in the newly organized American Seamen's Association, membership in which is limited to Americans. This association is expected to offset the effect of the marine unions controlled by the foreign element, which have exerted every effort to keep Americans from obtaining employment on American ships.

*Doubt Expressed.*—In spite of the Shipping Board's pronouncement and the backing it has received from the American Steamship Owners' Association, the majority of operators are outspoken in expressing the opinion that the idea of 100 per cent American crews for American steamships is impractical "bunk." While Americanizing is admitted to be an excellent thing in its way, it would be just as well, they say, to let every alien stay in his job until an American, well-equipped, can be put in his place. Otherwise Americanization will result in mere flag waving instead of sound business, and the merchant marine will function even worse under the new régime than it did before.

In discussing the subject with a *Nautical Gazette* representative this week, an American skipper who had commanded both sailing vessels and steamers said that the idea of the board was absurd. "These are not the days of clipper ships," he remarked. "Young Americans of fair education can get much better wages and opportunities ashore. Why should they go to sea? And what sort of sailors are there on steamers nowadays? Cleaning brasswork, scrubbing decks and doing all sorts of other chores. That doesn't sound very attractive. Young men will enlist in the United States Navy because life on the warships has a great deal of interest, and there is always a chance for promotion; but you will find very few young Americans worth their salt who are pining to get jobs on freight steamers at \$55 a month."

A similar opinion was expressed by the vice-president of one of the largest American shipping companies. While he conceded that the captains, deck officers, engineers, and assistant engineers should be American, and also the machinists and other mechanics in the engine room, it was unimportant, he said, whether the rest of the ship's company were American or of some other nationality. "Can any man tell me," he observed, "why any young American should be eager to accept the job of an unskilled or manual laborer at sea any more than on shore? You can't get Americans any longer to dig ditches or carry hods; you depend upon certain grades of foreigners for such tasks. In the fire room you can get much better results from Lascars, Chinese or Greeks. Americans don't take to the water now, and since the end of the clipper days they have paid less heed to the call of the ocean."

E. A. Quarles, assistant to the president of the U. S. Mail Steamship Co., said that he doubted whether 100 per cent Americanization in the complement of American ships would ever be successful, however desirable such a transformation might be. Neither Great Britain nor any other maritime country had ever been able to man ships entirely with its own nationals.—*The Nautical Gazette*, 13 August, 1921.



**GERMANS ENTER U. S. AS SEAMEN, SAYS LASKER.**—Numbers of Germans are shipping at German ports on American-bound vessels as seamen at wages of one cent a month, Chairman Lasker, of the Shipping Board, has advised Secretary Davis. The belief was expressed by Secretary Davis that the Germans are permitted to land in this country as seamen, and then flee to the interior. He said he expected to ask that a bill be introduced in Congress requiring the registration upon arrival of all foreign seamen. There are probably 40,000 Chinese in this country without legal right to be here, he added, as a result of their taking advantage of the Seaman's Act.—*The Nautical Gazette*, 13 August, 1921.

### AERONAUTICS

**DEVELOPING AIR DEFENCE.**—By the 15th of this month it is expected that the old battleship *Alabama* will be ready at Philadelphia navy yard to be delivered over for airplane bombing tests in Chesapeake Bay. These tests will be novel in many respects, and should elucidate several points about which there has been some dispute. It is not expected, however, that there will be any developments which will change the fundamental facts brought out through the recent tests which ended in the sinking of the former German battleship *Ostfriesland* and other vessels. In those tests the efficacy of airplane bombs in destroying surface vessels, even without striking them, was fully demonstrated. The terrific shock administered to steel plates by the explosion of bombs in the water near the vessels was sufficient to open the seams and send the ships to the bottom. Probably if there had been human beings aboard they would have been killed by the concussions. The forthcoming tests will include experiments in night bombing in the light of 100,000 candlepower flares dropped in parachutes from the bombing planes. These lights will illuminate the target while the parachute cover will keep the plane in darkness. Experiments will be made with gas bombs, to ascertain the extent to which various kinds of gas permeate a vessel and cover the sea surface. The bombs containing T. N. T. will be of various sizes, some of them holding 4000 pounds of the explosive.

The indefatigable efforts of the army and navy aviation officials and personnel are bearing good fruit and are worthy of all commendation. Through these efforts and through the daily and hourly exertions of flyers the development of aviation in this country is proceeding, in spite of the reluctance of Congress to acknowledge the necessity of adequate provision for air defense. This defense must be provided, if not in peace then under the stern necessity of war. Battleships costing \$40,000,000 each must not be subjected to bombardment from above, and the only method of preventing such attack is to provide an air force that will beat off any force coming against it. The air above a sea fleet must be possessed by the side possessing the fleet. Once the air is lost, the havoc wrought by aerial bombs under practice tests may be wrought in actual warfare.

The United States will surely develop an air force for naval as well as for military purposes. The ground work for such development has been laid. But the development is exasperatingly slow to those experts who have grasped the full significance of air strategy as a concomitant of naval and military strategy. In the next war, they hold, it will be as big a mistake to fail to hold control of the air as it would be to fail to control strategic points on land or naval bases. The mobility of air forces is such as to render military and naval operations doubtful unless the danger of a counterstroke from the air is eliminated. This can be accomplished by holding control of the air above the region of operations. In short, a struggle for mastery of the air is probable in every case hereafter before the struggle on land or sea. This evolution of warfare was repeatedly forecast on the battle fronts during the late war, and naval aviation foreshadows the same situation in sea operations, at least those offshore. As

airplane carriers are under construction by several navies, the time is at hand when air operations will be possible far out at sea.

The bombing of the *Alabama* should bring out much information of value in the construction of battleships to resist the shock of bombs. But it would be hopeless to attempt to build ships capable of defying air bombs. They cannot be constructed in such manner as to survive the shock. Every human being on board a vessel struck by a 4000-pound bomb of T. N. T. would be killed or shocked into insensibility, leaving the vessel helpless, even if it were not sunk. Moreover, gas bombs of deadly nature would rain down upon the ship, making sure of the disablement of all the personnel. Experience has shown that anti-aircraft guns are practically worthless as a defence against air attack. The defence must be airship against airship. Similarly, coast fortifications must be protected by air defences which can beat off the air enemy. As for armies, there is no pretense that they can exist without air defence.

Thus, from any angle considered, the problem yields only to one solution—the creation of air defences strong enough to cope with any possible air offensive. This conclusion means the development of air forces to a point far excelling anything now in existence, both in skill, numbers and equipment.

No doubt the general question of air warfare will be considered by the Washington conference. One thing is certain, however; there can be no just complaint by any nation against the air armament of the United States, or against its program in that direction. The immense territory and long coast lines of the United States are defenceless from the air, and will be for many years at the present rate of progress. The nation is to be criticized, not for arming itself for air operations, but for leaving itself defenceless and thereby endangering its costly naval vessels, its forts, the Panama Canal, and its ports and cities.—*The Washington Post*, 9 September, 1921.

REPORT OF JOINT ARMY AND NAVY BOARD ON BOMBING AND ORDNANCE TESTS.—1. The Secretary of War and the Secretary of the Navy have approved the following report of the Joint Board on result of aviation and ordnance tests held during June and July, 1921:

*Nature of Experiments and the Results.*—2. Certain ex-German war vessels having been turned over to the United States Government in accordance with the decision of the Supreme Council as to their allocation, the Navy Department decided to comply with the provision requiring their destruction by conducting a series of experiments in which these vessels were to be sunk by gunfire or by bombs dropped from aircraft. In order that both branches of the national defence might gain the maximum benefit the Secretary of the Navy invited the army to participate in these experiments.

3. In addition to the experiments with the ex-German vessels as targets, one was conducted with the ex-*Iowa* steaming under radio control as a hypothetical enemy. Search was conducted by aircraft and attacks made using dummy bombs from 4000 feet altitude. This experiment was conducted with a view to obtaining information as to the effectiveness of aircraft in search operations, the ability of aircraft to concentrate for effective attack on a vessel at sea, and the percentage of hits which could be made by dropping bombs from this altitude under the most favorable conditions against a slow moving target capable of changing course at will to decrease the accuracy of bombing.

4. The aviation experiments were successfully conducted under the direction of the commander-in-chief, Atlantic fleet, by the air force of the Atlantic fleet and a provisional air brigade of the army. The gunfire experiments were conducted by destroyers and battleships of the Atlantic fleet.

5. The experiments extended over the period from June 21st to July 21st, and resulted in the sinking of the ex-German vessels as indicated below:

Type	How Sunk	Date
Submarine <i>U-117</i> .....	Bombs	21 June
Submarine <i>U-140</i> .....	Gunfire	22 June
Submarine <i>UB-48</i> .....	Gunfire	22 June
Destroyer <i>G-102</i> .....	Bombs	13 July
Destroyer <i>S-132</i> .....	Gunfire	15 July
Destroyer <i>V-43</i> .....	Gunfire	15 July
Light Cruiser <i>Frankfurt</i> .....	Bombs	18 July
Battleship <i>Ostfriesland</i> .....	Bombs	21 July

6. The schedule of experiments was so arranged as to obtain the greatest amount of information for the practical development of aviation and ordnance including weapons, their appurtenances, and projectiles. Boards of observers were appointed by the War and Navy departments.

7. The experiments definitely determined in each case that the projectiles used were superior to the defensive features of construction of the vessel attacked. It has long been recognized that the gun carried by any type of war vessel is superior at moderate ranges to the armor or protective construction of vessels of like type. In a large measure, therefore, the greatest interest in these experiments lay in the bombing of naval vessels by aircraft. The main features of this report, therefore, relate to the effectiveness of aircraft in offensive action against various types of naval vessels.

8. The Joint Board has carefully studied the reports of the boards of observers and as a result of such study, actual observation of the experiments by one or more members of the Joint Board, and general knowledge of the principles of war and methods of conducting war, has arrived at the following general conclusions:

*General Conclusions.*—9. Within their radius of action, which, relative to that of naval vessels, is extremely short the effectiveness of heavier-than-air-craft carrying large capacity high explosive bombs, depends upon:

- (a) Ability to locate the naval vessel,
- (b) Ability to hit the target vessel with the projectile carried,
- (c) Ability of the projectile to damage or destroy the vessel.

*Consideration of Ability to Locate the Naval Vessel.*—10. Aircraft of any of the three general classes: lighter-than-air ships, flying boats and land planes, either in combination or singly, have pronounced ability to search sea areas within their radii of action and to locate naval vessels operating in such areas. The high speed of aircraft and the range of visibility obtained by altitude are factors which make these craft especially valuable in the service of information.

11. Heavier-than-air craft may obtain the maximum radius of action for use in the service of information only by carrying additional fuel in place of heavy bombs. When armed with heavy bombs the radius of action of heavier-than-air types is inadequate for extensive search operations. Therefore, to conduct an effective attack on naval vessels it will usually be necessary to have certain aircraft for searching and others for conducting the attack with bombs.

12. Darkness, fog, falling or squally weather, will greatly reduce the effectiveness of aircraft in search operations. Most of these conditions likewise adversely affect surface vessels conducting such operations but not to the same extent.

13. The present dependability of the personnel and material of the army and navy aircraft appears to be such as to ensure that search operations, under suitable conditions, can be conducted without an undue percentage of loss. The further development of aircraft will undoubtedly increase both dependability and radius of action.

*Ability to Hit the Target Vessel With the Projectile Carried.*—14. The number of dummy bombs which actually hit the target during the experiment with the *ex-Iowa* was a very small percentage of those dropped. Other experiments, however, showed that it is not necessary to make direct hits on naval vessels to put them out of action or to sink them, provided the bombs drop sufficiently close to the vessel and the explosive charge is sufficiently large to produce a mine effect of such proportions as to destroy the water-tight integrity of the vessel beyond the control of its personnel and pumps. The effective target for the bomb being, therefore, greater than the deck area of the target vessel, the percentage of effective bombs would be greater than the percentage of actual hits.

15. Inasmuch as these experiments were not conducted under battle conditions it is difficult to draw conclusions as to the probability of hitting a target with bombs from aircraft while in action. Under the favorable conditions existing during the experiments—namely, stationary, or practically stationary, target, immunity from enemy interference and excellent visibility and flying conditions, the percentage of hits was greatly in excess of that to be expected under battle conditions.

16. The probability of hitting will be reduced in the case of a target moving at high speed on varying courses; further reduced if the target vessel is protected by effective anti-aircraft armament; and practically negligible if the target is protected by effective pursuit planes. On the other hand the probability of hitting will be increased by more efficient sighting and bomb-dropping control apparatus, by further training and further development of aerial tactics.

17. In the present state of anti-aircraft defence it is believed that, if an air force can obtain the mastery of the air, an effective percentage of hits can be obtained against surface vessels coming within the radius of action of bombing planes without an undue percentage of loss of aircraft. Anti-aircraft armament is in an early stage of development. The history of war indicates that means of defence develops rapidly to meet the development of offensive weapons. The effectiveness of the bomb carried by aircraft emphasizes the necessity for the rapid development of anti-aircraft armament and for the provision of pursuit planes as a part of the fleet.

*Ability of Aircraft to Damage Naval Vessels.*—18. Aircraft carrying high-capacity, high-explosive bombs of sufficient size have adequate offensive power to sink or seriously damage any naval vessel at present constructed, provided such projectiles can be placed in the water close alongside the vessel. Furthermore, it will be difficult, if not impossible, to build any type of vessel of sufficient strength to withstand the destructive force that can be obtained with the largest bombs that aeroplanes may be able to carry from shore bases or sheltered harbors.

19. High-capacity, high-explosive bombs hitting the upper works of the vessel are disastrous to exposed personnel, serious to light upper works, comparatively slight to heavy fittings such as guns, and negligible to turrets. The effect of direct hits was completely local. The most serious effect of bombs is the mining effect when such bombs explode close alongside and below the surface of the water.

20. In the case of major ships the mining effect of a bomb will be materially reduced due to the ability of the personnel to free the ship of large quantities of water by means of pumps to distribute the excess water through the various compartments and to shore up the water-tight doors and bulkheads which are in most serious danger of carrying away due to water pressure.

21. Aircraft, through the medium of machine guns and fragmentation bombs as well as by high-explosive bombs of high capacity, possesses sufficient offensive power to seriously threaten the exposed personnel of naval vessels unless such vessels are protected by pursuit planes. This emphasizes the necessity for the further protection of personnel and for the provision of aircraft carriers on which such pursuit planes may be based.

22. The effect of the gas bomb has not been determined but it is believed that such bombs possess offensive power which, within the radius of action of the aircraft, is to-day a serious threat to vessels insufficiently protected by aircraft.

*Summary of General Conclusions.*—23. At present aircraft possesses the following abilities as regards operations with the fleet in areas beyond the radius of action of aircraft based on shore:

- (a) Limited assistance to gunnery in the control of fire.
- (b) Limited assistance in the service of information and security.
- (c) Important strategical and tactical qualities in operations of coast defence.

In adequate quantities they may be the decisive factor in such operations. The availability of these qualities at present depends largely on weather conditions. The radius of action of bombing planes limits their effectiveness against naval vessels to coast defence, or base defence, in which this type is a very powerful adjunct to the present system of coast defence.

24. With reference to the effect of aircraft on future naval construction the Joint Board is of the opinion that:

(a) The mission of the navy is to control vital lines of transportation upon the sea. If no opposition is met from enemy naval vessels this mission can be accomplished without entering an enemy's coast zone within which aircraft based on shore or in sheltered harbors are effective.

(b) Without an effective navy in time of war a nation must submit to an economic blockade fatal to its trade and the importation of necessary materials for the production of war supplies.

(c) If heavier-than-air craft are to be effective in naval warfare they must have greater mobility and since their radius of action is not great, additional mobility must be obtained by providing mobile bases—i. e., aircraft carriers.

(d) So far as known, no planes large enough to carry a bomb effective against a major ship have been flown from or landed on an aeroplane carrier at sea. It is probable, however, that future development will make such operations practicable.

(e) Even in the present state of development the aircraft carrier, as exemplified by the *Argus* of the British Navy, is a type essential to the highest efficiency of the fleet.

(f) Aircraft carriers are subject to attack by vessels carrying guns, torpedoes or bombs and will require, as all other types of vessels require, the eventual support of the battleship.

(g) The battleship is still the backbone of the fleet and the bulwark of the nation's sea defence, and will so remain so long as the safe navigation of the sea for purposes of trade or transportation is vital to success in war.

(h) The aeroplane like the submarine, destroyer and mine, has added to the dangers to which battleships are exposed but has not made the battleship obsolete. The battleship still remains the greatest factor of naval strength.

(i) The development of aircraft instead of furnishing an economical instrument of war leading to the abolition of the battleship has but added to the complexity of naval warfare.

(j) The aviation and ordnance experiments conducted with the ex-German vessels as targets have proved that it has become imperative as a matter of national defence to provide for the maximum possible development of aviation in both the army and navy. They have proved also the necessity for aircraft carriers of the maximum size and speed to supply our fleet with the offensive and defensive power which aircraft provide, within their radius of action, as an effective adjunct of the fleet. It is likewise essential that effective anti-aircraft armament be developed.

25. The Joint Board recommends that the provisions of the previous orders of the War and Navy departments relative to secrecy concerning the results of the aviation and ordnance experiments be rescinded and that

this report, if approved by the War and Navy departments, be issued jointly to the press.

The report of the joint board of the army and navy on bombing tests off the Virginia capes must remind the layman of the problem of the conflict between the irresistible force and the immovable object.

One of the questions which the tests were to answer was whether the bombing plane, in its present state, was a generally adequate weapon against the battleship of to-day. To this question the report says, No; not unless the plane is operated from a land base:

"No planes large enough to carry a bomb effective against a major ship have been flown from or landed on an aeroplane carrier at sea. It is probable, however, that future developments will make such operations practicable."

What of the bombing plane as an instrument of coast defence, operating from the shore? On this point the plane scores:

"Aircraft carrying high capacity high explosive bombs of sufficient size can sink or seriously damage any naval vessel at present constructed provided such projectiles can be placed in the water close alongside the vessel."

Can battleships be made invulnerable against aerial attack? Only through the ship's offensive defence, the board indicates, for it says that "it will be difficult, if not impossible, to build any type of vessel of sufficient strength to withstand the destructive force that can be obtained with the largest bombs that aeroplanes may be able to carry from shore bases."

So if the United States had enough planes of sufficient capacity no invading fleet could reach our shores unless the enemy ships were equipped with anti-aircraft guns so marvelous as to bring down all our fliers.

As the report remarks, the development of aircraft "has but added to the complexity of naval warfare." It has not junked the battleship, for that must be kept to protect the nation against a blockade. It has rendered it necessary to make the battleship a carrier of planes and to equip it with more and more powerful anti-aircraft guns. Meanwhile the planes must be made bigger, faster and their locating instruments more accurate.

The report does not doom capital ships, but it is for all that a victory for the advocates of the plane as a tremendous weapon in coast defence. The United States could have within a year and at comparatively small cost, a squadron of bombing planes that could fly from a shore base and destroy any battleship that came within gun range of the coast. That's a comfort to know, however the scientific duel between the builders of dreadnoughts and the makers of planes may result in future.

There are naval officers in England and America who think with Admiral Sir Percy Scott and Brig. Gen. Mitchell that submarines and aircraft have rendered the capital ship obsolete. If so, a nation that spent millions chiefly on aviation and maintained a fleet of swift carriers would be a more terrible enemy than a power that placed its dependence upon capital surface ships and neglected aviation. Granting that surface ships are necessary to a navy for police duty in time of peace and for offence and defence in war, it would be judicious not to have too much faith in them. Senator King of Utah said a sound thing when he declared that "these tests demonstrated the vulnerability of the battleship and demonstrated that while it is not obsolete as the principal unit of the fleet its strength and influence have been greatly impaired."

While exceptions may be taken by advocates of the airship as a superior unit to some of the reasoning of the Joint Army and Navy Board's report, it is an honest and courageous summing up of the case by men who felt their responsibility. Speaking of the navy alone, its aviation strength must be expanded to the dimensions of a fleet in the air, which of course will require time, and a sufficient number of swift carriers must be provided. But this will take money—a great deal of it. In the present state of the

country's finances the naval appropriations cannot be increased. Will not Congress have to choose between neglecting aviation, which would be blindness to the lesson of the bombing tests at sea, and calling a halt upon the three-year capital ship program somewhere, so that money to be spent upon it could be diverted to the expansion of naval aviation?—*Aerial Age Weekly*, 5 September, 1921.

**THE BACKBONE OF THE FLEET.**—The report rendered by the Joint Army and Navy Board on the recent aerial bombing tests off the Virginia Capes confirms the lessons which we drew in our issue of August 6th from these trials. The findings of the report are summed up in the following statement: "The battleship is still the backbone of the fleet and the bulwark of the nation's sea defence, and will so remain so long as the safe navigation of the seas for purposes of trade or transportation is vital to success in war."

The above quotation is one of the ten conclusions, categorically stated, in which the Joint Board, made up of naval and army officers, submitted its findings on the burning issue as to whether bombing aircraft have rendered the battleship obsolete. The argument runs as follows: That if the navy commands the sea routes, the lines of traffic can be kept open without entering the area on the enemy's coast zone which is controlled by aircraft bases on shore. Conversely, a nation without an effective navy must submit to a fatal economic blockade. Again, if heavier-than-air craft are to be effective in naval warfare, they must be able to operate in midocean; and since their own radius of action is limited, they must operate from those mobile bases known as aircraft carriers. Although our navy does not know of any case in which bombing planes, such as sank the *Ostfriesland*, have flown from or landed on an aircraft carrier, it is believed that such operations will in the future become practicable. In this connection, the report quotes the *Argus*, of the British Navy, as a type essential to the highest efficiency of the fleet; but the point is made that since aircraft carriers are subject to attack by vessels armed with guns, torpedoes or bombs, they, like all other subsidiary types of vessels, will require the eventual support of the battleship.

We think this last statement is subject to criticism. A 30,000-ton, 32-knot aircraft carrier would be self-supporting; and for defence against a too-powerful enemy would depend upon her superior speed to enable her to keep out of range. The best of modern battleships cannot hit beyond 20 or 25 miles—an aircraft carrier could maintain a range of 30 miles and send out her bombing planes against the enemy with complete immunity to herself.

The report admits that although the airplane, like the submarine, destroyer, and mine, has added to the dangers to which battleships are exposed, it has not made the battleship obsolete, although the appearance of aircraft has added to the existing complexity of naval warfare.

With the final clause of the report, as indeed with the whole report as such, we are in thorough accord. It states that the aviation and ordnance experiments, conducted with the ex-German vessels as targets, have proved that it has become imperative as a matter of national defence to provide for the maximum possible development of aviation both in the army and navy. These bombing experiments have also proved the necessity for aircraft carriers of maximum size and speed as an effective adjunct of the fleet. It is likewise essential that effective anti-aircraft armament be developed.

Now there is danger, we think, of becoming so greatly impressed with the necessity for building an effective fleet of aerial bombing planes as to overlook the equally important defensive side of the problem. The present popgun arrangements, mounted on warships for the purpose of bringing down airplanes are futile. Shells thrown by 3- and 4-inch gun do not afford a big enough burst and spread; moreover, there remains to be developed

an accurate and swift means for determining the ever-changing position of the enemy. We look to see the day when the 5-inch anti-torpedo batteries of warships will be known as anti-torpedo and anti-plane batteries; which means that they will be mounted on the topmost decks and provided with unlimited elevation.—*Scientific American*, 3 September, 1921.

**THE AIRPLANE IN SCIENCE.**—The use of airplanes for meteorological observations is not only possible but essential to scientific progress, according to Gabriel Guilbert, Chief of the Forecast Service in the French National Meteorological Bureau, in a recent address at Rouen.

"The basis of good forecasting is first of all good observation," he said. "Exact information and a capable staff of workers will not suffice; there must be a considerable number of stations, placed at carefully selected points and under professionally trained meteorologists. Our daily charts, though the largest prepared anywhere in the world, must be developed, and in this the wireless telegraph will enable us to record observations in the north, coming from Spitzbergen or even nearer the Pole, from the east, from Siberia, the Caspian Sea, Asia Minor, from tropical lands to the south, and in the west from stations in Greenland and the New World, as well as maritime observations from transatlantic liners.

"Last of all, scientific progress demands the utilization of the airplane. That is in the present and the future the best means of meteorological exploration. The aviator can determine the physical nature of different clouds, their extent, altitude, relative positions and motion. He alone can watch 'on the spot' the secrets of the formation of rain and storm. And if artificial rain is not an idle dream, the aviator can bring it about. The entire atmosphere is comparable to-day to an unexplored desert; and through airplanes new foundations may be laid for the development of scientific weather forecasting."—*The N. Y. Times*, 29 August, 1921.

**THREE NEW FOG DEVICES** to overcome the drawbacks of mist and fogs to airmen are stated to be under discussion by British authorities. The first consists of the "laying along the route traversed by the airway of a powerfully charged electrical cable. This automatically sends up into the air a constant series of signals." By keeping his machine in such a position that the strength of the signals is kept constant the airman is assured that he is flying along the cable line. The second makes for safety in landing when the ground is not visible, and consists of a wire, with a weight attached, which is lowered from beneath the machine; when the weight touches the earth the airman learns that it is time to "flatten out" his machine. The third is called the "artificial horizon." It is "a gyroscopic instrument which shows an artificial horizon line always in front of the pilot and enables him to detect instantly when his machine is heeling over too much sidewise in its relation to the real horizon, which is temporarily invisible. A tiny model airplane poised above the artificial horizon line mimics precisely the movements of his own machine."—*Scientific American*, 3 September, 1921.

**STEAM ENGINES FOR AIRSHIPS.**—Invention of a system of steam propulsion for airships is claimed by Captain W. P. Durnall, who was a British naval officer during the war, and up to a year ago staff captain in the chief mechanical and electrical engineer's department of the Royal Air Force.

It is maintained that the new system will function at altitudes hitherto unattainable with the ordinary type of internal combustion engine.

The invention is said to do away completely with the ordinary boiler, the steam being generated by means of internal combustion power or heat energy. The superheated steam heat energy is supplied to special steam motors which are reversible and can be controlled from a central control station. Only heavy oil is used as fuel, and it is claimed that the driving



machinery can be safely placed inside the frame of the airship instead of in separate gondolas outside, thus bringing about a great reduction in air resistance and consequently reducing the power required for propulsion.

The engines or "steam motors," as Captain Durtnall calls them, are of the double-acting type, requiring no flywheels.—*Aerial Age Weekly*, 5 September, 1921.

**TRANSATLANTIC FLYING SHIPS.**—According to the London *Daily Mail* the Fairey Company, builders for the British Air Ministry of the great Titania flying boats, have in hand plans for giant transatlantic flying ships, driven by specially designed 4000-horsepower engines, which will have luxurious accommodation for as many as 100 passengers, in addition to fuel, crew and stores. They will, in fact, be air liners, with great hulls which, seen without their wings, one might mistake for some specially designed craft for use on the surface of the water. Starting from the lower reaches of the Thames, such vessels will be able to make a non-stop flight to New York in very little more than 40 hours; while calculations which have just been made show that with a sufficient fleet, well patronized, the fare by flying should be little, if any, more than by steamship. Conditions in the flying ships will approximate almost exactly to those of first-class steamship travel. Guided on their course by directional wireless, informed in advance of weather changes, and with a motive plant which is practically immune from the risk of breakdown, they will offer not only speed and comfort but also safety.—*Aerial Age Weekly*, 5 September, 1921.

**THE GREATEST AERIAL DISASTER.**—When the world's largest dirigible exploded, collapsed and fell flaming into the River Humber burning to death or drowning 17 American and 27 British officers and enlisted men, it meant "the end of experiments with airships of the *Zeppelin* type," in the opinion of Hiram Percy Maxim, inventor and aviation enthusiast. "The great cost of constructing a 700-foot rigid dirigible," agrees the *New York Sun*, "has perhaps checked the progress of development in this type." Rear Admiral Moffett, chief of naval aviation, however, maintains that the American Navy "will 'carry on,' build and operate as many ships of this type as may be authorized by Congress." In fact, at the present time the *ZR-1*, sister ship to the British *R-38* (which was to have become the *ZR-2* after the successful completion of her trials) is now in process of construction in this country. "It seems, however, that at the present time, like Frankenstein, men build such a giant only to have it turn upon them and to destroy them," notes the *Hartford Courant*. In any event, says the *Springfield Union*, "this tragic instance—the world's worst aviation disaster—clearly shows that the construction of these immense dirigibles involves problems yet to be mastered." Moreover, contends the *New York Herald*, "they must be mastered at home, where we must eventually make these airships for ourselves. Why should the government spend \$2,000,000 for a British dirigible? Yankees are good hands at such work."

As the *R-38* had not been accepted by the navy, the investigation of the cause of the disaster probably will be undertaken by the British Air Ministry, it is pointed out. Nor, it is said, will the United States be expected to pay any part of the loss. That the *R-38* was considered a "lemon" and a "flivver" by several members of the crew which was to have brought her over the Atlantic, is now revealed by the *New York press*. Although at this time it is not known whether the collapse of the dirigible was due to faulty design, mechanical trouble, fuel or gas leakage, structural weakness, fire or the bursting of gasoline feed pipes, "time and again news of defects in the airship were published," we are reminded by the *New York Evening Mail* as we read in a *New York Times* editorial: "Defects in her construction had come to light, although little was said about them officially. In July an intermediate plane and four intermediate

braces showed weaknesses. It was then reported that she had a tendency to 'drag amidships.' Early in August some control wires loosened when she was running under half power. The balanced elevators and rudders were said to be 'overbuilt'; a rib here and there gave way; and extensive repairs were necessary. There was some talk of engine trouble. The fact is, the dirigible was in the repair shop a good deal of the time, but the constructors were sanguine that she could be strengthened and made airworthy."

More specifically, we are told by the *New York Tribune*:

"Prior to her final flight the *ZR-2* (as she was to have been rechristened by the U. S. Navy) had made three short trial journeys. On each of them serious defects were observed immediately after all of the craft's six engines were advanced to full speed.

"On her first trial flight the airship was compelled to descend before her scheduled time because control wires loosened quickly under half-speed flying. The second flight had to be shortened in order that the rudder surfaces could be reduced.

"The third trial flight disclosed for the first time that the giant hull was structurally defective. On this flight the airship attained a speed of 50 knots for the first time. This speed was 10 knots less than the contract cruising speed. Nevertheless, even at this reduced speed the strain was so great that some of the vessel's ribs weakened and gave way. Only four of the six engines were running at the time the weaknesses developed.

"It was after this flight that the dirigible was taken back to Howden and extensive repairs made with a view to strengthening the hull."

It was expected that the *R-38* would be the forerunner of a fleet of war and commercial dirigibles. She carried a wireless set capable of sending messages 1500 miles; all parts of the ship were connected with the commander's gondola by telephone; the exhaust from the engines was utilized for cooking purposes; the men had bunks instead of hammocks; the ship was electrically lighted throughout; in fact, as one writer puts it, "nothing was overlooked in making the vessel an air-floating home." True, her compartments were not filled with helium gas, which is non-inflammable, but with hydrogen gas, but this is because the United States has the only known supply of helium gas, and even we do not produce it in large quantities. Had this gas been used, experts agree, there would have been little, if any, loss of life. As the *New York World* points out, "inflammable gas is never safe in the vicinity of a gasoline engine or an electrical storm." Continues *The World*:

"The theory of the dirigible remains so sound essentially that it will not be abandoned, but the production of an inexpensive, non-inflammable gas must precede further rapid development. As matters stand, the necessary experience in piloting and handling airships is brought too often at the price of the lives of the crew. If the business of experimentation were put on a more scientific basis and confined for a while to laboratory tests more progress might be made and fewer lives lost at the same time. As Germany pretty well proved during the war, the dirigible can be both manageable and effective when correctly built and well handled. It has a future."—*The Literary Digest*, 3 September, 1921.

**BIGGEST NAVY BLIMP BURNS WITH THREE MORE.**—Twenty minutes before she was to have started for the hangar built at Lakehurst, N. J., for the *ZR-2*, the naval balloon *D-6*, the largest and newest non-rigid dirigible possessed by the navy, burned with her hangar and three other balloons at the Rockaway Point Naval Air Station yesterday morning.

No lives were lost, but Machinist's Mate Donald B. MacKay, in the car when the fire started, was severely burned. MacKay, his clothing in flames, escaped by climbing down a rope ladder to the floor of the hangar just as the fire began to lick up the sides of the huge envelope.

The *D-6* was fully inflated and contained about 190,000 cubic feet of hydrogen gas. The other balloons, not inflated, were the kite balloon *A-P* and two small dirigibles, the *C-10* and the *H-1*, which broke away from its moorings about two weeks ago and was found in Westchester County.

*Balloon was Navy-Built.*—The *D-6* was 200 feet long and 50 feet in diameter fully inflated. She was propelled by the two 125-horsepower Union type motors, and could make 50 miles an hour. She had a lifting power of about 10 tons. The *D-6* carried 200 gallons of gasoline and had a cruising radius of 1000 miles. She was assembled at the Rockaway Point Station under the direction of Lieutenant Bausch.

The gondola and engines were built at the League Island Navy Yard in Philadelphia and the balloon was made at the navy balloon plant in Akron, Ohio. The *D-6* was equipped with the limousine type of gondola, completely enclosed, which made it possible, the authorities believe, for the men in the hangar to escape before the balloon ignited. The trip to Lakehurst would have been her maiden voyage, although she had been taken for several short test spins over Jamaica Bay and Coney Island.

Before the *ZR-2* disaster it had been planned to sail the *D-6* to Lakehurst, where she would have been used as a training ship for the crews of the *ZR-2*. Her hangar was built in 1917. Its dimensions were 225 by 125 by 80 feet, built to house two ships the size of the *D-6*. Constructed of steel and glass, it was a total loss. The value of the *D-6* was put at about \$100,000. No estimate was given of the value of the other balloons or the hangar.—*The N. Y. Times*, 1 September, 1921.

THE AMERICAN AIRSHIP.—The destruction by fire of the *D-6*, the largest American naval dirigible, and of two smaller lighter-than-air craft, following so closely upon the loss of the *ZR-2*, invites attention to America's part in the development of the airship. As in the case of the airplane, the country's part in the development of this means of air transportation has been slight. The Wright brothers had to go to France for sympathetic aid during the pioneer airplane days, and their experience discouraged Americans who were interested in Germany's efforts to bring the *Zeppelin* to perfection.

The war found the United States, with inventive genius, money and manufacturing facilities, far behind even second-rate powers in aerial navigation progress. Under the stimulus of war, the country tried to catch up, but failed. Its armies in the field paid a tremendous price in blood, because at the outset of the war the American Army had only two serviceable airplanes. The war lesson was, however, forgotten as soon as the Armistice was signed. The American factories equipped to make aircraft of all kinds are now receiving little encouragement from the government. Even the experiments in the use of airplanes and dirigibles in naval warfare off the Virginia capes have not aroused the government.—*The Indianapolis News*.

WOULD USE HELIUM TO FLOAT AIRSHIPS.—Further experimental work in the production of helium as a substitute for hydrogen gas for dirigibles is urged by Van R. Manning, former director of the United States Bureau of Mines and new Director of Research for the American Petroleum Institute. The terrible loss of life in the *ZR-2* disaster at Hull, England, Mr. Manning declared yesterday, accentuates the need for an intensive development of the helium here.

"The military and commercial use of helium for dirigibles," said Mr. Manning, "is generally recognized, although to date no practical utilization of this gas has been made except by the government. In the spring of 1917, as the Director of the Bureau of Mines I approved a preliminary investigation as to the possibilities of the production of helium as a war measure, and as a result a co-operative effort was instigated by the Interior, Army and Navy departments looking toward the solving of a problem

which was important to our own and our Allies' interests. Prompt and quick results were desired.

"It can be said to the credit of these branches of our government that satisfactory results were obtained, although not in time to put into actual service dirigibles filled with helium. Ample funds were allotted by the Army and Navy Departments to the Bureau of Mines, Interior Department, and experiments were immediately begun with three processes. One process was proved to be successful, another not wholly successful and the third plant has been operating experimentally up to a few weeks ago. The fact is that the government is now operating a large helium production plant, with a capacity of 30,000 cubic feet of helium per day.

"Major P. E. Van Nostrand of the United States Army, who was to have been one of the officers on the ill-fated *ZR-2*, was one of the collaborators in the development of this work and fully appreciates the importance of helium for dirigibles and balloons, is credited by the press with the statement that 'had the ship been filled with helium it is doubtful if such an accident could have happened.'

"As one who had to bear the responsibility for the experimental work until a year ago, I cannot emphasize too strongly the statement that the government expenditures, large as they were, in separating helium from natural gas for use in dirigibles, whether for military or commercial purposes, have been thoroughly justified, and it will be obvious to any one who has even a superficial idea of the uses for helium that ample funds should be forthcoming from the government and private sources to carry on further experimental work. The government is now the chief user of helium, and I should like to direct the attention of our country to the importance of continuing active and immediate development of the rigid airship and helium programs previously undertaken by Congress to the end that the officers and men who forfeited their lives may not have died in vain."

The story of helium was described by Mr. Manning as "one of the romances of science." "It may be of interest at this time," he said, "to know something of helium and the development in the production to date. Scientists admit that its discovery was one of pure science. It was first discovered in 1868, in India, while scientists were making observations of an eclipse of the sun. Scientists agree that the occurrence of helium is in the air, in sea and river water, in rocks and minerals, in the stars and sun, in mineral springs, in geysers and in volcanic gases, but the only quantities on a large scale can be recovered from the natural gas of the United States."—*The N. Y. Times*, 4 September, 1921.

**THE DIRIGIBLE'S USES.**—The comment often heard upon the lamentable destruction of the dirigible *ZR-2* takes the form of criticism of our government for acquiring at great cost a type of airship that has so often succumbed to storms and enemy attack. It is said that the government should put all its money into seaplanes, which are much more useful and much cheaper. Why, ask the critics, did the United States contract to buy a British dirigible when there were so many competent American constructors and mechanics to build airships here? The answer is that the Navy General Board recommended that 10 rigid dirigibles be added to the fleet, and that as the British *R-38* was in the market a beginning could be made with that ship at a time when the British possessed the only hangar in which a dirigible like *R-38* could be built. The United States has since completed a hangar and will make its own lighter-than-air ships. One about the size of the *R-38* or *ZR-2* is now building. It must be understood that when the contract was made in 1920 to take over the *ZR-2* our designers were learning from the British, who previously had obtained the German secrets of construction.

The naval authorities believe that dirigibles are valuable auxiliaries. "For coast patrol," says Woodhouse in his "Textbook of Naval Aero-

nautics," published in 1917, "the *Zeppelin* is very efficient indeed. For submarine hunting, convoying ships and patrolling ship channels a single *Zeppelin* can easily do the work of 50 airplanes, and can do work which no airplanes can do at present." Dirigibles are thought to be indispensable for "spotting" mines and signalling the presence of submarines to the fleet. It must be considered that a ship like *ZR-2* would have a cruising radius of 5000 miles. She could move in any direction and leave her base for a long time. At night the dirigible is master of darkness, while the airplane is uncertain of her course. The dirigible can carry many tons of explosives; on a raid stealthily carried out she could demolish camps and lay fortified cities in ruins.

The *ZR-2* was to have been a formidable war machine. She was to be equipped to carry four bombs of 520 pounds and eight of 230 pound. She was to have a battery of 14 machine guns and a one-pound automatic gun for defense. So spacious were her crew accommodations that she was to serve as the aerial general headquarters of the fleet. There were to be telephone communications on board and a wireless system. A dirigible like her is now building at Lakehurst. The American constructors believe that their ship will be an improvement upon the *Zeppelin* and the best British dirigible.

There will, of course, be no halt in the work at Lakehurst because *ZR-2* proved a total loss and valuable officers perished. A naval policy may be changed because it is proved to be wrong, but it is not abandoned because casualties have occurred in carrying it out. The airplane, in the opinion of some specialists, has rendered the battleship obsolete. Nevertheless, the battleship is to be retained because a greater number of specialists contend that it is the most useful unit of a fleet. But no one will argue that the airplane has "scrapped" the dirigible. The lighter-than-air ship has many uses in a sea campaign and can be very destructive on land. The building of dirigibles will go on, although they may be made smaller for the sake of greater structural strength and security.—*The N. Y. Times*, 26 August, 1921.

**AIRCRAFT AND LIGHTNING.**—An experienced flier discusses the possibility of aeroplanes in flight being struck by lightning during a storm in a recent issue of *Illustrirte Flug-Welt*. His remarks are based on some 70 flights under such circumstances and on general principles. He shows that no danger is to be expected in the first place if the machine is not in the direct line of the discharge, and in the second place, even if it is, it is not likely from the nature and distribution of the conducting metal portion that danger due to fire will arise. Out of 30 cases where the machine was struck directly, the writer maintains that there were no evil effects, while in all known cases in Germany where a machine fell during a storm there was no evidence of scorching of parts or melting of metal.—*Aerial Age Weekly*, 22 August, 1921.

**A SURVIVAL OF THE FITTEST AMONG AIRPLANES.**—The French public, which has ever taken a keen interest in the advancement of aviation, was recently treated to an interesting competition among a number of large passenger airplanes, the object of which was to determine their respective merits for regular passenger service. The main factors of the competition were the maximum of safety, of speed, of general performance, and of dependability over a protracted period of service. First of all, a series of elimination trials was conducted, only the surviving machines being permitted to take part in the final and true test in the form of a flight of 2700 miles.

Under control of the well-known pilot Gonin, the Farman *Goliath* made a remarkable flight. It carried a load of over 6000 pounds. The average flying speed over the 2700-mile course was upward of 80 miles per hour, with the motors turning at 1300 revolutions per minute. The machine

scored a veritably perfect performance; indeed, not even a single wire had to be adjusted upon its return, and the *Goliath* was said to be ready to undertake a new flight without a single repair or tuning up.

It will be recalled that the Farman *Goliath* as a type has been known for the past two and one-half or three years, or shortly after the termination of hostilities. However, heretofore this type has had but two motors of 250 horsepower each. The addition of a third engine should make for even greater reliability and greater speed. The two-engined *Goliaths* have distinguished themselves by the Paris-Dakar flight with seven passengers, Paris-Constantinople, and the regular commercial services between Paris and Brussels and Paris and London.—*Scientific American*, 3 September, 1921.

**NEW SYSTEM OF DETERMINING GROUND SPEED OF AN AEROPLANE IN FLIGHT.**—A mathematical system for determining the ground speed of an aeroplane during flight, as well as wind direction and velocity at any altitude, which shows considerable promise of proving an interesting and highly useful solution of these heretofore difficult problems in the longer cross-country, photographic, and bombing operations, has recently been evolved by Major Junius W. Jones, A. S., who has just completed a series of tests in these subjects incidental to his routine air missions as a student pilot at the Air Service Observation School, Post Field.

The system devolves upon the known geometric relationship between three factors, all of which may be readily determined by the pilot whilst in flight; namely, air speed, drift angle, and time each way between any two nearby points on the ground. An exact mathematical height above the earth, independent of the data given at the moment by the aneroid instrument, may also be determined by the system worked out by Major Jones, and would doubtless prove of great advantage over the altimeter, which is necessarily limited in accuracy by zero orientation at the home landing field, in cases where exact scale photography were to be carried out over distant objectives of varying elevation above the sea level, or when, in artillery work, the Battery Commander is requested to lay his guns on the plane, the exact altitude of the ship above the designated target forming the base line of triangulation by which accurate range may be determined.

To reduce the application of his system to a practical basis so that the pilot's attention need not be absorbed in calculation, which the inventor modestly admits must lead to realms somewhat abstruse before the integrations employed may be directly applied, Major Jones has resolved all formulæ into a single simple chart, consisting of a series of arcs with their intersecting and correlated curves, a photostat copy of which has already been published in practical scale for use in the cockpit. By this chart it is necessary only for the pilot to adapt the simple arithmetical factors of time, airspeed and drift angle to a base line of the chart, which is then followed through its various intersections graphically to obtain the desired information concerning ground speed, wind direction and velocity, compass course, or altitude, etc.—*Aerial Age Weekly*, 3 September, 1921.

**IMPROVED AIRPLANE PROPELLER.**—Announcement is made in the *Times* of the invention of an improved type of airplane propeller whereby engine power necessary for driving the airplane will be lessened and the vibration of the machine will be much reduced. The new type of propeller arises from the addition of a number of "veins" or flanges made of aluminum to the existing type of propeller. These "veins" are about six inches in height and run parallel across the surface of the propeller at a distance of about one foot from each other. There are eight at the drive side, four at each end of the blade, and six on the wind side in similar positions. It is claimed that by this arrangement the air is properly directed past the propeller blade faces, with the result that there is an avoidance of the air

losses from the blade ends, which through natural causes take place in the present type of propeller, making possible a maximum thrust with a minimum expenditure of power.—*Scientific American*, 3 September, 1921.

### NAVIGATION AND RADIO

**THE DISTANT COMPASS.**—For a long time, small fluid compasses were almost exclusively used on aircraft. Such a compass consists essentially of a number of comparatively weak magnets which, supported by a hollow float, turn on a needle point in a vessel filled with alcohol and water. This would answer for ordinary use, if there were on the aircraft no iron parts and no other magnets, like starters, magnetos, dynamos, etc.

The compensation of these disturbances by small magnets is only a make-shift and by no means frees the compass readings from error. The many neighboring movable iron parts, like steering devices, weapons, tools, bombs, etc., even key-rings, knives and the like in the pockets of the occupants, exert, according to their size and proximity, a varying influence on the compass readings which, on the aircraft, are hardly controllable and cannot be corrected, any more than the constantly varying influence of the above mentioned magnets.

Every deviation of the aircraft from the horizontal position, in either a lateral or longitudinal direction, likewise exerts an influence on the compass readings. Thus there are generated, especially by sudden changes of position in curved flight, oscillations of the card which may even increase to the complete revolutions dreaded by every aviator.

The oscillations of the compass card, due to those magnetic and mechanical influences are indeed deadened by the compass liquid, but this friction is operative not only in the indicated instances, when the card, with the magnets, oscillates with reference to the compass vessel, but also when the system is at rest and only the vessel turns, as in every curving flight. In the latter case, the card is also carried along and indeed just so much more, the weaker the magnet system and, accordingly, its directive power. On the other hand, the greater the directive power of a magnet system, the greater are its errors of deflection from neighboring masses of iron. These errors call for stronger compensation magnets which, the stronger they are, the more they weaken the directive power of the system. Out of this endless circle there was yet on an aircraft only the unsatisfactory compromise. The employment of a reliable magnet compass, free from objections, was impossible and one was compelled to make the best of inaccurate and unsatisfactory compasses.

An improvement of the properties of the aeroplane compass to real serviceableness in aerial navigation is only possible then, when the disturbing causes are eliminated. The navy prescribes for every compass on shipboard a minimum distance within which there must be no iron. This is impossible on an aeroplane, since there is no such amount of room free from iron from within view of the pilot or observer. It is difficult to install a compass on an aeroplane at all, on account of the limited space.

On the other hand, the remedy by placing the compasses in magnetically somewhat more favorable position, for instance, on the upper or lower supporting deck, presents many other disadvantages: inconvenient reading of the compass, difficult and inaccurate steering by such a distant instrument, compulsory cessation of the possibility of taking bearings, as also the impossibility of using adjustable indicators and other accessories, mistakes in reading oblique and side views, insufficient protection of compass against cold and wet, as also against the force of the air current which, in such a location, often tilts the compass or even upsets it. Moreover, only small compasses with weak magnets can be used, since a higher directive power cannot be employed, for reasons already given, and the still unavoidable proximity of iron and because the limited space prevents the installation of larger compasses.

Against the use of the ordinary compass on an aeroplane there are various further practical considerations. Steering by a reference mark and the general use and complete utilization of such a compass requires too much experience on the part of the pilot, especially of one with little or no knowledge of navigation, while even an experienced and educated pilot finds it too strenuous to watch the card, with its finely divided scale, and, at the same time, attend to the numerous details of managing the aeroplane,

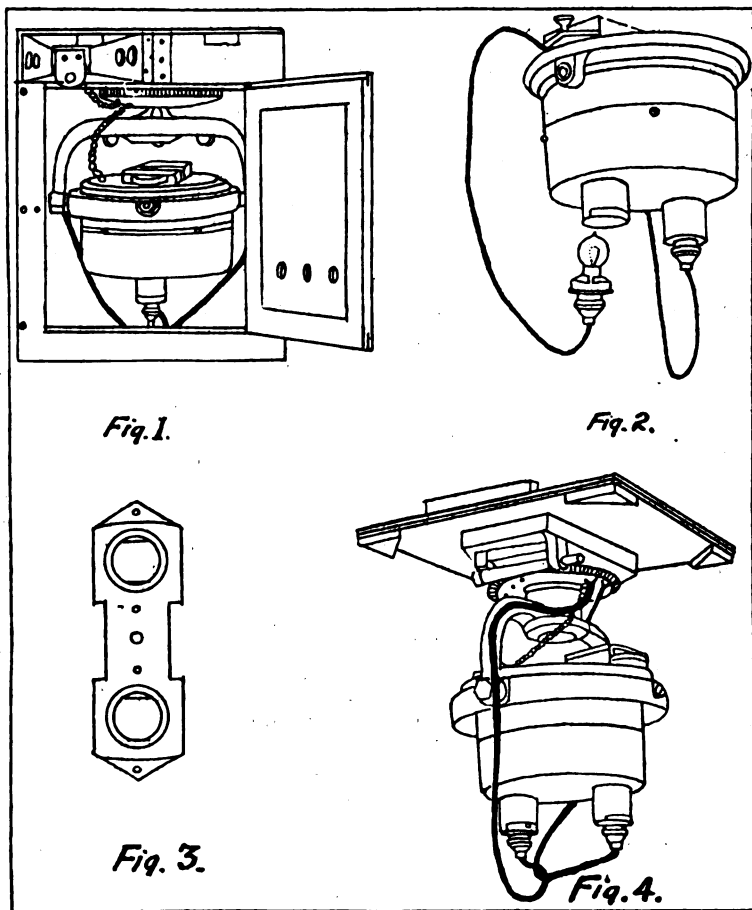

observing, fighting and keeping constant watch of the ever-increasing number of instruments. The increasing demands on the pilot emphasize the need of direct communication between him and his observer, in order to do away with time-robbing attempts at speech, signals and makeshifts.

For solving all these problems, there is now a new device, the "distant-compass" constructed by Carl Bamberg, Friedenau, and improved in 1918 by the Seaplane. Division and practically tested in comprehensive experiments and use at the front. Since this compass does not need to be in sight of the aviators and can be located far from all iron parts, it can be as



powerful as those used on ships. This compass is free from error down to the fraction of a degree and at least as reliable as those on large ships. The most favorable location on the ordinary type of aeroplane is from one to one and a half meters behind the rear seat in the fuselage, where the compass, enclosed in a wooden case (see Fig. 1), is protected from the wind and weather. The magnet system is the same as demonstrated its stability in the submarines. Its use on aeroplanes has greatly increased the accuracy of steering in comparison with the compasses formerly used, and, even while flying in clouds and bad weather, there were no harmful oscillations nor revolutions. Not much compensation is usually necessary, since in every type of machine it is possible to find a location entirely free from magnetic disturbances. The improvement thus obtained consists first in eliminating the compensation, which always requires an expert, and further, in fact that the directive power of the compass is not weakened by compensation magnets.

The magnet system of this compass is supported in the usual manner in a compass-vessel filled with alcohol and water. In the bottom of the vessel there are two lighting devices (each consisting of a small electric bulb and "condenser"), which throw two cones of light, sharply defined by the condensers, up through the compass liquid (Fig. 2). Both light-cones fall on two selenium cells (Fig. 3) which are applied in an air and water-tight cap to the vessel (Fig. 4). The electric resistance of the selenium is lessened by the illumination, so that, for instance, an electric current passing it can cause the pointer of an indicator to move. For the distant-compass, a special precision galvanometer with suitable scale serves as course-indicator (Kurszeiger), with radiumized marks and pointer. (Fig. 5.)

The magnet system carries a diaphragm which, in a certain position, simultaneously intercepts both light-cones and leaves both selenium cells dark. If now the compass vessel (Kompasskessel) is rotated about its vertical axis whereby the magnet system remains constantly in the north-south direction, one or the other cell passes out of the diaphragm shadow into one of the light-cones and the pointer moves to one side or the other. In this way, every swing of the compass vessel can be read on the course-indicator and, indeed, so that the amplitude of the oscillation of the pointer is proportional to the deviation from the course. This result is obtained by giving the proper oblique shape to the diaphragm, so as to cause a gradual strengthening or weakening of the illumination and therewith a proportional decrease or increase of electrical resistance in the selenium cells. This method of transmitting the compass indications differs from most other known methods in that it is accomplished without influencing the compass card of weakening its directive power.

Any seaplane or aeroplane provided with this device can be steered exactly in the desired direction, since every deviation from this direction causes a rotation of the compass vessel with reference to the magnet system, which is immediately indicated. The pilot only needs to turn the rudder right or left according to whether the pointer moves to the left or right. This device has two fundamental advantages over the ordinary compass. First, the pointer moves a relatively longer distance than the card of an ordinary compass, a deviation of  $15^\circ$  from the course, causing a motion of about 5 cm. in the former case to only 1 cm. in the latter case, making the accuracy of the reading about five times as great for the former. Second, this compass, like all the other instruments on the aeroplane, is read on a fixed scale by means of a mobile pointer and thus spares the aviator the special thought required, on all other instruments for reading the mobile card scale with reference to a fixed steering mark.

If the compass is rotated a certain angle, say  $65^\circ$ , with reference to the longitudinal axis of the aeroplane, then the new course, if flown according to the course-indicator, will evidently deviate  $65^\circ$  from the original direction, since one of the selenium cells receives the light and thereby brings the course-indicator to one side. until, by the turning of the aeroplane

itself  $65^\circ$ , it comes again into the shade of the diaphragm. At any time during flight, any desired new course can be established by turning the compass vessel the desired angle with reference to the longitudinal axis of the aeroplane. The compass vessel had for this purpose a suspension device which can be readily rotated by means of a worm gear (Fig. 4).

For this purpose, the compass is placed in the rear part of the fuselage or other iron-free location. The turning of the compass vessel, and with it the establishment of the course, is then effected by means of a flexible shaft (Fig. 7) which is within reach of the aviators and is turned by a

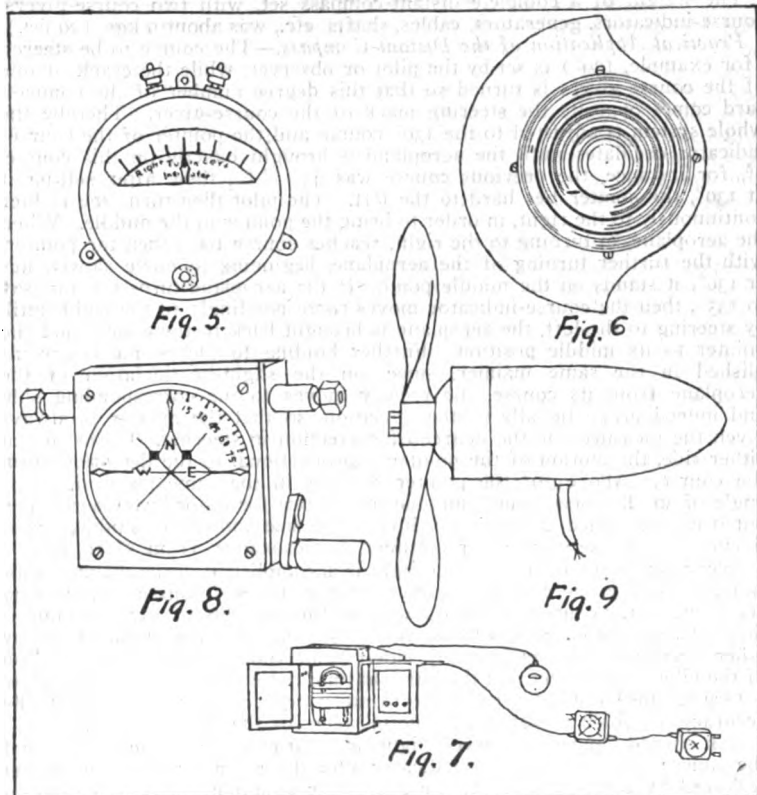

crank. By this shaft a compass card near the crank is simultaneously turned exactly the same angle as the compass vessel, so that on this course-giver (Kursgeber) (Fig. 8), the angle and thus the compass course can be read. Naturally, in such a system with a flexible shaft, several course-givers and course-indicators can be installed, for the pilot and observer and any other persons in any part of the aeroplane, who are thus enabled to observe and assist in the navigating.

The heat generated by the electric lamps prevents the freezing of the compass liquid, even in very cold weather. The minimum current required for the compass installation is about 10 watts. This current can be obtained by connecting the system with a source of electric current already on the aeroplane, but is usually supplied by a small airscrew double generator of

especial reliability (Fig. 9), specially constructed for this purpose, with an output of 40 volts 6 milliamperes for the indicator circuit, which flows through the selenium cells, and 8 volts, 2 amperes for the electric lamps, and weighs only 1.8 kg. (4 lbs.). The tension of the generator is kept constant between 3700 and 7500 r. p. m. by an automatic regulator according to the Sumner principle. The best location for the generator is in the air current from the propeller. The number of r. p. m. required for the work of the compass system was found in a test to be about half the r. p. m. of the engine.

The weight of a complete distant-compass set, with two course-givers, course-indicators, generators, cables, shafts, etc., was about 9 kgs. (20 lbs.).

*Practical Application of the Distant-Compass.*—The course to be steered (for example,  $130^\circ$ ) is set by the pilot or observer, while the crank of one of the course-givers is turned so that this degree number of the compass card comes opposite the steering mark of the course-giver. Thereby the whole system is adjusted to the  $130^\circ$  course and the pointer of the course-indicator oscillates until the aeroplane is brought exactly on this course. If, for instance, the previous course was  $45^\circ$  N.E., then, after setting it at  $130^\circ$ , the pointer lies hard to the left. The pilot then turns the rudder continuously to the right, in order to bring the pointer to the middle. When the aeroplane, in turning to the right, reaches course  $100^\circ$ , then the pointer, with the further turning of the aeroplane, beginning to move slowly, lies at  $130^\circ$ , it stands on the middle point. If the aeroplane turns too far, say to  $135^\circ$ , then the course-indicator moves correspondingly to the right until, by steering to the left, the aeroplane is brought back to the course and the pointer to its middle position. Further holding to the course is accomplished in the same manner, since, on the slightest deviation of the aeroplane from its course, the pointer moves to the corresponding side and indeed proportionally to the deviation, so that the aviator is always given the measure for the degree of correction in steering. Up to  $30^\circ$  on either side, the motion of the pointer is proportional to the deviation from the course. Above  $30^\circ$  the pointer remains in the same position. This angle of  $30^\circ$  has been found suitable in practice for an ordinary aeroplane, but it can be varied at will, according to the size and corresponding sensitiveness of the aeroplane (or airship), by resistance, from  $5^\circ$  to  $40^\circ$ .

Every change of course during flight is accomplished in the manner indicated by setting one of the course-givers for the new course and steering according to the course-indicators, without the necessity of any communication between the occupants by signs, notes, etc. Also the observer or any other occupant can, without any closer understanding, call the attention of the pilot to an object that the latter has not noticed, or accurately indicate a target, since the pilot has only to steer according to the pointer, the accuracy of which makes it possible to steer for the smallest goal.

If it should happen, in curved flight or great changes of the course, that the course set on the course-indicator should be exactly opposite to that followed by the aeroplane at the time (for example, set on the course-giver: East  $90^\circ$ , aeroplane flying west =  $270^\circ$ ), the course-indicator in this special case, when the difference is just  $180^\circ$ , stands in its middle position, which results from the two selenium cells being located at  $180^\circ$  apart. This position, however, hides no possibility of error, because it is immediately evident that likewise (following from the construction) the course-indicator swings in the opposite direction than when the aeroplane is flying on the course set. If the aeroplane, as assumed in the example, is flying west and turns only  $1^\circ$  to the right of this course, the pointer swings to the left and the pilot must therefore steer to the right. Thereby he continually goes further to the right from his false west course, for the pointer remains on the left until the aeroplane is again on the east course for which the course-giver is set. Only then is the pointer again in its correct middle position. The second and opposite middle position of the course-indicator makes it possible therefore for an aeroplane that has

deviated by a large angle (around  $180^\circ$ ) from its correct course, to be always shown the smaller angle and therefore the shorter way back to its correct course. Every aviator must therefore become accustomed to following the course-indicator blindly, then, whether in clouds or fog, even in battle, after completely losing his bearings, he will immediately return to his correct course, without danger of the compass whirling, even from the most violent motions of the aeroplane.

The sensitiveness of the pointer, which indicates deviations of fractions of a degree from the direct course, enables the aviator to fly straight ahead and horizontally in clouds and at night. Only this condition enables the use of aeroplanes for photogrammetric surveying which requires the holding of a straight line and further imparts genuine accuracy to observations from an aeroplane and from the earth, which unconditionally require straight lines, like speed measurements, etc. True, there already exists in the Drexler Gyroscope Indicator (*Kreiselsueranzeiger*) a highly sensitive instrument for facilitating direct flight, but its value is confined exclusively to the aerodynamic field, since it only shows whether, for the time being, the aeroplane is flying straight ahead or in a curve, and does not enable the holding of a single definite course, like the distant-compass course-indicator.

Furthermore, the distant-compass not only makes possible the general control of one's bearings, but also the accurate determination of compass, directions and variation, even without seeing the compass itself, because the card of the course-giver, as long as the aeroplane continues on the course set for it, always corresponds to the true magnetic compass card since the course-givers are always mounted parallel to the longitudinal axis of the aeroplane. A variation device attached to a course-giver is more convenient and utilizable for compass variations than when attached to the sensitive and mobile compass itself.

The advantages and possible applications of the distant-compass are so numerous that it has become one of the most important instruments for aircraft. This was also demonstrated by its adoption in 1918 for all former naval seaplanes, with the exception of combat aeroplanes, as well as for certain types of army aeroplanes. This device is a very important aid for commercial, as well as military aviation. By its advantages it increases both the safety and economy of aviation. The accuracy of course-steering, which the distant-compass has made many times greater than that hitherto attainable, lessens fuel consumption, facilitates unconditional reaching of one's goal even under the most trying circumstances, and diminishes the intellectual and nervous tension of the pilot, which is of especial importance in long distance commercial aviation.

It is not the purpose of this article to discuss the application of this invention to sea ships. The parallels are readily drawn. Even the farthest evolution possibilities open up favorable vistas. Thus, on a ship, there has been successfully substituted for the indicating instrument a relay enabling the compass to operate the rudder directly. Such a device, which has already been finished and tested, demonstrates the possibility of dispensing with the pilot and replacing him by an automatic and considerably more accurate steering-compass. The lateral steering of an unmanned aeroplane rests on the same principle.—By Walter Friedenburg.—*Translated for the National Advisory Committee for Aeronautics, by D. M. Miner.—Aerial Age Weekly, 29 August, 1921.*

COMPASS CONTROL MIGHT HAVE AVERTED DISASTER.—Commenting on the Alaska disaster with its toll of human lives, the *Shipping Register* observes that there is one feature of that wreck that has been overlooked in the official inquiry. At his hand, and absolutely free, the master of the *Alaska* had for instant use a service which would have told him within a few hundred yards his exact position. That is the compass control service of the United States Navy.

All that the captain of a ship has to do, at any point off the Pacific Coast of the United States, is to notify his wireless operator to send out a signal for compass control direction. In reply and within a few minutes the radio operator receives directions.

There is no excuse for ignoring this service. Had the *Alaska* inquired for angular position just before she struck she could not but have avoided the treacherous shore.—*The Nautical Gazette*, 3 September, 1921.

**RADIO SERVICE BETWEEN LONDON AND PARIS.**—From the French journal *Radioelectricité*, we learn that stations for regular communication between these two cities are located in Neuilly-Levallois, France, and Chelmsford, England. A high-frequency generator of 10 to 25 kilowatts is employed for sending. Signals are first recorded by perforation by means of a special machine upon a strip of paper and are then sent at about a hundred words per minute. The received messages are considerably amplified and are registered upon a fast rotating wax disk similar to that of a phonograph. For transcribing, the disk is revolved much more slowly to enable the operator to copy the message on a typewriter.—*The Scientific American*, 3 September, 1921.

**RADIO ABOARD AIRPLANE.**—In a recent issue of *Radioelectricité* there are described the various stages of the development of radio communication from and between airplanes. The first satisfactory operating set in French aviation contained a spark coil fed from a 20-volt storage battery. Later the heavy storage battery was superseded by a small air-screw-driven generator running at an average speed of 4500 r. p. m., and delivering 20 volts at 5 amperes. Finally, two types of air-screw-driven 900-cycle alternators were developed, differing only in weight and bulk from each other. Both are rated at 50 volts and 7 amperes at 4500 r. p. m. The machines contain a direct-connected exciter and a tooth-wheeled generator with no rotating windings. A rotary spark gap mounted on the main generator shaft is used on both types.—*The Scientific American*, 3 September, 1921.

**AHEAD IN RADIO TUBE WORK.**—"I was astonished to find that in wireless development Germany was ahead of us in some respects, especially in tube work," is the summary of two week's study here by Lee De Forest, the wireless inventor, who came here to sell the German rights of his wireless patents. Mr. De Forest has concluded arrangements with the second biggest German wireless corporation, the Huth Gessellschaft Fur, the Funkentelegraphie.

He is enthusiastic about what he has seen here in the way of wireless developments.

"The government wireless station at Königswusterhausen is remarkable," he said. He has 11 transmissions, all operating simultaneously. There is nothing like it in the United States. Königswusterhausen has 10-kilowatt transmission tubes, and is the largest tube station in the world, having larger and better transmission tubes than we have ever been able to make in America, though we invented and started that art. One reason is the extremely low cost of skilled labor, particularly expert glass blowers." Mr. De Forest, who left Berlin to-day for an unknown destination, presumably home, added:

"I am taking back with me some very novel ingenious apparatus which will be extremely interesting to the American radio art, particularly to amateurs, for receiving the broadcast service which the United States Government will shortly inaugurate. The German Government is far ahead of any other in the matter of broadcasting the news of the Stock Exchange, the weather report, etc. The German Government is now building in Berlin 1500 standardized receiving sets, which the government itself will place in various banks and business houses throughout Germany for the reception of this broadcast service. The government also proposes this

winter to send out from the Königswusterhausen station the music from the State Opera in Berlin, which will be heard all over Europe.

"The reception which I have had from all German scientists has been most delightful and cordial. They haven't hesitated to show me anything they had. The German wireless scientists expressed themselves as highly gratified at the reception Einstein received in America. I find working conditions in Germany for anyone engaged in research work far better than in the United States," De Forest added explaining his intention of soon returning to Germany to live and engage in wireless research experimental work.

"By the way," he said, "despite the much touted perfection of the anti-static receiving system in America by the Marconi Company, etc., I find the Service from Germany to the United States very frequently delayed and interrupted for hours, sometimes days. The best German wireless talent admits that the problem of overcoming static is still a long way from solution, either here or in America."—*The N. Y. Times*, 7 September, 1921.

**CONCRETE MASTS FOR RADIO.**—The Japanese Government is building a powerful radio station at Tokio, one striking feature of which is the reinforced concrete tower for supporting the aerial. The tower is 672 feet high, and of a round, tapering form. It measures about 50 feet in diameter at the base, and about 4 feet at the top. The structure is hollow, of course, with reinforcing bars throughout. The center hollow of the concrete tower is occupied by a steel stairway, which gives access to a balcony near the top, and to four other balconies. The tower was cast by means of a central framework of wood and outside wooden moulds, which were shifted upward as the casting progressed.—*The Scientific American*, 27 August, 1921.

**MR. MARCONI**, who has recently returned to London, announces that he has been for the last few weeks testing a new method of wireless reception developed by one of the company's engineers which has enabled him to receive continuously from the United States without being in any way interfered with by atmospheric disturbances which are particularly prevalent at this time of year, and more severe than usual in recent weeks in consequence of the abnormal spell of hot weather. Mr. Marconi regards this advance as of the greatest importance, for it enables a wireless telegraph service to be conducted, notwithstanding atmospheric disturbances, during the whole 24 hours and at high speed during the greater part of the time.—*The Engineer*, 19 August, 1921.

**RADIO WAVE BAND FOR EVERY COUNTRY.**—American backing of wireless telephony was the big thing of the near future revealed in the International Wireless Conference which closed this evening after having been in session for two months.

The American delegation, headed by Major General George O. Squier, Chief of the Signal Corps of the United States Army, came to Paris with a definite program. Most of this program is said to have been adopted, although the conclusions of the conference will be kept secret until they are presented to the various governments by their delegates.

The principal contention of the Americans was that certain bands of waves should be reserved for wireless telephony. This was opposed by the Europeans, as they considered that telephony would occupy too great a part of the usable waves. With the backing of Japan, however, the American viewpoint finally was adopted. The Americans pictured presidents and premiers of the future speaking directly among nations and emphasized the overwhelming importance of wireless telephony in supreme moments, as well as the necessity for aiding in its development.

The activity of the Americans in "selectivity" of the development of the equivalent of the private line in wireless, as opposed to the present "party line," where anyone may listen in on a conversation, met with recognition by the conference.

Among the fourteen principal questions with which the conference dealt and adopted was a recommendation by the Americans that certain waves be assigned in each country, with treaty provisions limiting each country to the use of instruments adapted to those wave lengths, so that the result would be secret wireless.

It was agreed to apportion these waves, probably designating each group by color, so that each country might have the exclusive use of certain colored waves.

It was the opinion of the conference that wireless never would supersede submarine cables, and it advocated the extension of cable facilities. The speedy elimination of state interference, which now is so serious to wireless, was predicted.

The conference emphasized the need of governments interesting themselves in wireless telephony.

The report of the conference, which will fill seven mail bags, offers solutions for problems that were not solved at the Washington Communications Congress. It is believed that this report will be submitted to the Washington Government in November.

General Squier will return to the United States in September to render his personal report. The delegates are leaving to-morrow to visit the French wireless stations.—*The N. Y. Times*, 23 August, 1921.

**TRANSMITTING PHOTOGRAPHS AND DRAWINGS BY RADIO.**—For some time an interesting series of experiments has been under way at the large radio station at Annapolis, Md., having as the object the transmitting of photographs and drawings by radio to a receiving station at Malmaison, near Paris, France. This series marks but another step in the development of the Belin system of photographic transmission, which was described in our columns last November when M. Edouard Belin succeeded in transmitting photographs between St. Louis and New York City over the usual telegraph lines. This time, however, the transmission is by high-power radio, which obviously introduces a number of complications.

The Belin principle is quite simple and ingenious. The photograph to be transmitted is transferred on to a brass cylinder and so treated that its image is reproduced in high relief. The cylinder is then placed in the transmitting unit, where its irregular surface presses against the stylus of a sensitive microphone. The irregular surface varies the pressure on the microphone and hence its electrical resistance, and in that manner modulates an electric circuit in direct proportion to the photographic values. A special synchronizing device sends out a synchronizing signal at regular intervals.

The receiving side consists of a highly sensitive Blondel oscillograph, which carries a tiny mirror on its strings. The strings are placed in oil so as to make them dead-beat, while the mirror swings about on its vertical axis. A source of light casts its rays on the mirror, which in turn reflects them on to a screen of graduated transparency, behind which is a drum covered with a piece of sensitized paper. This drum turns in perfect synchronism with the transmitting drum through the means of the synchronizing signal and special mechanism, which our available space does not permit us to describe here. As the modulated current or signal strength reaches the receiving end, the tiny mirror is deflected more or less so that its beam falls on any part of the graduated screen that corresponds with the image at the transmitting end. In this manner more or less light falls on the sensitized paper of the cylinder, which is then developed in the usual manner.

A simpler transmitter and receiver arrangement calls for a plain make-and-break device at the transmitting end, operated by the surface irregularities, and no graduated screen at the receiving end. This arrangement is for the transmission of drawings, cartoons, facsimile type matter or handwriting, maps, and all other matter in plain black and white, without the half-tone gradations of the usual photograph.

In the present experiments, which are being conducted by Messrs. Marcel Touly and Gaston Johanneau of M. Belin's staff, only plain black-and-white transmission has been undertaken thus far. The difficulties encountered have been mostly in the way of getting the Belin apparatus to modulate the powerful output current of the big arc generator at Annapolis. Over sixty relays have to be actuated in order to handle the transmitting current, and it stands to reason that in this large number of relays some mechanical, electrical and other troubles must arise. The main difficulty is to reduce the lag as much as possible, so that one impulse will not be piled atop the preceding one.

Facsimile handwriting and printed matter have been transmitted by radio to the French receiving station. In fact, it is believed that the greatest application of M. Belin's remarkable system will perhaps be in the direction of greater accuracy, and the facsimile transmission of messages. Column after column of newspaper print or typewritten matter can be transmitted by wire or wireless, and received without a single deviation from the original. Furthermore, because of the high speed of this transmission, it will greatly increase the traffic over our present systems of communication.—*The Scientific American*, 3 September, 1921.

#### ORDNANCE

FOR "ALABAMA" BOMB TEST.—New weapons of aerial warfare will receive an initial test when the army air service conducts its next bombing operation, a night attack on the old battleship *Alabama*. The present plan is to stage the attack about September 15, probably at the scene of the recent tests upon the former German craft, off the Virginia Capes.

A "light barrage" composed of giant aerial flares, each of more than 200,000 candlepower, will be one feature of the attack. Army engineers have submitted such enthusiastic reports on this weapon that larger flares, estimated to be equal to 1,000,000 candles, have been placed under construction.

Giving a greenish-white light, literally "brighter than day," the flares to be used in the *Alabama* test will illuminate an area of five square miles, and, expert fliers say, should enable the aviators to obtain greater accuracy than in daytime.

The flares are attached to a parachute of white silk, which reflects the light downward with sufficient intensity, it is believed, to blind the officers and gunners of the ship under attack, so as to demoralize any plan for defence, while keeping the upper air reaches shrouded in gloom.

Just before the armistice was signed flares of 2000 candlepower were perfected by the ordnance branch of the army air service. They were equipped with 18-foot parachutes, which kept them aloft while the magnesium burned for a period of from seven to eleven minutes. No opportunity was afforded for a test of these against the enemy, however.

Although disappointed that they cannot have the *Alabama* equipped for battle, with radio control, as they had hoped, the army fliers are exerting every effort to conduct the bombing tests with war conditions as nearly simulated as possible.

It will not be the object of the army pilots to see how quickly they can sink the *Alabama*, officials said to-day, but rather to try out special gas and non-extinguishable phosphorous bombs on her, as well as to ascertain the effect of small demolition bombs. Bombs up to 4000 pounds each may be used.



The *Alabama* is at Philadelphia, and practically ready for delivery to the air service.—*The N. Y. Times*, 2 September, 1921.

**NEW TORPEDO WILL RUN WITHOUT WAKE.**—An invention which will seriously complicate naval warfare programs is being developed by more than one sea power, including the Japanese. It is the trackless torpedo. It is a torpedo shooting to its mark without leaving a tell-tale wake on the surface, such as is caused by the air bubbles set up by the swift passage of the ordinary torpedo through the water.

The bubbling wake often enabled ships being attacked to avoid the deadly blow by prompt alteration of their courses. To realize what the invention means, one has only to study the reports of naval actions during the war and to read again the stories of those under torpedo fire. Nearly all of them mentioned the "white track of the torpedo."

At the battle of Jutland perhaps a dozen of Admiral Jellicoe's ships were able to save themselves from torpedoes by a timely touch of the helm as soon as the streak of bubbles betrayed the approach and direction of the torpedo. The same thing occurred before that at the battle of Dogger Bank when Admiral Beatty's flagship, *Lion*, avoided torpedoes by changing its course.

**Germans Knew Handicap.**—The Germans claimed to have fired during the war 5000 torpedoes from U-boats, with 50 per cent hits, and if they had used trackless torpedoes the percentage would have been 80 hits at least. Admiral Jellicoe in his book says: "When the experience of Jutland showed that under favorable conditions the track of German torpedoes was visible for some distance, great care was taken to avoid all mention of this in dispatches, so that future use could be made of the fact. But the Germans knew this handicap and had already devised a type of torpedo which would run under the surface without leaving a discernible track, and this was in the experimental stage at the time of the armistice."

A naval expert is able to give to the public the first details of this weapon and its development. The trackless torpedo is propelled by electricity and not compressed air, and therein lies the secret. With the old torpedo the air was exhausted through the propeller shaft and rose to the surface in large bubbles, which made a track. With electric propulsion there is no exhaust, and consequently no conspicuous track.

**Used Special Batteries.**—The Germans tried out, late in 1918, a torpedo of 20.18 inches which would travel at a speed of 28 knots, with a range of 2000 yards. This is considerably under the range of the air-driven models, but is sufficient to do the work in most cases. Special storage batteries were manufactured by the Accumulator Fabrik, of Berlin, and a special type of light high speed motor was designed by the Siemens-Halske firm. The trials were very successful. The torpedo ran straight and true, without a perceptible track, the first notice of the approach being given by the explosion as it hit.

The early model was regarded as a beginning, and the Germans were working on one of 25-inch diameter with a range of 10,000 yards, which they figured would increase the efficiency of the U-boats 50 per cent.

The secret was well kept, but members of the allied naval missions scented it out. Previously, however, trackless torpedoes had been designed by France and England, but not built. The Japanese are now known to be giving much attention to this subject and are reported to have produced at the Kure arsenal electric torpedoes with a speed of 30 knots and a range of 6000 yards.

Experts say that the new torpedoes will exert an influence upon naval tactics quite as much as upon torpedoes themselves. A British flag officer who fought at Jutland said:

**No Longer Novelty.**—"The trackless torpedo isn't a novelty in the sense that it was unforeseen or unexpected. We have always known it to be

inestimable in value, but happily for us the Germans were late with it. Had they used such torpedoes early in the war our naval mercantile losses might have been doubled, and we certainly would have lost more ships at Jutland."

Among the American ships attacked and saved by the wake of torpedoes were the *Florida* and the *Delaware* on February 8, 1918, and the *Arkansas* July 28, 1918. In each of these cases the torpedoes were seen coming and were avoided.—*The N. Y. Herald*.

**HEAVY MACHINE GUNS FOR NEW BATTLE PLANE.**—Machine guns of a new type, much heavier than any yet used, will protect the giant Siddeley-Cirkis battle plane, which is carrying out trial flights in the neighborhood of Aldershot. They will be mounted in a kind of gallery.

The machine is very fast, considering its size. It weighs nine and one-half tons, and its twin engines develop 900 horsepower. It is so powerful that it will be possible to dispense entirely with the protecting airplanes, which in the past have had to accompany big machines. The pilot and observer travel in the nose of the airplane, and are protected by the circle of machine guns from attack from almost any direction.—*The N. Y. Times*, 1 September, 1921.

### MISCELLANEOUS

**ARTIC EXPLORATION BY AEROPLANE.**—A natural development of the greater reliability of the aeroplane is the decision of an American physicist, Mr. E. F. Naulty, to make a flight over the North Pole in September. The machine which has been specially constructed for the trip, has been designed to carry fuel for a 50 hours' continuous flight at a maximum speed of 100 miles an hour. Three men will accompany the aviator. The route to be followed will be from Point Barrow, in Alaska, *via* Spitzbergen and North Cape, and it is hoped to make several landings during the flight, although it is believed that the machine would be capable of covering the whole distance of 1500 miles between Point Barrow and Spitzbergen in a continuous flight. Plans are in the making to continue the flight from North Cape *via* Scandinavia to London.—*Engineering*, 5 August, 1921.

**PSYCHOLOGY AND THE EDISON TESTS.**—That the general public should have missed the point of the Edison tests was perhaps inevitable; but one expects better things from a Harvard professor of psychology. Dr. Roback declares that they were merely a test of memory, and of a memory "for things which are useless to mankind in common." It would be more sensible he says, to train a boy in the use of a library of reference books and then set about testing his "brain power."

The Edison tests were intended to measure, not knowledge nor yet mental training, but the subject's "contacts with actuality." A man's mind may be a storehouse of important facts and an instrument of great subtlety and power in the use of those facts, and yet be wholly of the detached and scholastic type. What Mr. Edison was after was the man of the seeing eye and the human touch—the man whose being has a thousand antennæ bringing him news of a world about him. Such antennæ are valuable in the foreman and shop manager, making him vividly alive to his human and material environment. To the inventor and technical expert they are indispensable.

The tests gave Mr. Edison precisely the results he wanted, and he is continuing to use them. They tell him which candidates are and which are not acutely impressionable and retentive of stimuli from without. They are a new and significant phenomenon in the way of examination, and of precisely the kind that ought to interest deeply a professor of psychology.—*The N. Y. Times*, 10 August, 1921.

**RADIUM IN INDUSTRY.**—Radium, the most mysterious and most powerful of all discovered sources of energy, has now been linked with the safety movement, and will lend its inexhaustible power to the prevention of avoidable accidents. The power of radium was made known only a few years ago through the discoveries of Mme. Curie who recently returned to France after a tour of this country.

Radium's rôle in industry as a life saver is important. The great mass of accidents in factories, in mines and in other industrial institutions where darkness is a creator of danger, are being eliminated through the newest invention of science—undarkradium luminous material.

Power-line switches, where fumbling might mean electrocution to the operator, are now illuminated with radium. Gauges—high pressure, steam and water electric switches, fire alarms and fire extinguishers are made visible through the magic of radium.

While radium is the most valuable element in the world—a gram of radium, which is about a thimbleful, cost \$120,000—it is so powerful when mixed with other materials that even the most minute particle is effective in making material self-luminous for years. It is this quality which makes radium luminous material commercially possible.

When other lights fail, when fuses blow out, wires break down, radium will glow dependably, without danger of explosion or of burning. The employment of radium to help solve our medical industrial problems of life-safety is as yet in the first stages of its development. What the future will bring, no one knows.—*The N. Y. Times*, 28 August, 1921.

**SECRET OF GERMANS DIVINED BY CHEMIST.**—Dr. William Henry Nichols, a noted manufacturing chemist and Chairman of the Board of Allied Chemical and Dye Corporation, announced yesterday at the sixty-second meeting of the American Chemical Society in this city that his company, through the ingenuity of American chemists, had duplicated one of the dearest secrets of the Germans—that of manufacturing nitrogen products from the nitrogen of the air.

The chemist sent out the announcement that the new method was being operated on an industrial scale and that the country could be virtually independent of the Chilean nitrates formerly indispensable in the manufacture of explosives, dyestuffs and fertilizer. The Germans used a similar process on a vast scale during the war.

"This process is the extraordinary 'fixation' of atmospheric nitrogen and 'synthetic production' of nitric acid and nitrates generally which have so greatly interested chemists and chemical manufacturers during the last few years," said the announcement. "Although Germany succeeded in doing it during the war—indeed, it is said that without it she could not have continued the war for six months—the accomplishment is an entirely new one outside of Europe, and marks an important step in the progress of the American chemical industry."—*The N. Y. Times*, 8 September, 1921.

#### CURRENT NAVAL AND PROFESSIONAL PAPERS

Tactical Organization and Employment of Anti-Aircraft Searchlights. *Journal of the United States Artillery*, August, 1921.

Some Technical Problems in Aeronautics. *Mechanical Engineering*, August, 1921.

Internal Combustion Engines in Marine Service. *Journal of the Franklin Institute*, August, 1921.

A Course-Setting Bomb Sight. *The Engineer*, 19 August, 1921.

Locating Faults in Direct-Current Armatures—Coils and Windings. *Power*, 6 September, 1921.

Airplane Bombing. *Army Ordnance*, July-August, 1921.

Improvements in Methods of Fatigue Testing. *The Engineer*, 12 August, 1921.

# NOTES ON INTERNATIONAL AFFAIRS FROM AUGUST 10 TO SEPTEMBER 10

PREPARED BY

PROFESSOR ALLAN WESTCOTT, U. S. Naval Academy

---

## WASHINGTON CONFERENCE

**FINAL ACCEPTANCE OF POWERS.**—The formal invitations issued by the United States Government for a conference on limitation of armaments and on Pacific problems were accepted by all the nations included. China's acceptance, published on August 18, took special note of the fact that China was to appear on an equality with other powers. The British note, received on August 22, expressed the hope that the conference, approached "in a spirit of courage, friendliness, and mutual understanding," would achieve far-reaching results. The reply from Tokio, published on August 24, again referred to preliminary negotiations for limiting the scope of discussions regarding the Far East. A despatch from Tokio on August 31 stated that the Japanese would insist on excluding from the agenda the following: first, the Kwang-tung leased territory; second, the operation of the Manchurian railway; third, Kiao-chau, which will be returned to China; and fourth, the question of Yap.

Premier Lloyd George, speaking in Parliament on August 18, suggested that "if the alliance with Japan could emerge into a greater understanding with Japan and the United States on all problems of the Pacific, that would be a great event which would guarantee the peace of the world." He added that the Imperial Conference had agreed that the British naval force should at least equal any other.

**AMERICAN DELEGATES.**—Secretary Hughes was made the head of the American delegation for the conference in Washington, and Senator Lodge was named as a second member. In a letter on September 7, President Harding indicated that only four delegates would be named, Mr. Elihu Root and Senator Underwood completing the number.

**PAN-AMERICAN BUILDING TO BE USED.**—Secretary Hughes on August 26 accepted the offer of the Pan-American Building for the meeting place of the Washington Conference. The army and navy and other government buildings will also be used for offices of the visiting delegations.

Upon a rumor that French would not be recognized as an official language at the conference, Premier Briand declared to the French Academy on August 24 that he had received assurances to the contrary, and that the

French Government could not under any circumstances take part in a conference in which the French language was not recognized. The statement of President Wilson in 1919 was recalled in this connection; advocating the recognition of English as an official language together with French, he referred to English as "the diplomatic language of the Pacific."

**NEGOTIATIONS OVER YAP.**—While negotiations between the United States, Japan and other Allied powers were progressing, no settlement of the Yap cables question had been reached at the close of August. From Tokio came a report that the probable basis of agreement would allow Japan to retain the mandate over the island, give the United States control over the cable from Yap to Guam, and recognize Holland's interest in the cable between Japan, Yap, and Mendanao (Dutch).

### PEACE TREATY WITH GERMANY.

**TREATY SIGNED IN BERLIN.**—The peace treaty between Germany and the United States was signed in Berlin on August 25 by Dr. Friedrich Rosen, German Foreign Minister, and Ellis Loring Dresel, the American Commissioner. The treaty is in accord with the peace resolution adopted by Congress on July 2, 1921, and the preamble repeats the parts of this resolution relating to Germany. The remainder of the treaty follows:

*Article One.*—Germany undertakes to accord to the United States, and the United States shall have and enjoy, all the rights, privileges, indemnities, reparations or advantages specified in the aforesaid joint resolution of the Congress of the United States of July 2, 1921, including all the rights and advantages stipulated for the benefit of the United States in the Treaty of Versailles which the United States shall fully enjoy notwithstanding the fact that such treaty has not been ratified by the United States.

*Article Two.*—With a view to defining more particularly the obligations of Germany under the foregoing article with respect to certain provisions in the Treaty of Versailles, it is understood and agreed between the High Contracting Parties:

(1) That the rights and advantages stipulated in that treaty for the benefit of the United States, which it is intended the United States shall have and enjoy, are those defined in Section One, Part Four, and Parts Five, Six, Eight, Nine, Ten, Eleven, Twelve, Fourteen and Fifteen. The United States, in availing itself of the rights and advantages stipulated in the provisions of that treaty mentioned in this paragraph will do so in a manner consistent with the rights accorded to Germany under such provisions.

(2) That the United States shall not be bound by the provisions of Part One of that treaty, nor by any provisions of that treaty including those mentioned in Paragraph One of this Article, which relate to the Covenant of the League of Nations, nor shall the United States be bound by any action taken by the League of Nations, or by the Council or by the Assembly thereof, unless the United States shall expressly give its assent to such action.

(3) That the United States assumes no obligations under or with respect to the provisions of Part Two, Part Three, Sections Two to Eight inclusive of Part Four and Part Thirteen of that treaty.

(4) That, while the United States is privileged to participate in the Reparation Commission, according to the terms of Part Eight of that treaty, and in any other commission established under the treaty or under

any agreement supplemental thereto, the United States is not bound to participate in any such commission unless it shall elect to do so.

(5) That the periods of time to which reference is made in Article 440 of the Treaty of Versailles shall run with respect to any act or election on the part of the United States from the date of the coming into force of the present treaty.

*Article Three.*—The present treaty shall be ratified in accordance with the constitutional form of the High Contracting Parties and shall take effect immediately on the exchange of ratifications, which shall take place as soon as possible at Berlin.

*In witness whereof, the respective plenipotentiaries have signed this treaty and have hereunto affixed their seals.*

*Done in duplicate in Berlin, this 25th day of August, 1921.*

The treaty was framed with the aim of securing for the United States all rights and privileges acquired by other nations in the Versailles Treaty, so far as desirable, while freeing her from responsibility in connection with matters of European concern. The treaty explicitly confirms the right of the United States to take part in the disposition of Germany's overseas possessions on an equality with other allied powers. From France came the suggestion that the treaty raised the need of another agreement between America and the Allies, giving American sanction to the disposition of European affairs made in the Treaty of Versailles.

**AUSTRIAN AND HUNGARIAN TREATIES.**—A peace treaty with Austria, based on the Treaty of St. Germain much as the German treaty was based on that of Versailles, was signed in Vienna on August 24. Negotiations for a similar treaty with Hungary were also reported in progress.

## LEAGUE OF NATIONS

**LEAGUE COUNCIL ACTS IN SILESIA.**—By a vote of the Interallied Council on August 12, following failure to reach an agreement on the Silesian problem, its settlement was left to the Executive Council of the League of Nations, the Allied Powers binding themselves to abide by the League decision. Ambassador Harvey, who was present, did not vote, but stated that since the matter was one of distinctly European concern, the President of the United States would hear with relief of its being referred "to a body with which the United States is not associated."

After discussing the Silesian question in an extraordinary session on August 29, the League Council turned it over to a special committee composed of Paul Hymans of Belgium, V. K. Wellington Koo of China, Count Quinones de Leon of Spain, and Dr. Gastao de Cunha of Brazil.

In view of possible dismemberment of Upper Silesia, both Poles and Germans of that region got together in an agreement on August 17, pledging cooperation in the interest of their "common motherland," and favoring an undivided Silesia whether awarded to Poland or Germany.

**MEETING OF LEAGUE ASSEMBLY.**—The second Assembly of the League of Nations met at Geneva on September 5. Dr. Koo of China opened the

session as temporary president and Foreign Minister A. Van Karnebeek of Holland was elected permanent president. Of the 48 countries in the League 39 were represented; the delegates of Peru, Hayti, and Costa Rica were reported on the way; and Argentina, Guatemala, Nicaragua, Panama, Honduras, and Salvador sent no delegates. The five new nations represented were Austria, Bulgaria, Albania, Finland, and Luxembourg.

**TACNA-ARICA DISPUTE INVOLVES MONROE DOCTRINE.**—The League Assembly was put in a difficult position by the appeal of Bolivia that the League consider whether it could properly take up the dispute between Bolivia and Chili over Bolivia's claim for an outlet to the sea. By a treaty in 1904 between Bolivia and Chili the former country was shut off from the sea. Bolivia has demanded that the treaty be revised, claiming a just settlement would give her an outlet. Chili insisted that the question should not come before the League in any form, first on the ground that the League could not properly engage in the revision of treaties, and second, on the ground that the Monroe Doctrine prevents non-American countries from interference in questions exclusively affecting the New World.

**NEW AMERICAN MANDATE NOTE.**—At the request of the Allied Powers Secretary Hughes in August formulated a new note on mandates setting forth in detail the views of this country regarding both Class A and Class B mandates. The note reiterated the American demand for an "open door" to all powers (not merely those in the League of Nations) in all mandate territories, and the right of the United States to be consulted in all questions regarding mandates. It insisted that even though the United States did not declare war on Turkey, it aided in her defeat and therefore should have an equal voice with other powers in the disposal of former Turkish territories.

**FORMATION OF WORLD COURT.**—For the 11 judgeships in the proposed world court, 91 names had been put in nomination when the League Assembly met at Geneva. Among the more prominent American nominees were Elihu Root, James Brown Scott, and John Bassett Moore. Mr. Root declined to be a candidate on account of his age. Last year the major powers blocked the principle of compulsory jurisdiction. Unless this is adopted, no case can be brought before the court without the consent of both nations concerned.

## GREAT BRITAIN AND IRELAND

**IRISH REPLY UNFAVORABLE.**—The Irish republican parliament or Dail Eireann met on August 16 to consider the terms presented by Premier Lloyd George after conferences with Mr. de Valera in London. Following secret sessions of the Dail Eireann, Mr. de Valera sent a note on August 24 in which he stated that the terms had been rejected by a unanimous vote. The note declared that "geographical propinquity" could not, as the British minister insisted, "impose the condition of the subordination of Ireland's rights to Great Britain's strategic interest." If this principle

were followed, according to the note, no small nation such as Holland or Belgium would have the right to exist.

In reply Premier Lloyd George kept to fundamental principles. He declared that the terms were liberal beyond all precedent, were so regarded by the whole civilized world, and offered Ireland a partnership in the British commonwealth of free nations, with government by consent of the governed. He cited Lincoln's words on the impossibility of separating the North and the South, and quoted the Irish patriot Grattan who wrote, "the ocean protests against separation and the sea against union."

The final verdict of the Dail Eireann, contained in a note published on September 4, declared that the Irish people by an overwhelming majority had decided in favor of independence; that the British proposals offered Ireland "a status definitely inferior" to that of other British dominions, "dividing her into two artificial states, each destructive of the other's influence in any common council, and both subject to military, naval, and economic control by the British Government"; and finally, that Ireland was willing to continue negotiations only on the principle of "government by consent of the governed."

**BRITISH PROPOSE ANOTHER CONFERENCE.**—After a meeting in Scotland the British Cabinet on September 7 sent a reply to Ireland declaring that the principle of government by consent of the governed could not be taken to mean the right of any body of people to set up any form of government it pleased, or the right of Ireland to renounce its allegiance to the Crown. The reply closed by calling for a definite answer whether or not discussions were to continue and suggesting September 20 as the date for a conference at Inverness, Scotland.

**BELFAST RIOTING.**—At the close of August, disturbances were renewed between Orange and Sinn Fein factions. Snipers on both sides shot down opponents in the streets. On August 31 there was a toll of 15 killed and scores wounded. Order was restored by reinforcements of troops.

### GERMANY

**CURB ON REACTIONARIES.**—At the end of August the German Government issued decrees prohibiting meetings, processions, demonstrations, and publication of periodicals likely to encourage seditious movements, and started a vigorous campaign against monarchist opposition. Several anti-republican journals were suppressed. On August 31 there was a demonstration of over 100,000 members of the Social Democratic, Independent Socialist, and Communist parties. The action of the republican government on the whole increased its strength and prestige, with a rallying of all moderate elements, including the German People's party, behind the government and in support of execution of the treaty terms. Herr Stresemann, leader of the People's party, pledged support for the republican government against "violent overturn."



**ERZBERGER ASSASSINATED.**—On August 26, Matthias Erzberger, German Centrist politician, was shot to death by two assassins while he was walking with a companion in the Black Forest. Erzberger, after having been driven into retirement by the attacks of his opponents, had planned to reenter politics in support of the Wirth government.

### AUSTRIA

**AUSTRIAN OCCUPATION OF BURGENLAND RESISTED.**—The march of 8000 Austrian troops into the Mattesdorf district of Burgenland, assigned to Austria by the peace settlement, was resisted at the close of August by a large body of irregular Hungarian forces under Captain Hejas and other insurgent leaders. The advance of Austria was halted in the expectation of pressure upon Hungary by the Allied Powers.

**AMERICAN AID URGED.**—Paris, September 4.—Samuel Untermyer is the latest to urge that the United States remit Austria's debt for such a period as will give that unfortunate country opportunity to recover. Eight months ago the Allied Powers, through the Finance Committee of the League of Nations, began work in this direction, each promising that it would remit all claims for fifteen or twenty years, and the State Department was asked if the American Government would take a similar step with regard to the \$22,000,000 which Austria owes America on account of food relief work.

Conditionally on America's replying in the affirmative, the League's Finance Committee worked out a scheme for the advancing of private loans to Austria on her national securities and with a certain control over her expenditures. That scheme has, however, never become possible, because no reply has been received from the American Government to the proposal of the committee. Some weeks ago the Council of Ambassadors was asked to approach the State Department to see if it could draw a reply; but since then nothing has been heard of the matter.—*N. Y. Times*, 5 September.

### RUSSIA

**AMERICAN RELIEF AT WORK.**—On August 18, Secretary Hoover, as head of the American Relief Association, was informed that an agreement had been signed at Riga by the American representative, Mr. Walter Lyman Brown, and Maxim Litvinoff, the Soviet envoy. By the terms of the agreement, the American organization secured complete control of the distribution of relief at all points in Russia. This differed from the arrangement made by Dr. Nansen on behalf of Allied relief organizations, which turned over the distribution of supplies to the Soviet Government.

At the close of August the All Russian Famine Commission headed by Maxim Gorky was dissolved, some of its members arrested, and its work taken over by the Soviet authorities. The latter claimed that certain members of the Gorky Commission planned to carry on anti-Soviet propaganda outside of Russia.

### NEAR EAST

**ALEXANDER ASCENDS JUGOSLAV THRONE.**—Following the death of King Peter of Yugoslavia, his son Alexander ascended the throne and on August

22 issued his royal proclamation recalling the great work of his father in the unification of the Slav peoples, and guaranteeing the constitutional rights and privileges of his citizens.

**GREEK OFFENSIVE SUCCESSFUL.**—Through August and early September the Greek advance against Turkish Nationalists in Asia Minor met with continued success. The Turks evacuated Ismid on August 17. At the close of August the Greeks were in a 40-mile front before the last defenses of Angora east of the Sakaria River.

On August 10 the Allied Supreme Council decided to throw aside the Sévres Treaty and let the Greeks and Turks fight it out. The Allies declared strict neutrality, while permitting private traffic in arms with both belligerents, and taking measures to maintain control of the Straits.

### LATIN AMERICA

**PANAMA SURRENDERS TERRITORY.**—On August 18, Secretary of State Hughes sent a note to Panama announcing that the United States Government had suggested to Costa Rica that it occupy, at once, the territory assigned it by the Loup award. At the same time a battalion of marines was sent to reinforce American troops in the Canal Zone. Finding that it was the intention of the American Government to prevent hostilities in the disputed area, Panama ordered the evacuation of Coto and it was peacefully occupied by the Costa Rican authorities. In a parting message, Foreign Minister Garay of Panama, special envoy in Washington, complained of the injustice of the American action in forcing the peaceful settlement.

According to the Port Anderson Treaty between Costa Rica and Panama, one Costa Rican, one Panamanian, and two American Commissioners were to be named to lay down the boundary line in accordance with the White award. According to Chief Justice Taft named Prof. J. F. Hayford of Northwestern University and Prof. O. W. Leland of Cornell as the American engineers. It was regarded as probable that the line would be laid down, even if a representative of Panama were not named.

**FAVORABLE MEXICAN OIL RULING.**—On August 30 the Mexican Supreme Court handed down a decision debarring Mexican authorities from denouncing oil rights held by the Texas Oil Co. prior to May 1, 1917. This decision apparently established definitely the non-retroactive character of Article 27 of the Mexican Constitution providing for the nationalization of petroleum deposits.

President Obregon on September 1 declared a treaty with the United States "neither possible, convenient, nor necessary." As a matter of fact, the court decision lessened the need of further treaty guaranties.

A conference between American oil officials and the Mexican Government concluded on September 3 with an agreement regarding the collection of the new export tax and resumption of oil exportation.

## SPECIAL NOTICE

### NAVAL INSTITUTE PRIZE ARTICLE, 1922

A prize of two hundred dollars, with a gold medal and a life-membership (unless the author is already a life member) in the Institute, is offered by the Naval Institute for the best original article on any subject pertaining to the naval profession published in the PROCEEDINGS during the current year. The prize will be in addition to the author's compensation paid upon publication of the article.

On the opposite page are given suggested topics. Articles are not limited to these topics and no additional weight will be given an article in awarding the prize because it is written on one of these suggested topics over one written on any subject pertaining to the naval profession.

The following rules will govern this competition:

1. All original articles published in the PROCEEDINGS during 1921 shall be eligible for consideration for the prize.

2. No article received after October 1 will be available for publication in 1921. Articles received subsequent to October 1 if accepted, will be published as soon as practicable thereafter.

3. If, in the opinion of the Board of Control, the best article published during 1921 is not of sufficient merit to be awarded the prize, it may receive "Honorable Mention," or such other distinction as the Board may decide.

4. In case one or more articles receive "Honorable Mention," the writers thereof will receive a minimum prize of seventy-five dollars and a life-membership (unless the author is already a life member) in the Institute, the actual amounts of the awards to be decided by the Board of Control in each case.

5. The method adopted by the Board of Control in selecting the Prize Essay is as follows:

(a) Prior to the January meeting of the Board of Control each member will submit to the Secretary and Treasurer a list of the articles published during the year which, in the opinion of that member, are worthy of consideration for prize. From this a summarized list will be prepared giving titles, names of authors, and number of original lists on which each article appeared.

(b) At the January meeting of the Board of Control this summary will, by discussion, be narrowed down to a second list of not more than ten articles.

(c) Prior to the February meeting of the Board of Control, each member will submit his choice of five articles from the list of ten. These will be summarized as before.

(d) At the February meeting of the Board of Control this final summary will be considered. The Board will then decide by vote which articles shall finally be considered for prize and shall then proceed to determine the relative order of merit.

6. It is requested that all articles be submitted typewritten and in duplicate; articles submitted written in longhand and in single copy will, however, receive equal consideration.

7. In the event of the prize being awarded to the winner of a previous year, a gold clasp, suitably engraved, will be given in lieu of the gold medal.

By direction of the Board of Control.

F. M. ROBINSON,  
*Commander, U. S. N., Secretary and Treasurer.*

# United States Naval Institute Proceedings



The writers only are responsible for the contents of their respective articles

## CONTENTS

	PAGE		PAGE
Use of Aircraft in Naval Warfare.—Cum- mings . . . . .	1677	T=C-W.—Van de Carr . . . . .	1763
The Salvage of the "Leonardo da Vinci."— Guidoni . . . . .	1689	Tactical and Fire Concentration Problems and Their Solutions.—Hill . . . . .	1765
Rigid Airships.—Fulton . . . . .	1697	A Solution of the Officer Personnel Situa- tion.—Blasdel . . . . .	1779
The Naval Officer and the Civilian.—Stevens	1725	Secretary's Notes . . . . .	1787
Yap.—Allen . . . . .	1741	Professional Notes . . . . .	1791
Across the Continent With an Insane Man. —Coontz . . . . .	1749	Notes on International Affairs . . . . .	1847
The Study of History for Naval Officers.— Mayo . . . . .	1755	Information Index . . . . .	1789

Copyright, 1921, by J. W. Conroy, Trustee for U. S. Naval Institute

Entered at the Post Office at Annapolis, Maryland, as Second Class Matter

See Special Supplement immediately inside of cover, containing:  
**The Relative Importance of the Philippines and Guam.—Fiske . . . . . Page 1676**  
**Sea-Power: The Senate and the Air.—Moran . . . . . Page 1676**

# WORLD'S ONLY MAKER

Moulded High Frequency High Tension Insulators

POTENTIALS 1,000 ← TO → 1,000,000 VOLTS

Medal and Diploma  
received at  
World's  
Columbian  
Exposition,  
Chicago, 1893



Medal and Diploma  
received at  
World's  
Fair,  
St. Louis,  
1904



REG. U.S. PAT. OFF. & FOREIGN COUNTRIES.  
INSULATION  
MADE IN AMERICA

Louis Steinberger's Patents

**ARRIVED**



**AIR-GAP TYPE  
INSULATORS**

PATENTED

Radio Frequencies  
Radio Telegraph  
Radio Telephony  
X-Ray Apparatus

Damped or Sustained  
Voltages

Air Gap  
1/4" and Upward

Maximum Dielectric  
Strength

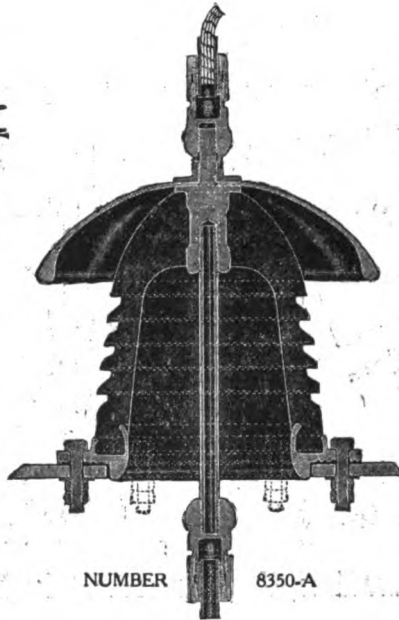

NUMBER 8350-A

**ARRIVED**



**AIR-GAP TYPE  
INSULATORS**

PATENTED

Audio Frequencies  
Transmission Lines  
Sub Station Bushings  
Transformer Bushings  
Oil Switches  
Circuit Breakers, Etc.

Air Gap  
1/4" and Upward

Maximum Mechanical  
Strength

**MINIMUM DIELECTRIC LOSS  
MINIMUM WEIGHT**

**MINIMUM COST  
MINIMUM PHYSICAL DIMENSIONS**

Materials so proportioned that:

**MAXIMUM ELECTRIC STRESSES FORMED IN AIR**

EXTENSIVE TESTS under sustained radio frequency operation show:

**NO DETECTABLE HEATING**

**ARC-OVER ESTABLISHED IN AIR**

"ELECTROSE" Insulators are standard with United States Navy and Army and Wireless Telegraph and Telephone Companies.

"ELECTROSE" is made in a number of grades for various requirements, each grade possessing special characteristics.

"ELECTROSE" Insulators—Best in the World for High Frequency Currents, Power and Transmission Circuits.

SOLE MANUFACTURERS

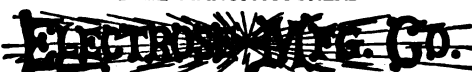

60-82 Washington St.  
60-76 Front St.

27-37 York St.  
1-23 First St.

Brooklyn, N. Y., America

Please mention the PROCEEDINGS when writing advertisers

# SPECIAL SUPPLEMENT

---

United States Naval Institute Proceedings  
No. 225, November, 1921

---

THE RELATIVE IMPORTANCE OF THE  
PHILIPPINES AND GUAM

BY REAR ADMIRAL BRADLEY A. FISKE, U. S. NAVY

AND

SEA-POWER: THE SENATE AND THE AIR

BY CYRIL GODFREY MORAN

NOTE—These articles were not received in time to be included in the regular pagination of this issue, but are considered of such importance that the mailing has been delayed in order that they might be bound in as a supplement.



*Naval Department*  
*6*

**COPYRIGHT, 1921**

**By J. W. CONROY**

**TRUSTEE FOR U. S. NAVAL INSTITUTE**

[COPYRIGHTED]

U. S. NAVAL INSTITUTE, ANNAPOLIS, MD.

---

## THE RELATIVE IMPORTANCE OF THE PHILIPPINES AND GUAM

By REAR ADMIRAL BRADLEY A. FISKE, U. S. Navy

---

During the last ten years, and especially during the last few months, a great deal has appeared in print from the pens of navy officers and others, concerning the strategic situation in the Pacific Ocean. In virtually every writing that has appeared, the importance of Guam has been called to the attention of the reader: but only casual mention has been made of the Philippines, and very little realization manifested that they possess any strategic importance worth considering.

In the chapter on "Naval Bases" in my book, "The Navy as a Fighting Machine," page 322, is the paragraph "Mahan states that the three main requirements of a naval base are position, resources and strength: and of these he considers that position is the most important; largely because resources and strength can be artificially supplied, while position is the gift of nature, and cannot be moved or changed."

Now the book itself was published more than five years ago, and Mahan's declaration had been made some years before. The opinion expressed has never been challenged to my knowledge. It seems, in fact, to have been definitely accepted.

Let us see how the Philippines and Guam compare, if measured by each one of these standards.

1. *Position*.—From pages 327 and 328 of the book just mentioned, I beg leave to quote the following sentences: "The whole usefulness of bases is due to their ability to put fleets into good fighting condition and maintain them in it. This shows the advantage of having a base as close to the place where a fight is going to happen as may be possible. . . . It merely means that the closer the base is to the scene of operations or the actual battle, the



better 'tuned up' the personnel and material will be. It also means that this consideration is of the highest practical importance."

This paragraph enunciated no new principle. I mention it merely to call it to the attention of the reader, and to add a definite statement that the principle was stated in a well-known book five years ago, and has never to my knowledge been controverted or even questioned.

On the assumption that the principle is correct, it must be manifest that the Philippines are much superior to Guam in position; for the reason that they are much "closer to the scene of operations, or the actual battle": because, although we do not expect that any war is going to happen in the Pacific, yet if it does, the scene of probable operations can hardly fail to be the general vicinity of Formosa and Japan; unless, indeed, it be in the waters of the Philippines themselves.

2. *Resources*.—The Philippines cover an area of about 115,000 square miles and Guam an area of about 210 square miles. As there seems no reason to believe that the soil of the Philippines is less rich in natural resources than that of Guam, it follows that the natural resources of the Philippines must be at least five hundred times as great as those of Guam; using the expression "natural resources" in the accepted way, to mean the vegetable and mineral products of the soil. In the matter of what we may call "naval resources" (the resources needed to maintain a fleet, such as sheltered harbors of deep water, suitable places for docks and wharves), the ratio cannot be determined with exactness; but, since Guam has merely the exposed and contracted harbor of Apra, while the Philippines have scores of large harbors of deep and quiet water, it is clear that these resources also are much greater than those of Guam.

3. *Strength*.—The word strength, as applied to a naval base, could hardly have had any other meaning in the mind of Mahan than that in which it is usually applied to bases like Gibraltar: *i. e.*, ability to prevent capture. Here, also, the Philippines seem superior to Guam. Surely it would be more difficult to capture them than to capture Guam. It would necessitate a greater effort, and cost more in money, men and time.

Looking at the question somewhat more generally, we can see that the Philippines, by reason of their contiguity to the coast of a great land about to be developed (China), and by reason of lying

on the flank of all vessels passing from the Mediterranean to China and Japan and back, have a strategic importance in a highly important area, of the utmost possible value, and one that will increase as the years go by. And while it is true that Guam will always have a considerable strategic importance, because of its contiguity to the routes between the west coast of the United States and the Philippines, yet those routes are merely between the United States and the Philippines; whereas the trade routes that pass the Philippines lie between *all* the great countries of Europe and *all* the great countries of Asia.

Yet most navy officers and others who write on naval strategy wax eloquent in speaking of the value of Guam and almost ignore the Philippines! Why is this? Some may answer that the writers presume that the importance of the Philippines is so well understood that it is not necessary to speak of it. But this is not so: the importance of the Philippines seems not understood at all, if one is to judge by what is written and spoken and *done* about it.

Probably the reason is that the non-realization of many people of the ability of the airplane to prevent the actual invasion of the Philippines brought them to believe that the Philippines could be taken at any time: and that this belief gradually became "*une idée fixe*." Now, *une idée fixe* in important matters is a dangerous thing; because it remains *fixe*, even when the persons entertaining it know that the conditions which originated it have departed.

Has not the time arrived to shake off the manacles of this *idée fixe*? The Philippines can be defended without great cost or labor, and they are even more important than Guam or Yap.

Surely this question is important enough to demand the most serious thought. No more important question is before the United States; none more imperatively demands the proper answer.

[COPYRIGHTED]

U. S. NAVAL INSTITUTE, ANNAPOLIS, MD.

---

SEA-POWER: THE SENATE AND THE AIR

By CYRIL GODFREY MORAN

---

I

The results of the bombing experiments on the ex-German warships by army and navy aviators, however far reaching and ramified their effect, are at the outset rather discouraging to the onlooker interested in the political future of the United States, who is alive as well to the necessarily important rôle our navy will play in it.

They have furnished to date quantities of hot material to ill-informed newspaper correspondents, worse informed legislators and certain officers in the service of the United States who have employed more of enthusiasm than the light of cold reason in their arrival at conclusions, in their statements to the press and in published writings.

On such a broad stage was the contest set, with properties dramatic as the airman and the ghosts of an enemy naval power, the foreordained result could not but be spectacular. Now snap judgment and the hasty decisions of the popular mind are its dangerous concomitant.

When action on these decisions is pursued on the floors of our Congress by men fortified in the consciousness of their duty to effect the economies of which this country stands so much in need, their perseverance may well involve the military, especially naval forces in a disaster that will strike at the very heart of national defense; may, in the emergency when moments are priceless, cause the irreparable loss of lives and territory and leave a breach into which billions will be tossed in an effort to expiate the shortsightedness and questionable economies of the present.

The press in the past few months relates repeated efforts to suspend, in the interests of economy, construction on all new battleships and battle-cruisers. That overridden, another move to stop building on all that are below a certain per cent completed was

attempted. Now, following the "victory of the air," fervid in their latest conversion, the senate of the United States has for its consideration still another measure to provide for the conversion of three embryonic battle-cruisers into airplane carriers, with the stoppage of construction on the remaining three in addition to suspension of work on six super-dreadnoughts.

This is by way of meeting Secretary Denby, who with more weight than his word carried several months ago, before the bombing tests, is requesting a special appropriation of thirty millions from Congress to build an airplane carrier. Provision for two such vessels was thrown out by the House of Representatives in the Naval Appropriations Bill for the ensuing year, ending July 1, 1922. It may be noted that this bill was passed immediately prior to the sinking of the ex-German cruiser *Frankfurt* and the battleship *Ostfriesland*. As far as the Senate and House's limited technical understanding serves them, they are now vaguely apprehensive at the ostensible outcome of the tests and the quick confutation that seems to have assailed their cheap frugalities.

Noting the trend of the time and public interest they clamor now for the carrier. But blind still to the fundamentals of naval strategy, the uproar is at the expense of our most vital naval need—the battle-cruiser; and the last bill, introduced by Senator King of Utah, robs Peter to pay Paul but the half.

On the necessity of the battle-cruiser to the modern fighting fleet and its function, we will dwell later. Suffice it to say here that we have been more than five years getting the six that are authorized, they are still far from realization; yet they have been the object of consistent and bitter attacks by legislators, who seem to have singled them out as particular targets in their philippics against "The 1916 Program." (Which, whatever its mistakes, is one of our few progressive steps in the embodiment of a sound and broad naval policy.)

The disarmament conference, erroneous conclusions drawn from the bombing tests and the reaction of public opinion against the capital ship, tends in a dangerous degree to undermine the navy's defensive structure. The situation is no less than critical when the well being—possibly the future—of the service vacillates in the balance, subverted to the decisions of those hasty and untrained judgments who unfortunately have a large and altogether too detailed voice in the development of measures for national defense.

Carried away by the ideal of disarmament or by popular concession to a widespread misapprehension, they are being led to the committing of national indiscretions that will react perhaps heavily to our disadvantage in a future emergency.

To Senators Borah, of Idaho, and King, of Utah, is generally conceded the leadership in the fight against the continuance of capital ship construction, the completion of the 1916 program, and so on down the line to total disarmament.

To these men, personally, it is impossible to impute anything but the highest motives. They are actuated, doubtless, by the greatest sincerity and desire of service; the one pursuing his ephemeral vision of an everlasting world peace, the other supported by a conscientious effort to develop what appears to him a modern navy. Neither of them, however, are technically trained, and, lacking this specialization of their subject, are incapable of dictating in any military measure, policy or a detailed program of matériel. They are forced to accept in whole or in part the dicta or opinion of others more in touch with the matter, whose views for the time may be swayed by the detonation of a bomb on an abandoned hulk or who are accepting as postulates the empirical assumptions of air proponents.

Senator King in his long speech before the Senate last spring advocating suspension of naval construction, made no less than five misstatements in his opening remarks. They were important in that he was then reviewing the past administration of the service, resolving it to the present for disparaging comparison; and in all but one instance the statements directly or indirectly supported the logic of his disapproval. These departures in no way reflect on the senator's veracity; they are more an earnest of ignorance of subject. On the other hand they directly impugn the reliability of his sources of information and lay his conclusions, however ably drawn, open to serious question. In justice to Mr. King, however, be it said that his stand in the same speech on the disappointing results of our submarine program is well founded, and his effort to improve the present wretched condition of that service worthy of attention and support.

The Senate is here left to its discussions and we proceed to analysis of the airplane and the capital ship; weigh their functions, consider their comparative value, their necessary correlation and the place of each in the strategic plan of a naval operation.

## II

Before going further the writer submits that the spirit of this discussion is not an opposition to air. On the contrary air's proper recognition as a factor in offense and defense, and its development within the physical limitations of its performance, is heartily urged. Its present menace (or usefulness if you will) and potentialities are fully recognized. But its sweeping adoption at the expense of the more stable, the tried machinery of naval warfare is from the soundest practical sources, decidedly condemned.

In the proposed substitution of the airplane carrier for the battle-cruiser, to the latter is assigned a distinct tactical function that can neither be usurped nor superseded by the former; each in their design present dissimilar characteristics of strength and weakness that will, as far as the plan goes, keep them widely separated in a fleet engagement.

The carrier is cut to Admiral Lord Fisher's rule; "Speed is armor." Her speed is her defense, her planes her offense. The battle-cruiser's offensive arm is the big gun; speed is likewise her defense. Because of the requirement of speed and sea-worthiness, both are large, the largest units of a fleet. Therefore, the equality of speed and inferiority of gun-power renders the carrier the particular prey of the battle-cruiser, or conversely the battle-cruiser is the best defense against the operation of the carrier, ship for ship. In the judicious provision for the carrier, it is axiomatic that the battle-cruiser, as a form of capital ship, must be retained in the strategy of a naval power for its protection. In detached operations the enemy battle-cruiser is the logical attack that may be looked for against it.

The function of the airplane carrier is, in the vessel itself, of a defensive order; that of the battle-cruiser, essentially offensive. The cruiser, aside from its duties at the head of the battle column maintaining contact between its own and the enemy's fleet, for rapid concentrations of force and the execution of possible enveloping movements in a general action, is also for the destruction of enemy commerce. This latter duty may involve the annihilation of their protective cruiser patrols, the sinking of their merchant ships, or simply driving them into port and off the seas as a most effective way of paralyzing their communications and strangling their resources for making war. Moreover, the battle-cruiser serves as protection to its own sea-borne trade in that it is

the only type swift and powerful enough to overtake and destroy the enemy battle-cruiser, supporting perhaps light cruiser raiding squadrons, and put a stop to his depredations, maintaining international credits and feeding the country with the vital necessities for prosecuting the war on which they may be engaged.

Among world powers, all of the potential enemies of the United States are better equipped with this type of vessel than we will be in ten years. The very fact of the possession of battle-cruisers by powers whose world interests may in future conflict with ours is an all-sufficient *raison d'être* for the retention and completion of those projected in our own program. Additional battleships, at this unstable period in naval design, can perhaps be dispensed with profitably, but the airplane carrier and the battle-cruiser are to this country a politic necessity before we shall subscribe to a naval holiday. It will be a critical step in our position as a naval power with major world interests, to vitiate a now too-meager force of the latter type.

For the purpose of speed in realizing an air defense program it may be expedient and the part of wisdom to sacrifice one or possibly two of the least completed battle-cruisers for conversion into airplane carriers, but this idea should not be entertained without the certainty of others of the latest design being immediately laid down and their construction expedited to replace them. These vessels are tremendous works of naval architecture and engineering and cannot be built in a day. Hagglng as we are over penny economies may postpone their completion until the crisis when a minute is worth the year, and, realizing their need and our folly, we will pay with pounds.

There would be but little actual economy, as claimed, in converting the cruiser at this stage, the cost being all out of proportion to the advantage, and the necessary limitations of the carrier resulting from the change would be little profit for the labor, the time and the concessions.

It is not irrelevant to note here that at the outbreak of the war, Germany with thirteen commerce raiders spread over the seas of the world, ranging from light cruisers to armed liners, fully and exclusively occupied the attention of no less than seventy Allied warships in the several months before they were captured, driven into port or destroyed. England, who undertook the protection of the majority of the world trade-routes, was at times in extreme

straits with the utmost help her Allies could render, for lack of sufficient cruisers for this work. Her own battle-cruisers, possessing a slight preponderance over Germany's in weight and number, were kept closely confined in home waters for the express purpose of preventing the enemy from getting to sea and wreaking havoc with Allied trade. Although two were diverted for a time to South American waters subsequent to Cradock's defeat at Coronel, it was done only under dire necessity and with the greatest secrecy. Mark, England's Grand Fleet was not regarded as a certain stop for this handful of fast ships. It was the battle-cruiser squadron, because of its speed, that assured the safety of the gigantic commercial fabric; that could prevent the enemy from winning free and with superior speed and guns engage separately and destroy the Allied light cruiser squadrons that patrolled the world, generally wrecking that far-reaching system of communications and supply. The simple fact of the British battle-cruiser squadron "being" prevented this logical and, for the Allies, disastrous move on the part of Germany.

### III

The airplane, embodying though it does terrific power of destruction, is inherently a defensive weapon, due to its dependence on a particularly immediate base for its fuel and ammunition. Offensive power is largely a matter of range; effective operating range, from a military standpoint, is as vitally a matter of time as of miles. To adduce it in terms only of distance is the sophistry that will argue naval strength in the glib generalities of tons and horsepower.

The fundamental weakness of air navigation is its subjection to the contingencies of weather; in contrast, one of the capital ship's chief sources of strength lies in its comparative indifference and independence. In the interesting search problem and bombing of the old battleship *Iowa* last summer, actually the most remarkable feature was the achievement of naval engineers in controlling a crewless ship from a distance of five miles; the most significant was the postponement of the problem for two days to await fair weather and good visibility for the airplanes that were to make the "search." That the ship was found and two bombs dropped on her while maneuvering at four knots establishes little: had the *Iowa* actually been an enemy approaching the coast at the time first arranged, even though the defending forces had information of



her, as far as air scouting was concerned she would have made her landfall, accomplished the bombardment or other military object and have been back at sea before the weather had cleared sufficiently for air observation even to watch her depart. Here is the real crux, the betrayal of the airman's narrow range as presently equipped. Had the navy not something more sturdy that could remain "out at night," for defense, the *Iowa* and her attack, representing an enemy battle force, would have been successful.

In the squadron and fleet engagements of the war, weather and visibility conditions were generally such as to preclude the successful operation of aircraft; the notable exception being the early hours of the battle of the Falklands between Sturdee and Von Spee. Even that battle, however, was concluded under the handicaps of low visibility, mists and rain, a condition that had prevailed unremittingly for several days, clearing only on the morning of the action.

The battle of Helgoland Bight, in August, 1914, the first naval engagement in force of the war, was fought under varying conditions of mist and low visibility, according to an authoritative account. British submarines nearly torpedoed their own cruisers going into action because of the difficulty in distinguishing them and the failure of signals. In the day's fighting most gun ranges were perforce point-blank.

At Jutland, German air reconnaissance totally broke down. Admiral Von Scheer was forced to postpone the operation that brought on the battle (the raid against Sunderland) for eight days, May 23 to 31, 1916, for, according to his own report, "it was impossible to send up airships" for the scouting he had relied upon and finally carried on without. Sixteen of his submarines were stationed from May 23 off five English North Sea ports to report movements of Grand Fleet squadrons. On the morning of the action, because of poor visibility, two of them reported the movement of a total of ten British warships—all they saw—though the number of British ships directly concerned in the action was one hundred and forty. On the same morning five Zeppelins took the air and accompanied the German High Seas Fleet into the North Sea as scouts, but Von Scheer says of them, "They took no part in the battle (of over fourteen hours), neither did they see anything of their main fleet, nor of the enemy nor hear anything of the battle.

"The *L-4*," he says further in his report, "according to her own reckoning was directly over the scene of the action at 10 p. m." This was 8 p. m. Greenwich time and in that latitude, still daylight. There thirty or more men hovered over the greatest sea battle in history, being fought over a hundred square miles at once, unaware of it.

The following day, when the North Sea from Horn's Reef to the Orkneys was literally plastered with British ships, five more Zeppelins went up for a look around.<sup>1</sup> Of them, two reported sighting British units, but "were unable to maintain contact." For these super-ships of the air the record is not impressive.

Admiral Beatty sent up a seaplane at the beginning of the battle-cruiser action from H. M. S. *Engadine*, that was the most successful air attempt made during the course of the battle. The pilot was forced to fly at about a thousand feet because of low visibility and cloud formations. He was thus a target for the high-angle secondary batteries of the German warships, which placed a shrapnel box around him and allowed him to approach no closer than a mile and a half. His observer made out the ship class with some difficulty and they returned after a breakdown, to report they had flown through bursting shrapnel. The necessity for the German anti-aircraft batteries never even arose. Had this plane carried bombs little could have been accomplished with them at a mile and a half.

The battle of Coronel was fought in a heavy sea and under weather and visibility conditions prohibitive to successful air scouting or attack. Many of the detached engagements between single ships throughout the war were carried on under conditions where

<sup>1</sup> The report of the Zeppelin *L-11* says in part: "June 1st, 1.30 a. m. went up at Nordholtz . . . visibility limited owing to ground fog and later to fog-like atmosphere high up extending over 2 or at most 4 nautical miles. Helgoland not visible through fog. At 5.10 sighted enemy . . . visibility so poor extremely difficult to keep contact. At 5.15 enemy opened fire on airship. . . . Flash of guns could be seen though ships were hidden by smoke . . . shrapnel shook airship so increased range . . . visibility became worse and enemy lost to view at 6.20 . . . went so low as 500 meters in hope of better visibility . . . impossible to see over one or two miles."

Another, the *L-24*, the same morning reported: "4 a. m. sighted enemy destroyers, was fired at and returned fire with bombs. Then got away . . . 5 a. m. sighted 12 ships in Jammer Bay. Impossible to keep contact as there was bank of clouds as low as 500 meters."

it would have been impractical to even launch an airplane. The days on which these various engagements were fought were not exceptional; they were the ordinary run of sea weather. In most latitudes, through the winter months, the days are such as would be classified "bad, or perilous flying weather."

#### IV

The experiments carried out against the German warships were primarily an effort by the navy to determine the resistant powers of different types of modern fighting craft to the destructive effects of air bombs. Secondarily, it was a simple and profitable means of complying with the terms under which the ships were surrendered, namely, that they would be destroyed.

The navy invited the army to participate in the tests, to share with them the compilation of data that would be advantageous and instructive to both. The army accepted and soon it was noised about that the capital ship was in its obsolescence, a new weapon of destruction, cheap and effective, had arrived to supplant it; that the tests were to determine which would survive. The issue was raised—it was the airplane or the capital ship! Of course the ships were sunk; they were towed to their last anchorage in fifty fathoms for that purpose. The attacks were carried out under conditions ideal to the airman, they were directed to fly as low as consistent with their safety, the object being to get hits and waste little ammunition as possible. They were at least once postponed to await more favorable flying conditions.

So, in an issue that was really not an issue, but a controversy manufactured by those whose interests were certainly not the navy's, the navy in many quarters has suffered an unwarranted loss of prestige, experienced a pernicious reaction from its efforts to provide against a new form of warfare. One disquieting fact, because in a measure overlooked by both "sides" in the tests, was brought out; that the water, heretofore relied upon by the armored ship as protection below which to secure its most vital organs, was in the new form of attack a critical weakness, that the air-bomb acting as a depth-charge or mine can deliver mortal wounds through this incompressible medium, and that in reality "the hits that miss are the hits that count!"

Little, however, was proven that was not already known; were someone to suddenly stop you and whisper confidentially that a mine will sink a ship, you would hardly be incredulous. You might retort that the news was several generations old.

On the other hand, much was learned and new applications of old principles were noted. Important among these was the demonstration of the thorough effectiveness of the protective deck against air attack and the virtual immunity, as regards machinery spaces and magazines of a ship so fitted against bombs. The cruiser *Frankfurt* was attacked for nine hours with bombs up to 600 pounds, during which she suffered a number of direct hits. The last inspection party to board her before she sank reported her machinery spaces apparently undamaged. This vessel was extremely light in construction for the high speed requirements, and her protective deck was two inches thick. She was fitted in addition with a narrow strip of light side armor.

Armor-piercing bombs, dropped on the battleship *Ostfriesland*, tore through two upper decks, but in every case splintered on the protective without damage to the vital spaces below it.<sup>2</sup>

Perhaps the greatest lesson of the tests lay in the fact that it was not the actual hits made by the airmen on the target ships that wrought the real damage. They were spectacular enough and their manifestation of force terrific. They tore apart rigging, bridges and fittings, threw wreckage incredible distances, and in general seemed to justify the airmen's most sanguine claims of their destructive virtues. But the damage was in the main superficial. Taking account of only the direct hits, under battle conditions, the *Frankfurt* and *Ostfriesland* could have maneuvered and fought with little diminution of their value as military factors. The shattering effect did not extend beyond the immediate area of the explosion, nor did it penetrate into gun turrets or conning-tower.<sup>3</sup> The bombs that were physically a miss determined the result in both cases, and established the dropping of explosive, not on the deck of the ship for an actual hit, but close alongside as the proper and effective attack. These seek great depth and with almost instant detonation drive the incompressible water against the light

<sup>2</sup> Three inches on slopes.

<sup>3</sup> Only the *Ostfriesland* was equipped with turrets. The 5.9-inch guns of the *Frankfurt* were mounted in the open and fitted with shields.

plating of the ship's bottom, that it had heretofore shielded from gunfire, driving it in like a paper bag. Achilles had his heel; a warship's most vulnerable area, accessible to these bombs, is that below her water and armor line.<sup>4</sup>

This weakness, up to the present, is a wholly justifiable one. To-day's capital ship is but an evolution of the old line-of-battleship and has been designed until now principally for defense against its kind. Perfection of subsurface resistance has lacked the inspiration of necessity, the insistence of which has only recently been felt; indeed, in vessels some time afloat a start in this direction is indicated in the "inside hull" design that has shown so favorably under test.

In the case of the battleship *Ostfriesland* it will be noted that her sinking was directly the result of capsizing; that is, she turned over on her beam ends before she sank. An inquiry into the cause of this has its inception in the preceding paragraph. Well into the last century<sup>5</sup> the navies of the world had concerned themselves with the question of improved underwater defense and German designers, of late well in the van on warship construction, had placed in the *Ostfriesland* and even earlier ships an intricate underwater subdivision, combining fore and aft bulkheads in addition to the thwartship ones; forerunners of the present "inside hull" and "blister" construction. German practice, as Admiral Jellicoe complains,<sup>6</sup> was consistently superior to other navies in their clear estimate of the value of heavier interior protection; employing, as they did, stronger integral construction and in many cases armored partitions between compartments throughout the ship, both above and below the water-line; the sole object aimed at being maximum resistance to shell-fire.<sup>7</sup>

<sup>4</sup> The prior sinking of German submarines and two destroyers had little bearing on the question of bomb effectiveness against the warship. It more closely approached sinking a tin can in a pond with rocks—to get it out of the way and at the same time to try your aim.

<sup>5</sup> The earliest attempt to armor a modern warship against underwater explosion occurred in the French coast battleship, *Henri IV* (1899) 8800 tons. This vessel carried a steel splinter deck, fitted below the protective deck, clear around to the turn of the bilge, where it joined onto the double bottom. The space between the decks was fitted as a cellular layer.

<sup>6</sup> "The Grand Fleet."

<sup>7</sup> Their battleships, for a given displacement, had greater percentage (by weight) of armor allowance than their British contemporaries, which more

When the *Ostfriesland*, last July, was towed to her target position off the Chesapeake Capes and anchored, she carried a degree or two list to port. Subsequent to an afternoon's bombing, in which she sustained a dozen direct hits and a number of "depth-charges," she was allowed to remain over night without attention, and in the morning when the airmen returned to the attack she was found to have settled a little by the stern with the list slightly accentuated. In the second phase thousand-pound missiles were dropped on and around her, driving holes in her bottom and opening seams with the successive shocks. Still the old warrior gave no signs of vital distress until near noon, when the airman's *pièce de résistance*, the two thousand-pound demolition bomb, was introduced.

The damage of the first day and the morning of the second seemed to observers to have been principally to port. Twenty minutes after the first two thousand-pound bomb found its mark the *Ostfriesland* turned over on her beam ends and a minute later sank.

In the rapidity of its climax, the sinking, though foreordained, was a staggering shock to all who witnessed it. In an analysis of the cause it appears that the very measures for safety taken in the vessel's design were primarily responsible for her quick succumbing to the last attack.

Due to her longitudinal subdivision, with its inherent structural power, the damage sustained the first day, concentrated largely on the port quarter, while not in itself necessarily vital, certainly became so through inattention during the night and the consequent heavy accumulation of water to the port side of the ship. The heavy armored bulkheads held as they were designed to and confined the large mass of free liquid far to one side of the vessel's

---

than compensated for their lighter guns, in minimizing the effect of interior explosions and increasing their resistance against shell-fire. As a result, they were enabled to bring heavily damaged ships successfully out of the engagement at Jutland, where British ships, no worse hit, were lost. The battle cruiser *Derfflinger* was hit in that action by twenty-eight shells of all calibers up to 15-inch, and the *Seydlitz* suffered twenty-five hits besides torpedo damage below the water-line. Both vessels were in action until the end and were repaired within a short time by German dockyards.

center-line, promoting her list and bringing more openings and superficial damage below water.\*

Fifteen hours later, in the attack the following morning with the heaviest bombs, her declining resistant powers were unequal to the assault. Further underwater damage accomplished on both sides of the ship had quickly apparent effect. The rapidly increasing inrush of water, still preponderantly to port, her decreased righting-arm and the still virtually water-borne starboard side generated a turning moment that her great mass could not overcome; she simply turned over.<sup>9</sup> As she did so she bared her wounds, displaying punctures of her underwater body as if to show those who saw why she gave up the unequal fight. Many among those who saw her go down, are yet to be convinced that she was sunk by bomb-fire.

No ship was ever designed to float long on her beam-ends.

Had the *Ostfriesland* a crew aboard under actual steaming conditions, the damage suffered in the first day's attack was such as not to have even taken her out of action; and, beginning with the

\* The capsizing of H. M. S. *Victoria* in the Mediterranean was ascribed principally to the longitudinal bulkheading system employed in her design. The *Victoria* was rammed by H. M. S. *Camperdown* on a calm sea, during fleet maneuvers in June, 1893. She was badly holed on the starboard side, above and below the water-line, taking in nine minutes a heel to starboard of 19 degrees. From there it was accelerated to a sudden lurch, submerging hatches and gunports of her main battery. Shortly afterward she turned turtle and sank.

The admission of water to two forward compartments and its confinement to the starboard side and the flooding of a forward coal bunker on the same side were given as the cause of the sudden capsizing, which resulted in great loss of life. The vessel had apparently ample reserve buoyancy, though her stability was destroyed by the uneven distribution of the water she took in. The *Victoria* was a battleship, 11,940 tons, built in 1887.

<sup>9</sup> Discussing the loss of eight old British battleships during the war—2 *Formidables*, 2 *Duncans*, a *King Edward*, a *Majestic* and two of the *Canopus* class—William Hovgaard, one of the foremost authorities on warship construction concludes: "Most, if not all of the vessels that were lost capsized, or at least took a heavy list before going down, whereby the foundering was much precipitated and the loss of life increased. Perhaps, in some cases, the ships might have been saved had they remained upright. The heel was due to the presence of longitudinal bulkheads, which here, as on so many other occasions, proved a most vicious feature unless associated with efficient appliances for quickly righting the ship."—*Modern History of Warships*, page 86.

handicap of the following morning, it is entirely possible with a crew to manipulate her compartments to give her proper trim and with pumps on the leaks, she could have been brought successfully out of action and saved, as she was at Jutland, after running on a mine. During that engagement the battle-cruiser *Lutzow* was fought and navigated after she had taken in over 7000 tons of water as a result of Beatty's hammering, before she was abandoned and torpedoed by her own crew. It is contended that the *Ostfriesland* had taken in enough water to capsize her, in her untrimmed condition, but insufficient (before turning turtle) to cause her to sink.

The light cruiser *Frankfurt* (which an observer-correspondent of a New York daily likened to a "powerful battle-cruiser") was still afloat after nine hours of bombing during which there was some very good shooting. At its conclusion, the airmen's ammunition had all been expended; a mining party had been called away from the battleship *North Dakota* to finish the job and get the *Frankfurt* out of the way before dark, as per schedule. It was not until then she was observed to be sinking; the actual result of a bomb dropped in the latter part of the attack that had missed the target by fifteen yards. It was well (or poorly) timed and detonated late underneath the vessel, breaking her back and actually administering the *coup de grace*. Weakened by her day's punishment, she finally bowed to this "hit."<sup>10</sup>

## V

Returning to the airplane, we will for the moment concede in all points the claims of its most extravagant advocate. Assuming it is the superior of the capital ship in all essentials of offensive. it is immediately apparent that it will take on itself the functions of the battle-fleet in war. A basic principle of naval strategy, old as ships themselves, has been to consider the seacoast of the enemy

<sup>10</sup> In the detonation of this 550-pound bomb, abreast of the bridge, on the starboard side, water geysers were raised on both sides of the ship. Though there were frequent explosions near them her guns did not appear to have been damaged. The personnel manning them, however, would have unquestionably suffered severely. Although the *Frankfurt* is classed as a light cruiser, she is little more than a large destroyer leader and as lightly built. She served through the battle of Jutland as flagship of a scouting division and as such did not come under gunfire from the heavy ships. She was built in 1914; 5400 tons; 28 knots.



the proper frontier of operations. Hence, a naval power is faced with the necessity of transporting a large number of these efficient, inexpensive weapons against the bases and territory of the enemy, an operation requiring a fleet of large fast carriers, which it is supposed are already built and in commission.

The enemy, in its attempt to block the transfer of this dangerous offensive into its own territory or an area possibly disadvantageous to it, will direct its first effort against the transportation of the planes, therefore against the carrier.

Primarily, submarine or destroyer torpedo attack would be the logical method employed against the carrier, en route. For defense against this, the carrier would be protected by a screen of destroyers. Against this screen and for the protection of its own destroyers and submarines, the enemy dispatches the light cruiser. Light cruiser must be met with light cruiser, which in its turn would bring into action successively the armored and then the battle-cruiser and so right back to the capital ship, whose size, power and number, either in action or in being, would be the deciding factor in permitting to operate that which in the premise is the superior of the capital ship. In a word, before a plane could be transported on the sea a fleet action must be fought; or the disparity between the belligerent fleets so marked as to leave no doubt of the result. Under these conditions, the stronger power could undertake an air offensive in a theatre of its own choosing, while for the weaker a similar move, either as a counter attack or an independent offensive, would be out of the question.

Thus we go round in the great circle; enlarging as it does with each age of development; each decade a little more complicated, more intricately subdivided perhaps, but always deferring in the final analysis to the decision of the armored ship and the big gun.

"War," says Mahan, quoting Napoleon, "is a business of positions." The allusion is not, in a strict sense, geographic, but implies as well the proper concentration and dispositions of offensive power. Suppose in a war of extermination the United States won a decisive victory with our hypothecated air fleet in a foreign area. How without the capital ship could we realize our advantage, organize our acquired positions, and from them prepare further attacks against the enemy?

Artillery, on land, is a weapon capable of driving in a position, rendering it untenable for the defending force. But artillery of

itself cannot occupy the position it has won, cannot enjoy the fruits of its strength. Occupation and consolidation with other points in the battle line must be effected with infantry, who can also establish a vigorous defense against counter-attack. The air force, in its offensive phase, is analogous to artillery, capable of forcing a position, but not of occupying it; useless without the co-operation of the other branches of the military machine. The plane, in its limited scope is capable of a very dangerous and not to be minimized assault; but there its offensive virtue ceases. Though it drives its enemy from a position, it cannot occupy it; its pilot cannot tarry if he would.

In the contest for vital points, final appeal for the military decision rests with the instrument capable of occupying and holding a position in face of the strongest concentration the enemy can bring against it. In armies the general battle plan must ever evolve around that strongest and most flexible of its components, the infantry; in naval strategy, the capital ship. Mahan, in his endorsement of this, said: "Seaworthiness and reasonable speed under all weather conditions are qualities necessary to every constituent of a fleet; but over and above these, the backbone and real power of any navy are the vessels which, by due proportion of defensive and offensive powers, are capable of taking and giving hard knocks. All others are subservient to these, and exist only for them."<sup>22</sup>

Thus, while to-day the air is acclaimed the new and only true basis of sea-power, it is, as can be seen, dependent on the capital ship for leave to operate in any capacity but as a factor in coast defense, from a protected base. And as it is subsidiary to the actual sea-power of the nation launching it, the airplane is relegated, like the submarine, the torpedo and mine, to its proper place as an indispensable auxiliary to the operation of the fleet. In gunnery observation and for coast defense command of the air has become a necessity, though in the latter connection it is not unreasonable to predict that the fleet engagement of the future will be fought no nearer a coast-line than either commander will permit himself to be driven. Sea room is as vitally an advantage in the day of the big gun as it was in the age of the sailing frigate.

In the field of naval offensive, the air, during the past war, had in a marked degree its opportunity for conclusive demonstration.

<sup>22</sup> "Preparedness for Naval War." *Harpers Magazine*, March, 1897.

Probably in no succeeding conflict between major powers will the naval effort be concentrated into such narrow compass as British preponderance steadily forced it from the opening months of the war. British naval bases, the Grand Fleet and the cruiser patrol areas were within easy range of the German air bases on the North Sea and in Flanders. Mine-sweeping operations were carried on continuously, deferring only to bad weather, while British monitors anchored at will off the French and Belgian coasts within big-gun range. Germany had at this time carried air bombing to a reasonable perfection; yet the fact remains that no persistent or extensive bombing operations were directed against the units in the North Sea, no Allied vessel was disabled from the air and few were ever subject even to attack.

The case, not amiss here, of the Turks getting the *Sultan Selim*,<sup>19</sup> aground in the Dardanelles, floated, repaired and moved to a place of safety in the face of the utmost efforts of British airmen with their bombs, constitutes another example of the difference of conditions as they exist in actual war, and fair weather experiments such as we undertook on the German warships.<sup>20</sup>

That the targets were stationary in both cases constructs an even closer analogy that throws into strong relief the dominating factor of actual hostilities. Cases of such similarity with so opposite results are not without their lesson. There is conveyed the admonition not to place a too-heavy responsibility on the new instrument now so in the ascendant; <sup>21</sup> not to ignore them certainly, but we

<sup>19</sup> Ex-German battle cruiser *Goeben*, 23,000 tons, transferred to Turkey in September, 1914. Of 28 knots speed, she was armed with ten 11-inch, twelve 5.9-inch and 4.7 anti-aircraft mounts.

<sup>20</sup> "During her sortie and attack on British monitors at Imbros (the *Sultan Selim*) in January, 1918, she struck at least one mine, whereupon she settled by the stern and took a list of some 10 or 15 degrees. While proceeding slowly up the Dardanelles she was vigorously attacked by aircraft and was hit several times. Finally she ran ashore at Nagara Point, and was during a whole week subjected to the most persistent and energetic attacks by British naval aviators, who made no less than 276 flights over her and scored a number of hits. Nevertheless she was refloated, went to Constantinople under her own steam and was repaired." Hovgaard, *Modern History of Warships*, page 241.

<sup>21</sup> In discussing the concluding operations of the German cruiser *Konigsburg*, when she was finally blockaded in the Rufiji River, East Africa, by Captain Drury Lowe in H. M. S. *Chatham*, Sir Julian S. Corbett, in his official history of the war's naval operations, says: "Having by this skill-

are warned to be slow in withdrawing the known safety of tried and proved weapons until the new have proved themselves against something more concrete, more substantial than a hulk floating on the surface of the sea. The time to perfect a weapon is unquestionably in peace; the last determination of its value is in war.

The operation of sea-power and the success of naval armaments is subject to certain principles, and though the evolution of weapons and motive power may have changed the aspect of tactics and the application of these principles to the time, they have remained basically unchanged since Salamis, since Rome forced Hannibal to a disastrous action in northern Italy because her navy dominated the western basin of the Mediterranean.

Their recognition, unconsciously adopted perhaps, but persistently and closely applied, won for England the preponderance of seapower she has exercised for four centuries; enabled her to maintain almost wholly by maritime tendons her great, loosely-knit empire. That the defeat of fleets and consequent decline of naval powers is directly due to a misapplication of these principles, the ignoring of one or more fundamentals, history readily shows. And to those who will see, the close parallel of these oversights and the inevitable penalty exacted for them, submits a consistent analysis and reads a dark prophecy for the future of our political influence as backed by naval strength necessary to the stand, in international questions, of an isolated nation.

In tonnage and man-caliber ours is a great navy and it is farthest from the writer's thoughts to hold brief for a greater. But it is incomplete, and in the light of the present faces a serious crippling from well-meaning but uninformed legislation that threatens, as it were, to kill it with kindness.

---

ful operation (sinking a block ship across the river channel) imprisoned the *Konigsburg*, at least for the time, the next step was to endeavor to destroy her. But this was no easy matter. She lay so high up amongst the tall jungle that fringed the river that the cruiser's guns (the *Chatham's*) could not reach her, and gunboats could not see her. She could only be got at with the aid of troops or by bombing. But no troops were available and the seaplane that had been sent was unequal to bombing attack."—*Official History of the War*, Naval Operations, page 389.

Though the *Konigsburg* was located October 30, 1914, it was not until July the following year that she was destroyed by gunfire from the British monitors *Severn* and *Mersey*. The seaplane referred to in the text had, operating from H. M. S. *Kinfauns Castle*, previously carried out a successful reconnaissance and located the *Konigsburg* at her jungle anchorage.

When men have devoted a lifetime of study and effort to the invention and application of the involved instruments of war only to find their judgments at fault in the severe laboratory of actual hostilities, discover that devices on which they placed high hopes fail utterly; that other devices relegated to a minor importance suddenly occupy the center of the stage and by their achievements necessitate some great defensive expansion in a wholly unlooked for quarter, it is hardly reasonable to expect others, who have devoted energies to more peaceful pursuits, business, industry, politics or administration, shall possess an infallible foresight, the absolute sense of values along these very technical channels.

That is precisely the idea this nation entertains; it is what is expected from the members of its governing body. It is so written into the laws. Through a palpable misapprehension, a misdirected effort toward economy, they invest the bodies who appropriate moneys for national defense with the authority, aye the responsibility, for directing how it shall be spent.

The laws governing appropriations for work in the military and naval services provide that such work shall be specifically outlined in the bill authorizing the appropriation, and that the money shall be used or diverted to no other purpose. If not all expended in the completion of the work authorized it shall be returned to the national treasury at the close of the fiscal year. This short-sighted policy, designed in the interest of economy (like the "cost plus 10 per cent" contracts with which we had such costly experience in the last war) lends itself readily to the practice of extravagance, is a knife that cuts two ways. It kills initiative, deprives the executive in charge of the expenditure of such money from using his judgment and skill in seeking and employing short cuts to get out the work in the shortest time and at the minimum labor charge. Should he perceive a saving, an opportunity for economy, the logical assumption is that he will avoid it. For this reason, not being allowed to divert the money thus saved and employ it in some other phase of his work where he sees need of it, it is obviously against his own interest to have any surplus at the end of the year. Suppose he returned 30 per cent of the money administered in his charge; his requests and estimates would probably be cut for the following term by that amount on the assumption that if he did it once this cheaply he should do it all the time. This in complete disregard of the fact that the officer might be unable to effect the

economy a second time or regularly, it resulting once from some extraneous condition or local circumstance. So instead he is moved to spend everything he can get and the next year ask for more than he needs in the moral certainty that he won't get enough. Is this an excellent and efficient method to administer an organization of the size of our military establishments? How long would a shipyard or any private industry endure under such a régime? How long, after bankruptcy proceedings, would it take the stockholders to land the directors in jail? The people of the United States are the stockholders in the navy, our national insurance company. A naval officer who had made a close study of naval administrations previous to the war recently declared that in the period 1911-14 Germany could by direct methods and efficient management put three capital ships in the water for the cost of one of ours. The fault lies directly at the threshold of our federal legislation.

A valuable page might be torn from England's book in the administration of our navy. There Parliament votes the Admiralty a stated sum as the naval budget, based on their requests to cover maintenance and expansion over a given period. The money appropriated is then expended to the best effect and for the needs of the fleet as they are realized by experts who have made the navy a profession; not as the House of Commons or Lords thinks it should be parceled out.

The manner in which Congressional Committees at Washington, ostensibly seeking information as to the best way to spend the nation's money in these matters, contrive to get misinformed or informed not at all, is, to say the least, discouraging. They bring out not useful facts, but usually nothing more than dreary proof of their utter lack of comprehension of the matter in hand, that which they are supposed and which it is their duty to be most closely in touch with. Quoting an article by a naval officer and introduced by Mr. King in his above referred to speech when touching on the submarine situation, it was declared that "At the hearing before the naval committees of the House and Senate during the consideration of the current (1921-22) Appropriations Bill by Congress, previous to March 4, it is astonishing to note that not a single naval officer who had actual experience in submarine warfare was called upon to testify. The so-called 'director' of submarines, who is thoroughly informed on the subject, though he has no real authority to direct submarine policy, was not permitted or invited to

appear and present the facts concerning deficiencies and crying needs." This might be excused in some quarters on the ground that the testimony suppressed might be needlessly disturbing.

In spite of great battleship power and apparent weight, our navy, in its unbalanced state, is incompetent.<sup>15</sup> It lacks features necessary to the whole, the proper functioning and use of which only will give to the whole its fullest scope. Representing as it does an investment of billions, its administration should be such as to render it at all times capable of exerting its full force. It should not be hampered by deprivations of material nor forced to submit to the technical conclusions and deductions of statesmen for that mechanical perfection which must be its only excuse for existence—its instant availability. Better have no navy at all than one in which we repose a false security, that may fail us when we have moved on the checkerboard of the world with the consciousness of its full support.

The dependence of effective sea-power on its undeviating basic principles cannot be too often reiterated. It is in indifference to these principles, largely through ignorance of them, regardless of pleas and criticisms of men who sail the ships, by the bodies who now administer the navy that the peril of our one day paying a heavy reckoning lies.<sup>16</sup> And who knows, in the present world

<sup>15</sup> "Under modern conditions of warfare battleships are not self-contained tactical units. More than ever they require for their assistance and protection a variety of attendant ships of different types, the most important of which are battle-cruisers, light cruisers, destroyers, submarines and aircraft. Each of these classes, besides being indispensable as tactical adjuncts to the battleships, also supplement them strategically and are required for a variety of independent duties.

"Depending on the nature of the operations, a fleet of modern battleships needs also the more extraneous assistance of mine-sweepers, mine-layers, and a host of auxiliary vessels."—Hoygaard, *Modern History of Warships*, page 480.

<sup>16</sup> "Naval policy is pursued in peace conditions under inevitable disadvantage in a democratic country, because there are many claims on the exchequer. Reviewing our pre-war programs of ship construction and equipment, and bearing in mind the unconsciousness of the nation generally as to the imminence of war, it is a matter for satisfaction that the boards of admiralty from the beginning of the century were able to achieve so much . . . securing for us inestimable advantages as, I hope, I have demonstrated in my record . . ." Sir John Jellicoe, "The Grand Fleet." Discussing German superiority in material, he says: "We did in fact obtain a margin of safety (numerical) in the most essential type of

unrest, but the exacting of that payment awaits us just around the corner?

The plea for the "three-plane navy," air, surface and subsurface, of which much has been heard, is sound and reasonable. But one plane must not be intensively developed at the expense of the others, for none of them can be effective alone! We cannot overlook the still crying necessities of the surface. We have invested too much to stop now and by reckless frugality eliminate the necessary auxiliaries that will render impotent the costly foundation with which we are possessed.

The most thorough economy is adequate safety and protection. It does not require a strategist to determine that our first line of "non-aggressive" defense is not the seacoast, but beyond.

The broadest distinction that can be drawn in a discussion of military and naval preparedness is the amount of time and labor involved in the building of a warship, and the slow, necessarily careful training of the personnel required to animate and fight the ponderous, intricate mechanism that is a city and a fort within itself. That it is a cold impossibility to put a fleet on the fighting line within years of the time that an army can be organized and thrown into the field was demonstrated past argument in the war.

The United States trained, equipped and transported to the fighting areas two and a half million soldiers, beside the additional reserve being continually augmented at home. In the navy, though, the requirements necessitated a large force of destroyers, with which we were not particularly well supplied. The rush contracts, when it was seen what was needed, provided for about 250 of the new "flush-deck" destroyers (in addition to those of the same design being completed under the 1916 program). Despite the fact that in all yards capable of building this not large or particularly complicated type, with work suspended on capital ships and production concentrated on the destroyer, only seven were completed in time to engage in actual war operations. The rest were finished, drifting into navy yards for commissioning, as late as May of this year. The essence of strategy, as one writer puts it, lies not in finding a defense after an attack has been launched, but rather in anticipating each successive development of offensive with a means to combat it at its source.

---

vessel, the capital ship, and we did gain advantage from the heavier caliber of our guns."



## VI

Due to our political and geographical situation, the work the navy will be called upon to perform in the event of war against a single power, is generally determined. Our strategy, and also particularly the tactics to meet a given situation, are subject to broad rules of circumstance and can be predicted within general limits.

The fleet's want of essential constituents that will necessarily be contributory to its operation, its success or failure as a fighting force, are matters of common knowledge. The utter absence of the battle-cruiser type and the insufficient force of fast cruisers and scouts " is the cardinal weakness and it is of such importance as to determine the naval tactics of an enemy operating against us, basing their plans on that weakness. In the important point of control of the air we are not so irreparably behind other powers as to preclude recovery, to make it comparatively so vital a defect. Moreover, the condition and equipment of the aircraft industry in the States, the speed of their production compared with the prolonged period of a warship's construction, stresses further the need for completing the vessels of these types we have under construction: not, on the authority of certain gentlemen of Congress, allow them to die of inanition.

Americans as a people and those directing channels of opinion here have been usually careless students of history. They have too easily forgotten or perhaps never realized it was the protection of the prepared and efficient British Navy that enabled us to retrieve the military omissions and mistakes of the years preceding our entrance into the war. It was in the security of their silent Grand Fleet, hidden in the mists of the Orkneys, that our blunders were overcome with feverish haste and appalling cost; others made and retrieved, till at last we were able to throw our full weight into the conflict, probably as the decisive factor. In possibly no other combination of politics and treaty can we ever again employ the friendly protection of such an organization of steel and manhood; to repair behind its impregnable front the mistakes of peaceful years. We are warned, therefore, to consult our safety and the proper means to assure it. The next war will find us alone with our antagonist, with the world looking on.

" We now have ten of these vessels (7100 tons, 35 knots, 8.6-inch guns) only two of which are well advanced. The completion dates on the others are "indefinite." We should have twenty-five or thirty.

The period of colonial expansion succeeding the Spanish war, our penetration of the Pacific, the Far East and the Caribbean carried with it increased responsibilities and incurred for us a new and imperative interest in world affairs; there devolved upon the navy graver and more complicated duties. The nature of them was immediately reflected in the design of the first-line ships, which from coast defense vessels previously fulfilling every requirement of our strategy, there were developed sea-going types of greater size and increased radii of operation. With the enlarged demands met in the design, there also arose the necessity of types of ships we had hitherto not possessed in any force, and for which we had had no particular use. These were particularly the fast cruiser types, and—since the *Columbia* and *Minneapolis*, of 1892, which were in a measure ahead of their time—in twenty years only feeble and occasional effort has been made to meet this need.<sup>18</sup> The importance of these vessels and the manifold duties with which their capabilities endowed them were thoroughly determined in the war.

While in the foregoing the battle-cruiser has been dealt with largely in a comparative sense, its fundamental relation to proper fleet operation is self-evident. The complete recital of their functions is not within the scope of this discussion and the reader is referred to authoritative works that fully treat with this important arm. The fact that we have none, that the start made on the six authorized seems in a fair way to be atrophied by efforts to turn them into something they are not, or suspend construction, with heavy loss and the more than even chance of their total abandonment, cannot be viewed but with the keenest apprehension. They may be termed the keystone of the efficient navy. Without battle-cruisers, in a campaign in the Pacific our fleet could be brought to virtual impotence without having seen the enemy battle-fleet or brought them to action. They dare not leave our coast for inability to protect their communications and supplies, the lines of which would be instantly imperilled by the enemy's battle-cruiser force.

This is a fair appraisal of a situation urged and brought about in the name of economy and based evidently on an exiguous hope of lasting peace.

<sup>18</sup> The *Chester*, *Birmingham* and *Salem* (1908), 24.5 knots, 3800 tons, two 5-inch and six 3-inch guns. These vessels were virtually experimental boats and nothing was done from the lessons drawn from them.

War at the present time, economists assert, is a physical impossibility. Money enters their discussions as the prime prohibitive factor. Several facts face us. Japan emerged from the World War with greater profit for her investment than any belligerent; the only participant, in fact, who is the clear gainer. There has been little effort to disguise her ambitions in the Pacific, and she is there the only power pursuing an aggressive policy. In 1890 Japan was declared to be too small, too weak, too poor to fight China. She won the Chinese war in 1895, and under like unfavorable predictions defeated Russia in 1904-5. She has developed as a result an intense national spirit and confidence that bids to carry her far. The fruits in territory and authority accorded her at Versailles could not but confirm and enlarge this self-estimate and seem to sanction the propriety of her aims. Acquisition of the German archipelagoes, in addition to broad mandatory powers, established a foothold and interest in the Pacific that she immediately came to regard as indispensable to her existence as an empire, any question of which she is prepared to protest vigorously. Her dreams of expansion are just beginning to be realized and the nation, as a man, is bending every effort to the accomplishment of its splendid vision. Japan is at this time spending a greater proportion of her revenue on naval maintenance and additional construction than any nation has before in history. On paper the third most powerful, but actually the second, she defers only to England in naval strength. She is forced to go on with her stupendous program, according to her statesmen, because of threats, potential or otherwise, against her integrity in the Far East. She is now said to be in extreme straits financially as a result of this heavy armament program, and she will sit at the disarmament conference in short mood to listen to discussions of authority in the Far East, which she has come to believe are for her sole disposal. Economists aver that she cannot undertake a war because of her lack of financial resource.

It is interesting to recall that primarily lack of money and the prospect of industrial stagnation and bankruptcy, rather than a glittering illusion, inspired in the Germans their dream of world conquest and moved them to their threat at civilization. It was for Germany a simple sum in economics; the available markets for her merchandise had been cultivated to their utmost limit; she was at the end of her resources in the great armament race whose pace

she had set; the density of her population and the immediate need for expansion, the creation of new markets for the surplus production of her highly organized industries and the feeding of the overpopulated homeland, made imperative the acquisition of new territories that could only be had at the expense of other nations. She had the tools of war, and certainly from her point of view was so situated as to justify their opportunity. Billions of foreign capital were invested in the industries of the fatherland, its mills, mines and railways. The real property and the raw materials—the only things the possession of which constituted absolute ownership—were in her hands. She was bound to her creditors simply by a promise to pay. What was a simpler solution than to abrogate her debts through war and by conquest acquire territory, expand into new markets, and with new lands to develop and exploit, relieve by emigration the overcrowded home states, plant the flag of the fatherland in all quarters of the globe and gain not in one direction, but several?

This is a situation one phase or another of which may be experienced by any nation geographically restricted, in the course of rapid expansion, in its transition from obscurity to greatness. The point of view of its statesmen in their scrutiny of the case will be, as it were, from the under side; from that angle, where there being little to lose, all arguments towards a trial by force are favorable. A small nation seldom engages a larger in war except under conditions where the advantages to be gained far outweigh the costs even of a probable defeat.

From Japan's viewpoint, a nation contesting with her the supremacy of the Pacific will conduct a war under circumstances overwhelmingly in Japan's favor; a war, where what she risks in defeat is so inconsiderable beside the infinite possibilities attending a victory that it would be a chance well worth taking, an opportunity where her own magnificent equipment, for what would be primarily a naval war close to her own bases, could be utilized to the fullest advantage.

It is not in the key of an alarmist that these conditions are adduced. They are facts of very general information, briefly reviewed for their application to our own position, for the future relation they may have to the irrational naval policy we are pursuing. This policy admits of quick correction with little fuss and, for the premium of security attained, at small expense. It urges

simply the completion, with minor modifications of something we undertook before we were involved in the World War, in which we have already heavily invested, a naval program dictated by an analysis of conditions as they affect us alone.

Even though the corrective be applied and we move again with reason and progress, with a thoroughly equipped, well-balanced naval service, this favorable condition will have but short tenure. For the cause of its present inefficient state lies deeper than an injudicious apportioning of matériel; it has its fundamental weakness in the nature of our legislation. It lies in the wielding of the all-powerful financial club by Congress to retain their supervision in the technical administration of the navy and the army. Vacillations of policy such as shown in the last year, betrays the inability of the political intellect to grasp the fundamental of defense, its versatility, its flair for the distractions of the moment. Until the military services with their governing boards shall have unhampered disposal of the funds voted them, to be used as training and experience approves, a sound policy along these lines, however well planned and initiated, can never be pursued to its conclusion through a term of years or a succession of administrations.

The experiments off the Chesapeake Capes last summer, in addition to serving as a basis for much misleading oratory, placed us perhaps on the threshold of another epoch in naval warfare, as important with relation to future development as the *Monitor* and *Merrimac* were to the evolution of the battleship.

The net result of the sinking of the ex-German warships, however, may be summarized as a sweeping victory for the depth-charge. As indicative of the destructive possibilities of the aerial bomb acting as such, it was valuable and interesting. As argument for the military superiority of the airplane over the fighting ship, it was spectacular but unconvincing. That decision will be dictated by development that will come—if ever it does come—far in the future.

When the airship is built that can maintain itself in its element with the reliability, safety and continuance with which the big-gun ship can keep the sea, then may the predominance of the surface battle-fleet be challenged from above, and on equal terms the survival of the fittest be determined. Then, and not until then, can the place of the capital ship, as the dominating factor in naval strategy be seriously called into question.

# United States Naval Institute Proceedings

PUBLISHED MONTHLY  
EDITED BY F. M. ROBINSON



U. S. NAVAL INSTITUTE  
ANNAPOLIS — MARYLAND

**COPYRIGHT, 1921**  
**By J. W. CONROY**  
**TRUSTEE FOR U. S. NAVAL INSTITUTE**

**The Lord Baltimore Press**  
**BALTIMORE, MD., U. S. A.**

*The writers only are responsible for the contents of their respective articles*

## CONTENTS

---

USE OF AIRCRAFT IN NAVAL WARFARE. By Commander D. E. Cummings, U. S. Navy.....	1677
THE SALVAGE OF THE "LEONARDO DA VINCI." By Lieut. Colonel A. Guidoni, Italian Navy.....	1689
RIGID AIRSHIPS. By Lieut. Commander Garland Fulton (C. C.), U. S. Navy.....	1697
THE NAVAL OFFICER AND THE CIVILIAN. By Professor William O. Stevens, Department of English, U. S. Naval Academy.....	1725
YAP. By Commander B. C. Allen, U. S. Navy.....	1741
ACROSS THE CONTINENT WITH AN INSANE MAN. By Admiral R. E. Coontz, U. S. Navy.....	1749
THE STUDY OF HISTORY FOR NAVAL OFFICERS. By Commander C. B. Mayo, U. S. Navy.....	1755
T=C-W. By Lieut. Commander James C. Van de Carr, U. S. Navy.....	1763
TACTICAL AND FIRE CONCENTRATION PROBLEMS AND THEIR SOLUTIONS. By Lieut. Commander H. W. Hill, U. S. Navy.....	1765
A SOLUTION OF THE OFFICER PERSONNEL SITUATION. By Lieut. Commander F. G. Blasdel, U. S. Navy.....	1779
SECRETARY'S NOTES.....	1787
PROFESSIONAL NOTES.....	1791
NOTES ON INTERNATIONAL AFFAIRS.....	1847
INFORMATION INDEX.....	1789



# OFFICERS OF THE INSTITUTE

---

## *President*

REAR ADMIRAL BRADLEY A. FISKE, U. S. NAVY

## *Vice President*

REAR ADMIRAL HENRY B. WILSON, U. S. NAVY

## *Secretary and Treasurer*

COMMANDER F. M. ROBINSON, U. S. NAVY

## *Board of Control*

REAR ADMIRAL BRADLEY A. FISKE, U. S. NAVY (*ex officio*)

REAR ADMIRAL HENRY B. WILSON, U. S. NAVY (*ex officio*)

BRIGADIER GENERAL GEORGE RICHARDS, U. S. M. C.

CAPTAIN JOHN HALLIGAN, JR., U. S. NAVY

CAPTAIN J. A. FURER (C. C.), U. S. NAVY

COMMANDER JOHN DOWNES, U. S. NAVY

COMMANDER J. O. RICHARDSON, U. S. NAVY

COMMANDER F. M. ROBINSON, U. S. NAVY (*ex officio*)

# PAST PRESIDENTS

---

ADMIRAL DAVID D. PORTER, U. S. NAVY, 1873

REAR ADMIRAL JOHN L. WORDEN, U. S. NAVY, 1874

REAR ADMIRAL C. R. P. RODGERS, U. S. NAVY, JAN. 1875—JAN. 1878

COMMODORE FOXHALL A. PARKER, U. S. NAVY, JAN. 1878—JAN. 1879

REAR ADMIRAL JOHN RODGERS, U. S. NAVY, JAN. 1879—JAN. 1882

REAR ADMIRAL C. R. P. RODGERS, U. S. NAVY, JAN. 1882—JAN. 1883

REAR ADMIRAL THORNTON A. JENKINS, U. S. NAVY, JAN. 1883—OCT.  
1885

REAR ADMIRAL EDWARD SIMPSON, U. S. NAVY, OCT. 1885—OCT. 1887

REAR ADMIRAL STEPHEN B. LUCE, U. S. NAVY, OCT. 1887—OCT. 1898

REAR ADMIRAL WM. T. SAMPSON, U. S. NAVY, OCT. 1898—OCT. 1902

REAR ADMIRAL H. C. TAYLOR, U. S. NAVY, OCT. 1902—OCT. 1904

REAR ADMIRAL C. F. GOODRICH, U. S. NAVY, OCT. 1904—OCT. 1909

REAR ADMIRAL RICHARD WAINWRIGHT, U. S. NAVY, OCT. 1909—OCT.

1911



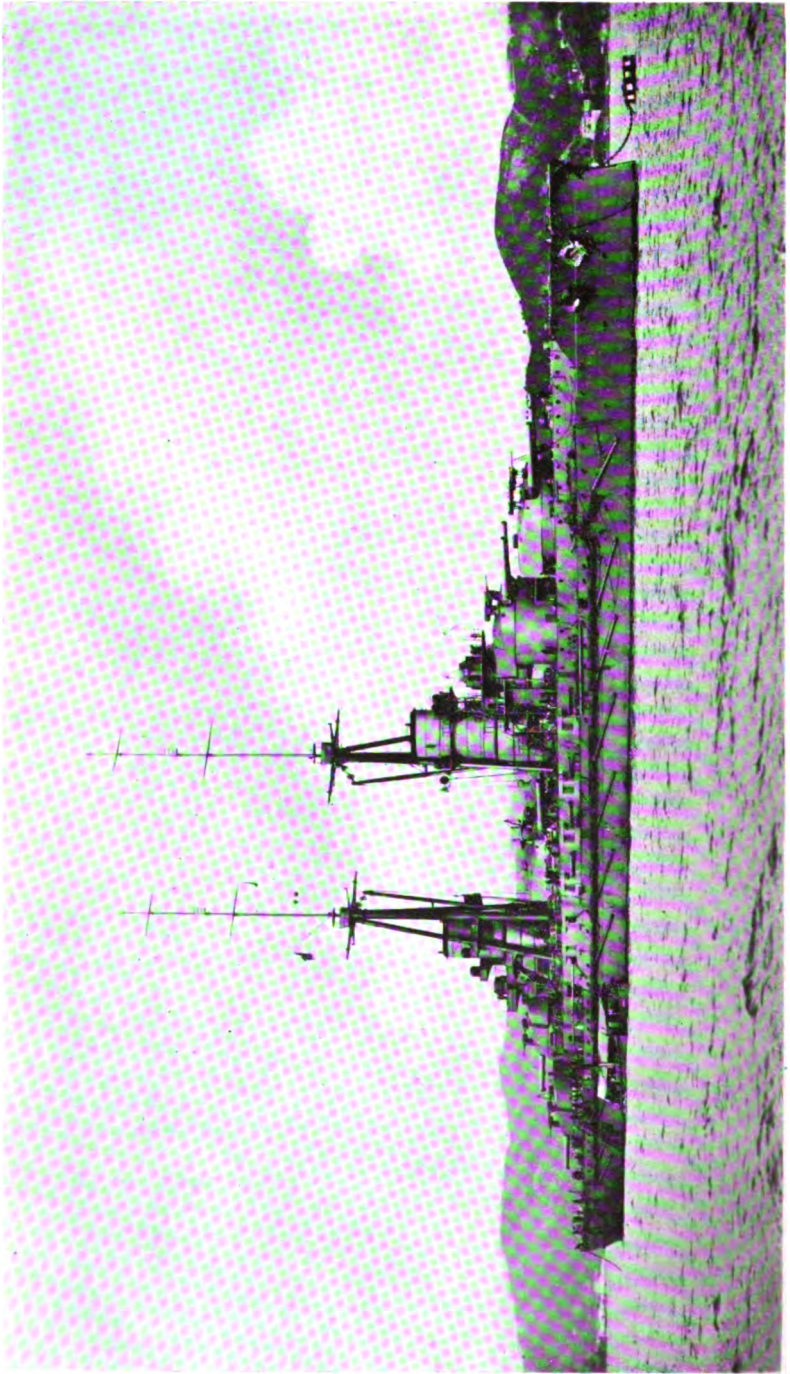

R. N. "LEONARDO DA VINCI"

# UNITED STATES NAVAL INSTITUTE PROCEEDINGS

---

Vol. 47, No. 11

NOVEMBER, 1921

Whole No. 225

---

[COPYRIGHTED]

U. S. NAVAL INSTITUTE, ANNAPOLIS, MD.

---

## USE OF AIRCRAFT IN NAVAL WARFARE

By COMMANDER D. E. CUMMINGS, U. S. Navy

---

Aircraft appeared in the great war as a new instrument of warfare. They are still a new instrument, whose development is incomplete, and imperfectly understood. In order, therefore, that their use in warfare may be developed and that officers may be enabled to employ them intelligently it is necessary to consider (a) the performances of which they may now be considered capable, (b) the limitations to which they are subject, and (c) the direction in which they may be expected to develop.

In general, aircraft are of two types, (1) heavier than air, and (2) lighter than air. Heavier than air machines are designed to alight on land or on water; and some of each type are fitted to land, in emergency, on either element. The heavier-than-air machines in use at present are all planes.

Another type of heavier-than-air machine, known as a helicopter, or gyrocopter, is in process of development, in which the propeller rotates on a vertical axis. This will differ from the airplane in that it can take off, alight, and maneuver without maintaining a high horizontal speed component.

Lighter-than-air machines include free balloons, kite (captive) balloons, and dirigibles. The free balloon is the old circus variety which, when released, is entirely at the mercy of the wind, and which can be controlled only by tethering it and by varying the

weights carried, or gas pressure in envelope. The kite balloon is a captive balloon, with devices to keep it headed into the wind. The dirigible is a free balloon with motive power and steering apparatus added.

The value of aircraft in war lies in a number of factors, such as their mobility, their vision, their speed, the difficulty of attacking them. They can observe places otherwise inaccessible for observation. They can operate over either land or sea, they can reach and depart from a point of vantage for observation and bombardment with great speed, they can get a bird's-eye view of the earth's surface within their radius of vision, which angle gives them a much truer and more complete picture than a view from near the surface. In many cases they can reach and depart from their vantage point without disclosing their presence. Their advantage of vision lies both in the angle from which they observe and in the speed with which they come and go, and, sometimes, in the distance they can see.

Range of vision varies extremely according to conditions. At Philadelphia, on a hazy day, planes rose above the haze and saw Atlantic City, 60 miles away. On a clear day, planes at Hampton Roads saw ships at sea clearly, in detail, at 30 miles, and saw the smoke of Richmond, 90 miles away; while the day before the same plane, spotting for firing ships, at a height of 1500 feet over target could see the target but could not see even the flashes of the guns of the firing ships. No rule for visibility of, or from, aircraft can therefore be of great value. Haze at different altitudes may be indistinguishable from deck and yet reduce vision of aircraft materially.

The visibility of aircraft is very variable. A 100-foot flying boat operating as part of a squadron in the clear daylight weather of Guantanamo was completely lost sight of by a similar boat at a distance inside of five miles; while the *NC-4*, approaching Lisbon, silhouetted against the western sky at sunset, was picked up at a distance of perhaps 20 miles.

Generally, planes are least visible when flying low, headed directly toward or away from the observer. They are most easily picked up on a clear day with high stratus cloud formations; and are difficult to pick up on the average clear day when there is a certain amount of haze. Usually there is no smoke to give them away, though the smoke of the *NC-4* was picked up at Lisbon



BOMBING THE EX-GERMAN "FRANKFORT."



before the plane. Protective coloration is not effective in the case of planes seen from below, as the visible part of them is always in shadow and looks black at a distance. Relative to ships, in most conditions, the small size of the plane makes its visibility less than its vision.

Lighter-than-air craft can be painted to be very inconspicuous under particular conditions, but under other conditions will be seen much further than they can see. Kite balloons frequently disclose the presence of the ships carrying them long before they themselves see anything.

The tactical qualities of aircraft are generally similar to those of ships. Every aircraft is a compromise, exactly as a ship is a compromise, between the various desirable factors, the preponderance of the one or the other being governed by the requirements of the service to which the aircraft is to be put. The tactical qualities may be said to consist of speed, radius, turning circle, acrobatics, carrying capacity, minimum flying speed, size, climb, ceiling, take off, landing, mooring requirements, seaworthiness, airworthiness, battery. Some of these depend to some extent on others. Thus acrobatics depend on speed and available power, but also on properly proportioned structural strength and on rudder effect. Take off depends on minimum flying speed and climb, and is governed (in the case of water-borne craft) by hull shape, so that the craft cannot take off until it has speed enough to remain in the air, else it would hop from wave crest to crest and smash itself up. Power, weight per horsepower, and lifting area govern the capacity of a given plane.

The carrying capacity of aircraft is strictly limited by the design. This carrying capacity may be used for equipment, fuel, crew, armor, armament. Thus a bomber can greatly increase his radius by carrying extra fuel in place of his bombs, and a large machine can carry many passengers a short distance at the expense of fuel. Many extraordinary aircraft performances are therefore of limited value as indicating the practical possibilities of aircraft, inasmuch as they are accomplished by dispensing with other things that are necessary to practical work.

Aircraft have been armed with machine guns, Davis guns up to 3-inch, automatic cannon up to 75-mm., bombs, torpedoes. Machine guns are mounted in small fighting machines either to fire between the blades of the moving propeller, being synchronized



with it; or to fire through the hollow propeller shaft, or upon movable mounts, firing clear of propeller in any direction. Large craft usually have machine guns mounted to fire clear of the propeller, in any direction. Synchronized guns must be fixed, and are aimed by aiming the aircraft. Armor has not generally been employed in the past, but is increasing. Engines, gas tanks, and pilot's seats are generally the essential points to be armored. Special means to accomplish some of the ends served by armor have been devised. Thus non-inflammable gas for balloons has been developed; gas tanks that will not leak when punctured, etc.

Aircraft are subject to certain limitations that govern the uses to which they may be put. Many of these limitations are subject to constant change as material and the knowledge of it develops. Thus the weight which may be lifted by a plane of a given power and speed is a function of the area and efficiency of the lifting surface and of the wind resistance. In a given type of machine, as the linear dimensions increase, the ratio of useful load to gross load increases less and less rapidly, so that, beyond a certain point, increase of size can only be obtained by lightening the load, by increasing the ratio power to weight of engine, by sacrificing some tactical features, or by changing the type. All these matters are being studied constantly; engines have reduced their factors of safety to a minimum, but new types of greater power per unit of weight may be developed; new types are being studied constantly. New methods of obtaining strength with less weight, and of streamlining are being developed. Very great increase in airplane size would seem to be dependent very largely on the development of an entirely new power plant, the present type having approached its maximum perfection. The resistance due to struts, wires, etc., known as "parasite" resistance, is a minimum on a monoplane.

One of the greatest limitations to which aircraft are now subject is life of the materials employed. The safe life of aircraft is limited by deterioration of wing fabric, struts, etc., which cannot always be detected from the outside. Obviously that limitation will be gradually removed as materials develop. Engines can be renewed bodily at will. The average safe life of a Liberty engine, which in its field compares favorably with any other, between overhauls is 75 operating hours. After a total of 215 hours they are not considered safe. That limitation also is subject to change, but not so much as in the case of the structural parts because,

(a) they have already been reduced to an approximately minimum factor of safety, and (b) engine failure in the air does not in itself mean certain disaster, as failure of important structural parts frequently does, because landing can be made without power if a suitable landing place is available within effective gliding distance. Probability of structural failure is negligible. At one air station, after a year's experience, forced landing averaged one in forty flights.

Aircraft are limited in their operations by the requirement that they must alight at suitable landing places. The requirements are (a) conditions which make a safe landing possible, and (b) conditions which will enable the aircraft to take off again. In order to land, a water-borne plane must have a clear water area, smooth enough for the type of machine, free from stakes or floating debris, and clear of interferences. To take off again, it must have these, and, in addition, a sufficient area in which to gather speed and climb clear of interference. More space is required to take off than to land. A land machine's requirements are similar, substituting for the water area a smooth field. In restricted areas wind direction must be favorable, especially for taking off. Lighter than air machines must alight where suitable unencumbered areas with specially designed, permanent mooring equipment are available, although it will probably prove practicable to moor out a dirigible without special equipment under favorable conditions.

Radius of action is limited by fuel carrying capacity. Possibilities exist in this line for the development of motors making more efficient use of fuel or of a more concentrated fuel or both.

Another restriction to the use of some types of aircraft is their limited habitability; but that can be met in large degree where necessary; the larger craft correspond to submarines in that respect.

The uses of aircraft in war include (a) scouting, (b) bombing, (c) torpedo firing, (d) spotting, (e) lookout, (f) combat, (g) escort, (h) attack on surface craft by gunfire, (i) despatch carrying, (j) transportation.

(g) is of particular value in submarine danger zones, since underwater craft can, in many cases, be clearly seen from aircraft, which can guide surface craft to the attack, point out safe courses for non-military vessels, or drive the submarine under

by bombing attacks or gunfire. The essence of defense against submarines is vision, which aircraft possess in the highest degree.

In the east coast of England submarine zone, large convoys passed constantly. Submarines always menaced them. Sinkings were daily occurrences. During five months of aerial patrol in this area, not a single sinking occurred in the presence of airplane patrols except one, and in that case the plane was on the surface of the water, in tow, and obviously unable to take the air.

Aircraft are particularly suited for scouting work, on account of their speed, and vision. They are handicapped, in this duty, by (a) their limited radius—they cannot expect to alight at sea and await fuel, as has been done by destroyers during the war, except under favorable conditions or as development progresses; (b) their limited radio range, which can be increased indefinitely if the circumstances justify the carrying of the extra weight; (c) defensibility—due regard must be had to the nature of the opposition that is to be met, whether it can be beaten off or avoided, or whether visibility conditions are such that the machines can see without being seen or heard—which would be their best defense; (d) reliability of motors. In machines that are operated alone over the high seas, much must be sacrificed to reliability, else the ratio of results to cost would be too low to warrant the free use of this valuable instrument.

A letter dated at Hampton Roads, 27 April, 1920, speaking of the Atlantic Fleet Air Detachment, says:

We have just arrived here, yesterday, from Guantanamo, via Nuevitas, Turtle Harbor (near Miami) and Fernandina, Florida, and Southport, N. C.....we are anchored west of the operating base with the planes anchored just outside of the submarine basin. The people at the Air Station can't quite get it through their heads that we don't want anything from the Station, but we simply don't. These planes will be turned in to the factory. They have been in service since we got them last October, and have had about 150 hours in the air apiece..... From Guantanamo each flight has been without casualty, except that one plane landed once for a few minutes to change a distributor head." This detachment consists of six F-5-L flying boats with two Liberty engines each; and has visited Philadelphia, Hampton Roads, Pensacola, Guantanamo, Samana Bay, Virgin Islands, and other West India Islands and intervening points.

Dirigibles are especially adapted to long distance strategical scouting, where they are not liable to meet effective aerial resis-

tance, on account of their great radius and ability to remain in the air without consuming fuel, while planes must keep going at high speed to remain in the air. . . . (e) A further and most important consideration is the question of navigation, which will be treated in some detail below. Within its radius, the conventional methods of search by surface vessels are all open to aircraft, remembering, however, that the aircraft course and speed made good is always the resultant of its own speed and course through the air and the speed and course of the wind. Thus a change of course may involve a difference in speed over the water of twice the velocity of the wind. If the wind is force 5, that means a 50-knot change of speed. "Scouting and Screening" also gives certain methods of utilizing ship planes to increase an area searched or to decrease fuel consumption in covering a given area.

The problem of bombing aircraft is purely an application of the principles of gunnery. In gunnery, the angle of discharge of the projectile is varied to suit the relative positions and speeds and courses of ship and target, while in bombing the angle of discharge is fixed and the position of the aircraft is varied to suit the speed and course conditions. The elements involved are (a) speed and course of aircraft relative to target, (b) altitude, (c) bomb trajectory. The component of the bomb trajectory resulting from the speed of aircraft is much greater, obviously, than the corresponding element in the case of a firing ship. The bomb trajectory depends upon coefficient of form and specific gravity of the bomb, and to some extent on lateral wind effect on bomb. Relative speed and course depend upon air speed and course of aircraft, direction and velocity of wind, course and speed of target. If these three, or their resultant, and the altitude can be accurately determined, the problem of bombing becomes largely one of mathematics. The tactics of bombing at sea under favorable conditions are as follows: (1) Set sight for airspeed for aircraft. (2) Set sight for altitude from altimeter. (3) By observation and estimate (quite accurate from air as regards course) set sight for target course and speed. (4) Approach up or down wind to determine direction of wind (which may be entirely different in upper air than below). Set sight for direction of wind. (5) Approach from right angles to wind to determine wind velocity. Set sight accordingly. (6) Approach on steady course, fire when on. This procedure, carefully followed through by a trained aircraft crew, in good air

conditions, will give results whose accuracy depends entirely upon the accuracy of the instruments and sight employed and upon the skill of the personnel.

Results of bombing practices under target practice conditions are of limited value as indicating actual results obtainable. In judging the figures, it should be borne in mind that:

(a) Bombs used are sub-caliber. At least 10 per cent greater accuracy may be expected from the full-size bomb.

(b) Present instruments are of limited accuracy, and calibrating, or "bore sighting," is not always adequately carried out.

(c) All firing is done with open sights, mechanically very imperfect. Greatly improved telescope sights are in experimental use now.

(d) Figures are misleading, in that the target area is a circle, while the pattern is usually an ellipse.

The recent exercises against ex-German ships are of more value, and indicate great hitting ability under favorable conditions.

The effectiveness of a bomb depends upon various factors. One is the penetration of the bomb before explosion. Another is the parts of the ship on which the explosion exerts its force. An aircraft carrier would make a very fine target, in this respect, as well as in size. Another is the speed of the projectile, and herein lies a difficulty, for the speed of a bomb is due entirely to gravity. While in a vacuum the speed would increase rapidly with the height from which dropped, actually a point is soon reached where air resistance balances the force of gravity and the downward speed becomes constant. This speed has been increased by streamlining the projectile. Recent experiments at Indian Head show better penetration results than had been anticipated. It is to be remembered that properly fused bombs will give depth charge effects even if an actual hit is not scored.

It has been authoritatively stated that: "Experimental development of the torpedo launching from aircraft is promising and there is no reason to doubt that ships may be successfully attacked in this manner. The tactics of this attack remain to be developed, but from a mechanical point of view no difficulty need apparently be anticipated." The method of launching torpedoes from airplanes consists in flying within a few feet of the water, heading toward the target, and releasing the torpedo, after which the

torpedo behaves precisely as does any other torpedo. The attack may be masked by a barrage of smoke bombs under conditions which will make the latter effective. In getting very near the water within torpedo range, the plane subjects itself to the possibility of zone shrapnel or fuzed H. E. fire from the entire battery of surface vessels, laying guns on the horizon and training on the plane. A very effective barrage might thus be laid. Even more effective would be a "splash" barrage ahead of the plane. This method was proposed for use in the British fleet. Wings, rudders, stabilizers, etc., are of fabric and would be wrecked by a splash; and the substitution of metal surfaces, as has been done in some planes, would probably not enable a plane to pass through a splash barrage. Aside from all the questions of directing the torpedo itself so that it may make a hit, it is difficult to launch one effectively. Too great height or speed will result in deranging a torpedo. Thus, when a service torpedo was recently dropped from a Martin Bomber at 35 feet, and at high speed, the head broke off and spun in the air when the torpedo hit the water.

Comparing torpedoes with bombs as aircraft weapons, it may be considered that: (1) A large proportion of the torpedo weight is taken up by machinery which has no destructive effect; (2) structural defense against torpedoes is highly developed; (3) zone fire and water barrage against craft within a few feet of the water and on a course giving small deflection promises many more hits than any high angle defense now in sight; (4) torpedo directors are better developed than bomb sights.

The usefulness of aircraft for spotting has been recognized by both the British and the United States navies. From the experience to date it may be stated that:

(a) Aircraft, from their position, can observe the fall of shot immensely better, than anyone on board ship.

(b) Aircraft can sometimes spot successfully when ship's spotters are prevented by (1) smoke screens, (2) thick weather, (3) target hull-down beyond horizon.

(c) Planes have thus far proved to be better spotting platforms than kite balloons.

(d) Planes can seek best position for observation, while kite balloons can vary position only in height. This is most important in practice.

(e) Planes, when up, do not hamper handling of ship. Kite balloons do.

(f) Communications are an absolute essential.

(g) Selective radio communication is to some extent possible to prevent interference of various spotting planes. Four planes have thus communicated without interference.

(h) Spotting is best done by planes carrying two or more persons.

(i) It is difficult, but by no means impracticable, to differentiate reasonably well between the salvos from various ships and between the targets that various ships are firing at.

Since kite balloons are much more vulnerable to attack from enemy aircraft than are planes, it may be considered that planes are the more desirable for spotting. When spotting, planes take position according to the visibility of the targets and to the effectiveness of the enemy's anti-aircraft measures. Their special value for the service lies in the fact that they can take position so as to accommodate themselves to existing conditions.

For simple lookout, as distinguished from scouting, an advantage of position over ship board observer is gained by the use of kite balloons. This advantage of position enables an observer, under favorable conditions, to see a submarine better than from deck. For surface craft, and for submarines not in favorable position, the advantage of vision is frequently offset by the added visibility. For observation of channels and along shore work they are useful. They are very vulnerable to attack from mobile aircraft due to their immobility and consequent helplessness.

Combat machines are usually small land planes of great speed, climb, and aerobatic ability, armed with machine guns for use against other aircraft. The maneuvers executed by such craft vary with the whim of the pilot; but consist generally in maneuvering to get the opponent under a quick momentary burst of machine gunfire without getting in his arc of fire. Defense against such craft by aircraft may be by out-maneuvering them along the same line, or, in the case of large planes, by machine gunfire from a large number of machine guns capable of firing in any direction. To render this defense adequate the problem must be met of eliminating "blind spots" and in large machines placing guns to fire in absolutely all directions. Lighter-than-air craft are not defensible against combat planes, nor, generally,

against planes of greater speed, climb, and ceiling, except that gun platforms have been rigged on top of Zeppelins, and it is probable that in future types guns will be so placed on rigid dirigibles as to be able to fire in all directions. The gunnery problem of combat planes involves such great speeds, variety of angles of approach, and quick turns, that long ranges are not attempted, and sight setting is practically non-existent, sights being designed with one fixed point and one movable, the movable one being controlled by the effective wind. Devices are usually added to assist the gunner in estimating the allowance for course and speed of the target relative to own plane. Training for this work is by means of camera guns, which photograph the target and show whether or not hits would have been scored.

Recent developments in airplane cannon seem to indicate that the use of cannon of 1-pounder, 3-pounder, and 3-inch is perfectly practicable. No exact data is available as to the use of these guns except that it is known that a high percentage of hits can be obtained on surface targets from altitudes up to 1000 or 2000 feet. These are not Davis guns, but automatic or semi-automatic guns of conventional type. Such guns suggest the feasibility of attacking light craft such as submarines and destroyers. The use of these guns or of machine guns to drive personnel from decks or from fire control tops is also suggested as an occasionally and probably practicable method of attack.

The question of anti-aircraft defense ashore and afloat differs materially for much the same reasons that gunnery differs. An essential part of any defense is a lookout sufficient to give ample warning of the presence of attacking aircraft. It would probably be impossible entirely to prevent observation of a naval base by enemy aircraft except by denying them a starting point within their radius. Operations to that end may be conducted by the use of longer radius observation aircraft with bombs or supported by surface craft. The use of artillery and splash barrage against planes would be effective in the case of planes flying very close to the water as to discharge torpedoes. Against lighter-than-air craft, in daylight, it is less difficult within gunnery angle ranges. The use of artillery against aircraft by ships is difficult and of limited effectiveness. Machine guns with a proportion of tracer bullets are effective within an altitude of 4000 feet when skillfully



operated. Defense of fixed positions against dirigibles and low altitude planes at night is most effective by means of curtains of streamers hung from lines supported by captive balloons. Such lines have been strung at altitudes up to 10,000 feet. The most effective defense for fleet and most other purposes is combat planes of our own, out-numbering and out-speeding the enemy's planes.

The navigation of aircraft presents the same problem as the navigation of ships, but with some features very greatly emphasized. Thus air currents are of unknown direction, and very speedy, so that dead reckoning frequently is entirely untrustworthy. Air currents vary in velocity and direction at various altitudes and at various places. An air indicating balloon released for observation purposes at Lisbon moved in a spiral covering 16 points of the compass before reaching 5000 feet. With a wind of 20 knots, that means that two planes steering the same compass courses at the same air speeds from the same place, but at different altitude would be 40 miles apart at the end of an hour. When landmarks are in sight, or ships, the course made good may sometimes be determined. It is sometimes possible to drop smoke bombs on the water and take observations of them. The taking of observations of the sun and stars is difficult due to inaccuracy of height of eye estimations. This has been overcome to some extent by development of a leveling sextant, which uses a self-contained bubble for horizon. The amount of apparatus that can be carried and used is limited by weight and space considerations. Observations are difficult due to the physical inconvenience of exposure to a wind of 60 knots or more while observing.

A very great aid to navigation may at times be found, when light conditions are favorable, by the character of the bottom or the depth. Thus, in southern waters, where ships are frequently piloted by eye from the top, aircraft can frequently identify characteristic formations. Isolated reefs or deep spots, or sharply defined depth curves can frequently be identified and furnish excellent land or water marks.

Aircraft can also obtain fixes from radio compass stations. In so doing, owing to speed of aircraft, observations by various stations should be taken on signal at the same instant. Results within 3° have been obtained, and this can be bettered.

[COPYRIGHTED]

U. S. NAVAL INSTITUTE, ANNAPOLIS, MD.

---

THE SALVAGE OF THE *LEONARDO DA VINCI*

By LIEUT. COLONEL A. GUIDONI, Italian Navy

---

The night of August 2, 1916, the Italian dreadnought *Leonardo da Vinci* was moored in the Mar Piccolo of Taranto in a depth of about 6 fathoms when, following an explosion in the aft magazine, she was sunk, almost completely overturning with her turrets fast in the muddy bottom. Only a small part of the forward portion of the vessel was left above water. The explosion had opened two large leaks in the hull abreast the magazines and a large leak on the top decks.

Following the opinion of a committee, it was decided to salvage the ship, adopting a system proposed by Lieut. General of Naval Constructors Edgardo Ferrati. The method consisted in making the ship float by filling her with compressed air, after repairing the leaks in the hull and closing all the airports and other side openings.

A special board was then organized in Taranto headed by Lieut. Colonel of Naval Constructors O. Giannelli, directly under a research officer of the Navy Department headed at first by Lieut. General Ferrati and Colonel E. deVito, then following the death of General Ferrati the most important and the final operations were directed by Lieut. General Carpi.

The work was at first hindered by the war, which did not permit the detail of many people and made it hard to get the supply of materials. This last difficulty was the main reason for a more important modification of the first plan which provided for the construction of a floating dock in order to keep dry and repair the overturned ship, when she had been freed from the bottom with the use of compressed air.

It was decided to place the overturned ship in the big dock of the navy yard of Taranto. This made it necessary to free the ship from gun turrets, conning-tower, smokestacks, cranes and other deck elements whose projection would not permit the ship to enter the dry-dock. After overcoming many difficulties, the ship was finally lifted from the place of disaster and put in dock, September 17, 1919, after a little over three years since she was

overturned. The recovery of the ship and the transfer to the dry dock, where she was placed bottom up to dry and for bottom repairs, the undocking and uprighting on the following October 5, was a triumph in the use of compressed air, which had been adopted throughout the whole work, and which permitted the ship to be entered under the water level and also under the mud level for the unloading of the ammunition and the detachment of the armored turrets which were left temporarily at the bottom of the sea. The compressed air also furnished the means to raise the ship from the bottom, and to keep her afloat during the transfer to the



GENERAL VIEW OF WORK PRIOR TO DOCKING.

dry dock, and for the period necessary to place her on the transverse bearers provided.

The first phase of the salvage was successfully finished when the ship was taken to the dry dock; after that it was necessary to provide for the repair work prior to floating, then for the overturning of the ship. It also was necessary to provide for the recovering of the 12-inch guns which were at the bottom of the sea, together with their heavy armored turrets. These were recovered with the aid of special ring-floats invented by Lieut. Colonel Giannelli of the naval constructors who headed the work. These ring-floats must be submerged on the turrets and then emptied by compressed air when attached to the turrets. This process is very simple and can be employed also for the recovery of any heavy body.

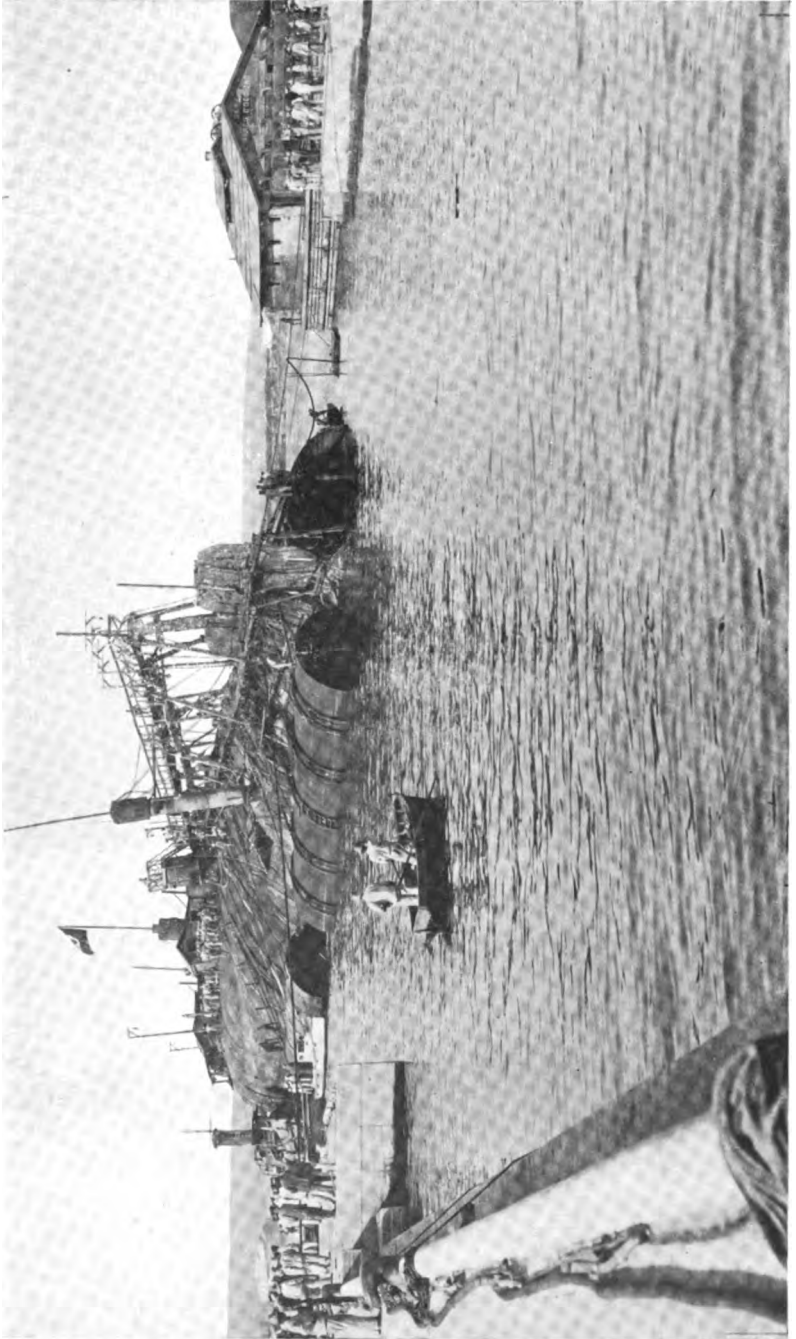

VESSEL ENTERING DRY DOCK.

In order to keep the ship afloat in any position it was necessary to close and tighten all the openings, then to repair the large holes in the deck caused by the explosions of the ammunition. The overturning of the ship required also that many of the compartments must be flooded; so it was necessary to tighten the bulkheads and decks. The decks of the ship in the overturned position of the vessel would be subjected to a high hydrostatic pressure while those structures when the craft is upright have to support very little pressure. This added to the difficulty and volume of work

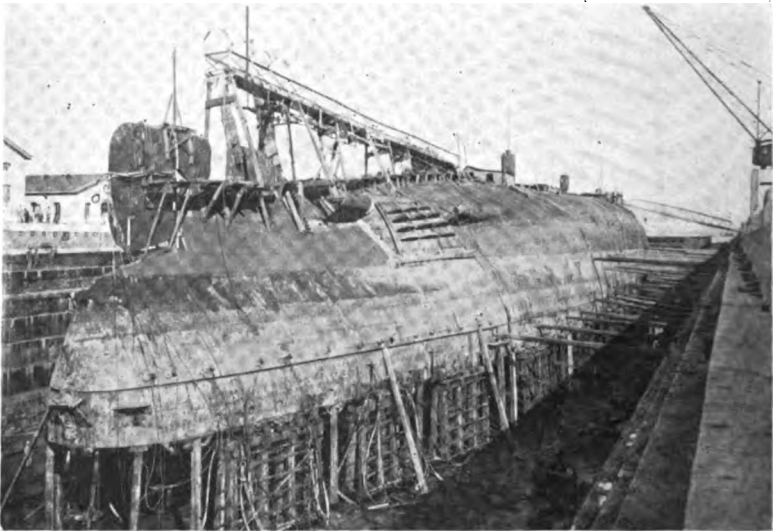

VESSEL IN DRY DOCK SHOWING SUPPORTS.

required. When all the work of tightening bulkheads had been finished, the overturned ship was floated from dock on December 16, 1920.

Very careful studies had been made in order to foresee all stability conditions during the rotation and the calculations were verified by model tests. By means of a stability test the displacement and position of her center of gravity were determined. The displacement of the overturned ship was found to be 18,000 metric tons, including the hull structure, the power plant, the armor and some equipment, minus 5-12" turrets, the control turrets, smoke stacks, cranes and some deck erections. At the time of the disaster the displacement was about 24,000 metric tons. In order to pro-

ceed with the uprighting of the ship, she was taken from the dry dock over a large pit dug out of the bottom of the Mar Piccolo in the north south direction to a depth of 60 feet. The task remaining

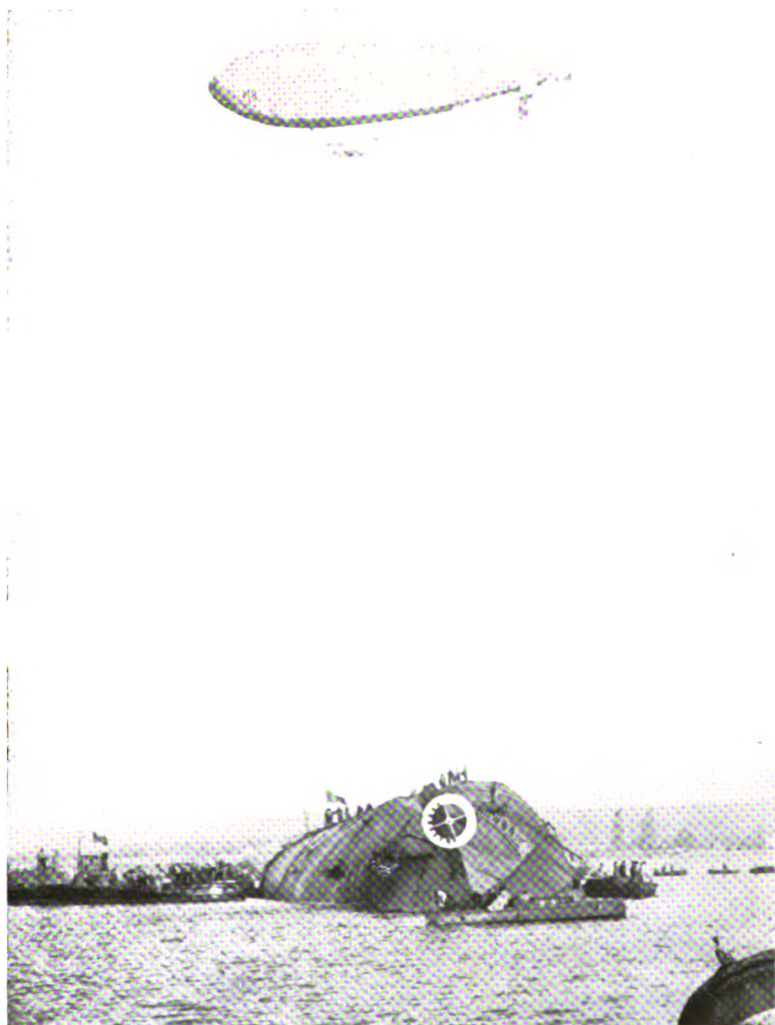

VESSEL AFTER UNDOCKING IN PROCESS OF TURNING RIGHT SIDE UP.

was to roll the ship over into its normal position, by rotation on the left side counter-clockwise. This was done by loading 400 tons of chain and cast iron ingot ballast in the double bottom; by flooding 2900 tons of water in the double and triple bottoms and other com-

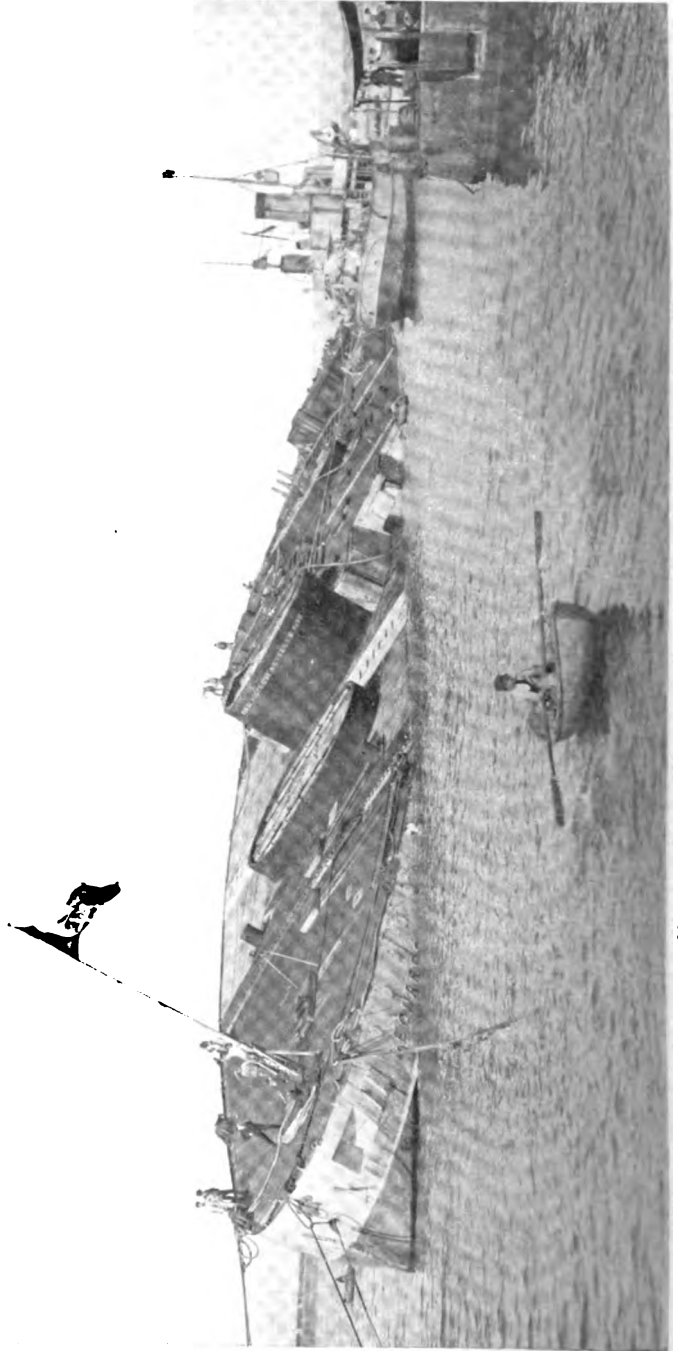

View from the tugboat towing the "Leonardo da Vinci".

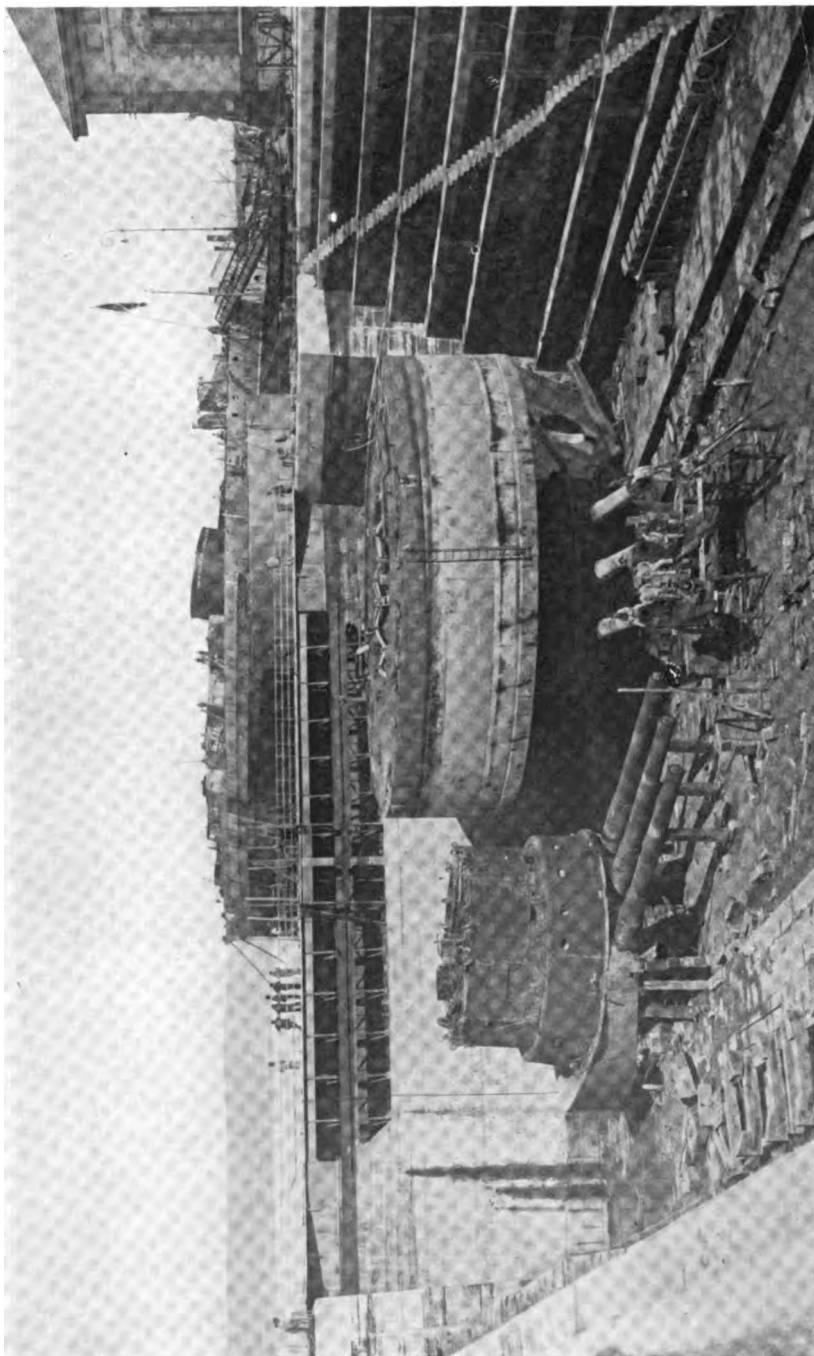

TWO OF THE TURRETS IN DOCK WITH LIFTING RING FLOATS IN PLACE.



partments, such as magazines, boiler room bilges and trimming compartments; by flooding the side ballast tanks with 3500 tons of water on the left side of the vessel. By loading these weights the inclination of the ship increased to 30 degrees with a total displacement of 25,000 tons. At that time automatic flooding of some side ballast tanks was provided for by opening special sluice valves which permitted the water to enter slowly enough to permit the crew to leave

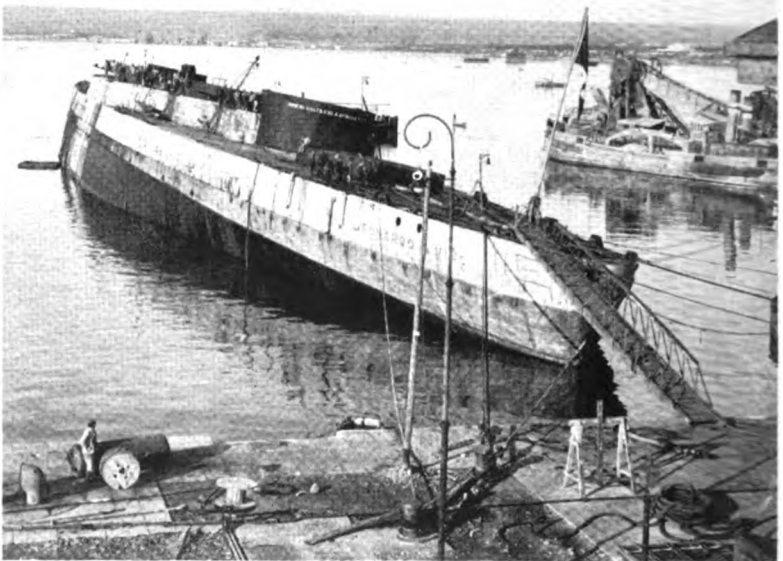

VESSEL AT BERTH AFTER RIGHTING.

the vessel. These compartments had a total capacity of 1700 tons but only 850 tons were needed to bring the ship to an inclination of about 45 degrees, in which position a righting movement became effective which pulled the vessel entirely over. Naturally with a loading of about 1000 tons of water on one side, the ship when turned over would have her position of equilibrium at an inclination which had been calculated to be 22 degrees to the right. The results actually obtained completely confirmed the calculations as the ship stopped at that exact degree of inclination.

[COPYRIGHTED]

U. S. NAVAL INSTITUTE, ANNAPOLIS, MD.

---

## RIGID AIRSHIPS

By LIEUT. COMMANDER GARLAND FULTON (C. C.), U. S. Navy  
(CONCLUDED)

---

### MODERN TYPES OF RIGID AIRSHIPS

The scope of this article will not permit a description of how a modern rigid airship is built nor a detailed description of its component parts, but having sketched briefly the outstanding steps in the evolution of the present-day rigid, it is proper that a summary be given of the functions of the principal parts of late types. The description will not apply to any one type of rigid, but will be more in the nature of an appraisal of the present state of the art.

A brief explanation of some of the fundamental terms used will prove helpful. Any airship derives its "lift" from the difference in weight of the ship and the displaced air. The total lift is the buoyancy, at ground level with all gasbags full. Variations in total lift depend primarily upon the volume of gas and density of the surrounding air. The capacity is the capacity of the gasbags when fully inflated. Fixed weights include: (1) Hull or structural weights; (2) fabric weights; (3) car and machinery weights, and (4) miscellaneous weights such as electrical and other equipment, crew, food, and ballast. The disposable lift is the difference between the total lift and the summation of fixed weights and is a measure of the ship's usefulness as regards fuel capacity and endurance. The maximum static height or ceiling is the height at which the ship will be statically in equilibrium with all dischargeable weights gone.

Construction of a rigid airship is both art and science in a high degree. The chief problem confronting the designer is the combination of strength with lightness. Considering the hull proper, on the one hand there is the lifting force of the gas and on the

other the weight of the hull structure, cars, engines, ballast, fuel, fabric, bombs, armament, equipment and personnel. Both of these opposing forces must be distributed as evenly as possible along the entire length of the ship. In addition, there are local forces due to the lift of each gasbag, thrust of propellers, handling and mooring and specially assumed conditions to take care of any possible attitude or internal condition of the ship. As with most design work, the determination of the components is dependent on previous experience. A condition is assumed and a stress worked out. By comparing with a stress worked out under the same assumptions for a successful ship, a judgment can be formed as to the suitability of the design. Load factors, or factors of safety, vary from three to six, depending upon the part under consideration, or may be even lower or higher in special cases.

As regards external appearance the profile may be divided into three distinct parts comparable to a surface ship—entrance, parallel body and run. Various form coefficients can be figured, the principal one being the slenderness ratio already referred to. The form affects materially the power required to drive the ship, and it is worth noting that the Admiralty coefficient long used as a criterion for comparison of similar surface ships can be applied with satisfaction to airships and furnishes a useful preliminary index to the power required for a new design.

While wood has been used in some rigids, the material universally used to-day for the bulk of the structural work is duralumin. This is an alloy of aluminum with about 4 per cent copper, 0.5 per cent magnesium and 0.4 per cent manganese. Its properties are susceptible of improvement by appropriate heat treatment and in its heat treated condition its strength is about equal to that of mild steel, while its specific gravity is 2.8, only slightly more than one-third that of steel. Its resistance to the corrosive action of salt water is better than that of steel. It was first discovered by a German named Wilm in 1903 and perfected by him during the succeeding eight years. License to manufacture was sold by Wilm to the Düren Metal Works who first produced it in quantity. The name "duralumin" is a trade name and appears to be a blending of the manufacturer's name, Düren, with "aluminum." It was 1914 before it became available in sufficient quantities to justify an extensive airship program. Licenses had been sold to Vickers.

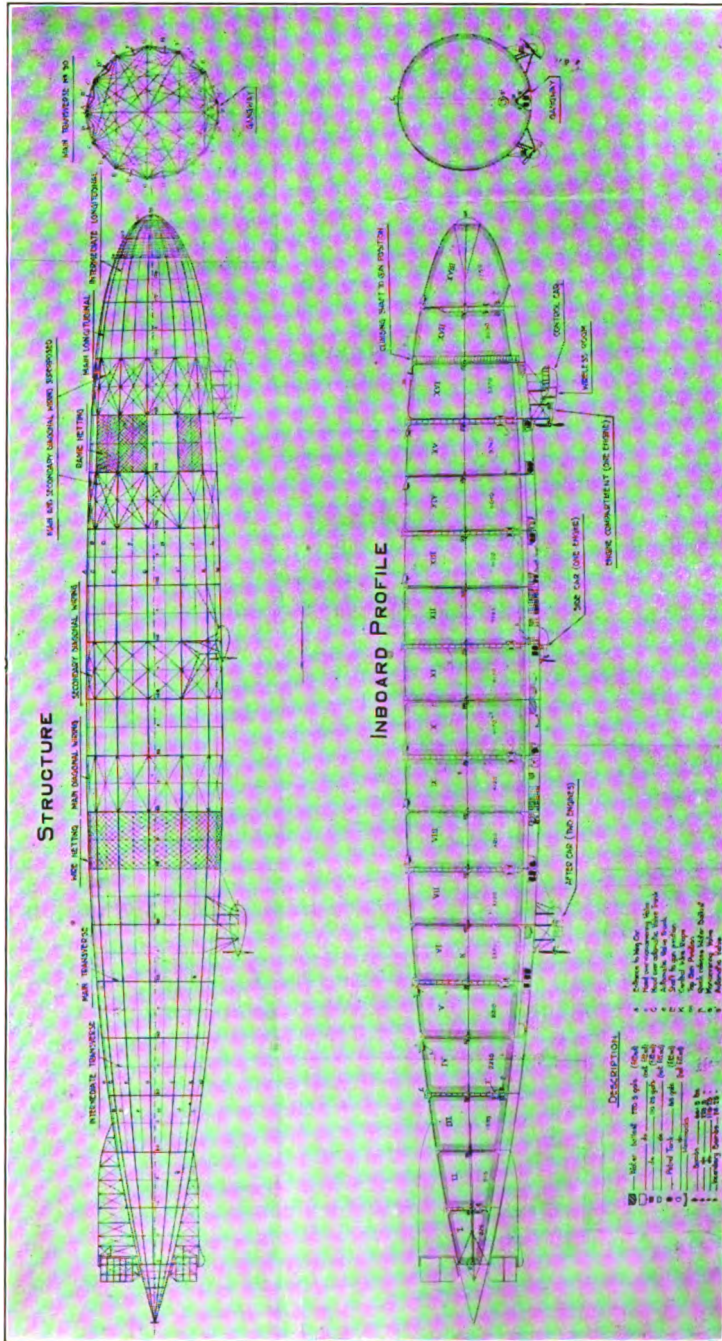

FIG. 10.—Diagrams of a Typical Rigid Airship.

who were soon able to produce equally satisfactory material, and to other foreign concerns. License to manufacture in the United States was allocated to the Aluminum Company of America and the Bausch Machine Tool Company, by the Chemical Foundation under German patents sold by the Alien Property Custodian during the war. Both concerns now produce satisfactory duralumin on a commercial scale in the form of strip, sheet and forgings. Drawing tubing has thus far proved difficult, but progress is being made towards perfecting this process. Dr. Schutte has proposed to build a ship of tubular girders and if the inherent difficulties in satisfactorily joining intersecting tubes can be solved, such a structure should prove very economical. As airships grow larger steel, either tubes or shapes, seems to offer attractive possibilities.

The hull of a rigid is composed of lattice girders of various shapes and sizes depending on the particular work for which designed. Generally they are triangular in section and are formed by longitudinal channels at the three corners of the section, each face of the girder being braced by a series of crossed, light, corrugated stampings riveted to the channels and to each other where they cross. By this construction a girder 30 feet long may weigh only 10 or 15 pounds. The hull structure comprises a system of main and intermediate longitudinals running the full length of the ship supported at intervals by main and intermediate transverse frames. The longitudinals are spaced round the perimeter of the polygonal transverse frames at intervals of about 10 feet measured at the ship's greatest diameter. Alternate longitudinals are heavier than others and are designated main longitudinals. The number of sides to the polygonal frames is odd and in modern ships is usually 25, as viewed from the outside. The main transverse frames are each fitted with a system of brace wires in its own plane to maintain its polygonal shape, and enable it to fulfill its function as a strong ring preserving the transverse form of the ship. They are spaced equally along the length of the ship, generally 0.4 to 0.6 of the maximum diameter apart. On the first Zeppelins the spacing was 10 meters or about 33 feet, but this was increased to 15 meters or about 50 feet in the last ships to be completed. The inter-transverse frames are of lighter construction and have no transverse wiring in their own plane. They are spaced about 5 meters, or 16 feet, apart, there being one or two inter-transverses

between each pair of main transverses depending upon the spacing of main transverses. With different spacings of main transverses the arrangement may change, but probably not far.

A system of diagonal wires in the rectangular panels formed by the longitudinals and transverses on the facets of the 25-sided solid completes the hull structure proper. It remains, however, a most indeterminate structure. Considering the ship as a whole, at any section there will be a bending moment and shear forces and the basis of calculations goes back to the familiar beam theory as

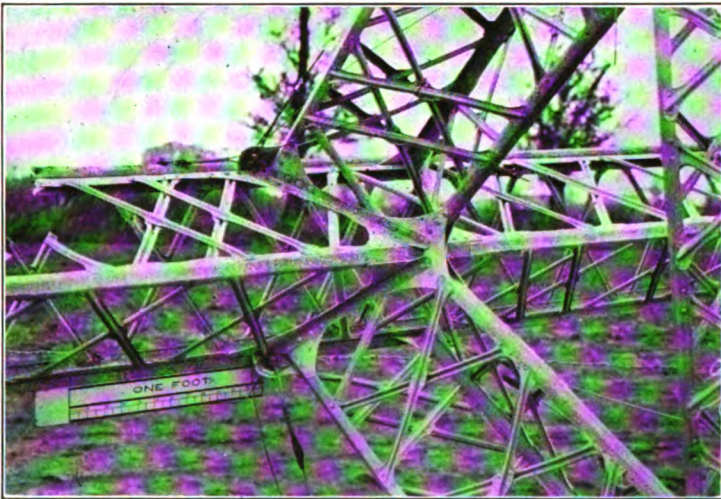

FIG. 11.—Typical Hull Girders Showing an Intersection. Photograph from *L-33* Brought Down in England, 1916. (Navy Dept. Photo.)

a first approximation. But this does not imply that all calculations are as straightforward even as present ship practice; they become very intricate and lead into places where no guiding light of calculation is possible, and one must rely on engineering judgment and past experience. Here the great difficulty is lack of authoritative data on previous types, but as time goes on this condition will gradually correct itself.

In early ships, the keel girder served to take most of the loads, but in later ships it is termed the corridor and its function is chiefly to distribute concentrated loads such as control car, power cars, bombs, fuel, and ballast, and to provide communication and

habitable space for the crew. In *ZR-2*, the corridor is of quadrilateral cross section the size of an average hallway; a narrow walkway runs down the center with canvas pipe bunks, fuel tanks and ballast bags spaced on either side. Near amidships the walkway spreads out into a light platform to provide for cooking and messing. Access to the top of the ship, where there is a narrow fore and aft "cat walk" or crawlway, is by means of vertical access shafts suitably located.

The fabric outer cover, or envelope, contributes little directly to the strength of the ship, but serves to protect the interior parts and should be properly taut to present a smooth exterior and reduce resistance. This latter is of the greatest importance as about 70 per cent of the total resistance of an airship is chargeable to the hull and any slackness in the outer cover will act to reduce speed and endurance. The envelope may be of cotton or linen cloth, in general similar to that used for covering airplane wings, but usually of lighter weight. It is applied in longitudinal strips or gores which extend between each pair of main longitudinals and over from four to six frame spaces. The outer channels of main longitudinals are fitted with eyelets at close intervals and the gores are laced to the channels by cords which pass through the channel eyelets and corresponding eyelets in the edges of the gores. The strips of lacings along the longitudinals are closed by strips of fabric about 8 inches wide called sealing strips which are secured in place by "dope" which gives the necessary adherence.

Before manufacture into gores the envelope cloth is impregnated with some opaque pigment to prevent the passage of light which has a markedly deteriorating effect on the gas cells. After being laced tautly in place the exterior surface of the envelope is doped with cellulose "dope" to produce a contracting effect. This gives a smooth taut surface to the cover. The final outer coats are usually pigmented with aluminum powder which gives a fine reflecting surface and thus helps to minimize the superheating effect. Enough light must get through to the corridor by day to permit operations so the bottom panels are usually not pigmented, but are doped "clear."

Gasbags, the lifting elements, are placed in the compartments formed by the main transverse frames with their bulkheads of radial wires, and vary in number between 14 and 18 depending

upon the type of ship. Adding a section of parallel middle body with its additional gasbags is a favored method of increasing the capacity of a given ship. When in place they are supported against the bursting pressure of the gas, partly by the enclosing hull girders and the network of wires filling the areas between them, and partly by cord nets fitted over the bags and attached to the inner edges of various rigid members of the hull structure. An annular space of about 6 inches is left between gasbags and outer cover for ventilation.

The gas bags are made generally of cotton fabric lined with goldbeater's skins, afterwards coated with varnish to protect from moisture and handling, and to improve the impermeability. Goldbeater's skins are obtained from the "blind gut" of oxen, one skin comprising, say, two square feet, being obtained from each animal. For a large ship, perhaps 750,000 skins may be needed thus requiring a large herd of steers. The raw skins are packed in salt until ready to be stripped and put through various processes which finally result in a thin transparent sheet having a parchment-like feel. The processed skins are applied, sometimes single-ply, sometimes double-ply, to the cloth by means of a rubber solution adhesive. While the method is expensive, primitive, and the results not entirely satisfactory since gasbags remain a most delicate part of the ship and require rather frequent replacement, yet the use of goldbeater's skins secures extraordinary gas tightness combined with remarkable light weight. Considerable research has been done towards finding a satisfactory synthetic substitute and it is gratifying to be able to state that promising progress is being made. Good gasbag fabric should be durable under extreme temperature changes and considerable abrasive action and show a diffusion of not more than one liter per square meter per 24 hours, or for a large mid-section bag, about 0.01 per cent in 24 hours.

The size and shape of each bag is adjusted to suit its location in the ship. The largest when inflated will be like an enormous cheese about 80 feet in diameter by 45 feet long. Each bag is fitted with a spring loaded automatic relief valve, about 32 inches in diameter located near the lower part of one of the plane ends. A hand operated valve for maneuvering purposes may be provided at the top. Above all things the valves should be reliable, but in



practice this has been difficult to attain. If for any reason one gasbag becomes empty, a severe stress is imposed tending to bulge the wires in the plane of main transverses towards the empty bag.

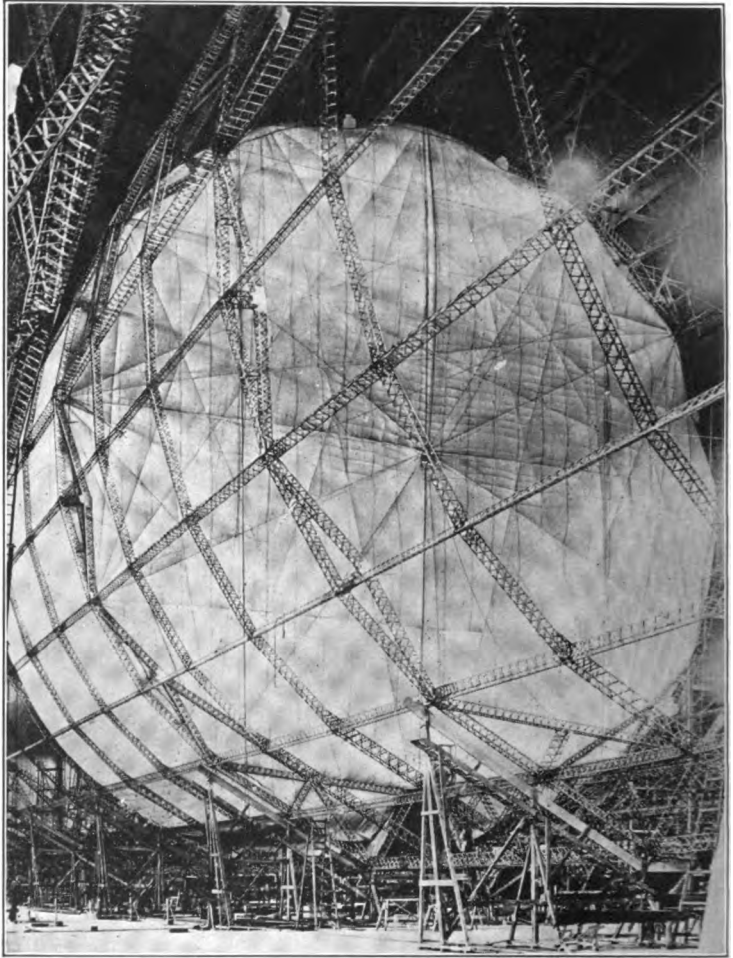

FIG. 12.—ZR-2 Gasbag in Place for Test. Note Wiring and Diamond-Shaped Sides of Main Transverse Frames.

To assist in resisting this action an axial wire is led along the axis of the ship through the gasbags and secured to the wires of each bulkhead. Subdivision of the gas space is desirable for several reasons; it facilitates transverse bracing of the hull structure; it

insures against total loss of gas from a leak; it prevents excessive top internal pressures in case of steep inclinations of the ship; and it minimizes surging of gas with its disturbance to stability, analogous to the action of free water in a surface vessel's hold.

Water ballast for use in landing or correcting the trim of the ship is carried in large fabric bags each having a quick discharge valve capable of being operated from the control car. The amount of ballast carried varies between 3 and 6 per cent of the total lift and must be symmetrically placed about the center of lift, and so calibrated that the pilot can know instantly how much ballast should be discharged to correct the trim.

Any elongated body, such as an airship moving in still air, in the direction of its axis will, if inclined away from its normal path, encounter a moment tending to increase the inclination. The motion is, therefore, unstable and the measure to combat this is to fit stabilizing or control surfaces on the after portion of the hull, which can be operated to cause a counter moment. Control surfaces consist of vertical and horizontal fins (fixed surfaces) and vertical and horizontal rudders (movable surfaces). Proper design and proportioning of control surface is a troublesome problem. Usually four fins with rudders are fitted, one set above and one below on a vertical diameter, and one on either horizontal diameter. A cross sectional view from astern will thus show them to be symmetrically disposed in cruciform fashion. Recent fins are triangular in section and thick enough to be braced internally thus eliminating all but a few exterior guy wires. The rudders are usually balanced to facilitate operation.

Static stability requires that as much weight as possible be placed near the bottom, hence, control cars and power cars are found at the lower part of the hull. They are all built of duralumin and carefully streamlined. The forward car is on the centerline near the nose and is used for navigating the ship. It contains all navigating controls and instruments, and a separate compartment for the radio outfit and operator. It may either be suspended below, or built integral with the hull. In either case, access is via a hatchway to the corridor. Early ships mounted an engine and propeller in the after part of the control car, but the present tendency is to avoid this as too noisy for comfort.

The propelling machinery is divided into a number of separate units, each carried in a car slung from the under side of the hull. Each unit consists of one, occasionally two, engines driving through disengaging clutches and reduction gearing a pusher propeller at the after end of the car. Each engine has its own radiator. In some cases, with slow running engines the reduction gear is dispensed with. The number of power cars varies with the size of the ship, horsepower required, and size of engine available. Their arrangement is a compromise between best longitudinal spacing; placing cars as far up the side as practical to reduce head room and facilitate handling; and avoiding interference of propeller slip streams. Pairs of cars are usually symmetrical with the centerline. One or more of the after cars is provided with gears for reversing the propeller for checking headway on landing, or maneuvering near the ground. The question of car suspensions is one of considerable complexity. Besides taking the normal propeller thrust provision must be made for the ship taking an angle of pitch of perhaps 45 degrees up or down. The German system of suspension consists of a fairly rigid system of compression struts for taking the propeller thrust with tension wires to assist in taking the weight of the car. The British system has a minimum of struts which serve to maintain the car at a fixed distance from the centerline, the thrust being taken by a wire led aft through the propeller hub. Which is the better principle is a matter of opinion. Some provision should be developed so that a spare power car as a complete unit can be rapidly substituted for a car containing an engine in need of extensive overhaul.

The primary requirements of an airship engine are reliability over long periods and low fuel consumption. It has already been pointed out that since 1911 all German rigidships have used Maybach engines of various sizes. In England a number of airship engines were produced, very efficient from a weight viewpoint, but not entirely satisfactory as regards reliability and fuel economy. Fairly good results are expected from the use of Liberty engines in *ZR-1*, the rigid now building in the United States. Other desirable characteristics of an airship engine are continuous running at high percentages of maximum horsepower; low revolutions; and simplicity and ease of overhaul while in the air. Weight of machinery is an important item and one in which improvements

may be expected. At present, an approximate figure of 13 pounds per B. H. P. may be taken for the weight of propelling machinery including cars with engines, and their installation. For continuous

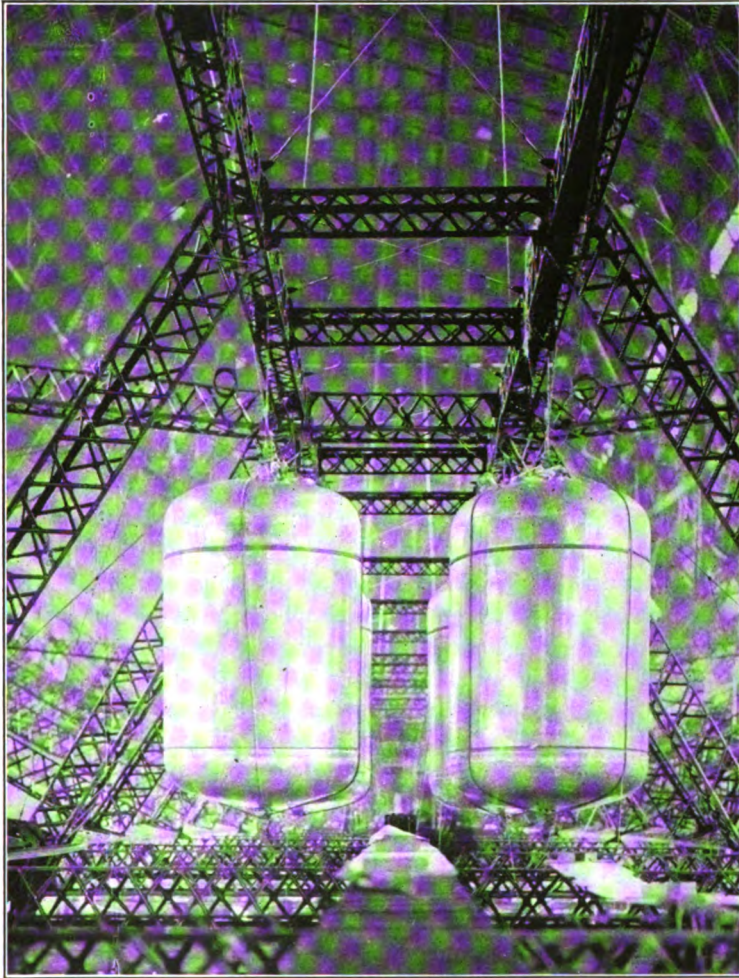

FIG. 13.—Corridor of ZR-2 Showing Fuel Tanks. Each Holds 90 Gallons.

running speeds a fuel consumption of the order of 0.55 per B. H. P. per hour may be expected.

The fuel system comprises a number of aluminum tanks spaced along the corridor, some arranged to be quickly released and

others fixed, but all connected to one or two fore and aft mains which feed each power car. The tanks which can be released—known as “slip” tanks—can be dropped free of the hull, either empty or full, when it is desired to lighten the ship by more than the water ballast available, or in a fire emergency.

An airship making a long voyage has to contend with difficulties due to changes in temperature. Assuming an early morning start, as the sun appears she warms up and her lift increases due to superheating of the gas and to fuel consumed. Unless she is prepared to keep herself down by flying nose down, using horizontal rudders, she must rise and lose gas in doing so. In the evening when superheat disappears this loss of gas will be a serious embarrassment. To avoid this, it is necessary to add weight to the ship. A promising method designed to accomplish this is to condense and recover water from the exhaust. Very satisfactory experimental results have been obtained, but to get 100 per cent recovery in service requires very heavy condensers. It is also certain that during a flight it will be necessary to discharge gas, and an alternative economy is to provide for burning as fuel a mixture of gasoline and hydrogen. Use of either or a combination of these two methods of adding weight would permit the airship commander to control his altitude almost without regard to atmospheric changes. It is expected one or both of these schemes can soon be declared beyond the experimental stage and placed in service.

It is unquestionably true the fire hazard in any airship is very great. This danger is commonly thought to be due to the presence of hydrogen and one sees articles dealing with the desirability of adopting helium at any cost. A far more important question which is often completely ignored is that of fires due to the fuel installation. Setting aside attack by hostile aircraft, the danger of primary fire from gas is small for hydrogen takes a good spark to become ignited and reasonable precautions will prevent it. Gasoline must be recognized, however, as the greater menace and so long as it is used the most stringent precautions should be taken. The fuel system extends practically the whole length of the corridor and invites accumulation of gasoline vapor, but with proper precautions to have the system tight and adequate ventilation of quarters, corridor, and cars the danger of fire from this source will not be

great. It will be still further reduced if engines can be developed to use kerosene or other fuel of high flash point instead of gasoline.

The great military advantage of invulnerability to incendiary projectiles makes the use of the inert, non-combustible gas helium of great value in the presence of an enemy. Helium has about 92 per cent the lifting power of hydrogen and about 65 per cent as rapid diffusion. It is being produced in the United States to-day in limited quantities, but it will be considerable time before it can compete with hydrogen in cost and undue insistence on the advantages accruing from its use does not seem desirable at present. It has been suggested that hydrogen-filled gasbags may be surrounded by an annular space filled with some inert gas as the Germans are reported to have done with kite balloons during the war to save them from incendiary bullets. Possibly some scheme of this sort can be worked out though its efficacy remains to be proved.

Although a rigid can navigate in almost any weather while in the air, the question of handling when making a landing or near the ground presents many difficulties and is a handicap to their greater utility. The problem of landing a rigid without human labor is one that has engaged designers for years. A great many devices have been proposed or tried, such as docking rails, and wind screens, but while these assist in getting the ship in or out of the shed, there is still the problem of handling from the time she approaches the ground until the mechanical devices may take charge. Buffer bags are provided under each car and give a useful cushioning effect besides furnishing flotation when alighting on the sea. Handling frames are provided at landing fields to be clamped on the hull as soon as it is brought within reach, and furnish grips for a large number of men. To keep the ship from rising and to guide her while moving about the field a number of handling guys are led from various strong points on the hull. Besides requiring great skill and judgment on the part of the airship commander in jockeying his engines and water ballast, the latter sometimes to the discomfort of the ground crew, the evolution of landing requires the services on the ground of perhaps 400 men who must be thoroughly drilled in their duties. Thus while the evolution is similar to warping a liner to her pier or placing a large ship in dry dock, it is a three-dimensional instead of

a two-dimensional problem and, hence, more difficult. A new kind of seamanship or "airmanship" is required.

Recent success in England with an improved type of mooring mast and a new method of approaching it promises to remove a large part of the troublesome handling problem, and to reduce the number of expensive sheds required. The mooring mast is a steel lattice structure similar to a radio mast and somewhat over 150 feet high for a 600-foot ship. At the top, mounted in gimbals so that it may tilt, is a pedestal enclosing a telescopic tube carrying

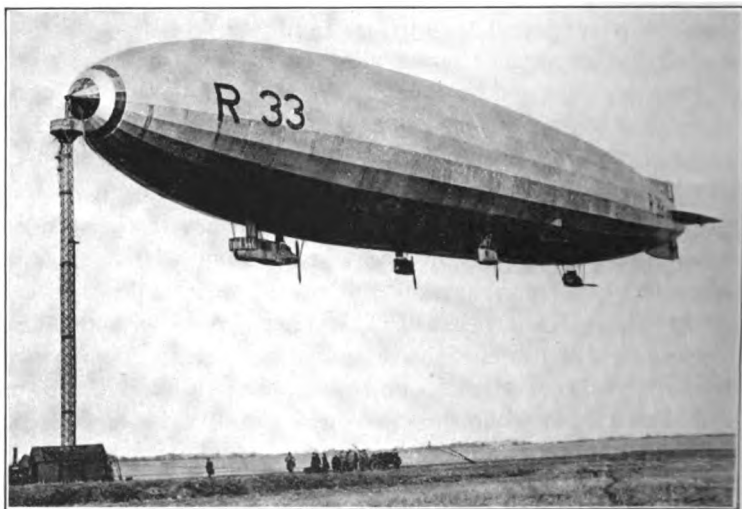

FIG. 14.—*R-33*, Sister Ship of *R-34* of Transatlantic Fame, Riding to Mooring Mast.

a bell-mouthed, conical cup at its upper end. The nose of the airship is strengthened and fitted with a short horizontal outrigger to which is hinged a cone designed to fit into and lock with the mast cup. A hauling-in cable controlled by a winch is led up the mast, through the telescopic tube and cup and down to the ground perhaps a thousand feet from the base in the direction of approach. When the ship, approaching from leeward and properly trimmed, is hovering about 500 feet over the end of this cable, a ship's cable is dropped from the nose fitting to the ground and shackled to the mast cable. Ballast is discharged, the ship rises, and it would seem to be a simple matter to haul her to the

mast and secure her, but in practice it was found the ship had a tendency to swing forward into the wind and surge about in dangerous fashion. The modification proposed by Major Scott, who commanded *R-34* on her voyage to this country, to overcome this and recently adopted, is very ingenious. Blocks are spaced  $7\frac{1}{2}$  degrees apart on the circumference of a 1000-foot diameter circle having the base of the mast for its center. When the ship has been hauled in by the mast cable to a height of about 300 feet above the mast, two guide ropes, also attached to the nose, are



FIG. 15.—Interior of Control Car.

dropped and shackled to two ground ropes, each controlled by a winch. These are led through two of the ground blocks symmetrically situated and about 60 degrees each side of the wind direction. The guide ropes are hauled in simultaneously until predetermined marks arrive at the ground blocks and are there held. The ship is then above the mast, her nose securely held by two guide ropes forming the sides of an isosceles triangle. As the mast hauling line is hove in the nose must describe an arc of a circle the center of which is on the base line of the triangle; thus by keeping tension on the three lines the nose cone is drawn straight into the cup and the cone and cup locked together without difficulty.



The guide ropes and ship's cable are released and returned on board; the telescopic tube is secured in an upright position; and the mooring is complete.

This evolution, while calling for great skill, requires only a handful of men and has been executed under severe wind conditions and also at night. When secured the ship can ride to the mast for an indefinite period swinging around freely with the wind with two or three men on board to adjust trim. The remainder of the crew may leave through a small hatch in the nose and climb down the mast. Fuel and water are supplied via the same nose hatch. The reverse operation of casting off from the mast is more simple and need not be described.

The general operation of a rigid is not unlike that of a surface ship and the analogy is particularly close in the case of submarines. While underway the ship is navigated from the nerve center in the control car forward. To this car lead engine telegraphs and telephones from each power car; rudder controls; maneuvering valve controls; ballast valve controls; bomb releases; and similar apparatus required for operating the ship. The radio room is immediately adjacent to the control station. An auxiliary control position is generally provided in an aft location. Suitable sleeping and messing accommodations are provided for the crew of perhaps thirty officers and men. Cooking is done by electricity or engine exhaust and is served on fo'lding tables. Electric lights are provided as are small electric blowers for ventilation when not underway. The natural draft due to the ship's motion furnishes ventilation while underway and electric heaters are a necessity at the higher altitudes. In flight, watches are stood in sea-going fashion. There is in each watch at least the officer of the watch; a navigating officer; an observation or meteorological officer; a height coxswain; a direction coxswain; a radio operator; one engineer for each power unit; two or three engineers for fuel supply; and two or three general hands for inspection of gasbags, hull, and patrol of the ship's interior. The operations of gassing, fueling and ballasting the ship, while in her shed or preparatory to flight, need not be gone into here, nor the routine of checking up on gas purity, tautening outer cover, nor inspection of valves, wires and hull structure. It is worth noting that when a ship is to be in her shed for any considerable period, or when gasbags are deflated the

weight of the ship is taken by a number of slings secured overhead to the shed structure. When in this condition the ship may be said to be "docked."

#### UNITED STATES DEVELOPMENT

Active interest in the design of rigid airships in the United States dates from July, 1916, when, at the request of the Bureau of Construction and Repair, the various naval attachés in Europe were urged to furnish information regarding the construction and use of rigids. Special inquiries were made as to goldbeater's skin and such other special materials as were then in use. Samples of duralumin from *L-3* wrecked off Jutland in 1915 and *L-20* wrecked on the Norwegian coast in 1916, were received through a naval attaché and the development of similar material in this country was at once urged and encouraged. In October two draftsmen started as a design problem, based on such meager information as was then available, weight estimates and preliminary calculations for 500,000-, 700,000- and 800,000-cubic-foot ships. This work continued to the point where sample girders were made up from an aluminum alloy and tested.

About this same time a board of army and navy officers was appointed to consider the policy that should be followed as to the development of rigid airships. This board recommended that to facilitate effective cooperation in regard to rigids an Army and Navy Airship Board be created with the chief constructor as senior member; that a rigid airship be designed and constructed under the direction of the chief constructor; and that expenses be borne equally by the army and navy.

This Airship Board was appointed and met in February, 1917. It received a report as to the earlier activities of the Navy Department, and after discussing several suggested methods of obtaining a rigid airship and weighing the resources of those private corporations who professed a readiness to build such a ship, decided to try to obtain a design, or a complete ship, from abroad at the same time proceeding with the work already begun of designing a small 700,000-cubic-foot rigid at least to the point where contract plans could be issued to a private firm. Work on this design was continued within the organization of the Bureau of Construction and Repair. The services were obtained of a Swiss citizen who

claimed to have the design of a wooden girder rigid of about 1,500,000-cubic-foot capacity, similar to *R-31* then building for the British Admiralty and design energy was shifted to this larger ship. Information received from abroad in late 1917 disclosed the fact that so many changes had been made in late British ships, evidently based on lessons learned from experience in the use of rigids, that it was considered advisable to completely revise the design. It was discovered that although he had contributed valuable information, nothing further could be learned from the Swiss citizen's design, and he was released. Aside from considering questions relating to the airships, this "Zeppelin Board," as it was commonly called, discussed and made recommendation on Argon gas (helium), sheds and other related problems. It was also called upon to consider a number of proposed designs, nearly all of them freaks, from ambitious inventors or promoters.

In March, 1918, the board sent a special mission abroad to obtain first-hand the latest results of Allied work in rigid airship design, construction and operation. This mission returned in July and a final report from the board was submitted to the Secretaries of War and Navy shortly thereafter. The report recommended that if any rigid airships were wanted for use by either the army or navy in the zone of operations of the war, they be got by purchase in England; that if any were wanted for use from home bases they should be constructed in the United States in an effort to establish the art in this country; that such design and construction should be handled under existing organizations rather than by a joint board; and in view of the very evident use the navy might have for large airships, the Navy Department was the logical organization to handle the work; and, finally, a building program of four (4) rigid airships was suggested. This report was accepted by the Secretaries of War and Navy and referred by the Navy Department to its General Board for consideration. The General Board recommended in September, 1918, that two (2) rigid airships be purchased in England, and that the building of two (2) hydrogen filled airships be undertaken in this country at once. A recommendation of The Joint Board that the Navy Department be charged with the development of rigid airships, including their incidental acquisition in foreign countries, was subsequently approved by the Secretaries of War and Navy. No

restrictions are placed, however, on their use by either service after development.

The acquirement of rigid airships was mentioned before Congress in early 1918 in connection with war-time naval appropria-

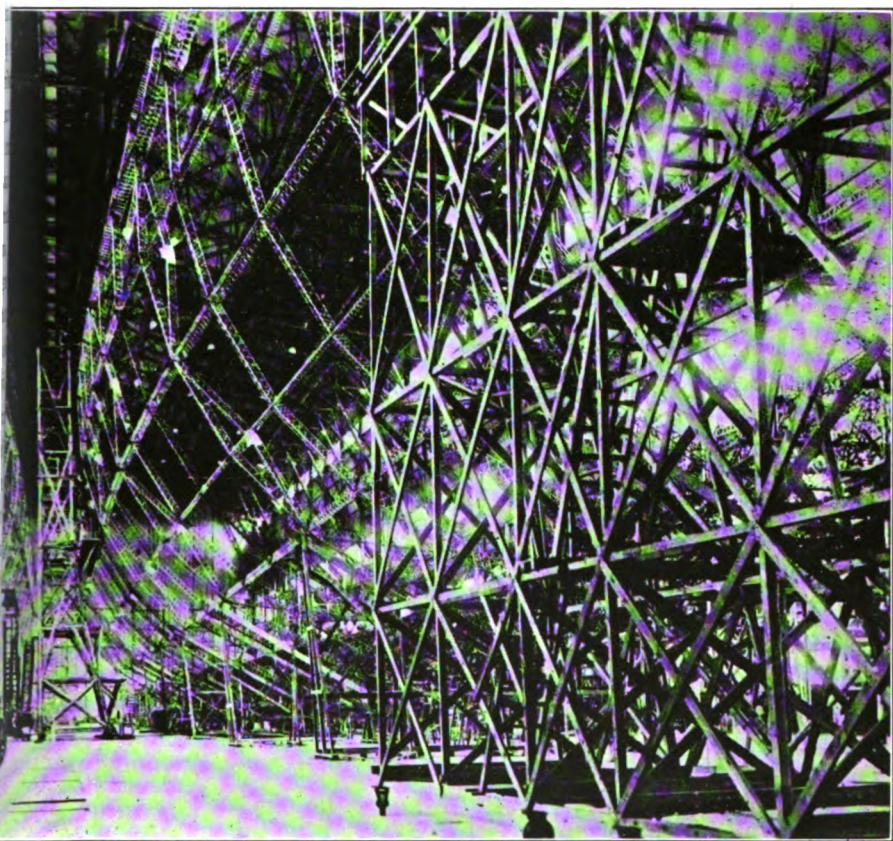

FIG. 16.—ZR-2 in Process of Erection.

tions and the aviation estimates submitted in October of that year for the fiscal year ending June 30, 1920, contained items for the four rigids recommended by the General Board and two large sheds. In hearings on these estimates in November the policy of acquiring rigid airships for the United States was discussed. The Armistice had intervened since the estimates were prepared and

necessitated a very radical reduction. In this reduction Congress saw fit to eliminate the items relating to rigid airships and sheds. The importance of the project was emphasized by the Navy Department in the Spring of 1919 with the result that as finally approved July 11, 1919, the Naval Bill appropriated \$1,500,000 towards the construction of one rigid airship; \$2,500,000 for the purchase abroad of a second; and about \$3,000,000 for the construction of sheds for two large dirigibles. The inclusion of these items had

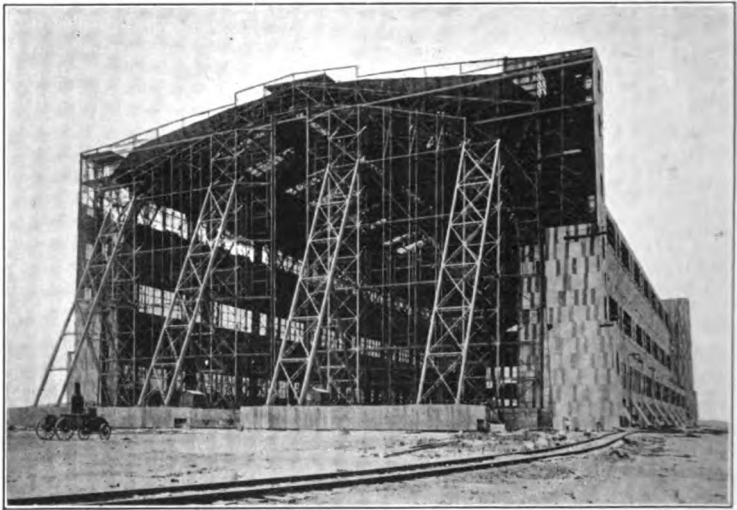

FIG. 17.—Airship Shed at Lakehurst, N. J. The Largest Shed in the World and Capable of Housing a 10,000,000-Cubic-Foot Airship. (Navy Department Photograph.)

been anticipated and plans were ready for prompt execution immediately funds were available.

A survey was made of all likely locations on the East coast for a large shed. The place finally selected was an abandoned army camp near Lakehurst, New Jersey, about half-way between Philadelphia and New York and some 50 miles from the coast. While it approximates a satisfactory site as regards meteorological conditions and has somewhat more than the minimum of one square mile of level, cleared ground, its choice was largely one of expediency. It was the only near-satisfactory site that could be obtained. Contract was at once let for the world's largest shed

to a preliminary design worked out by the Bureau of Yards and Docks. It is 800 feet long with cross section 250 feet wide by 172 feet high in the clear, and will house a pair of 5,000,000-cubic-foot ships or a single 10,000,000-cubic-foot ship provided a 200-foot extension be added. This shed is now practically complete and will be surrounded by a large hydrogen plant, shops, barracks, and by recent decision, a 160-foot high mooring mast, to make at Lakehurst a complete station for construction and operation of large airships.

For the airship to be constructed in this country, *Fleet Airship Number 1*, the Department in July approved a 2,000,000-cubic-foot design substantially similar to the German *L-10* except that it will be adapted to use American power plants, including Liberty engines, and American materials. She will not, however, be a Chinese copy, as advantage has been taken of every opportunity to revise the design as the work proceeds in accordance with the latest information received from abroad and a number of improvements have been incorporated that will make it equivalent to the later German ships. Officers have been sent abroad to study the latest British and German practice and some experienced foreign talent has been obtained to assist in placing this new form of ship-building on a rational basis.

Due to efforts started in 1916, all the required materials, including duralumin, are to be available from American manufacture for the construction of the ship. The necessary special tools, jigs, and erection devices have been prepared, contracts let for nearly all of the materials such as gasbags, reduction gears, etc., and fabrication of metal parts is underway at the Naval Aircraft Factory, Philadelphia. Erection of the ship is to be in the shed at Lakehurst although the failure of Congress to provide adequate funds for the completion of the ship makes its future uncertain at this time.

The designation of the ship has been changed from *Fleet Airship Number 1* to *ZR-1* to conform to latest departmental practice. The new designation is not a combination of German and British symbols, as may occur on first thought. It is merely coincident that the symbol "Z" selected for all types of airships combined with "R" for rigid type gives a hybrid appearing designation.

While practicable to develop rigid airship building with the information at hand and on our own resources such a course would require a number of years and be expensive. Therefore, executing the authority given by Congress, negotiations were opened abroad in the summer of 1919 with a view to obtaining the full benefit and value of the development there. The high water mark of this development was undoubtedly in Germany, but since peace had not been consummated by the United States it was, although considered, not possible to obtain by allocation a late German rigid even if it had been our policy to accept it, and if we had possessed a shed to receive it, which we did not. Further, in view of the provisions of the Treaty of Versailles which prohibited the manufacture of aircraft in Germany for a period it would have been most undiplomatic to have placed even through an intermediary an order for a new German ship. Negotiations were, therefore, opened at once in England with a view to purchasing a rigid airship and also to get advice and technical assistance in the construction of *ZR-1* in the United States. Personal inquiries had been made along these lines by officers from the Department several months previously and paved the way for the final negotiations. Preliminary and more formal inquiries now made of the British Air Ministry met with the most cordial response and the extent to which they would extend advice and assistance to us was referred to the British Cabinet as a matter of national policy. The Under-Secretary of State for Air expressed pleasure in the most cordial terms at the opportunity to cooperate with the United States in the future development of the rigid airship and this was given immediate effect by their offer to sell to us *R-38*, under construction at Short Bros. (now under Air Ministry), which represents their latest development in all particulars and is the largest airship ever laid down.

The agreement as drawn up with the Air Ministry includes complete plans and specifications; provides that the ship shall be built entirely to Air Ministry designs and practice; and provides for the closest cooperation, evidenced by two visits to this country by Constructor-Commander C. I. R. Campbell, R. N., in charge of rigid airships for the Air Ministry, and by permission for American officers to be resident at the building works. As a separate matter, also meeting with hearty cooperation, arrangements were made to train in England a complete American crew of officers and men to fly *R-38* to the United States on her completion.

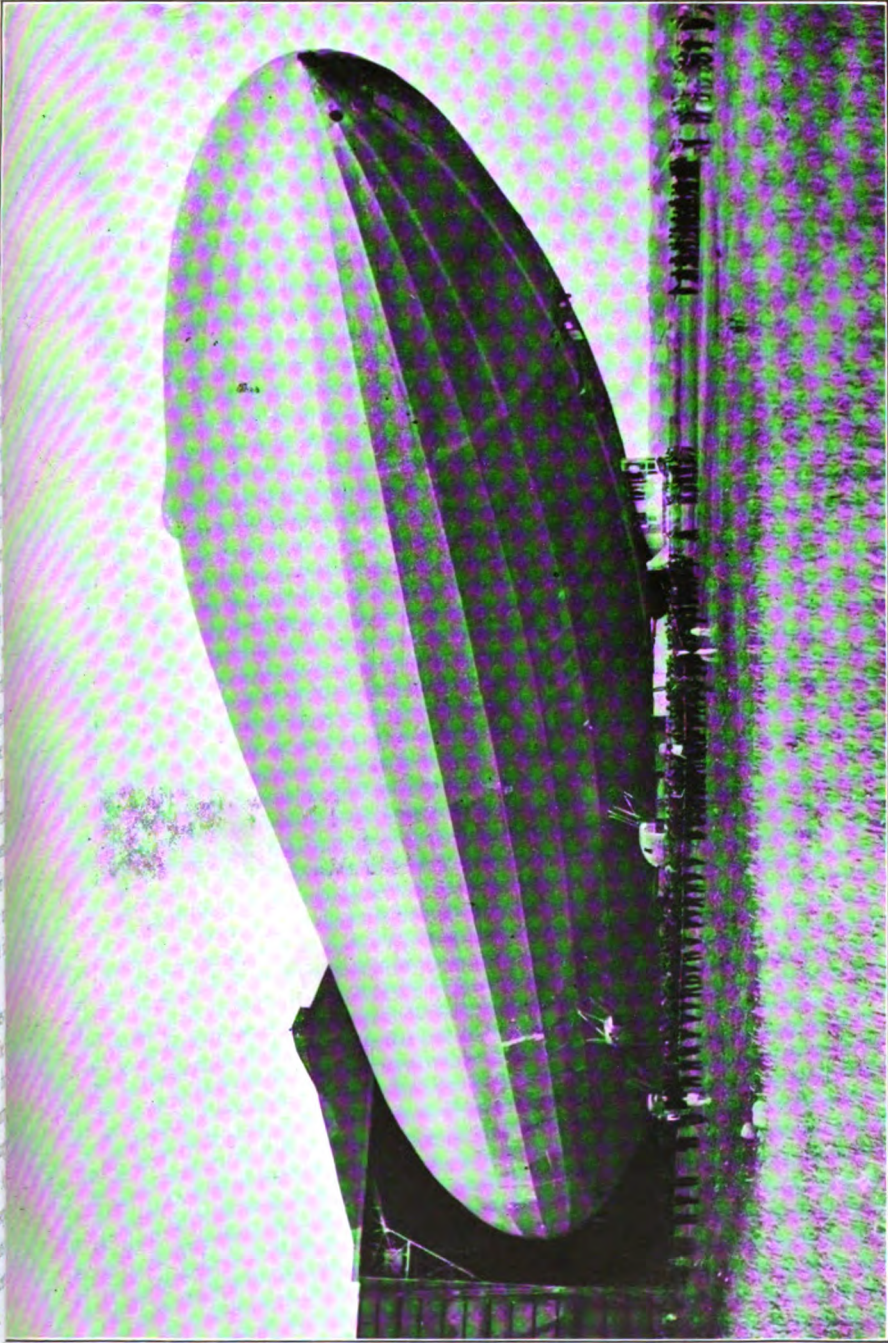

FIG. 18.—ZR-2 Being Hauled Out of Shed. (Navy Department Photo.)



The price paid for *R-38* was to be actual cost to the Air Ministry which was estimated, and later definitely fixed, at \$2,000,000 which is inclusive of the cost of inspection and trials, hull spares, and machinery spares, amounting to about one-fifth the cost of the ship proper. The cost to the Air Ministry will likely be in excess of this figure but a duplicate ship could be built for about three-fourths the amount. Being a single ship of a new type built in a large plant the costs run somewhat high.

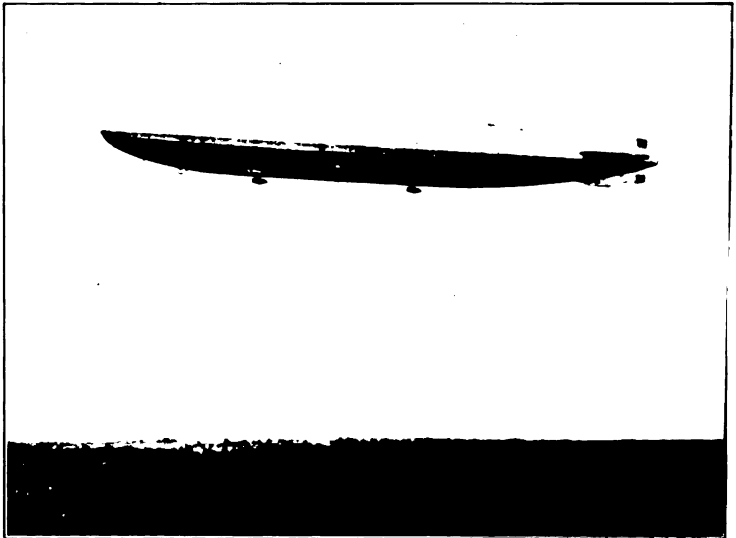

FIG. 19.—*ZR-2* in Flight. (Navy Department Photo.)

*R-38* was designed in 1918 by the Admiralty staff as a reply to the large high-flying German rigids of the *L-71* type. She is not a copy of German ships but is entirely a British conception. She is 300,000 cubic feet larger than *L-71* and is only exceeded in size by designs that exist on paper. The design has been worked out especially for naval purposes and has been kept as light as possible for the high altitude work the latter stages of the war proved was so essential. Originally it was proposed to build three ships of this class, but two were canceled just before construction started in November, 1918, leaving only *R-38* at the works of

Short Brothers in Bedford. These works have since been taken over by the Air Ministry.

Advantage has been taken of the somewhat slow progress of construction to introduce improvements and additions such as bow mooring gear. The car arrangement is similar to late Schutte-Lanz ships. The control car with radio room is rigidly attached to the hull well forward. There are three pairs of wing power cars of clean shape each car with a 350-horsepower Sunbeam engine, and arranged so that no propeller is on the center-line of the ship. The results of trials are not yet known, but the following are the principal design dimensions and performance characteristics:

Volume .....	2,724,000 cu. ft.
Length .....	695 ft.
Diameter .....	85.5 ft.
Height overall .....	93.0 ft.
Total normal lift .....	83 tons
Useful lift .....	50 tons
Percentage useful/gross .....	60.2%
Full speed .....	60-70 miles per hour
Endurance at full speed.....	5000 miles, or 73 hours
Cruising speed.....	55 miles per hour
Endurance at cruising speed.....	8000 miles, or 146 hours
Ceiling (estimated).....	24,000 ft.
Total horsepower.....	2100 (6-350 H. P. Sunbeam engines)
Fuel capacity.....	30 tons (50 tanks, 190 gals. each)
Number of gasbags.....	14
Normal crew.....	28-30 officers and men
Armament .....	14 machine guns
	1 one-pounder
	4 520-lb. bombs
	8 230-lb. bombs

While non-rigid and semi-rigid airships have rather distinct limits as to their economical size, the rigid airship is a different proposition and its limit has certainly not yet been reached. Generally speaking the larger an airship is the more efficient it can be made. At their present stage of development rigid airships can carry a cargo of 25 tons 5000 miles over land or water, or both, at a speed 50 per cent greater than that of an express train; or, with a maximum fuel load and no cargo, can similarly travel 9000 miles or more. They can navigate in all sorts of weather and, if necessary, circumnavigate storms, go to altitudes of 20,000

feet to avoid them, or hover and wait for a fog to lift. They may be moored to a mast for days and can carry out routine repairs to engines and equipment while underway.

The necessity to any naval power of such ideal scouting craft, able as each is to scout the same area as three scout cruisers, is obvious; likewise, it is obvious that any use of large airships over the sea is essentially naval. Airships in themselves are of relatively small offensive value, and must be developed to coordinate with the surface and sub-surface fleet and its other types of aircraft. To a naval power which develops aerial cooperation with the fleet along sound lines, airplanes and airships will be a vast accession of strength.



FIG. 20.—Comparative Sizes of a Battle Cruiser, a Destroyer and a 2,000,000-Cubic-Foot Rigid Airship. ZR-2 Was 725,000 Cubic Feet Larger Than the Airship Shown Here. (Navy Department Photo.)

Vulnerability is an undisputed military handicap to rigid airships and whenever one has been lost the Jeremiahs have been prompt in declaring the type worthless, but the history of warfare shows that for every method of attack there is a defense and the advantage fluctuates with progress. Even now at her customary high altitude the large airship is unconcerned by mines, torpedoes, gunfire from surface ships and fortifications, or attack from any airplanes but the extremely high powered types able to climb above 18,000 feet. In a war against a modern fleet the present-day rigid might, if caught unawares, fall a victim to incendiary bullets from high speed airplanes, but if skillfully handled and fought, the air-

ship would stand a better chance of getting its information back to its fleet, and do it in quicker time, than would any destroyer or light cruiser dispatched on the same scouting mission and attacked as it would be by the same airplanes augmented by torpedo and bombing planes, gunfire, torpedoes and with probably an added mine hazard. When and if helium is used, airships will by no means be easily destroyed weapons. They already carry a considerable sting in the form of numbers of machine guns, and the questions of their further defensive armament and tactics in the presence of high performance airplanes or enemy airships have scarcely been touched. The naval use of rigids in the war was a one-sided affair, and airplane performance and attack did not become so serious but that it could be taken care of by improvement in the airship's ceiling and performance. The old adage "set a thief to catch a thief" may have its application here for the British have already proved that an airplane can be carried on and released from a rigid airship.

For short distance scouting heavier-than-air craft will doubtless prove the more useful and are certainly cheaper, but airships will be indispensable for carrying large loads and for flights beyond the endurance of the airplanes. The rigid is essentially a long distance, weight-carrying craft. Its principal naval function is long distance, or long endurance, reconnaissance. Other uses are: coastal patrol; long distance convoy work; anti-submarine operations; mine searching; bombing enemy fleets or bases; maintaining communications with detached expeditionary forces, providing supplies in small quantities, etc. At present their significance to our own fleet is potential only. The extent to which this potentiality can be turned into an actuality depends on time, and the energy, imagination, and skill with which their development is pushed.

#### SOURCES

Neumann: "The German Air Force in the Great War."

Whale: "British Airships. Past, Present and Future."

Pratt: "Commercial Airships."

Cole, A. P.: "The Principles of Rigid Airship Construction." Royal Aeronautical Society, 1920.

Pritchard, J. E. M.: "Airships and Their Development." Royal Aeronautical Society, 1920.

Campbell: "The Effect of Size Upon Performance of Rigid Airships." Institution of Naval Architects, 1920.

[Various magazine articles in German and British Press.]



[COPYRIGHTED]

U. S. NAVAL INSTITUTE, ANNAPOLIS, MD.

---

THE NAVAL OFFICER AND THE CIVILIAN

By PROFESSOR WILLIAM O. STEVENS, Department of English,  
U. S. Naval Academy

---

In the days when government was in the hands of kings or an upper class, it made no difference whether a people knew anything about its army or navy. Wars were declared by those in authority to suit themselves, and the professional fighter did the work. The rank and file could be conscripted or impressed, and these poor wretches, who had no idea what the war was about, had no alternative but submission. The rest of the people, except for paying taxes, went about their occupations. It is interesting, for example, to note how little the city of London, with its trades and handicrafts, was affected by the long drawn wars of the roses. Whether white won or red made no difference to the plain citizen of London; with him it was "business as usual."

In our own day, however, kings and upper classes have little to say worth listening to. What has always been true of our republic is getting to be true of the world. Wars will be declared hereafter by the chosen representatives of the people. Moreover, wars are no longer a matter of a professional class, they are fought by whole nations. Indeed, the distinction between combatant and non-combatant was practically wiped out in the World War. The professional is the leader and drill master, but he must depend on wholesale popular levies for the actual fighting force. This is too obvious perhaps for comment, but it has its implications which do not seem to be so clearly recognized.

Let us suppose the army and the navy to be two members of a team for national defence. It follows that the third member of this team is the people. Further—and this is too often ignored—this third member of the team is also its captain. It lies with the

people to determine the size of army and navy, to say whether army and navy shall act, or indeed whether there shall be any army and navy. Obviously if the team is to succeed there must be team play and team spirit. Do we have these essentials developed to the proper degree? If not, what are the things in the way, and what may be done about it?

Of course the answers to these questions affect the army as well as the navy, but I shall confine this discussion to the naval aspect as suggested in the title offered by the Board of the Naval Institute—"The Naval Officer and the Civilian." I venture to hope that a connection of nearly a score of years with the navy may be of service in explaining to the naval officer civilian points of view which must seem baffling and exasperating, and in suggesting means of creating that *entente* between our first line of defence and the people which any man who believes in the navy must desire to see attained.

#### I. SOURCES OF FRICTION

No one need pretend that relations are ideal now. There are apparently sources of misunderstanding which do the navy harm. In the first place nothing, I suppose, strikes an officer as so absurd, so maddening, as the charge that naval officers are "snobs." And yet we cannot shut our eyes to the fact that there is a strong under-current of feeling to this effect which has been running ever since the navy was founded. Last fall, for instance, *The Baltimore Sun* said editorially that the Naval Academy "bred more snobs than any other school in the country." If that is the way people feel, our team spirit can certainly be improved. And as far as that idea is reflected in Congress it is going to hurt the navy every time it appeals for the support it needs. What is at the bottom of this snobbery idea and what can be done to get rid of it?

Not long ago this question was discussed by an officer in the pages of the U. S. NAVAL INSTITUTE PROCEEDINGS, and as I recall it his conclusions were that the fault lay with the civilians and that the only remedy was to have universal conscription, through which civilians would gain the habit of saluting officers. That reasoning is hardly calculated to make a hit with the civilian public. Why not approach the subject by admitting that there must be some fire that has kept this harmful idea smoldering a hundred years and look for it with the idea of putting it out?

The earliest reason lay in the fact that when our republican navy was first organized every other navy in the world was composed exclusively of the members of the aristocracy. It is true that occasionally in the British Navy a commoner like Benbow or James Cook won commissions by sheer merit—but the fate of Benbow and the niggardly recognition of Cook's great achievements are suggestive of the difficulties such men had. Our democratic country did not relish an artificial aristocracy in its army and navy, kept a jealous eye on its servants from the beginning, and did not like it when our officers imitated too closely the ways and manners of the British. But as a matter of fact, people don't expect an officer to mess with the enlisted men any more than they would expect a superintendent of a mill to lunch with his operatives. The civilian inclines to the view, nevertheless, that the heavens wouldn't fall if either should happen to do so for a good reason. But this aspect amounts to little to-day in view of the almost unlimited opportunity offered for advancement to any enlisted man who can make good.

Civilians regard the naval officer as a public servant; they are at bottom exceedingly proud of him, though they don't often betray the fact, but they are quick to resent anything on his part that smacks of caste or "class consciousness." Any civilian may say things which will be promptly resented when uttered by someone in the service. For example, I once overheard a captain's wife in a party of naval officers on a train remark loudly and sneeringly, "Oh, I suppose anything can happen in this American *democracy* of ours!" A business man in the same seat with me—who had entertained scores of naval officers in his own house—turned to me and said angrily: "Did you hear that? Damn these naval officers, they make me sick!" It was a trivial thing to get excited about, and if the remark had come from someone not identified with the service my neighbor would probably have not noticed it, but there it is. That is just the kind of thing, repeated here and there, which helps to keep the old charge of snobbery alive. The moral seems to be that the uniform marks the officer from the rest of his countrymen and the unfortunate trifle in word or act of an individual reacts upon the whole service. If you must get out of patience with democratic institutions and damn the "Peepul," do it far from the civilian ear!

But this vague charge of snobbery does not rest only on the idea of a social caste. Many civilians hold that the officer thinks of the



navy first and of his country second, or perhaps that he regards the service as a close corporation, organized for the benefit of its members. This is not true, of course, but some things have happened that give color to the idea. For example, the classes of reserve officers that came to the Academy during the war were officially welcome, but unofficially treated to an amazing amount of ridicule and hostility. One would have thought that these young men who had left their college or their profession to serve in the navy were interlopers or trespassers. The midshipmen particularly, though excused from saluting these reserve officers in the yard, were outraged; indeed their chief worry in the war seemed to be not whether we should be able to beat the Germans but whether these reserves were going to stand in the way of promotion.

Naturally these amateur officers could hardly be expected to compete successfully at all points with the Naval Academy graduate, but the navy had to have them and they came with the best intentions in the world. Moreover, Admiral Sims pays them a high compliment for their service in the war. Indeed, he even suggested that the Naval Academy be transformed into a graduate technical school for college men.

Now many of these reserve officers had a sense of humor, and most of them got to sea, where in the wholesome atmosphere of a man-of-war they forgot the annoyances of Annapolis. They returned, as far as my experience goes, full of enthusiasm for their respective skippers and for the navy in general. Others who did not have this sea experience before the armistice went home sarcastic over the "snobbery" of the navy. One of them wrote a long article for a leading southern paper describing his experiences. This was sent by the editor to a civilian at Annapolis for comment. "If this is true," wrote the editor, "I'll see that this is printed broadcast all over the south at least." The civilian succeeded with difficulty in preventing its publication. The young man, by the way, had had every advantage of wealth and education. While traveling toward Annapolis in a glow of patriotism to join the navy, he scraped acquaintance with a naval officer. The latter was plainly disgruntled. He explained that he was assigned "the worst duty in the navy—teaching those damned reserves." He went on to tell at length how worthless they were and concluded by saying he could "tell one a mile off." That was the young fellow's introduction to

the navy, and the rest of the story was in keeping with that introduction. Now wherever he goes and as long as he lives, he will be a bad advertising agent for the navy. And he was not alone, as I happen to know. In short there may be an overgrown *esprit de corps* which contributes directly to this charge of snobbery.

In passing, while this has no relation to the question of "snobbery," it may be remarked that both army and navy seem at times to develop their respective *esprits de corps* to the point that makes smooth co-operation for the nation's benefit impossible. Our history is not notable for the teamwork of the two services. And the recent discussion, for instance, between the Army Air Service and the Navy Department has not been remarkable for the show of team spirit. We have at last a joint Army and Navy Board, but a certain army officer of high rank—who has himself been present at the meetings—informed me that it was a failure because the representatives of the two services were more concerned in keeping each other from gaining any advantage than in accomplishing their common purpose!

The second source of friction is the charge that the naval officer is a militarist—a "Prussian." This is probably even more exasperating than the charge of snobbery. Of course a naval man believes in militarism of a certain sort. But no American officer of the army or navy has ever tried to play the man on horseback with the nation's liberties. This fact is generally recognized, and many of our military men have been elevated to the highest elective office in the land. The feeling comes down to something like this, that the officer is always urging a larger armament because it magnifies his profession rather than because the situation demands it. In much of the talk about increased armaments, it must be admitted that the champions of increase have not reckoned enough with the popular demand for reduction to the point of safety, and have done little to make clear to the American people just why the increase is needed.

The civilian says that Japan is our one war cloud but that we ought to be able to establish an understanding with the British Empire that would cool off even the Junkers of Tokio. Before the war, he says, we were told that our navy should be second to England's; we have that at the present time. But now we are informed we must have a navy equal to England's, and a rear

admiral has recently declared in public that we must have a navy equal to England's and Japan's combined! The civilian argues, therefore, that you can't trust the naval officer's opinion. He will always demand a bigger navy on principle—the principle that promises quicker promotion. To build a navy equal to England's the civilian thinks is the surest way of making trouble with a nation whose existence depends on maintaining a margin of sea power. Germany tried it and committed suicide. As to a two-power standard, he dismisses it as sheer lunacy. Hence, when the naval officer sounds the cry of "wolf, wolf!" in an hour of real danger, he may find it hard to get a hearing from his fellow countrymen.

It may be added too that it does not pay for an officer in writing for a civilian public to sing the "benefits of war." It will pay no better to sneer at the American people because they are "peace-loving"—even Mahan did that. Nor will it do much good to harp on the need of universal military service. It seems as if naval officers in writing for the public too often hit these notes, which are precisely the ones least calculated to wake an echo in the civilian mind. They strengthen the suspicion of "militarism." Let there be more talk about preparedness that reasons from actual necessity, that recognizes the curse of great armaments, and that aims to prevent war.

The third and chief cause of friction is not a charge against the navy; it is sheer ignorance. Sometimes the officer fails to understand the civilian view point, more often the civilian knows nothing about the navy. This is the fundamental trouble. Much of the feeling expressed in the charges of "snobbery" and "militarism" arises from nothing but ignorance. The civilian does not realize, for example, that naval officers are so cut off from their countrymen, by the very nature of their calling, that they find common interests in each other rather than in outsiders. Hence, what is called "clique spirit" is not a fancied superiority to civilians but the inevitable consequence of naval life.

I have come across people, too, who have the idea that naval officers live in luxury and idleness at government expense. They think that uniforms and mess bills are paid for by the public, that officers have nothing to do but stalk about and damn their subordinates. In short their idea of a naval career is a succession of luxurious yachting cruises, furnished for certain lucky individuals at the taxpayers' expense. Probably the chief reason some people

steal cigars, silver, and epaulets at a public reception aboard ship is that, according to their lights, everything on board is paid for out of the common taxes, and they might as well help themselves to souvenirs. Of course this extreme opinion is not held by anybody who knows anything about the navy, but the trouble is that there are too many people who do not know anything about it. This is a fact that the navy needs to take into account. This is the fundamental trouble in the relation between the navy and the civilian.

## II. EDUCATE OUR MASTERS

Nothing has been said so far about the officers' complaint against the civilian public. The civilian has always been blind to the needs of preparedness, he has had the most absurd misconceptions of military and naval problems, he has never appreciated discipline, he has never understood the military ideal in character. It is the civilian who must bear much of the blame of the ghastly failures of our war of 1812, the prolonging of the Civil War, the delay in getting into action in our late war. All this is true. But the trouble is that the civilian is the boss, and you cannot kick your boss, no matter how stupid and how slack he may be. When the suffrage was extended to the poorer classes in England a half century ago, one of the tories who had fought the measure exclaimed mournfully, "Well, we must now educate our masters!" This is the second step in creating an *entente* between the navy and the people. We cannot kick the boss but we can educate him.

The naïveté of the civilian public regarding naval and military matters is well illustrated by an observation by the late Henry George in his *Social Progress*. The substance of the passage is this: "The United States should abolish army and navy, because we are so powerful a country that no other nation would dare to attack us, and for the same reason we should be ashamed to attack any other." No one can deny that Henry George possessed an original mind capable of acute thinking, and if he could write like that, what of the rest of his countrymen? It is safe to wager that at least a million voters to-day would wag their heads over that precious piece of reasoning and declare that it was just about right.

Ferrero, the brilliant Italian historian, recently published an article in which he proved that the Americans had abandoned the League of Nations because the freedom of the seas was the one

thing they wanted in the World War and it was lost in the shuffle at Versailles. It is a very pretty theory indeed; the only trouble with it is that it is not true. Not one American in ten thousand has any idea what "freedom of the seas" means. The Americans are not conscious of the sea at all. In England, on the other hand, everybody is conscious of the sea; the man in the street does not have to be told what sea power means to the British Empire, and the navy does not have to counteract a public indifference.

The contrast is brought out by the fact that in this country we have to depend almost entirely on the American branch of an English house to get any naval books at all. And the American branch—the George H. Doran Company—finds it hard to sell in the United States half the number of copies that the home office (Stodder and Houghton) can sell to the British public.

Moreover, the usual post war revulsion from everything military tends to make it more difficult than ever to rouse popular interest in the navy. Magazines refuse articles or stories with even a brass button in them. Last year it took four entrance examinations and a newly created certificate to fill the entering class at the Naval Academy to anything like its normal size. Clearly, for the sake of both the navy and the nation, the public needs education. But who is to supply it?

In the Spanish American war the country made itself ridiculous by the howl of the Atlantic seaboard for naval protection against Cervera's fleet. Congress bowed to the storm, and our strategy was upset. Schley's "Flying Squadron" was held at Hampton Roads instead of operating off Cienfuegos. It was at that time that two eminent statesmen from Portland, Maine, wrung from the President a pledge that he would send a man-of-war to protect the old home town. Roosevelt, who received the order, chuckled over it and dispatched a Civil War monitor with twenty-one New Jersey naval militia aboard. But Portland was satisfied and felt safe!

The whole episode was ridiculous but perfectly natural. What naval officer had ever taken the trouble to tell his civilian countrymen anything about the elementary problems of war? In commenting on this episode Mahan wrote feelingly, "Whatever really enlightens public opinion in a country like ours *facilitates military operations.*" In short, the more enlightenment you spread the better for your military operations. To establish a better rela-

tion, then, between the navy and the civilian, it is necessary to have a campaign, or at least a policy, of public enlightenment. The first step is to encourage officers to write and speak for the public.

In the past it has been considered bad form, not to say officially improper, for officers to contribute to papers and magazines. Mahan himself was once curtly informed by the Department that it was not a naval officer's business to write. Nevertheless, he performed a great service by writing not only his erudite works which comparatively few would read but also by contributing articles to popular magazines—even to a boy's magazine. Of this service President Roosevelt wrote: "In dealing with our naval officers . . . Mahan was merely one among a number of first-class men. . . . But in the vitally important task of convincing the masters of all of us—the people as a whole—of the importance of naval needs, Mahan stood alone. There was no one else in his class or anywhere near it."

Admiral Sims remarked recently that if he was alive and able to speak when the next war came he would go on the Chatauqua circuit. Why wait till the next war, when it may be too late? The British Navy has prided itself on the name "Silent Service," but since the war almost every admiral has either written a book or an article for the *Times*, or both, usually with the idea of setting himself right with the public. Why should not officers be encouraged in peace times to discuss some of the matters dear to their profession with those who have their destiny in their hands—the people—and do so before post mortem explanations and apologies are called for? Why should all such discussion be expected to come from outsiders who cannot begin to have either the knowledge or the interest?

Of course criticism of the administration can hardly be encouraged, but let us have as much free speech for naval officers here as they have in England. Suppose an officer does give vent to a fool idea, it won't do any harm. He will get some wholesome criticism, you may be sure, either from the newspapers or his colleagues, or both. Better that, than having him rise to a post of responsibility with that fool idea set like granite in his head. At all events we should never see again the spectacle of 1914, when Admiral Mahan himself was muzzled by executive order for fear he might hurt someone's feelings in Berlin or reveal perhaps our

own unreadiness for war, or that of 1916 when Admiral Fiske was forbidden to say "even that two and two make four." Why should the naval officer be quarantined from the rest of his countrymen? And how can you blame the civilian public for not knowing essential things about their first line of defence if naval men are not encouraged or permitted to tell them about it? There is no Mahan for this generation of Americans.

A case in point is our situation relative to the Philippines. An American naval officer wrote the following to an English friend:

The Philippines are there for Japan whenever she likes to take them, and nothing can prevent her from seizing them when she feels disposed to do so. As at present circumstanced, we could do nothing whatever to protect them in time of war. If we were foolish enough to locate a fleet at Manila the history of Port Arthur would repeat itself, with us in the rôle of the Russians. An expeditionary force . . . could leave the southern ports of Japan, reach Manila in three days, and make itself absolute master of Luzon before succor could arrive from Hawaii, our nearest naval base, which is some 5000 miles away. Consequently, when the "rescuing fleet" did turn up, it would find the Japanese flag waving over Manila, and itself, with depleted bunkers, forced to fight under the most disadvantageous conditions or to beat an ignominious retreat without standing on the order of its going. That is not merely a picture of what might happen, but of what most assuredly will happen if war breaks out within the next few years.<sup>1</sup>

No brother officer is likely to deny the truth of that picture, but how many civilians, how many Congressmen especially, realize that it is true? To most people the fact that we have more dreadnoughts than Japan is a comfortable guarantee of victory in a conflict of sea power. But, after all, how can they be expected to know better unless the naval officer, instead of addressing only his brother officers or writing to service friends in England, finds a way of carrying the message to his countrymen? Does one American in a hundred thousand realize the importance of making Guam a fortified base, and if not who is to blame?

When an officer sets out to teach, like every other person who begins to teach, he will learn also. He will learn the civilian point of view as to war and armaments and treat it with respect, he will be careful to make his readers or hearers feel that he thinks of the navy as a servant of the nation, he will remember that it is possible for a lieutenant to be right and a rear admiral wrong, and he will

<sup>1</sup> Quoted by Hector C. Bywater, *Sea Power in the Pacific*, p. 256.

remember that not everything that is time-honored is sacred. The military mind has not been famous for its welcome to new ideas. Never a change has come, from the introduction of gunpowder to the founding of the War College, that was not fought by nine-tenths of the officers at the time. At the same time he will find it not difficult to make any audience—that is not Bolshevik—realize that a nation needs an adequate navy for the same reason that a city needs an adequate fire department and police force—anyone can grasp that. He can readily show the need of the most modern equipment and a full and well-trained personnel. He can make clear also what the navy's functions are in war with relation to our national defence. Finally, he can make the civilian realize that the military ideal in character is too fine a thing to be monopolized by the military man.

That introduces a second feature of this education policy—morale. It is not enough that people are able to perceive naval needs and problems of national defence; they must have the proper spirit. This third member of the team for national defence must not only know the plays, so to speak, but he must have the stamina, the fighting spirit. This does not mean the bellicose spirit; it means the belief in certain impalpable things that the people hold so dear that they are willing to fight to the death for them. And as history has shown, this spirit is not in the least incompatible with what Mahan called a "peace loving" nation.

National morale depends on what a nation believes in. This is a factor of enormous military significance. It is perhaps hard for a military man to realize that the most terrible force in history is an idea. It is terrible because it mocks at armies and navies; uses and disdains them at pleasure. It can conquer with the sword, as Islam swept over Europe in the armies of the Saracen and later of the Turk. It can conquer without the sword, as Christianity triumphed over Rome. It can make an army unconquerable, as the Ironsides of Cromwell or the motley soldiers of France in 1793. It can ruin an army, as the Russian of 1917, or a navy, as the German of 1918; and it is curious to see how the same Russian army that collapsed in 1917 became formidable in its devotion to Bolshevism. Napoleon paid tribute to the power of the idea when he said, "the world is ruled by imagination."

Now an idea may collapse of its own emptiness but it can be beaten only by another idea. It cannot be shut out by any *cordon*



*sanitaire*, and it can spread faster than a prairie fire in these days of rapid communication. A nation that succumbs to a demoralizing idea suffers worse than from an enemy conquest, and the latter is sure to follow as a consequence. If this country yields to the fashionable ideas about "self expression," "class consciousness," "class warfare," "peace at any price," it will fail utterly as a fighting machine, and in its failure it will drag down army and navy with it. It would seem therefore that the naval officer might well be interested in trying to preserve the older and stiffer ideals on which this country was built—in the best sense the soldierly ideals comprised in that splendid word "service." Who can do this as well as the man who has been brought up to that tradition, and who bears that word as the title of his profession?

### III. METHODS

How then shall we go about this policy of getting the people and the navy into closer teamwork? We will avoid the term "propaganda" because it is still rank with the smells of the war. We might say our motto is to "sell" the navy to the American people, but that has a commercial sound for something much finer than a trade or a deal. But whatever we call it, it must be a campaign thought out and organized by experts. The suggestions given here are merely hints of the methods that might be followed.

In the first place I venture to urge that the activities of the present Morale Division be extended to cover not only the morale of the navy but the "navy-morale" of the country. This should not shut out the work of individuals—we don't want another Creel Bureau—but the general campaign should be in the hands of the Morale Division.

The prime consideration is the objectives. There is a large section of the country, the Middle West—with which may be lumped a part of the South—which, being far from the coasts, is likely to be lukewarm about the navy. In the past the people of this agricultural section have been sneeringly dismissed as "wild-eyed Populists" or "Hicks." But they have not been all fools, nor have all the "fool ideas" they have stood for been entirely foolish. What in 1896 were "outrageous attacks on the Constitution"—like the popular election of Senators—are a matter of course in 1921. Moreover, this section of voters has the whip hand

in our elections and it is exceedingly independent in its voting. It is important then that the navy reach inland to those people and preach navy doctrine. These people never see a naval officer or a bluejacket, to say nothing of a battleship; they have no districts that fatten on federal appropriations for navy yards. They know that they are perfectly safe from the shells of an enemy fleet. Every circumstance tends to make them indifferent to their navy. Let the Morale Division, then, plan a campaign to conquer this region for the navy. Let the navy capture "Gopher Prairie"! It is a strategic point.

Further, in the last year women have become voters the country over. What interest have women in a navy? How many women understand the need of an adequate navy, and how many take any interest in it whatever? Yet these women have a tremendous power in electing the governments that can make or unmake the navy. Let the Morale Division plan a campaign also to interest the woman voter.

Lastly, there is the most fertile field of all—the voter of to-morrow, particularly the boy. Here is someone easy to convert, and to fill with enthusiasm that will last him a life time. Get the boy of to-day and you insure the navy of the future.

Now what are the avenues of approach for these objectives? Obviously one is the printed page. It ought to be easy to prepare readable articles or "stories"—fully illustrated in most cases—for every type of publication that reaches the people. Naval anecdotes, new wrinkles in naval development, facts regarding the present superiority of other navies in matériel needed by our own, the relation between our navy and our international problems—all such matters can be treated in ways adapted to publications as diverse as the *Atlantic*, *Saturday Evening Post*, the *National Geographic* and the *American Boy*. As for women's magazines, why has nobody ever written an article on a subject like "Housekeeping Aboard a Battleship"? Nor should the humble country weekly be forgotten. One way of reaching country districts is through these home papers. This is easy. Prepare what is known as "patent filler" or "boiler plate," a section of matter electrotyped and ready to fit into the page. Editors will be glad to get it, especially if it doesn't cost them anything.

It is hard to over-emphasize the value of the boy's magazines. I remember being thrilled about thirty years ago by an article in

*St. Nicholas* on the Naval Academy. What had been merely a name became thereafter something of absorbing interest. But nothing on the subject, as far as I know, has ever appeared in *St. Nicholas* since. My early enthusiasm for naval heroes was largely due to Molly Elliott Seawell and her serial, in the same magazine, on Decatur and Somers. But Mrs. Seawell is gone. The point is that you can get the boys of this generation and the voters of the near future through the boy's magazines. But why wait for some enthusiastic civilian to write the navy stuff, hoping that somebody will turn up; why not prepare and plan this material in Washington and have it published by co-operation with the editors?

Another means, of course, is the "movies." The short "educational" and news films are popular, and they spread a vast amount of information. Why not see to it that there is plenty of interesting naval information ready for the producers? Here is an easy way of showing your corn-fed voter in Iowa what our fleet looks like, how our men live and work, study and play, and at the same time sandwich in the ideas of what the navy is for.

Then there is the method by speech. There are countless occasions where an officer who can speak well and who has an attractive personality can appear and give navy talk. Rotary Club meetings, conventions of all sorts, Y. M. C. A.'s, Chamber of Commerce functions, patriotic occasions, where a naval man—if he can speak well—would be welcome, and where he could do a great deal to bring about the team spirit between navy and people. Ideal occasions are Boy Scout and Girl Scout conventions. Not one should be allowed to occur without being "planted" by a navy speaker. And there are Boys' Clubs; for example, a flourishing one on the East Side in New York. This club has distinguished men as speakers from time to time. Why not a naval man too? Nor should the schools be forgotten. The Erasmus High School of Brooklyn has, I am told, about five thousand boys. Suppose Lieutenant Isaacs, for example, were detailed to tell those boys of his experiences in the war. You would have five thousand boy "rooters" for the navy now and five thousand voters for the navy in five years.

Many other things might be done. For instance, suppose each graduating class at the Academy were asked to contribute a definite

number of their "Lucky Bags," and these were presented to the libraries of picked schools. The boys would devour them, and they would make the finest imaginable advertising for the Naval Academy. Again suppose medals and other prizes were awarded annually for essays on naval subjects in schools of various districts, and books about the navy were awarded to the schools represented by the best upper twenty-five or fifty of the essays. Indeed, one could multiply such suggestions indefinitely, but these are surely enough to indicate the lines that might be followed.

Much can be accomplished for the navy if there is a deliberate campaign directed from the Morale Division. Does all this sound fanciful? The idea of a Morale Division in itself would have been thought fanciful ten years ago. Let us not forget Mahan's saying that "whatever really enlightens public opinion in a country like ours facilitates military operations." Mahan is gone—and there is no individual to fill his place—but the process of creating enlightenment and arousing interest ought to be taken up and carried on. How else can we create a national interest in the navy, an understanding of the relation between national policy and the navy; how else to a loosefooted people like ourselves can we make clear the value of discipline—self discipline, the devotion to the ideal expressed in the word "Service"? How else can we make the civilian realize the fine inspiration in the military ideal of character? Knowledge and morale cannot be trusted to happen somehow; they must be deliberately created. If we do create them, they will react on Congress and through Congress on the navy. Then we shall have fulfilled its greatest need by establishing a team spirit between the navy and the people.



[COPYRIGHTED]

U. S. NAVAL INSTITUTE, ANNAPOLIS, MD.

---

## YAP

By COMMANDER B. C. ALLEN, U. S. Navy

---

Within the past two years the question of mandates in general has changed Yap from a possible subject for a comic opera to a probable cause for international dispute. A great deal of information, largely of the mis-variety, has been published recently, but some points of possible interest remain to be told by one who is fortunate enough to have been there when the laying of the Guam-Yap-Menado Cable put Yap on the chart, in 1905. Perhaps many changes have been effected since that time, but as it was not the German nature to improve the islands or the natives, it is probable that Yap to-day is about as it was then.

In the PROCEEDINGS for November, 1920, Lieut. Commander Luckel shows that there are only two cables in the Pacific, as compared to twenty-two in the Atlantic, and that the British Vancouver-Australia Cable does not furnish direct communication with the Orient. This leaves, to carry all of our traffic, but one cable, the San Francisco-Honolulu-Midway-Guam-Manila-Hongkong Cable and its two branches, Guam-Japan and Guam-Yap-Shanghai, both owned by Japan.

With Japan, our business competitor, in control of the direct cables to Japan and China, our communications would be subject to delay, interference and tampering. True, we have radio communication, but radio can be read by all and codes can readily be broken. It is evident that our commercial success in the Pacific demands that no other country have control of the cables.

Yap, which under German ownership, was the capital of the Western group of the Caroline Islands, Ponape being the capital of the Eastern group, is in Latitude  $9^{\circ} 30' N.$ , Longitude  $138^{\circ} E.$ , or about 500 miles southwest of Guam and 1400 miles from the

Philippines, therefore flanking the Guam-Manila line, and the Samoa-Manila line as well as forming a base for operation against Guam.

While the island probably is not fertile enough to supply food other than cocoanuts, hence would not be self-supporting. It has an excellent harbor in Tomil Haven, capable of considerable enlargement. Reference to the chart (Fig. 1) will show its size and narrow, easily protected entrance. A diagram of a 750-foot ship, drawn to scale, shows that although there are very few possible anchorages with sufficient room to swing, many ships

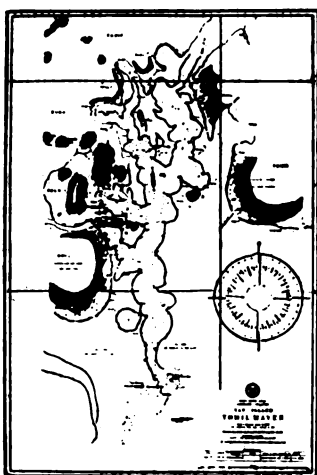

FIG. 1.



FIG. 2.

could be moored bow and stern, making an excellent base for a raiding force.

The island is about 12 miles in length with an average width of 6 miles. Tomil Haven being long and narrow, extends into its center so that indirect fire might be used against it from almost any direction (Fig. 2). The highest point is about 1000 feet, the hill being just back of Tomil Haven and affording an excellent site for fortifications. A canal connects Tomil Haven with the inlets to the northeast and northwest. This was cut through the Mangrove Swamps in about a year by 800 natives, and in 1905, was difficultly navigable by a navy cutter, being intended only for

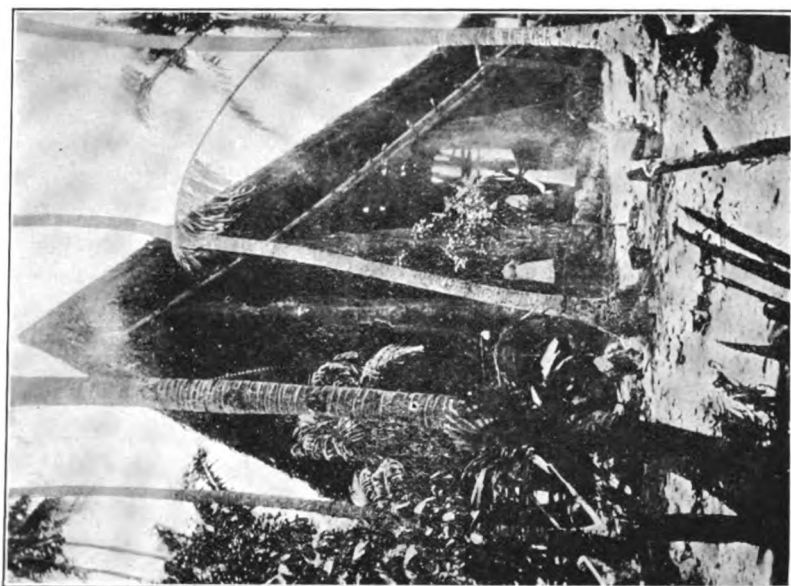

FIG. 4.—Bachelor Hut.

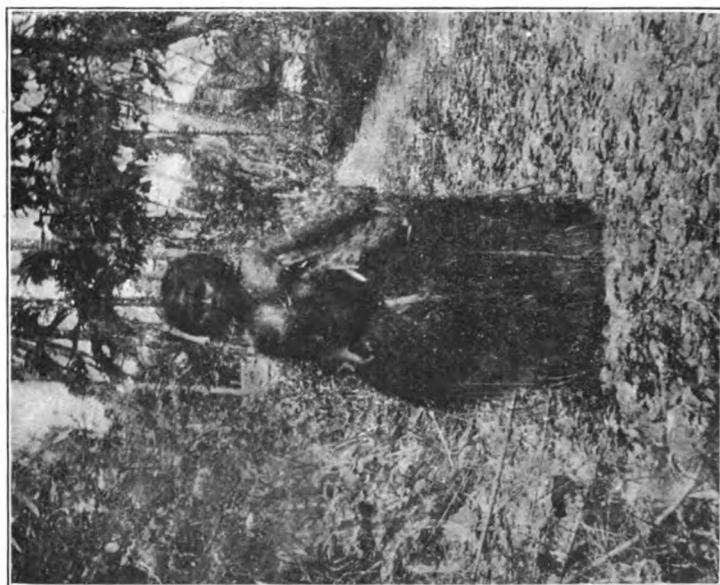

FIG. 3.—A Lady of Yap.



native canoes. It could be readily enlarged so as to accommodate destroyers, at least.

The natives of Yap number about 7000 and are called "Micronesians" or "Caroline Islanders." Their tribal instinct is strong and they do not readily mix with other peoples. They are somewhat migratory and are bold navigators. About 20 years ago a colony of them settled in Guam, where they were extensively photographed, the resultant picture postals being sold by the enterprising Japanese merchants as showing the natives of Guam. This colony was banished in a short time, being undesirable in many ways, and, in 1905 was still intact as such on Saipan, another of the Marianas. Five or six Caroline Islanders made the trip from Yap or Ruk to Guam, in a small outrigger canoe in 1905, but were wrecked in landing through the surf. They had subsisted for about two weeks on bread-fruit and rain water.

The men are rather taller and more slender than the Samoan or the "Chamorro" of the Marianas and the women smaller (Fig. 3). A feudal system was said to exist, the serfs belonging to the owner of the land upon which they lived and transferring with the land. The freeman was distinguished by the wearing of a comb in the long hair he wore like the tail of a comet, the serf being without the comb. The female serf could become free by marriage with a freeman, but the male serf could not become free. The serfs lived in villages by themselves.

Yap has been one step ahead of the so-called civilized world in the marriage system, in that they have trial marriage and find out incompatibility before and not after taking. Large "bachelor huts" are built, some of them 50 feet in height, as can be seen in the photograph (Fig. 4) by comparison with the height of the woman in the foreground. These are entirely of wood, nipa, etc., and have no nails in them. In fact in 1905 the natives still used stone tools almost entirely.

The huts of the well-to-do are sometimes fenced in by fences of stone money which is even used to pave the "yard" in front of the hut or left at the water's edge in front of a hut, as can be seen in the photograph (Fig. 5). No tale of Yap or of stone money is complete without the history of "King O'Keefe," trader and able financier. O'Keefe was, somewhat like Bully Hayes, a trader who ran a schooner from island to island collecting copra. "bêche de mer" (dried sea slugs much appreciated by the Chi-

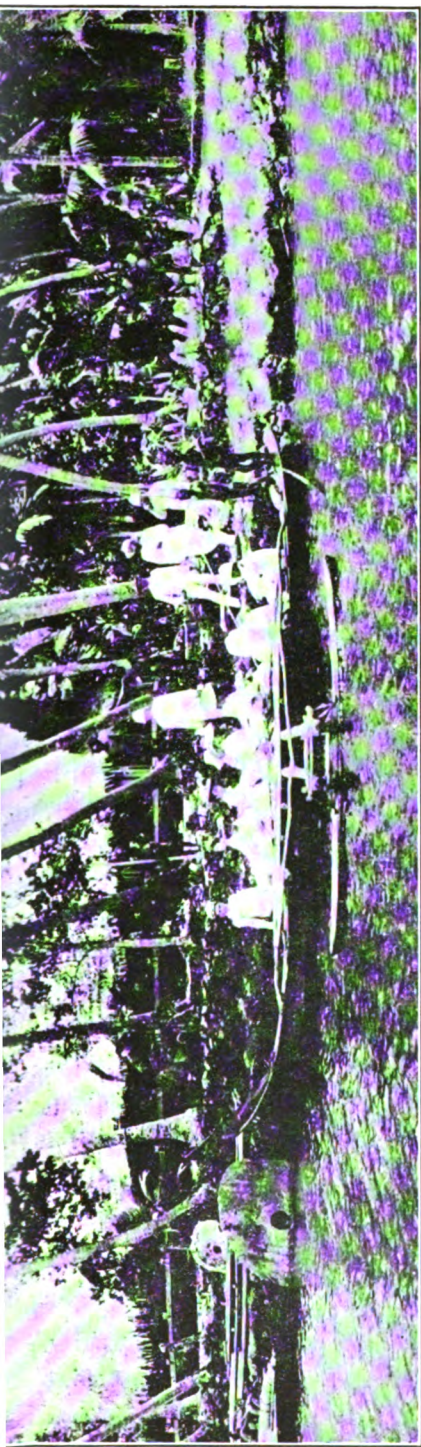

FIG. 5.—A Yap Canoe and Some Stone Money.

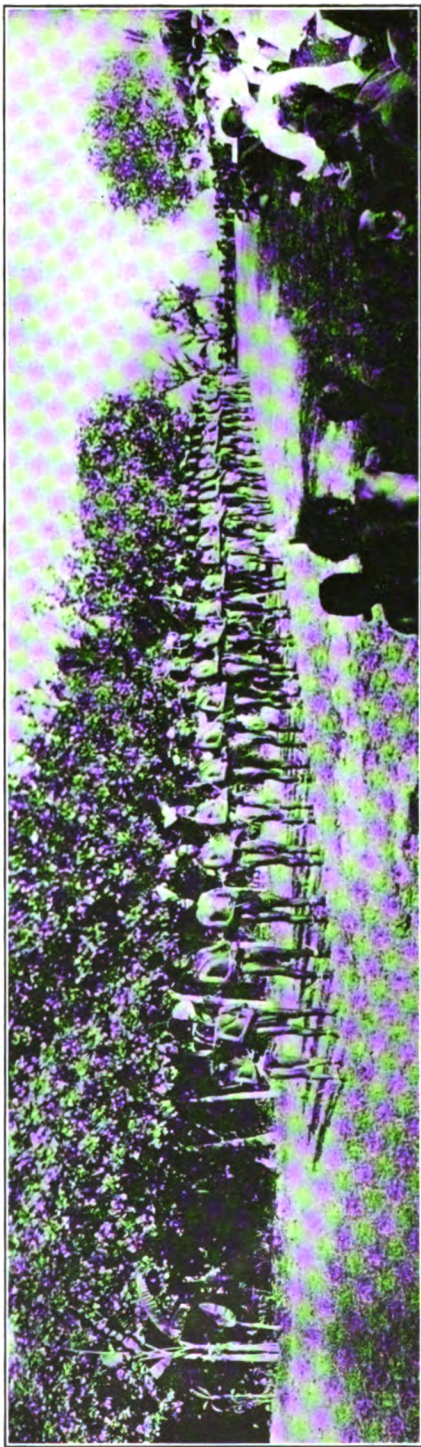

FIG. 6.—A War Dance.

nese), etc. It is said that he started his rise to affluence by marrying several daughters of well-to-do chiefs on various islands, and part at least, of the tale is true, for several of his widows lived together for years, at his trading station at Port Tomil, in amity. The next step was the establishment of a mint near his main trading station. This consisted of a stone quarry made "taboo," so no one else could use it, from which O'Keefe had cut large stone cart wheels of various sizes, the basis of the system being the cocoanut and the stone representing for each span of the hand, 1000 cocoanuts. When the native delivered cocoanuts he was paid in trade stuff or in stone money, but stone money bought no trade stuff, also as the native male wore only a jockstrap and a comb and the female a grass skirt like a haystack and a hibiscus, they needed little trade stuff (Fig. 6). O'Keefe was a great financier. It is evident that no police force was necessary to protect the money fences.

On one occasion about 20 "buck" natives came on board the *Supply*, which had been especially equipped for the Governor of Guam, and filed into the "reception room" which contained several large fans controlled from a pear push switch. These fans were started without warning, but although some of the men nearly lost their back hair they showed no sign of astonishment, except a slight flinching, nor did the stopping of the fans or the snapping on and off of the lights, break their stoicism. They had never seen such marvels before. Small cakes were passed to them and following the example of their hosts, each took one and put it in his mouth. They soon made a dignified exit and walked aft until out of sight of the Governor's quarters, then spat the cakes over the side. Such innate gentility in a naked savage was unexpected to say the least.

It is probable that the natives have some useful occupation other than chewing betel-nut sprinkled with lime and waiting for the cocoanuts to drop off the trees, but no such was in evidence. The German governor and his one assistant had created a fine state of discipline as was shown by the fact that only one native was seen by the officers of the *Supply* until after the Governor had approved them when the natives flocked around. Shortly before the *Supply* left, a bandsman went crazy and deserted, going into the thickest part of the island. A word to the Governor brought the man back within two hours.

The German system of colonization did not contemplate any improvements for the land or the natives, and all taxes went toward the maintenance and comfort of the Governor.

The occasion of the trip of the *Supply* was the completion of the laying of the Guam-Yap leg of the cable and its readiness for use. The Germans, Dutch and Eurasians engaged in the cable work, gave a picnic, the *Supply's* share of the spread being ice. A native started up the hill with a cake of it on his shoulder, then dropped it saying that it burned him. However, it finally arrived and was used to chill something with more than 2½ per cent therein. The German chief engineer of the cable company was the busiest man present as he dashed through the crowd yelling "bier, bier!" seized a bottle, backed out, emptied it and repeated the process *ad infinitum*.

It is possible that some of the statements made as to customs are in error, if so they at least have the virtue of having been made by those on the spot.



[COPYRIGHTED]

U. S. NAVAL INSTITUTE, ANNAPOLIS, MD.

---

ACROSS THE CONTINENT WITH AN INSANE MAN

By ADMIRAL R. E. COONTZ, U. S. Navy

---

In August, 1889, while an ensign in the service, I was attached to the U. S. S. *Pinta*, whose station was in Alaskan waters, but at the time in question the ship was at the Mare Island Navy Yard, for repairs. I had been away from home for several years and thought that during the stay of the ship at the navy yard, the time was opportune for a visit to my home in Hannibal, Mo. I well remember that I had accumulated the large sum of \$242 which looked big to one who had saved it in Alaska on an ensign's pay of \$109 a month. So I telegraphed Commodore John G. Walker, then Chief of the Bureau of Navigation, which bureau I had left, when ordered to sea, and requested a month's leave. I sat around with a packed trunk for four or five days awaiting a reply. One day during this wait and while at luncheon, Assistant Surgeon W. F. Arnold returned from a visit to the naval hospital and related the case of a man, who had twice escaped from the *Independence* while insane and had attempted to swim to Vallejo, and while on the second attempt had been picked up off the magazine wharf, about one mile south of the ship. He further stated that the commandant of the yard was anxious to get the man to St. Elizabeth's, Washington, D. C., the government asylum for the insane. About this time of day a telegram came from Commodore Walker granting me a month's leave providing it would not delay the preparations of the *Pinta* for sea.

I had made up my mind regarding the insane man as soon as I heard Dr. Arnold's story and went up at once to the commandant's office to interview Commodore A. E. K. Benham. This efficient and genial gentleman of the old school inquired my business and I told him I wanted to volunteer to take the insane fire-

man East. I had visions of a couple of enlisted men as guards to help me, of course, and was somewhat startled when the commodore asked me flatly whether I thought I could take the man alone. Being only 25 and green to the handling of insane people, I boldly answered "yes." "Very well," said the commodore, "I will make out your orders. You will start to-morrow night, will get the tickets in San Francisco and the man will be turned over to you at Port Costa Ferry."

About an hour later I received this order which is shown with all endorsements:

COMMANDANT'S OFFICE,  
NAVY YARD, MARE ISLAND, CAL.  
August 6, 1889.

SIR:

You will proceed to Washington, D. C., with Frederick Staade, 2d cl. fireman, an insane patient now at the naval hospital here, and deliver the said Staade to the officer in charge of the government hospital for the insane in that city.

Upon the completion of this duty, you will report to the navy department.  
Delivered Aug. 6, 1889,

A. C. Hodgson,  
Lieut. Comdg.

Ensign Robt. E. Coontz, U. S. N.  
U. S. S. *Pinta*,  
Navy Yard, Mare Island, Cal.

Respectfully,  
Your Obt. Servt,  
A. E. K. Benham,  
Commandant.

NAVY DEPARTMENT  
Approved  
Aug. 13, 1889.  
J. G. WALKER,  
Acting Secretary  
of the Navy.

NAVY PAY OFFICE  
Washington, D. C., Aug. 13, 1889.  
Paid \$251.20 Mileage from  
Mare Island, Cal.,  
to Washington, D. C.  
G. E. Thornton, Pay Director,  
U. S. N.

NAVY DEPARTMENT  
BUREAU OF NAVIGATION  
1889, August 13.  
Reported  
J. G. Walker,  
Chief of Bureau.

I was up early the next day and proceeded to San Francisco and with the assistance of A. Frank Gomez got a round trip ticket to Chicago and return leading back by Hannibal for \$135, got Staade's transportation to Washington and fixed a section in the sleepers through and no change in depot at Chicago. I took the 6 p. m. overland out of San Francisco, feeling in good spirits with practically a free trip East assured.

Up to this time I had not seen the man. When the train slowed up at Port Costa I went out and met a couple of petty officers and Staade and they hustled him on board the sleeper in a hurry, placed one white clothes bag and one black one in the berth and then left me. The first question he asked me was, "Where is my thousand dollars?" To my amazement I realized that he had imbibed at least two drinks. His question rattled me for a second and then I unhesitatingly answered, "We are on the way to get it." He had on a white hat, a blue jumper and a pair of white working trousers. The sleeper was full of women and children and I promptly gave him my traveling cap and linen duster, the latter being worn by travellers at that period. He was a stout built fireman of 16 years' service, with a muscle on him that was appalling. Any visions I had of handcuffing him, if he got obstreperous, vanished when I saw that with one blow of the handcuffs he could smash my skull. In the section opposite me was an Australian lady, and her grown daughter, bound for England. She was watching us narrowly and about the time we got to Sacramento she leaned over to me and whispered, "Excuse me, young man, but isn't there something peculiar about your companion?" Tired and hot in that August night, I blurted out, "Yes, madame, he is crazy." "Oh!" she exclaimed, "you see this is my first trip through your country and I had read so much of the rough miners who had become wealthy and I thought perhaps this was a case and your companion was a rich miner and you were his son."

I couldn't answer this question, but I was reminded of the words of Lieut. David Peacock's famous song "For he looks just like a dog-house and much resembles me."

I had the porter put the cushions in the lower berth and some pillows there and turn the upper up with the idea that my friend would sleep there and I could arrange with the porter to sit up and doze in the smoking compartment. Staade refused, however, to go to bed in any such place and about 11 p. m. we both entered



the smoker and from then-on until about 5 a. m. he told me the story of his life over and over again about 43 times. He had three ideas in his brain: First, that he was a Chinaman and his business was to dissect people, that is, he cut them up into the smallest parts possible after they were dead; second, that he had saved up money on a vessel on the South Pacific until he had \$1989 on the books, but when the end of a certain quarter came they made him sign for \$989 and somebody got the other thousand; third, that he had a saloon out on Georgia street in Vallejo and a wife and two children who lived over the saloon. Repeatedly and realistically he described this place to me, the rooms in the house, the personal appearance of his wife and children, until I began to think they must really exist.

I carefully explained to him that we would see the President and the Secretary of the Navy immediately upon our arrival in Washington.

The loss, or supposed loss, of the thousand dollars must have been the original cause of his insanity.

Somewhere about daylight I dozed off sitting upright and was rudely awakened about 6 a. m. by the conductor, who said, "Say, Mister, come and get that friend of yours. He has turned out all the people in the tourist sleeper and is giving them bits of paper and soap." I rushed in the tourist car and found he had carried his black bag in and had torn up some old German newspapers, sliced up a bar of salt water soap, and insisted on giving a piece of each to every passenger. On the plea of getting ready for breakfast I got him back in the proper sleeper, and about that time we stopped at Reno or Truckee for breakfast. We took a table and the waiter girl came up and asked him if he would have coffee. He answered, "Yes, sir." "Ham and eggs?" "Yes, sir." The girl got mad, but I smoothed it over by telling her that he had seldom met women and so said "sir" to everybody alike. When we finished breakfast and the conductor yelled "all board," Staade grabbed all the oranges, apples and bananas in the fruit dish on the table and started out. The result was the proprietor came over and I paid him a quarter for the extra fruit. After that meal I had a private talk with each eating house proprietor before we starting eating. We worried through that hot August day somehow and in the sleeper with me I found an army lieutenant named Ord traveling East with his wife and children. He kindly offered

to sit with Staade in the sleeper a few hours that evening while I slept in the smoking compartment. This was a fine chance as I was now nearly dead for sleep. About 9 o'clock, however, I was aroused by a succession of yells and on rushing in found that two of the Ord children had fallen out of the upper berth. The out-board one had seen her father talking to Staade and had leaned too far out and in falling had grabbed the inboard child and down both came. No bones were broken. Lieutenant Ord was game enough to amuse Staade until 1 a. m. Without that sleep I would have been desperate. We passed Ogden the next morning, changed sleepers and started on the 36-hour run for Omaha.

In a chair car they attached there Staade found a sympathetic friend and we sat there off and on until about 2 p. m., when we returned to the sleeper. As we passed the ladies' dressing room Staade made a break for it, got inside and locked the door. I took a seat near by, expecting he would soon come out, but he didn't and after an hour or so the conductor and porter tried to get him to open the door, but without avail. In the meantime we could hear him carrying on at a great rate and we began to get worried. About 5 p. m. he suddenly opened the door and came out. As he came up the aisle he exclaimed, "Well, that was the dirtiest, dustiest place I ever saw, so I cleaned it up." He had, there was no doubt of it. He had torn up his blue shirt and scrubbed the floor, windows and paintwork. The conductor demanded that we leave the car, but I showed him my orders and finally persuaded him that the road would have trouble with the government about it and he let us remain. By 11 o'clock that night I was dead for sleep and arranged with the porter that I was to pay him 50 cents an hour while he allowed Staade to talk to him. I sat down in the berth and was sound asleep in a second. About 2 a. m. I awoke and went into the smoking compartment and the porter was sound asleep and my insane man was gone. I aroused him and he admitted that Staade had talked him to sleep about 1 a. m. We got the conductor and brakemen and made a quick search of the train but failed to find him. The last stop had been Ogallala. Visions of a general court-martial for "neglect of duty in allowing an insane man in my charge to escape" came over me while I was getting my valise ready to leave the train and make a search for the missing man. About 3 a. m. we stopped at a cheerless station on the Platte River and I left the train. As I was about

to start up town I heard some excitement at the head of the train and the fireman came running down the platform yelling, "We have found him in the tender!" It transpired that he had slipped the porter at the last stop, gone down to the engine tender and got on board and sat there in the coal surveying the prairie scenery along the Platte River. Well, we got on board and I determined never to lose sight of him again, and I didn't. I stayed awake the next 60 hours. We got to Omaha that night, Chicago the next afternoon, and got on the Baltimore and Ohio limited train. When we finally rolled into Washington about 5 p. m., August 12, he insisted on going to the White House at once. I told him we must go to a good hotel and clean up first. I hadn't shaved since we started and wasn't letting him have any razors. Out on the sidewalk I hired a burly hack driver for five dollars, explained the situation to him and he bundled us inside and yelled "All aboard for the White House hotel." We drove across the river to St. Elizabeth's, entered the "hotel" and I got my receipt from the asylum authorities. Staade requested me to purchase him a necktie before we called on the President and the Secretary of the Navy and I went out to get the necktie and never returned. About 6 p. m. the hack driver landed me at Ebbitt House and I got a room and bath. I got out of the bath tub and sat down on the side of the bed for a minute and the next thing I heard was loud pounding on the door. It was 3 o'clock the next afternoon. Twenty-one hours had worried the hotel people. I determined next time to register from Antioch so they would think I was one of the seven sleepers and let me alone. I had slept without a stitch of clothes on, but being the month of August in Washington City, I didn't catch cold.

Well, I rushed up and reported at the department, drew my mileage, went to bed for eighteen hours again and then started for Missouri. I slept all the way out there in a dazed sort of way. My leave was shortened by telegraph and I returned to Mare Island early in September. As soon as I stood a tour of duty I took the first ferry for Vallejo and walked up Georgia street and down the hill looking on the starboard side for the man's saloon and his wife and his children. They were not there.

[COPYRIGHTED]

U. S. NAVAL INSTITUTE, ANNAPOLIS, MD.

---

## THE STUDY OF HISTORY FOR NAVAL OFFICERS

By COMMANDER C. B. MAYO, U. S. Navy

There is nothing new under the sun.  
History repeats itself.

---

### THE SWIFTNESS OF MODERN WAR

Modern method of communication, swift concentration of crushing forces, make initial mistakes irreparable. The inherent difficulty of communication in the days before steam and radio, gave ample time for thought and study before the decision on which the fate of nations depended. The outcome of a campaign rested all too often on the forces of nature—there was an ever present feeling that, plan as they would, victory might come to the blunderer through the luck of weather or circumstance, and save from annihilation the slothful in preparation. Man has conquered nature; nature has taken her revenge. Woe to the luckless commander who has not prepared himself mentally, morally, physically for the strain and trial of modern war. The swift and merciless Mars of to-day metes out destruction to the laggard. He requires laborious hours of his devotees and upon his altar must be sacrificed comfort and ease and pleasure if we are to attain those attributes which alone can guarantee victory to our country's banners.

### HISTORY REPEATS ITSELF

An officer aspiring to his full duty for his country; burning to excel in battle, must perfect himself in the rudiments of his profession in his early years and excel in the refinements thereof in later days. But this is not enough to command victory in the day of battle. The expert navigator, the bold and skillful seaman, the experienced engineer, the able tactician, all may well be

embodied in the person of the commander-in-chief of our fleets, but unless he be the possessor of a deep and thorough knowledge of the actions of great leaders in past wars, he is not fitted for his command. "History doth repeat itself," every situation of modern war finds its counterpart in past wars. "There is nothing new under the sun." A knowledge of what has gone before makes us prescient of the future. He who holds within his well-trained mind intimacy with the generals and admirals of the past wields a weapon of incalculable potential value.

#### MEANS OF ACQUIRING KNOWLEDGE AT HAND

Nor does the American naval officer have to turn far to find within his reach the means for acquiring this familiarity. Every cabin and every wardroom offers its inmates an excellent library of military history and biography. The department has done its part by placing within easy reach these books with their priceless lessons. It has done even more, for it employs an expert librarian who is ever ready and willing to advise us in our reading and to secure special books upon request. The War College has also selected a library and recommended certain books to be found on every large ship. There is, therefore, no excuse for a neglect of searching historical study by the young officers of the service. Such reading should not only impress history's lessons upon the formative mind, but will prove of value to that officer when our excellent War College opens its doors to him. How much the more benefit can be derived from a War College course if he understands the fundamentals upon which its teachings are founded! The time actually spent at the War College is of too short duration to allow exhaustive reading of *all* of history's lessons.

#### THE FASCINATION OF HISTORY'S STORY

The young officer who reaches this paragraph in this article (if any one *does* read it), will probably throw up his hands and remark that such a deep and important subject must, of necessity, be extremely dull and laborious. (Witness most of our studies at the U. S. N. A.) If the writer can claim his indulgence for a few more paragraphs *perhaps* he can be convinced that such is far from the case. Is the reader fond of adventure? What more

fascinating than the story of the Little Corporal, whose youthful genius, flaming out from the murk and chaos of the French Revolution, led ragged armies to victory at Castiglione; at Rivoli. What deed of our boyhood hero books equals the charge of the French Grenadiers with Napoleon in the lead, across the bridge of Arcola? What modern story can equal in adventure the wondrous tale of the youthful Macedonian who led his phalanxes across the desert and at 30 wept for more worlds to conquer? History is replete with youthful adventure; Alexander, Hannibal, Napoleon, Nelson, Decatur, Jackson, and a host of others flash across its pages with their deeds of daring and adventurous courage.

#### THE DRAMATIC IN HISTORY

Perhaps the dramatic appeals to the reader? What more dramatic than the council of the Athenian generals before Marathon when the Persian king, the king of kings, landed his army on Grecian shores and with his hordes threatened to extinguish forever the torch of liberty and western civilization? No stage has ever produced so dramatic a moment as when, in that council of indecision and fear, there stood forth one man who spurred his laggard comrades on to audacious attack. Does the modern drama afford spectacle half so wonderful as that of the still youthful Hannibal leading his swarthy African army across the snowy summits of the Alps—pushing his way forward with his elephants and desert soldiers, through hazardous mountain pass threatened by avalanche and savage tribes? And ever dear to the seaman's heart must be the thought of Nelson's splendid adventurous courage which sent his ships into Aboukir Bay amidst uncharted perils in the gathering darkness of the Egyptian night.

#### HISTORY TELLS THE STORY OF MANKIND

History tells the most wonderful stories of love and hate; of nobility and degradation; of victory attained by inborn genius and of the goal reached by plodding endeavor; of inordinate ambition, of self-sacrificing devotion; of villainy and heroism; of vice, of purity. Nations rise and fall only to have other nations grow great upon their ruins. A countless procession of gigantic characters march across its pages—each with their stories to tell, each with a lesson for the practical student of history.

### FAULTY METHODS OF TEACHING HISTORY

Why, it may be asked, do so many of us find the pages of historic fiction more entertaining than the source from which the story is drawn? Is it necessary that men of trained minds and analytical power be fed in homeopathic doses? The answer perhaps lies in the fact that history means school history to us. Small time is given to history in our schools and so much is crowded into so little a period as to make history largely, it is feared, a matter of more or less unconnected dates. Few of us have enjoyed the opportunity for intensive study of any one epoch, with the fascinating detail of happenings which can alone vitalize and make human the men of the period. Historical fiction is valuable, giving, as it does, side-lights on the characters of the time, but if we are really to get the meat of history for our own development, we must also study the whole story of the period in mind.

### A GENERAL KNOWLEDGE ESSENTIAL

It is well however, before taking up the study of a particular epoch, to secure a general knowledge of history, and it will be confessed, a certain number of dates must be memorized if we are to follow human progress and achievement which finds its expression in the leaders whose characters we seek to study. No book is better for this "date getting" than "Crecy's Thirteen Decisive Battles of the World," written about 1849. It may be amusing to note that this author, in his preface, makes an apology for writing of war when "the efforts of the Universal Peace Society" were thought to have made war a thing of the past. And this in 1849! The dates of the 13 battles therein given will be invaluable if committed to memory, together with a knowledge of the causes and a comprehension of the results of these battles: Marathon, Syracuse, Metaurus, Varrus and his Legions, (Teutoberg Forest), Chalons, Tours, Spanish Armada, Pultowa, Blenheim, Saratoga, Valmy and Waterloo. To these have been added Gettysburg and the Marne. It is of course, unnecessary to learn the exact year, but it is important to know within, say, 50 years of ancient battles and 10 years of the more modern combats.

## THE STUDY OF MANNERS AND CUSTOMS

Having attained our first objective—a general framework of dates, we should now study manners and customs; means of transportation and communication; economic and political situations; religious and moral developments of the peoples of history at the time of each of these dates. We will now have attained: First, a knowledge of 13 dates; second, a knowledge of at least 26 important nations, from the political, economic and moral viewpoint. But little more is needed before we can take up the study of our chosen leaders, and this is, a certain ethnographic knowledge of the races from which they spring. This is perhaps more important than at first it may seem. Can we judge Cromwell and Napoleon from the same viewpoint? The Anglo-Saxon and the Latin? How can we understand the military genius if we do not understand the people from whom he springs? The third and last step brings us to a character study of the great leader whose actions in great crisis is our particular concern.

## THE READER MUST DISCRIMINATE BETWEEN THE TRUE AND THE FAKE

Almost every great leader has his biographer—the lives of the military geniuses have proven a fruitful field for the labors of the men of letters. All too frequently, however, national pride has lent color to the pen of the biographer; almost all of these “lives” have been written by literary men with a necessarily small knowledge of war and of the principles upon which the Great Captain founded his seemingly miraculous successes. It is here that the student should use his native common sense; realize that the profession of arms has given comparatively few writers to the world and, while granting the thanks of posterity to the military biographer, carefully discriminate and seek to grasp the truth from the mass of ulterior information laid before him. Mahan, Jomini, Dodge and Henderson, however, have given us splendid studies from the military viewpoint. These books are *invaluable* to the naval student of history.

## OUR PERSONAL INTEREST IN THE GREAT LEADERS

Having now delineated for our use the personal character of the leader we are studying; his race, his ancestry, his physical charac-



teristics, his mental and moral development, early education and surroundings, position in society, and first steps up the ladder of life and fame, we come to our hero's trial by fire, how he acquitted himself and brought victory to his banners. We cannot help but feel a thrill of *personal* interest in our leader, for we *know* him now, can reconstruct the mental processes which dictated the decision which brought him his maiden laurels. Having followed him through his youthful years of preparation we can begin to apply the lessons learned to the development of our own characters. Here we again pause for a moment to study once more the conditions which surrounded him. Is a leader as fit after a long night ride on horseback as he would have been if whirled to his destination in a few hours by a comfortable train? With his character fully before us, the attendant conditions surrounding him in mind, let us now analyze his actions from a purely military standpoint.

#### THE APPLICATION OF MILITARY PHRASES TO OUR STUDY

There has grown up of late years, a distinct literature on "the Art of War," in which certain apt phrases and terms have attained a recognized standing: the initiative of the subordinate; indoctrination; loyalty to the general plan. It is for us now to apply each of these terms to our hero and appreciate his fitness by the knowledge of his adherence to the great principles of war. These *principles* never change. We will find, in many cases, *seeming* violations of these principles yet a closer study will show us that these departures were almost invariably only seeming.

#### LEE AND NAPOLEON

Take for instance, the Campaign of Second Manassas. There the Southern General, with an inferior force: First, divided that force in face of his enemy; second, moved away from the capital he was defending; third, placed his advance force in contact with the enemy with a dangerous pass in the rear, only finally to unite his whole army astride his enemy's line of communication in time for a well-nigh decisive battle. See again how history repeats itself when the same general, under yet more dangerous conditions, executes precisely this same maneuver at Chancellersville. Strive to analyze the motives which lead up to such decisions. Upon what information did he base such hazardous enterprises? See how

the spirit of a great genius rises above apparently insurmountable obstacles to snatch victory from defeat. With a knowledge of Napoleon's character, study his brilliant campaign of Austerlitz. How did Mack (by no means a poor soldier) come to surrender an army to the emperor? Why was the Archduke Charles (one of the best soldiers of his day) rendered powerless to save his country's capital? How were the armies of Austria and Russia destroyed by a single stroke at Austerlitz?

#### THE HEROES OF THE SEA

We turn from the land to the sea. Drake, Hawke, Howe, Rodney, Paul Jones, Nelson, Farragut, the resolute spirit of the great sailor shines alike in all their lives. They are singularly alike, these men of the sea, in deadly earnestness of purpose, in self sacrifice to country's need, in professional skill, in daring and in courage. The life of each is a rich treasure given to the young officer of to-day to do with as he will. Neglect the study of these men, the applications of their lessons to your own career, and you throw away a shining weapon, the lack of which will hold you to mediocrity—the possession of which will go far toward fitting you for high command.



[COPYRIGHTED]

U. S. NAVAL INSTITUTE, ANNAPOLIS, MD.

---

$$T = C - W$$

By LIEUT. COMMANDER JAMES C. VAN DE CARR, U. S. Navy

---

Recently, in working out a problem in Compass Error (and after looking it up in "Muir" to make sure), the writer happened to jot down the above expression and was immediately impressed with the familiarity of the term " $C - W$ ," as being one with which every navigator has wrestled in an effort to get his G. M. T. By placing a " $T$ " on the other side of an equation from " $C - W$ ," it is promised that no navigator need ever again scratch his head, draw circles and arrows, or desperately try to remember how to apply the old rule of "true, right, east," in connection with compass work. Think it over.

$$T = C - W,$$

or true course equals compass course minus westerly error.

The " $-W$ " suggests " $+E$ " and it is easy to write down

$$T = C + E,$$

or true course equals compass course plus easterly error.

The above two formulas, which amount to thumb rules by remembering " $C - W$ ," will solve any problem in connection with compass work. As an example, the navigator gets an azimuth of the sun and finds that it bears 100 (psc). The azimuth tables show that it bears 105 (true). Jot down:

$$T = C - W \text{ and } T = C + E.$$
$$105 = 100 + 5E$$

and therefore the compass error is  $5E$ .

Again, it is desired to steer a certain course, say 150 (true); the compass error (variation and deviation combined) is  $5W$ .

$$T = C - W \text{ and}$$
$$150 = 155 - 5W.$$

The compass course is therefore 155.

The above "Wrinkle" has been so enthusiastically received, and it is so easily applied that the writer apologetically offers it to the service in spite of its elementary nature. It is especially useful in taking temporary and reserve officers over some of the rough places in navigation, where the more fortunate of us "fit, bled, and died" in our youth.

[COPYRIGHTED]

U. S. NAVAL INSTITUTE, ANNAPOLIS, MD.

---

TACTICAL AND FIRE CONCENTRATION PROBLEMS  
AND THEIR SOLUTIONS

By LIEUT. COMMANDER H. W. HILL, U. S. Navy

---

PROBLEMS

- I. When ordered to take position on a given bearing and at a given distance from a moving ship, find:
  - (a) Change of course necessary using certain speed.
  - (b) Speed necessary if a certain change of course is made.
- II. When ordered to change distance from guide to maintain present bearing, find:
  - (a) Change of course necessary using a certain speed.
  - (b) Speed necessary if a certain change of course is made.
- III. In fire concentration, to determine the bearing of the C.-in-C.'s target from ship concerned, having been signalled the bearing of that target from C.-in-C.'s flagship (*i. e.*, the General Bearing Line).
- IV. In maneuvers, target practice, etc., to straighten maneuvering ship or unit up on a line which is parallel to, and at a given distance from, course of guide or target.
- V. To determine whether an enemy at known range and bearing and approximately known course and speed is within torpedo range, and if so, what the desired gyro setting is.
  1. The problems listed above are simple ones, but which in constantly varying form are ever present during all forms of tactical maneuvers. A quick and accurate means of solution is necessary to flag officers, commanding officers, navigators, gunnery officers and officers of the deck.

2. These problems are capable of solution by many methods, but the Battenberg Course Indicator, manufactured by the Washington Navy Yard and issued to all large ships, furnishes, in the minds of those who have tried all methods, the most practical solution. Recently a flag officer commanding a battleship division used the Battenberg Course Indicator entirely, and it was soon a remarked fact that his division, following a fleet tactical or fire concentration signal, always led all other divisions in getting the correct signal hoisted and executed.

3. Small, light, but durable, made of non-corrosive metals, so that it is readily available in all kinds of weather at any part of the bridge, it is in effect a portable, weather-proof mooring board, and requires no instruments to operate it.

4. There are three types of Battenberg Course Indicators now in use in the service. Heretofore their issue has been only to the large ships, but probably in the near future they will be supplied to cruisers and destroyer division leaders. The three types are:

(a) Mark I. Manufactured by Washington Navy Yard in 1913.

(b) Mark II. Manufactured by Washington Navy Yard in 1920.

(c) British type. Manufactured by Elliott Bros., London, Eng.

The Mark II, type is shown in Plate I, and may be briefly described as follows:

The **Tray** (1) is circular, 12 inches in diameter, and its rim is graduated from 0 to 360 degrees to indicate both bearings and reciprocal bearings. Pivoted centrally in this tray are the disc (2) and three brass arms. The **Disc** (2) is grooved with parallel lines, marked alternately red and black. The **Diameter Groove** (3) is of greater width than the other grooves and has an arrow head at each end. The unit spaces of all markings on both disc and bars are of equal size.

The two **Position Bars** (4-5) are graduated from the center in units from 0-30, each unit being subdivided into two parts. These units may be used to represent any desired scale—the larger the scale chosen, of course, the greater the accuracy obtained. On the position bars are **Pointers** (6) which may be moved to any position and clamped.

One position bar represents the observer's present position relative to the guide, or ship angled and ranged upon, and the other

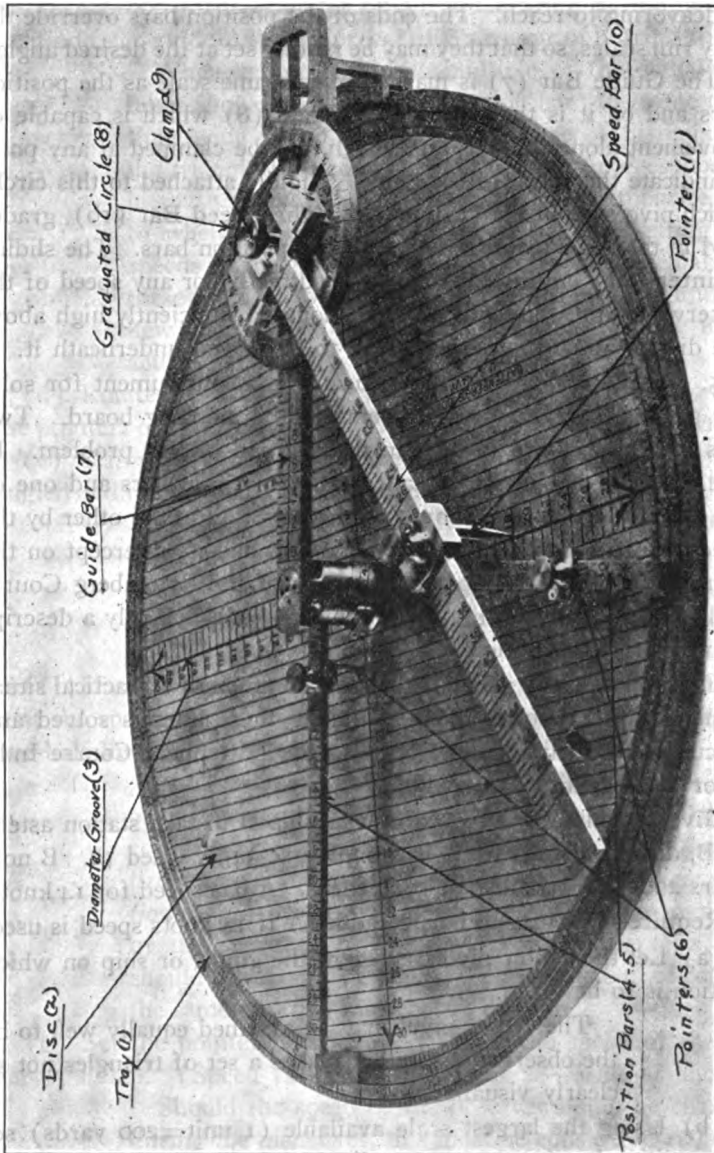

PLATE I.



represents the position relative to the guide that the observer is endeavoring to reach. The ends of the position bars override the tray rim scales, so that they may be readily set at the desired angles.

The **Guide Bar** (7) is marked in the same scale as the position bars and on it is the **Graduated Circle** (8) which is capable of movement along the bar, and which may be clamped at any point to indicate the speed of the guide. Rigidly attached to this circle, which pivots about the **Clamp** (9), is the **Speed Bar** (10), graduated in the same scale as the guide and position bars. The sliding **Pointer** (11) on this bar may be set directly for any speed of the observer's ship. The guide bar is mounted sufficiently high above the disc to allow the position bars to be moved underneath it.

5. The Battenberg Course Indicator is an instrument for solving graphically the many problems of the mooring board. Two sets of triangles are formed in the solution of any problem. In one of these the sides are made by two position bars and one of the small red or black grooves on the disc, and in the other by the speed bar, its intercept on the guide bar, and its intercept on the diameter groove. A geometrical study of the Battenberg Course Indicator solutions will not be attempted here, but only a description of how the solution is reached.

6. Problem I (a) presents the most common of all tactical situations and the following problem along these lines is solved and discussed in detail. (Plate I shows the Battenberg Course Indicator set for this solution.)

**Given:** Ship A is ordered by Flagship B to take station astern of B, distant 1000 yards. B is on course  $345^\circ$ , speed 12. B now bears  $260^\circ$  from A, distant 5000 yards. A has speed for 14 knots.

**Required:** Course to be steered by A if 14 knots speed is used.

(a) Let the center pivot represent the guide, or ship on which station is to be taken.

The center pivot may be assumed equally well to be the observer's ship, but makes a set of triangles not so clearly visualized.

(b) Using the largest scale available (1 unit=200 yards) set one position bar for the present distance (5000 yards—pointer on 25) and bearing of the observer's ship from guide B. (Reciprocal bearing  $260^\circ$ .)

(c) Using the same scale set the other position bar for the distance (1000 yards—pointer on 5) and bearing of the desired position from guide B. (Reciprocal of B's course or bearing  $165^\circ$ .)

Whenever practicable a multiple of the actual distance should be set on the position bar; the same multiple being set on both bars, of course. This enlarges the triangle formed and so makes for a corresponding increase in accuracy. This may be done without regard to whether any multiple will be used in setting the speeds on the guide and speed bars, for, as noted above, these are arms of an entirely separate triangle, and the new triangle will be similar to that formed by using actual distances.

(d) Rotate the disc till the grooves run parallel to a line joining the pointers on the two position bars. This completes this triangle.

(e) Clamp the guide bar on the course of the guide, or vessel angled and ranged on. (Guide's course  $345^\circ$ .)

If the problem to be solved is one arising from an actual or prospective change of course by the guide, the guide bar should be set for the *New Course*—i. e., the course that will be taken by the guide before the completion of the maneuver.

(f) Move the graduated circle along the guide bar and clamp it at the speed of the guide. (Clamp at 24—scale one unit equals one-half knot.)

Should the guide change speed during the maneuver, or by zigzagging have a resultant loss in advance on the course set, this must be considered as creating an entirely *new problem*, and therefore requiring a *new solution*. In order to obtain greater accuracy, a multiple of the speed of both the guide and observer's ship should be set on the guide and speed bars, but, of course, the same multiple must be set on both.

(g) Set the pointer on the speed bar at the speed of the observer's ship. (Speed 14 knots. Clamp at 28—scale as above.)

Should the speed of the observer's ship be changed during the maneuver, this must be considered as creating a *new problem* and requiring a *new solution*.

(h) Swing the speed bar around till its pointer comes to the diameter groove on the disc. The reading of the graduated circle

shows the number of degrees (37) to the left of the guide's course which must be steered to obtain the desired position under assumed conditions of course and speed. The course to be steered, therefore, is 308 degrees. *Answer.*

It will be noted that there are two solutions to every problem, due to the fact that the speed bar may be swung either to right or left to its position relative to the diameter groove. The problem, when set on the Battenberg Course Indicator, however, becomes self-apparent. A general rule is that the long end of the speed bar must be on the same side of the guide bar as the position bar which represents the present position of the observer's ship. No rule is necessary to determine whether the change of course should be made to the right or left.

7. In most instances changes of course will be made in multiples of 10 or 15 degrees. When the change of course is 10, 15, 20, 30, 45, or 60 degrees, the sines of which are easily kept in mind, the time for completion of a maneuver can be readily computed mentally.

The sines of these angles are, roughly:

10 degrees— $1/6$ .

15 degrees— $1/4$ .

20 degrees— $1/3$ .

30 degrees— $1/2$ .

45 degrees— $7/10$ .

60 degrees— $7/8$ .

8. Therefore, if in a maneuver one finds that 1000 yards must be gained to the left and the change of course is 30 degrees, speed 12 knots, the time required to run before straightening up on the base course may be quickly computed as 5 minutes. (12 knots—400 yards per minute. Since 30 degrees =  $\frac{1}{2}$ , or gain to left in 1 minute is 200 yards. In 5 minutes 1000 yards will be gained to left.)

9. The Battenberg Course Indicator supplies quickly the information needed for the above problem—as to distance to be gained to the flank. After it is set for the data of the problem, rotate the disc till the red and black grooves are parallel to the guide bar, or course of the guide. Now count the number of grooves between the pointers of the two position bars and multiply this by the num-

ber of yards per space between grooves, according to the scale used on the position bars.

10. The use of the disc as described above is a handy one, and may be used for many problems. For instance, with the fleet in column, suppose a formation signal is made which requires the van division to take station 30 degrees abaft the port beam of the guide (center) division distant 4000 yards. The Battenberg shows a big change necessary, but for sake of example, let us assume that a "Ships left 90 degrees" signal is made. As the ships of the van division run out, successive problems may be made from each range and bearing obtained of the guide, and when the ships are 1000 yards, or the distance of their advance, from the line parallel to the guide's course running through their desired position (shown by the Battenberg by method described in above paragraph), "Ships right 90 degrees" may be executed and the ships straightened up on their base course. They are now "on the line," and distance may be gained or lost on that line to bring them to the required bearing. A person experienced in the use of the Battenberg should be able to straighten up on the base course and pick up speed, within a very few degrees of the required bearing.

11. The following problems are solved and discussed to illustrate more clearly the uses of the instrument. In these solutions each setting is enumerated, making it appear slow and complicated. *It is to be emphasized, however, that all but one or two settings are kept corrected up to date at all times, so that when the signal is made to execute a certain maneuver, the correct course may be almost immediately determined.*

*Problem 1.*—**Given:** Ship A is ordered by Flagship B to take station, astern of B, distant 1000 yards. B is on course 345 degrees, speed 12. B now bears 260 degrees from A, distant 5000 yards. A has speed for 14 knots.

**Required:** (1) Course to be steered by A if 14 knots speed is used.

(2) Speed required if it is desired to steer course 315 degrees.

Solution (1) has already been discussed in Par. 6.

Solution (2):

(a) a, b, c, d, e, f, of this solution are the same as in the solution of (1) discussed in Par. 6.

(b) It is desired to steer 315 degrees, which is 30 degrees to the left of B's course. Therefore, swing the speed bar (to the right

of the guide bar—or on the same side of it as the position bar showing the present position of ship) till the graduated circle reads 30 degrees.

(c) Now move the pointer along the speed bar till it is over the diameter groove. Its position on speed bar, 26.2, indicates a speed of 13.1 knots necessary. *Answer.*

**Problem II.—Given:** Ship A, now in position 45 degrees on starboard bow of Flagship B, distant 2000 yards, base course 270 degrees, speed 12 knots, is ordered to open distance to 3000 yards maintaining present bearing. A has boiler power for 17 knots.

**Required:** (1) To find change of course possible using 14 knots

(2) To find speed necessary changing course 15 degrees to right.

**Solution (1):**

(a) From an examination of conditions it will be seen that one of the triangles is eliminated in this problem, *i. e.*, the triangle formed by the position bars and diameter groove becomes a straight line. Therefore

(b) Rotate the disc until the diameter groove is coincident with position bars, *i. e.*, to the bearings of Flagship B from ship A (135 degrees). The position bars need not be set on this bearing.

(c) Clamp the guide bar on course 270 degrees.

(d) Clamp the graduated circle at B's speed—12 knots. (Clamp at 24—scale one unit equals one-half knot.)

(e) Set the pointer on the speed bar for A's desired speed—(14 knots). (Pointer at 28—scale one unit equals one-half knot.)

(f) Swing speed bar as directed in par. 6 (h). The graduated circle gives a reading of 9 degrees, which in this case is the desired change of course to be made to the right by ship A (the present base courses of ships A and B are the same). *Answer.*

**Solution (2):**

(a) a, b, c, d, of this solution are the same as in Solution (1) above.

(b) It is desired to steer 285 degrees, which is 15 degrees to the right of B's course. Therefore, swing the speed bar until the graduated circle reads 15 degrees.

(c) Now move the pointer along the speed bar until it is over the diameter groove. Its position on the speed bar, at 32.7, indicates a speed of 16.4 necessary.

**Problem III.—Given:** The fleet deployed in battle formation. Fleet Flagship A bears 15 degrees (true) from ship B, distant 2200 yards. Fleet course is 360 degrees. Enemy is on port beam of fleet. A's corresponding ship in the enemy line is distant 15,000 yards. Flagship A hoists G. B. L. signal "My target bears from me 275 degrees. Concentrate according to plan." In order to make concentration plans the fleet flagship's target must first be identified by ship B.

**Required:** The bearing of fleet flagship's target from ship B.

**Solution:**

(a) After deploying into battle formation, individual ship or division maneuvering practically ceases, and therefore the Battenberg Course Indicator may be kept ready for this problem, and its setting kept corrected, during the battle approach, for the range and bearing of the fleet flagship, and also, if visibility is good, for the approximate range and bearing of B's corresponding ship in the enemy line.

(b) Assume the fleet flagship A to be at the center pivot.

(c) Set one position bar for range 2200 yards (pointer on 4.4—scale one unit equals 500 yards), and reciprocal bearing of Flagship A—195 degrees.

(d) Set the other position bar for range of B's corresponding ship in the enemy line (pointer on 30—scale one unit equals 500 yards), which is also the approximate range of the flagship's target from the flagship.

(e) When the signal is made, set position bar (step d) on signalled bearing (G. B. L.)—275 degrees.

(f) Rotate the disc until the grooves are parallel to the line adjoining the pointers of the two position bars.

(g) The reading of the rim scale of the tray marked by the arrow head on the end of the diameter groove is the bearing of the fleet flagship's target ship B, in this problem  $283\frac{1}{2}$  degrees.

**NOTE.**—Having this bearing of the flagship's target, it may be readily identified by glancing over an azimuth circle on a pelorus and its numerical position in the enemy line fixed. Then considering the number of enemy ships ahead or astern of this target, relative to our own battle line, the concentration plan may be quickly decided upon.

**Problem IV.—Given:** Ship A is making a run on target B, and wishes to reach a point where she may parallel target B's course, when latter bears 65 degrees to the right of this base course, on a,

line which will be 10,000 yards abeam of target B. Speed of B is estimated at 7 knots, course 360 degrees, and A's speed is 20 knots. Target B now bears from A 72 degrees, distant 22,000 yards.

**Required:** (1) To find the course which must be set to allow straightening up on the proper line when the target bears 65 degrees true (i. e., 65 degrees to the right of the base course).

(2) To find the approximate time required to reach the turning point, so that the gunnery officer may be notified.

(3) Assuming A's advance for a 60-degree turn to be 800 yards, what will be the range of the target at the proper movement to put the rudder over when straightening to the base course?

Solution (1):

(a) Set guide bar on course (360 degrees) of target B.

(b) Set one position bar for position abeam of target B or bearing 270 degrees, distance 10,000 yards. (Pointer on 10—scale one unit equals 1000 yards.)

(c) Rotate the disc until the grooves are parallel to the guide bar.

(d) Set the other position bar for the bearing of the desired position (245 degrees, or the reciprocal of 65 degrees) and note where the grooves passing through the pointer of the first position bar cut this bar. In this example 11.10—11,100 yards. (Scale one unit equals 1000 yards.)

This is the range of position desired.

(e) Having found the range and bearing of this desired position, this now becomes a simple problem and may be solved as described above in par. 6. The correct solution shows the desired course to be 60½ degrees. For sake of example, let us use 60 degrees. *Answer.*

Solution (2):

(a) The Battenberg Course Indicator is set for solution (1). Now rotate the disc until the red and black grooves are parallel to the guide bar, or base course of target B.

(b) Count the number of spaces between the grooves running through the pointers of the two position bars. (In this case 10.8.)

(c) Multiply this number by the yards per space (in this case 1000 yards) or  $10.8 \times 1000 = 10,800$  yards.

(d) Following the method described in par. 8. Twenty knots—666 yards per minute.  $\text{Cos. } 60 \text{ degrees} = \frac{1}{2}$ . Ship A will close at

the rate of 666 cos. 60 degrees = approximately 580 yards per minute. The time required in problem will therefore be

$$\frac{10,800}{580} = 18\frac{1}{2} \text{ minutes. Answer.}$$

NOTE.—For this approximate solution it is not necessary to correct for the time of turning.

Solution (3):

(a) Let us assume that the approach has been made correctly and that when about to turn the target B bears 66 degrees from A.

(b) Set both position bars on bearing 245 degrees (reciprocal of 65 degrees) with one pointer marking the distance from the target that ship A will be when on her line at that bearing.

(In this case, as found in solution (1), 11,100 yards.)

(c) Add 800 yards (assumed advance) to this distance which is the point at which the rudder should be put over, or range 11,900 yards.

(d) Due to many causes the approach, as assumed in (a), will not be perfect. If not, the same method of locating the desired *line* must be used as described in solution (1) of this problem, and the advance added to the range of the line at the actual bearing.

*Problem V.*—**Given:** Ship A steaming on course 350 degrees, speed 18 knots, is engaging enemy ship B, bearing 95 degrees, distant 13,000 yards, on estimated course 330 degrees, and speed 17 knots. A's torpedoes are good for range 10,000 yards at 30 knots, 12,000 yards at 26 knots, and 15,000 yards at 22 knots. Ship C, of A's fleet, bears 150 degrees from A, distant 2000 yards, course and speed the same.

**Required:** (1) To find if the enemy is within torpedo range, and if so what is the highest of the three speed settings that can be used.

(2) To find with what gyro angle setting the torpedo must be fixed.

(3) When fired with this setting, will the torpedo pass 500 yards ahead of ship C, assuming it runs true?

Solutions (1) and (2):

(a) Set the guide bar for the estimated course 330 degrees and speed 17 knots of enemy ship B.

(b) Set one position bar for the range 13,000 yards and reciprocal bearing 275 degrees of ship B.



(c) Set the pointer on the speed bar for the highest speed, 30 knots, of torpedo.

(d) Swing the speed bar till its pointer—set as in (c)—reaches the line between the center pivot and the pointer on the position bar. (It will be noted that the center of the pointer on the position bar is about  $1/16$  of an inch from the edge of the bar.) This completes the speed triangle.

(e) Note the reading of the graduated circle. (In this case 97 degrees.)

(f) Rotate the disc until its grooves are parallel to the speed bar.

(g) The reading of the scale on the tray rim opposite the arrow head on the diameter groove, in this case  $67\frac{1}{2}$  degrees, shows the true course which must be made by the torpedo in order to hit, at 30 knots speed, an enemy vessel on course 330, speed 17, now bearing from A 95 degrees true. This hit will be made irrespective of the range, provided that the range, measured along the torpedo track, is not in excess of 10,000 yards, the assumed maximum.

(h) Now consider the speed bar as a range bar (the scale is the same as that of the position bars) and set its pointer for the maximum range for 30 knots, *i. e.*, 10,000 yards.

(i) Keeping the speed bar at the angle obtained above, in (e) and (f), slide it along the guide bar until its pointer again reaches the line between the center pivot and the pointer on the position bar. This completes the range triangle, maintaining the angle between the course of the torpedo and the present bearing of enemy ship B.

(j) If the pointer on the position bar is closer to the center pivot than the pointer on the speed bar set, as in (i), the target is within range for this speed of the torpedo, otherwise not.

(k) This problem, when solved for a torpedo range of 10,000 yards, speed 30, shows the target to be about 1000 yards out of range.

(l) The solution, by the same method, for a torpedo range of 12,000 yards, speed 26, shows the target to be well within range, and the true course for the torpedo to be  $62\frac{1}{2}$  degrees. As A's course is 350 degrees, this is a course  $72\frac{1}{2}$  degrees to right of A's

course and will require a gyro setting of  $17\frac{1}{2}$  degrees left on the torpedo. *Answer.*

Solution (3):

(a) This is a problem similar to others previously described. Assume ship C to be at the center pivot.

(b) Set one position bar for range 2000 yards and reciprocal bearing of C from A (330 degrees).

(c) Set the other position bar on C's course 350 degrees, and the distance 500 yards; it is desired that the torpedo pass ahead of C.

(d) Rotate the disc until the grooves are parallel to the line joining the pointers on the two position bars.

(e) Set the guide bar for C's course 350 degrees, and speed 18 knots.

(f) Set the speed bar for the torpedo's speed 26 knots, and swing it until it cuts the diameter groove, extended. The graduated circle on the guide bar reads 131 degrees. This shows that the torpedo could be fired on course 350 degrees plus 131 degrees—121 degrees and still pass 500 yards ahead of C. Looking at it in another way, it may be figured that the torpedo may average as little as  $10\frac{1}{2}$  knots on its course  $62\frac{1}{2}$  degrees true and still pass 500 yards ahead of C. *Answer.*

13. It will be seen from the above problems that the Battenberg Course Indicator is an instrument capable of solving almost any type of problem which may confront an officer of the deck, navigator, captain, or flag officer during maneuvers and battle, and it is sincerely hoped that its value will be fully utilized by the units of the fleet.



[COPYRIGHTED]

U. S. NAVAL INSTITUTE, ANNAPOLIS, MD.

---

A SOLUTION OF THE OFFICER PERSONNEL  
SITUATION

By LIEUT. COMMANDER F. G. BLASDEL, U. S. Navy

---

The officer personnel situation in the navy to-day presents two problems that will necessarily have to be solved in the near future. The first is that of *promotion*. The second and the harder to solve, is the elimination of staff corps in so far as practicable.

I have endeavored to present my solution of these problems in the following proposed legislation which has been formulated from a study of the many plans put forward at various times by other officers of the navy and from a study of the question off and on during the past seven years.

PROPOSED LEGISLATION

That, on the date of the approval of this act, all staff corps in the navy, except the medical corps, dental corps and chaplain corps, shall be amalgamated with the line, and all staff officers, except those in the medical corps, dental corps and chaplain corps, shall be transferred to the line of the navy and assigned seniority in their several ranks and grades in accordance with their total length of naval service; *Provided*, That the rank of any officer shall not be reduced by anything contained in this act; and *Provided*, further, That all officers hereafter promoted from one rank, or grade, to another shall take rank at the foot of the list of officers in the rank or grade to which they are promoted in the order in which they are promoted.

That, hereafter, the total number of commissioned officers, excluding those in the medical corps, dental corps and chaplain corps, authorized on the active list of the navy shall be six per cent (6%) of the total enlisted strength of the navy divided as nearly as practicable among the several ranks in accordance with

## 1780 A SOLUTION OF THE OFFICER PERSONNEL SITUATION

the following percentages: Rear admiral, one per cent (1%); captain, four per cent (4%); commander, seven per cent (7%); lieutenant commander, fourteen per cent (14%); lieutenant, lieutenant (junior grade) and ensign, combined, seventy-four (74%).

That the number of officers authorized in the medical corps shall be one-half of one per cent ( $\frac{1}{2}\%$ ) of the total authorized strength of the navy, including both officers and men, divided as nearly as practicable among the several ranks in accordance with the following percentages: Captain, five per cent (5%); commander, seven per cent (7%); lieutenant commander, fourteen per cent (14%); lieutenant and lieutenant (junior grade), combined, seventy-four per cent (74%): *Provided*, That there shall be allowed two officers of the relative rank of rear admiral in the medical corps to be promoted by seniority from those officers of the relative rank of captain.

That the number of officers authorized in the dental corps shall be ten per cent (10%) of the number authorized in the medical corps divided as nearly as practicable among the several ranks in accordance with the following percentages: Lieutenant commander, twenty-six per cent (26%); lieutenant and lieutenant (junior grade), combined, seventy-four per cent (74%).

That the number of officers authorized in the chaplain corps shall be one for every four thousand (4000) of the total authorized strength of the navy, including both officers and men, divided as nearly as practicable among the several ranks in accordance with the following percentages: Captain, five per cent (5%); commander, seven per cent (7%); lieutenant commander, fourteen per cent (14%); lieutenant, lieutenant (junior grade) and ensign, combined, seventy-four per cent (74%).

That all officers hereafter appointed in the line shall be commissioned as ensigns from graduates of the Naval Academy, or from the enlisted personnel and warrant officers of the navy, after physical and professional examination.

That all officers hereafter appointed in the medical corps, dental corps and chaplain corps shall be appointed in the lowest grade in the respective corps from graduates of colleges after professional and physical examination.

That the several grades in the medical corps shall be as follows: Assistant surgeon with rank of lieutenant (junior grade), passed

assistant surgeon with the rank of lieutenant, surgeon with the rank of lieutenant commander, medical inspector with the rank of commander, medical director with the rank of captain and surgeon general with the rank of rear admiral.

That the several grades in the dental corps shall be as follows: Assistant dental surgeon with the rank of lieutenant (junior grade), passed assistant dental surgeon with the rank of lieutenant and dental surgeon with the rank of lieutenant commander.

That chaplains shall be commissioned as chaplains and promoted in rank as hereinafter provided.

That the total number of line officers assigned permanently to staff duty shall not exceed twelve (12) with the rank of rear admiral, seventy-two (72) with the rank of captain, one hundred and twenty-two (122) with the rank of commander and two hundred and forty-four (244) with the rank of lieutenant commander.

That not more than twenty (20) officers of the line, of, or above, the rank of commander may be detailed permanently for engineering duties only.

That officers of the medical corps, dental corps and chaplain corps shall take rank with each other and with officers of the line in the same rank or grade in accordance with their total naval service as commissioned officers.

That, hereafter, the duties heretofore performed by officers in the construction corps, supply corps, civil engineer corps and corps of mathematics, shall be performed by officers detailed from the line for that purpose.

That all officers shall be promoted, if fully qualified both physically and professionally, upon completion of service in grade as follows: Ensign, three (3) years; lieutenant (junior grade), three (3) years; lieutenant, eight (8) years; lieutenant commander, six (6) years; commander, six (6) years; captain, seven (7) years.

That hereafter officers of the navy, both on the active and reserve lists, shall be retired upon reaching the age of sixty-four (64) years, or for *total* physical disability incurred in line of duty.

That ensigns shall perform two years line duty and one year engineering duty.

That lieutenants (junior grade) shall perform one and one-half ( $1\frac{1}{2}$ ) years line duty, one (1) year detail on staff duty and six (6) months engineering duties.

That lieutenants shall perform four (4) years line duty, two (2) years engineering duty, and two (2) years detail on staff duty.

That line officers of the rank of lieutenant commander, who are not permanently detailed for staff duty, shall perform five (5) years line duty, and one (1) year engineering duty.

That whenever the number of officers in any corps, in a grade, or rank, of, or above, that of lieutenant commander and below that of rear admiral, exceeds the number herein authorized, the necessary reduction in numbers shall be made by selecting out those officers least qualified for duty in the navy; *Provided*, That the officers selected out shall be placed upon a reserve list and shall be available for any duty to which they may be assigned either under the Navy Department, or any other department of the government; *Provided*, further, That officers on the reserve list shall be promoted in the same manner as if they had remained on the active list but not above the rank of captain; *Provided*, further, That officers on the active list below the rank of lieutenant commander may be transferred to the reserve list if found unsuited, for any reason, to perform all the duties of their rank on the active list; and, *Provided*, further, That transfers to the reserve list, in accordance with this act, shall be made upon the recommendation of a board of nine officers of the rank of rear admiral for the line; a board of nine officers of the medical corps, not below the rank of captain, for the medical corps and dental corps, all the members of which shall be senior to any officer recommended for transfer to the reserve list; and a board of three chaplains for the chaplain corps, all the members of which shall be senior to any officer recommended for transfer to the reserve list.

That officers on the reserve list shall not be eligible for transfer to the active list.

That officers now on the retired list of the navy and not totally disabled may, in the discretion of the Secretary of the Navy and upon their own request, be transferred to the reserve list and if so transferred shall take rank in accordance with their total active naval service since graduation from the Naval Academy, or their appointment as commissioned officers.

That all staff officers who are transferred to the line by the provisions of this act shall be permanently detailed to such staff duty as they have heretofore been performing.

That officers of the navy, either on the active or reserve list, assigned to duty under other departments of the government shall not be entitled to any pay other than as an officer in the navy.

That nothing contained herein shall reduce the rank, or pay, of any officer now in the navy.

That all officers on the reserve list shall be available for duty with the navy in time of war, or other national emergency.

That all laws, or parts of laws, inconsistent with the provisions of this act, are hereby repealed.

#### DISCUSSION

I will not attempt to discuss the reasons for the utter failure of the present system of promotion; *i. e.*, by "selection up." However theoretically correct the system may be, it has failed dismally in its practical application and has left in its wake a disheartened, disgruntled and unhappy personnel.

The great trouble with the several methods of promotion tried out heretofore has been that they have only met the situation as it existed at the time. What the navy needs is a steady flow of promotion which will be permanent and which will meet any contingency that might arise. Such a system must be absolute and can be obtained only by "selection out." A combination of "selection up" with "selection out" is unnecessary, for if a certain percentage of officers are eliminated from those who have had the same advantages, the difference in efficiency of those remaining would be so small as not to justify "selection up," which, whatever may be said in its favor, has many inherent defects.

Any system of promotion must be fair both to the government and to the personnel.

The government which takes young boys and, at a considerable cost, educates and trains them for a life time service in the navy, has the right to expect their services for life. By this I do not mean that resignations should not be accepted, but rather that the officers, having been trained for, and in, a highly specialized profession, will, with few exceptions, remain in the navy for life. On the other hand, the officers, having entered the service of the government with its many hardships and disadvantages, expect their services to be retained by the government as long as they prove satisfactory.



So, in order to obtain a fair basis on which to work—and nothing but a plan that is founded on a fair basis will work—we must assume that officers entering the navy will remain in the government service for life or until retired for age.

Granting this assumption, one will naturally ask: "What is to be done with those selected out?" The answer to this is found in the fact that the government employs thousands of men in positions under all departments for which naval officers are ideally fitted both by education and training. Those officers "selected out" could certainly be used to great advantage by the government in such places. Most assuredly officers of the navy could be used advantageously in the diplomatic and consular services as well as many others.

The legislation as proposed, in so far as promotion is concerned, can meet with no objection from the personnel, as it is fair to them, provides a uniform promotion at all times, and gives an assurance that as long as they "deliver the goods" for the nation, the government will retain them in service.

It is fair to the government because instead of paying many officers who have been retired for slight disability three quarters pay for doing nothing, it will retain their services in positions where they will be able to work efficiently.

Under the present system, an officer has very little, if any, assurance for his future. He may be retired as an ensign on three-quarters pay for some slight physical defect, such as deafness. What happens to him? Does the government allow him to work? It certainly does not, as he is prohibited by law from accepting a position with any firm or company which has, or may have, a contract with any department of the government. This practically means that a retired officer can be a teacher, or a farmer, and nothing else. He cannot accept a government position and get the full pay of the position and he is absolutely prohibited from entering the diplomatic or consular service of the government. These are a few of the reasons why I have included a provision about retired officers in the proposed legislation.

In figuring up the number of officers in the several ranks, you will find that possibly 1600 will ultimately be in the rank of captain on the reserve list and a proportionate number in other ranks. Some emphatically state that the Congress would never pass anything like that. That is ridiculous, for they are only retaining the ser-

vices of those the country has paid to educate, and employing them in positions, the total pay roll of which to-day is far and away greater than the total pay of all the officers on the reserve list would amount to. The watch-word of to-day is "economy." This legislation would certainly be a measure of economy as it would eventually fill all important positions in the government service with highly educated, trained men at probably a less cost than such positions are now filled and at certainly an enormous saving to the country in the payment for a retired list. It would certainly result in increased efficiency in the other government services.

The proposed legislation would solve the officer personnel question in time of war, which is a point not to be neglected.

The ardent selectionists will state in regard to this proposed method that the best men will not go to the top. If there are any "best men" in the navy to-day, the present "selection up" system has certainly not resulted in their going to the top. I cannot see that the flag officers in the navy of to-day are any better, if as good, as those from John Paul Jones, down through Farragut, Porter and Robley D. Evans. So far as I know, the navy did not suffer from the lack of efficient officers in any rank in the days before "selection up."

The advocates of the "plucking board" system neglect to take into consideration that the personnel selected out must be provided for in some way or else the system will ultimately be eliminated. Give officers "selected out" means of support with nothing to do but work against a system that they consider has used them unjustly, and it is only a question of time before a change in the system will be forced. A man that has a duty to perform, whatever it is, has not much time to protest against imagined injustices of the past.

As regards the question of the amalgamation of the staff corps (except the medical, dental and chaplain corps) with the line—there is a well defined conviction among line officers that we have too many staff officers in the navy, and I have no doubt that the officers in each staff corps believe that their corps has too few. As a matter of fact, there are approximately two line officers for every staff, or non-combatant officer, in the navy, which would appear to be rather a small ratio for a fighting force.

Unquestionably an amalgamation would result in increased efficiency by the elimination of petty jealousies, by a more cordial

co-operation in the service and by a co-ordination of minds and methods.

In addition, the number of officers could be materially reduced, every officer could be used to the best advantage, and the number of officers qualified for all duties on board ship would be increased. This last is of vital importance in these days, as the World War demonstrated the necessity of an increase in the complements of combatant officers for war purposes.

To summarize, the proposed legislation, quoting the words of Commander R. A. Koch, U. S. Navy, would result in :

1. " High average ability on the active list."
2. " Promotion to the various grades at a suitable age to get all out of an officer there is in him."
3. " Selection to duty and assignment in accordance with special qualifications."
- 4: " *Esprit de corps*, team work, initiative, mutual confidence."

And in addition, would :

1. Be permanent as it would meet any possible contingency.
2. Eliminate practically all dissatisfaction.
3. Be a measure of economy for the government.

## U. S. NAVAL INSTITUTE

### SECRETARY'S NOTES

Life, regular and associate, 5487. New members, 8. Resignations, 3. Dropped, 2. Deaths, 3: Lieutenant A. C. Kozlowski (S. C.), U. S. N. Captain A. J. Minnis, U. S. M. C. Mr. C. A. Post.

Practically the whole service receives the benefit of the PROCEEDINGS yet many officers, who read it monthly, are not members and therefore contribute nothing to the support of the Institute. Members are requested to urge non-members to join. Publication costs are now so high that the Institute is carrying a loss. The cost, per member, however, decreases with an increase in membership.

The annual dues (\$3.00) for the year 1921 are now Dues payable.

Regular and associate members of the U. S. Naval Institute are subjected to the payment of the annual dues until the date of the receipt of their resignation.

Discussion of articles published in the PROCEEDINGS is cordially invited. Discussions accepted for publication are paid at one-half the rate for original articles, or about \$2.25 a page.

To insure the delivery of the PROCEEDINGS and other communications from the U. S. Naval Institute, it is essential that members and subscribers notify the Secretary and Treasurer of every change of address, without delay.

**Address of Members**

**Book Department** *The Institute Book Department will supply any obtainable book, of any kind, at retail price, postage prepaid.* The trouble saved the purchaser through having one source of supply for all books, should be considered. The cost will not be greater and sometimes less than when obtained from dealers.

The Landing Force and Small Arms Instructions, 1920, is now ready for issue. The price is \$1.00 per copy.

The first part of November the Institute will have ready for distribution a new book entitled "Airplanes, Airships, Aircraft Engines" by Lieut. Albert Tucker (C. C.), U. S. Navy. The price of this book will be \$3.50.

The Seaman's Hand Book, containing much valuable information for enlisted men, particularly those of the deck force, has been added to the Institute's publications. This excellent little book is retailed at 65 cents per copy.

The attention of readers of the PROCEEDINGS is invited to the classified analytical index for numbers **Index to Proceedings** 101 to 200 inclusive, which is noticed under "Publications." This is a most complete index, which has been prepared at considerable expense in order to make readily available the information contained in both the articles and the notes of these issues. Only a limited number of copies are being printed. Price, bound in cloth, \$2.35; bound in paper, \$1.85.

The Institute desires articles of interest to all branches **Articles** of the service, including the Reserve Force. Attention is invited to the fact that the submission of articles is not limited to members, and that authors receive due compensation for articles accepted for publication.

All articles and discussions submitted by persons belonging to the navy for publication in the PROCEEDINGS must be in duplicate, one copy being signed by the author, which will be submitted to the Navy Department when the original is published, as required by General Order No. 46, of May 20, 1921.

The attention of authors of articles is called to the fact that the cost to them of reprints other than the usual number furnished, can be greatly reduced if the reprints are struck off while the article is in press. They are requested to notify the Secretary and Treasurer of the number of reprints desired when the article is submitted. Twenty copies of reprints are furnished authors free of charge.

Authors of articles submitted are urged to furnish with their manuscript any illustrations they may have in their possession for such articles. The Institute will gladly co-operate in obtaining such illustrations as may be suggested by authors.

Original photographs of objects and events which may be of interest to our readers are also desired, and members who have opportunities to obtain such photographs are requested to secure them for the Institute.

Whole Nos. 6, 7, 10, 13, 14, 15, 17, 144, 146, 147, 173, 215 and 217 of the PROCEEDINGS are exhausted; there are so many calls for single copies of these numbers that the Institute offers to pay for copies thereof returned in good condition at the rate of 75 cents per copy.

ANNAPOLIS, MD., November, 1921.

#### INFORMATION INDEX

	PAGE
ADVERTISEMENTS, INDEX TO.....	I
PUBLICATIONS, U. S. NAVAL INSTITUTE.....	(2)
SPECIAL NOTICE .....	1854
TOPICS FOR ESSAYS .....	1855



# PROFESSIONAL NOTES

PREPARED BY

LIEUT. COMMANDER R. A. HALL, U. S. Navy

## GENERAL ARRANGEMENT

VESSELS BUILDING.	France .....	1791.
NAVAL POLICY.	Germany .....	1798
MATÉRIEL.	Great Britain .....	1800
PERSONNEL.	Japan .....	1810
MERCHANT MARINE.	United States .....	1816
AERONAUTICS .....		1824
NAVIGATION AND RADIO .....		1840
ENGINEERING .....		1841
ORDNANCE .....		1843
MISCELLANEOUS .....		1844
CURRENT NAVAL AND PROFESSIONAL PAPERS .....		1846

## FRANCE

THE CHANGING ELEMENTS OF SEA POWER.—If from 1870 to 1900 the French Navy can be said to have adhered to a policy of her own, in turn indulging in *gardecôtes*, battleships, small *torpilleurs*, *croiseurs-cuirassés*, and *croiseurs-corsaires*, there began with the 1900 Lanessan program a new period that extended up to the war, in which Gallic constructors sought their inspirations mainly in Great Britain. Thus the *Patrie* type was meant to outdo the British *Majestic*; the *Danton* was an improved copy of the *Lord Nelson*, the *Bouclier* class of destroyers embodied the good points of the British "rivers," the *Barts* owed something to the designs of the British-built *Sao Paulo*, and the *Bretagne* was a pretty close copy of the *Orion*. And no wonder, since the great bulk of French naval men professed openly the British "Doctrine Navale" (expounded by Daveluy and Darrieus) on all important questions of tactics and of strategy; and, as happens often enough, the imitators went further than the model they were copying. They prepared solely and exclusively *la bataille d'escadres*—fleet actions—and the Lapeyrère program (28 battleships) was framed on the assumption that the gun alone mattered, and consequently comprised none of the fast fleet auxiliaries for which the shipbuilding policy of Lord Fisher so wisely provided.

To-day the position has been completely reversed. *Les Français brûlent ce qu'ils ont adoré*. Just like Percy Scott in England, Daveluy (the French Mahan) finds pleasure in torpedoing the battleship idea and in sapping the very foundations of the Doctrine Navale which he contributed so much to bring into existence. True, battleships yet preserve many influential partisans in the service, especially among flag-officers and captains; but in a few years those conservative-minded *cuirasséphiles* will have joined the dense and thick ranks of the retired navy, *de la marine d'hier*, and will no longer possess "*voix au chapitre*" or consulting vote. And, of course, it would be futile to ignore the fact that the great majority of our young or



younger *officiers de vaisseaux* are very far from entertaining in their hearts the same gun and armor worship that has so long been the gospel of their fathers. Sad to note, they show scant respect for the mighty battleships of the *Bart-Bretagne* types, being struck less with the hitting powers of these *imposantes citadelles flottantes* than with the size and vulnerability of the target which they represent to mines, torpedoes and aerial bombs. In the minds of many there is a conviction that the incompleted *Normandies* will be the last of French battleships. The battleship not only has lost its former prestige but it is considered to be unsuited to France's needs.

In this respect it is not too much to say that a new era begins for the French Navy which will henceforth forge ahead, strictly on lines of her own, little influenced by what great ocean powers like Great Britain, America, and Japan can do, and this for both financial and doctrinal reasons. The cost of battleships is becoming prohibitive, save for the richest powers, and solely for those powers that are, from their geographical positions, freed from the heavy military obligations that will ever be the lot of France so long as she has to live side by side with a united and overpopulated Boche-land; and, on the other hand, the development of torpedo and aerial flotillas is attaining such proportions, and entailing such expense, that even if France could afford to increase twice over her *Budget de la Marine* (this year amounting to some 1,200,000,000 francs, including the expenditure for the Guist'hau program) she could not manage to simultaneously have an efficient battle-fleet and adequate flotillas.

It is felt that henceforth sea power will be represented by two distinct classes of navies, viz., those relying on large armored fleets for the command of the oceans and those composed entirely of *poussière navale* of a "défense-mobile" order. The question for France is whether she is to rank last among ocean powers, or to lead among "les marines-défensives." Without denying the fighting worth of the latest types of armor-clad (a point on which even *jeune école* protagonists are careful to express themselves with prudence and moderation), the majority of our naval and Parliamentary men are fond of picturing France as "la première des marines sous-marines et aériennes," and as being in a position, by virtue of her geographical situation, to command the most important European sea routes.

The Guist'hau program (6 cruisers, 24 destroyers, and 36 submarines) is merely a "programme de transition," the result of painstaking and creditable efforts consented with a view to giving the illusion "de faire quelque chose." In reality it satisfies nobody. It is no secret that Chief of General Staff Grasset and all our gunnery experts would have welcomed, instead of an overgrown 8000-ton scout, a bona fide fighting cruiser of some 12,000 tons; and—by the way—not a few French officers have sympathy with the strike-hard-and-run idea embodied in the British *Glorious*. Conservative old officers who cling to the battleship openly sneer at those so-called Guist'hau *éclaireurs* that will scout "en théorie" for a phantom fleet, whilst uncompromising partisans of "poussière navale" pure and simple are denouncing the madness responsible for the construction, in these times, of "vulnerable show mastodons of 8000 tons!"

M. Delpierre, the able editor of the "*Moniteur de la Flotte*," has on the question of the naval policy suitable to France sought the opinion of some three score *officiers de vaisseau*, mostly of the younger generations, and the results of this consultation he sums up as follows:

1. France owes to her traditions and prestige, as well as to her comprehensive maritime and colonial interests, to remain a first-class sea power; all the more so as her military power and security on land depend to a great and growing extent on her efficiency at sea and in the air. Practical unanimity exists on this point, especially since events are showing that alliances are essentially precarious and constitute no firm ground to build upon. Therefore the need of planning and acting just as if friends of to-day could become the enemies of to-morrow, and building a naval

force strong enough to discourage aggression on the part of the strongest powers.

2. The French fleet, for the immediate future at least, needs no battleships, for the twofold reason that armored fleets can never again rule the waves and that France is too poor to construct them. For the price of three 50,000-ton battleships, that would cost over one milliard francs and have mostly a nominal value, 200 submarines could be built that would count very much in the balance of sea power.

3. Therefore the naval effort must exclusively aim at supremacy for three classes of weapons, viz., submarines, flying machines, and super-cannon. "*Il faut faire peau neuve,*" the past to be erased, and a blank slate to write upon.

A truly attractive dream on paper, but it is only a dream. No masterpieces of eloquence and literature and no magic stroke can possibly change in a few days, or in a few years, the "orientation," the ways and methods of that antiquated and venerable institution called "*l'amirauté de la Rue Royale,*" that will be for many years to come in the hands of highly estimable *officiers de vaisseau*, who only know and appreciate that part of their trade that concerns pre-war methods of sea-fighting. Old dogs, especially of the Gallic species, do not learn new tricks, as is shown by the inner history of the Paris Admiralty within the last few decades. "*La supériorité aérienne,* indeed!" England possesses half-a-dozen efficient seaplane carriers in commission, and America is conducting aerial experiments on a realistic scale and with a thoroughness worthy of the admiration of every naval student, whilst France has accomplished, as always, wonderful strides on paper, but very little as yet at sea. To squarely face the truth is the road to self-improvement; mental and verbal agitation and bold program-making are poor substitutes for undelayed action.

Admiral Bienaimé approves the policy of England in leading the way in the matter of battleship displacement, this being the only safe course to minimize aerial and submarine dangers and to ensure superior speed on economical lines. Whereas the *Hood* steams 32 knots with 140,000 horsepower, no less than 200,000 horsepower would be necessary for propelling four ships of 10,000 tons at the same rate of going, 72,500 horsepower for each vessel; and, moreover, the superior armed and defended *Hood* could smash her four antagonists to pieces with impunity. Contrary to the prevailing opinion, the advent of the aerial and submarine dangers has strengthened, rather than otherwise, the case for large displacements.—*Naval and Military Record*, 17 August, 1921.

**FRENCH NAVAL POLICY.**—With regard to the naval policy of France, there appears to be considerable ambiguity, as to what this policy really is. Whilst the Republic naturally remains one of the world's great sea powers, the complete change in the strategic outlook is causing her to occupy her position in this respect in rather a negative manner. As Mr. John Leyland has pointed out, current French naval policy is ruled in great measure by the dominant necessity for retrenchment.

But although this is unquestionably a very potent factor, it is not the sole determining influence. French naval opinion is very much disturbed by a conflict of views on the subject of warship design. The doubts regarding the capital ship with which we have become so familiar on this side of the Channel are even more pronounced in France. The outbreak of war found all five battleships of the *Normandie* class, provided for in the budget of 1912, in the water, but a long stage from completion. It was not until January, 1920, that President Poincaré gave his formal assent to continuation of work upon these vessels. M. Georges Leygues, the Minister of Marine, announced, however that it had been decided to abandon further progress upon these vessels.

This step was taken as a result of the conclusions arrived at by the Superior Council of the Navy. The grounds for it were that it would be

unwise to continue the construction of battleships which would prove inferior in so many respects to the ships they might be called upon to engage. The *Normandie* type are of 24,802 tons, and designed to mount twelve 13.4-inch guns, in three turrets. The last of them to be launched, the *Béarn*, is now being used as a seaplane base and barrack-ship at Toulon.

The truth is that when the late Lord Fisher openly denounced the capital ship as obsolete in consequence of the development of new conditions of sea warfare naval thought in France was moving in much the same direction. The more moderate school urged that at any rate both the subject and the circumstances warranted and allowed of exhaustive consideration. Various high-placed officers frankly advocated a reversion to the principles of the *Jeune Ecole*, which Admiral Aube defined as "*le nombre, la vitesse, l'invulnérabilité, et la spécialisation.*" That the principles of the *Jeune Ecole* had been responsible for reducing the French Navy to a relatively inferior position was not overlooked. But the development of the submarine and the aircraft seemed to harmonize so completely with the doctrine laid down by Admiral Aube that it was contended that what was demonstrated as a dangerous fallacy towards the close of last century had now been rendered *fait accompli* by changed conditions.

It appears, therefore, that the disciples of number, and speed have triumphed, although how far they will attain invulnerability remains to be seen. Admiral René Daveluy, whom Mr. John Leyland terms the master mind of the French Navy, has ranged himself definitely on the side of the prophets of radical change in the methods of sea warfare. In writing upon the ship of the future he declares that the solution of the problem lies in the adoption of forms altogether different from traditional ones.

This academic form of destructive criticism has unquestionably profoundly influenced the policy of naval construction in France. No armored ships are to be built at all, but a great swarm of "mosquito" craft. The inevitable effect of this principle, if it is persevered in, must be to restrict the naval activities of France in her colonial zones. The characteristically logical reply to this is that it is useless to maintain naval activities with types of warships which would be unable to meet the vessels of other great sea powers. But such an admission is tantamount to a renunciation of all further competition in the balance of naval armaments.—*Naval and Military Record*, 14 September, 1921.

NAVAL AND AERIAL PROGRESS.—The enhanced effectiveness of the naval arm for colonial as well as for coastal warfare is once more demonstrated by the latest developments in Morocco. Where Spanish infantry had failed, the big guns of the *Espanas* told with rapid effect. This confirms the lessons of the Belgian coast, of the Black Sea, and of the Franco-British co-operation in Syria as to the fact that ballistic progress has considerably lengthened the arm of old Neptune and vastly increased his influence in land affairs. But much more is to come in this direction with the advent of mastodon seaplane-carriers, capable of unexpectedly appearing at any point off an enemy coast and of promptly extending their scouting and bombardment radius of action over a hundred miles inland, sowing destruction and panic in districts far removed from the belligerent zone, with disastrous consequences for the staying power of the enemy. Henceforth no coast is to remain immune from attack; no inland port militaire, however proof against direct bombardment by warships (as in the case of Brest, Rochefort, Bizerta, Portsmouth, Rosyth, etc.), is to be regarded as being safe against destructive attacks by seaplanes, at least so long as the enemy possesses a margin of aerial supremacy. In this respect a new chapter may be said to open in warfare; the world will next time witness true "*guerre intégrale*" with the whole of the belligerent nations sharing in the fight and in the dangers. It is to discuss and decide about the practical consequences of this totally new situation that the active Minister Guist'hau has called to Paris those experts who took a leading part in the *Prinz Eugen* and *Béarn* experiments.

Up to the present the British and American navies are the only ones possessing bona fide seaplane-carriers, and are thus in a position to carry on *la grande guerre* on the above-mentioned lines. The experiments in the *Béarn* just concluded have merely demonstrated the many difficulties that stand in the way of a thoroughly serviceable *navire porte-avions*, and which only time and patient training can overcome. The landing on board in practically all weathers of light and short scouting *Spads* and *Nieuports* is a relatively easy affair, and is being smartly carried out. Far more difficult is the problem with heavy bombers, so much so that many officers consider it probable that most of the bombers, after carrying out their mission overland, will fail to return to their mother ship and become a total loss in rough weather, which is a powerful argument in favor of the *croiseur aérien autonome* designed with a view to being at home on the waves as well as in the air and independent of any mother ship or convoy. It is interesting to note that comparative experiments and paper calculations have led to a return to the metallic monoplane type with raised fuselage, being an improvement of the German *Dornier* boats. Experience has shown biplanes and triplanes to be unsuited to sea conditions, float and lower wing accidents being daily occurrences. But whatever strides *autonome* flying boats may make, the seaplane-carrier has come to stay and will constitute an important element of sea power.

There are signs that monster airships and submarines, that have long existed on paper, are coming nearer to realization. Ingénieurs Simonot, Laubeuf, and others have prepared plans for submarine "transports" of 10,000 tons and above, and the suggestion has been made that state subsidies should go towards encouraging the construction of submersible cargo boats (for which plans are ready) that would ensure in war time safe communications between France and her oversea dominions. *Jeune Ecole* partisans are waxing enthusiastic over the idea, but the failure of the so-called insubmersible *Leparmentier* boats, that were constructed in America, is a timely reminder of the danger of untried, imperfectly-studied innovations. France is now too poor to afford to waste time and money as she did with the 1906 Pelletan program, comprising four boats, of which the *Charles-Brun* was a total failure, and the *Mariotte* and *Bourgeois* were lame ducks, without speaking of the Bertin boats, that proved unserviceable and did so much towards depreciating the submarine in the public eye. Indeed, it pays to proceed on safe ground and to leave nothing to chance, when is considered the check which the development of any weapon receives from failure, all the more so as the obvious advantages of size have great drawbacks as a counterpart. Thus the fine British *K-5* submarine and the gigantic *R-38* dirigible came to grief mostly because they considerably exceeded the dimensions of preceding craft and required excessive care in construction and in handling—such at least is the contention of those on this side of the Channel who advocate number rather than size, oppose the taking in hand of improved copies of the Zeppelins (of which pleasing designs have been drawn both by private firms and by the section technique), and are satisfied with the 1100-ton submersible of the Guisthau program. Exaggerated vulnerability is what they object to. Monster aeroplanes of 50 to 70 meters span, as prepared by the leading French aeronautical firms may have splendid qualities on paper and carry many tons of 400, 500, and 1000 kilo Michelin bombs, besides armor; but there remains the fact that they will be relatively slow to rise and maneuver, and therefore fall an easy prey to the ultra-rapid and marvelously handy *avions de chasse* of the *Spad* class (300 kilometers per hour). And yet an irresistible tendency in leading circles is bringing nearer the day of monster aerial and submarine craft. Aptitude to dare and run risks has ever proved for individuals and nations alike the best qualification for success. Difficulties and disasters, far from cowing down strong races, have the effect of spurring them to action. Thus it is safe to say the sad sacrifice of the aeronauts of the *R-38* has not been lost upon

go-ahead British ingenieurs and inventors, and may lead to the conquest of the aerial supremacy by England.

The French Air Secretary, M. Eynac, has just prescribed at St. Malo a "*fête aeronautique*" and an aviation display, in itself of no very great importance though interesting to note, as it shows which way the wind is blowing. In the air even more than at sea it is the human element that will tell; so in the historical roadstead of the old Breton *nid de corsaires* a dozen aviators offered the spectacle of a keen competition in bomb-dropping from various heights at changing rates of speed. Interesting results were obtained so far as accuracy is concerned, but much remained to be done in that direction. The effect of sand-filled 12- and 13-inch shells in the *Prins Eugen* was most remarkable, but the low percentage of hits on the motionless target has been a matter for derision in naval circles, the practical value of the experiment being denied by old officers. A single shell of one ton or more will disable any mastodon provided it is dropped on the right spot; it is with a view to ensuring the realization of the latter desideratum that Minister Guist'hau has decided to introduce aerial battle practice into the navy. The new sport will, further, be encouraged by prizes offered by the great constructor Michelin and several others.

The Minister of Marine has just authorized the opening of a commercial harbor in Toulon roadstead, to the disgust of many old officers who still cling to the idea that efficiency and secrecy are synonymous terms. The development side by side of naval and commercial ports, as in England, is now seen to offer no end of advantages in the way of increased personnel and matériel resources of all sorts. Our ports *militaires* are becoming semi-commercial, even Lorient receiving the 23,000-ton British *Scynthia* and several small liners to complete or refit.

Similarly, in all French circles where efficiency and economy are appreciated there is a dead set against the monopoly enjoyed by the *arsenaux de la marine*, centers of laziness and anarchy, that immobilize no fewer than 35,000 workmen, most of them with good technical training, and are a millstone round the neck of the Marine Française, entailing the yearly waste of over 300 million francs and acting as a check upon the development of the French shipbuilding industry. With the advent of new aerial and submarine weapons, that require expert and careful workmanship, the unfitnes and to a growing extent the uselessness of our huge arsenals is asserting itself in the minds of all Gallic naval students. Electoral considerations alone stand in the way of their reduction. Yet if France is to survive financially and escape bankruptcy she will have to get rid of some of her 700,000 bloodsucking parasites, and here lies the hope for the contemptors of the arsenals.—*Naval and Military Record*, 14 September, 1921.

NEW FRENCH TRAINING METHODS.—The Parliamentary vacations are drawing to a close, and this brings nearer the prospects of angry debates in the Chamber and of a possible Ministerial crisis, as deep dissatisfaction prevails as to the way in which French interests have been defended on the High Silesia question; and no wonder, since the safety of France and the possibilities of an all-around disarmament depend on the maintenance of a strong Polish State capable of preventing an anti-French (and also indirectly anti-English) coalition of Boche and Bolshevist forces. Still, confidence is felt in the tried ability of Premier Briand; and also in his well-known pro-English sentiments, to find a satisfactory issue out of the apparently inextricable situation. Meanwhile, designing, experimenting, and reorganizing are proceeding apace at Rue Royale. Indeed, splendid work has been done in all branches of the service during the last two months. "Vacations" is a blessed word in the state departments of our republic; it means methodical progress uninterrupted by ceaseless meddling on the part of good-intentioned politicians.

The *Première Escadre de combat* has regained Mediterranean waters after two months of visiting, feasting and banqueting in Channel and Atlantic ports, intermingled with bona-fide training in coastal navigation and combined exercises with the Brest and Cherbourg flotillas, that have received heavy reinforcements and are becoming redoubtable mosquito forces since being placed under the authority of the pugnacious *Prefets Maritimes* Schwerer and Barthes, who are never more happy than at sea with their pennants hoisted on board small torpedo-craft. Thus the first part is being completed of the program which the new commander-in-chief Admiral Salaun, had set himself when he assumed in July last charge of France's principal battle squadron. The second and more important part of his work he will shortly tackle in the Mediterranean, as soon as circumstances permit him to array under his flag the six 24,000-ton *Bart-Bretagnes* and the three 14,000-ton *croiseurs cuirassés* that are nominally to compose his force, together with several *escadrilles* of torpedo and aerial auxiliaries. Besides being the embodiment of well-directed activity, the Breton commander-in-chief belongs to the *Jeune Ecole* persuasion, priding himself on being the successor of another illustrious Breton naval man, Admiral Aube. And, as he means business, the scheme of preparation for war on novel lines, which he is going to apply this year and next, deserves to be watched with attention, all the more so as his crews, that are gradually being brought up to the full complement, have nothing left in them of the spirit of the Black Sea rebellion. Energetic weeding out, the practice of sports, and, above all, the greater percentage of Breton seamen on board, are raising anew the *Flotte Française* to its old standard of efficiency, without mentioning the beneficial effect of better attention to the welfare and contentment of the lower deck.

Constant sea practice, as announced by Minister Guist'hau, is, of course, to be the motto of the battle force; and gunnery, which remains the *raison d'être* of battleships, is to be carried out on new lines, as an improvement of the methods inaugurated during the war by Admiralissimo Gauchet. Turrets in all our dreadnoughts have been modified, and permit firing up to some 27,000 meters distance, which is judged to be sufficient, though our 340 mil. cannon used against the Boche have fired at over 40 kilometers. Accuracy at these extreme ranges is a matter of aerial control of stable, well-equipped flying machines, of thoroughly trained observers, and of a perfect signalling system. Whilst on paper all problems have been solved by our clever mathematicians, but little has been done in practice; and it is practice that will tell in the extreme range sport. Happily, professional interest will not be lacking, to judge from the fine preliminary preparation work conducted by the recently-constituted aviation *d'escadre*, that outwardly possesses the necessary elements of success.

Moreover, Admiral Salaun, who has had in the last war a comprehensive experience of operations at sea, and is, besides, a go-ahead man of progress, will not repeat the mistake of some of his predecessors, who considered the gun as their ultima ratio and their all-in-all, and, consequently, limited their field of mental activity to the study of those problems that had something to do with artillery duels at moderate range. Although the 24,000-ton *Bretagnes* might be superior ballistically to the remarkable *Dorias* of Italy, they would nevertheless represent a small and somewhat fragile asset of strength if their value were to reside solely in their guns and in their training for fleet actions in pre-war style. More is aimed at, and no wonder, as under the novel conditions of sea warfare France's power in the Mediterranean may be said to be invested mostly in the offensive radius of action of Bizerta, Oran, and Corsica points d'appui, as well as in the capabilities of the torpedo and aerial flotillas that will dot her extensive sea frontage. Six or seven battleships, even if in good fighting trim, are little in themselves, but they may become much if they can ever be assured of striking in co-operation with the adequate and well-trained coastal flotillas and supercannon batteries, if when moving across the Western

Mediterranean, at all times spanned by wireless and aerial transport communications, the admiral-in-chief can feel, at a safe distance across his van as well as abeam and in the rear, a double and impervious screen of weatherly and reliable aerial and submarine satellites, guarding against all possibilities of surprise, and giving time for tactical maneuvers and for his heavy guns to pound with some effect on an incoming enemy. This picture—it is for the present little more than a dream—while requiring time and finances, is above all a matter of will and stability at the head and of enthusiasm among subordinate officers for the hurricane-like character of the contests of to-morrow that will be a game of speed, initiative, and daring. To bring his heavy guns early and effectively into the fray is no longer to be the main preoccupation haunting the brains of French chiefs, if swifter and more decisive results can be got with less risks out of the torpedo and bomb. We are entering a new world in strategy and tactics, and efficiency will be more and more governed by the growing interdependence between sea, land, and air power; and for this reason the pioneer work M. Salaun will accomplish at the head of the *flotte de combat* cannot fail to be epoch-making in Gallic annals.

The prevailing opinion in British, and also in French, official circles that the world conflict has conclusively demonstrated the utter inability of the submarine to ever control the seas is meeting with an increasing number of objections, mostly as the result of the reaction in favor of submarining determined by recent German publications. Admiral Daveluy boldly stated that Boche-land would have won had she invested in submarines instead of in battleships, and now, even in semi-official organs, the opinion is volunteered, with the support of statistics that the Boches had actually the means of winning the war but for the meddling of politicians with the conduct of submarine warfare.—*Naval and Military Record*, 21 September, 1921.

### GERMANY

FROM WAR TO TRADE.—Although the conversion of warships into merchantmen is an expedient which has little to recommend it in normal times, it has been adopted to a fairly large extent since the war. So far as we are aware, no work of this description has been done in Great Britain; but in Germany, France, the United States, and Italy quite a number of former men-of-war are now sailing under the mercantile flag. It is in Germany, where the dearth of tonnage is most acute, that this policy has been carried to its greatest length. The German merchant navy now includes ex-warships of every type, from battleships down to submarines, though the latter, needless to say, have been modified to navigate on the surface instead of below it. We recently published particulars of the tank ships *Oberschlesien* and *Ostpreussen*, which were built up by joining together the hulls of unfinished *U*-cruisers, and are propelled by oil engines originally designed for *U*-boats. Further tankers of the same type are now building in Germany. It appears also that the old coast-defense battleship *Hagen* has been reconstructed as a motor cargo ship and undergone highly satisfactory trials.

Other notable cases of this kind are the *Hertha* and *Victoria Luise*, large protected cruisers, which have been refitted as merchantmen and are now in regular service. Among naval types the destroyer would seem the least susceptible of adaptation to commercial purposes, owing to the fineness of the lines and the limited space available for cargo or passenger accommodation. Nevertheless, several big destroyers have been rebuilt in Germany as merchantmen and are proving quite satisfactory in their new rôle. The motor ship *Heisdorf*, now running between German Baltic and Russian ports, was originally one of the many destroyers laid down under the German war program but not completed before the armistice. Apparently she belongs to the so-called "1916" class, representing the largest and most powerful destroyers ever built. As reconstructed she has a

new bow section, but otherwise scarcely any change has been made in the hull. She is fitted with a 420 B. h. p. Diesel engine, driving a single screw, and develops a speed of 9 knots. This installation is so compact that the greater part of the internal space is left free for cargo, of which 1350 tons can be carried. It is of interest to learn that the former U. S. destroyer *Preble* and three sister-boats have been converted into merchantmen and are now sailing under the Nicaraguan flag.—*The Naval and Military Record*, 7 September, 1921.

INVISIBLE TORPEDOES.—One of the most important revelations made by Admiral Scheer in the special interview which has been appearing exclusively in the "*Naval and Military Record*" concerns the introduction of the so-called "trackless" torpedo. To those who are unversed in the technique of naval warfare it may seem a matter of small consequence that a torpedo has been invented to rush through the water without leaving a tell-tale wake of air bubbles. But naval men will readily appreciate the significance of this innovation. At a very early stage of the war it was found that torpedo attacks, whether made by *U*-boats or destroyers, could often be defeated by keeping a sharp look-out for the track of oncoming torpedoes and making use of the helm to evade them. The first occasion on which this occurred was during the battle of the Bight, when Beatty's battle cruisers, although repeatedly attacked by *U*-boats, managed to dodge the torpedoes by the use of the helm. In the Jutland fight our battle fleet was kept busy altering course to evade the German torpedoes, and in alluding to one such attack Admiral Jellicoe wrote that "the tracks of some of the torpedoes were seen by the observers stationed aloft, and were avoided by very skilful handling of the ships by their captains." In another place he writes: "The fact of the tracks of so many of the enemy's torpedoes being visible was a matter of great surprise to me, and I think to other officers. Reports had been prevalent that the Germans had succeeded in producing a torpedo which left little or no track on the surface."

We now know these reports to have been well-founded, but, fortunately for us, the trackless torpedo did not become a practical proposition until the close of the war. Had the Germans possessed it at Jutland and earlier engagements the torpedo danger would have been greatly aggravated, while its use by their submarines and ours would undoubtedly have increased very considerably the percentage of torpedo hits. There is, of course, nothing mysterious about the trackless torpedo. It has been evolved by substituting electric motors for the compressed-air engines formerly installed, and in this way the emission of highly compressed air through the exhaust and the consequent wake of bubbles have been done away with. The only drawback is a marked loss of speed, for the electric motor is not nearly so efficient per unit of weight as the Brotherhood engine. This handicap may be overcome sooner or later, but even as it is the elimination of the tell-tale track increases the chances of hitting to such an extent that the loss of speed is more than compensated. We may be sure that the development of the new electric torpedo is engaging the attention of all the leading navies of the world to-day.—*The Naval and Military Record*, 31 August, 1921.

GERMANY'S GROWING TONNAGE.—The remarkable progress made in the restoration of the German merchant marine since the conclusion of the armistice was recently described in the "*Deutsche Allgemeine Zeitung*," one of the Hugo Stinnes organs. Reduced from around 5,000,000 to 419,000 gross tons between the outbreak and the close of hostilities, the German merchant fleet will probably total 1,140,000 tons by the close of this year. While seven ships of 30,117 tons were completed in German yards during 1918 and none in 1919, 76 of 388,506 tons were turned out last year, which record may be surpassed in 1921.—*The Nautical Gazette*, 1 October, 1921



"**BAYERN'S**" MAIDEN VOYAGE.—The Hamburg-American Line's new passenger steamer *Bayern* sailed on September 15 from Hamburg to New York on her maiden voyage. The *Bayern* is the first German passenger liner to sail for the United States since 1914.—*The Nautical Gazette*, 24 September, 1921.

NEW GERMAN SAILING CRAFT SHOW UP WELL.—Convinced that the motor sailing ship is the most economical type to operate, the Krupp Germania yard at Kiel after the war constructed for its own account 40 such units ranging from 75 to 318 feet in length and from 115 to 5600 tons deadweight. These vessels are fitted with motors of sufficient power to give them a speed of 6 knots an hour. The smaller of these ships have engines of the surface ignition hot-bulb type with from one to two cylinders. The larger craft are equipped with four-cylinder marine Diesel engines of the submarine type.

Difficulties of various sorts delayed the completion of these vessels but a number of the smaller boats have been finished recently. In order to exhibit their sailing qualities the builders had them tested out in a heavy blow for the benefit of a number of experts on board of a chartered steamer. They behaved admirably and carried out all orders signalled with promptness and despatch.

The successful outcome of this test has convinced the Krupp people more than ever of the advantages of motor sailing ships. With auxiliary motors installed even quite small vessels are in a position to make long voyages without having to take aboard a large bunker and feed-water supply to the detriment of their cargo-carrying capacity. The recently imposed heavier taxation of coal and resultant increased cost of that fuel in Germany cannot but cause German shipowners to resort more to the employment of motor sailing ships. On these craft the first cost, weight and fuel consumption of their engines are very much lower than in the case of steamers of similar sizes, while their cargo-carrying capacity is greater and a smaller number of engineers have to be employed.—*The Nautical Gazette*, 24 September, 1921.

#### GREAT BRITAIN

A SOUTH AFRICAN NAVY.—A beginning is being made by the Union Government of South Africa with the provision of a naval force of its own. A surveying sloop and some minesweeping trawlers are being taken over, and the Admiralty have called for 27 volunteer ratings to complete their crews. These men will sign on for three years, with an option to extend the engagement by one or two years. The bulk of the crews will be obtained locally, in which connection the existence of the South African Division of the R. N. V. R., enrolled under the South African Defence Act of 1912, is a great advantage. The progress of this latest of the oversea naval forces will be watched with sympathetic interest. That the Union should go in first for surveying and mine-sweeping craft, instead of cruiser and destroyer types like Australia and Canada did, is typical of the changed conditions now as compared with pre-war days. It is only fair to point out, however, that for some time the new South African force cannot relieve the mother country. It will still be necessary to keep a squadron of the Imperial Navy at Simonstown, for, as the naval correspondent of the *Morning Post* recently pointed out, with the best will in the world the Union cannot yet awhile provide and man a seagoing naval unit capable of controlling trade routes vital to South Africa and to the empire alike. Yet the home government will apparently be deprived of the yearly contribution of £85,000 towards the cost of maintaining the Cape Squadron which has been paid since 1902.—*Army and Navy Gazette*, 24 September, 1921.

**NEW CAPITAL SHIPS.**—Tenders for the construction of the four new British capital ships, it is expected, will be invited this month, writes a correspondent. All the shipbuilding firms in a position to carry out the contracts will be notified that they may tender. It is understood that these are to be practically the only war vessels to be built outside the Royal Dockyards for the present. At any rate, very little shipbuilding that can be carried out at the Royal Dockyards will go to private yards.—*Naval and Military Record*.

**DESTROYERS: A VANISHING QUANTITY.**—The Navy Estimates for 1921-22 authorize the commencement of four capital ships, one minelayer, and one submarine. No provision is made for laying down light cruisers or destroyers, and it is commonly supposed that our present reserves in both types are sufficient to meet all requirements for many a year to come. This may be true as regards light cruisers, of which we possess about 50 under ten years of age, though it should not be forgotten that only two of these vessels, *Emerald* and *Enterprise*, are equal in speed to the cruisers now building for other powers. If speed be accepted as the most important quality in light cruisers, then our position, albeit not unsatisfactory, is hardly so favorable as a mere counting of noses would indicate. And when we turn to destroyers the outlook is much less promising. It does not seem to be generally realized that a large proportion of the destroyers we had at the end of the war are no longer available. They have been scrapped wholesale, and scores of boats that nominally remain on the effective list have been allowed to deteriorate to such a degree that their reconditioning, if practicable at all, would entail almost as much expense as the building of new ones. "Fighting ships" for last year gives a total of 198 British destroyers, but we doubt whether at the present moment more than two-thirds of this number could be got ready for sea at a week's notice, irrespective of the manning difficulty.

While it would be foolish to pretend that this sweeping reduction in the size of our destroyer fleet affords ground for immediate alarm, the fact that we are well below our paper strength in a very important type of fighting ship should not be allowed to pass without remark. By the end of the year we shall have at most 150 effective destroyers, that being a liberal estimate, and as the one-Power standard has been officially adopted, no harm will be done by comparing this figure with the corresponding establishments abroad. According to the latest returns the United States Navy now contains 312 destroyers, of which 280 are less than three years old from the date of launch. Including some 40 old boats and a number of new ones not yet laid down, Japan has, or will eventually have, about 140 destroyers. The inference to be drawn from these figures is that in the course of a year or two, if nothing has been done in the interval to limit armaments by international agreement, the Admiralty may find it necessary to bring forward a new destroyer program, for the type is one that would be absolutely indispensable in any future naval campaign, no matter where or under what conditions it was waged.—*Naval and Military Record*, 14 September, 1921.

**NOT ELECTRIC.**—Rumor is the inevitable preliminary to a general knowledge of the design of new warships. And so, the Admiralty having announced that the specifications of the four capital ships which are to be built are "not completed," various reports regarding the wonderful features they are to embody promptly get into circulation. One of these is to the effect that electric propelling power will be employed. We may easily trace this to the fact that the United States battleships are all being fitted with electric propulsion. As usual, before this statement has well started upon its career it is chased by an authoritative denial. But rumors of this character want a lot of overtaking.

The fact is that naval engineers on this side of the Atlantic remain unimpressed by the merits of electric propulsion for big warships. That well-known specialist, Mr. Alexander Richardson, M. P., in discussing the performances of the *New Mexico*, says there are many incidental disadvantages to the system of electrical transmission between the turbine and the propeller. The *New Mexico* has two turbo-electric generating sets of 11,400 kilowatt capacity. These have no mechanical connection whatever with the propeller shafts. The electric power is transmitted to motors of 6600 nominal horse power, one on each of the four propelling shafts, the motors being close to the stern of the ship.

These are reversible motors, so that there are not, as in the ordinary turbine mechanical transmission system, separate turbines for going astern. During trials the *New Mexico* developed 3197 horse power more than specified in the designs, and averaged 21.08 knots for six hours. This increased power, however, was not due to electric transmission, but to the fact that, with oil fuel and steam turbines, overloads can easily be maintained for long periods. Where the real gain of the system comes in is that when running at a fraction of the full power it is only necessary to put into operation one or more turbo-electric generating units to supply the electricity to the motors. Therefore the turbo-electric generating unit can be worked at nearly full power, and consequently be made to yield maximum efficiency.—*Naval and Military Record*.

**POINTS OF CONTENTION.**—The advocates of electric propulsion maintain that the ability to use the full motive power of the ship in going astern is of great tactical value. The answer to this, however, is that the limit to the power of going astern in a turbine ship is determined by the danger of cavitation, which is likely to give trouble in high-speed vessels if, on reversing from full-ahead to full-astern, the power transmitted suddenly exceeds about 50 per cent of the full-ahead power.

At Jutland electric gear of every kind gave trouble. Under the shock of heavy gunfire switches were thrown out and circuits broken. On the other hand, mechanical and hydraulic installations maintained their functions under these conditions. The high turbine efficiency claimed for the electric drive at cruising, or economic, speeds is discounted for two reasons. First of all, the advantage is small to the point almost of negligibility when the most approved arrangement of cruising turbines is fitted to a gear-driven vessel, and, secondly, the loss of power with electric transmission is higher than with geared turbines.—*Naval and Military Record*, 17 August, 1921.

**BATTLE-CRUISERS.**—When the *Tiger* reduces to two-thirds complement at Devonport at the end of the present month there will not remain a single battle-cruiser of the Jutland era with the full commissioned fleet. Sir Walter Cowan's command will still consist of two ships only, the *Hood* and *Repulse*, for although the *Renown* nominally belongs to the battle-cruiser squadron, the "particular service" for which she is detached will keep her away from it for at least nine months.

Of course, the battle-cruisers which are being maintained at three-fifths complement in reserve are practically as available, should they be suddenly required at any time, as though they were in full commission. It has been suggested that the ships of the *Lion* group might well be adapted to burn oil fuel only. But it is very doubtful whether the Admiralty are prepared to sanction a big expenditure upon any vessels of the 13.5-inch-gun type. The *Hood*, *Repulse*, and *Renown* are, of course, all armed with the 15-inch weapon, and therefore thus far remain the "last word" in smashing power.—*Naval and Military Record*, 14 September, 1921.

THE "CAT" SQUADRON.—Whether they are modernized or not, the *Lion*, *Tiger*, and *Princess Royal* are bound to remain a valuable trio of first-line ships for a considerable time to come. They possess the qualities of very high speed, wide sea-keeping radius, and good protection, whilst their armament still remains very formidable, even when compared with the latest developments in naval artillery. No doubt they will be completely outclassed by the four capital ships it has been decided to lay down. But, then, if we are going to discard our fighting ships as fast as they are improved upon, our navy will become reduced to the last completed batch of the latest class.

The fact is that obsolescence travels in very uneven cycles. Jutland proved our capital ships to be adequate to anything in the way of gun power, but unsuspectedly defective in protective qualities. This means that ships have been condemned not because they were not still capable of putting up a staggering attack, but because they were weak in their defence. It should be quite feasible to reconstruct these ships on the same principle as in the case of the *Repulse*. But here again arises the consideration of worth while, for would the relative value which the *Lion* type would bear to the latest design, after reconstruction, justify the heavy expenditure involved? The *Repulse* is a 15-inch-gunned ship, so the question does not apply to her in anything like the same degree.—*Naval and Military Record*, 14 September, 1921.

POST-JUTLAND BATTLESHIPS.—The launch of the American battleship *Washington* on September 1 has brought the number of post-Jutland capital ships now afloat up to five, of which three are owned by the United States and two by Japan. Although often labelled as such, the *Hood* is not really a post-Jutland ship, for her designs were completed several months before the battle, and the modifications introduced subsequently did not and could not embody all the experience derived from that action. But the *Washington* and her two sisters previously launched, viz., *Maryland* and *Colorado*, were planned long after Jutland, as also were the Japanese ships *Nagato* and *Mutsu*, so that all five vessels are credited by naval authorities with a very much higher degree of tactical efficiency than that possessed by the most powerful ship laid down in the pre-Jutland era.

At least three years must elapse ere the British Navy includes any capital ships equal in armament and protection to the *Washington* or the *Nagato*, and by that time both the American and the Japanese navies will have been reinforced by several more ships of greatly increased dimensions and power. The *Washington* belongs to the "*Maryland*" class, the fourth unit of which, the *West Virginia*, is still on the stocks. Her length over all is 624 feet; breadth, 97 feet 3½ inches; the displacement at full load being 33,590 tons. She will be propelled by turbines with electrical transmission, designed for 28,000 horsepower, and a speed of 21 knots. Her main armament consist of eight 16-inch 45-caliber guns in four turrets, discharging projectiles of 2100 pounds. She will carry in addition fourteen 5-inch q. f., four 3-inch A. A. guns and two torpedo-tubes. In the latest American battleship type, now building, the displacement has been increased to 43,200 tons, the armament to twelve 16-inch 50-caliber guns, and the speed to 23 knots.—*Naval and Military Record*, 7 September, 1921.

MINELAYING VESSELS.—It appears from a reply to a question in Parliament, just before the adjournment, that the new minelayer which is to be built at Devonport is likely to make quicker progress than either the experimental submarine at Chatham, or the capital ships in the private yards. Mr. Amery stated that the boilers for the vessel are already available, as well as portions of the main machinery and the accessory auxiliary machinery. This is all to the good, as it must always be a desirable thing, once a new design has been approved, to translate it into practical shape at the earliest moment. So many excellent designs in the past have, owing

to slow construction, been rendered out of date before they could be tested in service by the ships for which they were adopted. In the case of the new minelayer she is an entirely new departure. All our minelaying vessels hitherto have been converted cruisers, ex-merchantmen, or ordinary fighting craft like destroyers and submarines temporarily diverted from their original purposes. The new ship will be the first to be designed and built for the primary duty of laying mines. As to the object in building her, anyone who gives a thought to the matter must realize that minelaying in the next war will be vastly different to that in the last, when the distances to the places to be mined were so small. Where vessels were then able to make a run of a hundred miles, lay their mines and return, in future they may be required to travel a thousand miles to perform the same operation. Even if they could go so far, it would be ridiculous to use for such an undertaking vessels like the *Paris*, carrying only 79 mines, or destroyers, carrying 40 mines each, or trawlers, carrying 25 mines, such as Admiral Bacon tells us he had to be content with in the Dover patrol.

If we turn to our present position in regard to minelaying vessels, it will be found that the war left us with none which is likely to be of future service, with the possible exception of the *Princess Margaret*. In August, 1914, there were in commission the seven ex-cruisers of the *Apollo* type, which had been fitted to lay mines, but they proved too slow to be of much use. Until November, 1914, we laid no mines whatever, and the minelayer squadron attached to the Grand fleet was utilized instead to assist the hard-worked cruiser patrols. In 1915, however, a different state of things prevailed, and the Admiralty chartered the Canadian Pacific liners *Princess Irene* and *Princess Margaret* for conversion into minelayers, of which the former was unfortunately blown up in Sheerness Harbor on May 27, 1915. The *Princess Margaret* was, however, employed in the North Sea, the Dover Straits and elsewhere during the war, and in 1919 was attached to Rear Admiral Cowan's force in the Baltic. On her return she was paid off on January 20, 1920, and is now in charge of a care and maintenance party at Portsmouth.

The experience gained in the war will naturally be taken advantage of in the design of the new vessel, even though she is likely to be very different to anything then used. When the Americans came across the Atlantic to assist in laying the northern barrage, they were able to rely chiefly on small craft because they had the advantage of a friendly base in the neighborhood. This may not be the case with us in a future war, and we may therefore have to depend entirely on the capacity and enduring mobility of our minelayers, just as the Germans were entirely dependent upon fast vessels like the *Meteor*, which made a minelaying raid into the Moray Firth in August, 1915, when the destroyer *Lynx* was blown up. The casual strewing of mines by German submarines and vessels under neutral flags as far overseas as the Cape is in a different category, but the difficulties they had to encounter shows the need of a properly equipped mining vessel which can either lay a field herself or act as a depot-ship for minelaying submarines operating in hostile waters.—*Army and Navy Gazette*, 10 September, 1921.

**TURBO-ELECTRIC PROPULSION.**—The rumor that one of the four new battle-cruisers of this year's naval program is to be fitted with a turbo-electric system of propulsion still persists, though it is very difficult to imagine on what grounds it does so. The turbo-electric is a system of transmission for marine purposes that has been received with little favor in this country. Whether because marine engineers are not usually expert electricians—and, if so, it is really mere prejudice—or whether as the result of a careful consideration of its merits compared with those of mechanically geared turbine installations, the fact remains that attempts to introduce it into Great Britain have hitherto signally failed. There is

therefore available here very little actual experience on the subject beyond what may be gathered from foreign sources. As a result of comparative trials made on three 12,000-ton colliers fitted respectively with twin screws, driven by reciprocating engines, geared turbines, and turbo-electric machinery, the United States Navy Department fitted electric driving to the battleships of the *New Mexico* and *Tennessee* class, and has adopted it for the new battleships and battle-cruisers now under construction. With these remarkable exceptions, vessels fitted with this type of machinery are very scarce indeed.

The progressive nature of the Admiralty Engineering Department towards all developments which offer promise of success is well known, but it is hardly likely to lead the Department to make its first experimental installation on a scale more than twice that of any British power station. In fact, very few stations in the world contain a plant capable of a steady output of 125,000 kilowatts, which is what the new installations represent. That in the *New Mexico* was 24,000 kilowatts. The history of United States battleship machinery since their first dreadnought *Delaware* was constructed has hardly been consistent. We have seen reciprocating engines, twin-screw direct-connected turbines, four-shaft turbine installations, more four-shaft installations, a reversion to reciprocating engines, then another twin-screw turbine and a reciprocating engine, then partially geared turbines and the electric drive follow one another year by year, and the last step was determined on while the latest battleship was fitted with piston engines. The all-geared installation has not been tried in United States battleships. There is no doubt that the United States Navy Department exhibited extraordinary boldness in passing directly from the *New Mexico* type to battleships of 60,000 and cruisers of 180,000 shaft horsepower. The latter are to be propelled by four shafts and the application of motors of 45,000 horsepower to each will be a very noteworthy feat. In the *New Mexico*, the shaft revolutions were brought down to 165 at 21 knots, which enabled very efficient propellers to be adopted. The *Hood's* revolutions were 210 for 32 knots, and anything much less for transmitting those enormous powers is likely to lead to difficulty in the manufacture of the shafting, the tail shafts for the latter being no less than 28½ inches in diameter, so that with electric driving other conditions than the motor affect the speed of rotation. The general claim made for the advantage of electric driving is that (a) the turbine speed is independent of the propeller shaft; (b) one generator can be run, for low powers, at nearly its full capacity and drive all the motors, the full capacity rendering it more economical than four separate units each running at a quarter of the power which is being developed; and (c) there is no astern turbine. It is very difficult to get marine engineers in this country to admit the advantage of any one of these points. With mechanical gearing, the turbine speed can be made almost anything desired, and with turbines driving generators, it is the construction of the generator which often controls the turbine speed. The highest turbine speed which can be used depends on the necessary area through the low-pressure blading for the desired vacua and blade efficiency, in association with the strength of blade and centrifugal stress. It may be necessary to reduce the revolutions when the power is high in order to increase the area for steam to pass through the blades without unduly increasing its velocity. This condition is frequently met with nowadays in destroyers and cruisers, and when a design approaches it there is no more to be gained from the economical point of view by putting up the revolutions. If anything, the geared installation has an advantage in this respect over the electrical drive. The latter must rotate at revolutions which suit the number of cycles employed; the former may run at any odd number. As regards (b), owing to the power being so high for the speed, neither turbine has any advantage over the other as regards full power economy, and while one turbine generator, run at nearly full power for, say, quarter-power, will

be more economical than four units each run at one-sixteenth, there is no gainsaying that when both generator and motor efficiencies are considered the difference will be materially reduced. As regards point (c), that there is no astern turbine, this is merely a small matter. With gearing, no trouble accrues from the small size of astern turbine now fitted. Against these claims there are some formidable disadvantages. First of all, the combined motor and generator efficiency at full power is materially less than that of reduction gearing. Secondly, as the turbines will be practically identical, because they will each be run at practically the maximum revolutions, and piping and condensing plants are similar, we have, in one case, the gear wheel, pinions and casing, and in the other, generator, motors and switchboard and wiring to contend with, and the weight of the latter is obviously far more than that of the former. Thirdly, as regards the astern turbine, the motors and switchboards must contain corresponding complexity to enable reversal to be effected. Summarized, we might say that turbo-electric propulsion in the eyes of British marine engineers offers three salient disadvantages: (a) Lower economy at all except very low powers; (b) considerably greater weight; and (c) more complexity by the full extent of the whole system of electrical control, the steam element remaining practically as before.

For these reasons in general, without entering into many minor points, it is most unlikely that the Admiralty advisers would commit themselves to an experiment on a colossal scale. We invariably hesitate to criticize a system which is endeavoring to fight its way, and least of all on hearsay evidence. But we admit that prior to being willing to support the Admiralty Engineering Department in an experiment on turbo-electric propulsion on even the scale of a light cruiser, we should like to know a great deal more about the performance of the *New Mexico* and *Tennessee* than has hitherto appeared. Experience of small merchant vessels with this class of machinery has been anything but satisfactory in some cases, though a number of vessels in the United States are to be fitted with it. We shall look to the future development of the type with much interest.—*The Engineer*, 9 September, 1921.

**SUBMARINE LIFTING.**—Some very interesting experiments have lately been carried out in the Albert Dock with an immense magnet which, it is claimed, will prove of great value in raising submarines that cannot recover their buoyancy sufficiently to come up again. Charged with electricity this magnet is said to be capable of raising up to 15 tons, and during the course of the demonstration brought up an iron body weighing  $2\frac{1}{2}$  tons from five fathoms of water.

It is, of course, possible that submarine mishaps might occur in which salvage operations would be quite feasible by the use of such a magnet. But as a rule the cause which leads to loss of reserve buoyancy results in complete flooding. The submarine then becomes a sheer dead-weight of several hundreds of tons. If it is only necessary to employ a lifting force representing a few tons to recover a sunken submersible, probably divers and slings would prove quite as prompt and even more effective than plumbing with a magnet. The idea is one which should prove of great utility in many directions, but we scarcely imagine that the recovery of submarines is likely to be one of these.—*Naval and Military Record*, 7 September, 1921.

**ROLLING OF WARSHIPS.**—It is understood that experiments are being carried out with a new form of gyroscopic equipment, with a view to minimizing the rolling of ships in a seaway, and that if the results are considered satisfactory the idea is likely to be generally adopted in the navy. The gunnery people will be particularly interested in these tests.

since steadiness of platform is one of the chief factors in efficiency of shooting.—*Naval and Military Record*, 31 August, 1921.

**BRITISH HELICOPTER.**—Tests with the Brennan helicopter—the new type of flying machine for rising straight into the air—are progressing satisfactorily at Farnborough, but until the experiments are completed the work will be confidential.

It will not be easy to maintain privacy when the helicopter takes the air in more ambitious flight, as it is expected to do very shortly, but for practical purposes open-air flights will probably be tried in the twilight hours.

A point of special interest is the superiority of the British type over designs favored elsewhere. It promises a notable innovation in aviation, alike for military and civil purposes. For instance, a ship mothering aeroplanes will no longer need to be equipped with cumbrous reaches of decking, as a modest area will suffice for the helicopter.

When space can be similarly economized in land stations, the prospect opens of the helicopter's invasion into the busiest of populous centers—making it as easy to take as train or tram.—*Naval and Military Record*.

**FIVE LIVES LOST IN DISMANTLING OF "DEUTSCHLAND."**—A disastrous explosion occurred in the ex-German submarine *Deutschland* on Saturday at Birkenhead Yard, where the vessel was being dismantled. Three 17-year-old apprentices were killed at once and two others succumbed to injuries later in the day. The cause of the explosion is a mystery.

The *Deutschland* was the big German *U*-boat which made the voyage to Baltimore in June, 1916, under the command of Capt. Paul König. She carried a cargo of precious stones, dyes, and patent medicines to German firms in the United States. Following upon this trip she took part in unrestricted submarine warfare, and after the armistice was handed over to Great Britain.—*Naval and Military Record*, 14 September, 1921.

**ENGLISH ADMIRALS TO EARN THEIR SALT.**—The British reserve fleet is about to be reorganized in such a fashion that its "admirals will earn their money." As at present constituted the reserve fleet consists of only a few light cruisers and destroyers, and yet it has one vice admiral and four rear admirals. Moreover, it is scattered among the home dockyard ports, at which there already is an admiral who is a naval commander-in-chief and an admiral superintendent of the dockyard, so at each port there are three officers of admiral's rank.

To correct that abuse, in the future there will be only one admiral commanding the reserve fleet. The other admirals will be assigned to the active Atlantic fleet for training. They are to go through a war course, a course of weapon technic, a submarine and anti-submarine school, an air-force school of co-operation with the navy, and, finally, three months' active duty with the Atlantic fleet. The three months will be divided among various portions of the fleet: a fortnight each with battle cruisers and light cruisers, a week with the rear admiral of destroyers, a week with the senior officer of submarines, a week on board a fleet aircraft carrier and a month on the fleet flagship.

When with the cruisers the reserve admirals will be permitted to handle them in tactical maneuvers, and toward the end of the month on the fleet flagship they are to maneuver the whole Atlantic fleet for two days each. At the close of their training, the commander-in-chief of the Atlantic fleet is to communicate confidentially to the Admiralty his opinion of their capabilities as fighting commanders. A brief comment is that at the close of those courses "the country will get full value for its money."—*Philadelphia Public Ledger*, 10 October, 1921.



**NORMAL CONDITIONS RESTORED AROUND BRITISH ISLES.**—The Admiralty announces that the work of clearing the Heligoland Bight minefield has now been successfully accomplished by the Germans. This marks a definite stage in the work of restoring the seas to normal conditions since the entire North Sea is thus rendered clear of moored mines. The waters surrounding the British Isles are now entirely cleared. The Mediterranean Sea is practically cleared, only three small areas on the Albanian coast remaining, the clearing of which should be completed this year.

Four small areas remain in the Arctic, for which Germany is responsible, and a German mine-sweeping flotilla is at present at work there, but in all probability ice has affected their clearance during the last four winters. In the Baltic mines still exist between latitudes 56.30 N. and 60.30 N. to the eastward of 17.30 E., and here mine clearance is in progress. In the Adriatic the three small areas still to be swept will be cleared in the near future, one by Italy and two by Yugo-Slavia.

With one exception, the fields enumerated above constitute the only areas which now remain to be made safe for shipping. The one exception is the Black Sea. Here are still numerous minefields. No international agreement exists for their removal, and the region is now in a far worse condition than when the British mine-sweeping forces withdrew, more mines having been laid by the Russians.

This work of clearing the seas has been carried out under the ægis of the International Mine Clearance Committee, brought into existence as a result of the Allied Naval Conference on clearing the seas of mines after the war. During war time seaborne trade was regulated by the convoy and other systems, but on the arrival of peace no such restrictions could be imposed, and shipping had to be warned of the existing dangers and of the changes as they occurred.

The committee's mine warnings obtained a worldwide reputation. Not one report has been received of a vessel striking a moored mine while obeying the committee's instructions. Considering the vast tonnage afloat and the enormous aggregate mileage covered, it is remarkable that accidents have been so few, and where these have occurred it has in all cases been proved that the casualty was directly caused by a breach of the instructions.—*Naval and Military Record*, 14 September, 1921.

**BRITISH AND GERMAN SHIPYARD ACTIVITIES CONTRASTED.**—In a series of articles entitled *Germany on the Seas*, the London *Daily Telegraph* asserts that before the war only 25,000 men were employed in German yards as compared with 100,000 in May last. Of these 70,000 were working on vessels which were to be paid for out of the funds voted by the German Government to replace ships lost by the terms of the Versailles peace treaty.

Deliveries by the yards to German firms began on a large scale only during the present year. In the first quarter of 1921 the Hamburg yards completed eight steamers of 36,000 tons, while in the succeeding quarter the output rose to 16 vessels aggregating 106,000 tons. At present 64 steamers of 300,000 tons deadweight are on hand on the Elbe alone. Eighteen of these are for the Hamburg-American Line, while 5 are to be constructed for foreign owners.

"While the shipyards of the Clyde and Tyne are deserted and silent," continues the *Telegraph*, "those of the Elbe are teeming with busy men and ringing from morning till night with the rattle of the pneumatic riveter. While ten to fifteen million tons of Allied and neutral cargo space lie rusting in the back waters, Germany is not merely building new ships as fast as she can, but is also buying back many of those she was compelled by the Versailles Treaty to surrender."—*Scientific American*.

**ECONOMIC CONDITION OF BRITISH SHIPBUILDING.**—What may well be taken as a direct reflection of the general state of affairs in the shipbuilding industry is the announcement which Messrs. Yarrow and Co., Ltd., of Scotstoun, on the Clyde, have recently made to their workmen and sent to the press. They intimate that they have decided to temporarily close their works, with the exception of the experimental and research department, on or about November 30, and will reopen when conditions enable business to be carried on with some chance of success. They state that owing to repeated strikes, reduction of output, and demarcation disputes which have taken place in various industries throughout the country, the cost of shipbuilding has become excessive; in addition to which it is impossible to promise dates of delivery. As an illustration both of shipbuilding difficulties and their reluctance to close down, the firm states that a recent offer which they made for a British steamer, an offer involving about £25,000, which would have left them no profit, and which turned out to have been the lowest in this country, was underbid by a Dutch firm to the extent of £6000. Another instance of the same kind, although experienced by another firm, may here be referred to. Messrs. Rennie, Ritchie and Newport Shipbuilding Co., who operate several yards throughout the kingdom recently lost an order for 50 barges owing to a Dutch firm cutting in at one-third less their price, and in a way which throws a striking light on the manner in which the British labor troubles are sending work abroad. The order for these 50 barges for South America had actually been placed with the firm, and the contract was on the point of being signed. As the barges, however, had to be delivered through Antwerp, enquiries were being made in that port. In this way a firm in Antwerp got wind of the business, and they applied direct to the principals, offering to build the vessels at one-third less than the English firm. This was accepted, and forthwith the Antwerp firm handed the order over to Holland builders and got 10 per cent on the business. Such facts as these (and they are by no means isolated) are convincing evidence of the deplorable condition of affairs which have for a considerable time operated against the British builders securing orders, and whose continuance is now causing firms to close their works. This is the second Clyde shipyard which the adverse state of affairs has so seriously affected. Some little time ago the Lloyd Royal Belge Co., at Whiteinch, practically closed their works, owing to the inability of the shipowning concern, the Lloyd Royal Belge Co., of Antwerp—who were operating the yard chiefly on their own account—to continue building at a great loss, tonnage they were finding could be produced at reasonable cost in Antwerp. While the case of Messrs. Yarrow—who have renown and experience chiefly in types of ships other than plain merchant vessels—may be thought to be exceptional, there is abundance of other striking evidence of the pass to which the general state of shipbuilding has now come. The slump in shipbuilding contracts, and the delays in the completion of work actually on hand, alike point to this. While costs of shipbuilding material have certainly fallen somewhat since the end of the coal strike, and the supply and price of coal has become more normal, there are still other factors which contribute to the perpetuation of the depression and the increase of the unemployed. Wages in every branch must be lowered considerably before any tangible revival can be hoped for, especially considering the low volume of world's trade, and the superabundance of existing shipping tonnage to deal with it. It must surely be recognized by all workers that it is better to be employed at such remuneration as industry can really afford, and thrive upon, than to employ a small number and leave the great masses of workmen idle. Happily, we now have the welcome news of the shipyard joiners having accepted modified terms in connection with the 12s. per week deduction, against which the joiners have struck for nearly nine months past. There is also strong hope of the proposed reduction of 12½ per cent on the wages of the engineering

trades being accepted shortly. Unless these and other modifications in wages are made, unemployment, which has affected at least 40 per cent of the ship building workers for too long a period already, will be prolonged and aggravated. The new and reconditioning of work that has offered of late has, because of the prevailing state of things, been diverted to other countries, where wages and other conditions are normal and more favorable. Unless British workers can content themselves with less wages there will be less and less work for British ship yards and their closing down will occur, not in single cases only, but in groups.—*The Marine Engineer and Naval Architect*, September, 1921.

THE WHITE STAR "MAJESTIC."—The White Star Line quadruple-screw steamship *Majestic*, 56,000 tons, now nearing completion, will be the largest vessel in the world, and, by reason of the altered economic conditions consequent upon the war, will doubtless be the last word in mercantile shipping for some time to come. A recital of the dimensions of this vast steamer, and a few particulars of her principal features should testify to the outstanding position the *Majestic* will hold in the world's commercial marine when, as is anticipated, she takes her place in the White Star Line's mail and passenger service between Southampton, Cherbourg and New York next spring.

With a length over all of 956 ft., a height from keel to boat deck of 102 ft., and a breadth of over 100 ft., the *Majestic* will have a gross tonnage of about 56,000, and a displacement of 64,000 tons when loaded to her marks. The turbine machinery will develop a maximum of 100,000 horse power, and it is intended that the *Majestic* shall have an ample reserve to steam an average of 23 knots per hour at sea—*Marine Engineer and Naval Architect*, September, 1921.

## JAPAN

SUPER-SUBMARINES.—A sensational story comes from New York about the "giant" submarine which Japan is said to be laying down. The well-known Sulzer firm of Winterthur, Switzerland, which specializes in Diesel-motor manufacture, is reported to have received an order from the Japanese Government for several sets of submarine engines, each set to consist of three or four units developing collectively from 16,000 to 20,000 horsepower. If this news is authentic, it means that the Japanese under-water craft will be larger and faster than any that have been built up to now. The fastest submarines in the world are those of our *K* class, steam-driven on the surface, with a speed of 24 knots, these turbines developing 10,000 horsepower. Next in point of speed, so far as British submarines are concerned, are the *J* boats now in Australia, with Diesel engines of 3600 horsepower, giving a speed of 19 knots. America is building nine "fleet submarines" of large displacement, which are reported to be equipped with motors of 8000 to 10,000 horsepower.

All these figures, however, are cast into the shade by the Diesel installations which Japan is said to have ordered from the Sulzer firm. The Japanese naval authorities are known to have been much impressed with the ex-German submarines that fell to their lot, and there have long been rumors that a Japanese edition of the *U*-cruisers type is building. That submarines of 3000 tons or thereabouts, with a high surface speed, great cruising endurance, and good accommodation for the personnel would be extraordinarily useful for war service in the vast wastes of the Pacific Ocean goes without saying. Even as it is, the Japanese Navy has built submarines of much larger dimensions than those with which they are credited in the naval text-books. Although the latest New York story may not be entirely accurate, it is within the bounds of possibility that the power which owns, for the moment, the largest battleship afloat has decided

to take the lead in introducing submarines designed on the same grandiose scale.—*Naval and Military Record*, 17 August, 1921.

**JAPANESE NAVY'S FUEL SUPPLY SHIP ON WAYS.**—In the presence of a number of Japanese naval officers and officials of the United States Navy, the keel of the fuel supply ship *Kamoi* for the Japanese Navy was laid at the plant of the New York Shipbuilding Corporation at Camden, N. J. Named for a mountain in the province of Hidakia, Japan, meaning "dignity of God," the *Kamoi* will be 500 feet long and have a deadweight tonnage of 13,000 tons. The contract calls for a speed of 15 knots an hour.—*The Nautical Gazette*, 24 September, 1921.

**JAPANESE AIRPORT.**—Japanese aviation authorities, it is announced, are making preparations for the establishment of an aerial port near Tokyo. This port is intended to be the first of many airdromes to be constructed in Japan, Korea, Saghalien, etc. It is to comprise a training ground, landing place, warehouses, customs house, hospital, wireless installations, a signal tower, etc., also equipment for night flying. The fact that this air port will be placed under the control of the Imperial Japanese Aviation Bureau will serve to make it an important military asset in time of war.—*Aviation*, 3 October, 1921.

**PACIFIC STRATEGY.**—Some three weeks ago, before Japan had formally signified her acceptance of the American invitation to confer on the subject of armaments, it was reported from Tokyo that the Imperial Government was then considering a proposal which originated with the Japanese naval authorities, having in view the non-fortification of island zones and a declaration of the freedom of the Pacific. This proposal, the message added, was to be forwarded to Washington with a view to its being placed on the agenda for the conference. As nothing further has been heard of the suggestion up to now, it may have been dropped. In any case it is very unlikely that America would have approved a plan so obviously disadvantageous to herself. The effect of such an agreement would be to deny to the United States the right of providing secure bases for her fleet in the Western Pacific, and would consequently close that area to the American Navy for all practical purposes.—*Naval and Military Record*, 17 August, 1921.

**JAPANESE NAVAL MANEUVERS.**—A fortnight hence will see the Japanese naval maneuvers in full swing. This year's exercises are said to be planned on a larger scale than any which have been held up to now, and will surpass those of October, 1919, as regards the number of ships participating. According to a detailed account just published in the *New York Herald*, the principal maneuver zone will be the Sea of Japan, though the operations will also extend to the open waters of the Pacific. The leading rôle has been assigned to the 1st and 2d fleets, based on Yokosuka and Kure respectively, but the 3d fleet, with its headquarters at Sasebo, will also take part. Irrespective of small craft and auxiliaries, upwards of 40 ships are to be commissioned for the maneuvers. They will include 12 dreadnoughts and battle cruisers, some of the older armored ships, and a large force of light cruisers. Destroyers, submarines, and aircraft will be well represented. The maneuver fleet will be headed by the battleship *Nagato*, flying the flag of Admiral Tochinai.

Early in September the 1st and 2d fleets are to rendezvous at Saiki Bay, in the Bungo Strait, between the islands of Kyushu and Shikoku. For a week or more this combined force will carry out tactical exercises and various practices under the supreme command of Admiral Tochinai. The second phase will begin on September 12, when the force will be split into

two fleets—one representing the Japanese battle fleet and the other an “enemy” squadron bent on forcing its way into the Japan Sea through the Korean and Tsushima Straits. Admiral Shimamura, chief of the naval staff, will probably embark in the *Nagato* to observe the proceedings. The object of the tactical plan is to determine whether the Japanese fleet is strong enough to carry out the dual task of guarding the Pacific coastline from attack and simultaneously holding the approaches to the Sea of Japan. Interest will center mainly round the defence of the Korean and Tsushima Straits, for the problem before the defending fleet is a magnified version of that which confronted the British naval authorities at Dover during the war.

It is true that the islands of Tsushima and Iki, situated midway between the coasts of Korea and Japan, are heavily fortified, and could do much to hinder the passage of enemy surface ships during daylight. But the channel on either side is from 30 to 40 miles wide, so that hostile submarines would have a good chance of getting through unmolested. Nevertheless, the Japanese are endeavoring to make this passage inaccessible to submarines, for they are well aware of the danger that would menace their communications with the mainland were enemy boats able to penetrate into the Sea of Japan. A considerable part of the Japanese air fleet is to be mobilized for the maneuvers, and it is expected that 80 machines will be in service. Two years ago a series of “raids” took place on the principal coast towns, and the object lesson proved so effective that public opinion demanded the speedy reinforcement of the air fleet.

It appears that at the close of each maneuver period the results are investigated by a commission of admirals and staff officers, who award praise or censure in accordance with their findings and permit no personal considerations to influence their judgment. “Efficiency,” says the *Herald*, “is the sole standard by which officers are measured, whether their rank be high or low. The Emperor of Japan never meddles in technical matters. In this he is unlike the ex-German Kaiser, who, although innocent of practical knowledge, never hesitated to pronounce final judgment on the most complex problems of sea strategy.”—*Naval and Military Record*, 31 August, 1921.

**JAPANESE NAVAL POLICY.**—According to the Osaka journal *Mainichi*, the Japanese defence program in the Pacific is steadily advancing towards completion. It involves not merely the expansion of the fleet on the lines of the well-known “eight-eight” scheme, but the building of fortifications and bases at various points that would possess high strategic importance in the case of a naval campaign in the Pacific. During the current year strong batteries have been erected at the Bonin Islands, which are situated some 500 miles south of Yokohama. These islands had hitherto been undefended, and there were no special facilities for the accommodation of warships. A portion of the press criticizes the government for spending money on the fortification of the Bonins, but from the strategical point of view this measure was undoubtedly justified. Had they remained defenceless they would have been liable to seizure by a fleet operating against Japan. The islands have been Japanese territory for 60 years, and would no doubt have been fortified long ago but for the fact that only within comparatively recent times has Japan found it expedient to devote serious attention to her naval frontiers facing the Pacific, instead of contenting herself with the attainment of absolute supremacy in the Sea of Japan, the Yellow Sea, and the East China Sea. The Bonins, it should be noted, are on the direct route between Yokosuka, one of the principal naval bases, and the Mariana Islands, the southernmost island of which is Guam, the only American naval station in the South Seas. Thus Japan, without violating the terms of the mandate under which she occupies the former German islands of the Mariana group, and which inhibits her from putting them to military

use, has nevertheless contrived to establish a strong *point d'appui* within 750 miles of Guam.

Fortifications are also in course of construction on several islands of the Luchu archipelago, which extended between Formosa and the southern coast of Japan (Kyushu). Batteries have been mounted at Amami, Oshima, and Yajima. In view of their geographical position these works must be regarded as purely defensive in character. Miyake Shima, an island off Idzu Province, lying 100 miles due south of Yokosuka, is to be provided with a naval signalling station and an aerodrome. These and similar measures—including the conversion into a second class naval base of Mako, in the Pescadores Channel—reported to be in contemplation, indicate a desire on the part of Japanese strategists to leave undone nothing which is calculated to make Japan and her outlying possessions secure from attack. Foreigners may be at a loss to understand the motive of all these preparations against an invisible enemy, but the Japanese evidently think them necessary or they would not be spending large sums on defensive works at a time when money is notoriously short.

The large flotilla leader *Yukaze* (*Evening Wind*) was launched on May 28 at the Nagasaki yard of the Mitsubishi Co. in the presence of Admiral Takarabe, commander-in-chief of the Sasebo naval station, who named the vessel. Belonging to a group of eight leaders authorized in 1920, the *Yukaze* is a representative of the largest and most powerful type of Japanese torpedo craft. The papers describe her as a "torpedo cruiser" of 2000 tons, 36 knots speed, with an armament of 4.7-inch guns. It is feared that the construction of many warships, from battleships to submarines, now in hand at the Kawasaki and Mitsubishi yard in Kobe will be delayed by the labor troubles that broke out in that city a few weeks ago. Practically all the workmen at both yards downed tools, and their attitude became so threatening that troops and gendarmes were called in to guard warships lying on the stocks and in the fitting-out basins. Naval officers hurriedly despatched from Tokyo made eloquent appeals to the strikers to abstain from committing any act of sabotage against the warships, and these appear to have been successful, for no damage to the vessels is reported.

As a counterblast to Mr. Ozaki's speech-making tour in favor of a reduction of armaments, the Imperial Marine Association—a society formed in 1900 for the promotion of Japanese maritime interests—has decided to embark on an intensive publicity campaign to popularize the navy among all classes of the nation. For this purpose a special naval committee has been appointed, under the presidency of Prince Higashi-Fushimi, with the title of "Kaibo Kyokai" (Naval Defence Association), to arrange lectures and kinema displays on naval subjects, especially in inland districts, where knowledge of the navy and its functions is limited. A fund equivalent to £400,000 has been placed at the disposal of the committee. Part of this sum will be held in reserve to subsidize inventors who are working to improve naval architecture and naval weapons. The movement is obviously receiving official support, for the Navy Department has sent the battleship *Satsuma* from Maidzuru on an "educational" cruise along the coastline fronting the Sea of Japan, and, the papers state, "her chief mission is to diffuse the maritime spirit among the people at the various ports of call." At each port visited the ship is thrown open to the public, and officers specially borne in the vessel deliver lectures at the local schools on Japan's need of sea power.

The first Japanese press comments to hand on the note issued by the foreign office last month (agreeing that "if any situation arises whilst the Anglo-Japanese alliance remains in force in which the procedure prescribed by the terms of the agreement is inconsistent with the procedure prescribed by the Covenant of the League of Nations, then the procedure prescribed by the said covenant shall be adopted and shall prevail over that

prescribed by the agreement") show that in Japan, at any rate, the alliance is already regarded as defunct. The *Mainichi* says it is completely null and void, the *Kokumin* speaks of it as "the ghost alliance," and the *Yorodzu* writes: "From to-morrow the Anglo-Japanese treaty of alliance will practically be a dead letter. In fact, the alliance came to an end with the assistance given by Japan to Britain during the Great War. Though it may formally continue in force for a maximum period of one year, unless it be renewed in the interim, it will be of no effect whatever. Even if it be renewed in future it will be only in such a form as may accrue solely to the benefit of the Anglo-Saxon race. In any case, the whole world is falling under the sway of that race." Language of greater warmth than this is used by other journals, whose indignation at the supposed annulment of the alliance is strangely in contrast to the views they expressed at the height of the war, when they spoke of it as obsolete, and even recommended its substitution by a German-Japanese compact.—*Naval and Military Record*, 7 September, 1921.

**JAPAN'S ATTITUDE.**—Having notified her willingness to take part in the Washington Conference on the limitation of international armaments, Japan is now reviewing her naval position and naval needs. She is measuring her strength against the United States and Great Britain with perfect frankness and impartiality, obviously for the reason that these are the only two sea powers to be reckoned with in the Pacific. And the conclusion to which the Japanese Admiralty are reported to have come is that a proportion of two ships to the American three and the British four would be a perfectly adequate provision. These calculations are arrived at on the basis of distances. The United States seaboard is some 5000 miles away from Japan, and hostile operations by the United States would necessitate the employment of at least this ratio of superior numbers to stand any chance of success.

The one qualifying possibility in this computation which is very much exercising the minds of Japanese naval administrators is the development of Guam and Manila into first-class naval bases. Such a step would obviously profoundly affect the strategic situation, and Japan makes no secret of the fact that the question will have to be satisfactorily resolved at the Washington Conference. We cannot find anything unreasonable in this view, for the fortifying of these two geographically important spots could only have reference to Japan as an objective. Flanking the great eastern highway as they do, the matter is likewise not one of indifference to this country. The practical response to such a policy would be the corresponding development of Singapore, and it is because Japan clearly realizes this that she takes British naval potentialities into her calculations.

Presuming that the United States were to persist in the expansion of Guam and Manila into great naval bases, Japan declares that her security would demand a fleet at least as large as that of America. But, having laid down this proposition, she candidly admits that it would involve an intolerable financial commitment. A capital ship of the latest type cannot be built in a Japanese yard for less than £8,000,000.

A program of competition with the United States Navy would therefore be ruinous, for we may certainly assume that America would promptly take up such a challenge and increase her shipbuilding accordingly. In both countries the position is clearly realized, and the burthen of obligations will undoubtedly form the great determining influence at the Washington Conference. The real negotiators, indeed, are America and Japan. If they can agree it will be a comparatively simple matter for us to harmonize our own policy with their decision. And we believe that they will agree, if for no more lofty reason than that neither can afford the colossal expenditure which would be imposed by the alternative.—*Naval and Military Record*, 14 September, 1921.

**RAZING OF FORTS TALKED OF.**—Japan will consult with other members of the League of Nations relative to the desire of the United States to receive equal treatment in mandate islands of the Pacific as a feature of the settlement of the Yap question, it is said by newspapers here. Japan will also study the American claim to land ownership in Yap, as foreigners do not have the right to land ownership in Japanese territory.

It is estimated that this country's expenses at the Washington Conference on limitation of armaments and Far Eastern questions will be about \$2,000,000. Government leaders believe the conference will be in session for two months.

It has been decided that the chief of the Japanese delegation shall sail for the United States on board the steamer *Kashima Maru* on October 15. This steamer will take to America a number of Japanese business men, who will proceed to England after visiting the United States for two months.

It is believed that Japan is awaiting information regarding the character of the British and French delegations before finally deciding on the man who will act as chief at the Washington Conference. H. Ijuin, former Ambassador to Italy, has been suggested as one of the men who might be chosen chief, while there are reports that Premier Hara is attempting to induce Viscount Chinda, former Ambassador to the United States and to England, to accept the post.

Another meeting of Japanese field marshals and the Supreme War Councilors has been held, and the *Yomiuri Shimbun* says that the army's attitude on the limitation of armaments is as follows:

"Japan will maintain her already settled principle of national defense, and no change or alteration will be made until the time arrives when international disputes and trouble can be settled without relying upon, or resorting to, armed force. This is because of Japan's particular national status, and the situation which exists in surrounding the states."

This would indicate a change from the previously announced decision of Japan, which supported, in principle, the maintenance of 21 army divisions. It would seem she would be disposed to follow other nations in actual reductions.

Leading newspapers declare that it is the intention of army and navy authorities to propose definitely the reduction or abolition of fortifications in the Hawaiian Islands, the Philippines and Guam in exchange for the dismantling of Japanese fortifications on Formosa and the Pescadores Islands, and at Port Arthur and Bonin. Confirmation of this report, however, cannot be secured, but the opinion is general that this proposal may prove one of the principal points of the Japanese proposals.

"Perhaps the idea of dismantling fortifications in the Pacific," said an authority yesterday, "is a hope rather than an expectation. Certainly the making of a fortress out of Guam, which is near Japan, might be considered a theoretical menace in the same sense that America would look upon a British fortress in Jamaica in the same light."—*New York Times*, 25 September, 1921.

**JAPANESE SHIPYARDS INACTIVE.**—Indicative of the continued depression in the shipbuilding industry of Japan, Trade Commissioner H. A. Butts states that during the month of June only two ships were launched in the Osaka district, one of 2600 tons and one of 114 tons. Three vessels were completed one of 2560 tons, one of 969, and one of 99 tons. Out of 45 shipyards, 28 have gone out of business, the remaining 17 maintaining operations with difficulty.—*Nautical Gazette*.



## UNITED STATES

## NAVY DEPARTMENT—BUREAU OF CONSTRUCTION AND REPAIR

VESSELS UNDER CONSTRUCTION, UNITED STATES NAVY—DEGREE OF COMPLETION,  
AS REPORTED SEPTEMBER 30, 1921

Type, number and name	Contractor	Per cent of completion			
		Oct. 1, 1921		Sept. 1, 1921	
		Total	On ship	Total	On ship
<b>Battleships (BB)</b>					
45 Colorado.....	New York S. B. Cpn.....	80.7	79.2	78.4	76.8
*47 Washington.....	New York S. B. Cpn.....	69.7	63.5	69.3	63.
48 West Virginia.....	Newport News S. B. & D. D. Co.	62.5	55.5	61.	53.4
49 South Dakota.....	New York Navy Yard.....	34.6	27.	34.1	26.5
50 Indiana.....	New York Navy Yard.....	32.5	24.3	31.2	24.
51 Montana.....	Mare Island Navy Yard.....	27.6	19.	27.3	19.
52 North Carolina.....	Norfolk Navy Yard.....	36.6	27.1	36.5	27.1
53 Iowa.....	Newport News S. B. & D. D. Co.	29.5	25.	29.	24.8
54 Massachusetts.....	Beth. S. B. Cpn. (Fore River)..	10.4	3.9	10.4	3.9
<b>Battle Cruisers (CC)</b>					
1 Lexington.....	Beth. S. B. Cpn. (Fore River)..	25.5	16.5	24.2	15.
2 Constellation.....	Newport News S. B. & D. D. Co.	14.5	12.6	13.3	11.1
3 Saratoga.....	New York S. B. Cpn.....	28.4	20.	27.4	18.7
4 Ranger.....	Newport News S. B. & D. D. Co.	2.7	1.1	2.5	1.
5 Constitution.....	Philadelphia Navy Yard.....	11.1	6.3	10.7	6.
6 United States.....	Philadelphia Navy Yard.....	10.7	5.9	10.4	5.7
<b>Scout Cruisers (Light Cruisers CL)</b>					
4 Omaha.....	Todd D. D. & Const. Cpn.....	94.7	87.9	94.6	87.2
5 Milwaukee.....	Todd D. D. & Const. Cpn.....	92.5	84.6	92.4	84.
6 Cincinnati.....	Todd D. D. & Const. Cpn.....	87.4	80.8	87.1	79.5
7 Raleigh.....	Beth. S. B. Cpn. (Fore River)..	63.7	45.6	63.7	45.6
8 Detroit.....	Beth. S. B. Cpn. (Fore River)..	68.5	50.6	66.3	48.2
10 Richmond.....	Wm. Cramp & Sons Co.....	74.	64.	70.	59.
10 Concord.....	Wm. Cramp & Sons Co.....	68.	53.	66.	49.
11 Trenton.....	Wm. Cramp & Sons Co.....	51.	35.	50.	34.
12 Marblehead.....	Wm. Cramp & Sons Co.....	46.	30.	46.	30.
13 Memphis.....	Wm. Cramp & Sons Co.....	40.	25.	40.	25.
<b>Auxiliaries</b>					
Repair Ship No. 1, Medusa (AR 1).....	Puget Sound Navy Yard.....	69.3	53.9	68.	51.2
Dest. Tender No. 3, Dobbin (AD 3).....	Philadelphia Navy Yard.....	56.3	66.	66.3	66.
Dest. Tender No. 4, Whitney (AD 4).....	Boston Navy Yard.....	34.9	31.1	32.8	28.1
Sub. Tender No. 3, Holland (AS 3).....	Puget Sound Navy Yard.....	21.5	5.5	21.6	5.5
Aircraft Tender, Wright (AZ 1).....	Tietjen & Lang.....	92.	.....	90.	.....
<b>Patrol Vessels</b>					
Gunboat No. 22, Tulsa (PG 22).....	Charleston Navy Yard.....	70.8	54.5	70.6	53.4
<b>Destroyers</b>					
338 Wasmuth.....	Mare Island Navy Yard.....	99.5	99.5	99.2	99.2
339 Trever.....	Mare Island Navy Yard.....	97.5	97.5	97.3	97.3
340 Perry.....	Mare Island Navy Yard.....	76.3	74.5	71.6	70.7
341 Decatur.....	Mare Island Navy Yard.....	75.2	69.4	65.4	64.5

\* Battleship No. 47, Washington, launched Sept. 1, 1921.

† Previously reported 31.2.

‡ Scout (Light) Cruiser No. 9, Richmond, launched Sept. 29, 1921.

Authorized but not under construction or contract: (1) Transport No. 2.

Destroyers authorized but not under construction or contract: (12) Nos. 348 to 359 inclusive.

**OUR DEPLORABLE POSITION IN THE WESTERN PACIFIC.**—Maritime nations have always been rivals for sea trade, just as the merchants in any town are rivals for the trade of that town. In every town there are laws which govern precisely the relations between the merchants, there are courts to which merchants may appeal in case of bad treatment by other merchants, and there is a police force to compel obedience to the decision of the courts; but on the sea there are no laws, no courts and no police force to insure fair dealing among nations. For this reason each nation has to maintain its own armed force to guard its rights.

This does not mean that all nations are enemies of each other any more than it means that all merchants are enemies of each other. The rivalries of nations and of merchants are usually of a friendly character; for in both international relations and mercantile relations it is realized that war and strife are losing procedures in the main. For this reason many measures are taken to foresee and control the causes of war and strife.

One of the measures taken is to remove temptation to robbery and theft, by guarding possessions: *for an unguarded possession presents a distinct temptation to a rival.* Therefore, no nation regards the arming of a colonial possession as an evidence of unfriendliness or distrust, any more than a merchant regards an insistence on suitable guarantees as an evidence of unfriendliness or distrust. The closest friends and even relatives observe business methods in their business dealings with each other; rightfully regarding such observance as a necessary precaution against possible misunderstandings, and therefore as an insurance against a possible rupture of friendliness. Any man who would disregard such precautions would put himself in the power of other men and be regarded as a fool.

Yet this is exactly what the United States has done in the West Pacific by failing to defend the Philippine Islands. By so failing, we have put ourselves in the power of our good friend, Japan, by making it possible for her to capture them with very little effort and to prevent our recapturing them, except at the cost of an effort that we may not be strong enough to make.

It has been said that Japan does not want the Philippine Islands: that she prefers to expand on the mainland of Asia. This may be true; but it may be pointed out that the Philippine Islands cover more than two-thirds as much area of land as Japan does; that they cover more than twice as much area as the state of New York; that they are vastly richer in natural resources than either Japan or New York; that they lie as conveniently near to China as Japan does; that their harbors are fully as good as those of Japan; and that, if properly defended and developed, they will form a better commercial base than Japan itself for prosecuting trade with China, and for building the railroads and doing the other kinds of public work that have already been begun.

Furthermore, even if Japan should not want the islands for herself, it is inconceivable that she likes to see us there, because the Philippines flank Japan's lines of communication not only to Guam, but to Yap and her other newly acquired Pacific islands, and even to the Mediterranean. Japanese steamers stop at Philippine ports while going to and from the Mediterranean.

Since it has always been the custom for great nations to defend their insular possessions, and since it seems distinctly advisable for us to defend the Philippines, it may be asked why we have not defended them. There are two reasons:

1. The American people have never realized the practical value, both commercially and strategically, of the Philippines, and have been misled by the phrase "give the Filipinos their independence." The word "independence" has an effect on an American that is amazingly appealing; he will instinctively agree to almost any proposition granting "independence" to almost anybody. For this reason the American people were slow in deciding to retain the islands after Dewey captured them, and Congress

adopted a resolution virtually declaring the intention of the United States to give the Filipinos their "independence."

Now this looks superficially like a fairly good reason for not defending the islands. In fact, it seems to be regarded by some people as virtually obliging the United States to present the islands to the Filipinos, and to constitute an actual bargain with them. But really it does neither; for the reason that it was a mere statement of an intention held long ago, at a time when the importance of the Philippines was not understood, and when it was not realized that to hold the Philippines undefended made them actual hostages in the hands of Japan and put us in her power. Such, however, seems to be the fact, because both nations know that the ability of Japan to capture the islands enables her to hold a constant threat over our head; both nations realizing that, if the Japanese should capture them, public opinion would force us to try to recapture them, that the cost of the attempt would be prodigious, and that the attempt might not be successful. Remember that we have no base except in the islands, that the Japanese might adopt Fabian tactics, and remember also the fate of Hannibal in Italy after Fabius refused to fight.

2. The other reason for not defending the Philippines is that it has been deemed impossible to defend them, except at a cost in money wholly prohibitory. But, as I pointed out to the General Board of the Navy in the winter of 1910-1911, and have continually reiterated since, it is perfectly possible to defend them at small cost if we will only take advantage of the power that the airplane put into our hands several years ago. The airplane gave us the power to prevent troops from actually invading the islands, by dropping bombs on them before they could reach the shore.

Remember that any transports carrying troops destined to invade the Philippines would have to anchor at some distance from the beach selected as a landing place. Remember that the boats would then have to be gotten out and lowered into the water and placed alongside the transports at designated spots; that then all the men, ammunition, supplies, equipments and artillery would have to be placed carefully in the boats; and that then those boats (small, open boats) would have to be towed to the shore, crammed full of their living and unliving freight. Remember, too, that during every instant of the procedure thus briefly sketched, the transports, boats and men would be helpless against bombing airplanes, and that those planes could drop so many bombs on the boats that it would seem no boat could escape being hit; for the bombs need not be more than a pound in weight, and *each plane could carry hundreds of bombs*. The escorting ships could not even fire at the airplanes, because they would be more apt to hit their own boats than to hit the airplanes.

But even granting that the boats could reach the beach (it seems more than doubtful that even one boat could do so), how could the troops possibly land on the beach, get out from the boats all of their supplies, equipments, munitions and artillery, and then form and march over the long rough road to Manila if attacked persistently with bombing airplanes?

It may be objected that the enemy might bring airplanes and use them against the bombing airplanes. True, but airplanes operated from the stable and commodious conditions of the land and of the quiet little bays abounding in the Philippines could be launched in much greater numbers and much more quickly than from the crowded and unstable conditions of shipboard.

It may also be objected that pursuit planes could be sent from Formosa. True, but the southernmost tip of Formosa is two hundred miles from the northernmost tip of Luzon, and three hundred miles from any good landing beach. Now, three hundred miles is a great handicap to pursuit planes.

It may also be objected that no planes might be in readiness to bomb the would-be invaders when they arrived. This is possible, of course, on the general theory that almost anything is possible. But the great speed

of airplanes, combined with the facilities given by the radio telegraph, endows airplanes engaged against relatively slowly moving bodies, such as ships and soldiers, with a degree of *concentratability* hitherto unknown. By means of this concentratability and the help of scouting airplanes the probability seems to be almost one hundred per cent that no transports could land troops in Luzon before airplanes could reach the landing beach.

It may also be objected that Japan might use bombing airplanes instead of troops, or in co-operation with troops, to bomb out the present defenses of the Philippines, and then to bomb Manila itself, and thus force it to surrender. This is true, but it is respectfully suggested that this fact, instead of constituting an argument against defending the Philippines with airplanes, constitutes an unanswerable argument in favor of it, because the best defense against airplanes is airplanes.

It is a matter of frequent remark that the three countries most deeply interested in the coming Conference are the United States, Great Britain and Japan. Now these countries are great friends, and in some ways their interests are identical and a continuance of friendly relations a great desirability. Yet the fact stares us in the face that *the most fortunate thing commercially for any one of those countries would be that the other two should go to war against each other*, because such a war would make her the mistress of the commerce of the world. If we and Japan, for instance, should go to war, and Japan should take the Philippines, our national resources would be strained so much and for so long a time that it seems probable that Great Britain would soon resume her place as mistress of the sea. What would happen to the United States cannot clearly be foreseen.

Doubtless "everything will come out all right," but one may feel justified, nevertheless, in regretting that our weakness in the Philippines should have been permitted to exist for so many years, and to continue to the present crisis. No harm is done by alluding to it publicly, because it is *perfectly understood by foreign nations*; in fact, Mr. Bywater devotes many pages to making it clear in his recent book, "Sea Power in the Pacific," and expresses surprise that America does not seem to realize it.—*Army and Navy Journal*, 21 September, 1921.

**AIR CRAFT VS. SURFACE VESSELS AND SUBMARINES.**—The bombing by the army and navy aviation services of the enemy and obsolete surface and submarine vessels really proved only what was already known; that is, that what man has made he can unmake. As practice such tests are useful; as demonstrations of what will happen in war all firing at targets—of course the tests were nothing more—are unreliable, because the retaliation, and what is just as important, the fear of retaliation, cannot be simulated.

Before the tests anybody could be sure that if the airships kept on dropping more and more high explosives on the vessels, the vessels would ultimately be sunk. Everybody who had read and thought about the matter knew that aircraft nowadays is an essential weapon of offense and defense in naval warfare, but nothing in the bombing tests has proved that any class of surface or submarine vessels is obsolete because of the dangers from attack by aircraft. The tests did illustrate, of course, that if large quantities of high explosives are likely to be dropped on the decks of vessels or in the water near them, it is desirable that the vessels be constructed with reference to giving as much protection as possible against such attack.

Everybody knows that no protection is absolute and that there is no more reason to suppose that absolute protection can be given against aircraft attack any more than it can be given against gunfire from surface vessels. In war people are likely to get hurt and we must not discuss war from the point of view of the German-American citizen who sat on a coroner's inquest listening very intently to the evidence, the corpse lying before them under a sheet. Finally, in a pause in the proceedings he arose, lifted a corner

of the sheet and glancing at the dead face turned and said in a tone of horror to the coroner and his fellow jurymen, "My God, gentlemen, dis man vas dead."

In future wars vessels will be destroyed and the crews killed just as they have been for some thousands of years in past wars. Machine guns will kill infantrymen—millions were so killed in this way during the World War, but nevertheless infantry is not obsolete. The infantry minimizes its casualties by lying down, crawling around or attacking the machine guns with mortars and artillery. What is true of men is true of the matériel, both on land and sea. The fact that in a naval battle many ships are destroyed, does not mean that it is useless to build ships. The victor may lose most of the ships but if the vanquished has lost all of his the fruits of victory are adequate to the losses.

Let us not be carried away or become hysterical and go to one extreme or the other. During the war there was a constant cry that the old methods were obsolete and the training must be wholly for trench warfare. General Pershing was not carried away, but insisted on our troops being trained for open warfare, and it turned out to be one of the wisest decisions that was made in our behalf during the war. The truth is that no class of surface and submarine vessels is obsolete and that in any future wars the auxiliaries, that is the submarine and the lighter vessels of the enemy will have to be neutralized by our auxiliaries and the heavy fighting done by the line battleships—the infantry of the sea—as it always has been. What is and always has been obsolete is an unbalanced fleet. We have never had a balanced fleet and the sooner we recognize this fact the better. If we are willing to trust to agreements and the gentleness of human nature, then we do not want a fleet. But if we are not, and we think that war is a possibility, then it is the height of folly not to have a *balanced* fleet that is adequate to conquer any enemy we may have to fight.

Heavily taxing the people to build and maintain an unprepared or unbalanced fleet is a useless extravagance.—*National Service*, October, 1921.

AMERICAN NAVAL PROGRESS.—The launch of the battleship *Washington* at Camden, N. J., on September 1, means that three of the ten 16-in. battleships authorized under the building program of 1916 are now in the water. The others are the *Maryland*, launched on March 20, 1920, and the *Colorado*, launched at Camden on March 22, 1921. These ships are all to carry eight 16-in. guns in their main armament, and so will the *West Virginia*, which is rather behind them in point of progress, having only been laid down in April of last year. The other six battleships, however, of the *South Dakota* type, are larger and more powerful, with a main armament of twelve 16-in. guns. No date has yet been mentioned for their being put afloat, but it was stated by Mr. Amery in his speech on the shipbuilding vote in the House of Commons on August 3 that they would be completed by the end of 1924 or the beginning of 1925. In other words, they will be ready no sooner than the four British capital ships which are about to be ordered to replace some of those scrapped since the armistice. These new British ships are expected to occupy three years in construction from the date of the signing of the contract. It cannot be assumed, of course, that there is any sort of competition between the two countries in this respect. If there was, it would be necessary for us to be laying down something like sixteen big ships this year instead of four, since we have only the *Hood* as a post-Jutland ship to put against those laid down by America since 1917, and even the *Hood* has only 15-in. guns. However, there will be much mutual interest displayed in both countries in each other's designs. One thing which the progress of the new American ships does emphasize is the expansion of the resources for the construction of war vessels and the manufacture of naval war material in the United States.

It is understood that there is a minimum of fifteen slips capable of taking the largest ship yet contemplated. Now that our own public yards have unfortunately been left behind owing to the events of the war, so that none of them possess a slip capable of taking such a ship as the *Hood*, it would be interesting to know exactly how the private yards stand in this respect. We should rather doubt whether they have as many as fifteen slips; on the other hand, the official period of three years from the contract date shows that it is anticipated that they will be capable of more rapid construction than has hitherto been achieved with the new American ships.—*Army and Navy Gazette*, 17 September, 1921.

**SINKING OF "U. S. S. R-6."**—The U. S. submarine R-6, in command of Lieut. I. R. Chambers, U. S. N., sank at 9.15 p. m., September 26, while alongside the U. S. S. *Camden*, her tender, in San Pedro Harbor, Calif. The following men are reported drowned: Frank Amzi Spalsbury, electrician, 2d class; next of kin, mother, Mrs. Bessie A. Spalsbury, Box 123 Powers Lake, N. D.; John Edward Dresfein, seaman, 2d class; next of kin, sister, Mrs. Minnie Strait, Moline, Ill.

The accident, according to official dispatches received at the Navy Department from Vice Admiral W. R. Shoemaker, U. S. N., commanding the battleship force of the U. S. S. Pacific fleet, was caused by an outboard shutter of a torpedo tube being left open. This caused the opening of the inner tube door, as the interlocking device failed to work. Besides Lieutenant Chambers, the ship's company consisted of Lieuts. S. D. Jupp and J. M. Steele, and twenty-seven enlisted men. Operations to raise the submarine were at once ordered, and as her conning tower was reported to be only six feet under water, it is expected that she can be easily raised. The R-6 is a first line submarine, launched March 1, 1919, and she was commissioned May 1, 1919.—*Army and Navy Journal*, 1 October, 1921.

**BARS USE OF SAILORS AS "STOOL PIGEONS."**—Secretary of the Navy Denby does not purpose to permit the use of sailors as police "stool pigeons" or the use of the navy uniform in fighting vice in coast cities. He made this plain by denouncing the alleged employment of sailors as "stool pigeons" by the San Diego (Cal.) police.

His denunciation echoes the sensational disclosures of the alleged use of enlisted men of the navy as "stool pigeons" to stamp out vice at Newport, R. I. A formal statement said, in part:

"Attention of the Navy Department has been directed to evidence given in a trial at San Diego, Cal., in which it was stated that sailors of the navy had been used as 'stool pigeons' by the police. Secretary Denby, on reviewing the published reports of such action, sent a dispatch to the commander-in-chief of the Pacific fleet, Admiral Eberle, expressing the department's determined stand against the use of enlisted men for this purpose and calling attention to the navy's written instructions regarding the extent of co-operation with the civil authorities and directing the commander-in-chief to make a personal and thorough investigation of the matter.

"The statement, as reported, was made at San Diego, at the hearing of Police Judge Ed. L. Davis, under grand jury indictment for misconduct in office. In his defense Judge Davis, in referring to a case where a woman charged with having agreed to relations with two sailors who, it is claimed, were used as 'stool pigeons,' is quoted as saying.

"I was told that the sailors had been given marked money to give to the woman, and that policemen broke into the room at a prearranged time. It struck me as horrible that boys away from home in training for citizenship, both morally and physically, should be hired for such despicable work. I considered it the duty of the court to discourage such practice and that is why I dismissed the case."

"In regard to vice conditions in San Pedro, the Secretary on June 9 sent the following letter to the commandant of the eleventh naval district:

"The department does not desire that the commandant handle the vice conditions that may exist in the eleventh naval district in the manner described in his letter, and accordingly directs that F. W. Becker, enrolled as a lieutenant, United States Naval Reserve Force, be not employed as recommended."

"The department desires that the commandant co-operate with the civil authorities for the suppression of vice, as it affects the naval personnel. The primary responsibility for social conditions within any community rests on the civil government, and the department does not desire that the personnel of the naval service, the uniform of the naval service or persons employed by the navy be utilized for services that properly belong to the civil police."

"At the same time Secretary Denby wrote to Meredith P. Snyder, Mayor of Los Angeles, disapproving recommendations made by the Los Angeles Chief of Police that members of the police force of that city be permitted to wear the uniform of the navy or the marine corps in the discharge of their duty."—*Baltimore Evening Sun*, 23 September, 1921.

HARDING APPROVES NAVY YARD ECONOMY.—President Harding will not intervene in behalf of the 50,000 civilian employes of navy yards whose wages recently have been reduced by the Navy Wage Board. The judgment of the board and Secretary Denby, it was learned authoritatively to-day, will be final, and the wage cuts are in line with the administration's policy of getting back to normal.

Numerous protests of the reductions, which became effective September 16 in all the navy yards of the country, have been presented to the President by representatives of the men and union leaders in an effort to force a reopening of the award. Although the President has made no formal review of the findings, he is understood to approve generally. Secretary Denby was positive to-day in his assertion that the award will not be reviewed.

"The matter is a closed incident," said Secretary Denby. "The cut is made already, is in effect and is going to continue."

The administration has little patience with the criticism of the governmental policy which does not keep all the navy shops and plants in full operation at the present time. The President and his advisers regard as absurd the view that wartime activity should be maintained in navy yards, even if present appropriations would permit of such a course. Curtailment both in the activities of the navy yard plants and in the payrolls, is the definite program to be followed to eliminate the abnormal conditions which grew up during the war.—*Philadelphia Public Ledger*, 23 September, 1921.

SHIPPING BOARD IS RAPIDLY WHIPPING BAREBOAT CHARTER PLAN INTO SHAPE.—The bareboat-charter plan for the disposition of the Government fleet is now rapidly taking form under the three operating vice-presidents, and will be put into effect with a modified allocation system. The main points of the changes in policy which the Board will adopt have now become public. Under this scheme the government vessels will be continued in operation until fundamental conditions in shipping have been reversed and the vessels can be sold.

While the final form of the charter party has not yet been drafted, indications during the week are that this will contain the following provisions:

1. The Shipping Board will bear the expense of hull and machinery insurance.
2. The charterer will pay voyage repairs.
3. The Shipping Board will pay for repairs made necessary by latent defects in construction.
4. The charterer will assume the cost of protective and indemnity insurance.

5. The charter rate per deadweight ton will probably not be more than fifty cents per month, and will vary according to the conditions on separate routes.

Several vessels have already been chartered by the Board on substantially these terms, and while officials deny that the plan is in final shape there is good reason to believe that the public announcement in the near future will show these cardinal features of the charter party. The Board is now getting the views of steamship owners and operators on the proposition and will consider their opinions in drafting the plan. The original purpose of Chairman Lasker to make the bareboat charter system operative at once, with full abandonment of the allocation policy, has been modified considerably within the last few weeks. It is evident at present that this will be only one feature of a more comprehensive policy which will also include a certain amount of support for the steamship operators.

A study of the Merchant Marine Act has convinced the commissioners that the Board must continue certain strategic services regardless of the expense. Chairman Lasker has stated definitely that the law will be observed. This means that on trade routes which hold out immediate prospects for profitable operation, the Board will charter vessels under the new plan. But on the other services where traffic is poor and a constant loss is shown, the Board will continue temporarily to operate a minimum number of vessels on the existing commission basis. According to the intentions of the Board at present indicated, the bareboat charter system will be in force from certain ports from certain routes, while on others the allocation plan will be undisturbed.

In making the decision not to eliminate the allocation of ships entirely, the Board has taken drastic measures to cut the losses of operation to a minimum and to avoid competition between government vessels. Where two or three steamship lines are running on the same berth, with insufficient traffic and constant loss, the Board will concentrate the ships in the hands of one or two companies, and will continue in service only enough tonnage to care for the trade on a regular sailing schedule. In carrying out this plan Chairman Lasker expects by the middle of October to have not more than 350 ships in operation, or approximately one-fourth of the government fleet. These will be the best constructed and most efficient of the war-time fleet and will be retained by the Board as the foundation upon which to build up an American merchant marine. It is the belief of the chairman that the operating losses by this means can be kept down to \$5,000,000 a month, or eliminated entirely if trade conditions improve or the Jones Law is made fully effective.

The Board has already begun to put its new policy into effect. Within the last week announcement has been made that the Pacific Steamship Co. has chartered two ships for the movement of grain in bulk from the Pacific Coast to Europe. The action of the Admiral Line in chartering these vessels has discounted the arguments presented to the Shipping Board that it would be almost impossible just now to place ships on the charter basis.

In fixing the charter hire, which in the case of the Admiral Line was 50 cents per deadweight ton per month, the Board will consider the condition of trade, the amount of competition and the financial ability of the companies. It is expected that in some instances the rate will be nominal, only one or two cents a ton, while in others the Board may actually offer to pay the protective and indemnity insurance or voyage repairs to compensate certain companies for the charter hire. The Board will make the most favorable terms possible to get its ships under charter and to avoid the continuance of the allocation plan.

The Shipping Board Claims Commission is now actively at work, and within the last week has disposed of eight cases in which the attorneys for the Board and the claimants reached an undisputed agreement. All of these were for amounts less than \$2000 each. As a general policy, the Commission has announced that it will have its own examiners investigate



each of these negotiated settlements, partly as a precaution and also as a protection to the attorneys for the Board, whose firms in many instances are representing claimants.

As fast as the Board notifies the Commission that it is ready to proceed with certain cases the latter will schedule a hearing. The claim of the Downey Shipbuilding Corporation, involving \$4,000,000, will come up shortly.—*Nautical Gazette*, 1 October, 1921.

### AERONAUTICS

WHAT THE VIRGINIA CAPES AIRCRAFT BOMBING TESTS SHOW.—The conflict between the air bombing squadron and the ex-German battleship *Ostfriesland* off the Virginia Capes was an epoch-making incident in the ever-present conflict between the old and well-established and the new and untried. The new device proved successful and indicated a future.

When the United States entered the world war in 1917 it did not possess a single military flying machine, and of the two score training planes then owned by the army and navy there were barely a baker's dozen capable of an hour's flight. Not quite four years have elapsed between the foundation of American military aeronautics and the sending out of the unprotected David of the air with a few bombs to do battle with the Goliath of the sea protected with armament representing forty years of sustained development costing billions of dollars. The battleship went to the bottom of the ocean in less than twenty-five minutes. Still the aircraft engineers responsible for this remarkable performance thoroughly realize the crudeness of the airplane, especially as regards the sighting, aiming and bomb-dropping devices.

The battleship can be made larger and faster, but this will not make it less vulnerable to aerial attack. The airplane, however, is only at the threshold of its development. The question seems to be one of time when the battleship will be driven from the sea.

American engineers have particular reasons to glory in the success of our flyers. The planes used were chiefly of American design, driven by a typical American motor. The bold conception of the test was on a par with the big things done every day by our engineers, and the daring of the men who flew for over a hundred miles out to sea in planes which had no facilities for landing on the water is something of which the nation may well feel proud.

Great honor must be given to the persistent and marvelous organization of the Air Service, which carried this difficult task to such successful completion. This is due in large measure to the enthusiasm and leadership of General Mitchell and his extremely able corps of assistants. Colonel Bane, chief of the Engineering Division of the Air Service, is another who should receive no small amount of praise and congratulations.

From my experience in connection with the production of the first depth bomb for the navy, I am convinced that it is the only device capable of reaching the vulnerable parts of a battleship. The enormous sledgehammer blow that is delivered to the ship's structure by a depth bomb at a distance is something prodigious. The compressibility of water being only 1/150 at the pressure of one ton per square inch, it acts to all intents and purposes as a perfect solid in transmitting the enormous concussion. Mass action is the secret of the success of the depth bomb, as is shown in the following formula:

$$P = \frac{0.68 WK}{D^{1.55}}$$

where  $P$  is the effective pressure in tons per square inch against the target from the depth bomb;  $D$  the distance from the center of the charge to the face of the target, in feet;  $K$  the coefficient, which for the TNT equals 3.17; and  $W$  the weight of the charge in pounds,

In early bombing days, from the heights to which anti-aircraft guns drove the aircraft it was lucky if the bomb was able to hit the township containing the target. The precision obtained since that time in the various elements of the bombing equipment is due in no small measure to the astute, practical mathematician, the man who is 100 per cent mathematician and also 100 per cent engineer, in being able to point out a practical and physical, as well as simple, solution of otherwise very perplexing and abstruse formulas. This, together with the new method of stabilizing, finding and being able to hold the exact vertical reference line, and precision flight due to great care on the part of the pilot, are all important elements, but in the last analysis the level head and horse sense of the "man behind the gun" constitute no small part of the answer.

So aircraft, which is the natural American heritage, is coming not only into its own, but assuming nothing short of sovereign leadership in direct offensive action, and it has remained for America again to lead the way.

There are many defensive actions in which aeronautics will from now on take prominent leadership, and all are based on the most highly organized engineering analysis and skill. I, therefore, recommend that our Aeronautic Division make a close study of these intensely interesting activities so as to be in readiness to extend first aid in this all-important development.—*Mechanical Engineering*, September, 1921.

**BENDING STRENGTH OF "ZR-2."**—If ZR-2 buckled while she was making a sharp turn at high speed—and more than one witness has testified that she did—she was the victim of a lack of girder strength which is inherent in all airships of the rigid type. By this we do not mean to say that all dirigibles are weak to the point of danger, but we do wish to emphasize the fact that the frame of a dirigible is so constructed that it cannot be considered as a trussed beam, and therefore its great diameter or depth cannot, as in the case of a bridge truss, be taken as a measure of its bending strength.

This inherent weakness is due to the fact that the presence of the huge gas bags prevents the introduction of any longitudinal, diagonal ties across each section or panel. To use these it would be necessary to provide gas-tight tubes passing diagonally through the gas bags—an obviously impossible construction. An attempt is made to provide longitudinal strength by bracing and tying together the longitudinal girders and the exterior polygonal frames, so as to secure something of the stiffness of the shell of a tube; but the whole construction, to the eye of an engineer, looks extremely frail when it is applied, as in this case, to a structure that is eighty-five feet in diameter and some 700 feet in length.

There is, of course, an interior truss running along the bottom of the framework—a triangular truss of great strength and stiffness—but it is shallow as compared with the vast skeleton frame along the bottom of which it lies. When the heavy cross-bending strain, induced by setting the rudders hard over when the ship was running at high speed developed, stresses of compression and tension were set up in the frame of the ship, which the relatively small triangular truss below could not do very much to relieve.

In making the above suggestion we do not wish to throw any doubt upon the practicability of lighter-than-air navigation. Faults either of design, material, or handling existed in the ill-fated ZR-2; but this does not prove that dirigibles of the great size of this one cannot be built of sufficient strength to stand any of the reasonable mischances of the air. Now that the wreck is being salvaged and the log of the commander of the ship has been recovered, we shall probably learn in due course just where the break occurred and why. Every new art has its failures and alas, its disasters accompanied by large loss of life; but the art goes forward. We are among those who believe that the day may come when gas bags can be eliminated and the whole body of the ship sheathed with some light

allow so that it can serve as the container. The all-metal dirigible, for reasons of strength and safety, is as desirable as the all-metal airplane.—*Scientific American*, 10 September, 1921.

THE AMERICAN AIR TESTS.—The American naval authorities have no use for theatrical secrecy, and they pride themselves, with reason, on laying all their cards on the table. When, for instance, any particularly interesting experiment is to be carried out, such as the bombardment of an old battleship by gunfire or air bombs, they always invite newspaper men to attend, and even provide special facilities for the "chiefs" who are "takin' notes." They adopted this method on the occasion of the recent bombing practice against ex-German warships, with the result that very complete accounts of the event have been published for all the world to read. In our view this policy of frankness is infinitely to be preferred, from every point of view, to one of secrecy and mystification, and we venture to congratulate the American naval chiefs on having adopted it—not merely in this particular respects, but equally in regard to their naval programs and new construction and we wish that other Admiralties would follow their example. As the initiated know, there are very few naval "secrets" that are really secret, yet in certain countries the public is still bluffed into believing that an elaborate display of mystery is essential to the national safety. This, however, is a digression, our purpose being to emphasize the great importance attaching to the recent bombing tests by the U. S. Army and Navy. It is the first time that experiments of this kind have been carried out on so extensive a scale and in circumstances simulating war conditions, and of the two lessons that have emerged it would be difficult to say which is the more significant. These lessons are, first, that a modern heavily armored capital ship is liable to be destroyed by bombs dropped from aircraft; and, second, that the application of wireless control to practically every type of vessel used in naval warfare is a perfectly feasible proposition. It may be argued that both these results might have been, and were, anticipated, but the fact remains that they have now been conclusively demonstrated, and we have advanced from the uncertain footing of theory to the solid ground of knowledge.

If, on the one hand, the small percentage of hits registered on the moving target ship *Iowa* should serve to check the exuberance of aviation enthusiasts who have been chanting dirges over the *Dreadnought*; on the other, the appalling effect of very heavy bombs on the *Ostfriesland* should give pause to the sceptics who have hitherto denied aircraft any serious rôle in future naval warfare. When we read of two or three 2000-pound bombs being sufficient to disable and sink a battleship that embodied all but the very latest ideas of protection, it is time to ask ourselves whether this new form of attack can be safely ignored. That the conditions under which the *Ostfriesland* was sunk bore little relation to those of war is doubtless true enough, but at least there was as much realism about this experiment as existed when the earliest tests of the torpedo and the submarine were made. There has been up to now a tendency to deny the value of bombing aircraft for naval purposes on two grounds, namely, that they cannot aim straight and that, even when they do hit the target, their bombs cause only superficial damage. The first contention has yet to be disproved, for in the recent experiments only a very small percentage of the bombs appear to have taken effect; but, in view of what happened to the *Ostfriesland*, it is clear that the heaviest bombs now in use are capable of destroying any modern capital ship. If bombs could be dropped from the air with anything like precision, the big ship would indeed be in mortal jeopardy, and it would be criminal extravagance to build any more of the type. But, happily or otherwise, no such degree of precision obtains at present, and for the time being the big ship stands a fair chance of survival against this form of attack, provided she is well enough armed with the anti-aircraft guns to keep the attacking

machines at a height too great for accurate bomb-dropping.—*Naval and Military Record*, 17 August, 1921.

**AERIAL PLANES TO BE USED IN "ALABAMA" ATTACK.**—New weapons of aerial warfare will be given an initial test when the army air service conducts its next bombing operation—a night attack on the old battleship *Alabama*. The plan is to stage the attack about September 15, probably at the scene of the recent tests upon the former German craft, off the Virginia Capes.

A "light barrage," composed of giant aerial flares, each of more than 200,000 candle-power, will be one feature of the attack. Army engineers have submitted such enthusiastic reports on this weapon that larger flares, estimated to be equal to 1,000,000 candles, have been placed under construction.

Giving a greenish-white light, literally "brighter than day," the flares to be used in the *Alabama* test will illuminate an area of five square miles and, expert flyers say, should enable the aviators to obtain greater accuracy than in the daytime. The flares are attached to a parachute of white silk, which reflects the light downward with sufficient intensity, it is believed, to blind the officers and gunners on the ship under attack, so as to demoralize any plan for defense, while keeping the upper air reaches shrouded in gloom.

Just before the armistice was signed flares of 200,000 candle-power were perfected by the ordnance branch of the Army Air Service. They were equipped with 18-foot parachutes, which kept them aloft while the magnesium burned for a period of from 7 to 11 minutes. No opportunity was afforded for a test against the enemy, however.

Although disappointed that they cannot have the *Alabama* equipped for battle with radio control, as they hoped, the army flyers are exerting every effort to conduct the bombing tests with war conditions as nearly simulated as possible.

It will not be the object of the army pilots to see how quickly they can sink the *Alabama*, but rather to try out special gas and non-extinguishable phosphorous bombs on her, as well as to ascertain the effect of small demolition bombs. Bombs up to 4000 pounds each may be used.

The *Alabama* is at Philadelphia and practically ready for delivery to the air service.—*Aerial Age*, 12 September, 1921.

**NAVY BLIMP DESTROYED.**—Twenty minutes before she was to have started for the hangar at Lakehurst, N. J., the naval balloon *D-6*, the largest and newest non-rigid dirigible possessed by the navy, burned, with her hangar and three other balloons, at the Rockaway Point Naval Air Station August 31.

No lives were lost, but Machinist's Mate Donald B. MacKay, in the car when the fire started, was severely burned.

The *D-6* was fully inflated and contained about 100,000 cubic feet of hydrogen gas. The other balloons, not inflated, were the kite balloon *A-P* and two small dirigibles, the *C-10* and the *H-1*.

A board of investigation was immediately appointed by Commander F. H. Strong, and after a three-hour conference, in which all members of the crew of the *D-6* were questioned, a report was forwarded to Admiral Moffett, in charge of the Bureau of Naval Aviation in Washington. Commander Strong would not make public the results of the investigation.

It was thought that gasoline fumes from a leaky fuel pipe may have been ignited by a spark from a hammer. A new tank had been installed and mechanics were busy connecting up the feed pipe.

Lieutenant Charles F. Bausch, who was to command the crew of seven men, had just ordered them to get their luggage when he saw flames shooting toward the gas bag. He ordered every man out of the hangar and turned in an alarm which brought all of the 250 men at the station.

The reserve hydrogen tank, containing about 50,000 cubic feet of gas, a steel structure of the cylindrical type, standing 100 feet from the hangar, was used as a vantage point from which the sailors turned streams on the burning hangar and nearby buildings, keeping the sides and top of the tank under two streams of water. Lieutenant Kloor and Commander Strong led the sailors. Their forces were supplemented by fire companies from the Rockaway Park station, and soldiers hurried over from Fort Tilden.

The combined forces kept a water barrage going for more than an hour on all sides of the burning hangar. A stiff breeze was blowing off shore and threatened for a time to carry the fire to the barracks, the Naval Hospital and store houses and across the dry grass to cottages along the shore.

The *D-6* was 200 feet long and 50 feet in diameter fully inflated. She was propelled by two 125-horsepower Union type motors, and could make 55 miles an hour. She had a lifting power of about 10 tons. The *D-6* carried 200 gallons of gasoline and had a cruising radius of 1000 miles. She was assembled at the Rockaway Point Station under the direction of Lieutenant Bausch.

The gondola and engines were built at the League Island Navy Yard in Philadelphia and the balloon was made at the navy balloon plant in Akron, Ohio. The *D-6* was equipped with the limousine type of gondola, completely enclosed, which made it possible, the authorities believe, for the men in the hangar to escape before the balloon ignited. The trip to Lakehurst would have been her maiden voyage, although she had been taken for several short test spins over Jamaica Bay and Coney Island.

The Navy Department has under way plans for several other ships of the *D-6* type.—*Aerial Age*, 12 September, 1921.

**GENERAL MITCHELL ATTACKS BOMB TEST FINDINGS.**—A chapter has been added to the "aircraft *versus* capital ships" discussion that has caused so much comment in Washington this year.

This new development comes from a report made by Brig. Gen. William Mitchell, Assistant Chief of Air Service, on the bombing tests held two months ago off the Virginia Capes. The report was submitted to Maj. Gen. Charles T. Menoher, Chief of Air Service, in the form of a memorandum.

The report has not been issued for publication by the Chief of Air Service. Its appearance is expected to cause a greater sensation than that which occurred in the Air Service administration last spring when General Menoher warned General Mitchell to "speak softly."

Statements made by General Mitchell in his report are at considerable variance with the findings of the Joint Army and Navy Board which was appointed to report on the bombing experiments conducted with seacraft off the Virginia Capes last summer.

The outstanding statements in the Mitchell report are:

Aircraft can operate under conditions when seacraft is helpless.

Aircraft can safely protect the entire coast.

Seacraft should cease operations when within 200 miles the coast.

All naval activities should be confined to the high seas.

Had the army air service been permitted to attack as it desired, the seacraft attacked would not have lasted 10 minutes.

The first provisional air brigade could have put out of action the entire Atlantic fleet in one attack.

The problem of destruction of seacraft by airplane is finished. It has been solved.

The scheme of national defense should be revised at once on the following basis: A department of national defense, with sub-secretaries for army, navy and air service; a department of aeronautics co-equal with the departments of war and navy must be created at once.

The report stated that at present there is a complete lack of liaison or system about our national defense. It scored the present coast defense

system, asserting that at least \$1,870,000,000, had gone to create a coast defense that is little more than useless against hostile aircraft and hostile sea forces.

The report, as printed by *The New York Times*, says in part:

"Air forces with the types of aircraft now in existence or in development, acting from shore bases, can find and destroy all classes of seacraft under war conditions with a negligible loss to the aircraft. It is not necessary to destroy hostile seacraft at a distance greater than 25 miles off shore in order to protect the coast, as this distance exceeds the range of the most powerful guns at present installed. Aircraft, acting from suitable floating airdromes, can destroy any class of surface seacraft on the high seas.

"Conditions of weather affecting the air and sea conditions do not alter the statement made above, as aircraft can operate in conditions under which seacraft cannot operate. There are no conditions in which seacraft can operate efficiently in which aircraft cannot operate efficiently.

"The weapons used in the recent exercises against the seacraft were bombs alone. Torpedoes, gas, gunfire and mines were not employed. The army air service was not permitted to attack the targets, as it would under actual conditions, and never was more than one-tenth of the brigade employed in a single attack.

"Had the army air service been permitted to attack as it desired, none of the seacraft attacked would have lasted 10 minutes in a serviceable condition. The first provisional air brigade could have put out of action the entire Atlantic fleet in a single attack. The value of the airplanes in the first brigade did not exceed the cost of a modern destroyer."

General Mitchell then explains how battleships under war conditions are much more vulnerable than the targets used in the bombing tests. A battleship with full steam up and speeding ahead is a target much easier to hit and to put out of commission than the targets used, he asserts.

"The problem of destruction of seacraft by forces has been solved and is finished," the report goes on. "It is now necessary to provide an air organization and a method of defending not only our coast cities, but our interior cities against the attack of hostile air forces. Our recent maneuvers show an enemy having gained control of the air—which gives him control of the sea—may land air forces from airplane carriers on any of the islands or keys along our coast, which cannot attack by troops or artillery, and from those points launch air attacks against our great centers of population, extending even to Chicago, St. Louis and other Middle Western cities."

The report then explains how Chicago, St. Paul, Omaha, Kansas City and other cities in the Central West would be laid open to airplane attacks and their cities bombed with high explosives and the citizens killed with gas and incendiary bombs.

In conclusion, General Mitchell makes the following recommendations:

1. The establishment of an air force for frontier and coast defense.
2. The equipment of the navy for offenses on the high sea, and not for coast work.
3. Navy control should cease 200 miles from shore, protection of the land and the coast defenses being left to the army and the air service.
4. A more co-ordinate and working understanding between the different arms of the service. The present system, a heritage of our easy wars, has clearly demonstrated that the present lack of co-operation is a serious fault.

"In this connection," the report states, "an efficient solution of our defensive needs will not exist until a department of national defense is organized with a staff common to all services. Subsecretaries for the army, the navy and for the air service must be created."—*Aviation*, 26 September, 1921.

THE LESSON OF THE "ZR-2" DISASTER.—The two chief questions which in connection with the accidental destruction of the rigid airship ZR-2 (or R-38) come to the mind of the average person are:

1. What was the matter with the ZR-2?
2. Was her purchase by the United States Navy justified?

While it is yet premature, pending the findings of the official inquiry, to state with finality what caused the terrible disaster, it is not difficult to visualize what went wrong with the ZR-2. Statements by survivors seem to establish pretty definitely that the big airship broke in two not under the strain of full speed trials, as had first been assumed, but that the longitudinal snapped when the helm was put hard over. The commander of the dirigible, who was rescued, has declared that at the time of the accident the ship was making 50 knots—as against 65 knots "all out." On the other hand, another survivor, Lieutenant Bateman, states that just prior to the accident the ship had made turning tests, and that two turns had been managed without difficulty, but that on the third the vessel broke her back. His statement is particularly significant in view of the fact that he was able to observe the working of the rudders as he was seated in the stern cockpit, which is aft of the rudders.

So it becomes obvious that the ship was turned too suddenly for the speed at which she was flying, although this maneuver might have been totally harmless at a lesser speed.

This is still a further point to be considered: information reaching this country from men who were in close contact with the development and trials of the ZR-2 shows that her control surfaces were overbalanced. That is to say, the balanced portion of the rudders was so large that they were extremely sensitive to air pressure, so that when the ship was under way a slight turn of the steering wheel would suffice to whip about the rudders. At high speed this would naturally cause a tremendous strain on the 700-foot-long framework.

It would therefore seem that the design of the ZR-2's rudders was faulty. This defect, which might have been easily remedied, would not have been a serious matter on a stronger ship. But the ZR-2, far from being a strong ship, was what one may call an "extra-light" vessel—a feature which borders on structural weakness. To understand the why and wherefore of the situation we must look at the history of rigid airship development, which takes us back to Count Zeppelin.

Germany launched her first "super-Zeppelin," a 2,000,000 cu. ft. vessel, in 1916, after fifteen years' experience in this branch of engineering, in which period she built some sixty Zeppelins ranging all the way from 400,000 cu. ft. to 1,250,000 cu. ft. In the fall of 1916 one such super-Zeppelin, the L-33, was brought down fairly intact in England and the British Admiralty instructed its airship designers to duplicate it. Up to that time British experience in rigid airship design and construction was limited to that obtained from a number of experimental ships that were being built after very incomplete drawings of pre-war Zeppelins. The British copy of the L-33 called the R-33 was only finished after the armistice, her trials taking place in the spring of 1919. Although the vessel embodied some improvements found in another captured Zeppelin, the L-40, which had come down intact in France, it should be pointed out that while the latter ship had a useful load of 39 tons, and the L-33 one of 30 tons, the British copy of these 2,000,000 cu. ft. dirigibles had only a useful load of 24 tons. All of which is merely mentioned to show that a painstaking copy of an engineering structure will not necessarily be identical in all respects with the prototype—although they may *look alike*.

But while the R-33 carried a smaller useful load than her German sister-ships, she seemed to be in every way as strong as the latter. How strong the hull of these ships was, the R-34 (sistership of the R-33) demonstrated at Mineola, Long Island, where for four days she withstood the buffeting by

winds, although on one occasion with the anchorage fitting of the main handling rope was pulled clean out of the framework.

The success of the *R-33* class airships prompted the British Admiralty in 1918 to prepare drawings for a much larger class of airships which were to be superior to the German *L-71* type. This was the ill-fated *R-38* (the *ZR-2*, as we call it) class, which incorporated numerous novel and original ideas. Now, it should be emphasized that when this class was *laid down*, all the experience the British had in rigid airship construction had been derived from copying German ships. The only firm which eventually was to produce a highly successful original design (Vickers, Ltd., with their *R-80*) had not by then emerged from the experimental period of their work; their experience was therefore unavailable.

And what may strike the reader as particularly odd, the Admiralty gave the contract for the construction of the *R-38* (or *ZR-2*) to Short Bros. of Bedford—a firm that had never before built a Zeppelin type airship and whose entire experience with rigids was obtained from the building of *R-31* and *R-32*, which were patterned after the plywood-framed Schuette-Lanz type.

Here then we have, in part at least, the answer to the question which heads this article: What was the matter with the *ZR-2*? *This ship was built in a factory that had no previous experience with duralumin airship construction, and to plans which were not based on practical experience.* To cite but one instance, the well-proven radial truss of the transverse frames was replaced on the *ZR-2* by a tangential truss system, the merit of which had yet to be demonstrated. In this connection I cannot do less but pay a respectful homage to the memory of the late Colonel Campbell, chief airship designer of the Admiralty, who had sufficient faith in his ideas to go up on the *ZR-2* during her several trial trips and who lost his life with the ship.

Knowing the circumstances which surrounded the construction of the *ZR-2*, we begin to understand why, as one report has it "several girders were strained in the factory when as many as thirty fitters crowded on them in the course of the assembly work." It is quite conceivable that workmen accustomed to the resiliency of plywood girders would do such a thing and that their foreman, not knowing any better, would not warn them. And a 700-foot airship is such a gigantic structure that the engineers familiar with the vagaries of duralumin—whom the Admiralty had detailed to the Short Works—could not personally supervise every detail.

For the sake of completeness it may be added that when Messrs. Short Bros. closed down their airship department, the Admiralty took over their factory and completed the *ZR-2*, whereupon she was handed over to the British Air Ministry.

That the hull of the *ZR-2* was structurally weak was first demonstrated on the inflation of the ship when, due to unequal load distribution, several girders buckled. The failing members were repaired, but during the first trial flight trouble was again experienced from several intermediate longitudinal and transverse frames, so that it became necessary to reinforce certain portions of the framework. Details are not available as to the exact nature of the stiffening work, but one might suggest that by reinforcing certain girders others may have been further weakened. Of course, this is merely a guess.

Judging however from all that has been said before it appears beyond a doubt that the *ZR-2* was structurally weak—a condition brought about by the desire to carry the greatest possible useful load. This, as originally designed, was to be in excess of 50 tons, but it was subsequently reduced by the fitting of a bow mooring gear, not to speak of the reinforcement of the hull.

As to the second question we have placed at the head of this article: "Was the purchase of the *R-38* by the United States Navy justified?"—it would seem to the impartial observer that it was not.



Indeed, why should the government spend abroad \$2,000,000 on a foreign-built, untried type of dirigible?

On the one hand the navy is desirous of developing rigid airships in this country. This cannot be brought about only through experimentation, and it will be admitted that if the necessarily heavy financial outlay has to be faced it will better serve its purpose if the money is spent here rather than abroad. American inventive genius is second to none in the world and can be relied upon to solve the problems of rigid airship construction just as well as it has solved other engineering problems.

On the other hand, if the Navy Department—which is in charge of rigid airship development to the exclusion of the army—wanted to have a ready-made airship of proven design, it would seem that it could have secured from Germany, without cost, by virtue of America's participation in the victory—a dirigible that would have been far superior to the R-38. This will be seen from the appended table which gives the chief characteristics of the R-38 and of the L-71, Germany's largest Zeppelin, which was surrendered to Great Britain, while her sister ship, the L-72, was surrendered to France:

Type	Capacity cu. ft.	Length ft.	Dia. ft.	Total H. P.	Useful load (tons)	High speed miles per hour
R-38 .....	2,720,000	695	85	2100	50(?)	75
L-71 .....	2,420,000	745	79	1740	48	75

It is not generally known that while the war spoils of the United States include a great number of airplanes and engines, the lighter-than-air material of Germany was entirely divided up between Great Britain, France, Italy and Japan, the United States merely playing the rôle of a disinterested spectator. That this was a grievous mistake, will be readily conceded by all those concerned with the development of American airships.—*Scientific American*, 17 September, 1921.

**SETTLEMENT FOR THE "R-38."**—When the time comes to take up the matter of the financial adjustment incident to the wrecking of the R-38 a proposal will be made to the British Government that one of the one time German dirigibles be turned over to the United States. Just how this suggestion will be received by the British cannot be contemplated, but the naval officers connected with aviation, particularly lighter-than-air craft, are hopeful it will bear fruit.

The British Government has three of the one time German airships. They were turned over to the British Government under the terms of the armistice.

They are much smaller than the R-38. One of them is only half the size, while two are about two-thirds the size.

The contract price for the R-38 was \$2,000,000, of which amount \$1,500,000 had been paid to the British Government for the account of the manufacturers. Under the terms of the contract the United States was to pay half and the British Government half in the event of an accident.

Nothing has been done as yet regarding a financial settlement. The officers of the navy have felt that this matter could wait until the bodies of the victims had been buried.—*Aviation*, 26 September.

**WHAT CRUMPLED UP THE "ZR-2?"**—This is likely to be discussed for many months by engineers. The answer will have an important bearing on the future of aerial navigation. Few technical authorities have yet spoken. The daily press seems doubtful—the point of general agreement being that a disaster like that which befell the ill-fated dirigible is certainly not normal. Something was the matter. What was it? One of two voices, to be sure, may be heard to suggest that after all perhaps it could not have been otherwise, and to point to what they assert to be a fact—that no

German Zeppelin ever lived more than six months. Most writers, however, assume that the accident was avoidable, and the technical papers that have so far commented on it attribute it to structural weakness, which from one standpoint is reassuring, for that which is weak may be made stronger. An editorial writer in *The Engineering News-Record* (New York) declares that one or two of the numerous points of obscurity concerning the disaster should be cleared up soon. He writes:

"The first is the fundamental question of competence in the construction: Was every opportunity taken to apply the knowledge gathered from past experience? In other words, was the collapse the result of faulty or neglectful design, or does the accident truly represent insufficiency of existing knowledge? Next, but related to the preceding, is the question of whether this dirigible was planned on a scale so far beyond the range of past experience as to make the failure attributable to that fact itself. The danger of an abrupt change of scale of construction is known from many past experiences, and if excessive size is the secret of the present accident, there is less occasion for alarm. But in that event it becomes more surprising that 45 or 50 valuable lives were put at risk in a machine whose safety was still questionable.

"One fact of the disaster, in some respects its most damning feature, yet gives reason for a hopeful view as to the possibilities of the dirigible; the fact that the fall was due to a structural failure, not to defects of the lifting or driving equipment. If the constructors of aerial vessels have mastered all their problems other than structural, if they have made gas bags, machinery, and controls quite dependable, the outlook is bright, for nothing remains but to perfect the structural element of the vessel, and the road to this objective is a well-explored one. The loading must be determined, and thereafter it is only necessary to apply the resources of a well-developed art to obtain completely sound construction. The difficulties which lie in the determination of the loads may need to be approached by gradual steps; for the phenomena involved in the resistance of a slender bag structure hundreds of feet long to air forces are as indeterminate as those of wave loading on a ship's hull, and at the same time vastly more complex than the latter. But certain it is that every experience in aerial navigation will contribute to building up an increasing body of knowledge, leading constantly closer to the required certainty and safety.

"In the infinitely more difficult field of airplane construction, a truly wonderful degree of reliability has been attained—and this during a period much shorter than the history of lighter-than-air navigation. This result was achieved by ceaseless, undismayed work at the solution of the many baffling problems presented. Very much of the knowledge had to be gained at the cost of accident, but each accident was used as a step to fuller knowledge and sounder construction. If the only remaining problems of dirigible construction are of the structural kind, a simpler and more rapid development may be forecast.—*Literary Digest*, 24 September.

"ZR-2" MEMORIAL SERVICES IN WESTMINSTER.—Airmen of the United States Navy and the British Royal Air Force united September 7 in a service for the victims of the ZR-2 disaster "amid the memorials of Great Britain's most illustrious dead," as one of the prayers expressed it, in Westminster Abbey.

Air Commander Maitland, D. S. O., and Commander Louis Maxfield, U. S. N., were especially mentioned in the official program, but among the mourners no distinction was made, and the wives of ordinary riggers and of scientific experts sat side by side in seats reserved for them. Ambassador Harvey, Vice Admiral Niblack, Rear Admiral Twining and Consul General Skinner were among the well-known Americans seated in the choir. Near them were representatives of the King and Queen, the British Cabinet and the naval, military and air forces. The Lord Mayors of London and Hull and the Mayors of Westminster and Bedford attended

in state, and a large number of British flying officers, with rows of ribbons worn by hard adventure worn across their tunics, also came to pay tribute to their fellow-aviators.

The general public filled every seat in the nave, hundreds being turned away disappointed. Just before the service began a detachment of sailors from the United States battleship *Utah* marched in. Near them was another group of American sailors of still more significance. They were all that are left of the crew of the *ZR-2*, men who were left behind at the Howden aerodrome as she started on her last cruise.

An address was read from the chancel steps by the Rev. H. D. L. Viener, chaplain in chief to the Royal Air Force. He described how the Americans and British air forces had been associated in developing "a once formidable engine of destruction into a pioneer of closer commercial relations," and dwelt upon the horror of the catastrophe when long months of training were over and only the eagerly awaited voyage home seemed to remain.

"The price of progress and the toll of science," he explained, "are bitter enough. Yet, thank God, there is never lack of splendid men ready to do and to dare. It is best so. To be in the forefront of the fight to conquer what half a generation ago was an untried field will ever appeal to our splendid manhood."

As he finished the choir broke into "Mine Eyes Have Seen the Glory of the Coming of the Lord," and never did the old battle hymn seem to come with more appropriateness. The service closed with prayers and a hymn which here is imperishably associated with trials, vicissitudes and triumphs of the great war, "O God, Our Help in Ages Past." Then, after the blessing, the congregation stood motionless as the bugle notes of "The Last Post," wailed through the lofty arches and the American and British national anthems were sung.

Secretary Denby has been advised that the British cruiser *Dauntless*, which is bringing home the bodies of the officers and men of the navy who lost their lives in the *ZR-2* disaster, will arrive in New York late on September 16, or early in the morning of the 17th.

The ship will dock at South Brooklyn and ceremonies will be held on the dock at 2 o'clock Saturday afternoon, September 17. All arrangements in connection with these ceremonies will be made by the commandant of the Third Naval District, Captain C. T. Vogelgesang.—*Aerial Age Weekly*, 19 September.

**BOMBING TESTS OF THE U. S. S. "ALABAMA."**—To enable the Army Air Service to pursue bombing experiments against warships supplementary to the tests conducted last June and July off the Virginia Capes, the Navy Department has turned over to the War Department the obsolete battleship *Alabama*.

The objects of the tests conducted with the *Alabama* are described in an Army Air Service communiqué as follows:

*Objects of the Tests.*—(a) To determine what explosive or gas effect is needed to put seacraft *out of action*. It has been demonstrated that seacraft may be utterly destroyed; but obviously, if the system of fire control, communication and mechanical installations of vessels can be disrupted and the nervous systems of the human beings who man seacraft can be shattered, the efficiency of the craft is destroyed without necessarily sinking it.

(b) To determine the effect of smoke bombs in concealing the attack of aircraft and of the effect of white phosphorous clouds in neutralizing anti-aircraft elements.

(c) To determine the effect of machine gun fire and fragmentation bombs in clearing the ship's decks of anti-aircraft units.

**(d) To determine the feasibility and effect of night attacks on seacraft.**

There will be two distinct phases in the operation—the first, purely experimental in its nature to determine the effects of various auxiliary agents in the attack, the second, to consist of attack proper, simulating as nearly as practicable service conditions.

*Location of Target.*—Target will be located in Chesapeake Bay in the vicinity of the ex-*San Marcos*. Operations at the target will be controlled from the sub-chaser.

*Board of Observers.*—A Board of Observers consisting of three Air Service officers, two ordnance officers and two officers of the Chemical Warfare Service will inspect the results of tests and attacks on the battleship as indicated hereafter.

An advanced airdrome will be established near the target. A radio station will be established at that point by the communications section. The sub-chaser, one gig, and the *Sea Hornet* will be stationed at this airdrome during the operations for the purpose of transporting the Board of Observers and other visitors to and from the scene of the bombing, and for rescue work. During bombing the Board of Observers will be stationed aboard the sub-chaser.

*Description of Tests and of Attacks.*—In the preliminary tests a sufficient number of bombs and flares of all types will be dropped to determine the effect of each and the best method of tactical employment. It is anticipated that experiments with tear gas bombs will give important data on the attack of battleships by gas bombs. In similar manner the effect of phosphorous and smoke bombs will be determined. It is believed that smoke screens may be used with great effect in protecting the attacking airplanes from anti-aircraft defenses of seacraft. In order to determine this a series of tests will be held in which the various branches of aviation will make simulated attacks on the battleship through smoke screens.

*Night Attacks.*—The tactical effectiveness of flares in illuminating the attack of battleships will be determined in the preliminary tests as well as the effect of white phosphorus in outlining seacraft at night with sufficient distinctness to permit accurate attacks.

Tests will also be conducted to determine the effect of the 1100-pound armor-piercing bomb.

Upon the completion of the above-named tests an attack will be made on the battleship. This will be for tactical purposes and will employ the 1100-pound, 2000-pound and 4000-pound demolition bombs.

*First Day. Tests with Chemical Agents.*—In order to determine the effect of each of the following type of chemical bombs, tests will be made in the order listed below:

Tests	Planes	Type of bombs	Number of bombs
1	1-M.B.11	50-lb. smoke bomb, navy type	4
2	1-D.H.4B	25-lb. Mark I, phosphorous	4
3	1-M.B.11	100-lb. Mark II, phosphorous	4
4	1-M.B.11	50-lb. Mark III white phosphorous	2
5	2-D.H.4B	25-lb. Mark I, C & C T	16
6	2-M.B.11	50-lb. Mark I (lead lined) tear gas	8

In each attack one plane carrying the same number and type of bombs will accompany the attacking planes to the objective but will not release the bombs unless one of the planes is forced to abandon the mission.

*Second Day. Smoke Screen Tests.* In order to determine the best method of employing smoke screens with the various branches of aviation, experimental flights will be made by pursuit planes, light bombing planes, and heavy bombing planes. Only light bombs will, however, be used and

their effect on targets observed. List of tests in the order in which they will be conducted follows:

Tests	Planes	Type of bombs	Number of bombs
1	Fl. of 3 D.H.4B	50-lb. smoke bombs, navy type	12
	Fl. of 5 SE-5's	25-lb. Cooper bombs	20
2	Fl. of 3 D.H.4B's	100-lb. Mark I leaded with phosphorous	12
	Fl. of 3 D.H.4B's	50-lb. smoke bomb, navy type	12
3	Fl. of 3 D.H.4B's	50-lb. smoke bomb	12
	Fl. of 3 M.B.11's	100-lb. demolition Mark I	12
4	1 M.B.11	1110-lb. armor-piercing shell	1

Upon the conclusion of each test there will be an examination of the *Alabama* by the Board of Observers to determine the results obtained.

*First Night. Tests of Illuminating Bombs and Flares.*—In order to investigate the results of bombing at night and the illuminating effects of parachute flares and white phosphorous bombs as an aid in accurately locating the objective, the following tests will be conducted in conjunction with the dropping of illuminating flares and bombs.

Tests	Planes	Type of bombs	Number of bombs
1	1-D.H.4B	50-lb. Mark III (leaded with white phosphorous)	2
	1-D.H.4B	25-lb. Mark I, demolition	4
2	1-D.H.4B	Michelin flare, Mark I	4
	1-D.H.4B	25-lb. Mark I, phosphorous	4
3	1-D.H.4B	50-lb. Mark III (leaded with white phosphorous)	2
	1-M.B.11	100-lb. Mark I, demolition	8
4	2-D.H.4B	30-lb. Mark III (leaded with white phosphorous)	4
	2-M.B.11	100-lb. Mark I, demolition	12
4	1-D.H.4B	Michelin flare, Mark I	4
	1-D.H.4B	100-lb. Mark I, phosphorous	2
	1-M.B.11	100-lb. Mark I, demolition	6

Upon the conclusion of these attacks there will be an examination of the *Alabama* by the Board of Observers to investigate the results obtained.

*Second Night.*—On the second night an attack will be made for the purpose of destroying the *Alabama*. Following will be the order of attacks:

Attack	Planes	Type of bombs	Number of bombs
1	1-H.P.	4000-lb. demolition (if available)	3
		(successive attacks will be made by a single H. P.)	
2	8-M.B.23	2000-lb. demolition	8

*First Day of Tests.*—The first day of tests (chemical agents) was September 23. The following particulars of these tests are reproduced by courtesy of *The New York Times*:

A fleet of planes from Langley Field poured a constant fire of chemical bombs on the ship, at times hiding her completely from view in dense clouds of white smoke and flooding her decks with tear gas.

At noon a Martin bomber flew by at 75 miles an hour, dropping four 100-pound phosphorus bombs, each of which struck squarely on the vessel. As the "eggs" hit the battleship the phosphorus splashed up and fell to the decks in gray clusters of spray. Flashes of flame glowed through the thick smoke, but were almost instantly obscured by a cloud of dense white fog.

The *Alabama* was hit on the after fighting top, on the bridge, just aft the forward turret and on the stern. For a long time flames burned the planking of the *Alabama's* deck, and when the army and navy observers went to view the effect upon the target the fire was still raging.

As no men were stationed on board the *Alabama* during this or any other test, the personnel of the ship was represented by wooden boxes at various posts. Practically every one of these was scarred and discolored by the phosphorus gas, showing that if the ship had been manned her officers and enlisted men would have been knocked out by the choking chemicals.

Besides phosphorus bombs, smoke bombs were used to show that a heavy smoke screen could be so dropped that it would entirely hide oncoming aircraft and also the target itself.

Still another experiment was conducted with tear-gas bombs. Three direct hits were made with bombs manufactured at Edgewood Arsenal especially for use during the Mingo Miners' war.

These contained only a 10 per cent mixture of tear gas for they were intended to frighten rather than to injure for a long period. The bombs were so drastic in their effect that forty-five minutes after they struck the vessel observers were unable to penetrate the ship without gas masks.

*Night Bombing Test.*—The night bombing test, September 23-24, resulted in several direct hits being made on the *Alabama* by attacking airplanes.

Sopwiths darted down at an angle of 45 degrees as they neared the vessel, and the airmen let loose their machine guns as in actual battle combat. The purpose of this was to destroy the morale of the attacked ship's personnel.

As they crossed over the ship from prow to stern the aviators dropped their demolition bombs in pairs. The gleaming missiles were easily seen as they fell through the air. Many struck in the water near the ship. One hit the forward turret and another the aft basket mast. Still another struck a searchlight and a fourth smashed the bridge to pieces.

The aviators seemed to gain better aim each time they returned to the target. At first they were inclined to shoot short of the vessel, but, learning the wind, they held their fire until close in at about a 200-foot range.

Following the Sopwiths came the four Martin bombers. The first dropped two of her 300-pound bombs in the sea beside the *Alabama* from a height of 1500 feet, but the third machine let go her two bombs directly on the forward deck. As the first bomb struck the prow of the *Alabama* a column of flame shot up.

This hit was considered a feat by the Air Service observers because the wind had shifted and the Martin bombers were crossing the target amidships, leaving a narrow target.

*Second Day Test.*—The second day test, September 24, started with nine *DH-4* Air Service machines laying a smoke screen across the windward side of the *Alabama*. Some of the smoke bombs did not ignite, but eight caught fire and a fan-shaped cloud arose which hid all the vessel except her bow.

This test was followed by bombing attacks with 300-pound bombs dropped by Martin bombers. One of these bombs hit on the bow of the ship and tore through her first deck, spreading the sides of the jagged hole upward so far that the guns of her forward turret would have been unable to sight above the wreckage.

The crew's quarters below this deck were demolished. A second bomb, dropped with the first, followed through the hole made by the first, causing more destruction.

In addition to the Martin bombers, a fleet of eight *SE-5* planes dropped thirty-two bombs, many of which struck the ship in vital spots. Her communication systems were shot away, her fighting masts badly damaged and some of her searchlights were put out of commission.

So terrific were some of the explosions that the battered *Alabama* tore loose from her anchor chains and drifted down toward the wreck of the *San Marcos* and the *Indiana*.

The next morning the ship was seen to be on fire, and mine sweepers made fast to the hulk and fought the fire back into the holds, where it was not believed it would accomplish much additional damage.

*The Alabama is Sunk.*—The final attack on the *Alabama*, on September 26, resulted in the ship being sunk by a 2000-pound demolition bomb.

The bomb tore off her mast, destroyed her superstructure and turned her over on her side in shallow water. Six other planes almost simultaneously rained 1000 and 2000-pound bombs on the hulk as she went down. Four hit the vessel as she trundled over and the remainder landed in the water within 20 to 30 feet.

The plane which gave the *Alabama* her death blow flew over the vessel and dropped a 100-pound sighting bomb. Her pilot then guided her back, and from observations taken the 2000-pound bomb was dropped in the identical spot where the sighting bomb hit—directly at the base of the mainmast.

The scoring by the seven planes participating in the final attack was 100 per cent, Air Service officers said.—*Aviation*, 3 October, 1921.

**NEW ITALIAN AIRSHIP.**—The French Government is reported to be investigating a new lighter-than-air flying machine which is under construction at Naples. Using no gas, it is based upon the principle of the lightness of rarefied air. By a variable exhaustion of air in a series of envelopes, levitation is obtained.

The machine is the invention of two Italians, Vaugeau and Gargiulo. They do not form anything like a perfect vacuum, but by a system of enclosed reservoirs, the center one of which has the greatest rarefaction, they say that they have obtained the result that the pressure of the outside atmosphere is lessened to a degree which makes the frail envelope practicable.

There are three features of the construction. The first is a double envelope one part with another. In the outside envelope an atmosphere of seven-tenths is maintained, whereas in the center envelope the air is much more rarefied. The layer of seven-tenths atmosphere weakens the outside pressure upon the interior of the balloon, which exercises the levitation force.

The second feature is a series of hollow beams forming the frame of the machine, through which compressed air circulates in a manner to exert a counteracting pressure against the outside atmosphere.

The third feature makes use of air heated by the motors to obtain a further decrease of the outside pressure.

Professor Garuffa, an Italian expert, holds that the new machine means a revolution in flying. It will do away with the expense of the use of hydrogen and, it is said, will greatly reduce the crews needed.

The inventors say that the machine when perfected can make 350 miles an hour with 750 horsepower.—*Aerial Age Weekly*, 19 September, 1921.

**BRITISH AERIAL TRANSPORT.**—A type of aircraft which is quite new in some of its features is being constructed at Bristol for the government.

In describing it a *Daily Mail* correspondent says: Viewed even from a distance the colossus looks astonishingly large. Seen close at hand, with the framework of its tiers of wings, as yet uncovered, stretching one above another on either side of its tremendous hull, the machine almost takes one's breath away.

Gone is the day of aeroplanes as we have pictured them hitherto. This machine wants a new name. Its body makes one think of the slim lines of a speedy sea vessel. Then, when you are inside it, the impression is rather like that of some Pullman-car express on a glorified scale. But it is not

really like a ship or any earth vehicle. Those working on it merely call it an "aerial transport."

It may be used to carry troops. It is big enough to act as a tender for a squadron of aeroplanes, carrying fuel and spare parts for them. It may be fitted up as a Red Cross craft of the air and have its lofty main saloon equipped as an operating theatre.

*Concentrated Power Units.*—There is an engine-room inside the moister's hull. Banished here at last is that "amateurish" scheme of dotting motors with their propellers out somewhere on wings where they are inaccessible. Here there is a battery of engines, with their many gleaming cylinders, grouped in orderly precision; and—what makes the expert pause—such a system of gearing and power transmission as has never been fitted to any flying craft before.

It is from this engine room that the power will be transmitted to propellers on the wings; and if the experiment succeeds it will open up a completely new field. There is talk, for instance already, of obtaining a number of the huge 1000 h. p. aero engines now reaching perfection and using them for an enormous craft which may surpass our wildest dreams.

This Bristol giant will fly by night and day. The peril of forced landing—that bugbear of the aeroplane—is practically eliminated. If any portion of the power-plant gives trouble there will be mechanics in the engine room to put it right while the machine is in the air, the other working units being accelerated meanwhile to give the power sufficient to maintain altitude and speed.—*Naval and Military Record.*

**THE PARSEVAL SEMI-RIGID AIRSHIP "PL-27."**—The development of the German non-rigid *PL* airships occurred between 1906 and 1917. These two letters stand for "Parseval Luftschiff." The Parseval airships are all built according to the patents of Major August von Parseval, Dr.-Engineer, by the Luft Fahrzeug Gesellschaft (L.F.G.) at Berlin and Bitterfeld. That the Parseval airships were successful is attested by the fact that they were used before the war in Austria, England, Italy, Russia, and Japan.

Since 1913 all Parseval airships were constructed with envelopes having the Parseval patent trajectory band system of car suspension, which is a very efficient system of non-rigid construction. The *PL-27*, built during 1916, is in reality a semi-non-rigid, although classified in Germany as a non-rigid one. Within the envelope of this ship there is a V-shaped keel extending almost the entire length of the aircraft and containing the narrow runway or "catwalk" common to all large airships of the Zeppelin or rigid type. Forward, beneath this, is the navigating car or gondola, while immediately behind it is the first power car in a central position. In the center of the dirigible, on each side of the keel, are two power "eggs" or cars similar to those used on the later types of Zeppelins. At almost the extreme aft end of the keel is located another power car. All of the power cars are carefully streamlined. The gasoline tanks and water ballast bags are located on each side of the runway, the same as in rigid airships. *PL-27* is the largest "semi-non-rigid" airship built to date, and her performances have been extremely good, especially as regards useful load and speed. Nothing has heretofore been published about the carefully-guarded development of this type of ship that took place in Germany during the late war.

The interesting and important main dimensions, weights, performances, etc., are as follows:

Capacity, 1,000,000 cubic feet; length over all, 518 feet; diameter, 64.3 feet; total load, 74,700 pounds; useful load, 30,600 pounds; number of engines, 4; make of engines, Maybach; total horsepower, 900; propellers, 4 two-bladed of wood; speed, 72 miles per hour.

Account must be taken of the complexity of a non-rigid airship of such dimensions. It has the advantage, however, of not being so liable to break its back, or certain girders thereof, as happened in the case of the



ZR-2, with such unfortunate results. If, instead of prohibiting experimentation of any sort with airships by Germany in the Versailles Treaty, the United States had allowed construction and experiments to continue to a certain limited extent, she would undoubtedly have benefited thereby in her new policy of aircraft construction, as proper tests of *PL-27* would probably show her to be superior to the Zeppelins as regards economy and useful weight lifted, although at present the latter type of airship is considered in Germany to be better for long-distance transportation.—*Scientific American*, 1 October, 1921.

LIEUT. MACREADY SETS NEW ALTITUDE RECORD BY FLIGHT OF 40,800 FEET AT DAYTON FIELD.—Lieutenant John A. Macready, a test pilot at McCook Field, to-day shattered the world's altitude record, attaining a height of 40,800 feet in the same La Pere biplane used by Rudolph C. Schroeder, who set a record of 38,180 feet on February 28, 1920.

Lieutenant Macready was in the air 1 hour and 47 minutes, requiring all but a few minutes of the total flying time to reach his mark. At 39,000 feet ice formed on his oxygen tank, but he pressed on until the altimeter registered 41,000 feet. At this point his engine coughed and died. He then glided safely to the ground.

Macready's new record is 2620 feet higher than that of Schroeder, and in this flight the pilot suffered none of the hardship met by the former chief test pilot. Schroeder's eyeballs froze and excessive dilation of the heart kept him in a hospital nearly two weeks after the flight. On landing Macready declared he suffered only from numbness. He climbed out of the plane unassisted and posed for photographs.

Lieutenant George B. Patterson, chief of the technical data section of the field, took charge of Macready's instruments, and following calibration announced the official altitude as 40,800 feet.

Macready was clothed in the heaviest furs with special helmet and goggles. To insure clear vision a special gelatin was used on the goggles to prevent collection of ice. The suit was electrically heated throughout.

A centrifugal air compressor operated by a gas turbine forms the supercharger which made the flight possible. The turbine derives its power from the hot exhaust gas of the Liberty motor with which the ship is equipped, and air thus compressed is fed to the carbureter at the same pressure as air at sea level.—*New York Times*, 29 September, 1921.

### NAVIGATION AND RADIO

THE VOYAGE OF THE "QUEST."—It is possible that the voyage of the *Quest*, under Sir Ernest Shackleton, may lead to a substantial addition to the sum of knowledge of the conditions obtaining in the upper air. Sir Ernest recently offered his services to the British Air Ministry to carry out meteorological observations and to gather topographical information during his forthcoming expedition to the Atlantic, Southern and Indian Oceans. The *Quest* has been furnished with instruments and equipment necessary for carrying out observations, and she has been constituted an official reporting ship to the Meteorological Office. She has also been supplied with photographic apparatus and with kites similar to those employed in the investigation of the upper air over the Atlantic during the voyage of the steamship *Montcalm* prior to the flight of *R-34* in 1919. It is further proposed to take records of the temperature and pressure of the upper air by using a seaplane which is to accompany the expedition. As the ship will, among other places, visit the islands of St. Paul's Rocks and Tristan d'Acunha, in the Southern Atlantic, some valuable data should be collected. The first of these groups lies on the route which would probably be followed by aircraft flying via a position almost midway between South America and South Africa.—*Aerial Age Weekly*, 30 September, 1921.

**WIRELESS DIRECTION SERVICE ON BRITISH COLUMBIA COAST.**—The first modern device for directing steamers by wireless on the British Columbia Coast has been erected at Tatoosh, and is now in operation. All shipping masters are invited to make full use of this apparatus by which, it is claimed, steamers can be directed in a fog as easily as they can find their way in broad daylight.—*Nautical Gazette*, 1 October, 1921.

## ENGINEERING

**BRUEGGERMAN WATER-TUBE BOILER.**—The feature of the Brueggerman water-tube boiler is a water-storage reservoir that is connected with the drums of the generating part of the boiler. The upper part of the reser-

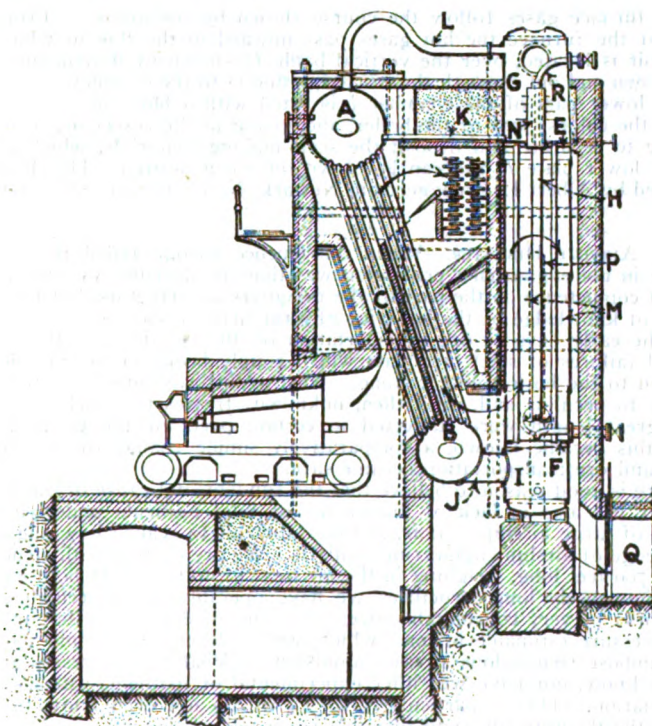

voir is utilized as a steam dome. The water of circulation passes through the main chamber of the reservoir, and the gases of combustion pass around it.

The generating part of the boiler consists of the upper and lower drums *A* and *B*, which are connected by a bank of inclined tubes *C*. Water is supplied to the drum *B* from the vertical cylindrical reservoir, which is divided by the tube plates *E* and *F* into three compartments, the upper one, *G* serving as a steam dome. The center portion as a water reservoir, and the lower chamber *I* connecting through the nozzle *J* with the lower drum *B*. The drum *A* is connected to *G* by the pipes *K* which are arranged below the water line. The steam space of the drum *A* is connected by the pipes *L* with the steam space of the chamber *G*. Tubes *M* extend from the upper

plate *E* through to the corresponding lower plate, and serve to carry the water of circulation.

The feed water enters through the pipe *R* and discharges from the tube *H* just above the plate *F*. It then rises and passes to the pipe *N* overflowing to the horizontal plates that are arranged around the pipe *N* in step fashion. As the hot water rises through the pipe *N* it overflows on the plates, which breaks up the hot water and frees the air.

Circulation of the water from the drum *A* through the pipes *K* to the lower part of the steam drum *G* and downward through the tubes *M* through the nozzle *J* and tubes *C* to the drum *A*. The hot water in passing downward through the tubes *M* heats the water in the storage reservoir and this water will be heated also by the flue gases which pass around the outside of the reservoir.

The furnace gases follow the course shown by the arrows. From the back of the furnace the hot gases pass upward in the flue in which the reservoir is located, over the vertical baffle *P*, shown by dotted lines, and then down and out through the discharge flue *Q* to the chimney.

The lower part of the chamber *I* is fitted with a blow-off. The water enters the coldest part of the boiler, and, rising in the reservoir, is heated, serving to separate and deposit the scale-making materials, which collect on the lower plate *F* and can be blown off when desired. This boiler is patented by Albert L. Brueggerman, Newark, N. J.—*Power*, 27 September, 1921.

**THE AIRSHIP DISASTER.**—When the Quebec Bridge failed the general feeling in the engineering profession was that the disaster was due not to lack of competence on the part of the designers and erectors, but rather to a lack of knowledge of the behavior of structures of such size.

In the early days of ore transportation on the Great Lakes there were several failures of steel ore boats which simply broke in the middle and plunged to the bottom like a stone. This, again, was ultimately found to be due to peculiar and, until then, unknown stresses to which vessels of such great length were subjected in certain parts of the Great Lakes. Once this became known, a comparatively simple change of design was made and ore transportation became safe.

There is good reason to believe that the fundamental cause of the airship disaster lies also in lack of knowledge of vital elements underlying the design of large airships. It is, at times, difficult to realize how slight our knowledge of airship engineering really is. We are dealing with structures 600 to 700 feet long, weighing in the air next to nothing. At both ends of these immensely long structures we have operable planes (rudders and elevators) of very considerable size, presenting resistance to the air equal to a pressure estimable in tons, which, with a leverage of some 300 feet, must impose tremendous stresses amidships. What these stresses are we do not know, nor have we either experimental or mathematical bases for computation. This is particularly so, as we do not even know to what extent the theoretically rigid dirigible is capable of flexure.

Such a situation would have been bad enough if we were dealing with materials with whose behavior we are familiar, but we are not. The main resistance parts of the dirigible are constructed of the so-called "duralumin"—an alloy of aluminum and copper, or aluminum and zinc, or all three of them. Duralumin is, however, a new alloy, practically a "war baby," and we have only scant knowledge as to its behavior and next to no knowledge as to its ability to withstand repeated stresses—something of particularly great importance in a structure that is vibrating like a string all the time. In airship design we have therefore to meet unknown stresses with a material of unknown qualities, which would be bad enough in itself but is stupendously aggravated by another circumstance, and that is the very low factor of safety employed in airship construction.

In a bridge, an ore boat, an automobile, generous factors of safety are used wherever there is doubt as to the stresses to which a member is likely to be submitted, because there is no vital gain outside of the cost consideration, which should be secondary in using excessively light members. But this is not so in an airship. If the latter is designed to fly across the Atlantic it must carry a certain weight of gasoline, oil and useful load, and every pound of these supplies reduces by a pound the weight of the metal that can be put into the structure, and hence the factor of safety, with the result that members one-sixteenth to one-eighth of an inch in thickness are by no means uncommon in dirigible construction; and members of such slender dimensions in duralumin, under the tremendous stresses they are called upon to withstand, no longer possess a factor of safety, but rather a factor of daring.

The airship has a certain military value, and in a war structure the lack of sufficient safety may not be considered a vital objection to its employment. For peace purposes the airship can probably be also made sufficiently safe after enough time and money have been spent in experimental work. It may be of interest to note that out of about fifty big dirigibles built so far at least one-third have met a violent end.

It was evidently from such a point of view as that, that the National Advisory Committee for Aeronautics passed a resolution recommending the government to continue its work on dirigibles, and to purchase for this purpose a discarded German Zeppelin. A more thorough investigation of the properties of duralumin, its heat treatment, "ageing," behavior under alternating stresses, etc., might also be of interest, and not for the design of dirigibles airships only.—*Mechanical Engineering*, October, 1921.

ORDNANCE

OFFICIAL TRIALS OF GERMAN ARMOUR PLATES.—Trials have recently been undertaken to test the quality of various types of German armor plates for the purpose of comparing them with plates of corresponding thickness manufactured in this country. The plates were obtained from the ex-German battleship *Baden*, and are therefore thoroughly representative of the German product.

The following table setting forth the results of these trials indicates the marked superiority of British armor plates. In the table the average limiting velocity of penetration for British plates is taken to be 1000 feet per second in each case, and the third column shows the comparative figures for German plates. The shells used at these trials were of similar mark and quality to those used in testing British plates of the same thickness.

Thickness of plate in lb. per sq. in.	Index number representing limiting velocity of penetration	
	British	German
80 Bulkhead plate.....	1000	1000
160 Turret roof plate.....	1000	Less than 955 *
200 Turret roof plate.....	1000	Less than 935 *
320 K. C. armor.....	1000	940
400 K. C. armor.....	1000	Less than 895 *
480 K. C. armor.....	1000	Less than 835 *
560 K. C. armor.....	1000	915

\*In these cases owing to the limited space available for attack, the velocities could not be taken low enough to determine the limiting velocity, the shells, at the velocities indicated by the index figures, passing on practically undamaged, except in the case of the 200-lb. roof plate.

—*Engineering*, 16 September, 1921.

**BRITISH NAVAL CORDITE.**—Questions were asked recently in the House respecting the sum of £106,700 which is being spent on plant for the treatment of cotton silver at Holton Heath cordite factory, near Portland. As the Admiralty will now supply their own cordite from this place, it is intended that all work connected with its production should be concentrated there. During the war risks had to be taken which were unavoidable in the circumstances, and the navy has not the confidence that it ought to have in its cordite at the present time. Hence the anxiety of the Admiralty to have the bleaching and cleaning of the cotton used under their own supervision.—*The Marine Engineer and Naval Architect*, September, 1921.

**ARMY EXPERTS DEVELOP FLASHLESS POWDER, WHICH ENABLES FIRING AT NIGHT WITHOUT LIGHTS.**—Flashless gunpowder, making possible night firing without illumination, one of the recent developments of the Army Ordnance Corps, will be demonstrated at the third annual meeting of the Army Ordnance Association at the Aberdeen proving ground.

Since the invention of smokeless powder, which eliminated the location of guns in daylight, ordnance experts have been working to prevent similar "spotting" at night. This has been accomplished, it was learned to-day. Night firing with guns as large as five-inches have recently been conducted with no more than a momentary dull red glow.

This has been accomplished by introducing substances into the powder which when the gun is fired are volatilized, diluting and cooling the hot inflammable gasses. Salt and chlorine of potash, it is said, are two substances used to eliminate the flash.

Other features of the program include the firing of the "heaviest single unit of ordnance in the world," the recently perfected 16-inch 50-caliber gun mounted on a disappearing carriage. The gun measures 69 feet in length, weighs 340,000 pounds, and requires 850 pounds of smokeless powder to propel its 2400-pound projectile approximately 22 miles.

Another rifle of the same type has been mounted on a barbette carriage, permitting an elevation of 45 degrees, and is expected to have a greater range than any gun now carried by naval craft.

A new and enlarged Browning rapid-fire gun of .50 caliber intended for defensive use against aircraft and tanks will be demonstrated. The ammunition used by this weapon is twice as large as that used in the World War and the rate of fire has been greatly increased.—*New York Times*, 5 October, 1921.

#### MISCELLANEOUS

**THE SPANISH NAVY.**—We have not heard much about the Spanish Navy during the troubles of that country in Northern Africa. Probably this is principally due to the fact that the Moors are not giving warships much opportunity to take a hand in the fighting, and that the services of these, therefore, are not of an active character. Whilst the navy of Spain is only a very minor force as sea armaments are measured these days, it is unquestionably stronger and more efficiently organized at the present time than at any period of its modern history.

The program to which this result is due was framed in 1913. It provided for an expenditure of about £11,000,000, a large proportion of which was to be devoted to the development of the naval dockyards. This work, however, does not appear to have made much progress. Since the war the program has been revised and extended and is now in steady course of materializing. Two additional light cruisers, of 5590 tons apiece, have been added to the list of new construction, together with six destroyers, twenty-eight submarines, and three gunboats. The Spanish naval authorities are manifestly impressed with the great defensive value of the mine.

and they are forming big depots of these weapons, and adapting ships for laying them.

Distinctly the most interesting feature of recent Spanish naval programs has been the disposition to build vessels of a larger size than heretofore. Three battleships have been completed at Ferrol, the *Alfonso XIII*, *Jaime I*, and *Espana*, and two more of a similar type are to be built. These vessels, in point of design, may be classified as minor dreadnoughts. Of 15,460 tons displacement, they carry eight 12-inch guns in four turrets, the midship pair being echeloned, but in such a manner that all the weapons can be fought on a very wide arc of fire.

The speed of these ships, which are propelled by Parsons' turbines of 15,300 s. h. p., is barely 20 knots. Their armor protection is very inadequate; the broadside belting is of 9.4 inch Krupp steel, and the heavy gun turrets are of 10 inch, of the same material. Whilst these Spanish battleships appear to embody the maximum value in collective qualities for their displacement (for they are only 460 tons bigger than our London class), they are assuredly less useful than had they been much faster and more lightly armed; for, as battleships, they are so hopelessly outclassed nowadays that their definition becomes little more than a misnomer. But, as armored cruisers of the same tonnage, they might have been really valuable ships. It is the old story of crowding too much weight of armament into a hull, to the sacrifice of other essential features, so that her resultant low standard of tactical mobility gives her very slender prospects of deriving any advantage from her hard-hitting power.

In their light-cruiser designs the Spanish naval authorities show this same disregard for the essential quality of speed. The *Reina Victoria Eugenia*, launched at Ferrol in 1920, is only good for 25 knots, although she displaces 5590 tons. The *Reina Augusta Victoria*, of 5778 tons, launched subsequently at the same port, will probably prove a little faster. Three more cruisers of the same type are in hand.

In our own C class (or, more strictly speaking, classes) of light cruisers we get a speed of 29 knots on displacements ranging between 3750 and 4190 tons. The *Reina* type carry nine 6-inch guns; the C group five 6-inch guns. We fancy that the five knots extra speed of the British ships would more than compensate for the lesser number of guns in a running action—and the tactics of all modern naval battles are of this character.—*Naval and Military Record*, 14 September, 1921.

**SPANISH SUBMARINES.**—The Spanish Minister of Marine announces that Spain has ten submarines ready for service. The government intend to purchase eighteen others shortly.—*Army and Navy Gazette*, 17 September, 1921.

**THE INDUSTRIAL SITUATION IN ITALY.**—Every effort was made by the Italian Government to avoid the closing of the dockyards at Trieste that had been threatened for some time as a result of the abolition of the subsidies arranged through the Nava decree. The Minister of Industry has arranged a subsidy of 600 lire per ton, which will be granted in the case of ships that were one-quarter constructed on June 30, 1921. Twenty-eight ships will benefit in this way.—*Engineering and Industrial Management*, 15 September, 1921.

**AUSTRIAN MERCHANT FLAG.**—According to an official decree the flag which is to be used in future by Austrian merchant ships is to consist of three horizontal stripes of equal width of which the middle stripe shall be white and the upper and lower stripes red. The height of the flag in relation to its breadth shall be as two is to three.—*The Nautical Gazette*, 24 September, 1921.

**THE RUSSIAN NAVY.**—Even the Soviet Government apparently believes in the Cromwellian doctrine of keeping your powder dry. The Red Army, of course, is chiefly maintained for the purpose of supporting the present régime, and it is more for the purposes of political distraction at home that it is employed on other adventures. The Russian Navy, not being necessary in this rôle, has been allowed to lapse into a condition of neglect and disorganization without precedent in the history of fighting fleets. But apparently an awakening is taking place, and the Soviet Government is beginning to realize that sea power cannot wholly be left out of its calculations.

This, at any rate, is suggested by the negotiations which Russia has opened with a view to regaining various ships of which the British Navy took possession during 1918. These consist of several ice-breakers, which are indispensable auxiliaries to the Russian Baltic fleet, and the five-funnelled cruiser *Askold*, which was such a familiar occupant of Mudros Harbor during the Dardanelles operations. It is very difficult to form any idea of Russian naval strength from a reference to the official text-books, because, although some very formidable dreadnoughts were building when the war broke out, there is no data as to the stage of progress reached in most of these, whilst the condition of dilapidation of the older ships of the fleet renders it impossible to even approximately assess their fighting value.—*Naval and Military Record*, 15 September, 1921.

**THE DUTCH SHIPPING COMBINE.**—It is not quite clear how far the arrangement between the principal Dutch companies is an amalgamation of all interests. The reports speak of their pooling their surplus tonnage. But as the capital of the new organization—which is to be called the United Netherlands Steam Navigation Company—is to be no less than ten millions sterling, it is clear enough that it is to be a very big thing. Moreover, the fact that the companies concerned are thus brought into so close a relationship will make it certain that, whether actually amalgamated or not, they will hereafter work in close union. The *raison d'être* of the operation seems to be a recognition of the fact that at the present time there is not enough profitable employment for all the ships owned by the constituent companies on the routes which they have hitherto traded. They accordingly propose to open up new routes in directions not previously served by them, wherever inducement seems to offer. The six companies concerned are (1) the Royal Netherlands Steamship Company; (2) the Steam Navigation Company of the Netherlands; (3) the Holland-America Line; (4) the Rotterdam Lloyd; (5) Messrs. Phillip van Ommeren; and (6) Messrs. van Nieveldt Goudriaan and Co. The Chairman of the combine is Mr. van der Houven van Dort.—*The Marine Engineer and Naval Architect*, September, 1921.

#### CURRENT NAVAL AND PROFESSIONAL PAPERS

Water Treatment for Boilers. *Mechanical Engineering*, September, 1921.

Reduction Gears for Ship Propulsion. *The Shipbuilder*, September, 1921.

Direction Finding Wireless. *Engineering*, 2 September, 1921.

Electric Propulsion of Ships. *Engineering*, 2 September, 1921.

Coastal Operations. *Journal of the United States Artillery*, September, 1921.

Some Applications of Physics to Ordnance Problems. *Journal of Franklin Institute*, September, 1921.

Lessons for Marines from the Gallipoli Campaign. *The Marine Corps Gazette*, September, 1921.

# NOTES ON INTERNATIONAL AFFAIRS

---

FROM SEPTEMBER 10 TO OCTOBER 10

PREPARED BY

PROFESSOR ALLAN WESTCOTT, U. S. Naval Academy

---

## WASHINGTON CONFERENCE

**MINOR POWERS INCLUDED.**—After consultation with other nations taking part in the conference at Washington, the United States Government on October 4 extended invitations to the Netherlands, Belgium, and Portugal to take part in the conference so far as it concerned the Far East. Belgium was included largely because of her part with the Allies in the war, and the Netherlands and Portugal because of their Pacific colonies and interests. It was decided that only the five principal nations should deal with the question of armaments.

**AGENDA OF CONFERENCE.**—Early in October the U. S. State Department published the following tentative agenda which had been proposed to the nations concerned:

*Limitation of Armament.*—One—Limitation of naval armament, under which shall be discussed (a) basis of limitation, (b) extent, (c) fulfillment.

Two—Rules for control of new agencies of warfare.

Three—Limitation of land armament.

*Pacific and Far Eastern Questions.*—One—Questions relating to China.

First—Principles to be applied. Second—Application.

Subjects:

(a) Territorial integrity.

(b) Administrative integrity.

(c) Open door—equality of commercial and industrial opportunity.

(d) Concessions, monopolies or preferential economic privileges.

(e) Development of railways, including plans relating to Chinese Eastern

Railway.

(f) Preferential railroad rates.

(g) Status of existing commitments.

Two. Siberia. (Similar headings.)

Three. Mandated islands. (Unless questions earlier settled.)

The powers addressed, it was intimated, were aware of the range of matters in the proposed agenda, and there was no possibility that any of the foreign governments would have any misapprehension concerning the scope of the questions. The object of this government in preparing the list of topics was to so arrange and state them that any matters pertinent to the specific subjects might be discussed without limitation in advance, which might make consideration of some questions impossible. As the agenda stand, there is no limit on any question that is suggested for consideration.



**PERSONNEL OF DELEGATIONS.**—The Japanese delegation to the Washington Conference was headed by Prince Tokugawa, President of the House of Peers, and included Baron Kato, Minister of the Navy, and Baron Sidehara, Ambassador to the United States.

The French delegation, it was announced unofficially in October, would consist of Premier Briand, M. Viviani, Senator Albert Serraut, General Berthelot, Marshal Foch, and Admiral Grasset of the Navy General Staff.

Advices from England indicated that there would be six British representatives, including three from the overseas dominions. George Foster Pearce, Australian Minister of Defence, was designated to represent Australia. In case Premier Lloyd George was unable to attend, the English delegation was expected to include Mr. Arthur Balfour and the First Lord of the Admiralty, Lord Lee.

**CHINA REJECTS SHANTUNG PROPOSALS.**—With the idea, it was thought, of keeping the question out of the Washington Conference, Japan in September made proposals directly to China for the restoration of Shantung.

As published by the Japanese Foreign Office on September 16, these proposals appeared to promise practically complete surrender of Japanese control, except with reference to the Shantung Railway, certain mines in which Japan stipulated joint operation, and public buildings and property at Kiao-chau. It was stipulated that Kiao-chau and some other ports should be opened on equal terms to all nations.

On October 7 China published her rejection of these terms, declaring that the Japanese offer was fundamentally unacceptable, and presenting detailed objections to the proposals made. The policy of China was apparently to avoid separate negotiations in order to be able to raise the Shantung question at Washington.

**JAPAN'S NAVAL POLICY.**—Tokio, Sept. 13 (Associated Press).—A conference of the naval and military authorities and the officials of the Foreign Office has decided upon the following basic principles as the limitation of naval armament, according to the Asahi Shimbun:

“Japan has no intention of reducing the strength of her navy independently, nor of suspending the previously arranged building program. But as she has heartily approved curtailment, so as to promote the happiness of mankind, Japan is willing to make efforts to establish some arrangement with the powers.

“Japan believes, first, that it is against the fundamental spirit of the Washington conference that any power should possess superior forces sufficient to secure a decisive victory over any other power or powers; therefore the powers should minimize the scope of armament to the same degree as that of the country having the smallest naval strength among the powers concerned.

“Second, the powers concerned shall not establish any naval base or make any arrangement to serve as naval bases for their navies on the Pacific.”

Concerning the second provision, the Asahi Shimbun says that the naval officers originally suggested that fortified islands in the Pacific should be prohibited, but this was amended as above.

Furthermore, continues the paper, Japan wants to suggest that limitation should be put on future warship construction after a certain year, to be named, because destruction of existing warships or suspension of construction on those building would involve inconvenience. Also the

period for the completion of previously planned vessels should be extended. For example, it is pointed out, the United States should extend her three-year program over a longer period, thereby regulating the augmentation of her naval strength.

UNITED STATES AND LEAGUE OF NATIONS.—Geneva, Oct. 2.—Great Britain and France will raise at Washington the question of the adherence of the United States to the League of Nations. If this comes as a surprise to the Washington Administration it is nevertheless the decision the London and Paris governments have reached.

They do not consider that it will be necessary to add any item to the existing agenda of the November conference, but will bring up the League under the discussion of disarmament, and particularly land disarmament. It is understood that the initiative will come from the British representatives at Washington.

The line of reasoning the Allied delegates will probably offer is that so far as land disarmament goes agreement of the great powers to disarm by no means solves the problem. England and France feel that possession of top-heavy military equipment by small states constitutes as great, if not greater, danger to peace than possession of large armies by the big powers with more poise and more to lose by rushing into war. Quarrels of little nations embroil big nations and thus many a war in history has grown to formidable proportions.

Therefore, they argue, real disarmament must be all embracing and the best if not the only means to assure that it is through the League of Nations for which the small nations have such enthusiasm.

It will probably be pointed out that the successful Republican campaign in America against the League was based most largely upon criticism of the Covenant and not upon the idea of an international association. But thanks to interpretations and constructions put upon it little now remains of the Covenant except the idea.—*N. Y. Times*, 3/10.

## LEAGUE OF NATIONS

ESTABLISHMENT OF WORLD COURT.—The election of judges for the permanent Court of International Justice, as announced from Geneva on September 14, resulted in the choice of the following eleven members: Viscount Robert Bannatyne Finlay, of Great Britain; Charles André Weiss, of France; Dionisio Anzilotti, of Italy; John Bassett Moore, of the United States; Rafael Altamira y Gravea, of Spain; Senator Ruy Barbosa, of Brazil; Antonio de Busttamente, of Cuba; Max Huber, of Switzerland; B. C. J. Loder, of Holland; Didrik Galtrup Gjedde Nyholm, of Denmark; Yoruzo Oda, of Japan.

The four deputy judges selected were Messrs. Negulesco, of Rumania; Wang, of China; Yovanitch, of Jugoslavia, and Beichmann, of Norway. It was arranged that the judges should meet in October at Geneva for organization and election of a president of the court.

WORK OF LEAGUE ASSEMBLY.—The Second Assembly of the League of Nations met at Geneva on September 6 and closed on October 5. Among the matters taken up at the conference may be noted the following:

*New Members Admitted.*—Latvia and Esthonia were admitted to membership in the League, bringing the total to fifty members. The application of Lithuania was held up pending her acceptance of the League settle-

ment of her dispute with Poland. That of Hungary was left until the next session.

*Amendments Made Easier.*—The process of amending the Covenant of the League was made somewhat easier by changing Art. XXVI to read as follows:

“Amendments to the present Covenant, the text of which shall have been voted by the Assembly on a three-fourths majority in which there shall be included the votes of all the members of the Council represented at the meeting, will take effect when ratified by the members of the League whose representatives composed the Council when the vote was taken and by a majority of those whose representatives formed the Assembly.”

*Expenses Apportioned.*—The committee assigned to distribute the cost of the League establishment divided the members into groups, Great Britain and France paying 9.2 per cent each; China, India, Italy, and Japan, 6.65 per cent; Spain, Argentina, Brazil, Rumania, Jugoslavia, and Czechoslovakia, 3.58 per cent; and other nations in proportion down to .21 per cent for the smallest. The budget for next year is 20,750,000 gold francs, 500,000 francs less than last year.

*Registration of Treaties.*—An effort was made to modify the article requiring the registration and publication of treaties in such a way that technical agreements, such, for example, as those in an alliance for military defense, would not have to be made public. This proposal, however, was left to a committee for report at the next session; and it was decided that in the meantime all treaties must be published.

*Report of Armaments Committee.*—The report of the Armaments Committee recommended that all members be requested to furnish data regarding armaments and appropriations for war material, military, naval, and aerial; for the years 1913-1921, with a compilation of their laws relating to armaments. It was further recommended that the Permanent Armaments Commission should continue its study of disarmament and present at the next session a plan for general limitation of armaments in the form of a draft treaty. The Assembly decided that immediate steps toward disarmament could be better considered by the major powers at the Washington Conference.

*No Action in Bolivia-Chili Dispute.*—Bolivia finally withdrew her demand that her dispute with Chili be taken up by the Assembly. A committee of the Assembly decided that the Assembly had no competency to discuss the revision of the Bolivia-Chili Treaty of 1904.

*White Slave Convention.*—An international convention was drawn up increasing passport restrictions for women and minors, as a means of combating the “white slave” traffic. Upon ratification of this convention by any nation, it becomes effective for that nation.

*No Increase in Council.*—A proposal was made to increase the present members of the League Council to ten, of whom five should be permanent and five non-permanent. There was a dispute as to whether the additional permanent member should be given to Spain or to some American nation. No change was made; and China, Belgium, Brazil, and Spain were again accorded representatives in the Council.

*Amendment of Blockade Clause.*—Article XVI, regarding economic blockade against a member resorting to war in violation of the league covenant, was slightly amended in such a way that it was left to the Council to decide when such a blockade should be instituted. The Council was also given power to release any member from the obligation of joining the blockade, if in the opinion of the Council such action would be ineffective or would result in loss or inconvenience to the nation.

*Article X not Changed.*—The proposed elimination of Art. X, guaranteeing members against territorial aggression, was left until the next session. It was the general agreement of the Assembly, however, that the article should not be so interpreted as to make its enforcement compulsory upon all members, nor was it intended as a guarantee that boundaries should remain forever unchanged.

AMERICA ANSWERS LEAGUE NOTES.—At the close of September the Secretariat of the League received from the United States Government fourteen notes briefly acknowledging League communications. These notes were dated at various times in August, 1921, and were in reply to communications from the League dating as far back as February 4, 1921. Criticism appeared in the press over the alleged failure of the United States to acknowledge or take action on League communications relating to mandates, reconstruction of Austria, opium and white slave traffic, and other international matters.

### GERMANY

GERMAN-AMERICAN TREATY RATIFIED.—At the close of September the German Reichstag ratified the peace treaty between Germany and the United States. The U. S. Senate at the same time agreed to limit debate so that the question of ratification should come to a vote in October.

STRONGER GOVERNMENT COALITION.—Berlin, Sept. 21.—A sharp tactical turn to the right made by the Social Democratic Party, still Germany's numerically strongest party, at the Goerlitz convention by an overwhelming four-fifths majority vote makes it practically certain that the German People's Party will enter Germany's present coalition government and that the Social Democrats will re-enter both the German and Prussian governments.

Hence composed of the German People's Party, the Democratic Party, the Catholic Centre Party and the Social Democratic Party, the Government of the Republic will be established on the broadest Parliamentary basis since the outbreak of the revolution, leaving the extreme reactionaries and radicals—to wit the German National Party and the Independent Socialist Party—out in the cold of a weakened opposition with the dwindling Communists a negligible quantity.

The impending entry of the German People's Party into the coalition and the switch to the right by the Majority Socialists will give a decidedly reactionary complexion to Germany's next government, and it weakens correspondingly Wirth's position as radical leader.—*N. Y. Times* 21/9.

### AUSTRIA AND HUNGARY

Early in October, in response to an Allied ultimatum, the Hungarian Government signed a protocol handing over Burgenland in western Hun-

gary to Austria, in accordance with the Treaty of Trianon. In the meantime, however, Hungarian irregular forces in possible strength up to 30,000 held the district in defiance of the authority of the Interallied Mission at Oedenburg, and prevented Austrian occupation.

### GREAT BRITAIN AND IRELAND

INVERNESS CONFERENCE ABANDONED.—To Premier Lloyd George's proposal for a conference at Inverness on September 20, the Irish leader, Mr. de Valera, replied accepting the invitation, but setting forth that Ireland had declared her independence and that her delegates would come "only as representatives of that state." The British Premier replied that negotiations would be impossible on the basis of the formal statement in Mr. de Valera's letter, since there would be an official recognition of Irish independence, and, therefore, an act of treason.

CONFERENCE ON OCTOBER 11.—Following a further exchange of telegrams, the British Government extended another invitation to the Irish delegates "as spokesmen of the people you represent, with a view to ascertaining how the association of Ireland with the community of nations known as the British Empire may best be reconciled with Irish national aspirations." This invitation was accepted in a brief note. Mr. Arthur Griffith headed the Irish delegation of five in all. The British conferees included the Premier, Lord Birkenhead, Sir Hamar Greenwood, Austin Chamberlain, Winston Churchill, and Sir Lansing Evans.

### RUSSIA

RUSSIA AND GERMANY RENEW RELATIONS.—Riga, Sept. 21 (Associated Press).—Official relations between Germany and Russia were reopened at Moscow Monday, when the representative of Germany, Professor Wiedenfeldt, presented his credentials to M. Kalinin of the Soviet Central Committee and a note to Nikolai Lenin, President of the All-Russian Central Executive Committee, at the Kremlin, says a radio dispatch received in Riga this evening.

According to Moscow sources, Russia assumes that, with the arrival of Professor Wiedenfeldt, Germany will greatly extend her commercial relations with Russia. This view is generally held also by neutral and American observers in the Baltic States, who foresee Germany, and not England, for the present playing the leading rôle in Russian trade.

It is stated that on all sides Russia, the Bolsheviki and the anti-Bolsheviki alike agree that at present Russia has little to offer in exchange for goods; but it is considered equally evident that most nations, except the United States, are officially going in for future prospects in the country.

Italy is the latest of these countries. Dr. Bogiano Pico, a trade delegate of the Italian Government, having arrived in Riga on the way to Moscow. He is authorized to conclude a Russo-Italian trade agreement, the main outlines of which already have been prepared in Rome by M. Vorovsky, the Russian representative there.—*N. Y. Times* 22/9.

RED PROPAGANDA CHARGED BY BRITAIN.—On September 20 it was announced that Great Britain had sent a strong protest to the Soviet Government alleging propaganda and political activities, especially in India

and Afghanistan, in violation of the trade agreement. Russia's reply on September 26 was a general denial.

**SETTLEMENT WITH POLAND.**—On September 15 Poland sent an ultimatum to the Soviet Government demanding fulfilment of the Treaty of Riga before October 5. On October 6 it was announced that an agreement had been reached according to the terms of which the Soviet Government promised to begin at once the return of art and other historic treasures to Poland, and to make the earliest possible payment of the first 49,000,000 gold rubles due Poland under the treaty, the payment to be made in raw materials.

**LEAGUE BARS FAMINE RELIEF.**—On September 30 a committee of the League of Nations Assembly reported unfavorably on the plan presented by Dr. Fridtjof Nansen proposing that nations in the League advance £5,000,000 for Russian relief. The unfavorable report was due to the refusal of the principal governments to extend credits.

The International Commission of Relief for Russia, with representatives of eighteen countries including Germany, met at Brussels on October 6, under the presidency of M. Delacroix of Belgium. The commission expressed preference for the American plan of relief as compared with that arranged by Dr. Nansen. According to a Russian estimate, the present harvest yields two billion poods (36 pounds) of grain, of which half a billion is required for planting, leaving a shortage of about 50,000,000 to be supplied to avert famine.

## SPECIAL NOTICE

### NAVAL INSTITUTE PRIZE ARTICLE. 1922

A prize of two hundred dollars, with a gold medal and a life-membership (unless the author is already a life member) in the Institute, is offered by the Naval Institute for the best original article on any subject pertaining to the naval profession published in the PROCEEDINGS during the current year. The prize will be in addition to the author's compensation paid upon publication of the article.

On the opposite page are given suggested topics. Articles are not limited to these topics and no additional weight will be given an article in awarding the prize because it is written on one of these suggested topics over one written on any subject pertaining to the naval profession.

The following rules will govern this competition:

1. All original articles published in the PROCEEDINGS during 1921 shall be eligible for consideration for the prize.

2. No article received after October 1 will be available for publication in 1921. Articles received subsequent to October 1, if accepted, will be published as soon as practicable thereafter.

3. If, in the opinion of the Board of Control, the best article published during 1921 is not of sufficient merit to be awarded the prize, it may receive "Honorable Mention," or such other distinction as the Board may decide.

4. In case one or more articles receive "Honorable Mention," the writers thereof will receive a minimum prize of seventy-five dollars and a life-membership (unless the author is already a life member) in the Institute, the actual amounts of the awards to be decided by the Board of Control in each case.

5. The method adopted by the Board of Control in selecting the Prize Essay is as follows:

(a) Prior to the January meeting of the Board of Control each member will submit to the Secretary and Treasurer a list of the articles published during the year which, in the opinion of that member, are worthy of consideration for prize. From this a summarized list will be prepared giving titles, names of authors, and number of original lists on which each article appeared.

(b) At the January meeting of the Board of Control this summary will, by discussion, be narrowed down to a second list of not more than ten articles.

(c) Prior to the February meeting of the Board of Control, each member will submit his choice of five articles from the list of ten. These will be summarized as before.

(d) At the February meeting of the Board of Control this final summary will be considered. The Board will then decide by vote which articles shall finally be considered for prize and shall then proceed to determine the relative order of merit.

6. It is requested that all articles be submitted typewritten and in duplicate; articles submitted written in longhand and in single copy will, however, receive equal consideration.

7. In the event of the prize being awarded to the winner of a previous year, a gold clasp, suitably engraved, will be given in lieu of the gold medal. By direction of the Board of Control.

F. M. ROBINSON,  
*Commander, U. S. N., Secretary and Treasurer.*

# United States Naval Institute

## Proceedings



The writers only are responsible for the contents of their respective articles

### CONTENTS

	PAGE
A Captain to His Crew.—Belknap . . . . .	1857
Amalgamation as Affecting the Civil Engineer Corps.—Searles . . . . .	1869
Practical Lessons for the American Navy from the Battle of Jutland.—Hinds . . . . .	1877
Officers for Shore Duty Only.—Jessop . . . . .	1885
Sea Scouting.—Smith . . . . .	1901
Psychology and the Naval Officer.—Gilmer . . . . .	1909
Over Seas Expeditions.—King . . . . .	1911
A Bird's-Eye View of Admiralty Law and Practice.—Faust . . . . .	1919
Minutes of Annual Meeting, 1921 . . . . .	1933
Secretary's Notes . . . . .	1937
Professional Notes . . . . .	1941
Notes on International Affairs . . . . .	1985
Review of Books . . . . .	1993
Index to Vol. 47 . . . . .	1999
Information Index . . . . .	1939

Copyright, 1921, by J. W. Conroy, Trustee for U. S. Naval Institute

Entered at the Post Office at Annapolis, Maryland, as Second Class Matter



# WORLD'S ONLY MAKER

Moulded High Frequency High Tension Insulators

POTENTIALS 1,000 ← TO → 1,000,000 VOLTS



Medal and Diploma received at World's Columbian Exposition, Chicago, 1893



REG. U.S. PAT. OFF. & FOREIGN COUNTRIES.  
**INSULATION  
MADE IN AMERICA**

Louis Steinberger's Patents



Medal and Diploma received at World's Fair, St. Louis, 1904



**ARRIVED**



**AIR-GAP TYPE  
INSULATORS**

PATENTED

Radio Frequencies  
Radio Telegraph  
Radio Telephony  
X-Ray Apparatus

Damped or Sustained  
Voltages

Air Gap  
¼" and Upward

Maximum Dielectric  
Strength

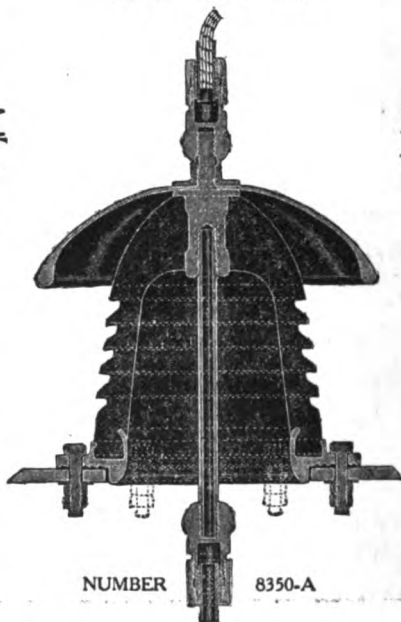

NUMBER 8350-A

**ARRIVED**



**AIR-GAP TYPE  
INSULATORS**

PATENTED

Audio Frequencies  
Transmission Lines  
Sub Station Bushings  
Transformer Bushings  
Oil Switches  
Circuit Breakers, Etc.

Air Gap  
¼" and Upward

Maximum Mechanical  
Strength

**MINIMUM DIELECTRIC LOSS**

**MINIMUM WEIGHT**

Materials so proportioned that:

**MAXIMUM ELECTRIC STRESSES FORMED IN AIR**

EXTENSIVE TESTS under sustained radio frequency operation show:

**NO DETECTABLE HEATING**

**ARC-OVER ESTABLISHED IN AIR**

"ELECTROSE" Insulators are standard with United States Navy and Army and Wireless Telegraph and Telephone Companies.

"ELECTROSE" is made in a number of grades for various requirements, each grade possessing special characteristics.

"ELECTROSE" Insulators—Best in the World for High Frequency Currents, Power Transmission Circuits.

SOLE MANUFACTURERS

**ELECTROSE CO.**

60-82 Washington St.

66-76 Front St.

Brooklyn, N. Y., America

27-37 York St.

1-23 First St.

Vol. 47, No. 12

December, 1921

Whole No. 226

# United States Naval Institute Proceedings

PUBLISHED MONTHLY  
EDITED BY F. M. ROBINSON



U. S. NAVAL INSTITUTE  
ANNAPOLIS — MARYLAND



*Naval Department*

**COPYRIGHT, 1921**  
**By J. W. CONROY**  
**TRUSTEE FOR U. S. NAVAL INSTITUTE**

**The Lord Baltimore Press**  
BALTIMORE, MD., U. S. A.

*The writers only are responsible for the contents of their respective articles*

## CONTENTS

---

A CAPTAIN TO HIS CREW. By Captain Reginald R. Belknap, U. S. Navy .....	1857
AMALGAMATION AS AFFECTING THE CIVIL ENGINEER CORPS. By Lieut. Commander P. J. Searles (C. E. C.), U. S. Navy.....	1869
PRACTICAL LESSONS FOR THE AMERICAN NAVY FROM THE BATTLE OF JUTLAND. By Captain A. W. Hinds, U. S. Navy.....	1877
OFFICERS FOR SHORE DUTY ONLY. By Captain E. P. Jessop, U. S. Navy .....	1885
SEA SCOUTING. By Lieut. Commander G. A. Smith, U. S. Navy.....	1901
PSYCHOLOGY AND THE NAVAL OFFICER. By Lieutenant F. H. Gilmer, U. S. Navy .....	1909
OVER SEAS EXPEDITIONS. By Colonel Edward L. King, U. S. Army...1911	
A BIRD'S-EYE VIEW OF ADMIRALTY LAW AND PRACTICE. By Lieut. Commander W. H. Faust, U. S. Navy (Ret.).....	1919
MINUTES OF ANNUAL MEETING, 1921.....	1933
SECRETARY'S NOTES .....	1937
PROFESSIONAL NOTES .....	1941
NOTES ON INTERNATIONAL AFFAIRS .....	1985
REVIEW OF BOOKS .....	1993
INDEX TO VOL. 47 .....	1999
INFORMATION INDEX .....	1939

## OFFICERS OF THE INSTITUTE

---

### *President*

REAR ADMIRAL BRADLEY A. FISKE, U. S. NAVY

### *Vice President*

REAR ADMIRAL HENRY B. WILSON, U. S. NAVY

### *Secretary and Treasurer*

COMMANDER F. M. ROBINSON, U. S. NAVY

### *Board of Control*

REAR ADMIRAL BRADLEY A. FISKE, U. S. NAVY (*ex officio*)  
REAR ADMIRAL HENRY B. WILSON, U. S. NAVY (*ex officio*)  
BRIGADIER GENERAL GEORGE RICHARDS, U. S. M. C.  
CAPTAIN JOHN HALLIGAN, JR., U. S. NAVY  
CAPTAIN J. A. FURER (C. C.), U. S. NAVY  
COMMANDER JOHN DOWNES, U. S. NAVY  
COMMANDER J. O. RICHARDSON, U. S. NAVY  
COMMANDER H. D. COOKE, U. S. NAVY  
COMMANDER F. M. ROBINSON, U. S. NAVY (*ex officio*)

## PAST PRESIDENTS

---

ADMIRAL DAVID D. PORTER, U. S. NAVY, 1873  
REAR ADMIRAL JOHN L. WORDEN, U. S. NAVY, 1874  
REAR ADMIRAL C. R. P. RODGERS, U. S. NAVY, JAN. 1875—JAN. 1878  
COMMODORE FOXHALL A. PARKER, U. S. NAVY, JAN. 1878—JAN. 1879  
REAR ADMIRAL JOHN RODGERS, U. S. NAVY, JAN. 1879—JAN. 1882  
REAR ADMIRAL C. R. P. RODGERS, U. S. NAVY, JAN. 1882—JAN. 1883  
REAR ADMIRAL THORNTON A. JENKINS, U. S. NAVY, JAN. 1883—OCT.  
1885  
REAR ADMIRAL EDWARD SIMPSON, U. S. NAVY, OCT. 1885—OCT. 1887  
REAR ADMIRAL STEPHEN B. LUCE, U. S. NAVY, OCT. 1887—OCT. 1898  
REAR ADMIRAL WM. T. SAMPSON, U. S. NAVY, OCT. 1898—OCT. 1902  
REAR ADMIRAL H. C. TAYLOR, U. S. NAVY, OCT. 1902—OCT. 1904  
REAR ADMIRAL C. F. GOODRICH, U. S. NAVY, OCT. 1904—OCT. 1909  
REAR ADMIRAL RICHARD WAINWRIGHT, U. S. NAVY, OCT. 1909—OCT.  
1911



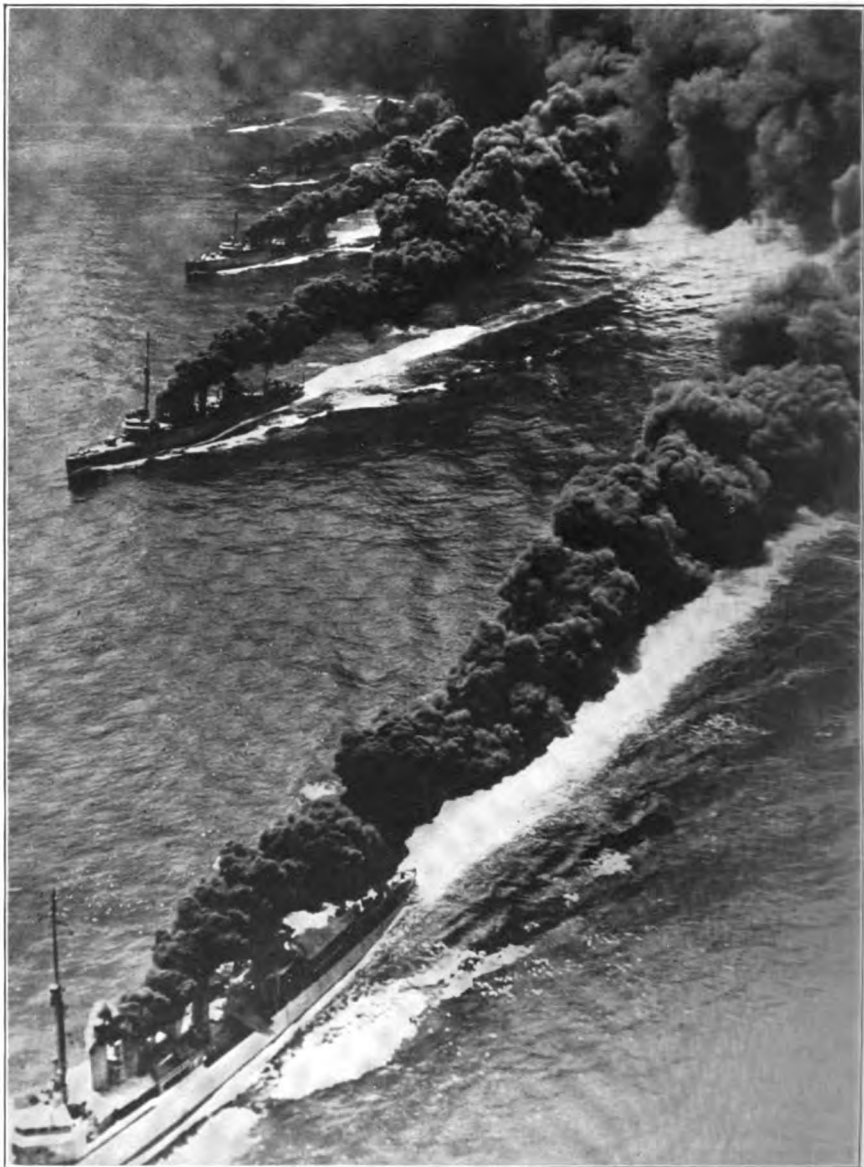

International

**DESTROYERS DEFEAT DREADNOUGHTS IN SHAM BATTLE OFF AVALON, CALIFORNIA.**

# UNITED STATES NAVAL INSTITUTE PROCEEDINGS

---

---

Vol. 47, No. 12

DECEMBER, 1921

Whole No. 226

---

---

[COPYRIGHTED]

U. S. NAVAL INSTITUTE, ANNAPOLIS, MD.

---

## A CAPTAIN TO HIS CREW

By CAPTAIN REGINALD R. BELKNAP, U. S. Navy

---

The following extracts from "The Big D Log," the weekly paper of the U. S. S. *Delaware*, were published during the winter and spring of 1920. At this time the personnel of the navy was at a very low state. Demobilization, high cost of living, high wages outside, and general unrest had taken away so many of the older men that the proportion of new, inexperienced and very young in our crew was unusually large. From her first year of commission, 1910, the *Delaware* had made a fine record for shooting, steaming, and general efficiency. She was one of the always reliable and, through good management being usually ready for whatever might turn up, she was lucky enough to get into many good things, including service with three other American battleships in the Grand fleet in the North Sea, beginning in December, 1917. With this background, the *Delaware* began the 1920 winter training in the West Indies, the oldest among eight battleships. Towards compensating for the great shortage of experienced naval men and with a view to dispel the apparent advantages of the newness and later improvements of the other ships, it was endeavored through a page in the weekly paper, signed by "The Captain," to make the men realize that the man's the thing that counts and to convince each man that his help was important in keeping up the ship's former high standing as a live member of the fleet.



## EVERY MAN'S INTEREST

It is an old navy saying that a ship is known by her boats, and this is as true to-day as it ever was, but there are also other outward appearances by which a ship's general condition is judged—the behavior of her officers and men on shore, her signaling, and the attention paid by individuals to the looks of their ship as seen from passing ships and boats.

Keeping ships together stimulates pride in ship-keeping. It is an inspiring sight, when a smart ship stands into anchorage—everything shipshape aloft and aloft, crew alert, all hands interested in doing it well. But only one man leaning on the rail instead of standing at attention, or lounging in a gun port, or sticking his head out an airpot—any such thing the rival ship sees and it spoils the picture.

Ship's boats have occasionally figured in international incidents. The gig of the U. S. Cruiser *Yorktown*, over 20 years ago, while waiting for the captain in a foreign port, was attacked by a crowd of roughs. More recently, at Tampico, the *Dolphin's* gig was interfered with by local authorities. In all such cases, the behavior of the crew becomes especially important, to uphold the dignity of their ship and flag, at the same time giving no cause of offense, which might aggravate the situation. While among only our own kind, little occurs outside the ordinary, but we should never, on that account, let ourselves forget that boats represent the ship, nor let boat duty slack down, lest we be caught untrained or careless when the test comes.

In navy life, the unexpected often happens. Naval forces are continually being sent to places of disturbance, to restore or maintain order or to assist in some local need. In such circumstances, the behavior of the crew comes all the more into view. Two battleships suddenly left Guantanamo Bay one day several years ago, to assist in feeding and policing the earthquake stricken people of Kingston, Jamaica. Then, one night at Port of Spain, Trinidad, the crew of the old *New York* policed and put out a large fire on shore. Instances of guard duty in local revolutions are too numerous to mention. In one, where the railway system of a whole country was tied up, our naval force soon had it running again.

When men are on duty, whether on board or ashore, there is something or some one at hand as a reminder, but also when not

on duty, we still represent our ship and the navy, particularly on shore. Our navy has traditions extending back nearly 150 years. Much is expected of naval men, and happily they are continually adding to the reputation of their uniform.

Walking one Sunday in Potomac Park, Washington, I saw a man struggling to move his car, parked at the roadside. Dozens of men passed by without lifting a finger. Then my wife squeezed my arm, as four sailors, chancing along, took it all in at a glance, boosted the car out into the road and went on their cheerful way. "Sailor men, every time!" my wife said.

In a foggy and windy night on Long Island Sound, an elderly lady, making her first trip by the Fall River Line, became very fearful, as the boat heaved and creaked and the whistle blew repeatedly. Her daughter tried to calm her but the elder lady refused to go to her room, even to go inside. A naval petty officer, happening to overhear, said: "I am a navy man, ma'am, and know that there is no danger now, but if there should be, I will look out for you myself. I will come to your room and see you safe ashore." He was at once so sympathetic and sensible, the elder lady first consented to go inside and then, upon his taking the number and location of her room and again reassuring her, she retired with complete confidence.

So, let every man who wears the uniform remember to wear it worthily, whatever happens. The navy's record is not made only by a few but by the great majority, to which every man, no matter what his rank or rating, should elect himself to belong.

#### REMEMBER, WE'RE AMERICANS

From every war, some words come down to us which were the utterances of officers or men under the stress of battle or in a tight place, and such words are treasured and carried along to remind us what stuff our predecessors were made of. From our War for Independence, 140 years ago, we have, for instance, Paul Jones' words, with his ship on fire and sinking, "Surrender? I have just begun to fight!" From the War of 1812, when our young navy made a world reputation, Commodore Perry's message after the Battle of Lake Erie, "We have met the enemy and they are ours." From the Civil War, Admiral Farragut's "Damn the torpedoes! Go ahead!"

There will be several sayings of this kind often repeated from the war just over, and one which deserves to be well remembered came from the U. S. S. *Mount Vernon*, Captain D. E. Dismukes, U. S. N., Commanding, on the occasion of her being torpedoed by a submarine off the coast of France. It had been well impressed on the crew that it would take more than one torpedo to sink the *Mount Vernon*. In one of the lower compartments a number of men were seated at mess when the ship was struck. There was a spontaneous rush for the door, which was natural enough on first impulse, since it was the only way to get on deck. But a petty officer sprang before the others and held up a hand. "Remember we're Americans," he called out, "and there was only one torpedo." Instantly all signs of scrambling haste disappeared, each man going quietly and deliberately to his station and, as we know, thanks to her training, discipline, and cool leadership, the *Mount Vernon* returned to port safely, earning commendation for her entire crew.

"Remember, we're Americans!" is a good motto for always. Our navy has had a great deal to do with making the word American mean what it does in the world, and it is for us of the navy to-day to do all we can to keep that meaning up to the same standard as in the past, and strive to carry it still higher.

On the ship's flying West Indian trip last December, when we changed uniform so quickly from overcoats to whites, there was one incident that may be mentioned here not inappropriately. When the second day of strenuous watches in the hot firerooms came around, with only a scant breeze giving but little cool air below, one of our new young firemen, scarcely heavier than one of the coal buckets he was to handle, passing the Chief on his way to the fireroom, said cheerfully, "This time, Chief, I expect to pass out, but I am going down there just the same."

A man of such stuff, of course, will not pass out. He has too strong a spirit. When there is work for him to do his one thought is to do it, because his own self-respect demands that all the work assigned to him shall be done well. No slacking, no loose ends, no easy excuses, least of all, no quitting—rather die first. Read all the history that is written and you will find that is the real basis of what has made the reputation of American naval men. Not just to get by with it, not to pass the buck, not to let George do it—but to be always on the job, to put it across, and to aim to lead the procession.

## MAN OVERBOARD

With another trip ahead of us, between Barbados and Colon, we may wonder whether, this time also, there will be occasion to pick up a man overboard from another ship. Such an event affords a good test of a ship's organization and discipline, showing whether her men are able and ready on the instant, night or day, to make a real rescue. Always provided no harm comes to anyone, such practice as we have had, now three times within a month, is the best kind of training. Action in a real emergency is what tells.

In these days of so much motor boating, the art of pulling a good oar is not so common as it should be. But it takes more than good oarsmen alone to effect a rescue. Careful but rapid lowering, getting the falls and lines properly clear and the boat away from the side, good steering, keen lookout and helpful signaling from the ship, and then safe hoisting—all these are equally necessary. In a word, there must be a good *crew* both in the ship and in the boat. Every man connected with the life-boat should do his best to become skillful in every part of his duties, from the cry "Man Overboard!" until pipe down afterwards.

Remember that in lowering a boat we stake 14 lives to rescue one. As yet we have had only smooth weather. When wind and sea are up, one must think twice before lowering. Very often it depends upon the skill of the men on board whether the decision must go for or against the poor fellow in the water.

When steaming in formation in bad weather, a man dropped from any but the rear ship may sometimes be picked up by one of the ships following. This happened once in 1908, the fleet being on the way from Manila to Japan. It was blowing a typhoon (Chinese for "great wind") and the sea was far too heavy to think of lowering a boat. A man washed off the deck of the *Minnesota* was seen by the *Vermont*, next astern, which steered for him. He caught a line over the bow and came on board before his loss was known by his own ship. Quick work! But don't count on it. You may be in the rear ship, or something may prevent your being seen.

It may be of interest to mention something of the shore life-boat service. Our home coast is well provided with life-saving stations, each manned by a keeper and crew, usually nine or ten all told. These are maintained by the United States Government. Along the south shore of Long Island, a stretch of about 100 miles, there

are 28 such stations. On the Massachusetts coast there are in addition some stations maintained by that state. On the coasts of Great Britain the life-boats are maintained by voluntary contribution to the British Life-boat Association. During the period of the recent war, although sea traffic was much less than in normal times these British life-boats rescued men from shipwrecks, a few at a time, to a number sufficient to man a dreadnought battleship.

These rescues that the *Delaware* has actually made should bring it home to every man of the seaman branch that, suddenly, it may be up to him to save a shipmate's life. Now is the time to do a little thinking about it. Imagine yourself the man in the water, unable to reach the buoy, or just holding on with strength fast failing. Every second the boat can save counts. Next, imagine your own feeling as a member of the crew, if the boat arrived too late. Then imagine it when, by the crew pulling every pound that was in them—through knowing how—the man is reached just in time. Only honest individual effort and good work will do that. Bear all this in mind at boat drill and it will seem more worth while.

#### STAND UP TO IT

A writer in a small monthly paper called "Gems" says: "Why is it that we hang up on the chapel wall the soldier's sword but never hang the yard-stick up? There is nothing discreditable in the yard-stick. It is altogether honorable; the man uses it for his own sake. When he takes the sword, he is willing to give everything, even life itself, at the call of the country, and get nothing of this world's goods in return. The sword, like the cross itself, is honorable, not as an instrument but as a symbol of sacrifice."

Many young men and boys enter the navy in a spirit of adventure, undertaking whatever seamy side there may be as a matter of course, not realizing what the hardest of hardships may prove to be. Bad weather, cold, discomfort, long hours, and hard knocks generally will be taken in good spirit. All share them alike. The real test is in each man's regular day's work. To stand up to this faithfully, week in, week out, never slighting the details even when so familiar as to be irksome, forms the sacrifice in every life.

Sacrifices are made to gain what cannot be bought in the ordinary way but must be worked and sweated for. No boat race, ball game, rating badge, good target score, or other success ever comes without persistent, personal effort at the sacrifice of ease and leisure.

Sometimes it is the ship that celebrates the success, some times it is a man's friends or his family who find satisfaction and benefit in the result of his efforts. But when a sacrifice is thrown away, no one can feel satisfaction, and it certainly is sacrifice thrown away when, by neglect or slight of some minor duty, an otherwise promising man fails to make good.

We should bear in mind that the great satisfaction which we may take in any kind of success comes from the pleasure it gives to our particular friends on board and to folks at home. They, as well as the ship and ourselves, benefit by our faithful efforts, and the thought of them should stimulate our sense of duty. For their sake, if not for duty's sake alone, one should go at his work promptly and vigorously. To do the work cheerfully in this spirit gets it off one's chest quickly and always makes it seem smaller, because it is so soon out of the way—done.

In battle and excitement no effort or risk may seem too great. The blood is up and a man feels on his mettle. But to stand up faithfully, day after day, to a duty that seems insignificant and easily omitted, is a much harder requirement, because tedious and never-ending. In every case, remember who are behind you, interested in what you make of yourself. They always wish you success and in most cases they expect it. One may count upon sympathy and understanding when failure comes in spite of honest effort, but not so when a man quits. That is the very last thing his people expect of him.

In one of the engagements of the Franco-Prussian War of 1870, the Prussians were getting the best of it and were killing all they could reach, giving quarter to no one. Some distance behind the French line, at the entrance to a small village, stood an old French woman whose only son, all that she had in the world, was in the fight. Scanning each fugitive that passed by, she stood there quietly, gazing along the dusty road towards the front, all through the long, fearful hours. With the waning light of afternoon, the sound of firing slackened and the stream of escaping men grew thin, and thinner, and ceased. Darkness fell on an empty road and all was silent. And then, turning after one last look, she cried out: "Thank God! he did not run away."

#### VISOR UP

The hand salute, which passes when members of the naval and military service meet, originated in the days of Knighthood, many

centuries ago. A knight in armor, with helmet on and visor down, covering his face, could not be easily recognized and when two of them met it was customary for the stranger or the junior to raise his visor. The other knight would immediately raise his visor, which corresponded to a return of the salute. When helmets were off, no raising of visors was necessary, just as we do not salute when the head is uncovered. Knights in armor have long departed, but that custom of theirs remains in use, as the military and naval salute all the world over.

Another heritage from the knights is the narrow commission pennant, flown at the ship's main truck. An old-time ship that flew a "Knight's pennant" was thereby marked by the State. She was thus distinguished from other vessels, engaged in private pursuits, which might or might not be lawful and honest—often they were not, from our point of view. When a ship flies an Admiral's flag instead of her commanding officer's pennant, it is a similar survival. The Admiral's flag—which we speak of as a personal flag in distinction from the national ensign—corresponds to the silken, embroidered, gilded, or otherwise gorgeous banner or standard which, in the Middle Ages, marked the presence of a personage of higher degree of rank and authority than a knight.

Knights were authorized—one might say, commissioned—fighting men, just as men-of-war are commissioned fighting ships. On being authorized to bear arms, knights took oath to act always honorably and in righteous cause, never to use their power to do wrong or injustice. In other words, they swore to be clean fighters and to support order and right, which the State ever stands for. So to-day, members of the army and navy, on entering, swear allegiance and obedience, to uphold the laws, the honor, the safety of their country.

The old knights and their customs were the best of their day. They lived and fought for the general good and safety, not for their own gain, and they were always careful to observe the rules and customs of their order. Their place has been taken by the army and navy, but the principles remain the same, and such of the old customs as still survive deserve our cordial observance. Customs do not come down through a thousand years unless they possess real value.

The hand salute belongs to the Services. Outside they do not do it just right—watch them and see; it is not quite natural. But

with us it is the recognition sign of our own kind, for all grades alike. The youngest recruit and the oldest captain make the same salute to an admiral, and he makes the same return to each of them, to captain, lieutenant, and apprentice seaman. Respect and courtesy work both ways, and all ranks and ratings stand on the common ground of sworn upholders of the law and order, the honor, and the safety of the State. Some people think of the salute only as a mark of subordination, but it means much more than that. As the silent password of a great body of men devoted to the service of order and right, it signifies the respect and good will necessary for proper team work, implying a sense of the common bond which unites high and low together in worthy, unselfish purpose.

The history, traditions, and customs of Knighthood centuries ago and of the Navy to-day are marked by dignity, courtesy, and good will among all members. That is something which visitors to ships almost invariably comment upon and admire, the more so the longer they stay on board. Bear these things in mind in connection with the salute—its old historical origin, its same meaning to-day, and its full significance—which is as if you said, on meeting a strange officer, "I may not know you personally, sir, but I recognize you as an officer, and you may count on me to know my job and do it, should we ever serve together."

#### THE MAN'S THE THING

In Great Britain's war with the black natives of Zululand in South Africa, about 40 years ago, although the British troops had the advantage of fire arms and modern army equipment, the black warriors, armed only with spears, kept their enemy's hands full and inflicted losses on them. The British soon found that the Zulus apparently neither slept nor rested. The slightest relaxation of vigilance brought in an attack; any incautious strayer or straggler never returned. By these tactics and the fierceness of their onslaughts, the Zulus so wore upon their invader that what the British had looked upon as an easy campaign soon took on a very serious aspect before it could be turned in their favor.

The Zulus fought to win and they understood the value of discipline and courage toward that end. To any sentry that slept on post the Chief awarded death, as a matter of course, and he was killed on the spot by a spear-thrust. Another custom was related to me by a British officer of that campaign. In one engagement a



certain band of Zulus were reported to the Chief as not having done well. After the fight was over they were summoned before him to answer the charge of cowardice. The Chief ordered them all to be stripped of their arms and shields and then lined up, unbound and free, before the assembled Zulus. A detachment of warriors was then ordered to attack them.

As the deadly spears brought down one after another, the unarmed and defenseless accused men stood motionless as statues, outwardly indifferent to the execution of their mates on either hand. The Chief with his counselors scrutinized them for any least sign of flinching. Seeing none, he ordered the spear-throwing to cease, satisfied that the cowardice charge had been disproved.

Such a test could be used only by savages, but among them the prevalence of treachery, superstition, and panic necessitated extreme measures to obtain high results. Zulu war-training taught men to fight unheeding of odds, and so they would wait in ambush motionless for hours, until some unwary step brought a victim, and with only their spears in hand would charge upon artillery, rifle fire, and bayonets, stopped only by death. It was a striking example of resolute spirit overcoming material odds, illustrating Napoleon's oft-quoted saying that the men's spirit is worth three times the material factor.

As Shakespeare said, "the man's the thing." The spirit with which he tackles his job is what we must look to for success. Fortune is a fickle dame, never won by faint hearts, any more than other fair ladies are. Obstacles and handicaps melt away, lions in the path slink out of sight, when fronted by a hardy resolute will.

Commenting on the winter's athletics, the Commander-in-Chief said that the *Delaware's* high standing in general excellence shows again that results lie with the men, whether the ship be old or new. Number one is *Arizona*, vintage of '16, the newest battleship present, and following close after her comes the oldest, our *Delaware*. Without her crew, a ship is but an empty, silent hulk. The men transform her into a thing of life, her spirit being their spirit. Said the Chief of Naval Operations on coming aboard, "The old *Delaware!* She has always been a good ship."

So, while on liberty you may rightfully let your chest out a bit and wear your *Delaware* ribbon with pride unsurpassed. Her name has been well upheld by her present crew, and you may with

truth assure your friends that, while other battleships may be newer, no ten-year veteran ever had such a record as *Delaware's*, especially as the fleetest of the fleet. Though not yet at the top, we are on our way.

P. S. And don't forget that the *Delaware* counts on your services promptly when your liberty is up. Especially you young ones, remember that you have now become important to your ship, and your "job awaits you there."

#### NO CONSOLATION PRIZE

In the fleet's winter athletic season, which finished with our departure from Guantanamo, the *Delaware's* high standing in general excellence was attained by salting away a few points in nearly every event. Many competitions offered points for second, third, and fourth places as well as for first, and so there was usually hope for some reward, by pulling hard, doing one's best clear through to the finish, even though outclassed for first place from the start by some other team or crew better prepared. Where so many compete, second, third, and fourth places are in reality winners over all the rest of the field. Though not the highest they are still winners. This is the only justification in a military service for giving any reward whatever for any place but first. These lower awards are given to stimulate competition and encourage sustained effort and to emphasize that a game is not lost until it is won. But where only two compete, there is no second prize, no consolation for the loser.

One sometimes hears, "Yes, they won, but we put up a mighty good game." Better let the winner say that of you, when you lose. When you say it of yourself, you are letting yourself down easy in defeat, an attitude that has no place in the navy. A navy must aim only to win, never a thought for second place.

Nelson said one day "If there were 11 sail and we took 10, being able to take also the eleventh, I would not call it well done." What a very superior ship that one would be in which this principle of Nelson's was lived up to all through! Another British admiral when urged by his chief of staff, after one success, to push the campaign with still more vigor and make a quick end of it by one big killing, replied "No, no; we have done very well as it is" and he let a great opportunity pass. Here we have the true expressions, one

of the ever winning spirit, the other of the complacent loser. In the navy, well enough is not good enough—only the best will answer. That is the only spirit to bring victory.

Every one of us, of whatever rank or rating, is in a daily competition which scores for or against the ship according as we do our parts. Each turret, each division, each gun's crew tries to surpass the others, but beyond that, in every line of duty, large and small, there is a higher standard by which the performance of duty is measured. It is a competition between you and the standard. Either you are forgetful, half-hearted or otherwise slack, and you fail, or else you do your work thoroughly well, and succeed. There are no points for halfway—except hope for the future, and hope counts only when followed by actual results. A high score in target shooting, a table of shining mess gear, a part of ship or gun compartment which the captain can't find anything the matter with, a trim and unscarred boat, a neat and tidy uniform, complete—all these things win points for first place. The hard work that goes before is like the training and practice of a boat's crew. The test of the whole ship comes at Admiral's inspection, at target practice, and at speed trials. The ship then gets only the points that her officers and crew have earned. A single lagging oar may lose a boat race. So in a ship, a weak man's work shows a loss to the whole ship. In contrast, the man who is steady, attentive, and alive at his work stands high with his mates, and his influence, as well as his work, helps the ship.

One of the chief signal quartermasters in the fleet wrote a set of "Signal Bridge Commandments" beginning, "When you go on watch, bring your *brains* with you." This applies equally all over the ship. Think what you are doing, bear in mind that it is the ship you are doing it for, and remember what the name of the *Delaware* stands for and has always stood for during 10 years in the fleet. On the Theodore Roosevelt calendar for May the motto is "Whatever your work may be, do it up to the handle, and when you have time, enjoy yourself in games and sport. If you are a real man, you will wish to do them well too."

[COPYRIGHTED]

U. S. NAVAL INSTITUTE, ANNAPOLIS, MD.

---

AMALGAMATION AS AFFECTING THE CIVIL  
ENGINEER CORPS

By LIEUT. COMMANDER P. J. SEARLES (C. E. C.), U. S. Navy

---

Among the numerous papers which have appeared on the question of amalgamation of the staff corps with the line, there has been but little mention of one corps which in itself is not directly connected with ship construction, or ship operation—the corps of civil engineers. It is the intent of this article to discuss the effect of amalgamation upon the line officers, and upon civil engineers, and the resultant effect upon the navy as a whole. The writer is of the opinion that amalgamation with the consequent attempt of line officers and civil engineers to perform reciprocal duties would not be desirable. The two professions are so different, and the work of both so varied that it is difficult to master one without taking thought of the other, and the attempt to combine both functions in one person or group of persons would inevitably tend to mediocrity in both.

By Navy Regulation, the Bureau of Yards and Docks has cognizance of the design, construction, repair, upkeep and operation of practically all public works and public utilities of the navy. While these do not quite include cabbages and kings, alleged to have been discussed by the Walrus, they cover a wide range, from aqueducts to wheels, dry docks to radio towers, and from dams to mules (not the same “dam” as commonly connected with mules). Practically all building work in navy yards, except shipbuilding, is carried on by civil engineers. (This does not, however, include shop manufacturing.) Buildings, railroads, pavements, wharves, dry docks, shipways, etc., are designed and constructed by the Bureau of Yards and Docks, which also handles care of grounds, janitorial service, chauffeurs, etc. The work is almost entirely of an engineering nature, and in order to carry it out

properly, the members of the corps should be civil engineers. There are certain exceptions to this in the case of mechanical and electrical engineers, who are more largely concerned with those particular branches, but in general civil engineering duties prevail, duties which are entirely different from those of the average line officer, and for which considerable education and experience are necessary for success.

The Bureau of Yards and Docks is of long standing in the navy, and with it have been connected some of the illustrious names of naval history, for, from its inception until a comparatively few years ago, the Chief of the Bureau was selected from the line. One point scored for amalgamation, you say? Not at all, for the corps itself was composed, not of line officers, but of civilian civil engineers. Men were employed, who before, during, and after their connection with the navy, made their names famous in the engineering records of this country. They were few in number, about half a dozen, not becoming officers, having no rank or official recognition, but merely accepting such positions while retaining their civilian status. They were stationed at navy yards where they had no military duties or connections, but were purely concerned with engineering projects. This situation lasted until the eighties, when, due to the efforts of Rear Admiral Endicott, the civilian civil engineers were commissioned, and were eligible for the position of Chief of Bureau.

To-day, the corps numbers 106 members, distributed throughout the various grades, and has an authorized strength of 115. The source of supply has been twofold: (1) Certain Naval Academy graduates have been selected, and after a two-year course at the Rensselaer Polytechnic Institute, have been transferred from the line; (2) other members have been commissioned who possess an engineering degree, have had 18 months' experience in construction work, and pass a professional examination. In only a few instances have line officers been assigned to civil engineering duty, and most of these were civil engineers by profession, and reserve line officers during the war. All of this leads to the question of the effect which would be produced by amalgamation.

First, the subject will be considered from the standpoint of the civil engineers. In general they are not qualified for line duty. The Naval Academy graduates have had certain line experience, and would be of some value on board ships. The writer, for

example, had three years of sea duty, ranging from junior divisional officer on a battleship, through division officer on a gunboat, to gunnery officer on a cruiser. This experience occurred from 1913 to 1916, but due to widely changed conditions, much would have to be learned in the event of future sea duty. Most of the Naval Academy graduates in the corps have not had the opportunity to keep acquainted with the late developments in fire control, marine engineering, etc., and while they may have kept up their interest in such subjects, they are, of course, years behind their classes in experience, and would remain behind for a considerable time. While their classmates have been learning and practicing line subjects, they have been learning and practicing civil engineering, and this naturally is not conducive to line efficiency.

The civilian appointees have, in general, had no sea experience, and their transfer to the line with line duty would necessitate their taking up an entirely new profession, in which, whether or not they had an aptitude, they would be far behind men of same age who had followed the sea for years. In an attempt to make a Jack of all trades, there probably would result an inferior civil engineer and an inefficient line officer. Both the Naval Academy graduates and the civilian appointees are now by profession civil engineers, and any attempt to change or modify their profession would result in a loss of efficiency. They have had several years in technical schools, and have had years of experience, and are neither desirous of nor qualified to jump into a new line of work. They are competent to perform their present duties, but might not be so successful in event of a change. And all who favor amalgamation must consider what place is to be occupied by present members of the corps, for it is not assumed that they will lose their commissions. The line must consider whether or not they want these men at sea. They are few in number it is true, but the ships to which they would be sent would be handicapped for some years, not because of a deficiency in the men themselves, but because they would be of little value until they learned a new profession.

From the standpoint of the line officers, somewhat the same situation occurs. They have had line education and line experience, and are neither desirous of nor qualified to change their profession. In order that they could successfully handle civil engineering problems, they would need a college course and some years of experience. At the end of this period they would go back to sea, behind

their classmates in line experience, would have to work twice as hard to catch up, and at the end of a tour of sea duty, their minds would be a jumble of both professions, with the result that they would be master of neither. How many line officers would take up civil engineering if under the conditions described? When shore duty arrived the energetic, active, ambitious men would prefer a post graduate course in some line subject; ordnance, radio, or the like; the lazy men would look for soft snaps instead of two years' hard study, and as a result the corps would be filled by men who had not made good in the line. At present, transfers occur when line officers feel or show an aptitude for the corps. If amalgamated, they would be replaced by misfits, and no one will dispute that the duties of the corps can be carried on better by the present staff of specialists than by the offcasts from the line. The best of the line would remain in the real line, the worst would infest the corps, with a result that a large portion of the shore stations would lose their present efficiency.

The point may be raised that under a new system, the present specialists will be retained for shore duty only. This will not alter the situation. The corps at present is of such strength that if all members were retained, only a few line officers could be used. These few after a tour of sea duty would be out of touch with engineering developments; just as mentioned before, a civil engineer cannot keep in touch with modern ship appliances. They would erupt into a developed organization, and by the time they had found a niche, it would be time for another tour at sea. Back and forth they would go, unlearning one profession to learn another and vice versa, until they would end by being master of neither. It would still fall to the specialists to carry on the work, under constant handicap of having to command or obey men of another line of work. How many navigators or gunnery officers would care to have as ship's executive, an officer who spent half of his time in the public works departments of navy yards, and how many commanding officers would care to have civil engineers as divisional officers? Similarly, how many commandants would care to have a good navigator as public works officer? In no case would satisfaction be assured, for neither profession could be thoroughly mastered. It is felt that at present the corps is efficient, for the men who compose it are able, keen and competent. The writer is not handing bouquets, for he attributes the same to the line and to

other corps. But ability in both endeavors can seldom be secured, and in event of amalgamation a loss of efficiency is certain to occur.

It is frequently argued by the proponents of amalgamation that while staff work is more or less specialized, yet the officers are mainly executives with the detail work handled by assistants, and thus the line officers having equal executive ability could equally well handle any department. This is only true to a certain extent. The civil engineers are both executives and specialists. For executive work, matters of policy, etc., in some instances but a slight knowledge of engineering is necessary. Routine paper work could usually be handled by any one. In these cases a line officer would be competent to act. But in a majority of questions that arise, at least a knowledge of the broad principles of civil engineering is necessary, and frequently a detailed expert's knowledge is essential. Not all design work is handled by draughtsmen. It is true that draughtsmen, aides, etc., put through a large amount of design, but all except the most simple plans are checked by a civil engineer. Very frequently the civil engineer is himself the designer of a structure. Very few members of the corps would entrust to a draughtsman the entire design of a dry-dock, complicated crane, or any other of a thousand and one things within a civil engineer's purlieus. Neither would a navigator rely on a quartermaster's sights. Assume a line officer with several years' sea duty after leaving the Naval Academy, two years in a technical school, and two or three more years at sea. Could he handle designing? And this, I emphasize, is essential. The civil engineer must be able to do himself, what is required in design from his assistants, and furthermore he must frequently actually do it himself. Line officers could issue orders but they could not be certain of their being carried out properly because they would not have the necessary technical knowledge to permit them to know when work is satisfactory. And how many would want to bear the responsibility of work over which they had no real control or knowledge?

One point which would occasion difficulty would be handling enlisted men and handling civilian labor. The writer has done (or at least tried to do) both, and is thankful that a change from one to the other is not to occur again. Each must be handled in a different way, and each presents its own special problems. A man may be an expert with one but hardly with both, and where a change is to occur every two or three years, trouble is liable to happen.



One has "esprit" and the other "union spirit," both excellent but different, and requiring different methods of approach. This is given as one of the more or less secondary problems to be met, although in some cases the success or failure of a public works officer depends upon the efficiency of his yard labor.

One of the points for amalgamation, not often mentioned, but much thought of, is, that it would send the shore going "waffle tails" to sea, and give the line officers more chance of regular shore duty. True. But this could be done in a more proper way, by making a line officer's shore duty strictly line business. Has the navy so many ordnance experts that the number of post graduate students in this subject could not be doubled? More inspectors of engineering material could be used. These two are mentioned as indication. Regular shore duty should certainly be assured, but why in a position for which line officers are not qualified?

One opinion, rather digressive, the writer would like to express. He believes that civilian appointees to the corps of civil engineers should at some early period be given six months to a year at sea in order that they may get acquainted with the line, discover and appreciate the line viewpoint, and in general find out what the navy is for and what it's all about. This would produce closer sympathy with each other's aims, and tend to more cooperation. This does not mean that civil engineers are to become line officers but merely that they may be imbued with the navy spirit and learn to belong to the navy.

A serious question arises in the problem of promotion if amalgamation occurs. Suppose a civil engineer with the rank of commander is due for promotion in the corps. He is compared with other men of his profession, and if qualified is advanced. But suppose he has spent 15 or 20 years in the corps, and is due for promotion immediately after amalgamation. He would be doomed, not because of any prejudice, but because he could not qualify as captain in the line. Also a present line officer who took up the specialization would lose. He would probably be passed over in favor of the all round sea going man. Rightly so, for the former would be mediocre, and the latter unhampered by years of digression would be an expert in his profession. Again I ask, what class of line officers would specialize? Only those who could not make good in the line itself. Sooner or later construction work would be carried on by misfits and offcasts with a certain loss of efficiency.

To-day the members of the corps take just pride in their work to an extent they could not approach if that pride were divided between two objects. One year proud of being public works officer; the next year proud of being first lieutenant; the next year proud of God knows what.

There is not on the part of any members of the corps a desire to exaggerate its importance or necessity. We realize that the line is paramount. Nothing is clearer than that "hits per gun per minute" is the essential of the navy and that everything else is secondary. We aim to serve the line and in doing so aid is not accepted always in the spirit in which it is given. "Ich dien" is the motto of a family proud of its position, and it might also be the motto of the corps, proud of its work. We serve, and ask in return due recognition that only by continuous and uninterrupted service can we continue our successful work.



U. S. NAVAL INSTITUTE, ANNAPOLIS, MD.

[COPYRIGHTED]

---

PRACTICAL LESSONS FOR THE AMERICAN NAVY  
FROM THE BATTLE OF JUTLAND

By CAPTAIN A. W. HINDS, U. S. Navy

---

Although thousands of pages have been written about the Battle of Jutland, no apology is needed from a naval officer in writing for a service magazine on this important subject if his writings clear up any obscure points in this most complicated battle.

Many officers, who spend a lifetime in military service, never take part in a great battle; fewer still ever engage in a sufficient number of battles to gain, from personal experience, the amount of strategic and tactical knowledge necessary to fit them for leadership.

Napoleon probably fought more battles than any other great general, and one might think he had enough personal experience to furnish the basis for his profound knowledge of military affairs—yet, while the world thinks of the great French Emperor as a military wonder, Napoleon attributed his marvelous success in war more to a good memory than to flashes of genius. At some critical point in a campaign or battle Napoleon merely had the good sense to apply a sound principle, already tried out by his predecessors, in the situations he found confronting him.

In the study of history pertaining to the naval profession we have to search through masses of detail to find important points and principles, just as Napoleon studied the history of Alexander, Cæsar and Hannibal for the maxims which stood him in such good stead in the many wars he waged in Europe.

Thousands of pages have been written on the life of the world's greatest seaman, Admiral Nelson. There is such a mass of Nelsonic history that those of us with poor memories read and forget—yet even those afflicted with the shortest memories gain, by reading the naval history of Nelson's time, a rough idea of the outstanding characteristics of the hero of Trafalgar, and find a few principles for use in modern war.

While the tactics and strategy of Nelson have been studied for over a hundred years, the Battle of Jutland is far more complicated than the whole of Nelson's war experience, and it will take many years of faithful study to prepare us to reap the benefit of all the professional data furnished by this great sea fight. No better indication can be found of the intricate character of the struggle between the British and German fleets in the North Sea on 31 May, 1916, than the great number of bridge and W. T. signals sent and received in the Grand Fleet during the interesting period between the late afternoon of 30 May and midnight of the following day. During this time the British fleet sent and received, on the average, a message every five minutes.

The importance of the Jutland Battle to the naval profession is accentuated by the fact that it is the only naval engagement in which practically all types of modern fighting ships were used. With the exception of submarines, every type existing at the time took part in the battle, and, if we consider the whole strategic plan of the commander of the High Seas Fleet, we shall see that even submarines were used. Sixteen of this type were in use during the operation, stationed off Scapa Flow, Moray Firth, the Firth of Forth and north of Terschelling Bank, and it is interesting to note that these undersea boats had, as one part of their dual mission, the supply of information to Admiral Scheer. A large number of dirigibles were to be used in observing the movements of the British forces, but under the plan, if reconnaissance from the air proved impossible, the U-boats were to be used as the advance scouts of the fleet. As it turned out the weather prevented the use of air scouts, and the submarines furnished to the commander of the High Seas Fleet at least three important reports of movements of British forces.

There is food for thought here. Where a submarine stands periscope watch, steaming so slowly that no "feather" is shown, or balancing and making no headway, the periscope is very difficult to see. If, then, the mission of the submarine is purely to gain information and it makes no attack to betray its presence, its use on scouting duty seems promising. Once discovered the value of the submarine in service of information will disappear, for destroyers will force it under and then its low speed will usually prevent it from regaining touch with the enemy fleet.

While on the subject of scouting, it seems rather strange that, although Admiral Scheer contemplated the use of dirigibles and actually used submarines for strategic scouting, no strategic scouting was done by the British fleet. Both the commander-in-chief and the commander of the battle cruiser fleet were informed on 30 May by the Admiralty that news pointed to early activity on the part of the German fleet, and later on, during the same day, received the following instructions: "You should concentrate to eastward of Long Forties ready for eventualities." The commander-in-chief then gave orders for the sweep to be made in the North Sea and appointed rendezvous for both the battle cruiser and Grand fleets at 2.00 p. m. the following day. The British fleet had 34 cruisers and 9 battle cruisers as opposed to 11 cruisers and 5 battle cruisers of the Germans. It seems that some cruisers at least could have been safely detached to scout against the enemy movement through the known swept channels leading out of Heli-goland Bight, yet, no scouting was done at any considerable distance from the battle cruiser or Grand fleets. Was it feared that British scouts sent out well in advance would cause the High Seas Fleet to return to its base? Of course the American Navy has no scouts as compared to the other two leading sea powers, but we may have a well-balanced fleet in the future, so strategical scouting at a good distance from the main fleet is a matter that should receive consideration.

The writer is attempting to bring out only the outstanding features of this battle, so wherever events ran along in their normal course they will not be subjected to comment; we are trying to touch upon only the points worth remembering.

It will be convenient to divide the battle into the three phases into which it is usually divided and then, concerning each phase, ask ourselves this question—what can we learn from this part of the action?

FIRST PHASE. BATTLE CRUISER ACTION

The forces engaged in the battle cruiser action were:

BRITISH.	GERMAN.
4 Battleships.	No Battleships.
6 Battle Cruisers.	5 Battle Cruisers.
14 Light Cruisers.	5 Light Cruisers.
27 Destroyers.	32 Destroyers.

This part of the battle was a normal gun-action with the usual torpedo attacks by destroyers and light cruisers and with the normal fight to be expected between these types. Notwithstanding the great superiority of the British ships, the German battle cruisers suffered but little damage, while two British battle cruisers were sunk.

Admiral Jellicoe ascribes the rough handling of the more numerous British capital ships in this phase of the action to these advantages in favor of the Germans: (1) Heavier armor; (2) a better delayed-action fuse; (3) armor protection above the main deck. Others seem to think that lucky shots sank the *Indefatigable*, the *Queen Mary* and the *Invincible*. As the Germans kept sinking battle cruisers all the afternoon, it seems more like superior marksmanship on the part of the Germans than anything else. Those of us who are lucky enough to have had much experience in battleships realize how complicated the fire-control problem is. The absence of *one* officer or man may vitiate the whole fire-control drill. From our knowledge of the willingness of the Germans to work, it is not difficult to believe that they spent more time on fire-control drill in pre-war time than was spent in either the British or the American navies. Was not the better German shooting in the battle cruiser action the simple reward of more drill when preparing for war? If so the lesson is simple.

It is generally admitted that the Germans were ahead of the rest of the world in range finders at the beginning of the war, just as they were in advance of all other navies in the construction and handling of submarines. They had better optical instruments than the rest of us and, in consequence, they hit with more salvos early in the fight, than the British. The fleet that can land the first salvo has a marked advantage. The answer here is not so easy. There are two ways to keep abreast of other navies in any type of ship or in any kind of material. The first is to spend time and money in investigation and experiment; if the navy had the money to do this we would not admit that any other nation could excel us in anything—but the wave of economy sweeping over the country will leave the navy with little money for experiment for a number of years. The other way is to spend money to find out what other navies develop; we can never hope to do this, for the money spent would have to come from a *secret fund*, and the

average Congressman is not willing to vote for a fund where he cannot see "in black and white" what the money is spent for. For the remedy we must depend on our high naval officials in Washington and a Secretary of the Navy sufficiently strong to be able to convince Congress of the necessity for spending money both for experiment and for information as to the progress our possible enemies are making. These remarks also apply to the shells for our guns and, in fact, to all the material that goes into the makeup of any kind of implement of warfare.

### THE MAIN FLEET ACTION

The first thing that strikes one on a study of this part of the engagement is that the battle fleet was 18 miles from the rendezvous made for it by the commander-in-chief for 2.00 p. m. on the day of the battle. Of course, hind sight is clear, yet there was every reason to believe the High Seas Fleet was out and, as this was to be a *coordinated* use of the whole fleet, had the commander-in-chief any right to be an hour's run from his own appointed rendezvous? The whole battle fleet lost an hour in the examination of trawlers, when another hour of daylight in the engagement might have brought quite different results. The lesson for us is to "stick to the plan."

"Be perfectly clear in your own mind what you want to do, and then carry it out to the letter."

The reports made to the commander-in-chief concerning the position of the High Seas Fleet were conflicting to a degree. In Admiral Jellicoe's report concerning his doubts as to how to deploy, he writes: "The conflicting reports added greatly to the perplexity of the situation, and I determined to hold on until matters became clearer."

The stumbling block of the British commander-in-chief was lack of accurate information. The damage done by the lack of this information was intensified at two points, first it delayed the deployment—second, later on in the action, the British battle fleet lost touch with the Germans because Admiral Jellicoe did not know the German fleet had turned away. The first lack of information cost the British a loss of 16 minutes, the second a loss of about 20 minutes and, as Nelson said—"Time is everything. Five minutes makes the difference between a victory and a defeat."



It is quite naturally a difficult matter for a ship to keep accurate record of her position, with reference to the flagship, during a hot engagement where there are numerous changes of course and perhaps even zig-zagging; but the results of Jutland show the vital importance of accurate navigation when approaching for battle and even when engaged. If the positions of reports are misleading, the commander-in-chief is hopelessly blinded.

The necessity for efficient tactical scouting, prompt and accurate reports and the charting of all incoming information seems to be far and away the most important of our lessons from Jutland.

The next event of importance on the British side was the "turn away" by the British battle fleet to avoid torpedoes. The "turn away" or the "turn towards" torpedoes to clear them is a thing that can only be decided by the commander on the spot. That no commander could be justified in entering a known torpedo area with capital ships is certain. The main point for us, however, is this—Admiral Jellicoe's light cruisers and destroyers were out of battle position when the torpedo attack was made on the battle fleet; they were out of position on account of the deployment and the four point turn to starboard (by divisions) to close the range. When we have built our light cruisers can we keep them and our destroyers in battle position when deploying the fleet or when changing direction in battle?

The other most interesting feature of the main fleet action was the three reversals of course made by the High Seas Fleet while engaged with the enemy. Our battle theory, up to the World War, was that such a thing would be disastrous. Even rank changes of course during a fight were to be shunned to avoid a "knuckle," danger from partial cap, and to keep clear from a further complication of the fire-control problem, too complex at best. In this connection zig-zagging was resorted to both by the British and the Germans in the battle cruiser phase of the action in order to derange the enemy fire delivery. Scheer's reversals of course under protection of a torpedo attack by his destroyers and smoke screens from these vessels show how incorrect were our old conceptions as to the danger of making a rank change of course while under fire.

Our lesson from this part of the battle will come from a closer study of smoke screens. The commander-in-chief will need to have handy for use on his plotting sheet some kind of a smoke diagram

giving the resultant form of the screen with the wind at various angles with his course, taking into account also the speed of the smoke screen layers and their distance from the battle formation. I believe it safe to say that much experiment is needed along these lines.

### THE NIGHT ACTION

The official dispatches of the Battle of Jutland show the last flag signal to have been made at 9.30 p. m. 31 May, and the first hoist next morning at 2.30 a. m., thus giving the duration of darkness.

This phase of the battle again shows the necessity for accurate knowledge of all ships' positions with reference to the rest of the fleet. The sketches made from a study of the battle data by Lieutenant Commander Frost show—(1) High Seas Fleet generally west of the Grand Fleet at 9.30 p. m., distant about 10 miles; (2) head of High Seas Fleet about west-northwest of the British battleships at 10.30 p. m., distant about  $7\frac{1}{2}$  miles; (3) by 11.30 p. m. the High Seas Fleet bore about north-northwest from the British battleships, distant about 9 miles; the German fleet was now heading off to the eastward, crossing Jellicoe's track (well astern) and at 2.30 a. m. the High Seas Fleet was about 30 miles north-northeast of the Grand Fleet.

The Grand Fleet was fairly well concentrated with the light cruisers and destroyers in general about 5 miles astern, and the battle cruiser force about 15 miles off to the westward. The High Seas Fleet, according to a track chart signed by Admiral Jellicoe, was badly scattered; the tracks of the *Westfallen* battle squadron, *Deutschland* class, and the *Kaiser* and *Konig* squadrons are 5 miles apart. It is inconceivable that, when the relative remaining strengths of the two fleets are considered, the British commander-in-chief did not desire to renew the action at daylight on 1 June. The opportunity to renew the action was probably lost on account of lack of information—possibly the information that came in from contacts was not promptly and efficiently charted for use of the commander-in-chief. It seems *most probable* that if the information of contacts had been promptly plotted, the general course and speed of the High Seas Fleet would have developed early enough so the British fleet could have still interposed at Horn Reef between the Germans and their base. The German fleet was

about 17 miles west-northwest of Horn Reef light ship at daylight on 1 June.

Our lesson from the night action is that tactical information must be given promptly and accurately and that it must be plotted quickly and correctly; the work of the plotting party may spell victory or disaster.

[COPYRIGHTED]

U. S. NAVAL INSTITUTE, ANNAPOLIS, MD.

---

OFFICERS FOR SHORE DUTY ONLY

By CAPTAIN E. P. JESSOP, U. S. Navy

---

Glittering generalities, like epigrammatic utterances, quite frequently by their apt expression carry far more semblance of truth and basic fact than analysis will bear out, and, as a result, those who seldom analyze or are not interested particularly in the subject discussed, accept such utterances at their face value and thereby blind themselves and those whom they influence to the realities of the case.

Such a condition, it appears to the writer, is shown by the service's placid acceptance of essays and articles having to do with specialization. That the subject is vital to our future success in a naval way seems not to have seriously disturbed the even tenor of our thought, when in reality there is no more important subject for our earnest consideration to-day than our attitude toward specialization and the methods which should be used to accomplish our needs in that line.

The pro-specialists seem to be on the increase in the service, although they still are in the minority, and no one would seek to discourage them utterly but only to control them and guide their footsteps so as to give us the kind of specialization that will be of real use and not act merely as an augmentor of corps or class animosities and disagreements.

None of the articles which have so far appeared have attempted to describe what kind of specialist is needed for naval use, and while it is probable that each of the writers had in the back of his mind some idea of what kind of a specialist he was talking about, it is not without the bounds of possibility that such an idea was in a very vague state, which would account for a great deal of the indefiniteness and lack of instructive information in the various papers.

When the term "specialist" is used, one has in mind an individual who knows more on some one subject than the average indi-

vidual who has to use the particular art in his business. In other words, it indicates a particular knowledge where the average individual has only a general knowledge. Therefore, in our service, it has been our habit to designate certain individuals from among the younger generation to take certain designated postgraduate courses to form a foundation for various specialties. These schools include courses in naval construction, electrical engineering, steam engineering, and ordnance.

The selection of young men for these various postgraduate courses, with the exception of those selected for naval construction, is rather loosely made, since the young men designated are permitted to apply for the designation, and the appointments are made from these. The average young officer, who is ordinarily bright and passingly energetic, can get sufficient recommendation from the officers with whom he is working to make a fair showing as to his fitness for appointment to the postgraduate course. Frequently, however, and quite properly, the number assigned each year to postgraduate courses is much greater than the number required to fill any particular specialist class which the service might need, so that a weeding out of the less fit is always possible: but it is questionable if much weeding out is done.

Having completed the postgraduate courses, all the graduates except those assigned to naval construction are sent to sea, and they, from then on, have recurring terms of sea and shore duty until they come to command rank, when, if they have applied and been assigned for engineering duty, they are relegated to "engineering duty on shore only" for the rest of their natural lives, unless they happen to be ordered to sea as fleet engineers. Those who are given a postgraduate course in ordnance do not have this "for shore duty only" tag applied to them, but, quite the reverse, they continue up through the ranks doing their recurring terms of sea and shore duty.

As is well known, the naval constructors do not go to sea after their appointment to the postgraduate course, except as they are called upon to go on trial trips or as attachments to the admiral's staff of the fleet.

It does not appear to the writer that such procedure can, with the wildest stretch of the imagination, be expected to produce the kind of specialists which the navy is in need of. There would appear to be two basic reasons for this: (a) The navy is approxi-

mately 75 per cent an operative and 25 per cent a building and repair problem. (b) Specialists who depend upon their work for a livelihood, and the monetary return from whose efforts fluctuates with their ability to please their clients with their work, are usually amenable to a suggestion from those who have to operate the product of their especial training; in other words, they meet the conditions imposed by their clients as far as it is possible to meet them.

Considering the first reason, due to the fact that the navy is to such a large extent an operative problem, the relegating of our specialists in construction and repair and our specialists in engineering to "shore duty only" is, to say the least, a peculiar method of maintaining specialists for our purposes. While appreciating that the construction corps of the navy seems to honestly believe that a constructor can learn little by recurring tours of sea duty, yet it is difficult to see on what they base any such belief. It is notorious that a ship turned over from the builders to the operating navy is practically never complete and is almost never completed. In other words, there is a great deal of evolution in arrangement and in equipment which goes on from day to day and the necessities for which are made evident by observation. Consider, for instance, the item of ventilation in ships. The ventilating system is designed, laid out and installed by the construction corps, and supposedly, theoretically each compartment of the vessel received its proper amount of calculation, and the amount of ventilation provided supposedly bears proper relation to such computation. That vessel is put into commission and taken to sea, and from that time on, 75 per cent of her time is spent in operation, and sea-going conditions immediately suggest changes. The ventilation as installed does not do what the calculations stated it would do. Recommendations are made for these changes, and it has been our experience, and it is not believed that the constructors themselves will question this, that the acceptance of such recommendations has in most cases been slow, and in many very notable cases the recommendations have not been accepted at all.

The same thing is true of all other items on board ship for which the construction corps is responsible, whereas if each first-class ship had a naval constructor on duty on the ship in any one of several capacities, he would be a representative of the Bureau of Construction and Repair, whose special training in naval construc-

tion would so strengthen such recommendations as to cause at least a fair percentage of them to receive proper attention.

In the realm of engineering we are rapidly approaching the same condition, as we are building up a corps of engineering officers who, upon arrival at the approximate age of 35, cease to be ordered to duty with the operative navy, as they are then tagged with the "for shore duty only" label.

In ordnance only do specialists continue to go to sea and take part in the evolution of their art, because it must be admitted by the most skeptical that it is the operations at sea which force evolution in the various arts which make up ship operation. Our specialists have not the incentive to receptiveness from outside experience and suggestion that the specialist in civil life has. Their livelihood is in no way influenced by their attitude toward the sea-going personnel and its ideas. They may in fact be just as obstructive, high-handed and dictatorial as they please under ordinary conditions, and experience has shown that they do tend to become just that wherever anything like a corps is concerned. It should be quite unnecessary to dwell on this point if the average officer had studied corps systems and their effect on military or naval service, and in order to point the way to light on the subject, a study of the following is recommended:

- (a) Condition of naval ordnance prior to 1899.
- (b) Condition of naval engineering prior to 1899.
- (c) Condition of army ordnance up to and through the World War.
- (d) History of naval construction to date.
- (e) Relations between the army engineers, ordnance, and artillery corps as affecting the efficiency of the artillery arm, and particularly that of the coast artillery.

Such a study, of course, must be made with the idea in mind of discovering how far the corps system is a basic reason for any inefficiency which may be found to have existed in these various activities. It will be noted that the activities mentioned in the army organization are those which have to do with the building and operation of artillery equipment, including emplacements, location of magazines, shell rooms, hoists, etc., and which correspond to our construction engineer and line corps in their relation to the ship.

It will be found that our naval ordnance was of such flimsy construction and so inaccurately built as to make it almost useless.

It will be found that our engineering departments on board ship were in a deplorable condition, although each ship had a number of specialist engineers to operate the machinery.

It will be found that army ordnance was far behind the times in design, greatly below par in weight of metal thrown in a given time, and deplorably slow in production.

It will be found that our naval constructors were behind hand in developing under-water hulls whose performance at sea could be considered in any way as approaching satisfactory results, and that for years we had been laboriously pushing ahead of us the water which was only too anxious to get by, and we had been likewise for years gravely calculating the necessary horsepower to drive hulls at a given speed only to find when we actually drove the hull at the designed speed that the horsepower necessary bore no relation to that we had calculated.

It will be found that the Engineer Corps of the army designed and erected the emplacements for our coast artillery; placed magazines far from the guns they were to serve; placed ammunition hoists of an antiquated type at an unnecessary distance from the guns to be served, thus preventing any attempt at rapidity of fire. That the Ordnance Corps designed and built the guns and mounts with practically no attention to suggestion from artillerists of long experience; provided slow and antiquated methods of loading and handling the mechanism long after the navy and foreign gun builders had brought their guns up to date, and as a crowning achievement accomplished the feat of so redesigning the French 75, which had stood the test of four years of war, as to prevent the arrival of a single battery of American built 75's at the front before the Armistice.

These things were true, not because the individual personnel was not up to the work, but because basic organization requires that in any combination of design, construction and operation, where the three are essential parts necessary to produce one definite result, they are too intimately connected and too interdependent to admit of separate control by three different units or agencies where one agency (the operative) is alone responsible for the result, and where the others can and do in such frequent cases load what should be their meed of responsibility on the former's shoulders.

An objection will undoubtedly be registered against the inclusion of naval ordnance under the head of corps, but the writer is con-



vinced that the methods pursued by the Ordnance Bureau during the years immediately prior to the Spanish War made what was practically a corps out of the Bureau and its activities, in that the Bureau became a self-perpetuating body with a permanent head, with the result that it had all the mystery and obstruction of the other corps, and this mystery and obstruction retarded naval ordnance evolution immeasurably. Nothing but a tidal wave from the sea-going personnel could have broken it up. Fortunately, we received the impulse for such a tidal wave from Admiral Sims' introduction of the Percy Scott method of training, and the condition of naval ordnance was quickly shown to be far behind the necessities of actual battle conditions. This rejuvenation of naval ordnance forced an awakening to some extent in all other naval lines of endeavor, and this was notably the case with naval architecture, with particular reference to the changes found necessary to protect handling rooms and magazines from fire dangers due to explosions in turrets; and the lack of knowledge of the necessity of this change by the British constructors seems to have accomplished the destruction of three battle cruisers of the British fleet in the Battle of Jutland.

This is a glaring case of the necessity of specialists seeing with their own eyes the results of their arrangements. Had the British constructors seen what happened on the *Missouri*, *Kearsearge*, and *Georgia*, they would not have placidly sat down as they did, saying "That poor American powder," and have sent three such death traps to sea as the battle cruisers proved to be.

A greater change in an engineering way had previously been made when the Engineer Corps was legislated out of existence by the Amalgamation Law of 1899. In ordnance we had no law in the way of opening up the Ordnance Bureau to outside influence, and, therefore, the Sims agitation was all that was needed for that, but it is a practical certainty that if we had had an Ordnance Corps established by law, the improvement in ordnance due to the efforts of Admiral Sims and other sea-going officers would not have had anything like the same impetus given it.

The ostensible reason for doing away with the Engineer Corps was to do away with the antagonism which had grown up between the line and engineers on board ship, for it was realized that the ships could not be really efficient when such disruptive conditions existed. There was no realization at that time that engineering in

the service was at a very low ebb, and it was not until the results of having a mutual ground from which to view the ships' efficiency as a whole began to make the various activities on board ship show in their true perspective in their relative importance to the ship's efficiency, that the evil effects of the corps system became really evident.

In this discussion, the corps which have to do with the building, operation and repair of the fleet are the only ones considered, thus eliminating the Medical, Supply, and Civil Engineer corps as unnecessary to the discussion. The relation of the three corps mentioned is of a nature which has so little effect on the general design, construction, operation and repair of the ship as to make it unnecessary to consider them.

The fact that we were able to show up the condition of our naval ordnance by the Sims method does not assure us of being able to do likewise with other corps, because after all the personnel of the Ordnance Bureau was made up of sea-going officers, who had merely lost some of their open-mindedness through being returned each recurring shore duty to their old positions in the Bureau, and who, through the peculiar kind of loyalty they thought they owed to ordnance, whose chief had been a fixture for 12 years or so, had that much incentive to be intolerant of suggestion from those who had not the inspiration which exists in the atmosphere surrounding the chief of the corps.

In other words, line officers in ordnance had much less of a gulf between themselves and the "run of the mine" line officers at sea, than was true either in the case of the Engineer Corps before it was abolished, or of the Construction Corps up to date.

Again, it must be stated that we did not abolish the Engineer Corps because it was not efficient as an engineer corps but because its continuance meant constant friction on board ship and the consequent lowering of the all-round efficiency of the ship. In this we succeeded in accomplishing our purpose, but we at the same time introduced a new element, that is, "Officers for engineering duty on shore only." The reason for this separate designation was that the older officers in the Engineer Corps were not required to qualify for the line, and those who did not qualify were placed on the "shore duty only" list. This arrangement at the time was, of course, necessary and quite proper, but it also placed a small foundation stone in the naval organization upon which could be built a practical Engineer Corps without designating it as such.

In 1916 such a corps was established by a clause in the Naval Appropriation Bill of August 29, which authorized the formation of a list of officers "for engineering duty only," who, after reaching the rank of commander, would, with the exception of fleet engineers, be "Officers for shore duty only." The proposition was not a service proposal in the sense that the service generally had been consulted, nor was it a service proposal if a majority of the service could be considered as having any right to a knowledge of what legislation was being considered with relation to the service personnel. It was entirely a star chamber proceedings as far as any service need or desire was concerned, and was, I believe, diametrically opposed to the general idea in the service at that time.

Coincident with the above, another much more serious proposal was prepared to be urged on the secretary. This second proposal amounted to a division of the line of the navy under two headings: (a) Officers for Command; and (b) Officers for Industrial Duty. The text of the proposal was such as to cause any officer who read it to believe that his chances to command ships at sea would be sadly jeopardized if he were seen to glance at a monkey-wrench or other industrial implement without openly manifesting the greatest aversion to it, in that it stated that any officer who accepted duty in the industrial side of the service on shore, should by that act be relegated to the list of industrial officers, and could not thereafter be considered eligible to command. Fortunately for the service, a few officers who knew that a knowledge of the machinery which operates the ship was a necessary part of the naval officer's equipment, and who at the same time could tell the difference between a jib and a topsail, got wind of the affair and by vehement expression of opinion were able to have the proposal consigned to the oblivion which it deserved, but the point to be remembered is that such a revolutionary proposal, fraught with such far-reaching effect on the whole service, could have been seriously prepared for submission to a civilian secretary, who could not have sufficient knowledge of the naval game to appreciate what the effect would be, and this proposal was prepared by an officer of such high rank and of such position in the departmental organization as to give his proposal all the earmarks of service need and service approval.

This proposal, if acted upon, would have divided the service more completely into two corps than it was divided in the days of the

old Engineer Corps, and would have engendered in the service the same old antagonisms which made our ships inefficient in the time prior to amalgamation, greatly augmented, however, by the outraged feelings of hundreds of officers who have carefully trained themselves in both the industrial and the upper deck sides of the service, in the belief that a knowledge of the mechanics of the ship is essential to proper decision on the bridge.

To-day we have a clause in the Navy Regulations which prevents officers who have taken the postgraduate courses in engineering and who have been assigned to the list of "officers for engineering duty only" from taking command of a ship when all others in authority above them are out of the ship, and already we have the beginning of heart burnings caused thereby and a tendency of the younger officers to look askance at following their natural desire to know about the machinery which makes the fighting of the ship possible. The above regulation, of course, refers only to those engineer officers who are designated as "officers for engineering duty only," but it is not beyond the bounds of probability, and in fact, is certain to happen, that one of the junior engineer officers who is not designated "for engineering duty only" will be left in command of the ship over the senior engineer officer who has been so designated. A more dangerous situation from a disciplinary standpoint could not well be imagined.

As to the importance of the senior engineer officer in the activities of the ship outside of his own particular department, there should be no question. His assistance in caring for and increasing the efficiency of the mechanical part of the ordnance game on board ship alone makes it essential that the closest kind of association and coordination be maintained between himself and the ordnance officer, and such sympathetic coordination would appear impossible if we are to separate him from a participation in all the functions which go with the rank he holds.

The members of the old Engineer Corps who did not qualify for line duties are rapidly becoming very few in number, and with their passing goes the only real reason for distinction being made between officers of the line, regardless of what course their duty may take, and we should abolish the "shore duty only" iniquity.

The fact that the engineer officers of the younger generation were able to qualify for the line duties has proven conclusively that going to sea in regular order is all that is necessary to keep an

energetic officer in touch with all departments of the ship, regardless of what duty he may be performing in the ship, and when it is remembered that we now have quite a number of ships whose purpose is to a great extent industrial, the solution of sea duty for those of too exalted rank to make it proper to assign them as engineer officers of ships, and who still desire to follow comparatively exclusively the engineering game, seems in our hands, for certainly the commanding officer of a repair ship, if the ship is to be efficient, must be an officer who knows the intimate details of operative, engineering, and the repair game, and should have the most vital interest in them.

A specialist in the navy to be really successful must not only have a postgraduate course but also must have practical experience on the operative side of the game, and this practical experience must be spread over the whole period during which the particular individual can safely be considered by the service as a specialist. This is true because of the rapid evolution in the naval profession, which evolution makes a back number of yesterday.

The above mentioned practical experience must also be general experience and not just confined to the narrow limits of his specialty, because it is the general conditions surrounding his specialty, or rather surrounding the use of the product of his specialty, which have the determining effect on the success of that product in the service. Herein lie the real reasons for the sea-going element insisting on the requirement of sea service for our specialists, whether they be constructors, electrical engineers, marine engineers or ordnance men.

It is easy to cite instances illustrating loss of touch with operative conditions by "officers for shore duty only." One is as follows:

In one of our large ship yards there was an inspector of machinery, who was probably one of the best of the old school engineers. One of his assistants, a sea-going officer, objected to the boiler installation on a vessel which was building, for very definite practical reasons, which reasons, however, would not have been true if the boilers had been Scotch type instead of water-tube type. The inspector said: "I have never had experience with water-tube boilers, but I will take your word for it," and the changes advocated by the young officer were made. The inspector had been an officer "for shore duty only" for about 10 years, and in that time had so lost touch that he had to take the advice of an officer

who had, as compared with him, very limited engineering experience, merely because "for shore duty only" had prevented him from keeping up to date from an operative standpoint.

Another illustration of the necessity of experts, or specialists, acquiring an intimate knowledge of operating conditions to permit them to properly do their work is as follows: At a meeting of the Naval Consulting Board, where the matter under discussion was the location of the Board's experimental station, a note was written to one of the Board by a naval officer present, saying that the plant should be located near one of our large seaports where it would be more easily accessible to officers who sent in suggestions, in order that they might assist in the development of their ideas by their practical experience. The answer he got was: "All we want is for the navy to tell us what they want to accomplish and we will give them the answer damn quick."

The same member of the Board later became interested in a naval problem and failed utterly to make any headway until a young naval officer was sent to work with him to answer his questions with regard to conditions and antecedent experience in the same line.

The ship is so much of a unit that everyone in the ship, and in particular every officer in the ship, has a complete running knowledge of the activities of all departments, and it is a matter of history that one of the greatest assistants in the evolution of equipment for proper training in gunnery in the early days of Admiral Sims' epoch-making crusade was a sea-going paymaster, and it is further a matter of history that by far the greater number of the improvements in naval ordnance at that time and since have been initiated at sea and pushed to satisfactory conclusion by practical sea-going officers.

While on this subject, it might be stated that it is exceedingly probable that had the first-class ships of the navy each had a naval constructor attached to it, the improvement in stream lines of battleships would have been made very much earlier than was the case, as they would have had daily and practical demonstration of the remarkably inefficient stream lines of all our battleships up to the evolution of the dreadnought. It is true, and it must be appreciated, that the everyday occurrences on board ship in all lines of endeavor are the guides by which future improvement in construction, arrangement and equipment of ships to do the work for which

they are designed must be based, and it is believed that any constructor who went to sea from day to day in vessels of the *Wyoming* class and who observed the motion of the vessel when being driven into a heavy head sea, would immediately be interested in evolving schemes to reduce the whipping tendency of the bow after it had buried itself solid to No. 2 turret. His tendency to investigate the possibilities of a fuller bodied forward section to reduce pitching, and at the same time not to reduce the speed elements of design, could not but have been more earnest than if handled by him merely as an academic subject.

The fear is always expressed that the time necessary to gain practical experience in the use of the product of the specialist, while a good thing, would prevent him from being a specialist on account of lack of time in one short life to collect the necessary knowledge to both design and operate any particular product. This, to be frank, is plain and unadulterated poppy cock. The caliber of brain which will be of use as a specialist will have to delve into many outside arts and sciences in order to keep itself properly warmed up and operative, and the operative side of the art affords the opportunity to improve as nothing else can improve the resultant output of such a mentality.

The truth is that many more weaknesses in any structure develop in use than develop on first test. When they develop on test, the builder of the structure sees the test and immediately remedies the defect, but when such defects develop in service it is frequently next to impossible to make the designer believe that it is not the crass ignorance of the operator rather than the weakness of the structure which is at fault.

On the other hand, given a certain piece of equipment which is designed to do certain things, turn it over to the sea-going personnel and have them report against it for certain defects; if the specialist has had practical experience with that particular design of equipment, he is in much better position to put his finger on the seat of the trouble, whether it be carelessness on the part of the operating forces or inherent defect in design, than he would be without such experience, and if it be the fault of the operating force the specialist will have much less trouble in clearing up the fault than would one who had no practical experience under conditions of operation and is known by the sea-going personnel to have had no such experience. In other works, one is much more liable to accept the dictum of a specialist when he knows that the specialist has had the same kind

of practical experience as he himself has had, than he is when he knows that the opposite is the case. The kind of naval specialist who does not have experience with the operation of the product of his specialization cannot but become a stumbling block to progress and a theoretical parasite on what is a problem 75 per cent of which is practical.

In all the above, the writer holds no brief for the line, because what has been said of constructors and engineers would be just as true of a line officer who insisted on sea duty only. Good professional duty on shore at intervals is just as necessary for the sea-going officer as terms of sea service are. Fortunately, we do not have many officers who make the mistake of remaining always at sea, and especially is this true at the present time when rotation in duty is more or less required by the Bureau of Navigation.

There has been a cult in the line of the service who have rather systematically refused to take their turn on duty in connection with the material side of the service, for the same reason which is taken to bolster up the supposed necessity of "officers for shore duty only," that is, the lack of ability of one brain to know thoroughly all sides of the service. These officers blind themselves to one element in naval life which makes it different from that of many civil occupations, and that is the fact that the whole navy is trained and operated to one particular end, efficiency in battle, and in moving from one organization to another the basic system of the new organization is similar to the old. Each new occupation to which the officer is assigned has some coordinating link with that which he has just left. His basic education, not only at the Academy, but in general service in his association, necessarily close on board ship, with all the activities which go to make up ship life, cannot but be general, and as long as he goes to sea at recurring intervals, cannot but keep him more or less up to date on the changes, not only in equipment but in method, without impairing but on the other hand increasing his efficiency in the particular activity in which he may be temporarily engaged. It takes nothing from his opportunity to think upon and study any specialty to which he may be inclined, but rather energizes his thought to the enlargement of application of his specialty in coordination with others to increase the general efficiency of the ship for battle.

There is no profession in which conditions change more frequently and in which requirements increase more rapidly, both as



to equipment and method, and to properly meet such changes and requirements an intimate knowledge of the operative side of the service is the first essential, and such intimate knowledge cannot be acquired without recurrent duty in the operative service.

An officer returning to shore duty from sea should have at his finger tips the results obtained in the use of his specialty aboard ship, and his ability to do this should not have been impaired by his assignment to other duties than those of his specialty if he is properly energetic and has the interest in his work which is a prerequisite of the true specialist, because it must be thoroughly realized that interest in certain lines of thought and endeavor, and not education, is what makes the true specialist. Education in special lines increases the ability of the individual in those lines only when this interest is present, and his limitations then are measured by the energy he possesses to drive him on.

Daily life on board ship brings to the attention of inquiring minds thousands of small ways in which the design of the ship or her equipment could have been improved; a door should have been cut here and not there, hatches here and not there, doors to swing inboard here and outboard there, ventilation here should have been thus and so, this arrangement is all right in port when so and so is true but is impossible at sea, etc., *ad infinitum*. Take these to the "for shore duty only" officer, and what do you get? "There appears to be no real need for these changes, etc., also *ad infinitum*."

This would not be so serious in many cases if the "for shore duty only" officer would put the item down where it would for a certainty be considered by competent authority when the next ship was being designed, but this he does not do because he personally has never had experience with the particular item which would stamp it on his memory as it is stamped on the memory of the operative personnel.

A case in point: An assistant inspector of machinery, just from sea, found on his first inspection of the firerooms of a ship that was building at one of our best shipyards, that the valve stems of all main and auxiliary steam lines were pointing downward. Investigating as to why this condition should be so universally true, he found that it was because the original type drawing giving simply the general arrangement of the machinery in sufficient detail to permit bids to be made by contractors, had all valves indicated with stems down. He also found that a ship just completed at the same yard had had the same situation and the stems had been turned up

afterwards, by the contractors, at great cost to the government, but no notation was made at the time in the drafting room to prevent a recurrence of the error, which error would have been instantly picked up by any competent operating engineer who had not been kept away from the operative side of the service by the "for shore duty only" mark on his record.

The memory of man is short and full of inaccuracy and in a profession where evolution never sleeps, memory, however tenacious of things of yesterday, cannot be of prime use in things of to-day, and is just one step farther removed from things of to-morrow.

Failure to appreciate the needs of fast flying evolution caused by operative requirements, obstinate refusal to recognize improvements when suggested by those who inhabit the less rarified atmosphere of the operative world, obstruction, procrastination, and ultimate ossification of the whole system of naval activities, will be the sure result of such a segregation of specialists from the "run of the mine" naval service.

This tendency of the present is all the more astonishing when one looks back on the quite recent war and the practical result of naval operations of our own service based on the general service idea, and of others based on the segregation idea. In whatever light one may view it, if the basic idea of the efficiency of the ship, which after all is the unit from which we work, be considered, one is inevitably forced to the conclusion that the corps system wherever it touches the operation of the ship is an utter drag on efficiency, and that any specialization which does not expressly feature operative experience rather than technical education and design, is a serious perversion of a proper naval perspective.

Any engineer officer of the army who was on duty at the front during the war will state emphatically that he found he had to have an intimate knowledge of infantry and artillery tactics and strategy in order to permit him to do his proper part in the operations with any measure of intelligence since his work made the movements and tactics of the two other corps possible, and what is true of the army is in no measure less in the navy, but is rather increased by the isolation incident to sea going.

To recapitulate:

Naval constructors should be amalgamated with the line for the following reasons:

(a) By segregating them into a corps and assigning them to shore duty exclusively we lose the benefit of their trained minds

on board ship in the almost daily conferences of the officers to increase the efficiency of the ship for battle.

(b) They lose the opportunity to observe constantly the points in which design, construction and equipment can and should be corrected to meet the rapid march of evolution, and they lose the incentive which the spirit of the ship inevitably imparts to greater endeavor to achieve excellence in their part of the game of preparation for war.

(c) They lose all the incentive which being in line of succession for command inevitably gives, and in addition they cannot but feel the soreness which comes from not being eligible for the highest and most satisfying position in the service, that of commanding units of the fleet and in time the fleet itself.

(d) Isolated in their work, they become intolerant of suggestion to a greater or less degree, and therefore frequently obstruct where they should assist development.

(e) Passing from one position to another on shore means only physical change of scene and environment, the association being a duplicate of that just quitted, and the work usually exactly the same. Such a life cannot but tend to discourage effort and lead the mind into narrow lines of thought which inevitably limit efficiency.

(f) Questions of promotion, precedence, and jurisdiction which at the present time are so irritating would be entirely eradicated.

(g) The number of officers assigned to postgraduate courses in naval architecture could be made commensurate with the needs in those lines instead of being, as is now the case, held to a certain number.

(h) The service would gain the continuous use of this specially selected class of mental attainment for general use in solving service problems instead of curtailing its use to the narrow limits of naval architecture, and at the same time the ability of these minds would be increased by broadening their field to include the operative side of naval life.

All other specialties which have to do with the building, operation and repair of the fleet are in the same category, and it follows that the abolishment of "for shore duty only" among constructors and engineers is an essential to increasing service efficiency, and while it will undoubtedly be opposed by some, the service would do well to look with care at the true reason for such opposition.

[COPYRIGHTED]

U. S. NAVAL INSTITUTE, ANNAPOLIS, MD.

---

## SEA SCOUTING

By LIEUT. COMMANDER G. A. SMITH, U. S. Navy

---

In this age of high pressure steam and electrical wonders, the average naval man is so weighted down with the yoke of scientific organization, and intensive operation that he forgets the historical component of his life's work. There can be no greater aid to morale than a clear understanding of the indomitable fighting spirit of the American sailor man of the past. The early whale and ocean carrying trade was developed as necessary for the life of the struggling nation; then came the navy with its long list of glorious victories and accomplishments in protecting brother sailormen and dependent industries. This long struggle on old ocean in the early days of American seagoing developed a distinct seafaring race, and the descendants of these men were born with a love of the sea, and a wholesome respect for its traditions. In practically any city in the United States you can find a number of men who are proud of their salt water blood. These men don't think in terms of the navy, merchant marine or fishing fleets.—Their ideals have grown from thoughts and tales of the *Constitution*, The West Indian pirates, a dead whale or a stove boat, the *Flying Cloud* and the gold fever. "Away you Rolling Rio!" It is to these men that the navy owes cooperation in developing their ideals by means of the sea scout movement.

The Sea Scouts are a part of the Boy Scouts of America, operated just as all other departments, under the authority of the national council through its executive board and the chief sea scout. The diagram on the following page shows the organization and there are also listed the national, honorary, and active officials.

Sea scouting can be taken up in any good-sized town or small city. It will be seen from the diagram that in starting sea scouting, the start is made with the local council. As boy scouting has been

DIAGRAM OF NATIONAL B. S. A. ORGANIZATION

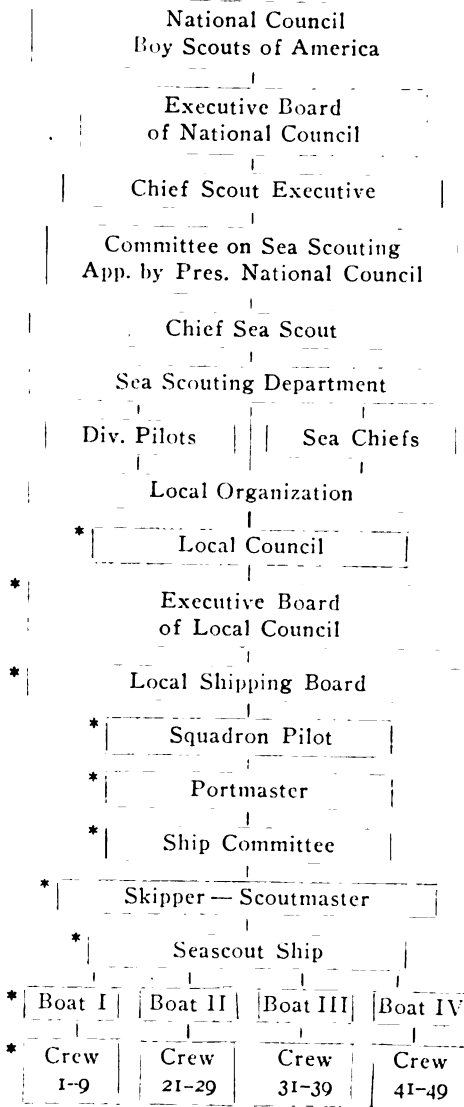

- OFFICERS**
- Honorary Pres.  
W. G. Harding.
- Honorary Vice-Pres.  
Woodrow Wilson.  
Wm. H. Taft.  
Daniel C. Beard.  
Wm. G. McAdoe.
- Pres.—Ch. Livingstone.  
Vice—Milton A. McKee.  
Vice—B. L. Delaney.  
Vice—Arthur Letts.  
Vice—Robert S. Thorne.
- Chief Scout Exec.  
James E. West.
- Com. on Sea Scouting.  
Geo. W. Goethals.  
Chairman.
- Chief Sea Scout.  
Geo. A. Wilder.

\* Explained in this article.

established throughout the United States, the local council is already in existence and may be expanded as necessary to handle the additional work which sea scouting imposes.

The scout executive, who is secretary of the local council, issues a call to members of the council to meet in the interests of forming a sea scout organization. The council meets and the executive board of the local council is empowered to start the movement.

The local sea scout shipping board is made up of and operates under the executive board. The shipping board consists of three or four men who are interested in the navy and marine matters and who may be counted on to attend meetings fairly regularly and push sea scouting.

The squadron pilot is the local boy scout executive, his other duties are active secretary of the local council and secretary of the shipping board.

The portmaster is a citizen of salt water blood or sea-going experience. He is the chairman of the shipping board.

The scoutmaster or "skipper" is the mainspring of the organization. He must be an experienced seaman. A navy recruiting officer, a retired officer or reserve officer, a retired boatswain or gunner, a retired member of the merchant marine, or a yachtsman. The skipper plans the work, executes the work, and brings the ship to practical efficiency.

The sea scout ship consists of one or more boat crews with nine men in a boat crew. The crew numbers are from one to nine, and are billeted as follows: Coxswain, messman, yeoman, baker, signalman, waterman, handyman, shipsmith and sailmaker.

The local council approves of the program of seascouting and the shipping board, pilot, portmaster, ship committee, and skipper are ready to begin work.

The ship committee is composed of the same members as the shipping board, until a number of sea scout ships have been organized, when the ship committee is formed to look out for the interests of the individual ships.

A good-sized room or small hall is secured, and invitations are issued to all boy scouts, 15 years of age, or over, weighing at least 112 pounds. The time, place and date of the first meeting are specified. At the first meeting the plans for the local ship are discussed and names of volunteers listed. All volunteers are

registered as apprentice sea scouts. The shipping board applies through the local council to the national council for charter for the ship, and upon issuing the charter the skipper is commissioned by national headquarters.

The hall is converted into the deck of a ship. The following equipment must be provided before the next weekly meeting; sea-scout ship flag, Seascout Manual, Bluejacket's Manual, small ensign, ship's bell, old running lights, small amount of canvas, palm and

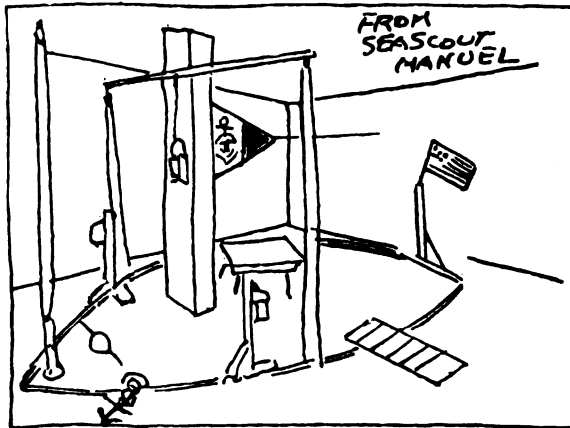

B. S. A. SLOOP "THEODORE ROOSEVELT."

Built in one evening in the basement of the house where John Hancock was born.

needles, marline, manila line, thread, compass, barometer, thermometer, jackstay, fids, broom, bucket, lantern, old steering wheel, blackboard and chalk. Having secured a small amount of gear and lots of pep, the ship is ready to be launched and sail forth on the seas of good fellowship, citizenship and seamanship.

The most difficult part has been accomplished and from now on the Seascout Manual supplies the sailing directions by which the ship is steered. Turning through the pages the skipper finds the following work to be done :

#### SCHEDULE OF WORK

The *Sloop Class* work is the first work to be accomplished and is the class that allows the boys to get acquainted with one another. In this class come many things already known to the first-class boy

scout; signalling, first aid, compass—but there are many new things, and review is always beneficial. It is in the winter that the following sea training takes place:

1. The mariner's compass—simple principles and boxing by whole points.

2. Make a hardwood fid 8 inches long, and 1 inch wide at base, sand paper and oil.

3. Make a three-strand eye, back, and short splice. Make a grommet. Using a palm and needle make the following stitches in a piece of canvas; round flat-overhand and herringbone. Whip the end of a rope with needle whipping.

4. Know the meaning of the following bos'n's orders: "All Hands"; "Up All Hammocks"; "Mess Gear"; "Sweepers"; "Pipe to Mess"; "Away Running Boats"; "Side Boys"; "Haul Away, Hoist Away, Belay."

5. Become familiar with following types of small boats: Punt, catamaran, balsa, wherry, dory, dinghy, "Clinker," "Carvel" and "Diagonal" builds. Scantlings and fittings of small boats; cutters, sloops.

6. Anchors, bower, sheet, stream, kedge, mushroom, sea anchor, grappels, chain cable, swivels, shackles.

AT CAMP, or when boats are available:

7. Sleep in the open or under canvas six nights.

8. Learn parts of an oar and commands for boat under oars; "Stand by your oars; shove off; out oars; stand by to give way; give way together; feather your oars; in bow; lay on your oars; up oars; let fall; trail oars; hold water; back water; point the oars; pull a dry oar."

9. Blocks—made, mortised, snatch, gin, secret, two-three-fold.

10. Rules of the road.

11. Buoys.

12. Barometer and clouds, swimming and life saving. It will be seen that this schedule, allowing one subject for each weekly meeting, will consume from four to five months. When this work is completed the boy is a real sea scout, is a practical little sailor, and wants to absorb more sea knowledge. After a thorough examination each boy is issued a certificate showing him to be "an ordinary sea scout."

The *Schooner Class* having qualified as an ordinary sea scout and having a minimum strength of 18 men in the ship, the next step



is to actually sail and row on the ocean, lake, pond or river. This work is not as comprehensive as that of *Sloop Class*, and can be accomplished in from six to eight weeks.

1. Draw compass circle. Draw outline of ship and name the ahead to astern bearings by points. Describe the liquid compass; dry compass.

2. Sketch the following type of vessels: Schooner, brig, bark, ship.

3. Make three trips in a pulling boat covering 10 miles. Prove knowledge of orders and boat handling.

4. Sea scout ship etiquette, discipline and ceremonies.

5. Make a sea bag 30 inches long and 10 inches in diameter. Make a three-strand tapered eyesplice and worm parcel and serve the same. Make a chain and a long splice.

6. Drill by sections from scout "Manual of Drills."

7. Learn the Beaufort scale.

8. Reeve off a luff tackle, mouse a hook.

9. Anchors, cat and fish falls, deck stoppers.

10. Make models to demonstrate rules of the road. Anchor lights for sail and steam vessels.

11. International code flags and storm signals.

After a thorough examination each man is given a certificate showing him to be an able sea scout.

When the sloop and schooner class work has been successfully accomplished sea scouting is on a firm basis. This work should not necessitate over six months. Therefore when organized in the fall, the crew of able sea scouts are ready when summer arrives to embark on a real cruise. Boats can be obtained from the Navy Department, and sails can be made in case some navy bos'n is available to help the work along. Complete schooner rig sails, with spars for the Syracuse sea scouts were made at a cost of \$50.00 (two outfits). These two cutters will serve for other sea scout ships that may be organized. When the boats are equipped a cruise is planned and the real joy of sea scouting begins. A camp site on some nearby lake is selected and the shipping board makes plans for establishing camp. Each scout must pay about 60 cents a day for his food. All arrangements being completed, the skipper and crews embark and establish camp. It is the ideal vacation for the young American,—sailing, watch duty, swimming, woodcraft, rowing, and physical drill.

The next step in sea scouting is the barkentine class:

*Barkentine Class.*—The barkentine class work is the next to be undertaken by able seascouts. A small part of this can be given in camp, but the major part will come when work is resumed in the city headquarters.

When the men qualify as able sea scouts they automatically become barkentine class sailors. As has been previously explained, six months during the fall, winter and spring is sufficient to take a green hand through sloop and schooner classes, so that all belong to the barkentine class when the cruise starts.

1. Show by models the rules of the road for large steam vessels.
2. Make and mark a hand lead line, "dipsey lead."
3. Make a chip log; sketch a patent log rotator.
4. International code flag signals.
5. Charts, variation and deviation.
6. Make a square topsail "flatten down", "let fly", "reef."
7. Reeve off a twofold purchase.
8. Make model of life-boat capable of being released. Use of oil during heavy weather.
9. Marlinespike seamanship from Knight's *Scamanship*.
10. Make a one week's cruise in a small boat and submit a 500-word log.
11. School of the troop—"B. S. A. Manual."

After a thorough examination men are given a certificate showing them to be extra sea scouts.

The next steps are *Bark Class* and *Ship Class*, but as sea scouting in the United States is still in its infancy, these will not be described here. This article is written with the hope that readers will become interested in the sea scout movement and, if occasion permits, personally lend a hand to some nearby struggling sloop or schooner class.

WHAT SEA SCOUTING MEANS.—Sea scouting like all boy scouting, has as its paramount objective "The development of sound patriotic, moral and physical principles in the great army of future citizens, now known as Young America."

The scout oath is:

On my honor, I will do my best:

1. To do my duty to God and my Country, and to obey the Scout Law;
2. To help other people at all times;
3. To keep myself physically strong, mentally awake and morally straight.

Boy scouting is coming into a high state of development throughout the United States. Thousands of troops are working and turning out good citizens and good thinkers. Generally speaking with boys from 12 to 15 years of age the results have been wonderful. It is for the boys over 14 years of age that sea scouting was started. The interest of this class of boys cannot be kept with straight scouting when the dance hall, pool room, and "do-nothing evenings" begin to exert their influence. Sea scouting is helping to fight these influences by providing healthy work and amusement that will put boys in the employable class.

At the present time a great many qualified and highly trained boy scouts are being lost to the scout movement. A successful sea scout organization is the answer to this loss of boys. Sea scouting is struggling for its life. Trained men are needed for its development. The recruiting service of the navy is ideally situated to render effective help without any complicated orders, extra details, or one cent of additional expense. The only thing necessary is to have the recruiting officer and a boatswain or gunner devote two or three hours a week to help develop a strong scout ship in the city in which the main recruiting station is situated. With a strong ship in the larger cities, many ships in the smaller cities can be developed. Retired or inactive navy men can be looked up to handle the smaller ships. The work is interesting and it is work that helps the government at all times.

The World War has left the navy with no strong naval reserve organization. The American Legion is absorbing thousands of navy men in posts where it is mostly all army and army deeds. The wonderful work of the Legion is not questioned in the slightest, but if "The race o' sailors is dying out" it is high time that the navy and merchant marine devote a small amount of time and thought to the development of the "American sailor of the future." The second line of naval defense is assured when the possibilities of sea scouting are realized.

[COPYRIGHTED]

U. S. NAVAL INSTITUTE, ANNAPOLIS, MD.

---

## PSYCHOLOGY AND THE NAVAL OFFICER

By LIEUTENANT F. H. GILMER, U. S. Navy

---

All mankind, except imbeciles, are capable of being properly designated as belonging to one of three classes. The classes are "the thinker," "the director" and "the doer." Regardless of how a man scales by a mental or psychological test he can properly be assigned to one of these three subdivisions of mankind. This does not mean that a man of the thinker class can do nothing other than think; nor does it mean that a man of either of the other classes is restricted to that type of functioning indicated by the class name. It does mean that the thinker is better qualified to think than he is to "direct" or to "do." It is possible to assume, with a fair degree of accuracy, that the thinker is capable of better thought than the "director" or the "doer." The same reasoning holds equally well for the other two classes. Briefly expressed this only means that any one man is better fitted for some one position than for any other position and that he is better fitted for that one position than most other men.

The navy is a large and complicated organization. Large enough to require a certain number of officers of each type. So large, indeed, as to necessitate the proper recognition of the type to which each officer belongs, and the distribution of work so that each officer is performing that sort of work consistent with his type.

In the past and at present the navy has completely ignored this fact and as a result all officers, with the exception of a few specialists are doing general duty. This is detrimental to the service because as a result many officers are occupying positions which some other officer is better qualified to fill and is failing to occupy the position for which he is best qualified. This necessarily results in a dual decrease in the efficiency of the navy.

It is also detrimental to the officer, for he is judged by his performance of a duty for which he is not temperamentally suited. Furthermore the present system of promotion by selection has introduced an additional unfairness into the situation; because a man who by chance is in his proper niche receives recognition of

his good work, while no one stops to realize that the misfit might do equally as well were he placed in his proper billet.

If each officer were made the subject of a short and yet thorough psychological research immediately after, or at the time of his graduation this condition would be effectively remedied.

This research or examination would serve a double purpose. It would first determine whether or not the candidate's four years of preparation had left him properly equipped to be qualified as officer material. It would then show to which of the three classes the officer belonged and the results should be used as a guide in the assignment of that officer to certain specific duties.

We will consider briefly the three classifications and endeavor to divide the several positions in the navy into corresponding groups.

The thinker is a man who is mentally alert. He is capable of sound thought but is not particularly fitted to direct the work of others; nor is he strongly inclined to put his thought into action. Officers of this nature are well qualified to occupy positions in our naval diplomatic corps, to act as instructors at the war college, and to write books on the higher calling of our profession.

The director is a man who is not inclined to great thought, but is able to direct the work of the doer so as to materlize the thoughts of the thinker. In connection with this, the idea, that a leader or director—for fundamentally they are the same—must be able to do everything better than any man he directs or leads, is not sound logic. The director must know only enough to assure his being able to distinguish between work properly done and work improperly done. The director must have the additional ability of selecting the right man for the right job. Officers coming under this classification should be the chiefs of our bureaus, the captains, executive officers of our warships, and the heads of our departments.

The doer is the man who when properly directed will exert much energy in the performance of his duties. He is, in the final analysis the "backbone" of the navy. The doer is generally the possessor of mechanical skill and to him we should detail the duty of attending to the upkeep and development of material. The doer is an able subordinate though seldom capable of assuming the duties of high command.

Briefly summarized—there are three types of mankind. All three are requisite to the service. The efficiency of the navy depends upon the proper assignment of the men. How?—is the question Psychological examinations—the answer.

[COPYRIGHTED]

U. S. NAVAL INSTITUTE, ANNAPOLIS, MD.

---

## OVER SEAS EXPEDITIONS

By COLONEL EDWARD L. KING, U. S. Army

---

During the past year the Naval War College at Newport, Rhode Island, and the general service schools of the army at Fort Leavenworth, Kansas, have cooperated in the solution of a certain number of problems involving combined operations of the army and navy. The problems themselves were of a simple character, entirely abstract, and covered by relatively few of the many details that such operations must, from their very nature, entail. While a casual reading of the problems and the several solutions might disclose only these few details, a closer association with them brings prominently to the front many others.

As the army member of the Staff of the President of the Naval War College it has been my privilege to cooperate in the solution of these problems and I have been impressed with the large field for research and study that they open up.

While the recent war has not altered the principles of warfare to any appreciable extent, it is well recognized that the introduction of modern weapons has decidedly disarranged many previously held ideas as to the exact methods by which these principles shall be applied. Much more exact information is necessary than was formerly the case and much more detailed plans and more fully developed team work must be recognized as essential than was formerly the case. Both the army and navy recognize this fact in their own spheres. For combined operations, team work is certainly essential and the difficulties of obtaining this desired team work seem at present decidedly hard. Careful study by each arm of its own duties must be made, a more than smattering knowledge of the needs, power, and limitations of the sister service must be secured, and then a study must be made with a view to fitting and joining the two services; a welding at the points of contact so as to secure a resultant that brings out the maximum effort of each service toward securing the desired ends. Officers of both services

who have given the matter thought are convinced of the necessity for consideration of this form of military work.

During the World War the army and navy were brought more closely together than was ever the case before. The skill displayed by the navy in safely and comfortably transporting to Europe and returning to the United States millions of men and enormous quantities of supplies is fully appreciated by their army comrades. We have absolute confidence that the navy end of any combined operations will be fully cared for. And the success of our troops abroad warrants a similar confidence as to the army end, when given time to organize and train. It is the work of the two together in combat operations that needs attention and study.

History furnishes many examples of overseas combined operations involving landings on hostile shores; but modern developments in offensive and defensive armaments make a study of the details on these former operations of little value. Among the few instances in history that may be studied with profit, the Dardanelles expedition is a prominent example. It was in this expedition that much skillful command and staff work was combined with many errors. Even wonderful gallantry was unable to overcome the handicap of these errors. In studying this campaign one is impressed with the fact that no matter how splendid the plans of the supreme commanders, ashore or afloat, may be, unless the details involving team work are carefully worked out and known by the subordinates responsible for their proper execution, failure will result.

The ideal conditions for a landing operation are those wherein the attacking party holds a base relatively near a hostile objective but so located that, with other considerations, the possible front of attack is so extensive as to prevent the defense from being strong enough at all points to prevent the landing.

Whether the base is close or distant, a study of the problem leads to the belief that the possible point of attack or alternative points of attack must be decided upon before the expedition sails, and preparations made accordingly. While many details must always be the same, there are many other details which will vary with the selected point of attack. Where but one point is selected before sailing, the arrangements may be simple. But if there are alternative points of attack the problem of so arranging details as to meet the different situations becomes more complicated. Exact

knowledge will materially assist in selecting a point of attack. Hence it follows that information is, as always, most essential.

A very prominent feature in the study of these expeditions—one which becomes more and more important as the study is pursued—is the absolute necessity for the fullest and frankest understanding and cooperation between the land and sea forces. At one point the interests of one service is predominant, and at another part the interests of the other must prevail. Only a complete mutual appreciation of the powers and limitations, the strategy and tactics, by each service regarding the other, can produce the desired result. No one who is unable to understand that the interests of his own service may at some part of the operations be subordinated to that of the other service should be placed in command. His ignorance, leading to stubbornness and false pride, will but insure failure.

A brief conception of the handling of a combined hostile landing operation is as follows:

Since the *raison d'être* of the operation is the successful placing and establishment on a hostile shore of a land force, it would seem that, considering all available information, the initial step in the problem would be a land solution. The army should determine approximately where, when and in what force it is desirable to make a landing. Taking this situation from the army, the navy would solve its part of the problem with a view to meeting the army needs. If the operation is practical from the navy standpoint, well and good. If, however, study shows insurmountable difficulties, they must be pointed out and, by conference, adjusted. It may be necessary for the army to make an entirely new estimate and form an altogether different plan, or it may be that slight changes will enable the navy successfully to carry out its part of the operation. Under any circumstances, these matters must be worked out in conference before the expedition is launched. Mutual and absolute confidence must be expected and extended by each service to the other—all jealousies great or small eliminated.

Having determined the "when, where, and how much" of the forces, the next step is the arranging of the details. This requires closely coordinated staff work and absolute cooperation. The hostile terrain and other conditions will govern the army in determining how best, tactically, from the army viewpoint, the troops should be landed on the beach in order to carry out the advance to form the necessary "beach-head." The knowledge of the tactical require-



ments of the army will be an important factor to the navy in determining what ships shall be used for different units of the army and how these ships shall be loaded. Here the navy will meet the army's wishes to its utmost. When the shipping situation prevents a full compliance with army needs the difficulties will be pointed out and alternative solutions made. The army must then modify its plans accordingly. In addition to the combat personnel and matériel, close attention must be paid to the landing of other supplies, and here again both the army and navy desires and necessities must be met.

Before sailing, every detail as to the actual landing of the troops should be considered. The soldier-man in a boat is helpless and very vulnerable. His only protection while en route from the transport to the beach are cover and speed. Every landing operation presents a different problem so far as the safe landing of troops is concerned. Some of the factors that enter are: The character of the beach, the depth of the water, amount of surf, prevailing winds, direction and force of local currents, amount of fresh water close to landing, character of terrain close to beach, character, location and extent of the actual and passive defenses, distance transports must lie off the selected landing point, etc.

If sufficient reconnaissance has been or can be made of the landing place to warrant a landing under cover of darkness, so much the better. If not, and the landing must be made in daylight, then artificial cover must be attempted. This cover may take one or more of several forms or combinations of forms, depending upon local conditions. With favorable wind, destroyers or small fast "skimmers" may lay a smoke screen. Under other conditions smoke from shells or bombs can be used to blind the land observation points. The ordinary fire from covering ships, aided or unaided by the several kinds of gases, would be used to neutralize hostile fire and interfere with the movements of hostile troops.

It is too much to hope that, except under exceptionally favorable conditions, all the enemy defenses may be smothered all the time. During some part of the time the boats conveying the troops will be subjected to fire. Particularly will enemy machine guns be able to function. It is most desirable that protection for men in boats against machine gun fire be furnished. This can be done by providing a craft with bullet proof shields. The design of these boats must meet the needs of the troops making the landing and at the

same time overcome the obstacles that present themselves to the navy end. With a base close to the selected landing place, suitable boats may be shipped in parts and then assembled, or they may be built at the base. With the base distant from the landing point the problem of placing suitable landing boats in position for use becomes a serious one. They would have neither the sea-worthiness, radius, nor speed to accompany the fleet under their own power and would probably be incapable of towing. They would have to be carried on ships, either assembled or knocked down and must be so stored on shipboard as to be quickly available when needed. This alone requires careful thought and appears to be mainly a navy problem.

As wire is liable to be found in the waters as far out as, say, a depth of 10 feet, consideration must be given to the design of these boats so as to overcome this kind of obstacle. This may include power to push through the wire, shaping of bow to override it, ramps to drop from bow to enable men to pass over it, and other schemes.

The *Beetle* used by the British at Suvla Bay overcame many of these difficulties. This boat had a speed of 4 or 5 knots under her own power, carried about 500 men, had bullet-proof sides, and a ramp on the bow. But the distance from the British base to Suvla Bay was short. With the base distance and across an ocean the difficulties of placing such a boat in position for use increase enormously.

The question of furnishing, covering and supporting fire during the landing and during the consolidation of the position offers food for thought. Any idea that good troops can be driven out of a position and kept out, and the position captured by gun fire alone, must be abandoned. The "go-get-um" forces are still necessary. It is probable that aircraft will be used by any future landing force. A sufficient number of copies of the best available maps and charts of the vicinity of the landing place must be furnished and these must have a common system of coordinates. The air craft will then be able to assist in the fire control to report to the firing ships the location of favorable targets. As it is well established that hit or miss artillery fire is useless, the method of using the supporting fire of the ships must be carefully planned, probably in about the same way as it is done for land artillery. This would undoubtedly involve the assignment of areas or sectors to certain

ships with the different types of guns having different tasks. In this fire the strength of the navy gun may in itself be a weakness. With the great initial velocity of these guns a very flat trajectory results. This may preclude a barrage close to front line troops and may prevent the searching of reverse slopes where hostile artillery or troops are known or suspected. Overhead machine gun fire from small navy craft, due to the pitch or roll of the firing ship, may be, and probably would be, more dangerous to friends than foe. One way of overcoming this difficulty is by making a careful study of the hostile terrain and so placing firing ships that their long range may enable them to enfilade slopes which are protected from the fire from the front.

Reduced charges in the navy guns may assist somewhat in overcoming the normal flat trajectory. Another solution is found in placing army howitzers on the decks (properly shored up) of ships and using them for needed searching. Even the types and amounts of ammunition that must be carried by the ships must receive careful consideration. Armor piercing shells, while desirable for a naval engagement, would probably not be the most suitable form of projectile for use in covering a landing. The greatest possible amount of proper fragmentation is desirable for a shell exploding on contact with the ground. This would probably not be obtained if the armor piercing shell were used. Smoke shells and different kinds of gas shells, with a knowledge of their tactical use, would also be important. The problem of storing and handling the kinds and amounts of shells that may be necessary in a landing operation will require careful thought.

A system of forward observation for the gun-fire of the ships must be devised. While spotters on firing ships are able accurately to locate splashes with reference to the target in a naval engagement, rear observers experience great difficulty in spotting shots landed in a rolling country. Whether this spotting or front line observation shall be a navy or an army function must be determined, and necessary methods of communicating the information to the guns must be found.

Communication between the forces on shore and on the ships is essential. The best solution for this is for the navy to handle all communication (message sending) between the ships and the beach, while the army takes it up at the beach, and handles all such matters inland. In all this work the point where the army and navy func-

tions seem to begin and end as such—the point of greatest potential friction—is at the beach or shore line. Fundamentally, it must be thoroughly understood that friction *must not* exist, either here or elsewhere. Between properly trained and educated people, each knowing the powers and needs of their own service, and appreciative of the same in the sister service, friction will not exist. People who do not come up to these specifications should not be given an opportunity to interfere with the success of the operation.

The proper solution is for the navy to be in absolute control of the transportation of the troops from the ships to the beach. The soldier-man is merely a passenger. He gets in, sits still and gets out when and as told. The loading, moving, and unloading of the boats are navy functions and all the work of this nature should be under the naval control. The naval representative on the beach is called the beachmaster. This officer controls all naval activities on the beach. He should also establish communication from the beach to the ships, hooking up with the army land communications. While the troops will be under the orders of their own officers on landing and will proceed on their mission as soon as they reach the shore, the army commander should have on the shore a representative to control the newly born service of the rear. This officer of the army might be called the shore commander. He would establish a message center, locate dumps, facilitate the forwarding of supplies and reinforcements, handle stragglers, assist in the evacuation of sick and wounded, form an information bureau, arrange for the building of temporary wharves, secure the necessary labor to unload boats, etc.

The shore commander and beachmaster must work in the closest harmony, and, in addition to great professional skill and energy, must possess unlimited tact. Each will require subordinates, both commissioned and enlisted, and these also must be fully indoctrinated as to the importance of the mission of the force.

It is obvious that it will be necessary to make careful and complete plans as to what will be needed to land and forward troops and supplies, and from the very beginning both the beachmaster and the shore commander should participate in this planning. Schedules must be prepared and the logistics of the boat movements carefully checked up. The amount, character, and location of works on shore, such as temporary wharves, landing stages, protection for men and supplies, etc., must be settled. All who are to be

engaged in this part of the enterprise must be fully informed regarding the details prior to the landing.

In order to avoid confusion on the beach it is necessary that the troops should fully understand what their duties are upon landing. Immediately upon embarking from the boats they should be ready to advance to their designated objective. This would seem obvious were it not stated that at Suvla Bay the orders regarding secrecy were so narrowly interpreted that even after getting into the boats at Imbros many troop officers were uninformed as to what was to be their line of advance or their objective after landing in the dark on the beach. This is, of course, entirely an army function. Previous instruction and drill will be required to secure smoothness in embarking and debarking the troops.

In every operation, military, naval, or civilian, personal acquaintance and conference are valuable assets. To promote this end, the army commander should be on the same ship as the naval commander. Their respective staffs should be in close personal touch, the beachmaster and the shore commander must know each other and even the soldiers and sailors should be in contact with each other. Each seeing the other service at work will appreciate the skill required and will respect and admire the other in a degree corresponding to their knowledge. At certain stages the needs of one service are paramount; at other stages this service must yield; while at other times each must yield and a compromise be arrived at which will best secure the desired ends. The navy loads the ships to meet the army's future needs; the army has no say as to the voyage or handling of the fleet; the navy controls the boats that put the troops ashore in accordance with the army desires; and the navy supports with fire the advance made in accordance with army plans.

The keynotes of an operation in landing on a hostile shore are:

Knowledge of one's own service.

Appreciation of the sister service.

Personal acquaintance and contact in the planning and conduct of the operations.

Absence of service prejudices with resultant complete harmony and cooperation in the team work so necessary for the accomplishment of the mission.

With a full appreciation of these key-notes, and the will to win, success will crown the combined efforts.

[COPYRIGHTED]

U. S. NAVAL INSTITUTE, ANNAPOLIS, MD.

---

A BIRD'S-EYE VIEW OF ADMIRALTY LAW AND  
PRACTICE

By LIEUT. COMMANDER W. H. FAUST, U. S. Navy (Ret.)  
Lecturer on Admiralty Law at the University of Michigan

---

Man travelled by water before any other method of transportation was known. The raft and then the dugout probably were the first cargo carriers as well as the first men-o'-war. It has taken thousands of years to advance to the present freighter, passenger liner and super-dreadnought. These marvellous changes in ship construction have not been followed by equally radical changes in the law of the sea, because the basic principles of this law have ever remained the same. These principles began with customs founded on the natural laws of right and justice, and, with the passage of time, were broadened in scope as the horizon of the adventurous sea-faring peoples of the east became extended. Along the shores of the Mediterranean civilization advanced rapidly and the inhabitants of the shores washed by these waters became the foremost commercial people of the earth. It was but natural, therefore, that the first laws of the sea, of which we have any authentic account, should have been codified and administered in that region. These are known as the Rhodian Code, or *Lex Rhodia de jactu*. The Phoenician traders planted colonies along the shores of the Mediterranean; the Carthaginians became their successors, and finally the Romans, copying the methods of warfare and commerce from the Carthaginians, became the rulers of the known world. With this increase in commerce the Rhodian Law was extended of necessity to suit the changing conditions of a growing civilization. We find in the Roman Civil Law many provisions regulating the rights and responsibilities of ships; and from these, the Rhodian Code, and new customs grew the *Consolato del Mare*, a collection of marine laws, of which the author and date are

unknown, but which antedate the fifteenth century. It is supposed to be a compilation of the marine customs of the trading nations of Europe, especially of those bordering on the Mediterranean.

Lying off the western coast of France is a small island, Isle d'Oléron, which was of maritime importance in the middle ages. It is of historical knowledge that Richard I, when returning from the Holy Land, stopped at this island, which then formed part of his domain, and became so impressed with the wise laws relating to the customs of the seas as administered by the courts of the little isle that he compiled them and carried them to England when he returned. These Laws of Oléron and The Black Book of the Admiralty form the basis of the maritime laws of England. Both on land and sea England was ruled by the laws of custom; by the common law on land, and The Black Book and Judgments of Oléron on the sea. That the Laws of Oléron were to be considered as part of the law of England is indignantly denied by Lord Esher, Master of the Rolls, in the great case of "The Gas Float Whitten No. 2" (Law Reports, 1896, P. D., 42). In delivering his opinion the Master of the Rolls says: "It was attempted by one of the counsel for the respondents to say that the Laws of Oléron were to be considered as part of the law of England. To any one who reads some of their strange enactments—as, for instance, in the Laws of Oléron (Art. 23): 'If a pilot through ignorance causes the ship to miscarry, he shall make full satisfaction, or lose his head.' (Art. 24): 'If the master or one of his mariners or any one of the merchants cut off his head, they shall not be bound to answer for it.' (Art. 26): 'If the lord of any place be so barbarous as to maintain (wreckers, etc.), he shall be fastened to a post or stake in the midst of his own mansion-house, which, being fired at the four corners, all shall be burnt together,' etc.—it must be ridiculous to suggest that they are part of the English law. But they contain many valuable principles and statements of marine practice which, together with principles found in the Digest and in the French and other ordinances, were used by the judges of the English court of admiralty when they were moulding and reducing to form the principles and practices of their court." There are some naval officers who, if they happen to read the above observations of Lord Esher, will agree that the Laws of Oléron were founded on right and justice and regret that they are not included in our International Rules of Navigation.

The judicial power shall extend . . . to all cases of admiralty and maritime jurisdiction.

The judicial power of the United States shall be vested in one Supreme Court, and in such inferior courts as the Congress may from time to time ordain and establish.

These two clauses in our Constitution comprise the full grant of power necessary to deal out and administer justice in all the intricate ramifications of business incident to navigation and commerce on the high seas and inland waters as carried on by the individuals and corporations within our territorial limits.

"The judicial power shall extend to all cases of admiralty and maritime jurisdiction." Each word here is clear, definite and apparently unambiguous. Still, especially for the first sixty years of our national existence, the meaning of these words, collectively and individually, and the intent of the framers of the Constitution caused endless controversies to be brought before the federal courts for consideration and decision. Even the Supreme Court has vacillated at times and, while it practically never "reverses" itself, it has had to "reconcile" its earlier decisions with later ones in a way that the naval officer would describe as an "about face." The word "admiralty" had to be defined and its derivation determined. We know that it comes from "admiral," but what did "admiral" mean in the language from which it came? Authorities are not agreed on its derivation but all agree that it means to all civilized nations "Lord of the Sea." It might be said that the weight of authority ascribes it to one of the Mediterranean countries. As it has a peculiar interest to the navy, aside from its legal aspect, it might not be an unprofitable digression from the subject to quote the result of Browne's search for its origin: "Many languages have been searched for the derivation of the celebrated word admiral, or ammiral (as Milton spelled it): Some derive it from the Greek *αλμυρος* *salsus*, because his jurisdiction extends over the salt seas. Others from the Saxon *aen mere eal*; that is, over all the seas; and others again, whose opinion Godolphin approves, partly from the Greek, partly from the Arabic; *amir*, or *emir*, in Arabic, signifying *praefectus*; and *αλιος* in the Greek language, *marinus*, both which amount to admiralius, or rather ammiralius. Certain it is, that in the east, the appellation was also given to terrene princes and commanders: Thus the Sultan, or tyrant of Babylon, frequently mentioned in their transactions, was also and commonly called admiral."



“Maritime” is not considered synonymous with “admiralty.” It amplifies and extends the meaning of the latter in order to fulfill the intent of those great and learned men who framed our Constitution to preclude the possibility of giving the phrase a narrow construction.

“The judicial power of the United States shall be vested in one Supreme Court, and in such inferior courts as the Congress may from time to time ordain and establish.” Combining these two constitutional grants gives the federal courts exclusive jurisdiction over *all* suits or controversies which are maritime in their nature and occur on public navigable waters. Through its grant of power Congress divided the United States into judicial districts and established in each district a court of original jurisdiction to try suits, including all cases of admiralty, of various characters cognizable by the federal courts. This court is called the district court. Therefore all admiralty suits must be begun in this court.

During our colonial period the vice-admirals of the several colonies were given commissions from the crown, with a jurisdiction far more extended than that enjoyed by the admiralty courts in the mother country, to try all admiralty cases arising within the limits of their territorial boundaries. Admiralty jurisdiction in the mother country was limited to tide waters and the high seas; and for many years after the Revolution the jurisdiction of our own courts was similarly limited. One of the notable cases in the records of the Supreme Court is where this august court, in order to decide whether an admiralty court had jurisdiction or not, found itself gravely considering the question whether the tide ebbed and flowed at New Orleans. As commerce in this country grew, both on the seaboard and the inland waters, this rule of limited jurisdiction to tide waters became embarrassing to the courts. The precedential ice was broken when the Supreme Court decided that the framers of our Constitution did not mean to adopt the English restricted view of this jurisdiction; but it was not until 1851, in the celebrated case of “The Genesee Chief,” that the last barriers were swept away and, with Chief Justice Taney delivering the opinion, the Supreme Court decided that conditions in this country were so vastly different from those in England that our courts could not be bound to the “tide water” rule, but that “navigability” should be the test of this jurisdiction. At one leap admiralty jurisdiction was extended to all public navigable waters capable

of carrying commerce. This means the Great Lakes and their connecting waters; the waters of the Mississippi Basin; all canals through which foreign commerce may be carried on. It does not include, however, waters entirely within the limits of a state which are not connected, naturally or artificially, with waters which form avenues for foreign commerce. Foreign commerce in its legal conception means commerce between states as well as with foreign countries. The Albemarle and Chesapeake Canal, the Illinois and Lake Michigan Canal, the Cape Cod Canal are all "public navigable waters," and subject to admiralty jurisdiction.

Besides the many interesting cases that have arisen to determine what are and what are not navigable waters, as large a number has been brought before the courts to determine what craft come under admiralty cognizance. Generally, it may be said, that any movable floating structure capable of being navigated and designed for navigation comes under its jurisdiction. The test here is "designed" for and "capability" of being navigated. It may be said that on the subject of what constitutes a vessel the courts are by no means in accord. A floating dry-dock which had been moored in the same place for more than 20 years was decided as not being intended for navigation and therefore admiralty had no jurisdiction. If it had been designed to be towed to different places in the same harbor it is very probable that the court would have decided otherwise. A floating boat-house permanently attached to a wharf was decided to be a craft designed for and capable of navigation. Lighters of all descriptions, floating elevators used for the storage of grain and designed to be moved from one point to another, dredges, floating movable derricks and pile drivers, floating movable bath-houses, all come under admiralty cognizance. On the other hand a vessel tied to a dock for the winter and used for the storage of grain, or a large gas buoy shaped like a boat, or a dismantled steamer used as a hotel and which met disaster while being towed from one place to another are not such craft as give admiralty jurisdiction. There are many decisions on both sides of the question whether a raft is such a structure as to come under this jurisdiction. The weight of authority and reasoning is in favor of jurisdiction, especially if the facts show that the raft is manned and steered.

The seamen or merchantmen have been considered, from the earliest days of water transportation, to be the wards of the admi-

rality. Their contracts are closely scrutinized by the courts and if they contain a suspicion of fraud or seem to be unduly harsh the courts will not hesitate to declare them void. Every person, with the exception of apprentices, who is employed or engaged to serve in any capacity on board a vessel is deemed and taken to be a seaman. Congress has incorporated his rights in statutes which now protect him from the "crimp," the boarding-housekeeper and the "bruiser" who thrived by shanghaiing drunken men. His lien for wages ranks at the very top; he is no longer subject to corporal punishment, although he may be put in irons for disobedience; he may not be arrested for desertion and the only punishment that may be inflicted for this crime is total or partial forfeiture of wages and effects; he may demand at least one-half of his wages due in every port so long as this demand does not come oftener than once every five days. The above and many other changes in the old-time status of the sailor have been made by the La Follette Act. The sailor is considered to be of the same nationality as the flag under which he sails, no matter what his real nationality may be. While the seaman has a lien on the ship for his wages the master has not; he must look to the owners for his pay. The English statutes give the master such a lien both for wages and disbursements.

In this country the admiralty courts have jurisdiction over suits brought by, and against, pilots. A pilot is required to exercise ordinary care; that is, the ordinary care of an expert in his profession. He is responsible for his own negligence, and this may not be charged against the pilot association to which he may belong if it happens to be the ordinary association one finds in this country. State statutes regulating pilots are considered constitutional since they come under those subjects upon which Congress may legislate, by virtue of its right to regulate interstate and foreign commerce, but, until it does legislate, these state statutes control.

It is difficult to say just what degree of authority a pilot has when he steps aboard a ship. He takes the place of the master in navigating, gives the orders to the wheel, designates the time, place and method of anchoring, and handles the ship generally. The master's duty is not to interfere with any orders the pilot gives unless he sees the latter is plainly incompetent or reckless. The ship is just as much responsible for the acts of the pilot as for the acts of the master himself; so, if the master interferes with the pilot in handling the vessel he is liable to relieve the latter from all

responsibility for damage done by the ship while supposedly under the pilot's sole charge.

Many state statutes regulate the fees that pilots are permitted to charge; many of them, too, are compulsory in requiring the employment of a pilot. The ship cannot avoid the payment of the pilotage fee where the employment of the pilot is mandatory. In case of evasion or refusal to accept a pilot either the pilot or the association to which he belongs may proceed *in rem* against the ship herself to compel the payment. This right is based on the theory that the maintenance of experts in this line is necessary for the public welfare, and like the city fireman, though it may happen that an individual may never need his services, he must be maintained for a call when required. Another reason is that it minimizes the danger of blocking channels either by running aground or being sunk by a collision.

One of the earliest known subjects of maritime law relates to "general average." All the old codes, including the Rhodian Code, provided that when a ship in distress was compelled to part with some or all of her cargo, her own gear, or even that she herself be run ashore in order to save either cargo or ship, all those interested in the marine adventure, if the subject of their interest was thereby saved, must contribute to the loss sustained by this jettisoning or grounding. Either the goods or gear must be thrown overboard or the ship run ashore *voluntarily* by the master or by his authority, in order to save either lives or property, or the question of general average will not arise. The test is whether the action of the master was voluntary or involuntary. In the former case it would be general average, in the latter, a peril of the sea where the loss must be borne by each owner who suffers from it. An interesting and decisive case happened where the cargo of a ship lying at a wharf caught fire and the port authorities had her towed out in the stream where her hold was flooded with water by a fire tug. The court decided that this was not a case of general average because the loss of the ship, which sank and became a total loss, was not caused by the voluntary act of the master or by his authority, although he was present, but by the municipal authorities to prevent the spreading of the fire. Another interesting case was that of a sailing vessel anchored off Buenos Ayres which broke adrift during a pampero and started up the river. It was inevitable that she would ground somewhere but because the master intentionally stranded her at a

point where the cargo could be saved the owners of the cargo had to contribute to the owners of the ship for her loss.

In fixing the responsibility for damage caused by a tug and her tow the question hinges on whether the tug or the tow was directing operations. The position of the tugman is quite similar in this respect to that of the pilot. The tow is not liable for the tug's negligence where the latter directs the movements of both; and *vice versa*, the tug is not liable for the acts of the master of the tow where the latter is directing the navigation. If the tow is at the end of a line she must take all ordinary means to avoid danger or damage even though she was placed in the position by the negligent acts of the tug. "Ordinary" in this connection means what could reasonably be expected of an expert in navigation and seamanship.

When the tug is towing alongside the tow it is usual in the merchant service for the master of the tug to direct operations from the bridge or forecastle of the tow, and the tug alone would be responsible for any damage caused by the tug or tow assuming that the management of both vessels was solely by the master of the tug. The courts generally hold the relationship existing between the tug and the tow to be the same as that between the hirer and driver of a taxicab. The "fare" merely states his destination. The driver, who is the agent of the owner of the taxi and not the implied agent of the "fare," and his employer become liable for the former's acts. On the other hand if the tow directs the navigation and the tug simply furnishes the motive power, the responsibility, aside from any negligent acts of the tug, would rest solely on the tow.

Salvage, like general average, is of very ancient origin. It has the distinction, moreover, of being purely maritime in its nature as nothing analogous to it is to be found in the civil law. Its justification is based on public policy; its purpose, to stimulate the saving of life and property when in peril of loss, and to encourage others to risk their own lives and property not only from humanitarian instincts but for the reward which follows success. Chief Justice Marshall stated the doctrine of salvage in the following language:

If the property of an individual on land be exposed to the greatest peril, and be saved by the voluntary exertions of any person whatever, if valuable goods be rescued from a house in flames, at the imminent hazard of life, by the salvor, no remuneration in the shape of salvage is allowed. The act is highly meritorious, and the service is as great as if rendered at sea.

yet the claim for salvage could not perhaps be supported. It is certainly not made. Let precisely the same service, at precisely the same hazard, be rendered at sea, and a very ample reward will be bestowed in the courts of justice.

Salvage is defined "as the reward allowed for a service rendered to *marine property*, at *risk* or in *distress*, by those under no obligation (independent of statute) to render it, which results in benefit to the property if eventually saved."

Each element in this definition must attach to property subject to the salvage award or it will not be permitted by the courts. It must be connected in some way with a vessel, either a life or property; the life or marine property must be in danger of loss, injury or destruction; the service must be rendered by a ship or persons under no obligations to render it; and the service must be successful. The master or crew of a salvaged vessel are not allowed salvage claims unless the services rendered have been extraordinary and they have exposed themselves to serious injury or loss of life. They are bound to render all reasonable service to preserve the passengers, ship and cargo from loss, and, incidentally, to save their own lives. Because a passenger is supposed to be interested in saving his own life, he must render some extraordinary service to be granted an award of salvage. A passenger on the *Great Eastern* was allowed salvage for rigging up an ingenious device, in the nature of a jury rudder, by which the ship was brought safely to port. On the contrary an English naval officer, who was a passenger on a brig, contributed his assistance when she was in distress, and claimed remuneration for his services. Lord Stowell said: "Where there is a common danger, it is the duty of every one on board the vessel to give all the assistance he can; and more particularly this is the duty of one whose ordinary pursuits enable him to render most effectual service. No case has been cited where such a claim by a passenger has been established, though a passenger is not bound, like a mariner, to remain on board, but may take the first opportunity of escaping from the ship and of saving his own life. I reject the claim." These two cases are on opposite border lines and it is impossible to reconcile them.

A pilot, for any services rendered in the line of his ordinary duties, may not lay claim for salvage. Neither may a tug, under ordinary circumstances, while executing its contract of towage. However, if a tug has not been negligent and, with her tow, is

overtaken by a storm of such violence that extraordinary exertions, involving exposure to injury or loss of the tug, are necessary to bring the tow to safety, she may be awarded additional compensation, beyond the terms of the contract, as a salvage award.

The service itself must be successful either in a complete rescue or in placing the imperiled property in a better position from which it is subsequently rescued. Even if a disabled ship is towed a thousand miles by a salvor and sinks at the harbor entrance, the time, labor and expense incurred are lost irretrievably.

It is a general rule that government employees, while engaged in the performance of their regular duties, may not claim salvage. For whatever assistance they render outside of their regular duties or employment they occupy the same status as any other salvor and may claim the award.

The courts have a wide discretion in awarding salvage. The amount and the method of distribution depend on the facts in each case. The character, skill, danger, labor and expense incurred by the salvors, the value of the property in peril and the value of the property risked by the salvors, the locality of the operations, and the time lost by the salvors—all enter into the court's calculations to determine the percentage of the value of the property saved to be awarded to the salvors. Besides the above reasons most courts are liberal in this bounty from motives of public policy in order that encouragement should be given future salvors to risk both life and property to save those in peril.

In late years, professional salvors have become institutions in all large and busy seaports. The courts encourage them by awarding large bounties when their efforts are successful. Their overhead expenses are extremely heavy, and it is only these large awards that induce them to be ready at a moment's notice to answer a hurried call for assistance. Most of the salvage work they do is by contract and the courts look with favor upon these if the negotiators are on equal terms and the salvor has not taken advantage of the unfavorable position of the endangered vessel, and the contract is not tainted with fraud or misrepresentation.

The amount of the salvage awarded is in the discretion of the judge. He apportions it among all those who participated, directly or indirectly, in rescuing the property. It is customary, however, for the court to award three-fourths of the amount to the owners

of the rescuing vessel and the balance to the master and members of the crew according to their ratings and services.

The word "tort" in legal language means a wrong committed for which the law demands compensation in damages. In admiralty the test of its jurisdiction is the "locality" where the tort was committed. Unless it occurs on navigable waters, either natural or artificial, admiralty has no jurisdiction. Many curious cases have come before the courts in this branch of maritime law, and, while the decisions in many of its phases leave them no longer doubtful, there still remains a border line along which many decisions are wholly irreconcilable. It is now recognized as established law that a ship is not liable, *in rem*, for damage she may cause to any structure attached to the shore, as a pier, a bridge, a warehouse, a floating but stationary dry-dock, or a marine railway. In a leading case a schooner rammed her jib-boom through a grain warehouse, tearing such a hole in the side that quantities of grain ran overboard. In another a ship on fire communicated the fire to buildings on shore whereby the buildings were consumed. In each case the court decided it had no jurisdiction. This means only that the admiralty court had no right under the Constitution to try the cases. The same judge sitting in the same chair could try them in his capacity as district judge hearing civil suits. There are many reasons, which will be stated later, why litigants usually prefer to get their cases before the judge sitting as a court of admiralty than as a common-law court.

If a ship is passing through a draw-bridge and, due to the carelessness or negligence of the bridge-tender, she is injured, the vessel has a right to sue the owners of the bridge before the admiralty court; if a stone is thrown by a person on shore and it injures a person on a ship the wrongdoer may be sued in admiralty. On the other hand if one on a ship throws a stone and injures a person on shore the latter must sue in the common-law courts and not in admiralty. Injuries by a vessel to a bug-light, to a submarine cable, to piles surrounded by navigable water, give a right to damages triable in the admiralty court.

The common law doctrine that contributory negligence bars recovery for personal injuries does not apply in admiralty. The award is very largely in the discretion of the court, and the amount of damages awarded will depend upon the degree of negligence of



the participants in each case, though many courts have given damages to persons who have been even more negligent in causing the loss or damage than the vessels.

Independent of statute there is no right of action in our admiralty courts for injuries resulting in death. In England to-day no such right exists even by statute to proceed *in rem* in admiralty against a vessel for causing death. The "Merchant Marine Act," passed in 1920, confers jurisdiction of such cases upon the admiralty courts and remedies thereby the curiously helpless position of the court to give relief in cases so purely maritime in their character.

Collisions between vessels, due to the negligence of one or both, are torts and give rise to a large proportion of the damage suits that occupy our district courts. For the purpose of avoiding collisions we have four sets of rules in this country: the International Rules which apply to the high seas outside of certain arbitrary limits fixed by the Secretary of the Treasury, the Inland Rules for coast waters and the connecting waters inside these fixed limits, the Rules of the Great Lakes and their Connecting Waters, and the Mississippi Valley Rules. Besides these rules local and port rules are enforced by the courts. They view these rules as so clear and explicit that, except for inevitable accident or inscrutable fault, collisions are considered due to negligence or fault of one or both vessels. Naturally, if one vessel alone is at fault she is responsible for all the resulting damage up to the full value of the negligent vessel. If both vessels are at fault the total damage is equally divided irrespective of the degree of fault of each. Herein lies a curious difference between the admiralty and common-law courts. "The common-law rule says, as each occasioned the accident, neither shall recover at all, and it shall be just like an inevitable accident, the loss shall lie where it falls. Admiralty says, on the contrary, if both contributed to the loss, it shall be brought into hotchpotch, and divided between the two."

Proceedings against a ship in an admiralty court are begun by filing a libel. The ship is then arrested and a representative of the United States marshal is left on board as a keeper or guard. The owner of the ship has no court notification of the arrest except as he may happen to see the copy of the warrant of arrest that the marshal nails to the mast or the door of the captain's cabin, or as it appears in a newspaper. To prevent the delay in loading

and sailing of a vessel under arrest it is usual for the owner to file a bond with the court as surety for the payment of any judgment that may be assessed against the ship. The ship itself is looked upon as an entity capable of making and executing contracts and agreements, committing torts, and satisfying all claims for damages or maritime judgments against her. Proceedings *in rem* bind the whole world; therefore the sale of a ship by an admiralty court purges her of all claims of every nature which are not included in the court decree. A ship in the custody of a state court will not be interfered with by a United States marshal, but the state court has no power to sell the ship and clear her of maritime liens such as the federal court has.

The proceedings in admiralty courts are quite simple, direct and informal. The judge decides questions both of fact and laws. Therefore, trial by jury is unknown; in fact, trial by jury is not permitted except on the Great Lakes, and here only by a curious clause in a statute passed in 1845 and now obsolete. It takes a vast experience in this technical branch of the law for a judge to decide correctly and justly questions of fact as presented by the evidence. It is notorious that a sailor makes a most unreliable witness. His ship or captain is never wrong, therefore the court must be a keen judge of human nature as well as of law in order to decide just how much of real truth is contained in the evidence of the sailor witness. This side of the sailorman's nature is not due to any lack of appreciation of the sanctity of his oath but to his loyalty to his ship. For this reason the courts are lenient as well as skeptical and prefer to draw their inferences from the general evidence and their knowledge of the ways of ships and the character of the men who follow the seas for a livelihood or for adventure.

Lawyers who practice in the admiralty courts are called "proctors." No branch of law is more technical than admiralty. Consequently it is necessary for a proctor in admiralty to be thoroughly familiar with the language of the sea, the customs of the sea, the rules of navigation, the construction and handling of vessels, in short, he must be a real sailorman in order to appear to advantage or on equal terms with his opponents. The judge is not easily deceived and soon sizes up the abilities of the opposing proctors. Possessed of this technical knowledge, and a legal one, the practice before the admiralty court is by no means difficult for the man of

ordinary talents. It is so clean and devoid of chicanery that it has been dubbed the "aristocratic" branch of law. Its very peculiarities, its radical differences from the excessive technicalities of the common law, its methods of procedure and the celerity with which a case is tried and decided, make it the chosen field of litigants even when other courts have concurrent jurisdiction.

## MINUTES OF ANNUAL MEETING, 1921

U. S. NAVAL ACADEMY, ANNAPOLIS, MD.,  
14 OCTOBER, 1921.

In accordance with Article V, Section I of the Constitution, two weeks' notice having been given, the annual meeting was held in the Board Room of the Officers' Mess.

Commander John Downes, U. S. Navy, Senior Member present, presided.

The minutes of the last meeting were read and approved.

The first and stated business being the election of officers, the following tellers reported the vote, having been appointed by the Vice-President ten days previous—

Commander E. D. Washburn, U. S. Navy.  
Commander D. A. Scott, U. S. Navy.  
Lieut. Commander J. L. Hall, Jr., U. S. Navy.

The tellers reported the results of the election as follows:

### *For President*

Rear Admiral B. A. Fiske, U. S. N.....	1093
Rear Admiral W. H. G. Bullard, U. S. N.....	293
Scattered Votes .....	15

### *For Vice President*

Rear Admiral H. B. Wilson, U. S. N.....	1299
Scattered Votes .....	30

### *For Secretary and Treasurer*

Commander F. M. Robinson, U. S. N.....	1057
Lieut. Commander R. A. Hall, U. S. N.....	291
Scattered Votes .....	11

*For Board of Control*

Captain John Halligan, U. S. N.....	941
Commander J. O. Richardson, U. S. N.....	884
Brigadier General Richards, U. S. M. C.....	819
Captain T. L. Johnson, U. S. N.....	803
Captain J. A. Furer (C. C.), U. S. N.....	761
Commander John Downes, U. S. N.....	711
Captain T. R. Kurtz, U. S. N.....	502
Commander W. R. Van Auken, U. S. N.....	442
Commander H. D. Cooke, U. S. N.....	401
Commander J. O. Fisher, U. S. N.....	396
Lieut. Commander S. E. Holliday, U. S. N.....	369
Commander W. W. Smythe, U. S. N.....	341
Commander I. C. Kidd, U. S. N.....	314
Commander Abram Claude, U. S. N.....	229
Commander John S. Barleon, U. S. N.....	201
Scattered Votes .....	37

The following officers were then declared elected :

*President*

Rear Admiral B. A. Fiske, U. S. Navy.

*Vice President*

Rear Admiral Henry B. Wilson, U. S. Navy.

*Secretary and Treasurer*

Commander F. M. Robinson, U. S. Navy.

*Board of Control*

Brigadier General George Richards, U. S. M. C.

Captain John Halligan, Jr., U. S. Navy.

Captain T. R. Kurtz, U. S. Navy.

Captain J. A. Furer (C. C.), U. S. Navy.

Commander John Downes, U. S. Navy.

Commander J. O. Richardson, U. S. Navy.

The Secretary and Treasurer presented his annual report as follows :

1. The cost of print paper, printing, binding, etc., has decreased approximately 15% in the past year, so that the printing cost of the PROCEEDINGS is approximately thirty-five cents a copy, leaving a printing loss of about ten cents a copy per issue. This loss added to the uncollected due and overhead expense gives a monthly loss of approximately \$1000 per month.

2. The sales of the Book Department have fallen off considerably during the last year, and the net decrease in surplus in that time amounts to about \$3000. This amount includes the depreciation in market value of bonds on 31 December 1920, as well as more than \$3300 of dues charged off as uncollectable.

3. The membership shows an increase of 215 over our last meeting. The present membership is as follows:

Honorary .....	3	
Life .....	140	
Associate .....	530	
Regular .....	4814	
		<hr/>
Total .....	5487	

Of these the PROCEEDINGS of about 400, as against 1500 last year, are held up owing to the fact that they are more than two years in arrears in dues.

4. The changes in membership during the year were as follows:

Resignations—		
Regular .....	251	
Associate .....	12	
		<hr/>
		263
Deaths—		
Regular .....	19	
Associate .....	6	
Life .....	7	
		<hr/>
		32
Dropped		
Regular .....	629	
Associate .....	0	
		<hr/>
		629
Total Loss in Membership .....		
	924	
New members .....		
	1139	
		<hr/>
Net gain in Membership.....		
	215	

5. The following Institute Publications have been revised during the year:

- Practical Manual of the Compass,
- Marine and Naval Boilers,
- Steam Turbines,
- Mechanical Processes,
- Manual International Law.

6. The following books and pamphlets have been published:
- How to Preserve Your Boiler, by Captain E. P. Jessop, U. S. N.
  - Composition for Naval Officers, by Professor C. S. Alden and Professor W. O. Stevens.
  - Seaman's Hand Book, by Lt. Comdr. R. Wainwright, U. S. N., and Commander M. F. Draemel, U. S. N.
  - Storage Battery Manual, by Lieut. Comdr. L. C. Dunn, U. S. N.
  - War on the Sea, by Captain Darrieus, French Navy, and Commander\* Rene Daveluy, French Navy.
  - General Index, Prepared by James M. Saunders.
7. The following books are in press or are under revision:
- Airplanes, Airships, and Aircraft Engines, by Lieut. Albert Tucker (C. C.), U. S. N.,
  - Reciprocating Engines,
  - Athletic Requirements,
  - Muir's Navigation,
  - French Reader,
  - Electrician's Text Book.
8. A revision of the following is contemplated:
- Naval Construction,
  - Radio Telegraphy and Telephony,
  - Seamanship Department Notes.

The report of the Secretary and Treasurer was adopted.

There being no further business the meeting adjourned at 8.15 p. m.

F. M. ROBINSON,  
*Commander, U. S. Navy,*  
*Secretary and Treasurer.*

## U. S. NAVAL INSTITUTE

### SECRETARY'S NOTES

**Membership** Life, regular and associate, 5514. New members, 32. Resignations, 5.

Practically the whole service receives the benefit of the PROCEEDINGS yet many officers, who read it monthly, are not members and therefore contribute nothing to the support of the Institute. Members are requested to urge non-members to join. Publication costs are now so high that the Institute is carrying a loss. The cost, per member, however, decreases with an increase in membership.

**Dues** The annual dues (\$3.00) for the year 1921 are now payable.

Regular and associate members of the U. S. Naval Institute are subjected to the payment of the annual dues until the date of the receipt of their resignation.

**Discussions** Discussion of articles published in the PROCEEDINGS is cordially invited. Discussions accepted for publication are paid at one-half the rate for original articles, or about \$2.25 a page.

**Address of Members** To insure the delivery of the PROCEEDINGS and other communications from the U. S. Naval Institute, it is essential that members and subscribers notify the Secretary and Treasurer of every change of address, without delay.



**Book Department** *The Institute Book Department will supply any obtainable book, of any kind, at retail price, postage prepaid.* The trouble saved the purchaser through having one source of supply for all books, should be considered. The cost will not be greater and sometimes less than when obtained from dealers.

The Boat Book, 1920, and The Landing Force and Small Arms Instructions, 1920, are now ready for issue. The price of the former is \$.50 and the latter \$1.00 per copy.

**Index to Proceedings** The attention of readers of the PROCEEDINGS is invited to the classified analytical index for numbers 101 to 200 inclusive, which is noticed under "Publications." This is a most complete index, which has been prepared at considerable expense in order to make readily available the information contained in both the articles and the notes of these issues. Only a limited number of copies are being printed. Price, bound in cloth, \$2.35; bound in paper, \$1.85.

**Articles** The Institute desires articles of interest to all branches of the service, including the Reserve Force. Attention is invited to the fact that the submission of articles is not limited to members, and that authors receive due compensation for articles accepted for publication.

All articles and discussions submitted by persons belonging to the navy for publication in the PROCEEDINGS must be in duplicate, one copy being signed by the author, which will be submitted to the Navy Department when the original is published, as required by General Order No. 46, of May 20, 1921.

**Reprints of Articles** The attention of authors of articles is called to the fact that the cost to them of reprints other than the usual number furnished, can be greatly reduced if the reprints are struck off while the article is in press. They are requested to notify the Secretary and Treasurer of the number of reprints desired when the article is submitted. Twenty copies of reprints are furnished authors free of charge.

Authors of articles submitted are urged to furnish with their manuscript any illustrations they may have in their possession for such articles. The Institute will gladly co-operate in obtaining such illustrations as may be suggested by authors.

Original photographs of objects and events which may be of interest to our readers are also desired, and members who have opportunities to obtain such photographs are requested to secure them for the Institute.

Whole Nos. 6, 7, 10, 13, 14, 15, 17, 144, 146, 147, 173, Notice 215 and 217 of the PROCEEDINGS are exhausted; there are so many calls for single copies of these numbers that the Institute offers to pay for copies thereof returned in good condition at the rate of 75 cents per copy.

ANNAPOLIS, MD., December, 1921.

#### INFORMATION INDEX

	PAGE
ADVERTISEMENTS, INDEX TO.....	I
PUBLICATIONS, U. S. NAVAL INSTITUTE.....	(2)
SPECIAL NOTICE .....	1906
TOPICS FOR ESSAYS.....	1997



# PROFESSIONAL NOTES

PREPARED BY

LIEUT. COMMANDER R. A. HALL, U. S. Navy

## GENERAL ARRANGEMENT

VESSELS BUILDING.	}	France .....	1941
NAVAL POLICY.		Germany .....	1948
MATÉRIEL.		Great Britain .....	1951
PERSONNEL.		Japan .....	1959
MERCHANT MARINE.		United States .....	1961
AERONAUTICS .....			1972
ENGINEERING .....			1977
NAVIGATION AND RADIO.....			1981
ORDNANCE .....			1982
MISCELLANEOUS .....			1983
CURRENT NAVAL AND PROFESSIONAL PAPERS.....			1984

## FRANCE

FRENCH NAVAL NOTES.—The French Navy, that could be said to be slumbering under the Leygues and Landry administrations, has this year resumed active life; the battle fleet has been restored to a war footing and has done much navigating and gun practice, whilst the concentration in Brittany ports of the ships of the *Voltaire* and *Hugo* classes and of numerous torpedo craft, supported by growing aerial and submarine flotillas, has caused France to become anew a potential factor in northern waters. On the other hand, there have been concluded at Lorient and at Toulon ballistic and aerial experiments of the highest value, and under the talented Chief Constructor Doyère the Section Technique has perfected the plans of the *croiseurs rapides* shortly to be laid down. All this does not prevent Minister Guist'hau from being hotly criticized for the delay in the execution of the cruiser programme as well as for the projected reduction in the navy estimates, and impatience is being manifested in Parliamentary quarters at the "naval stagnation."

There is a sign of the times in the election (valueless and illegal) as councillor by Charonne of the ex-mechanician Marty, the chief "hero" of the Black Sea rebellion. Marty, it is worth remembering, only found one supporter in the whole crew of a destroyer, and that individual was not a "marin," but an anarchistic workman serving as engine-room hand. The Charonne election points to the spread of Bolshevism in French industrial centres, as the consequence of liberal Boche subsidies, and it is an additional warning as to the vital importance of recruiting seamen on safe and rational lines: that is to say, among the seafaring classes, or at least among young men having the maritime vocation and electing to make their life's career on the stormy element. This obligation is rendered all the greater by the fact that as a rule French naval recruits commence their apprenticeship at fleet work when over 20 years of age. A counter-patriotic propaganda to oppose Bolshevist efforts is also required.

The recent sale of the 6500-ton *Gardecôtes Amiral Tréhouart*, that acted during the war as Toulon port guardship and was the most perfect representative of the *Jemmapes-Bouvines* class (1893-95), did not pass unnoticed in naval circles, as it is felt coastal ships have not said their last word in warfare, especially since Great Britain, the supreme naval power, had to have recourse to them under the test of the real thing. The designing of coastal armourclads is one of the most difficult tasks confronting naval constructors, for the reason that small *garde-côtes* are intended to fight against the most powerful battleships, and that no end of contradictory elements of strength have to be piled up within displacements too limited to contain them all. No wonder the ideal coast defence ship has yet to be found. In the *Amiral Tréhouart* class Gallic *ingénieurs* endeavored to correct the weak points which sea experience had revealed in the tough but low-freeboard, topheavy, and unseaworthy 7000-ton *Requins* (1885), and they brought into existence *petits cuirassés d'escadre* possessing nominally all the attributes of battleships, viz., good freeboard and habitability, 12-inch guns in closed turrets, and a complete 13-inch belt, together with a speed of nearly 17 knots, which was equal to that of the *Royal Sovereigns* of Sir William White. Splendid units on paper, those *cuirassés économiques* turned out to have their qualities too meagrely measured to be able to derive any practical advantage from them; they were mediocre—insufficient in every respect—and admirals who included them in their squadrons reported very unfavorably upon them. They were very little used either in peace or in war, and, all points considered, they have every right to be counted in the list of the few constructional blunders made by the Rue Royale Admiralty. And yet the small battleships now being constructed by minor navies, and notably by Holland and Sweden, represent, despite the advance made in speed, a similar mistake in conception.

The truth is that in small displacements, from 6000 to 10,000 tons, the best way to attain all-round mediocrity is to heap unreservedly qualities upon qualities, as French constructors are only too prone to do, instead of aiming at excellence in one or two respects, as the English have done with the *Marshal Soult*s or *Terrors*, that combine striking power and good anti-torpedo defence, to the detriment of speed and armored protection, also, like the old low-freeboard monitors of America that, by sacrificing nautical qualities, habitability, and speed, were made powerful hitters in fair weather and practically invulnerable to gunfire. In the *gardecôtes* line success resides in specialization and, above all, in the sacrifice of speed as recommended by the late Augustin Normand, the very French constructor who in his time placed France foremost in the production of speed. There is a chance that France, in default of too costly mastodon battleships, may try and utilize her recent ballistic discoveries in small semi-submersible and practically invulnerable all-armoured monitors mounting 450 mm. guns and capable in narrow seas of operating by means of both gun and torpedo against the heaviest battleships now projected. Whilst many experts see in *garde-côtes* an obsolete type of warship debarred of all practical value by the growing range of super-cannon batteries and of coastal aerial flotillas, others pin their faith in the virtue of seagoing instruments *de combat*, and their fertile imagination already pictures a revival of French sea power through the swarming along the coasts of our Republic of funnelless, tortoise-shaped monitors that will be (if built) a modern edition of the remarkable *Taureau* class of 1865 (2700 tons, 12 knots, single-fixed tower surmounted with heavy gun with all-round fire, armour carapace over the whole length and sides). The *Taureau* was designed at a time when Paris naval architects enjoyed pre-eminence, and there is much in the idea that could be modernized in these days of internal motors and submarines.

The aviation problem is, like all navigation problems, a question primarily of recruiting and training. The frequency of aviation mishaps, the terrific speed *avions de chasse* are attaining (over 300 kilometres per hour in last

week Etampes races), and especially the many difficulties that are peculiar to naval aviation, are reminders that without the right sort of personnel superior flying matériel represents no increment of fighting strength for navies. Now, it is no secret that French naval aviation, despite its wonderful strides on paper, has to contend with a growing shortage of trained pilots and mechanicians—a weak point the naval authorities have at heart to remedy, especially since the official report on the *Prinz Eugen* experiments has removed all doubt as to the vulnerability of the best armoured battleships to aerial bombardment. Up to the present young officers and seamen have not been over-anxious to join the aerial wing, not because of the dangers attaching to the aviation sport, but on account of the little esteem in which aviators are held in high quarters and of their consequent diminished chances so far as distinctions and promotions are concerned. Ministers of marine and admirals have at all times around them such a tremendous amount of merit to reward among their numerous staff officers and the friends of their staff officers that they cannot possibly think of those adventurous young men who, forgetful of their own interests, are flying somewhere out of the reach of flagships or of the *Rue Royale bureaux*. And yet the very sources of efficiency are endangered in a naval service when desert and reward are kept too long apart, when those in authority fail to understand that their primary duty is to stimulate and encourage true merits. Above all, no display ought to pass unnoticed of that bold initiative, of that manly courting of risks that are the distinguishing mark and honour of the naval profession. If these principles were applied in what regards the aeronautical branch of the service, if it were made a set rule for young officers to practice flying before being appointed to superior rank, there might be a chance of the "Aviation Francaise" asserting its predominance, but up to the present the chief incentives given to aerial progress have been of a verbal or literary order. A change, however, is to be made, and the flying *élite* is to receive more adequate recognition of its valour and fighting worth.—*Naval and Military Record*, 12 October, 1921.

FROM THE FRENCH POINT OF VIEW.—The attention of the French—and it may safely be added of the world—naval and political students is being centered on present Irish developments; and, no wonder, when are remembered the eventful history of Erin, her peculiar geographical situation, and the vast changes scientific progress is making in the conditions of maritime warfare, and especially in the offensive and defensive possibilities of advantageously-situated strategic centers. Now this description eminently fits the Irish Isle, that is spread on the western flank of England across her route of greater expansion, directly overlooking, so to speak, the outlets of those splendid maritime centers of activity and true arteries of English commercial life, the Severn, the Mersey, and the Clyde, besides being within commanding range of the northern round Scotland routes and of the channel highway. Indeed, considering the mechanism of the economical life of England and the fact that centuries of persevering toil have made her both supreme on the water and totally dependent on the stormy element for her very existence, Ireland may well be proclaimed to be, potentially, the most important strategic factor in the world, and it is not too much to say that a novel era will open in naval politics if seeds of anarchy can be permitted to fully germinate and bring forth their natural fruits, which are nominal independence and civil strife in Ireland.

Of course, it is very true that traditional hostility on the part of Ireland did not prevent England attaining her objects in past wars, and the question is whether the conditions of the naval game have changed so much as to enable Erin indirectly to do to-morrow what she could not achieve yesterday. This is a subject French students view with equanimity, for the two-fold reason that the least sentimental among them do not dream of a Franco-British war, and that France has no need of Ireland to be within striking range of England's shores and vulnerable centers (the

counter advantage being shared by England). But an independent Irish republic would provide an invaluable base of offensive operations for certain powers, with revolutionizing results so far as European strategy is concerned.

If nothing came out of the French 1689 and 1796 expeditions in Ireland this is due to the fact that these operations, besides being mismanaged, especially the second, had limited and purely military objects in view, viz., to drive the English from Erin's soil. Even if Chateaurenault and Hoche, after overcoming the tremendous difficulties that confronted them at sea and when landing, had completely succeeded in their daring attempts they would not yet have been in a position to utilize to advantage the fighting resources of Ireland, which was then in a chaotic state.

Totally different would be the prospects of an enemy of England assured of the co-operation of an independent and organized Irish Isle, surrounded with an inviolable and easily-watched and defended belt of territorial waters. To isolate Ireland, submarine and aerial developments no longer permit; to blockade it might prove ruinous, and yet it would have to be done to secure the freedom of the seas for English trade. Aviation is, as everybody knows, an essentially amphibious weapon, army avions being at all times available for coast defence or even for work over narrow seas, and a few modifications having proved sufficient to transform Army Spads and Nieuports into excellent navy scouts. Thus efficiency in military aviation means also, for any nation, efficiency in overseas fighting, at least within a certain limit. This is a good thing for the French Fleet when are considered the disappointing slowness of naval aviation progress and the frequent accidents for which any exercise or even a squall (a Latham 3-motor machine just capsized and totally lost in Cherbourg roadstead) is the pretext. The source of all the mischief, we are told, is to be found in the stubborn opposition of influential admirals of the retrograde school who have learned nothing by the war and, "in petto," do their utmost to discourage the development of the aerial branch, which they consider to be a danger for the existence of the old navy. Ministers Leygues and Landry at times waxed eloquent over the future of aviation, and Minister Guist'hau, though he has said less, managed to do more in practice. Unfortunately, with the ridiculous and disastrous ministerial instability which is the rule in our republic, "*les Ministres s'en vont, mais les amiraux restent.*" Not only do ministers change too often but also their chiefs of General Staff. We have had three of the latter within the last three years, viz., Ronarch, Salaun, and Grasset, whereas the Conseil Supérieur comprises admirals who have never left the Admiralty since 1916 or 1917, all distinguished gentlemen who combine the merit of seniority with the right sort of "piston." Their influence on the naval policy, nominally modest, is in reality predominating for the reason that they are assured of the morrow. With these bureaucrats lies the responsibility for the present condition of the aerial branch. There is little hope for the future, at least so long as an "*amiral-inspecteur de l'aéronautique*"—he, too, assured of the morrow—does not sit in the "*Permanente Section du Conseil Supérieur.*" Admiral Daveluy, who is not only the French Mahan, but also a practical aviator, could fill that job excellently, but then he is on the retired list, and "*le règlement*, sacred regulations, forbid his parading anew on the active scene even if the vital interests of his country should require. English broad-mindedness and the practice of hunting for the right man anywhere that he might be found, in disregard of set rules, are shocking to the tradition of the French *fonctionnaire* world.

Happily, matters stand in a different light in the army, which counted 7300 avions in 1918 and, out of 18,000 pilots (1914-18), lost no less than 4500 killed or grievously wounded. What aviation has done and what it is susceptible of doing to-morrow, everybody realizes, scores of flying generals being ever at work to remind the rising generation of the truth of

Foch's saying that he who rules the air will also rule on land. Of course, the notorious shortcomings of the French system of government (four Air Secretaries of State since 1918) and divergencies of views in high quarters, together with financial difficulties, have brought about a tremendous waste of aerial assets: aerial "cemeteries" are studded all over the land and the fine phalanx of "aces" has been dispersed to the wind. Such a spectacle of aerial ruin no other Allied country can offer.

Yet it would be a great mistake to look upon France as being reduced to aerial powerlessness. The creation two years since of a permanent "*Inspecteur Général d'Aéronatique*" in Marshal Fayolle has maintained fighting efficiency, assured steady progress in recruiting and training, as well as in machine designing, as was shown by the aerial maneuvers over Metz, where no fewer than 220 *avions de bombardement et de chasse*, mostly coming from Strasbourg, Neustadt, and Thionville, were gathered at a few hours' notice, and gave an impressive display of offensive and defensive tactics, which not the least accident or mishap came to mar. The Marshal-Inspector, who surveyed the operations both from the air and from land, remarked that this masterful demonstration of war readiness only gave an incomplete idea of the capabilities of the four regiments of the *division aérienne de l'Est* that could muster over 500 fighting units for war or for a prearranged theme of exercises. Moreover, this is only a small part of the whole French aerial force that is kept mobilized solely with a view to enforcing the execution of the clauses of the Versailles Treaty and in the interest of all the Allies.

The *Record* has called attention to the sad case of Lieut. Destremaux, of the 600-ton gunboat *Zelée*, who was severely reprimanded by Minister Augagneur for choosing to sink his boat in Papeete Harbour (Tahiti) instead of boldly going out and having a trial of strength on the high sea with the two 11,000-ton *Gneisenau* and *Scharnhorst*, and who subsequently died of grief at this undeserved treatment. Admiral Bienaimé is now urging that justice be publicly rendered to the memory of that gallant officer, who, he shows, did the right thing under difficult circumstances, and frustrated von Spee's designs by landing his guns and setting on fire the coal dépôt the Boches had come to seize.—*Naval and Military Record*, 28 September, 1921.

POST-WAR BATTLE PRACTICE.—For the first time since 1914 the Western Mediterranean was echoing last week the reports of big French naval guns engaged in normal battle practice. Hardly had the energetic Commander-in-Chief Salaün regained Toulon than he put again to sea with his few battleships—to the intense disgust of the traders of that *port militaire*—and for the thoroughly military purpose of carrying out his preliminary programme of "*écoles à feu*" that had been arranged on totally new lines with a view to applying war data and meeting the changed—and ever-changing—conditions of the naval war game, which means a departure from the former conventional training practice.

That conventional training does not pay is one of the far-reaching lessons of the Great War, and, as a matter of fact, of all wars. All armies and navies have sinned in that way, for the reason that conservatism is a natural and comfortable attitude of the human mind, and that it is more easy to keep on beholding and copying the past than to consent to the never-ending effort necessary to try and unravel the knotty and ever-growing mass of the fighting problems of the unknown future. Previous to the war, for instance, the great bulk of French naval men were humble followers of Mahan, professed contempt for the "*hérétique et anarchiste*" Amiral Aube, and had their eyes and admiration centered on Suffren and Nelson, whilst army officers spent their time worshipping in words and in deeds the great Napoleon, being never happier than when permitted to reproduce in mimic "*petite guerre*" incidents of Napoleonic battles. They



were thus napping and stationary, whilst the times kept moving on. The awakening was terrible, and all military critics agree in deploring pre-war training blunders. General Fonville ascribes the fearful losses of the French infantry in 1914 to the habitual and stubborn practice of errors in pre-war "*grandes manœuvres*" and to systematic disregard of the effects of new weapons; and General Serrigny (Sous-chéf d'Etat-Major General), in his conferences and literary publications, can hardly find enough sarcasm for those blind and unimaginative leaders who are so fond of seeking a guiding inspiration in the contests of the distant past instead of devoting their full attention and brain power to the study of present data and possibilities. Similarly, Admiral Daveluy, who in 1902 (*Le Combat Naval*) held a 3000 mètres range to be exaggerated ("*si ce n'était la torpille, la distance du combat devrait être à portée de pistolet, comme au temps de Suffren et de Nelson*"), was shown his error by the Jutland Battle, and expressed later his patriotic satisfaction that events spared the "insufficiently-trained French gunners" the necessity to have to fight at long range as British tars had to do.

And yet gunnery training in the French fleet before the war was of no mean order. In 1914, it will be remembered, the English First Lord, Mr. Winston Churchill, expressed surprise and admiration at the performances of the *canonniers* of Admiralissimo de Lapeyrère, in whose company he had witnessed an "*école à feu*," by the squadron of 18,000-ton *Dantons*; and older *cuirassés* like the *Justice* (Captain Schwérer) scored over 60 per cent hits 8500 mètres, the firing ships being all through the test kept moving on a zig-zag at a rate of 12 to 14 knots. It was even claimed then that battle practice was more exacting in the French fleet than in any other, and that French naval guns were the only ones to be habitually fired at full charge in time of peace, a privilege that was the twofold reward of perfect gun design and of perfect gun-powder (this did not prevent cases of gun-bursting in the war, *mais les exceptions confirment la règle*). Admirals Dartige du Fournet and Guépratte, who saw actual fighting in the Dardanelles and in Syria, had not enough praise for their gunners.

At the same time French gunnery had a tendency to routine work. It was earnestly preparing, with English methods and firing appliances, to fight exclusively in fair weather at moderate range and speed, in good 19th century style. With a tricky, go-ahead, matter-of-fact enemy like the Boches, who by tradition had the real thing in view, Admiralissimo de Lapeyrère might not, perhaps, have fared so well as had been expected.

Admiral Salaün is no longer considering battle practice as a mere sport for naval men, but as a means of all-round improvement in the fighting power of the fleet; and to that end *ingénieurs d'artillerie navale* and distinguished representatives of the Board of Construction have been invited to witness the comprehensive phases of the *écoles à feu* that obviously interest just as much those who make the guns as those who handle them. In this way, no end of time and *paperasserie* will be saved; there will be no more need of academic reports to be duly signed, counter-signed, stamped and sealed, read and discussed in committees, approved and confirmed before finally joining "*la montagne d'inutiles paperasses*" which is one of the glories of Rue Royale. From this direct co-operation, under realistic conditions, of the best naval and engineering brains in the service, steady progress may be expected, as gun designing is not a purely theoretical affair, as costly experience demonstrated. Scientific discoveries, however attractive, need to be confirmed and matured by realistic tests; and there can be no better source of inspiration for *ingénieurs* than the illusion of the real thing afforded by mimic action at sea; no field more suited for the fruitful exercise of imagination—and the use of imagination in warfare is revealing itself as being of capital importance.

By this interesting development of firing tests at sea, which will in time also be witnessed by experts of the aeronautical and chemical branches.

Admiralissimo Salaün is showing his appreciation of the military value of the factor time—the main factor of success, as remarked by the great Nelson. Range and speed are two aspects of the factor time; and to keep on progressing is not sufficient. What tells is to progress at a faster rate than all likely opponents, which means a task of immense magnitude, saddling the high command with unprecedented responsibilities. Commanders-in-chief must not be satisfied with attending to the immediate needs of the present; they must live in advance the war of to-morrow in the light of scientific progress that is never at a standstill, and remember the wonderful rate at which inventions came to birth all through the war under the pressure of events. So swift and deadly are the effects of new destructive inventions and so wide is their radius of action, that, next time, there will be no recuperation possible and victory will go to the side having acquired a decided lead in the scientific field. (The frightful consequences of the explosion of "agricultural" gases at Oppau are a proof that the revengeful Boches are already making their profit of those new principles of war.)

To surprise the enemy by new tactics and new weapons to which he can oppose no ready and adequate answer has always been a safe and economical means of securing victory. The Germans had a few surprises in store from which they derived temporary benefits, viz., special shells, smoke clouds, super-cannon, and asphyxiating gases. The English started the tanks. But as noted by General Serrigny, all these "surprises" were tried too soon and on too small a scale to produce decisive effects. The lesson has been learnt; next time will be a game of surprises; and in the field of gunnery, surprise (that is, relative superiority) might be effected by superior accuracy or range and by superior shell efficiency, realizing the ideal of true cannoniers, viz., to hit first and with crushing effects. The French work in the gunnery branch is carried on on progressive lines by the *Toulon Division de Canonage* (in the *Courbet*, *Patrie*, *Pothnau*) and *Ecole de Télémétrie*, and on shore by the *Gávres* permanent commission of experiments, as well as by the Paris, Ruelle, and Bourges laboratories, without mentioning the increasing contribution of Creusot and other gun-making firms to artillery researches. But it is, of course, at sea, by practice in all weathers of aerial fire control, that reliable accuracy at extreme range can be attained. The French fleet, just like its rival, is practicing the policy of the "*coup heureux*," or lucky shot, formerly so derived, and at the same time sparing no effort to make that "*coup heureux*" a deadly one for the enemy. The important fact is that the chemical science, since applied wholesale to the art of destruction, is adding wonderfully to the power of single shells, which is no longer limited to the same extent as before by caliber and weight, as the Lorient experiments have shown.—*Naval and Military Record*, 5 October, 1921.

PORT EQUIPMENTS.—The economical situation in France generally is not favourable to industrial enterprise of any kind, but the various Chambers of Commerce are fully aware that the countries which prepare for the recovery, when it comes, will reap the greatest benefit, and, aided by the government, a good deal of work is being carried out at the ports for dealing with a much larger volume of traffic than is possible at present. After obtaining her share of the ships surrendered by Germany, as well as the large tonnage conceded by Great Britain, France became the third maritime power, and, in view of the programme of colonial development, it has been found necessary to provide the means of utilising this merchant fleet, which will, moreover, extend its operations to South America, and more especially to the extreme east. Considerable harbour extensions are now in progress at Havre, Marseilles and elsewhere, and at all the ports a large amount of elevating and other machinery is being laid down. During the past week the Minister of Public Works paid an official visit to Bordeaux to inspect the installations that have been put down recently, notably the grain elevators and cold storage plants and machinery for rapidly unloading colliers.

Except for Calais, Dunkirk and Havre, where much was done to increase the harbor facilities during the British occupation, nearly all the ports were until recently lacking in the necessary material, and even at Havre the considerably increased tonnage imported at a time when fuel and commodities had to be purchased abroad obliged the local Chambers of Commerce to prepare a vast scheme of extension which is now being put in hand. The work cannot progress very rapidly on account of the shortness of funds, but much is already being done, and there is no doubt that in time the home merchant fleet will be in a position to deal with the bulk of the foreign and colonial trade.—*The Engineer*, 7 October, 1921.

**VOLUME OF FRANCE'S FOREIGN TRADE.**—For the first seven months of this year the weight of the goods imported into and exported from France amounted to 26,741,488 tons as compared with 34,193,171 tons in the corresponding period of last year. Imports this year were only two-thirds of the 1920 total, while exports were one-third greater.—*The Nautical Gazette*, 18 October, 1921.

### GERMANY

**THE EX-GERMAN FLEET.**—The book which Admiral von Reuter, the Commander of the German fleet which was sunk at Scapa Flow on June 21, 1919, has just published at Leipzig, is one of self-glorification rather than self-justification. He endeavours to convince his readers that he is proud to have acted as a Prussian officer in accordance with the Prussian tradition, but the boast sounds rather hollow. At this safe distance of time from the event, he assumes the whole responsibility for the scuttling, says he had no specific instructions or guidance from the German Admiralty, and shows what a brave deed it was, in sheltered waters, with land near at hand, no one to stop it, and means of rescue plentiful, to open the sea cocks and let his ships founder. It is the same sort of smoke-screen as that laid by Admiral Scheer two years ago when he declared that he rejoiced over the scuttling, which he considered as not only heroic but as one which had vindicated the honour (save the mark) of the German Navy! Were it not that the subject is now so very stale, one might be tempted to discuss again the curious turns which Prussian mentality takes at times.

Apart from this aspect, von Reuter's book, as a footnote to history, has some interesting points. He was beset by many obstacles during his period at Scapa Flow, as much from within as from without. Revolutionary extremists were powerful in his fleet, the officers were practically helpless, and the Admiral was afraid lest disorder might give the British authorities occasion for taking possession. For this reason he declined the British offer to place sentries on board to keep order. On his visits of inspection to his ships in the Flow he was obliged to use a British boat, having discovered that among the crew of his own pinnace were agitators who took this opportunity of spreading disaffection among the vessels' crews. What a commentary is this, however, on the state of the German Navy at the time! By the side of it, von Reuter's solemn deliberations as to his conduct appear almost ludicrous. It mattered so little what he did, seeing that the power of his fleet was destroyed by the indiscipline and discontent of his own men. His words show what the Ex-Kaiser meant when he said to Admiral Scheer on Nov. 9, 1918, "I have no longer a navy." On one occasion von Reuter found the extremists in the *Friedrich der Grosse* so out of hand that all he could do was to ask the British to ship them back to Germany. Two months after he records another mutiny, attributed "to the long strain of internment," and 4000 more men were sent back. Even the order for scuttling was in danger of miscarrying owing to the men getting wind of it, until a fresh order was drafted in a manner so as to appeal to the temper of the crews.

It must be left to the future historian to determine the exact degree of Admiral von Reuter's responsibility for the sinking. While it suits him to shoulder it in full, it is only fair to point out that the British Admiralty saved from his flagship the *Emden* two years ago a letter from Admiral von Trotha, Chief of the German Admiralty, dated six weeks before the scuttling, in which there was a passage which von Reuter evidently interpreted as most other people have done, as a clear hint that the ships must not be allowed to pass into the hands of the Allies. The Supreme Council, moreover, decided that the responsibility for the sabotage fell on the German Government and not on individual German officers, so that von Reuter escaped punishment, and additional ships were surrendered in consideration of those lost. Naturally, von Reuter does not explain that, in the long run, it made no difference to us whether the ships were sunk in Scapa Flow or saved to be used as targets, like the *Ostfriesland* in America and the *Thuringen* in France. No ex-German battleships or battle-cruisers were wanted, or are being preserved, by the Allies. But nothing can remove the added stain of dishonour from the escutcheon of the German fleet caused by the sinking.—*The Army and Navy Gazette*, 8 October, 1921.

HELIGOLAND.—The demolition of the fortifications of Heligoland are now said to have been satisfactorily carried out, and the special commission which has been watching the progress of the work is returning to England in the light cruiser *Delhi*. Naturally this country is more directly interested than any other in the disarmament of this ocean fastness. By many, the view is held that the strategic value of Heligoland, either to Germany or to ourselves, was greatly exaggerated, and the experiences of the war seemed rather to support this idea.

Heligoland served the Germans as an advanced base for destroyers and submarines and an airship station. But the value of an advanced base such a comparatively short distance from the coastal frontier did not prove of much advantage. The Germans ringed the island with mines for defensive purposes after the battle of Heligoland Bight. We did the same thing so as to bottle up the fortifications as a naval shelter, and the end of it was that the island became so perilous for either friend or foe to approach that it had a pretty dull time. The heavy artillery mounted upon it was seldom fired during the war. It was often asked why our fleet did not bombard it: The answer is that it was not worth while.

We could not possibly have done any material damage to the massive batteries without suffering injury, and probably very considerable injury, to the ships which attacked the island. Far removed as it was from the track of our sea communications, there was never any strategic reason for our vessels to approach Heligoland. Doubtless it was the most powerful sea fortress in the world, but it remained impotent throughout the war for the simple reason that we never gave its tremendous armament a chance to come into action. Whether we should have endeavoured to get into the Elbe but for this outpost astride the approach is a very moot point. The estuary to the Elbe is very strongly fortified, and our sea strategists never favoured the spectacular tactics advocated by Mr. Churchill of "routing the rats out of their holes."

Beyond affording a safe harbour, Heligoland was of very little use to Germany as a submarine base. It only brought the "U" boat flotillas two hours nearer to our northern coasts, whilst it was much more remote than Zeebrugge, Ostend, and Borkum for Channel and Atlantic depredations. As a destroyer and coastal patrol rendezvous it was probably of rather more utility. But its chief function was as an observation and wireless station, a rôle which any warship could have filled quite as effectively. We have never learnt precisely to what extent it was used as an air station. But as it only brought Zeppelins and seaplanes about half an hour nearer to any objective on this side the North Sea, the advantage in this respect was a very limited one.

Suppose Heligoland had remained in our possession on the outbreak of hostilities, what should we have done with it? Coming with such abruptness as the war did, more than likely the garrison would have been unprepared to withstand a long siege, and the navy would have had no easy task in maintaining them in the face of the efforts which the Germans would certainly have made to prevent this. The island was in no sense a necessary link in, or an obstruction to, our blockade organization. It merely served as a magnet for intensive minelaying, which would equally have happened to which ever power it had belonged.

As for the future of Heligoland, it will probably lapse into entire disuse. Its area is only the size of Hyde Park, and it cannot maintain any population without a steady flow of supplies from the mainland. The Germans have stopped the erosion of its shores by a colossal work of concrete buttresses, and they have built a magnificent harbour. But for commercial purposes this is valueless, as there is no trade to attract ships. Even fishing vessels do not use the island except for sheltering from the weather, since there is no market for their catches. In fact, it is hardly an exaggeration to say that Heligoland, dismantled as a fortress, is of no more use to Germany or any other country than the Mewstone is to Plymouth.—*Naval and Military Record*, 5 October, 1921.

**GERMANS BUYING MORE SHIPS.**—The following vessels delivered to the Allies have been repurchased by their original German owners:

Name	Tonnage
Badenia .....	6930
Erna Woermann .....	5528
Hersfeld .....	4487
Roma .....	2606
Rugen .....	1895
Tarpenbek .....	1871
Westfalen .....	5122

In addition, the White Sea Steamship Company has sold its steamer *Wolga* of 1098 gross tons to German buyers.—*The Nautical Gazette*, 18 October, 1921.

**NORTH GERMAN LLOYD'S NEW PASSENGER SERVICE.**—The North German Lloyd announces that it will start a regular passenger and freight service between Bremen and South America next month. The first sailing will be that of the steamship *Seydlitz* of 8008 gross tons, which carries first, second and third class passengers and will leave Bremen on November 3 next. On her outward voyage she will call at the Spanish ports Coruña, Villagarcia and Vigo. Later on the steamer *Yorck* of 8909 gross tons will be dispatched.

In addition to the above named vessels the Lloyd has the steamers *Hannover* and *Gotha* available of 9050 and 8050 gross tons respectively. It is reported that they will be put in the North Atlantic trade. The company has a number of new vessels building, some of which will be ready in the near future. One of these is the *Hindenburg* of 30,000 gross tons, a sister ship of the *Columbus* now named the *Homeric*. The *Hindenburg* is approaching completion at the Schichau Yard, Danzig.—*The Nautical Gazette*, 22 October, 1921.

**HAMBURG-SOUTH AMERICAN LINE.**—The Hamburg-South American Steamship Company has re-purchased from the Entente its former steamer *Santa Theresa*, of 3730 tons gross, which was to start on her first voyage to South America on October 6. For the same company the Reiherstieg-Schiffswerft, of Hamburg, has just launched the 9000-ton oil-burning passenger and cargo steamer *Espana*, which, it is hoped, will be ready in January for her first voyage to Brazil and Argentina.

The same line announces the resumption on February 16 next of its express passenger service to Brazil and La Plata. Its fast 20,000-ton steamer *Cap Polonia* is scheduled to depart on that date and will be followed a month later by the *Antonio Delfino*.—*The Nautical Gazette*, 22 October, 1921.

HAMBURG'S MARITIME TRAFFIC.—For the first time since the war, Hamburg's maritime traffic exceeded 1,000,000 net registered tons in September last. During that month 957 vessels of 1,017,738 tons arrived. In the corresponding month of 1913 the net tonnage arriving was 1,246,556.—*The Nautical Gazette*, 29 October, 1921.

### GREAT BRITAIN

NEW CAPITAL SHIPS.—*The Sunday Pictorial* learns that the specifications for the new battle-cruisers, tenders for which were lodged last Thursday, contain a clause reserving the right to the Admiralty to cancel the building at any time by paying the builders for work done.

The presence of this clause, described in the specification as "paramount," is taken to signify that the government does not intend to have its hands so tied at the Washington Conference on armaments that it could not agree to any proposal for reduction which aimed at stopping all new construction on hand.—*Naval and Military Record*, 12 October, 1921.

BATTLESHIPS AND WAGES.—Tenders for the four new capital ships were invited by the Admiralty more than month ago. In view of the magnitude of the work represented and the extreme difficulty of quoting a fixed price for any contract extending over several years at a period when the cost of labor and material is continually fluctuating, it may be some time yet before all the tenders are received. In shipbuilding circles it is felt that the Admiralty should make a departure from their customary practice by accepting bids on the cost-plus-profit basis. If this were done, each of the firms entrusted with new naval construction would receive an agreed percentage of profit on the ultimate cost of the work. The system worked well in America, where it was largely adopted in connection with war contracts. Meanwhile there appears to be much healthy competition among the ship-building and engineering firms to secure a share of the first big Admiralty contracts to be placed since the armistice. It is known that practically every firm in a position to undertake the work is preparing tenders.

Needless to say, the work people in the various shipbuilding districts have a personal stake in this matter. The allocation of one huge battle-cruiser would mean the payment in wages of millions of pounds, and the four ships together, including their machinery, armament, and equipment, will probably represent a wage bill of at least 12 millions, the disbursement of which will be spread over three years. Nor is it only in the ship-building centers that the putting in hand of the four new vessels will tend to mitigate unemployment. The manufacture of the thousands of tons of armor plate, of the main and secondary guns, and of the almost countless fittings required by a modern capital ship will keep an army of workpeople busy for a long time to come. It is, therefore, misleading to speak of naval construction as entirely non-productive. As a matter of fact, the economic situation is more likely to benefit than to suffer through our belated resumption of naval ship-building.—*Naval and Military Record*, 5 October, 1921.

NEW WARSHIP CONTRACTS.—The extracts given recently in the press of certain speeches by the Premier of New Zealand are likely to mislead. In one, Mr. Massey suggested that New Zealand would be called upon to contribute her share to the cost of building, and in another he spoke of

the new vessels as imperial ships. Of course Mr. Massey's remarks, cited without their context, may not have had the exact meaning ascribed to them, but in any case they seem to have been somewhat premature. The only ground in this country for the suggestion that the dominions may help to pay for the four new battle-cruisers is that contained in the speech by Mr. Lloyd George on August 18, when, in dealing with the results of the Imperial Conference, he referred to the feeling that the whole burden of defense should not be left to the Mother Country, but pointed out that the method of contribution must be left to the Parliaments of the dominions to decide, adding, "The proposals must come from themselves, and they are consulting their own Parliaments upon that particular question." It is hardly likely this passage had reference to the four new warships, which it must be remembered are merely intended as replacement ships. More reasonable is it to conclude that it referred to any future increase of the fleet if it became necessary, when the dominions might be asked to share the cost. Another source of mis-conception is the report that the contracts for the new battle-cruisers will provide for a cessation of work at any moment, the contractors receiving adequate compensation, so that the British representatives at the Washington Conference may be untrammelled by commitments in this respect. Here, again, the deduction is mistaken, because such a clause as this was inserted in very many contracts for munitions and war material during hostilities. The four new ships being merely to replace old ones, their construction cannot be stopped, whatever may be done at Washington, which is concerned with the future. It cannot be imagined that the British representatives to the Disarmament Conference are going there ready to cut down the British fleet even beyond a standard which the Admiralty have declared to be one involving risks to the security of the Empire.—*Army and Navy Gazette*, 22 October, 1921.

**DESTROYER'S SUCCESSFUL TEST.**—The *Seabear*, destroyer, last Tuesday underwent a most successful trial of her engines off Plymouth, under adverse conditions, maintaining a speed of 32½ knots at full power. The vessel was completed after the armistice, and this trial was more successful than those of any other destroyers of the S class which were built during the war.

The *Seabear* is one of eight of the class constructed by John Brown and Co., Clydebank. Since her completion she has been practically laid up with Devonport Reserve Flotilla, having only gone to sea for a week or so for the usual exercises. Her hull is foul, and this seriously affected the tests at a preliminary stage.—*Naval and Military Record*, 19 October, 1921.

**IRELAND AND THE NAVY.**—The contribution which Lord Grey, on his return to the political arena, made to the subject of the future relations of Ireland and the Empire was both weighty and timely. Many other speakers of authority have dealt at various times with the naval aspect of any settlement which may be arrived at, but the subject cannot be too often discussed or too much impressed upon the people of this country. It is indeed of vital importance that on the point of defence, an agreement which the naval authorities consider safe, practical and efficient, should be made. Whatever concessions are made during the present conference, whatever else is made the subject of bargaining, this cannot be one of them. It may be, as Lord Grey hopes, that the government are quite alive to the point, but our future security demands that there shall be no doubt about it.

The speech of Lord Grey is the more welcome because of certain mis-conceptions which have arisen from past utterances of some of his colleagues. Mr. Asquith, for instance, in November last, when he advocated for Ireland's "self-government in the same sense, neither greater nor less, in which it had been granted to and accepted by our great Dominions," said

that he could conceive of no motive which would lead the statesmen of a self-governing Ireland to squander any part of her meagre resources on a navy such as would be a constant menace to our shores. Yet, as Admiral Sir Cyprian Bridge pointed out, every independent or self-governing country which has a seaboard, desires to have a navy, and pretty nearly always manages to get one. He instanced the cases of Denmark, with a population of 3,000,000, and Norway, with 2,600,000, both of which nations have navies; and Chile, with less than 4,000,000, has a fleet and some very expensive ships. In fact, as the admiral picturesquely put it, a navy to many independent countries is what a dress suit is to a young man just out of his teens—a thing which he says he cannot, and certainly will not, try to do without. It costs money, but it is "the thing" to have it. So there you are! Supposing that Ireland, under a measure of self-government, should follow the example of the other great Dominions, and start a navy of her own. What then?

Lord Grey has but one stipulation to make in regard to this question, and it is one in which he will carry most reasonable men with him, viz., that the highest naval authorities at the Admiralty must be heard and their advice followed before a decision is arrived at. Mr. Asquith expressed his willingness last year to allow Ireland to start a navy, provided it was under the same conditions as those which were agreed to by all the Dominions at the Imperial Conference in 1911, which still regulate the status of the Colonial fleets. But, as Lord Grey points out, while as regards self-governing countries which are the other side of an ocean it is possible to have separate naval bases, units and authorities, he is quite sure that Great Britain and Ireland, situated as they are, cannot make the naval defence of either island sure unless that defence is under one authority. Equally as important as the actual provision of a separate Irish force is the matter of the use of Irish ports and docks. An American Admiral has spoken of the harm done during the war by Sinn Feiners who interfered with the Allied preparations. How much more harm might be done if Irish leaders were free to develop their own warships and naval ports. Even if they did not declare themselves hostile in a future conflict in which we might be engaged, they could do us untold damage by an unsympathetic attitude. It has been suggested that Bantry Bay and Lough Swilly should be made Imperial naval bases, with a zone around each under the administration of the Admiralty. The only safe plan is to take no risks, and to call into counsel those who in the school of war have learnt to appreciate those risks at their proper significance.—*Army and Navy Gazette*, 22 October, 1921.

BERMUDA.—A well-known weekly journal, which devotes considerable attention to naval and military matters, gives prominence to a suggestion from "a distinguished naval officer" on the subject of Bermuda. This says ". . . the United States would give anything in reason for Bermuda as an Atlantic fleet base. He believes she would even go so far as the whole of our indebtedness to her if we would deal. If so, why should we not?"

It cannot be expected that any proposal which involves the severance of the British Empire territory and subjects will be popular. But, apart from what is principally a sentimental view, and always presuming that the "distinguished naval officer" is correct in his surmise, the idea seems worth considering. The chief naval value of Bermuda to us lies in preventing anybody else from getting it. Otherwise the island is probably more of a liability than an asset. Such a suggestion involving any other country than the United States would be promptly vetoed. But the affinity between the two English-speaking races is of such a character as to place the idea in a category of its own.

From the purely strategic point of view it would only be reasonable to oppose the suggestion on the grounds that the United States may be a potential enemy. It is true that if we went to war with her Bermuda would



become a base of first-rate importance. But to dismiss this idea, as all sane men on both sides of the Atlantic will concur in doing, is to automatically neutralize the utility of the island to ourselves. The other western countries which bound the zone of which Bermuda is the *point d'appui* are not naval powers. Nor is it conceivable that we are ever likely to be brought into conflict with them, because the obligations which the United States assumes in consequence of the Monroe Doctrine imply responsibility on her part for their international relations.

On the other hand, the value of Bermuda as a naval base to the United States is self-evident. The island forms a natural outpost to her Atlantic zone. As to whether she would be prepared to go to the length suggested by a "distinguished naval officer" for its acquisition, this is a matter upon which it is obviously impossible for us to speculate. The subject is certainly not a new one, save in the sense in which it now crops up again. It undoubtedly takes an accentuated significance from the avowed resolve of the United States to become the dominant sea-power of the world. Our contemporary "recommends the Chancellor of the Exchequer to follow the matter up," and probably it is true to say that the mass of the tax-burdened people of this country would not be averse to seeing him do so. This is the political side of the question, however, and our interest in it, in these notes, is limited to the strategical aspects.—*Naval and Military Record*, 5 October, 1921.

**NAVAL AVIATION.**—We continue to receive information of a very depressing nature about the present standing and future prospects of naval aviation. If half these reports are true it would seem that the Air Ministry is still unduly favoring the army branch of flying at the expense of naval requirements. We hope that when Parliament meets some pointed questions on this subject will be addressed to the proper quarter. No secret is revealed by the statement that fleet flying work has been seriously hampered by shortage of personnel, material, and funds, though its possibilities are of enormous importance.

Officers responsible for the development of the navy's air service are confronted with the thankless task of producing bricks without straw. They are making the best of a bad job, and are able to point to what is really remarkable progress considering the means at their disposal, but all agree that the present system of a unified air service has proved a signal failure so far as the navy is concerned. Sea flying and naval aviation in general is governed by a set of conditions totally different from those that prevail in army air work. The trouble is, however, that military influence predominates at the Air Ministry, the result being that a disproportionate share of the money available is diverted to the military wing. The situation is viewed with deep misgiving by many of our best naval officers.—*Naval and Military Record*, 19 October, 1921.

**THE "LION."**—There is some satisfaction in the news that the *Lion*, having completed her refit, has become the flagship of Rear Admiral C. B. Miller, commanding the Rosyth Division of the Reserve fleet. This battle-cruiser, the pride of Devonport, has such a glorious war record that it would be rather sad to think of her "lying in cold obstruction," with a mere handful of people on board, whilst still a splendid fighting unit. Therefore it is pleasing to know that once again she enjoys the dignity of being a flagship.

Of course, time was—and not so very many years ago either—when our new warships, as soon as they had acquitted themselves on their trials, were passed into the dockyard reserve. The idea was to keep the latest and most formidable vessels in a state of pristine freshness as long as possible. Surprising as it now appears, it took a long while for the fallacy of this notion to be dispelled. Experience was all the time proving that a warship maintained in full commission was much more war-worthy than

a vessel of corresponding age laid at rest in a dockyard basin. Naval officers long raised a voice of protest against this procedure without any result, and it was only the lessons of successive maneuvers, with their regular crop of lame ducks amongst the specially-mobilized ships, which caused the system to be abandoned.—*Naval and Military Record*, 5 October, 1921.

**FLOATING DOCKS.**—Among the material that Germany was required to hand over to the Allies in accordance with the Peace Treaty were a number of floating docks, including several which had been specially built to take the largest ships of the German fleet. These have duly been delivered, and it is understood that the largest of them are being retained by the Admiralty for experimental purposes. Considering that the lifting capacity of these docks is about 39,000 tons they would appear to be a valuable acquisition, for with the solitary exception of the *Hood* all our present capital ships have a displacement considerably below this figure. If not required at home, the ex-German docks might prove useful at oversea naval bases, though even there they would have to be replaced by larger docks when the new type of capital ship, with a displacement exceeding 40,000 tons, comes into service.

When Germany first began to build dreadnoughts, which necessitated the provision of new dock accommodation at her naval ports, she decided to go in for the floating type as being cheaper and more quickly constructed than graving docks. The former are less durable, but in view of the steady and apparently unending growth of warship dimensions this was not a serious objection. It was reported just before the war that a floating dock of 50,000 tons was under design for the Germany Navy. The dock problem will certainly become urgent if the conference at Washington fails to impose a check on the development of naval armaments. The strategic requirements of the Empire will then render it necessary to provide docks of great capacity at the principal fleet bases in the Pacific, and in order to reduce expense it may be advisable to build floating docks instead of excavating dry docks. That, however, is a point which experts alone can decide. The presence in England of several big floating docks designed for the German Navy will doubtless assist the Admiralty engineers in determining the most suitable and economic type for our future needs.—*Naval and Military Record*, 12 October, 1921.

**THE AIRCRAFT-CARRIER "EAGLE."**—The aircraft-carrier *Eagle*, which, as the Chilean battleship *Almirante Cochrane*, was taken over by the Admiralty in the early days of the war, is rapidly approaching completion at Portsmouth Dockyard, and appointments are now being made to her in readiness for commissioning. Amongst those which have thus far been announced is Squadron-Leader F. J. Rutland. This officer, who has a very fine war record, will be in charge of that portion of the personnel and equipment which comes under the administration of the Air Ministry.

The *Eagle* herself is commanded by Captain Eric Dugmore, but although, of course, under the Naval Discipline Act he has complete jurisdiction over everybody on board, the existing system does unquestionably set up a duality of control. Air work is highly specialized, and needs specific qualifications quite as much as gunnery, torpedo, and other scientific branches. But whereas all the officers of these respective branches belong wholly to the navy, the squadron-leader is not under the Admiralty at all. The spirit of camaraderie and good sense will ensure harmonious working between the captain of the ship and the captain of the airmen; this, moreover, is not due to the system, but in spite of it.

We return to the contention that as airwork is now as much a feature of naval organization as submarine work, it should form an integral specialist branch of the sea personnel. If the *Eagle* wants more airmen, more machines, more equipment, as things are now ordered the demand has to be made through her squadron leader to the Air Ministry. Even admit-

ting that the system may work quite smoothly owing to the loyalty of the officers serving under it, what is to be argued in its favor as against the principle of direct control which would result from bringing the naval side of the Royal Air Force under the Admiralty?

Any complication of administrative methods is bound to militate against efficiency in wartime. That naval officers are quite capable of successfully specializing in aerial work was conclusively proved by the very fine service rendered by the Naval Wing of the Flying Corps during the war. This was a distinct naval unit under the Admiralty. Had it continued it would unquestionably have produced officers combining the double qualifications for commanding a ship in a fleet and acting as squadron-leaders. As things stand, it is quite conceivable that differences of opinion might arise between those who hold these distinctive appointments. The captain of the ship might consider it advantageous to place his vessel in a certain tactical position: the squadron-leader might want her somewhere else. We do not say that such a situation is very probable, but the fact that it is certainly possible reveals the defect of the existent system.—*Naval and Military Record*, 28 September, 1921.

**MARRIED NAVAL OFFICERS.**—The burning question of an allowance for married naval officers, similar to that paid to officers of the army and air force, would seem from certain statements in the newspapers recently to have advanced another stage. The rumors are twofold—first, that the whole matter has now gone from the Admiralty to the Treasury, and, secondly, that the allowance asked for is a consolidated one of fifty pounds per annum, irrespective of the number of children or the rank of the recipient. While it seems quite on the cards that the Admiralty have come to a conclusion on the matter, and have put their proposal forward to be considered in its financial aspect, it seems hardly possible that the second rumor can be correct. It will be two years on December 31 since the allowance paid in respect of officers' children during the war was withdrawn. Nothing has taken its place. On the other hand, as the Secretary for War stated in a speech on the Army Estimates in March last, "the State has recognized that officers over 30 and soldiers over 26 may be expected to be married, and it no longer refuses to recognize the increased responsibility that marriage brings." Admiralty officers have admitted that the matter has received favorable consideration by the board. Naturally, however, a good deal in the present day depends upon whether the Chancellor of the Exchequer will commit himself to the increased liability. While admitting that this is not the most suitable time to ask for more public expenditure, two points may be urged—one, that the Admiralty, as Admiral Sir Dudley de Chair has said, has not only since the armistice practiced the greatest economy, but has set an example to other state departments in so doing; the other, that the question must be considered in the light of its influence on the contentment and therefore the efficiency of the naval service. Once the claim of the sea officer to a marriage allowance is admitted to be just, it is putting an unfair tax on his zeal and public spirit not to meet the claim fairly. Considered in this light, it is obvious that to give £50 a year to the naval officer while his comrades in the other forces receive three or four times as much is ridiculous. More in accordance with naval custom would be a line of demarcation between commissioned and other officers, unless a further distinction is to be made and the allowances of army and air force officers are to be made contingent upon the index figures of the cost of living, while the proposed figure for the navy is to be a basic rate, irrespective of such fluctuations.—*Army and Navy Gazette*, 22 October, 1921.

**R. N. R. COMMODORES.**—The first award of the rank of commodore in the Royal Naval Reserve has just been made under the revised regulations

for this force. The distinction goes to Captain Charles A. Bartlett, C. B., C. B. E., who is the senior R. N. R. member of the newly-formed Advisory Committee. This grant of the rank of commodore for an indefinite period, and irrespective of the appointment held by the recipient, is something new in our naval organization, and it will be interesting to see if in time it extends to the regular list of the Royal Navy. It is the more curious that it so soon follows the abolition of the relative rank of brigadier general in the army. More than once of late years it has been suggested that all captains in the navy should be called commodore, and that all lieutenants, R. N., should be captains. Probably few of the present generation of naval officers know that the rank and title of commodore did not exist, officially, until after the battle of Trafalgar. The late Rear Admiral Sir R. Massie Blomfield, who wrote an instructive article on the subject in the *Journal of the Society for Nautical Research* in March, 1914, traced its origin to the States General and the Zealand Admiralty on the outbreak of the Dutch War in July, 1652. The title came over to us, with King William III, as "*commandeur*" (with the accent on the first and last syllables), and was vulgarized into its present form.—*Army and Navy Gazette*, 22 October, 1921.

ROYAL NAVAL RESERVE.—In view of the sympathetic interest we have always taken in the officers of the British Marine Service, it is with particular pleasure we note that a general revision of the position of the officers of the Royal Naval Reserve has been arranged. Those who have been in close touch with the subject have appreciated the dissatisfaction that has clearly existed for years past as to the conditions under which officers have served in this auxiliary service of the Royal Navy. It is no doubt due to the remarkable work done by the officers of the Royal Naval Reserve during the War which has impressed the powers that be with the necessity of clearly indicating that a unit of our fighting force which has done such valuable service is one of the claims of which cannot be disregarded. We understand that the Admiralty have decided to set up a permanent Advisory Committee which in the course of its duties will have to keep completely in touch with the general trend of opinion, with regard to the acquirement of particular knowledge affecting the Royal Naval Reserve, so as to be in a position to offer sound advice to that service, and through it generally to the Mercantile Marine. The chairman of the committee is to be the admiral commanding coastguards and reserves, who is to be assisted by such members of his staff as he may think necessary. The composition of the committee is to be of a thoroughly representative character, and will include the registrar-general of shipping and seamen, and representatives from the Chamber of Shipping and the Shipping Federation, a representative R. N. R. officer of captain's rank on the retired list, two representative R. N. R. officers of captain's or commander's rank on the active list, a representative engineer officer, R. N. R., either on the retired or active list, as may be found most suitable, a representative accountant officer, R. N. R., on the active list, and an officer on the staff of the A. C. R. to act as secretary to the committee. It is interesting to note that already Captain C. A. Bartlett has been elected as acting for the executive branch, and Mr. W. J. Willett Bruce as representative of the engineer officers. As is well known, these two prominent Liverpool officers are representative officials of the White Star Line, the former being the marine superintendent and the latter the superintendent engineer. Each has been an officer of the R. N. R. for a number of years, but both are now on the retired list. It now remains for the executive and engineering officers of the R. N. R. to further the work of the committee when fully set up by rendering every assistance and support by giving advice as to the actual conditions brought into being when the new regulations come into force, otherwise it is clear that the new committee will be unable to do justice to the important work which they have been elected to deal with. This effort on the part of the Admiralty is deserving of the greatest encouragement,

as the new move appears to us to form a direct and comprehensive means for doing away with much misunderstanding, and we might almost say injustice, with reference to complaints that have been raised from time to time in the past. The Auxiliary Service has shown itself of the greatest possible utility to the nation in the time of crisis, and on that ground alone is deserving of every reasonable encouragement which the authorities can extend to it.—*The Marine Engineer and Naval Architect*, October, 1921.

**LLOYD'S RETURNS OF NEW VESSELS BUILDING.**—According to Lloyd's Register of Shipping, 1475 merchant vessels of 5,542,978 gross tons were under construction on September 30 last. The showing by countries is as follows:

Countries	No.	Gross tonnage
Belgium .....	9	25,335
British Dominions .....	54	144,460
Brazil .....	1	2,170
China .....	6	15,505
Denmark .....	38	82,233
Esthonia .....	23	7,010
Finland .....	14	8,104
France .....	87	350,681
Greece .....	1	600
Holland .....	143	349,122
Italy .....	133	397,544
Japan .....	46	186,782
Norway .....	53	77,339
Portugal .....	43	17,496
Spain .....	17	75,017
Sweden .....	38	86,646
United Kingdom .....	700	3,282,972
United States .....	69	433,962
	<b>1475</b>	<b>5,542,978</b>

Vessels under construction in British yards for foreign countries were as follows:

Countries for which intended	No.	Gross tonnage
Argentine .....	6	8,800
British Dominions .....	23	82,815
Belgium .....	4	11,260
Chile .....	4	18,800
Denmark .....	5	19,840
France .....	41	223,181
Greece .....	4	18,920
Holland .....	25	211,914
Italy .....	3	53,000
Japan .....	4	25,200
Norway .....	35	112,814
Poland .....	1	1,200
Portugal .....	1	200
Roumania .....	1	3,550
Spain .....	9	27,460
Sweden .....	1	5,170
United States .....	3	24,400
Flag not stated .....	44	144,345
	<b>214</b>	<b>992,869</b>

—*The Nautical Gazette*, 21 October, 1921.

**LLOYD'S INCOMPLETE SHIPBUILDING STATISTICS.**—The quarterly shipbuilding returns of Lloyd's Register are being adversely criticized both here and abroad for their failure to afford a true indication of prevailing conditions in the shipbuilding trade. They reveal that, outside of Germany merchant vessels of 5,542,978 gross tons were under construction on September 30, in the various maritime countries, of which 3,283,972 tons, or almost three-fifths, were under way in the United Kingdom. But as work had been stopped on 1,563,000 tons of the total reported, the tonnage of the ships on which work is actually proceeding was only 3,980,000 tons. In other words, Lloyd's figures are so presented as to give the impression that the world's shipyards are engaged in turning out 40 per cent more tonnage than they are actually building.

For the two and one-half years preceding March last, Lloyd's statistics have reported a steady increase in the amount of work on hand in United Kingdom yards. Any one not familiar with actual conditions would have been justified in concluding from these figures that the prospects of the British shipbuilding industry were of the most rosy description. Exactly the reverse was the case, however. The gain in the amount of tonnage reported was not due to an influx of new orders, but mainly to the starting of work on old contracts which could not be undertaken during the war. What Lloyd's Register should publish is a tabulation of all new shipbuilding contracts awarded in each quarter. Such a compilation would afford a far better means of gauging the real state of the world's shipbuilding industry than the mass of figures now presented with their accompanying explanations and qualifications.

Lloyd's September returns call attention also to the continued decrease in the tonnage under construction in this country. This amounts now to 433,962 tons or only 10.5 per cent of what it was in March, 1919. Alongside of the 3,282,972 tons reported for Great Britain, America's prospective output makes but a sorry showing. It should be pointed out, however, that the figures for the United States represent work in progress, while the British total includes many suspended contracts. If this postponed construction be deducted, the British showing shrinks to 2,095,000 tons. Furthermore, the amount of tonnage completed in United Kingdom yards compares very unfavorably with pre-war times. Instead of totalling 23 per cent of the total work in hand at the beginning of each quarter as in 1913, it has only reached 8½ per cent during the first three-quarters of this year. Great Britain has a decided lead over the United States in the amount of vessel construction on hand, but it is made up largely of delayed tonnage which should have been delivered a year or so ago. Had no strikes intervened to prevent the prompt completion of ships in England, the new construction figures in the United Kingdom and this country would have been much nearer on a parity. Both in Great Britain and the United States the shipbuilding industry is suffering from a dearth of new orders and is faced with a complete standstill in the near future.—*The Nautical Gazette*, 22 October, 1921.

## JAPAN

**THE JAPANESE NAVY.**—Many erroneous statements have been published both in Japan itself and in America concerning the Japanese naval programme. On the one hand we find newspapers in Japan solemnly asserting that the project of 1920-28 is in no sense a reinforcement of the navy, but simply a scheme for replacing obsolete material. On the other hand, a section of the American press declares the Japanese programme to be the most ambitious measure of its kind ever introduced and to represent a manifest bid for supremacy in the Pacific. In view of these contradictory interpretations, and of the fact that Japan's naval armaments are now attracting more than ordinary interest and will doubtless form one of the chief subjects of discussion at the Washington conference, the following

*exposé* will be read with interest. It has been transmitted to me by the Imperial Navy Department at Tokyo, which invariably shows the greatest courtesy to inquirers who apply for information through the proper channel:

It was after the Sino-Japanese war, but before the conflict with Russia, that the Imperial naval authorities realized the necessity of possessing two battle squadrons, and accordingly drew up a programme to that effect, the numbers stated being the irreducible minimum required for the defense of the Island Empire. Consequently, on the outbreak of war with Russia the Japanese Navy had two squadrons, each consisting of six capital ships, *i. e.*, six battleships and six armored cruisers. From the experience gained in that war the Navy Department resolved to form two squadrons, each comprising eight capital ships, each unit to be less than eight years old from the date of its completion. This was the inception of the so-called "8-8" scheme. Just at that time, however, there occurred a far-reaching modification in the design of capital ships, *viz.*, the appearance of the dreadnought. This event had the effect of rendering all previous capital ships obsolete, and Japan therefore found herself faced with the necessity of building 16 vessels of the new enlarged type. Owing, however, to the financial situation, the problem became one of great difficulty and the navy was forced to be content for the time being with a building programme of 12 or 14 capital ships. This reduction, however, was well known to be merely temporary, and the ultimate aim of placing in commission a fleet of 8-8 ships was repeatedly announced in both Houses of Parliament.

The 1920-28 Programme was sanctioned by the Imperial Diet in July, 1920, and when the previous and present schemes are completed Japan will be in possession of a fleet having 16 capital ships of the first class. This establishment will be reached at the end of March, 1928. The programme sanctioned 14 months ago embraces the following new construction: Battleships, 4; battle cruisers, 4; cruisers, 12; destroyers, 32; gunboats, 5; fleet auxiliaries, 18; and a certain number of submarines.

The remaining eight ships to be included in the 8-8 fleet had previously been authorized. They are the battleships *Nagato*, *Mutsu*, *Kaga*, and *Tosa*, and the battle cruisers *Amagi*, *Akagi*, *Atago*, and *Takagi*. The two last-named are not yet begun, but preparations are in hand for laying their keels early next year.

To the foregoing official statement I may add some remarks contained in a letter which I received last June from a Japanese naval officer who is well known and highly esteemed in this country. "Judging by what appears in the press," he wrote, "one would suppose that Japan and the United States were building their war vessels against each other. This, however, is not the case. Our present naval scheme was originated as early as the year 1906, that is, just after the Russo-Japanese war, in accordance with the tactical opinion of our naval experts. During that war the United States of America gave us every possible assistance, and there could be no possible reason for imagining that our naval scheme was directed against the United States. The current American naval programme was, as you are no doubt aware, authorized in 1916, just before they entered the Great War. I cannot believe that it was put forward with any idea of competing with Japan at that moment. Most probably the Americans took a broader and finer view of the matter. Present naval construction both in the United States and Japan is, therefore, merely following out the old schemes laid down by the respective governments. At the present time no other country is building capital ships, and thus the idea has taken root that the two powers which are building such ships must naturally be building one against the other!"

The latest mail advices indicate that the labor dispute in the Kobe ship-building yards was settled rather more than a month ago. No fewer than 40,000 men had been idle for nearly six weeks, and, although there were one or two collisions between the strikers and the police, which resulted

in bloodshed, the dispute on the whole was conducted with exemplary moderation on both sides. The two principal yards affected were the Kawasaki and the Mitsubishi. At the former yard work was suspended on the battleship *Kaga*, which is still on the stocks, and on the light cruiser *Oh-i*, which is fitting out for sea. The *Kaga* was to have been launched on September 22, but she is not now expected to take the water before the end of this month (October). At the Kawasaki establishment the building of a considerable number of small war vessels has been delayed by the strike, among them being submarine *No. 27* and several destroyers. At no time during the labor conflict was any act of sabotage attempted against the warships building and completing in the yards.

Submarine *No. 24*, one of the newly-completed big ocean-going boats, had a narrow escape from destruction on July 19. While lying in Hiroshima Bay a fire broke out in the galley and spread to the adjoining torpedo room. Early efforts to extinguish the flames were unsuccessful, and they were not mastered till several compartments had been flooded. There were fortunately no casualties, but the damage to the interior of the boat is very serious, and will take a month or two to make good. On August 8 a less serious accident occurred to the *Fuso*, a battleship of the First Squadron, under the command of Admiral Tochinai. While engaged in night maneuvers outside the Bay of Sahegi she damaged her starboard propeller by striking a rock or some other obstruction, and was compelled to return to Kure for repairs. The *Fuso* seems to be an unlucky ship, for a month or two previously a large proportion of her company had been down with dysentery.

I am officially informed that the ships of the Japanese Navy in full commission are now distributed as follows:

First Squadron, comprising 3 dreadnoughts, 3 pre-dreadnoughts, 1 cruiser, and 16 destroyers.

Second Squadron, comprising 2 battle cruisers, 1 cruiser, 10 destroyers, 1 coast defense ship, and 4 submarines.

Third Squadron, comprising 3 pre-dreadnoughts, 3 cruisers, 6 destroyers.

In addition there are three cruiser squadrons abroad, viz:

In Chinese waters—1 cruiser and 5 river gunboats.

In southern waters—2 cruisers.

Training Squadron—2 cruisers.

Several old vessels are retained in commission as tenders to the various schools or for purposes of harbor defense. All other vessels are in reserve. Generally speaking, one-half of the vessels of the navy are in commission, while the remainder are in reserve.—*Naval and Military Record*, 5 October, 1921.

## UNITED STATES

TRIALS OF FIRST ELECTRIC COAST GUARD CUTTER.—The official sea trials of the *Tampa*, the first of four electrically propelled coast guard cutters to be placed in service by the Treasury Department, have been completed off the Pacific Coast with entire success.

The *Tampa* was built by the Union Construction Co., Oakland, Cal., and the electrical apparatus was furnished by the General Electric Co. She is 240 feet long with a beam of 39 feet and a displacement of 1600 tons. Her contract speed of 16 knots was exceeded during the trials.

The main propulsion equipment consists of two oil burning water tube boilers and a Curtis turbine directly connected to an A. C. generator supplying electric power to a 2600 h. p. synchronous motor giving a propeller speed of 130 r. p. m.

The control equipment consists of a control group and a panel, so arranged that it can be either operated electrically or in case of an emergency, by hand. Two exciters, one being a spare unit, furnish current for the excitation of the generator and synchronous propulsion motor and also power for driving various auxiliaries, such as the blower motor, steering gear, the gypsy, refrigerating plant, laundry and lighting equipment.—*The Nautical Gazette*, 22 October, 1921.



**NAVY DEPARTMENT—BUREAU OF CONSTRUCTION AND REPAIR**  
**VESSELS UNDER CONSTRUCTION, UNITED STATES NAVY—DEGREE OF COMPLETION,**  
**AS REPORTED OCTOBER 31, 1921**

Type, number and name	Contractor	Per cent of completion			
		Nov. 1, 1921		Oct. 1, 1921	
		Total	On ship	Total	On ship
<b>Battleships (BB)</b>					
45 Colorado.....	New York S. B. Cpn.....	83.0	81.6	80.7	79.2
47 Washington.....	New York S. B. Cpn.....	69.8	63.6	69.7	53.5
48 West Virginia.....	Newport News S. B. & D. D. Co.	64.0	57.3	62.5	52.5
49 South Dakota.....	New York Navy Yard.....	35.2	27.7	34.6	27.7
50 Indiana.....	New York Navy Yard.....	33.2	35.1	32.5	24.3
51 Montana.....	Mare Island Navy Yard.....	27.6	19.1	27.6	19.1
52 North Carolina.....	Norfolk Navy Yard.....	36.7	27.1	36.6	27.1
53 Iowa.....	Newport News S. B. & D. D. Co.	29.9	25.5	29.5	25.1
54 Massachusetts.....	Beth. S. B. Cpn. (Fore River)..	10.4	3.9	10.4	3.9
<b>Battle Cruisers (CC)</b>					
1 Lexington.....	Beth. S. B. Cpn. (Fore River)..	26.7	17.8	25.5	16.5
2 Constellation.....	Newport News S. B. & D. D. Co.	15.5	13.7	14.5	12.0
3 Saratoga.....	New York S. B. Cpn.....	29.4	22.2	28.4	20.1
4 Ranger.....	Newport News S. B. & D. D. Co.	2.9	1.2	2.7	1.1
5 Constitution.....	Philadelphia Navy Yard.....	11.7	6.8	11.1	6.3
6 United States.....	Philadelphia Navy Yard.....	11.1	6.2	10.7	5.9
<b>Scout Cruisers (Light Cruisers CL)</b>					
4 Omaha.....	Todd D. D. & Const. Cpn.....	96.8	89.6	94.7	87.9
5 Milwaukee.....	Todd D. D. & Const. Cpn.....	93.7	86.3	92.5	82.5
6 Cincinnati.....	Todd D. D. & Const. Cpn.....	87.4	80.8	87.4	80.8
7 Raleigh.....	Beth. S. B. Cpn. (Fore River)..	63.7	45.6	63.7	45.6
8 Detroit.....	Beth. S. B. Cpn. (Fore River)..	71.6	54.1	68.5	50.6
9 Richmond.....	Wm. Cramp & Sons Co.....	78.1	70.1	74.1	64.1
10 Concord.....	Wm. Cramp & Sons Co.....	71.1	60.1	68.1	53.1
11 Trenton.....	Wm. Cramp & Sons Co.....	52.1	39.1	51.1	35.1
12 Marblehead.....	Wm. Cramp & Sons Co.....	47.1	33.1	46.1	30.1
13 Memphis.....	Wm. Cramp & Sons Co.....	40.1	26.1	40.1	25.1
<b>Auxiliaries</b>					
Repair Ship No. 1, Medusa (AR 1).....	Puget Sound Navy Yard.....	70.6	56.7	69.3	53.9
Dest. Tender No. 3, Dobbin (AD 3).....	Philadelphia Navy Yard.....	66.4	66.1	66.3	66.1
Dest. Tender No. 4, Whitney (AD 4).....	Boston Navy Yard.....	36.8	33.3	34.9	31.1
Sub. Tender No. 3, Holland (AS 3).....	Puget Sound Navy Yard.....	21.5	5.5	21.5	5.5
Aircraft Tender, Wright (AZ 1).....	Tietjen & Lang.....	96.1	.....	92.1	.....
<b>Patrol Vessels</b>					
Gunboat No. 22, Tulsa (PG 22).....	Charleston Navy Yard.....	71.1	55.7	70.8	54.5
<b>Destroyers</b>					
338 Wasmuth.....	Mare Island Navy Yard.....	99.7	99.7	99.5	99.5
339 Trever.....	Mare Island Navy Yard.....	97.7	97.7	97.5	97.5
* 340 Perry.....	Mare Island Navy Yard.....	79.5	78.8	75.3	74.5
† 341 Decatur.....	Mare Island Navy Yard.....	73.7	63.0	70.2	60.4

\* Destroyer 340, Perry, launched 29, Oct. 1921.

† Destroyer 341, Decatur, launched 29, Oct. 1921.

In addition to the above there are under construction 4 fleet submarines and 37 submarines.

Authorized but not under construction or contract 6 fleet submarines and 1 submarine.

**PACIFIC FLEET BASES.**—The proposition, advanced in a recent book on the Pacific question, that modern fleets cannot undertake long-range operations with effect unless they possess properly-equipped bases at a reasonable distance from the scene of such operations, and that consequently the United States Navy will not be in a position to defend the Philippines until it has a near-by base where it can bunker and carry out urgent repairs, has been generally accepted in naval circles. That the overwhelming importance of base power in the Far Pacific is realized by American naval students is evident from the marked attention which this subject is now receiving. A contributor to one of the American service periodicals has dealt with the question in a very outspoken fashion. He lays emphasis on the mental strain to which a commander-in-chief would be subjected were he compelled to go into action knowing that injury to his ships could not be made good at a base near at hand, or that, if they were to be repaired, the work would deprive him of important units of the fleet for longer periods than he could spare them. The writer declares this question to be of supreme importance to the efficient conduct of the campaign and the victorious use of the fleet. "The necessity for dry docks, capable of taking our largest ships, in the distant bases is ever present, and so great is the need that war might find us totally unprepared in this vital respect unless we start at once to build such docks."

Where immense stretches of ocean separate a fleet from its home stations there must be repair shops, docks, and supplies of all kinds at other points than on the home coast if the fleet is to keep the seas. The United States, holding valuable naval bases in the Pacific, has not secured her hold on them to the extent that would make their use by her naval forces an assured fact in time of war. The result is that she might have to inaugurate a campaign by endeavoring to retake from the enemy what she had held for many years but had neglected to fortify and protect against capture. These arguments, cogent though they be, have apparently failed to convince American legislators, for it transpires that the Navy Department's plans for developing fleet facilities in the Western Pacific have been either rejected or so whittled down as to be hopelessly inadequate.—*Naval and Military Record*, 19 October, 1921.

**NEW SUBMARINE POWER DEVELOPED.**—A new type of submarine motive plant, comprising a combination of gas and electric propulsion, will be installed in three American submarines of the *V* type, two of which have just been laid down at the Portsmouth, N. H., navy yard. Naval engineers are said to be watching construction with great interest because of their expectation of improved operation of submersible warcraft to result from the new installation. A cruising radius of 10,000 miles is said to be one possibility.

The latest submarines are to be 2025-ton boats, measuring 300 feet in length and equipped with electric engines of 6500 horsepower. They are designed for a surface speed of twenty-one knots, and a submerged speed of from nine to ten knots an hour. The power plant will combine the latest engineering developments resulting from experiments conducted on the naval collier *Jupiter*, now the aircraft carrier *Langley*.

The two main engines, set well astern, of 2250-horsepower each, are of the six-cylinder type, and are connected with two motor generators which will drive two propellers. Two engines of the same type, of 1000-horsepower each, are located forward, and are connected directly with the generators, which, through two rear electric motors, will drive the submarine at an economical surface cruising speed of eleven knots. By combining the main and forward plants a maximum of 6500 horsepower will be obtained. When under water the submarines will be driven by the aft motors from batteries and no gas engines will be run.

Interesting features of the gas engines include the use of the aft motor generators somewhat as are electric self-starters in automobiles. The twelve engines for the three submarines are said to have cost \$3,000,000.

It is estimated by submarine experts that those vessels will be able to operate for a month away from their bases, or tenders, and that the maximum cruising radius at an average speed is approximately 10,000 miles. Those estimates indicate that the submarines will be able, as designed, to accompany naval fleets on long cruises.

The crews of those ships will include four officers and about fifty men, an increase of twenty men over those of the underwater craft now in the United States services.

When completed in 1923 the new submarines will be armed with one five-inch gun, set in a "wet" mount forward of the conning tower. The gun is designed to remain in the water when submerged, and can be trained almost in a complete circle or relayed as an anti-aircraft weapon. Machine guns will be mounted on the conning tower bridge. Forward will be four torpedo tubes and aft two others, all of the 21-inch size. Storage space is planned for sixteen torpedoes.—*Philadelphia Public Ledger*, 9 November, 1921.

**COMPARISON OF NAVAL STRENGTH.**—As a starting point for any limitation or reduction of naval armaments a clear idea of present relative strength is essential. This is not altogether subject to exact ascertainment. Naval strength, while based on known facts, is to some extent a matter of opinion. With warships of widely varying types and characteristics, various sizes and various ages, there is always room for argument when an attempt is made to compare the total fighting value of any two navies.

A comparison of guns alone can be made on the basis of caliber, of weight of projectiles, of range, of muzzle velocity, of flatness of trajectory, of rapidity of fire and of length of life. Guns are but one element of a battleship, however, which, in addition, should have defensive armor, under-water protection, speed, great radius of action, and a host of minor but desirable characteristics. All this, moreover, concerns only the individual ship. Every navy is composed of a multitude of ships, of every size, class, type, age and purpose. To be of any value in time of war, each of these ships must be manned by a thoroughly trained crew.

In this complexity it is no wonder that the average citizen seeks for some simple standard of comparison. Too often, however, this leads to undue emphasis upon some one particular feature. The two elements which seem to bulk largest in the popular mind are the caliber of the gun and the speed of the ship.

As to the first, there are those who would never spend money to put 16-inch guns on ships for fear some other nation will retort with 18-inch. No consideration is given to the fewer number which it would be possible to mount on a given size of hull or to the enormous increase in size and cost necessary to keep the same number of the heavier guns. The increase of two inches in the caliber of the 16-inch guns of the *South Dakota*, as compared with the *California*, meant an increase in displacement from 32,300 to 43,200 tons. The extra cost involved ran into the millions. Bigger guns may come with the progress of naval science, but the task of making your neighbor's ships "obsolete" by the simple process of mounting a larger gun is by no means as easy as it looks.

Speed is another spectacular feature of a ship, but in the case of heavy battleships its importance may easily be exaggerated. Wars are not won by running away from an enemy, and even the ability to catch an enemy who elects to run instead of fight is of secondary importance. Wars are won on sea as well as on land by the ability to seize positions of strategic importance, and to hold them against any force that may be brought to bear. "War," says Mahan, quoting Napoleon, "is a business of positions." Every one recognizes that on land the slow-moving infantry is the dominant factor, however necessary may be its more mobile auxiliaries. The same characteristics should not be sacrificed in ships meant to perform the same function, and extreme speed can be purchased only at the cost of other fighting qualities.

Every battleship is a compromise. Upon a given displacement, or total weight, the more guns you have, the less you have left for armor; the bigger the guns the fewer they must be. Speed is a direct function of the proportion of the total weight and space you are willing to allot to boilers and machinery; the radius of action is likewise dependent on the number of tons of fuel allowed. No one of these can be over-emphasized except at the expense of all the rest.

Herein lies the hint of the first and most important standard of comparison. The total displacement or weight of a battleship is the sum of all its desirable qualities. Displacement costs money, the more displacement you put at the service of the naval designer the better ship you will get.

It is not that size is a virtue in itself. The increased size and weight of the hull, together with the additional target it offers, are the disadvantages of bigness. The increased weight of the hull alone, however, is not in proportion to the increase in total displacement, and the increase in size puts so much more weight at the disposal of the designer to be used in the four fighting qualities, guns, armor, speed and endurance, that it is an axiom that the bigger the ship the better fighter it will be.

Twenty years ago there were many advocates of moderate displacement of individual ships on the theory that if a nation has so much money to put into battle-ships it were better distributed in more units of small size than concentrated in larger units. It is doubtful if the fundamental postulate is sound—that is, that a nation has a fixed sum to put into naval construction. Apart from this, not much is now heard in favor of small units. On the contrary, naval experts are convinced that the fighting value of a ship increases very nearly as the square of the displacement. The bigger hull not only permits the mounting of more heavy caliber guns, but the carrying of heavier armor, additional stiffening for underwater protection against torpedoes and more boilers for speed. It is the general acceptance of this principle that accounts for the abrupt increase in size, and incidentally in cost, from the British *Renown* of 26,500 tons to the *Hood* of 41,200 tons, promptly followed by our increase from the *Maryland* class of 32,600 tons to the *South Dakota* class of 43,200 tons and by Japan from the *Nagato* class of 33,800 tons to the *Kii* class of 43,500 tons. If this tendency is not checked by agreement at the conference we may soon look for monsters whose only limit is the 1000-foot length of the locks of the Panama Canal. It may be remarked, parenthetically, however, that as long as naval building is allowed to remain a competitive race, high cost is no disadvantage, since one main object of such a race is to make it too expensive for other nations to compete. Potential enemies who could seriously contest the supremacy of the sea with the United States have greatly diminished since we had trouble with Chile over the *Baltimore* incident, or since we fought Spain on substantially equal terms so far as our navies looked on paper. We have at least got something for our money.

Taking total displacement as a rough approximation of the strength of a navy, we have the following table:

TABLE I.—FIGHTING SHIPS OF ALL KINDS

	Built No.	Building and	
		Tons	Authorized No. Tons
Great Britain .....	533	1,860,480	17 215,380
United States .....	404	1,280,463	60 734,928
Japan .....	99	528,698	85 805,188
France .....	138	462,356	34 91,230
Italy .....	86	275,622	21 19,928

This is a rough yardstick indeed. The unreliability of counting units, by which a destroyer equals a dreadnought, is manifest. Even a comparison of total displacement gives no hint as to what proportion is given up

to light cruisers, submarines and destroyers and what proportion is in capital ships. A nation not intending seriously to contest the supremacy of the sea, will naturally put a greater proportion into defensive types.

Another factor that greatly modifies a comparison of displacements is the factor of age. The table above is compiled by drawing a dead line at 20 years from the launching of large vessels and 15 years for torpedo craft. Within these limits, however, there must still be considerable allowance for obsolescence. It is not so much that the ship itself deteriorates with age as it is the relative deterioration from improvement in design and construction. In this sense, age, like displacement, covers a multitude of details. Naval construction is a progressive science. Improvement in guns, armor, machinery, and hull construction are made constantly, so the sum total of these is a factor of considerable importance.

This can perhaps be best illustrated to the average citizen by the analogy between the progress in designing and building battleships and the progress in designing and building automobiles. The multitude of improvements, large and small, which makes the motor of to-day a more efficient machine than the motor of fifteen or twenty years ago, finds a close parallel in the corresponding progress in a naval construction.

The notion that a battleship "is obsolete before it is launched," or in a short time thereafter, is, however, fallacious. Successive designs, plus the willingness of legislators to increase the cost of units, may show substantial progress from year to year but it is only once in a generation that there is a revolutionary advance such as the monitor or the dreadnought. Otherwise improvement is gradual. A battleship fifteen years old may show at a disadvantage compared with her sister of to-day, but the older ship is not expected to fight the new one individually. Battleships act in fleets, and our earliest dreadnoughts are still effective units against a fleet which likewise must contain ships of its own age and size.

Ships may be classified as dreadnoughts, pre-dreadnoughts, battle cruisers, armored cruisers, etc., with reasonable exactness, though the classes sometimes merge in a way to give the captious full opportunity to dissent from the individual classification of many border line ships. Recent classifications divide ships within the age limit into "first line" and "second line" accordingly as they are strictly modern or obsolescent. The Navy Department's standard for a first line battleship is that it shall carry at least ten guns of 12-inch caliber or larger and displace at least 20,000 tons. A first line battle cruiser must carry 13.5-inch guns or larger and have a speed of at least 27 knots. A table compiled on this basis would show the following number of vessels of the larger types.

TABLE 2

	Great Britain		United States		Japan	
	Built	Bldg.	Built	Bldg.	Built	Bldg.
Battleships, first line.....	26	0	18	6	6	7
Battle cruisers, first line..	6	4	0	6	4	8
Battleships, second line...	6	0	15	0	4	0
Battle cruisers, second line	4	0	0	0	0	0
Cruisers, first line.....	2	0	0	0	0	0
Cruisers, second line.....	4	0	10	0	5	0
Light cruisers, first line...	45	4	0	10	9	14
Light cruisers, second line.	14	0	3	0	1	0

It will be noted that the main table includes the factors of number of capital ships, relative age, strength of main batteries and displacement. While it thus gives a general idea of relative strength in visual form, it further illustrates the difficulty of exact comparison.

As between Great Britain and the United States, for example, it is hard to compare the older ships of the Mother Country with our modern ships still under construction. With both programs finished, and barring the further scrapping threatened by Great Britain, the tonnage in capital ships will be practically identical. Under these circumstances our larger proportion of "post-Jutland" ships should give us a margin of superiority, even with 33 vessels against 45. Great Britain's overwhelming superiority in cruisers and airplane carriers, not shown on the table of capital ships, is, however, an item not to be disregarded.

With Japan age conditions are reversed. We excel in older ships, but the margin rapidly decreases with more modern construction. The *Settsu* is the only vessel old enough to carry 12-inch guns as against six of our earlier dreadnoughts. Following this Japan built four battleships and four battle cruisers, giving her eight ships armed with 14-inch guns, as against eleven American battleships. The "post-Jutland" program of both countries call for sixteen vessels, each armed with 16-inch guns. Our "three-year program," adopted in 1916, will give us ten battleships and six armored cruisers. Japan's "eight-eight" program as the name implies, calls for an equal number of each type. Japan's last four battle cruisers are not yet laid down, but her budget calls for their completion before 1928. Twelve of our sixteen are proceeding under reduced appropriations, the battleship at about 25 per cent of capacity speed and the battle cruisers at about 50 per cent, and their date of completion is officially designated as "indefinite."

In grand total Japan will have 76 per cent of our number of capital ships in a fleet at least 2 knots faster and 83 per cent of our capital strength measured in tonnage. Her fleet is, of course, superior to either our Atlantic or Pacific fleet taken separately. If strategic conditions in the Pacific are to be taken into consideration, the heavy disadvantage of either fleet's being compelled to fight on the opposite side of the ocean without adequate bases must be given considerable weight in a comparison of material strength.

Not only does the greater proportion of battle cruisers in the Japanese Navy make for a swifter fleet, but the battleships themselves are 2 knots faster than ours. The standard speed of our dreadnoughts is 21 knots, with our first oil burners, the *Oklahoma* and *Nevada*, designed for half a knot less. Except for the *Settsu*, the Japanese battleships are designed for 23.5 knots. We have now laid down the *South Dakota* class of 23 knots, but Japan, with the *Kaga* and *Tosa*, has gone up to 25 knots. Tactically therefore the Japanese fleet is in position to fight or to refuse to fight, always remembering, however, that wars are not won by refusing to fight.

Great Britain's standard speed is the same as ours. The *Queen Elizabeth* class of five ships is a fast squadron of 25 knots, but following this the Royal Sovereigns went back to 21 knots. It must be remembered, however, that every ship Great Britain has laid down since the war, including two altered during construction, has been of the powerful intermediate type of the *Hood*. These ships have a speed in excess of 30 knots and are officially classed as battle cruisers.

After all, however, a navy is not merely a collection of machines. Ships must have men to man them, and modern fighting ships must have crews which are thoroughly trained. Once in our history we sent a frigate manned by a green crew to meet one manned by a seasoned crew, and the crowd which gathered on the headlands to witness the fight saw the *Shannon* tow away the defeated *Chesapeake*. We do not want to repeat this on a large scale, yet at present every new battleship put in commission means the laying up of an older one—not the predreadnought long since in reserve, but one of the dreadnoughts listed in the main table.

To get back to actual comparisons, Great Britain has 123,700 regularly enlisted men and 10,158 officers at present in her navy. Japan has 68,800

**CAPITAL SHIPS OF THREE LEADING POWERS**  
*(Dreadoughts in Capitals, Battle Cruisers (B. C.) in Small Letters)*

Laid down	Great Britain			United States			Japan		
	Name	Main battery	Displacement	Name	Main battery	Displacement	Name	Main battery	Displacement
1905-06	Indomitable (B. C.) Infexible (B. C.)	8 12-in. 8 12-in.	17,250 17,250						
1906-07	BELLEROPHON TEMPERAIRE SUPERB	10 12 in. 10 12 in. 10 12 in.	18,600 18,600 18,600						
1907-08	ST VINCENT COLLINGWOOD	10 12-in. 10 12 in.	19,250 19,250	DELAWARE NORTH DAKOTA	10 12-in. 10 12-in.	20,000 20,000			
1908-09	NEPTUNE	10 12 in.	19,900	UTAH FLORIDA	10 12-in. 10 12-in.	21,825 21,825	SETTSU	12 12-in.	20,800
1909-10	COLOSSUS HERCULES ORION CONQUEROR THUNDER MONARCH Lion (B. C.) Princess Royal (B. C.) New Zealand (B. C.) Australia (B. C.)	10 12-in. 10 12-in. 10 13.5 in. 10 13.5 in. 10 13.5 in. 10 13.5 in. 8 13.5 in. 8 13.5 in. 8 12 in. 8 12-in.	20,000 20,000 22,500 23,500 22,500 22,500 26,350 26,350 18,850 18,850	WYOMING ARKANSAS	12 12-in. 12 12-in.	26,000 26,000			
1910-11	KING GEORGE V CENTURION ALAX ERIN	10 13.5 in. 10 13.5 in. 10 13.5 in. 10 13.5 in.	23,000 23,000 23,000 23,000	TEXAS NEW YORK	10 14-in. 10 14-in.	27,000 27,000	Kongo (B. C.)	8 14-in.	27,500
1911-12	IRON DUKE MARLBOROUGH EMPEROR OF INDIA BENBOW AGINCOURT Tiger (B. C.)	10 13.5 in. 10 13.5 in. 10 13.5 in. 10 13.5 in. 14 12-in. 8 13.5 in.	25,000 26,000 25,000 26,000 27,500 26,500	OKLAHOMA NEVADA	10 14-in. 10 14-in.	27,500 27,500	Hivei (B. C.) Kirishima (B. C.) Haruma (B. C.) FUSO	8 14-in. 8 14-in. 3 14-in. 12 14 in.	27,500 27,500 27,500 30,600
1912-13	QUEEN ELIZABETH. WARSPITE VALIAN PANTAN MALAYA	8 15 in. 8 15 in. 8 15 in. 8 15 in. 8 15 in.	27,500 27,500 27,500 27,500 27,500	PENNSYLVANIA	12 14-in.	31,400			

1913-14	RAMILLES..... RESOLUTION..... REVENGE..... ROYAL SOVEREIGN..... ROYAL OAK.....	8 15-in. 8 15-in. 8 15-in. 8 15-in. 8 15-in.	25,750 25,750 25,750 25,750 25,750	ARIZONA.....	12 14-in.	31,400	YAMASHINO..... ISE..... HYUGA.....	12 14-in. 12 14-in. 12 14-in.	30,600 31,260 31,260
1915-16	Rcnwn (B. C.)..... Repulse (B. C.).....	6 15-in. 6 15-in.	26,500 26,500	NEW MEXICO..... IDAHO..... MISSISSIPPI.....	12 14-in. 12 14-in. 12 14-in.	32,000 32,000 32,000	NAGATO..... MUTSU.....	8 16-in. 8 16-in.	33,800 33,800
1916-17	Hood (B. C.).....	8 15-in.	41,200	CALIFORNIA..... TENNESSEE..... MARYLAND.....	12 14-in. 12 14-in. 8 16-in.	32,300 32,300 32,600	KAGA..... TOSA..... KIL..... OWARI..... No. 7..... No. 8..... Amagi (B. C.)..... Akagi (B. C.)..... Atago (B. C.)..... Taka (B. C.)..... No. 5 (B. C.)..... No. 6 (B. C.)..... No. 7 (B. C.)..... No. 8 (B. C.).....	8 16-in. 8 16-in. 12 16-in. 12 16-in. 12 16-in. 12 16-in. 8 16-in. 8 16-in. 8 16-in. 8 16-in. 8 16-in. 8 16-in. 8 16-in. 8 16-in.	40,600 40,600 43,500 43,500 43,500 43,500 44,000 44,000 44,000 44,000 44,000 44,000 44,000 44,000
Authorized and building	Anson (B. C.)..... Howe (B. C.)..... Rodney (B. C.)..... No. 4 (B. C.).....	? ? ? ?	44,000 44,000 44,000 44,000	COLORADO..... WEST VIRGINIA..... WASHINGTON..... Washington (B. C.)..... Constellation (B. C.)..... Saratoga (B. C.)..... Ranger (B. C.)..... Constitution (B. C.)..... United States (B. C.)..... SOUTH DAKOTA..... INDIANA..... MONTANA..... NORTH CAROLINA..... LOUISIANA..... MASSACHUSETTS.....	8 16-in. 8 16-in. 8 16-in. 8 16-in. 8 16-in. 8 16-in. 8 16-in. 8 16-in. 8 16-in. 12 16-in. 12 16-in. 12 16-in. 12 16-in. 12 16-in.	32,600 32,600 32,600 43,500 43,500 43,500 43,500 43,500 43,500 43,500 43,200 43,200 43,200 43,200			

SUMMARY THREE LEADING POWERS

	Great Britain		United States		Japan	
	Build	Building	Build	Building	Build	Building
Dreadnoughts.....	31	0	18	9	7	6
Battle cruisers.....	10	4	0	6	4	8
Total capital ships.....	45		33			
Total capital tonnage.....	1,143,450		1,118,650		929,520	
Capital ships.....	136%		100%		76%	
Capital tonnage.....	102%		100%		83%	

PERCENTAGE STRENGTH COMPARED WITH UNITED STATES



men and 7430 officers, with provision for increase with the commissioning of new ships up to a maximum of 140,000 men at the completion of her "eight-eight" program. The United States has at present 106,000 men and 8727 officers, with no provision for increase with the completion of our "three-year" program. France has 50,000 men and 3730 officers. Both Great Britain and Japan have a more numerous and better organized reserve than has the United States.

Taken as a whole, therefore, Great Britain is now well in the lead. Upon the completion of the programs now under way the United States, with substantially the same tonnage will have a slight superiority due to the larger number of modern vessels. Japan's navy will be about 80 per cent of the strength of either of the others. This disparity, however, is principally in older ships so that, for example, if vessels carrying 12-inch guns should be considered obsolescent by the time all ships now authorized were finished, and comparison of capital ships confined to 13.5-inch, 14-inch and 16-inch guns, Japan's relative strength would be substantially increased. Any closer comparison involves such a complexity of factors as to resolve itself merely into a matter of opinion. France and Italy are not in the race to maintain supremacy in sea power.

There will undoubtedly be many and diverse plans for the limitation of naval armaments offered at the conference. Nations with a present superiority will naturally seek to maintain their relative strength, which, as has been pointed out, is no easy matter to ascertain for the present or to determine for the future. We may expect nations at present inferior in strength to suggest equality of armament as the logical corollary of the equality of nations. The Japanese press has been very insistent on this point and echoes in the American press have not been lacking to the effect that the spirit of the conference would be violated by any attempt of the powers now in the lead to maintain the existing relationship. Another suggestion that has been made is to limit the size as well as the number, of ships. Those nations who can make their money go farther than others will wish to solve the problem in terms of comparative expenditures or annual budgets, that is by comparing money instead of material. To find a satisfactory solution is going to tax the statemanship of the world.—*Washington Post*, 16 October, 1921.

**FREE CANAL TOLLS VOTED.**—By a vote of 47 to 37, the Senate on Monday last passed the Borah bill exempting American ships in the coastwise trade from the payment of Panama Canal tolls. The measure now goes to the House where it will probably encounter long delay as President Harding desires to have action deferred on this controversial subject until the Conference on the Limitation of Armaments is ended.

During the debate on the measure Senator McCormick of Illinois said that free tolls would discriminate in favor of the agricultural and industrial interests of the Atlantic and Pacific coasts and against those of the Middle Western States and would mean higher freight rates for the Middle West. Senator Lodge contended that the matter should go to arbitration and that the United States was open to the implication of bad faith in making use of its legal right to pass its vessels through the Canal free of tolls.

In the fiscal year ended June 30, 1921, American coastwise vessels using the Canal paid tolls of \$1,451,477.—*The Nautical Gazette*, 22 October, 1921.

**FOREIGN SHIPS EXCLUDED FROM MEXICAN COASTWISE TRADE.**—American Vice-Consul Stephen E. Aguirre reports that a recent decree, effective August 1, 1921, provides that foreign ships other than those flying the Mexican flag will not be permitted to engage in coastwise trade between Mexican ports. The reason for such a decree is given as an attempt to stimulate Mexican shipping. The enforcement of the new decree will

undoubtedly affect small foreign shipping now making regular calls, particularly those vessels calling at points on the west coast.

It is generally believed that such ships will change their flag in order to engage in Mexican coastwise trade. Large American freight and passenger vessels will be little affected since their cargoes originate outside Mexican ports and the cargoes taken on are destined for ports in the United States.

The decree has been strictly enforced in western and lower California ports and has seriously affected trade on the Pacific coast. As there are but few roads in this part of Mexico, all freight is sea borne, and before August 1 these ports were served by small American vessels. These boats usually sailed from California ports and entered at Ensenada, La Paz, and other Lower California ports, then continued to the ports on the Mexican mainland, and again touched the ports of the peninsula on their return trip.—*The Nautical Gazette*, 22 October, 1921.

**VESSELS SOLD TO FOREIGNERS.**—With the consent of the Shipping Board 10 American vessels of 9416 gross tons were transferred to foreign flags during September. All but four of these craft passed into British ownership. The largest vessel sold was the motorship *Balcatta* of 3109 tons, which is now under the French flag.—*The Nautical Gazette*, 22 October, 1921.

**BOARD'S PHYSICAL ASSETS SHRINK IN VALUE.**—The commission appointed to make a complete survey of the Shipping Board's physical assets aside from its steel ships reports that this property cost \$389,700,000. The surplus supplies and materials on hand cost \$124,884,000, and are now appraised at \$35,400,000. Other items in which large decreases in value were shown are:

Shipyard equipment, land, buildings and drydocks—original cost \$117,000,000; present value \$22,437,000.

Uncompleted wooden hulls—cost \$58,475,000; present value \$199,000.

The Emergency Fleet Corporation has removed all restrictions and limitations on the sale of its surplus supplies. To facilitate such sales district headquarters have been established at South Norwalk, Conn., Hog Island, Pa., Chicago, Ill., New Orleans, La., Alameda, Cal., Portland, Ore., and Tacoma, Wash. Each of the district directors of sales will be authorized to make cash sales of property in amounts not exceeding \$5000.—*The Nautical Gazette*, 22 October, 1921.

**BOARD'S VESSELS TIED UP.**—Indicative of the acute depression in shipping, 1241 vessels, out of a total of 2079 belonging to the Shipping Board, are now tied up.—*The Nautical Gazette*, 22 October, 1921.

**AMERICAN SHIPS CARRYING LESS OF OUR FOREIGN TRADE.**—Foreign ships are rapidly regaining control of our import trade. In July, 1920, they carried only 36 per cent of the total, while in July, 1921, they carried 54 per cent, an increase of 18 per cent. During the same period American independent vessels increased their percentage from 32 to 36, while the Shipping Board lost 22 per cent. Shipping Board vessels handled only 86,788 tons of imports (10 per cent of the total) in July, 1921—a record low figure—and only one-sixth of the total carried in July, 1920.

On the other hand, foreign ships are not appreciably increasing their hold on our export trade. In July last they carried 60 per cent of the total outward cargo movement as compared with 58 per cent in the same month of 1920. American privately owned craft increased their proportion from 17 to 25 per cent while that of the Shipping Board fell from 25 to 15 per cent.—*The Nautical Gazette*, 22 October, 1921.

**NATIONALITY OF MERCHANT SHIPS PASSING THROUGH PANAMA CANAL.**—According to the "*Panama Canal Record*," the number and net tonnage

of the ships of the various maritime nations passing through the Panama Canal from the time of its opening to June 30, 1921, was as follows:

Nationality	Total
Argentinian .....	2,335
Belgian .....	8,623
Brazilian .....	23,730
British .....	16,638,644
Chilean .....	1,331,220
Chinese .....	42,900
Colombian .....	161
Costa Rican .....	7,290
Cuban .....	9,994
Danish .....	1,079,643
Dutch .....	1,008,479
Ecuadorian .....	66
Finnish .....	4,281
French .....	726,067
German .....	120,089
Greek .....	14,575
Honduran .....	606
Italian .....	233,142
Japanese .....	2,106,581
Jugo-Slovak .....	4,508
Mexican .....	29,820
Nicaraguan .....	1,644
Norwegian .....	3,113,207
Panaman .....	3,051
Peruvian .....	1,027,523
Portuguese .....	9,002
Russian .....	57,192
Spanish .....	308,710
Swedish .....	527,924
United States .....	16,206,857
Uruguayan .....	410
Totals .....	44,648,274

—*Nautical Gazette*, 22 October, 1921.

### AERONAUTICS

THE "JL-12" ATTACK PLANE.—The *JL-12* Attack Plane was designed and built by John M. Larsen, a well-known engineer and inventor, who in the course of his aerial touring has flown between 250,000 and 300,000 miles in this country and Europe. It is a type in advance of the latest foreign all-metal planes. The plane is 32 feet long with a wing spread of 49 feet and carries 130 gallons of gasoline. When manned by pilot and gunner and equipped with 3000 rounds of ammunition and fuel for 500 miles of flight, it weighs 5000 pounds. Its radius of action in battle is 400 miles from its supply base. The engine is a 400-horsepower Liberty motor.

The main battery of the plane consists of twenty-eight machine guns arranged in two sections. The first section is of twelve guns located directly behind the pilot's seat, and the second of sixteen guns, is mounted to the rear.

The firing is done by the manipulation of three levers, one firing half the battery, another the other half, the third being a master lever which puts all twenty-eight guns into action with a single motion. The two remaining guns of the thirty are fired at will by the pilot or gunner from the cockpit. The replacement of fresh magazines for all the guns requires only four minutes.

The plane itself is constructed of American-made duralumin. The metal sheets are 25-1000 of an inch thick, more than twice the thickness of that used in the latest foreign all-metal planes. It is braced throughout with steel, there being a powerful criss-crossing of rods in the wings, which are two feet thick at their greatest diameter.

In designing this plane, it was Mr. Larsen's idea to provide a flying machine which, through its high speed, its sensitiveness under control and its ability to climb rapidly, could be used successfully against infantry either on the field of battle or while "going up," or to the rear, or to attack a convoy on a roadway. The intent of the plane is to swoop down upon the enemy, fly low over him, perhaps at not more than 50 feet from the ground, and loose an annihilating fire from machine guns. After such a dash, the machine is to climb swiftly to give the gunner time to adjust new magazines to the guns and then to return to the attack.

By manipulation of the ailerons of the plane, the latter can be made to rock back and forth above the object attacked and thus spray the ground with bullets for a wide distance. The forward Thompson guns are set at a slight forward angle, six in the second battery point directly downward and the remainder are trained slightly aft, so that fire from the plane flies in three directions simultaneously.

The circular drums for the Thompson guns contain 100 cartridges and the ammunition equipment for the plane in battle trim consists of three drums for each of the thirty guns, a total of 9000 cartridges.

In discussing the machine Mr. Larsen stated: "It has been put through the most severe tests already and the flying and the battery performance have been perfect.

"One marked feature of the plane is its climbing ability. During a recent test it climbed the first 1000 feet in 45 seconds and rose to 10,000 feet in less than 12 minutes. It is as fast as a scout plane and has high qualities of maneuvering at speed.

"Nothing has been overlooked to make it an irresistible weapon of war. Infantry, either in the open or intrenched cannot possibly withstand its sheer velocity of flight and its appalling fire. It flies too fast to afford a target. It sets a pace which is strides ahead of anything like it in the world, and the best part of it all is that this plane is of American material and workmanship throughout."

*Specifications.*—Type—All-metal monoplane.

Span—49 feet.

Length Overall—32 feet.

Height to Top of Cabin—400 horsepower.

Motor—Liberty 12—400 horsepower.

Control—Dual dep.

Weight of Plane empty (including cooling water)—2900 lbs.—*Aerial Age Weekly*, 7 November, 1921.

**REDUCTION IN NAVAL AIR SERVICE.**—The curtailment of the activities of the Navy Air Service up to date has closed the stations at Cape May, N. J.; Yorktown, Va. (branch of the Hampton Roads Air Station), and Rockaway, N. Y. This leaves operating stations on the Atlantic Coast at Hampton Roads, Va., Lakehurst, N. J., Anacostia, D. C., and Pensacola, Fla., and on the Pacific coast at San Diego, California. Of these the Hampton Roads and the San Diego stations are the only sizeable ones now existing, as far as the navy is concerned.

Due to the crash in England of the *R-38* the airship station at Lakehurst is in a peculiar situation. What will be done with the station remains to be worked out following the financial settlement over the *R-38*, which will soon be taken up with the British government. If it is possible to obtain—as some of the high officers of the Bureau of Naval Aeronautics hope—one of the British dirigibles as part payment in the settlement, the activi-

ties at the Lakehurst station will be resumed. Otherwise they will cease for about a year, when it is expected that the airship ZR-1, now building at the station, will be completed.

The Anacostia station, just outside of Washington, is maintained largely for experimental purposes. It is not regarded as an ideal naval air station in the accepted sense.

The station at Pensacola serves for training purposes, to supply fliers for the Atlantic and Pacific fleets.—*Aviation*, 24 October, 1921.

**BRITISH PLANES WITH LITTLE PLANES UPON THEM.**—Experiments with a remarkable type of battleplane which carries its own scout machine poised at the tip of one of its wings have been carried out at Farnborough, England. Two big bombing planes have been flying over Aldershot with a diminutive airplane fixed to the upper wing. So far it is understood that the tests have been successful. The parent machines have traveled at their usual pace, although the engine of the scout machine was kept running so that it was ready to dive off at a minute's notice to protect the larger and heavier craft. The automatic releasing apparatus is constructed on ingenious lines, we learn from *Aerial Age Weekly*. An expert pilot is carried by the bombing plane and as soon as his services are required he climbs through the top wing and takes his seat in the scout plane. By pressing a trigger he frees the smaller machine which at once glides along the battleplane wing and dives off.—*Scientific American*, 15 October, 1921.

**NEW THEORY OF THE SLOTTED WING.**—In a paper recently read before the Society for Aeronautical Science at Munich, Dr. Betz dealt with a certain development in sustaining planes or aircraft wings due to Lachmann in Germany and Handley Page in England. The object is to increase the lift by providing slots in the wing parallel to the leading edge. If these are to be effective they must extend without interruption across the entire width of the wing. This arrangement may also be regarded as an extra plane of small depth placed in front of the main wing at its leading edge so that there is only a very small space left between the two. The maximum lift of the plane is thereby increased by 80 per cent or more. There are different explanations of this phenomenon. One is that the small plane located in front of the main plane is located in an air stream whose conditions of flow are determined by the main wing. It follows that at the leading edge of the main wing the air speed materially exceeds the speed of flying. The reactions of the air on the small wing in front therefore are considerably greater than if it passed through space at the flying speed.

The new explanation of Dr. Betz is based on the fact that for a given speed the lift of a plane increases with the angle of incidence until the air stream on the upper surface can no longer follow that surface. If the angle of incidence becomes too big, a new condition of flow develops, the air stream separating from the plane, creating a field of eddies which grows with the angle of incidence. Such eddies have a tendency to form even in the case of small angles of incidence, but the air, passing over the plane, immediately washes them away, and thus maintains a smooth, lift-creating stream. In the case of large angles of incidence this becomes impossible. But if the air stream on top of the plane is reinforced by air passing through the slot in the wing from the under to the upper side, the lift-creating flow conditions can be maintained even with larger angles of incidence. New energy is being supplied to the air stream on top of the plane by the air flowing through the slot, which enables it to continue to wash away the eddies. This energy has to be paid for, however, the phenomenon being accompanied by increased drift of the slotted plane as compared with a plane without slot.

This new explanation is valuable for the reason that it furnishes a basis for judging the value of new plane combinations of the kind referred to,

and facilitates the arrangement of systematic test series in a field where the number of possible combinations is almost without limit.—*Automotive Industries*.

**FLEET WILL TEST ANTI-AIRCRAFT GUNS ON RAG MEN IN GLIDERS.**—Rag men will be used to "man" a fleet of gliders that will be under fire of anti-aircraft guns on ships of the Atlantic fleet in forthcoming maneuvers off the Virginia Capes and Cuba the latter part of the winter. It is planned to launch the gliders from navy dirigibles at a height of from 3000 to 5000 feet. The rag men will be fastened in the gliders to prevent the machines from turning over in the downward flight they will take after they are released. The presence of the rag men in the gliders will also given American gunners using small arms a charge to prove their marksmanship in picking off crews of an aerial enemy craft.

It is proposed to release the gliders in groups of five. Naval experts say the gliders, in their flight downward, will maintain an average speed of about 45 miles an hour, about half the speed an aviator in full flight would average in an attempt to escape guns on warship after delivering an attack.

Practically every ship in the Atlantic fleet will take part in the attack of the gliders.

An elaborate program of aerial target shooting and maneuvers is being prepared for use when the Atlantic fleet goes to Guantanamo the coming winter. Most of the fleet will assemble off the Virginia Capes within the next few weeks for preliminary target practice, which will include experiments with gliders and box kites. The latter style of target has been used in previous aerial target shooting and resulted in excellent records for navy gunners using small arms. Box kites are made fast to ships with ropes and permitted to soar at heights varying from 500 to 1200 feet.

The gliders will be larger than those used in land maneuvers by the army and navy. Each glider, it is said, could easily carry two live men with utmost safety.—*Aerial Age Weekly*, 24 October, 1921.

**NAVY HAS CATAPULT TO LAUNCH PLANES.**—Secretary Denby announced October 16 that, after much experimentation, the navy has developed a catapult for launching aeroplanes from battleships which will soon be tested. A complete catapult unit is now ready for installation on a battleship, and if the invention meets expectations in tests in service, the machine can be produced in quantity and all battleships of the fleet can be rapidly supplied with this new form of aviation equipment.

The catapult consists of a carriage moving on tracks. On this carriage is mounted the aeroplane. The carriage is caused to move on the tracks at an increasing speed until, near the end of the tracks, its speed is sufficient to permit the aeroplane to take the air. Then the carriage is brought to rest by means of suitable brakes and shock absorbers. The apparatus can be made in varying sizes so as to be adapted to the launching of any aircraft likely to be used from surface ships.

Normally, when an aeroplane takes off from the flying field, it runs along until it has attained a speed through the air sufficient to sustain it aloft. This is known as its minimum flying speed. After attaining such a speed on the ground, it can be so controlled as to take the air and to remain up so long as this minimum flying speed is maintained. The length of run necessary is dependent upon the type of plane concerned and its loading, the wind, and the nature of the terrain.

In case of a very lightly loaded plane, such as a single-seat plane, with a strong wind against the direction run, the length of run required before leaving the ground would be very short. However, as a rule, the length of run required is considerable, and under unfavorable conditions it may be several hundred feet. To supply this starting speed from the ships the catapult has been developed.

When a plane is launched from the deck of a battleship by means of a catapult it cannot land on the deck of the vessel at the end of the flight. Thus planes which will be used from battleships must possess some means of flotation. At the end of a successful flight they will alight on the water in the lee of the ship and be hoisted on board by cranes.

In the case of planes operated from proper aeroplane carriers, they may be launched by means of catapults from the carriers, or, under favorable circumstances, may take off directly from the flying deck of the carriers, as from a field. Also, at the end of their flight they may alight on the landing decks of the carriers, where they will be brought to rest gradually by the arresting devices now being developed.

In the absence of the catapult in recent efforts to launch aeroplanes from battleships platforms were built on the top of turrets and supported by the muzzles of the guns. The turret was so trained as to point the plane directly into the wind.

Under favorable conditions it was found possible to launch small light-loaded aircraft. The apparatus was heavy and cumbersome and interfered with the turret on which it was used. The plane was not locked to the platform while it was attaining flying speed, and a side gust was liable at any time to cause a serious accident.

The catapult will be built into the ship which is to use it and will be so installed as not to interfere with any other part of the vessel. It is believed in navy circles that in the near future all surface ships will be equipped with catapults and aircraft as they are now equipped with small boats. By a system of tracks the aeroplanes will be run from their hangars onto the upper decks of the surface ships and the carriages of the catapults.

Normally, while the ships are cruising or in bad weather, the planes will be kept under cover in the upper decks, some disassembled and some partially assembled. Up to the present, due to the fact that aircraft are of such recent development in use on ships, the apparatus necessary for them has not been "built in." Naval officers say the battleships of the future will be designed undoubtedly to take their catapults, necessary hangar space, machine shops, the tracks and their aircraft, just as they are now designed to take their turrets and guns.—*Aerial Age Weekly*, 24 October, 1921.

REPORT ON THE "R-38" INQUIRY.—The report of the court of inquiry appointed to investigate the causes of the accidental destruction of the rigid airship *R-38*, which has just been issued, confirms the opinion, privately expressed after the disaster, that it was due to structural weakness.

The report, which is noteworthy for its frankness, states that the airship while flying at approximately 1200 ft. over the Humber, broke in two, due to the failure of the structure to the rear of the after engine cars while being subjected to control tests.

The findings of the court of inquiry confirm evidence introduced at the inquest into the disaster. They say that fire, probably originating from a spark from electric wires, was mainly responsible for the large loss of life. They note that a quick reversal was being made at the time of the accident, bringing a heavy strain on the after-portion of the hull of the craft, due to the swing of the stern.

Then the court found, among other things, that "the requirements as to maximum height and speed, together with limit in length imposed by the only available construction sheds, necessitated the utmost economy in design, and it appears evident that in some cases there was lack of vital aero-dynamical information as to the effect of these modifications on the strength of the structure."

The latter paragraph should be of particular interest to all those concerned with development of American rigids. It is quite natural that the *ZR-2* disaster should have provoked considerable discussion as to the wisdom of having experimental ships for our government built abroad. It

is equally natural for the incidental question to come up as to why such an important matter of policy was not thoroughly discussed before the disaster instead of afterward.

The answer to this latter question can and should be made perfectly clear to our minds. The main issue evolved is simply this, whether it is better to accept as fundamental the foreign designs and constructions, subsequently improving them where possible; or if it is better to base the principal reliance on our own designs and constructions with the incidental object of using foreign experience to the best possible advantage.

There are no *a priori* grounds on which such an argument could be based. It is simply a matter of ascertaining which system will produce the best results.—*Aviation*, 17 October, 1921.

**ERECTION OF THE "ROMA" UNDER WAY.**—The airship *Roma*, recently purchased from Italy, and delivered to Langley Field, is being erected in the huge hangar at that field. Inflation of the envelope started September 21, and by Friday, the 23d, over 1,000,000 cu. ft. of hydrogen had been fed through two 6-inch gas lines.

The *Roma* entirely fills the 410 ft. hangar, necessitating mooring the *D-3* to the Vickers mast in the open.

Due to the great amount of rigging yet to be attached, and the fineness of adjustment for this rigging, it is estimated that the *Roma* will not be ready to fly before January 1, 1922.—*Aviation*, 27 October, 1921.

**ITALIAN AIR APPROPRIATION.**—For the fiscal year ending June 30, 1922, the Italian Government has appropriated 42,700,000 lire for the Army Air Service and 22,060,000 lire for Civil Air Service, both services being under the jurisdiction of the War Department.

With regard to the appropriation for military aviation, the largest sum is allotted for the renewal of aviation material (16,500,000 lire). Next in order is 13,000,000 lire for gasoline, oils, etc. For expenses incidental to the preparation of flying personnel 4,800,000 lire is allotted; maintenance of buildings, and airdromes 2,200,000 lire; special compensation to flying personnel, 2,400,000 lire; conducting experiments of aircraft and aircraft armament, 2,050,000 lire; repair and maintenance of planes, motors, and other material, 1,300,000 lire; aerial photography, 150,000 lire; and miscellaneous expenditures, 300,000 lire.

Of the appropriation for civil aviation, 4,500,000 lire is allotted as subsidies to private aeronautical concerns for the operation of airdromes and aerial routes by heavier-than-air and lighter-than-air craft; 2,300,000 for carrying out studies and experiments; 3,000,000 lire for construction purposes; 2,460,000 lire for the operation of a preliminary flying school; and the remaining 7,200,000 for miscellaneous purposes. An additional appropriation, not yet determined, is to be allowed the Civil Air Service for the construction of commercial airplanes.

The salaries of army personnel are paid out of other appropriations for the support of the army. Many of the airdromes are also supported from funds appropriated for the maintenance of army posts. It is estimated that the army and civil air services receive from other appropriations to cover various services such as maintenance of posts, pay of the army, etc., 50,000,000 lire, making a total sum to be expended for military and commercial aviation in Italy during this fiscal year of approximately 112,760,000 lire, or slightly over \$28,000,000.—*Aviation*, 31 October 1921.

## ENGINEERING

**THRUST METERS IN MARINE WORK.**—On account of the practical difficulties involved, actual measurements of thrust in a ship's shafting were confined to attempts on a very small scale until quite recently, and the later



successful instances do not seem to have received the attention which they merit. Both Messrs. Cammell Laird and Co. and Messrs. Denny had conducted a few trials of this nature, and in 1908 the Vulcan Company, of Stettin, had succeeded in measuring the thrusts of the turbine-driven light cruiser *Stettin*, of 22,000 shaft horsepower, but nothing of a really satisfactory nature had been accomplished prior to the trials of H. M. S. *Mackay*, a large destroyer flotilla leader of 1800 tons and 44,000 shaft horsepower, which was completed at Birkenhead in 1919. Full details of the thrust meter employed and of the trials were published in *The Engineer* of August 29, 1919, and an analysis of the latter was given in a paper by Mr. Holt to the Institution of Naval Architects in 1920. The extremely interesting results obtained merit careful attention on account of their unique nature and the valuable deductions which can be drawn from them. The thrust meter used was of a type evolved by Messrs. Cammell Laird and Co. after many experiments with other designs, and consisted essentially of a series of 3½-inch oil cylinders incorporated in the casing of the *Michell* thrust block, arranged with their axes concentric with the shaft, and with their pistons in contact with the abutment ring carrying the bearing pads. The product of the oil pressure and the areas of the cylinders sufficed to measure the thrust, which on many occasions ran up to a figure of about 60 tons on each shaft.

The results obtained in H. M. S. *Mackay* might reasonably be regarded, not with suspicion—though as being at least unconfirmed were it not for them we should like corroboration of certain points—but for the fact that shortly afterwards the Bath Iron Works, Maine, U. S. A., used a thrust meter of different design in the United States destroyer *Pruitt*, which they had constructed, and whose trials took place in September, 1920. A very full description of both vessel and trials appeared in the *Journal of the American Society of Naval Engineers* in February last. The thrust meter used in the *Pruitt* consisted of an attachment to the *Kingsbury*—which is the American form of the *Michell*—thrust block, which was fitted to the forward end of the gear wheel shaft. In principle, it consisted of a thin flexible copper disc, about 22-inch in diameter, placed in a closed chamber at the end of the shaft, from which it was separated by a film of oil, and operated by oil pressure on the face of the disc remote from the shaft. This thrust meter arrangement is not unlike the footstep bearing used in vertical turbines, whether steam or water-driven, where the weight of turbine, shaft and generator, often running into large figures, is supported on a film of oil. The U. S. S. *Pruitt* is a vessel of about the same speed as the *Mackay*—35 knots—but slightly smaller, being 1200 tons displacement, and having about 27,000 shaft horsepower. A very full analysis of the trials was made by Mr. J. Burkhardt, of the Bath Iron Works, which enabled an interesting comparison to be made with those of the *Mackay*. It is not our intention to elaborate the individual performances, but to call attention to the fact that in both cases the operation of these meters enabled a measurement of thrust over a range of speed to be obtained, which, by its ease of application and reliability of measurement, offers a method of solution of many problems connected with both resistance and propulsion which for lack of such apparatus have hitherto defied precise analysis. Even in their apparently considerable divergence of results—for the individual analyses of Messrs. Holt and Burkhardt are susceptible of considerable expansion and detailed comparison—the two performances corroborate one another to a very marked extent, and the broad facts which ensue from their evaluation undoubtedly contribute no small measure of mutual support to a comparison from which much is to be learnt. Without entering into details, we may note that the measurement of thrust in these cases, as in that of the *Stettin*, cast considerable light on questions of actual wake and hull efficiency values, on propeller performance, and on the differences between the estimated resistance of the ship from tank experiments and that actually measured. Reliable thrust meter readings put an

entirely different complexion on the value of experimental data, confirming it or modifying it, as the case may be. Whether cavitation is present or not, thrust meters show precisely what the propeller is doing, and by deduction from the effective horsepower of the model enable the uncertain influences of air or appendage resistance to be assessed. When cavitation is present—and it is probably far more prevalent than is generally imagined—it is very difficult, if not impossible, to make any accurate calculations of the thrust horsepower delivered by the screws, and even when it is not regarded as affecting results there are frequently discrepancies in propeller performance, calculated from the results of trials of models, which the use of a thrust meter largely discounts. The measured thrust per square inch of projected area of screws ran up to 15.7 lb. per square inch in the *Pruitt* and to just 15.0 lb. in the case of the *Mackay*, figures which are considerably on the high side, according to some authorities. But though the *Mackay's* propellers (on the deep load trial) were obviously breaking down, the *Pruitt's* were still continuing to work with high efficiency. Calculated from the effective horsepower of the model with appendages, the respective pressures were 14.8 lb. and 12.5 lb. This is but a small instance of the light shed on some unsolved propeller problems by this measurement; the values of hull efficiency and wake factor obtained by these measurements were distinctly different from those which might have been (and without adequate basis) anticipated from other trials. Thrust measurements will not solve the problem of the propeller efficiency of the ship, but they remove a most important element of doubt regarding its performance; the determination of the wake factor in the ship, as distinct from the amount found by experiment in the tank, is still essential before the real slip, and hence the efficiency, can be accurately estimated. But the evaluation of this, as shown by Mr. Holt, can more readily approximated when the true thrust is known. For the determination of the effect of various conditions of bottom, which is so necessary before full-scale proof of the laws of surface friction can be obtained, thrust meter trials offer a prompt and reliable solution. It would not be surprising to learn that experiments of this nature have already been conducted, and whether the advantage to the profession as a whole or the commercial value of the knowledge thus acquired will affect their publication remains to be seen. It would seem that this is information which might properly be obtained by experiments in naval ships. It is, however, a subject which is really of greater importance to the mercantile marine, where the fact is gradually being appreciated that the saving of one effective horsepower means, roughly, two of shaft horsepower.

But it is mainly in the facilities which it affords for the comparison of experimental data with observations in practice that the value of the thrust meter will be found. It possesses the paramount advantage of giving the actual resistance of the whole ship under any condition or combination of conditions of loading, trim, weather, state of sea, depth of water, or condition of bottom; quite apart from the comparative data to be gained regarding the differences between trial and service performance, such matters as astern performance and maneuvering data can be elucidated, while the use of actual screws to corroborate model results for purposes of design can now be placed on a very definite footing.—*The Engineer*, 7 October, 1921.

**FEATS OF KITCHEN RUDDER.**—One of the interesting exhibits at the Shipping, Engineering and Machinery Exhibition held recently at the Olympia in London was the Kitchen rudder, a photograph of which is reproduced. It consists of two curved deflectors formed of parts of a cylinder enclosing the propeller. Both deflectors are pivoted at the top and bottom on common centers, and are operated by two shafts, one of which is solid and the other hollow, the latter being concentric with the former. By suitable mechanism the deflectors are made to turn together in the same direction or equally in opposite directions.

When the deflectors are opened out they permit the boat to travel at full speed. When these are partially closed, with the engines still running, the boat can only proceed at half speed. When the rudder is closed still further, the boat will remain stationary, as the water churned by the propeller cannot pass behind the rudder in sufficient volume to send the ship forward. When the deflectors are closed altogether, the water reacting on the rudder causes the vessel to go astern. From full speed ahead to a standstill can be accomplished in less than a boat's length. In swinging astern with the rudder hard over, half a circle can be made easily within a radius equal to half the length of the boat.

One of the remarkable features of this type of rudder is the control secured of a vessel when backing and this without changing the direction

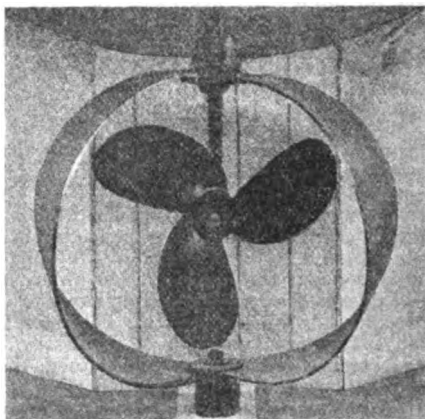

Photo by Wide World

#### THE KITCHEN REVERSING RUDDER.

or speed of the engine. Moreover, in the case of a high speed engine requiring a propeller with a low pitch, efficiency is not lost in backing as the engine always runs in one direction, while with an ordinary reverse gear the low pitched propeller would be very inefficient for backing if properly designed for going ahead.—*The Nautical Gazette*, 22 October 1921.

**CHANGE URGED IN METHOD OF PRODUCING POWER FROM OIL.**—Discussing the application of oil to power purposes before the Oil Conference at the Shipping Exhibition at Olympia, London, Mr. Sydney North said that the progress of the use of oil for power production is entirely dependent on our engineers and chemists, the former for introducing a system which will attain the greatest evaporative power on a minimum consumption, the latter for adapting the large variety of oils available to the purposes for which they are required.

Up to the present time, the former have restricted their efforts to the identical lines laid down as far back as the 'sixties, which involved the forcing of oil in its natural state through a small orifice, thus splitting up the oil into a fine spray enabling combustion to be obtained more readily. It is true that improvements have been made in the burner itself, and the arrangements in the interior of the furnace have been carefully studied, but the main principle remains the same.

It is always difficult to deviate from a fundamental idea once it has been adopted and worked on for many years, but if our oil fuel engineers would

think outside the one dominating the burning of oil under boilers they might arrive at a system of producing power from oil which would effect a very great reduction in the consumption of the fuel and attain greater efficiency. It might be worth while bringing the oil fuel system into juxtaposition with the principle of obtaining power in the Diesel engine and the hot-bulb engine and ascertaining whether any part of the method employed in the latter could be adapted or modified in such a manner as would give the desired improvements in direct oil firing.—*The Nautical Gazette*, 22 October, 1921.

**MOTORSHIPS AS EXPRESS CARGO CARRIERS.**—Commenting on the report that the North Star Company (Johnson Line) of Stockholm, which possesses a fleet of about 130,000 tons, one half of which is motor driven and the remainder steam driven, have decided to sell their steamers and purchase motor boats, our Liverpool correspondent writes that there is undoubtedly a great future for the motor-driven express cargo boat and for motor-driven combination passenger and cargo vessels. When equipped with internal combustion engine power, such vessels can attain a speed of sixteen knots without their fuel consumption exceeding that of an eleven to twelve knots geared turbine steamer of similar dimensions, whilst the absence of boiler water and the great reduction in the quantity of fuel required enables about 15 per cent more cargo to be carried.

Proof of the reliability of motor ships is furnished by the *Selandia*, built by Burmeister and Wain, and put in service in February, 1912. She is a twin-screw vessel of 7400 tons deadweight and has a speed of 10½ knots. Each engine of eight cylinders develops 2500 i.h.p. of 140 r.p.m. She has covered nearly 500,000 miles and is still in steady service, whilst large numbers of steamships built since the Armistice are laid up due to their inferior operating economy.—*The Nautical Gazette*, 29 October, 1921.

### NAVIGATION AND RADIO

**NEW LIGHTHOUSES ON SOUTH AMERICAN COAST.**—Sixteen automatic lighthouses furnished by a Swedish company have been installed at various points on the coast of Ecuador. Those at Santa Clara and Santa Elena have a visibility of sixteen and a half miles; others at Punta Española, Punta Arenas, and Jambeli have a radius of fourteen and a half miles, while the rest are visible eight and a half miles. The iron tower of the lighthouse is fifteen meters high. The automatic lanterns flash a spark every three seconds.

Details of the contract to be granted by the Venezuelan Government for the installation of seven lighthouses along the coast have been made public. There is to be a twenty-mile light for the northernmost extremity of the peninsula of Paraguana, a fifteen-mile light at the entrance to the port of Maracaibo, two twelve-mile lights at Punta Juanes and Punta Mangle respectively, and three six-mile buoys at the western end of the peninsula of Araya, in front of the port of Pedernales, and at the entrance to the Cano Macarreo, which is the principal mouth of the Orinoco River.—*The Nautical Gazette*, 12 October, 1921.

**PETROGRAD'S PORT APPROACHES.**—The British Russian Trade Delegation states that ships bound for Petrograd will find stationed off Narva Bay a large lightship marked *Priemny* with wireless telegraphy and pilots aboard. The latter will take ships to Cronstadt free of charge. The course from this pilot station to Cronstadt is clearly marked by buoys and has been swept clear of mines. At Cronstadt another pilot takes the ship to Petrograd docks free of charge. This last stretch of channel has a navigable depth of 28 feet.

There are no consuls, shipping agents, stevedores or private agents at Petrograd. The government reserves the right to carry on all business.

pertaining to shipping through its own officials. No charges are being made as yet for pilotage, dock or light dues. The necessary labor and appliances for the handling of cargoes are being supplied free of charge for the present.—*The Nautical Gazette*, 29 October, 1921.

#### ORDNANCE

**AIR TORPEDO TESTED.**—A successful mechanically controlled flying torpedo, destined to revolutionize land and sea warfare, has been developed for the United States Army and Navy air services. In a secret test, made two weeks ago, this remarkable aircraft, said to be the most important aerial weapon ever constructed, flew over New York City and two Eastern states. According to aerial experts here, the flying torpedo, had it been loaded, could easily have wrought great destruction to lower Manhattan.

The experiments have been carried on for several months on Chesapeake Bay, in New Jersey and Ohio in strictest secrecy, not more than 100 persons in the entire country having any knowledge of it. The machine already has made upward of a hundred flights, approximating 5000 miles.

Its existence undoubtedly will exert a profound influence upon the Conference on the Limitation of Armament, which opens here this week, because development of the craft, according to the experts, means that coastal fortifications are rendered obsolete.

Attacking in large numbers, machines of this type would be able to annihilate cities with incendiary explosives and poison gases without the loss of one life to the attacking forces, the experts declare. In actual warfare the flying torpedoes will be guided through the air to their targets without a person on board.

During the flight over New York City the experimental flying torpedo made an unexpected landing near a small town in eastern Pennsylvania. This incident attracted little attention at the time.

Upon receiving a report of the landing of the mysterious aircraft, however, the New York *Tribune* began an investigation, and now is in a position to outline the characteristics of this remarkable machine and its possibilities. The details of construction and control are still shrouded in mystery.

The test flight on that occasion commenced from a landing ground near New York. After the engine was started the machine ran a short distance across the field, and then took the air successfully and climbed to the predetermined altitude. It then set a course due west, straight into a stiff head wind.

The most remarkable feature of the new craft is the development which causes it to take off from the starting field. The secret apparatus controlling the elevators, which govern the ascent and descent of an aeroplane, is absolutely successful, according to the experts who have watched the experiments. For straight flying across country the machine is equipped with apparatus which gives it inherent stability, causing it to right itself under all conditions.

From official sources it is learned that the flying torpedo is designed for offensive action against enemy coasts, cities or fleets. In naval warfare it will be further controlled by radio, and at no time will machines of this type fly more than twenty feet above the surface of the sea during naval engagements. It can be flown at any altitude while being used in attack against cities or coast defenses. The flying torpedoes will be filled with incendiary explosives and poison gases.

The object of flying low in naval battles is based on two important factors. First, the present indicated defense against attacking aeroplanes—besides other aircraft—is detonation set up by a barrage of anti-aircraft guns. The theory of this defense is that, while no attempt is made to obtain a direct hit, a terrific air disturbance will be set up by the exploding shells, making it practically impossible for the attacking machines to approach their objectives. This, of course, will be obviated by low flying.

The other factor is based upon the fact that when a machine is flying very low there is a back pressure of air from the ground—or sea—which tends to keep the machine in the position in which it is flying. This, with the radio control, will make the flying torpedoes almost invincible, as only a direct hit will put them out of action.

In this manner hundreds of the machines can be set to fly straight toward a fleet, and then circle around until they strike one of the battleships. Or they may be directed by an attacking fleet against enemy cities from a distance of 200 miles or more.—*Aerial Age Weekly*, 14 November, 1921.

#### MISCELLANEOUS

**THE POLISH NAVY.**—Some of the references to the transfer of three of the ex-German torpedo boats to Poland are calculated to mislead those who do not follow such matters very closely. In the accounts in several papers of the picturesque and impressive ceremony which took place recently in Leith Roads, when the Polish flag was solemnly blessed on board, and holy water was sprinkled over the vessels by a Catholic priest, it appeared to be thought by the writers that the vessels were fighting craft, many references being made to Poland as a sea power, and to Poland's embryo navy. Actually the ships are unarmed. The Supreme Council, when allocating the ex-German and ex-Austrian men-of-war to the various Allied and Associated Powers last year, decided to entrust all 50 of the surrendered German torpedo boats to Great Britain. All but 12 were to be broken up, and of those spared, six were to be selected by Poland and six by Brazil, after being disarmed, to be used for police duties only. At the Supreme Council meeting at which this arrangement was made, the Poles expressed a preference for the style of certain ex-Austrian vessels, and asked whether Austrian destroyers could not be sent to Danzig, but for technical reasons it was decided that it would be impossible to accede to the suggestion. It seems advisable to point out the real facts at this juncture, if only because they may remove false impressions which might otherwise be created on the continent, and particularly in Russia.—*Army and Navy Gazette*, 1 October, 1921.

**THE RUSSIAN NAVY.**—In returning to the Soviet Government the ice-breaker *Alexander*, which was among the ships taken over at Archangel late in the war, the Admiralty has done a good turn which ought to be rightly appreciated, for the *Alexander* is a most useful vessel, and one which the Russians need very much. It is also understood that negotiations are proceeding for the return of the ice-breaker *Sviatogor* if a certain sum is paid for her. Both the *Alexander* and *Sviatogor* are fairly new vessels and British-built. They were constructed by Messrs. Armstrong on the Tyne in 1915-17. It will be remembered that when a Russian steamer was ice-bound in the Kara Sea in the spring of 1920, the Soviet Government had to admit that it was without the necessary resources for a relief expedition, and the British Government accordingly lent the *Sviatogor* for the undertaking, which was successfully carried out under the leadership of M. Sverdrup, the Norwegian explorer. Since the two ice-breakers mentioned are unarmed, there should be no objection raised to their being handed over to the Russians, but the cruiser *Askold* and two destroyers, which have been under British protection since 1918, are in a different category, and we hope that due and proper safeguards will be asked for and received before they are returned. We cannot forget that not many months ago a Soviet Minister, when launching a submarine in the Black Sea, said that he hoped it would sink an Entente vessel.—*Army and Navy Gazette*, 8 October 1921.

**THE DUTCH EAST INDIES.**—More than casual interest attaches to the recent Admiralty order touching the voyage to the Dutch East Indies of

the Netherlands submarine *K-6*. This little vessel, which may call at Falmouth early in the present month, is on her way to join the naval forces entrusted with the defense of Holland's most valuable over sea possessions. According to the text books she is quite a new boat, displacing 800 tons when submerged, with a surface speed of 16 knots and a cruising range of 5500 miles. Eight other boats of the *K* class are built and building. The Dutch Navy is understood now to include about 18 completed submarines, while many more are in course of construction or have been authorized. The new submarine programme may be of larger dimensions than is generally known, for a report was published in Berlin last January that the Dutch Government had placed an order with the firm of Thiess for 18 submarine Diesel engines, six of 450 horsepower and twelve of 1200 horsepower. The boats, it was added, would be built in Dutch yards. Apparently ten of the latest submarines are earmarked for service in the East Indies fleet—officially designated the Indian Marine—which already includes the finest surface vessels of the Netherlands Navy.

Java, Sumatra, and the other insular possessions in the Pacific have a total area of 735,000 square miles, so that Holland has to provide for the defense of Pacific colonies which are more than seven times as large as the Mother Country. Her stake in that ocean is therefore a considerable one, and the upkeep of the local naval and military forces costs her nearly £8,000,000 per annum. The Dutch Minister of Marine, in a speech last year, intimated that, although it was hopeless to think of defending single-handed these colonies against attack by a great power, the object was to provide a naval force sufficiently strong to hold an invader in check pending the arrival of aid from another quarter—the implication being that Holland, in such a contingency, would appeal to some powerful neighbor for armed assistance. Submarines are peculiarly adapted to coastal defense, and it is probable that the Dutch authorities are expanding their underwater fleet more with an eye to possible emergencies in the Far East than in Europe.—*Naval and Military Record*, 5 October, 1921.

#### CURRENT PROFESSIONAL PAPERS

- The Purpose and Nature of a Fleet. *Nineteenth Century*, October, 1921.  
 Wireless Telephony. *Annual Report of Smithsonian Institution*, 1919.  
 National Ports. *Proceedings of American Society of Civil Engineers*, October, 1921.  
 The Fortress of Heligoland. *The Engineer*, 21 October, 1921.  
 The Negatron: A New Negative Resistance Device for Use in Wireless Telegraphy.—*Engineering*, 21 October, 1921.

# NOTES ON INTERNATIONAL AFFAIRS

FROM OCTOBER 10 TO NOVEMBER 10

PREPARED BY

PROFESSOR ALLAN WESTCOTT, U. S. Naval Academy

---

## WASHINGTON CONFERENCE

**PLANS FOR NAVAL REDUCTION.**—The formal opening of the conference on Reduction of Armaments in Washington was scheduled for October 12. Press reports prior to the opening of the conference indicated that the American delegation would present a carefully worked out plan for a general reduction of naval armaments.

The head of the Japanese delegation, Baron Kato, on November 8 issued an official statement declaring that Japan would not, as had been reported in American newspapers, insist on carrying out her building program as regards capital ships, but would cut this or any other part of her program to conform to any plan agreed upon.

## GREAT BRITAIN AND IRELAND

**THE LONDON CONFERENCE.**—Consultations between British and Irish political leaders were renewed in London on October 11. At several points in the subsequent negotiations the conference appeared on the verge of failure. The British delegates were especially provoked by a letter from Mr. de Valera to the Pope objecting to the phraseology of a note from King George to the Pope, and denying Ireland's allegiance to the British king. Conferences were resumed on October 24. Following sharp criticism of government policy on the part of "die hard" conservative members, the House of Commons on October 31 by a vote of 439 to 43 gave Premier Lloyd George a mandate to continue negotiations. At the same time the premier announced the necessity of delaying for some time his departure for America.

In November it became clear that the Sinn Fein delegates were willing to accept the English demands, including admission of allegiance to the king and provision of military and naval safeguards in Ireland, on condition of certain concessions on the part of Ulster, involving the possible transfer of the counties of Tyrone and Fermanagh and the inclusion of Ulster in closer political union with the southern government.

**SOLUTION DEPENDENT ON ULSTER.**—Following a conference in London between Premier Lloyd George and Premier Sir James Craig of Ulster, the latter summoned the Ulster Cabinet to London on November 10 for





THE ULSTER PROBLEM AS THE MAP SHOWS IT

The shaded portion with the two counties in black comprise Ulster. London advices have stated that a final settlement of the whole Irish difficulty might hinge on Ulster's willingness to yield Tyrone and Fermanagh, both largely Catholic, to the Sinn Fein.

With the two counties in question added to the South, the Northern Government would have jurisdiction over less than half of the province, which has an area of 8613 square miles, while its population is hardly a million and a quarter, having shrunk from 2,286,622 in 1841 to 1,581,350 in 1901.

Tyrone has an area of 1260 square miles. Its population has shrunk from 313,000 in 1841 to 150,470 in 1901. Fermanagh has an area of 714 square miles. Its population in 1881 was 84,879 and twenty years later, 65,243. In Fermanagh the Catholics predominate in small communities on the eastern, southern and western border. The center and northern parts, adjoining the Catholic part of Tyrone, are predominantly non-Catholic.—*N. Y. Times.*

consultation. British press reports indicated that the Ulster leaders would not at once reach a decision, but that the prospects of concessions on their part were not bright.

In the meantime, the Ulster Government was granted judicial, educational, agricultural, and financial powers as provided in the Home Rule Act, and was extended an appropriation of £1,000,000 for the construction of a parliament house.

## GERMANY

**SETTLEMENT OF SILESIAN QUESTION.**—The Council of the League of Nations, to which the Silesian problem was referred by the Allied Powers, reached a decision which was accepted by the powers and communicated on October 20 to Germany and Poland. The solution was in the nature of a compromise which, roughly speaking, bisected the industrial triangle in dispute. At the same time provision was made for a commission composed of two Germans and two Poles with a neutral chairman to draw up a convention for the preservation of economic unity in the region thus divided. Details of the decision follow:

The boundary runs from a point where the Oder River crosses the Silesian border on the south through Rybnik to Niobotechau and gives Poland most of Rybnik province and all of Pless. Of the industrial basin Germany keeps Gleiwitz and Zabrze as well as the city of Beuthen. Poland gets Koenigshutte and Beuthen country, Kattowitz City and Kattowitz Country. The districts of Tarnowitz and Lublinitz are split, the western part going to Germany and the eastern to Poland. Germany keeps the northern and western part of the Upper Silesia.

The decision sets forth that the commission of two Germans, two Poles and a member named by the League of Nations shall prepare an accord for putting into effect the Allies' orders to preserve the economic interests of the territory involved. For fifteen years the railroads of both sections must be operated as one system with the same rates for both sides of the border. A reciprocal agreement must be established for water and electric supplies. The existing German currency shall be used for fifteen years throughout the district.

For fifteen years raw products from both sides of the line shall pass duty free to other parts of the industrial zone, and provision made for free passage of half finished products from one side of the border and back again under special permits. Both countries will agree during the prescribed fifteen years to take no unduly restrictive measures affecting the other section of the industrial area. On the basis of the average business year from 1911 to 1913, Poland shall supply to Germany a proportion of the product of the coal mines she gets and Germany shall furnish a proportion of iron ore for fifteen years. For fifteen years residents on one side of the line who work on the other shall pass freely on a commission pass without further formalities.

In case of any dispute arising which the commission is not able to settle amicably, either government may refer it to the League of Nations and must bind itself in advance to accept the findings of Geneva.

**CABINET REORGANIZATION.**—The Silesian decision, depriving Germany of a part of the industrial and mineral resources it had hoped to retain, brought about a crisis in German politics and finance. It was asserted that the loss of territory would take from Germany 84 per cent of Upper Silesian

anthracite coal (or 42 per cent of Germany's total deposits), all of the zinc production of the region, and about 60 per cent of the Upper Silesian iron industry.

A cabinet reorganization took place marked chiefly by the withdrawal of the Democratic party from representation in the government. On October 26 the Chancellor, Dr. Wirth, announced a new ministerial state, the only actual changes in which were that the Foreign Minister, Dr. Rosen, was dropped and his duties taken over temporarily by the Chancellor, and a new minister of justice was named. The so-called "Cabinet of Predicament" was supported by the Reichstag by a vote of 230 to 132; it can count, however, only on the Centrists and Socialists, and less certainly on the Democrats, making 216 out of a total of 469 votes. The German People's party, or party of "big business," agreed only to a benevolent neutrality.

SENATE RATIFIES GERMAN PEACE TREATY.—On October 18 the U. S. Senate ratified the treaties ending war with Germany, Austria, and Hungary. The vote on both the German and the Austrian treaties was 66 to 20 (52 Republicans for and 2 against, 2 Democrats for and 14 against). Exchange of ratifications on November 8 made the Austrian treaty effective, and it was expected that ambassadors would at once be appointed.

THREATENED FINANCIAL COLLAPSE.—*Paris, November 6.* Announcement made here last evening that the Reparations Commission had decided to go to Berlin is being interpreted as showing that the situation while acute, is not yet beyond the possibility of arrangement.

The proclaimed object of the visit of the commission is to ascertain what has been done by the German Government, and what remains to be done toward the payment of \$120,000,000 due on January 15, as the second instalment of the reparations payment which Germany accepted under the ultimatum last April.

Under Article 248 of the Treaty of Versailles the commission has first charge upon all assets and revenues of the German Empire. If, therefore, the German Government finds itself unable to pay and in a position to pledge some of its revenues and assets, it can do so only by consent of the commission. On the spot all the necessary information can be better secured and consent more rapidly given.

The need for hurry lies in the fact that Germany must be, by order of the Committee on Guarantees, by November 15 in a position to produce a percentage of the total payment due on January 15, and that by December 1 25 per cent of the value of foreign exports must also be available, under Paragraphs A and B, Article 7, of the Accord of London. To obtain these sums, which must be paid in gold or foreign values, the German Government can negotiate either with German bankers or abroad, and in order to do so it is understood that she wishes to be relieved from the lien which the Commission on Reparations has on the resources.—*N. Y. Times, 7/11.*

## PORTUGAL

REVOLUTION IN LISBON.—On October 19 a revolutionary uprising in Lisbon forced President Almeida to dismiss the Granjo Cabinet, dissolve parliament, and accept a new ministry headed by the revolutionary leader Col. Manuel Coehlo. Four members of the Granjo Cabinet were put to death. The new government proclaimed martial law, condemned the murders committed, and succeeded in reestablishing order.

## RUSSIA

SOVIET OFFERS TO RECOGNIZE DEBT.—On October 30 the Soviet Government issued a wireless message announcing that it was ready to recognize and make arrangements for the payment of the national debt of Russia up to August, 1914, in return for formal recognition by the powers.

In reply on November 2 the British Government expressed its pleasure that Russia had seen the necessity of recognizing its obligations as preliminary to a renewal of economic relations. The British note made inquiries as to the status of loans, claims, etc., subsequent to August, 1914, and as to other points not made clear in the Soviet message.

## HUNGARY AND SOUTHEASTERN EUROPE

HUNGARY EXPELS HAPSBURGS.—Leaving Switzerland by airplane in violation of pledges to the Swiss Government, the former Emperor Charles and former Empress Zita reentered Hungary on October 21, in a second effort to regain the Hungarian throne. On the march from Odenburg to Budapest, the forces of Charles were defeated by troops of Regent Horthy, and the royal couple were captured and interned.

Through their ministers in Budapest, the Allied Powers on October 24 issued an ultimatum to Hungary demanding the deposition of Charles, his arrest, and his expulsion under terms to be fixed by the Allies. The nations composing the Little Entente at once mobilized on the Hungarian frontiers and on October 27 sent a 48-hour ultimatum demanding not only the deposition of Charles but reimbursal for the cost of mobilization.

The Hungarian Government, acceding to these demands, passed a law disbarring all members of the Hapsburg family from the throne. On November 1 the ex-emperor and ex-empress were turned over to the Allied Powers and went aboard the British gunboat *Glowworm* for transportation down the Danube, and ultimately to the island of Madeira, where it was proposed that Charles should be interned.

In the meantime the insurgent Hungarian forces holding Burgenland continued to oppose the surrender of that territory to Austria on the terms finally agreed upon by the conference on that subject held in Venice.

MONTENEGRO OUT OF EXISTENCE.—On October 21 Queen Melina, widow of Nicholas I of Montenegro, signed an order relieving her ministers of their duties, and thus terminating the agitation to continue Montenegro as an independent state. Montenegro was merged, in November, 1918, into the new Yugoslav state. Although Italy for a time encouraged Montenegrin propaganda for independence, her support was withdrawn after the Treaty of Rapallo (December, 1920) with Jugoslavia.

ALEXANDER TAKES JUGOSLAV THRONE.—On November 5, King Alexander, son of the late King Peter, took the oath of office as sovereign of Jugoslavia. It was stated that the king had nearly recovered from the illness which delayed his return from Paris to the Serbian capitol.

**PROTECTION FOR ALBANIA.**—After a long delay, during which Albania was invaded by both Greek and Yugoslav forces, the Allied Council of Ambassadors on November 5 re-established the Albanian frontiers as they existed prior to the war. Notes were at once sent to the Greek and Yugoslav governments requesting the withdrawal of their troops. The British Government called the attention of the League of Nations Council to conditions in Albania as threatening international peace.

**FRENCH TREATY WITH KEMAL PASHA.**—On October 30 the French Government announced ratification of a treaty with the Turkish Nationalist Government at Angora, providing for the resumption of peaceful relations and economic cooperation. France withdraws from Cilicia, the line between Turkey and the French protectorate of Syria is established just south of the Bagdad railway east of the Gulf of Alexandretta, and France gains economic advantages, including a concession for operating the Bagdad Railway from the Mediterranean to the Tigres river and mining rights in northern Asia Minor. Negotiations for this agreement had been carried on for some time previously by the French agent Henry Franklin Bouillon.

**BRITISH PROTEST.**—Immediately upon the publication of the Franco-Turkish agreement the British Government sent a note to France protesting against certain of its terms. When this note was communicated to Premier Briand in Washington, he indicated that his reply would take the lines: (1) that the British had been aware of the general terms of the accord and that their objections were therefore belated; (2) that the accord follows the terms of the agreement outlined in London last spring, to which the British never objected.

The real cause of the dispute seems to be in a clash of the two policies which France and England have separately pursued in the Near East ever since the end of the war. The French have constantly endeavored to obtain a settlement by what they call a positive policy—dealing with the facts of the situation as they found them. The British policy on the other hand has been as constantly negative in its refusal to recognize Mustapha Kemal as the de facto government of Turkey with consequent admission of Turkish independence.

The French are more than pleased with the success of their policy with its fruitful consequences in reduction of military expenditure in Cilicia and increase of moral prestige in the Near East as respecters of Mussulman independence. There is in newspaper comment a note of satisfaction that France has taken from England the lead in liberalism and contrast is made between the "puppet show of independence made by King Feisul in Mesopotamia" with the real independence of Kemal freely recognized by France.

Unconfirmed news reached Paris to-day that Mustapha Kemal is completing his preparations for an aggressive winter campaign against the Greeks. This news, however, is regarded rather as a bluff intended to hurry the Greek Minister Gounaris into making concessions in the terms which he is now trying to arrange in London as a basis for mediation by the Allies.—*N. Y. Times*, 9/11.

## UNITED STATES

**SENATE PASSES FREE PANAMA CANAL BILL.**—On October 10, the U. S. Senate by a vote of 47 to 37 passed the Borah bill giving to vessels in the American coastwise trade the right of free passage through the Panama

Canal. The bill was passed in spite of the desire of President Harding that it should not be taken up at this time, and in spite of the opposition of the Republican leader, Senator Lodge. The bill went to the House where it is likely to be held up until the armament conference is well under way, if not concluded.

#### FAR EAST

**JAPANESE PREMIER ASSASSINATED.**—On November 5 Takashi Hara, Premier of Japan, was stabbed to death in a railway station of Tokio. The murderer, a 19-year-old Japanese named Nakoka, was captured and indicated in his confession that his deed was premeditated and the result of political fanaticism.

**CHINA DEFAULTS PAYMENT ON AMERICAN LOAN.**—On October 31 the U. S. Department of State sent a message to the Chinese Government to the effect that failure on the part of China to pay principal and interest on the loan of \$5,000,000 made by the Continental and Commercial Trust and Savings Co. of Chicago and due October 31, would detract from China's financial and political credit in the United States and make it difficult for the United States to continue to recognize the Peking Government. The Chinese Government's reply on November 6 declared its purpose to secure a refunding of the loan at the earliest possible moment.

In connection with China's financial difficulties, it was asserted by the British adviser of China, Mr. Lenox Simpson (Putnam Weale), that the refusal of China last year to accept the 16 million dollar loan offered by the consortium of powers through the agency of Mr. Thomas W. Lamont was due to Mr. Lamont's insistence that China recognize the Hu Kuang bonds of German issue which China repudiated on entering the war. It was asserted that the J. P. Morgan Co. held \$3,000,000 of these bonds. Mr. Lamont issued a vigorous denial of these charges.

**CHINA REBUFFS SHANTUNG OFFERS.**—Replying to China's refusal (October 5) to consider the Japanese proposals relating to Shantung, Japan on October 19 published another note justifying her position and calling attention to the fact that the Japanese acquisition of Shantung had been recognized by China before her entry into the war, and could not therefore be affected by any action upon China's entry. The reply of China on November 4 restated her reasons for considering the Japanese offers unsatisfactory, and again refused to enter negotiations on such a basis. The reply was summarized in part as follows:

"The Chinese memorandum of October 5 points out the difference in views between China and Japan regarding the principles underlying the Japanese proposals and the contents and terms thereof. If the Japanese Government understood these differences, she would very surely have proposed a more substantial and more just project, which would universally be recognized as fair. It is most regrettable, however, that the Japanese Government has given no sign of concessions, while maintaining that China is openly unwilling to proceed with negotiations.

"China was unable to sign the Versailles Treaty owing to the Shantung article, whence it is impossible to compel her to recognize the effects, arising from the treaty regarding Shantung. Japan considers that the Kiao-Chau leasehold was transferred to her by the operation of the treaty, while China deems the leasehold to have expired through her declaration of war against Germany. If both countries insist on this difference in viewpoint a solution of the problem would be rendered forever impossible, but since Japan is willing to restore Kiao-Chau completely to China, further necessity for Japan's insistence on the point in the dispute does not exist.

"Regarding the German declaration concerning Shantung, China, when the Sino-German commercial agreement was negotiated, insisted on her demand for the restoration of Kiao-Chau, but Germany could only regret to China that Germany's power for returning Kiao-Chau had been lost through a force majeure, which explanation China simply acknowledged. Hence it is a serious misunderstanding for Japan to construe this incident as meaning China's recognition of the Versailles Treaty.

"It must be observed that the Kiao-Chau-Tsinan-Fu railway was not public German property, or private property exclusively German-owned, but was built within Chinese territory and had a corporate nature, with Chinese capital invested, and that China had long looked for the opportune moment for its reclamation.

"Further, the right of policing was exclusively China's, and absolutely no military necessity justified Japanese occupation. China, thereupon, repeatedly protested the Japanese army's occupation of the railway as unjustified, pointing out that German troops were never stationed along the line, except within the leased territory. When China entered the war for the Allies, the properties of all the Chinese railways should have been returned to Chinese control, but the Japanese troops have remained, refusing to withdraw and causing endless losses to the Chinese along the railway.

"The Chinese memorandum of October 5 proposes, regarding the claim of right to control of the railway, to divide the entire capital and property into two halves, stating that China will redeem the Japanese half within a fixed period. This arrangement being most fair and just, the Japanese statement that China's proposal is devoid of meaning, is regrettable."

## REVIEW OF BOOKS

---

"Modern Seamanship." By Rear Admiral Austin M. Knight, U. S. Navy (Retired). Price \$7.00. (D. Van Nostrand Company, New York City.)

During the last twenty years, seamanship has been gradually taking her place among the progressive arts. The reasons are, of course, that the modern ship is a machine; that the modern battleship is the most powerful machine in the world, and yet the most delicate in proportion to her power; and that the destroyer, and still more the submarine, are more highly developed products of science and invention than even the physical and chemical laboratories of most colleges. As invention succeeds invention, every technical art changes to take advantage of them; and, as virtually every technical art is now represented on board of ships, and especially of naval ships, the art of handling those ships has become a technical art, and must necessarily change also.

Since no man can skilfully practice any technical art unless he keeps in practical acquaintance with the changes in that art, and since seamanship is one of the most exacting of all the technical arts, because it deals with the lives of men in continual possible peril, the seaman owes it to himself and to the ships and the men whose safety depends upon him, to keep up to date continually with the changes in seamanship.

To assist the seaman to do this, is evidently the object of the eighth edition of this book; so clear is the author's effort to illustrate and describe the many changes that have taken place since the seventh edition appeared in 1917. These changes were caused mainly by the requirements of the great World War. The principal changes in the book are the addition of the chapters on submarines and submarine chasers, and the amplification of the chapter on destroyers. Another change, nearly as important, is the additional chapter headed "Assistance by Public Vessels to Vessels in Distress," which was prepared by two officers of the Coast Guard, and which gives the seaman the benefit of all the expert knowledge and skill of that excellent organization, that has been developed by years of practice and experience.

For the reasons that the author published his first edition when he was head of the Department of Seamanship at the U. S. Naval Academy; that he has published six separate editions between the first one and the present; that he has, during the twenty years that have elapsed, commanded two navy ships, been president of the Special Board on Ordnance, Commander-in-Chief of the Reserve Fleet, President of the War College and Commander-in-Chief of the Asiatic Fleet—and that he has therefore not only kept in



close touch with seamanship itself but with all branches of the naval profession—for all these reasons, the reviewer feels a natural reluctance to express his individual opinion about any of the views expressed by the author, or any of his conclusions or declarations. If the present author is not *facile princeps* in the matter covered by his book—who is?

It might be, of course, that, despite his intimate knowledge of the subject, the author might be unable to communicate his knowledge to others. But a careful perusal of "Modern Seamanship" brings out the fact that the author is a master of diction; that his style is smooth and pleasant, and that his descriptions are so clear as to present real pictures to the mind. Furthermore, these pictures are reinforced by 199 full page plates, some of which include several separate figures. And while each of the plates is well executed, some are executed with a degree of finish and beauty that seems hardly necessary in a text book.

Yet it cannot reasonably be denied that the more attractively a text book is prepared, the more favorably it will impress the student; the more his interest will be aroused, and the more clear will be the impressions made on his mind and memory. And when one considers the immense amount of knowledge that the authorities have to force into the brains of midshipmen now, he must admit that anything which helps the midshipmen to assimilate it is a work of mercy.

So many and great have been the changes in ships and ships' equipments during the past of four years, that some changes and additions have had to be made in nearly every chapter in the book, even the chapters on "Rope" and on "Knotting and Splicing." The chapter on "The Compass, Log and Lead—Submarine Signals" has been made to include the Radio Compass and the system of piloting by its use. The chapter on "Boats" has been amplified and enriched with several additional plates. The chapter on "Ground Tackle" contains many new and important changes and additions. The chapter on "The Rules of the Road," is, in its general arrangement, the clearness of the descriptions, the author's notes concerning them and the really beautiful colored pictures which illustrate them, one of the most satisfying expositions that I have ever seen in any text book on any subject. Almost in the same class are the chapters on "Maneuvering to Avoid Collison," "Piloting," "Handling a Steamer Alongside a Deck," and "Placing a Ship in Dry Dock." The admirable chapter on "Weather and the Laws of Storms" has not been changed materially in the text, but the illustrations have been improved. The chapter on "The Handling of Destroyers" is extremely interesting, almost exciting: especially the latter half. The chapter on "Submarines" is entirely new. The chapter on "Keeping Stations and Maneuvering in Squadron" is so well up to date that it includes a discussion of the handling of the Idaho. The chapter on "Towing" has been revised, and so has the Appendix.

While the book is designed primarily for use as a text book, the fact should not be overlooked that it has a field of usefulness of perhaps even greater importance as a work of reference. It is, in fact, a very storehouse of information on the many subjects of professional interest which are

constantly arising in the every-day experiences of sea-faring life; and many a midshipman who look upon it during his course at the academy as of only temporary interest will find himself referring to it again and again, throughout his professional career, for the answers to questions which are answered nowhere else so fully and so clearly. In this fact lies the *raison d'être* of certain parts of the book which may find no place in the curriculum of the academy.

Not only the author but the publishers have done exceptional work in bringing forth this work; for paper, the type, the illustrations and the general appearance of the volume constitute a whole of which D. Van Nostrand & Co. may reasonably be proud.

B. A. F.

## SPECIAL NOTICE

### NAVAL INSTITUTE PRIZE ARTICLE. 1922

A prize of two hundred dollars, with a gold medal and a life-membership (unless the author is already a life member) in the Institute, is offered by the Naval Institute for the best original article on any subject pertaining to the naval profession published in the PROCEEDINGS during the current year. The prize will be in addition to the author's compensation paid upon publication of the article.

On the opposite page are given suggested topics. Articles are not limited to these topics and no additional weight will be given an article in awarding the prize because it is written on one of these suggested topics over one written on any subject pertaining to the naval profession.

The following rules will govern this competition:

1. All original articles published in the PROCEEDINGS during 1921 shall be eligible for consideration for the prize.

2. No article received after October 1 will be available for publication in 1921. Articles received subsequent to October 1, if accepted, will be published as soon as practicable thereafter.

3. If, in the opinion of the Board of Control, the best article published during 1921 is not of sufficient merit to be awarded the prize, it may receive "Honorable Mention," or such other distinction as the Board may decide.

4. In case one or more articles receive "Honorable Mention," the writers thereof will receive a minimum prize of seventy-five dollars and a life-membership (unless the author is already a life member) in the Institute, the actual amounts of the awards to be decided by the Board of Control in each case.

5. The method adopted by the Board of Control in selecting the Prize Essay is as follows:

(a) Prior to the January meeting of the Board of Control each member will submit to the Secretary and Treasurer a list of the articles published during the year which, in the opinion of that member, are worthy of consideration for prize. From this a summarized list will be prepared giving titles, names of authors, and number of original lists on which each article appeared.

(b) At the January meeting of the Board of Control this summary will, by discussion, be narrowed down to a second list of not more than ten articles.

(c) Prior to the February meeting of the Board of Control, each member will submit his choice of five articles from the list of ten. These will be summarized as before.

(d) At the February meeting of the Board of Control this final summary will be considered. The Board will then decide by vote which articles shall finally be considered for prize and shall then proceed to determine the relative order of merit.

6. It is requested that all articles be submitted typewritten and in duplicate; articles submitted written in longhand and in single copy will, however, receive equal consideration.

7. In the event of the prize being awarded to the winner of a previous year, a gold clasp, suitably engraved, will be given in lieu of the gold medal By direction of the Board of Control.

F. M. ROBINSON,  
*Commander, U. S. N., Secretary and Treasurer.*

## INDEX TO VOLUME 47

Figures in bold type indicate whole number; light figures following indicate page number.

### A

- Abercrombie** (H. M. S.). Illustration. **223**, 1325.  
**cross the continent with an insane man.**  
R. E. Coontz. **225**, 1749.  
**Admiralty Law.** See: Maritime Law.  
**Aeronautics.**  
Craven, T. T. Naval aviation and a united air service. **217**, 307.  
Cummings, D. E. Use of aircraft in naval warfare. **225**, 1677.  
Earle, Ralph. Naval aviation and a united air service. (Discussion.) **218**, 561.  
Edmonds, D. H. K. Aerial cooperation with the navy. **221**, 1114.  
Edwards, W. A. Naval aviation and a united air service. (Discussion.) **218**, 564.  
Hunsaker, J. C. Aerodynamics. (Illus.) **224**, 1519.  
Taylor, D. W. Naval aviation and a united air service. (Discussion.) **218**, 566.  
Air and sea power. **224**, 1616.  
Aircraft and lightning. **224**, 1652.  
Aircraft vs. surface vessels and submarines (1921). **225**, 1819.  
Aveline automatic pilot. **219**, 765.  
Catapult for U. S. Navy. **226**, 1975.  
Functions of naval aircraft. **221**, 1095.  
Mission of aircraft with the fleet. **217**, 431.  
Night flying experiments. **223**, 1462.  
Some problems in aeronautical research. **219**, 766.  
"Stunt" flying prohibited by U. S. War Department. **223**, 1465.  
The airplane and science. **224**, 1647.  
Theory of slotted wing. **226**, 1974.

### Accidents

- D-6*. Burns. **224**, 1649.  
Destruction of *R-38*. **224**, 1648.  
Lesson of the *ZR-2* disaster. **225**, 1830, 1842.

### Aeronautics.—Cont'd

#### Aircraft

- Fulton, Garland. Rigid airships. (Illus.) **224**, 1565; **225**, 1697.  
Behavior of a helicopter. **221**, 1131.  
Development and construction of Caproni airplanes. **216**, 272.  
Helicopter makes 312 miles per hour. **223**, 1461.  
*JL-12* attack plane. **226**, 1972.  
*L. F. G.—V3a* flying boat; description. **223**, 1464.  
Planes carrying small scouting craft. **226**, 1974.  
Proposed American transport plane. **220**, 951.  
Transatlantic flying ships. **224**, 1648.

#### Bombing

- Alabama* bombing tests. **224**, 1663.  
Aviators to bomb ex-German warships in tests. **219**, 767.  
Bombing tests, July, 1921. **223**, 1458.  
Bombing tests of the U. S. S. *Alabama*. **225**, 1827, 1834.  
Bombing the radio-controlled *Iowa*. **221**, 1112.  
Brig. Gen. Mitchell attacks U. S. bomb test findings. **225**, 1828.  
Calendar of June-July, 1921, bombing tests. **221**, 1112.  
Depth bombing from the air. **223**, 1353.  
Limitations of aerial bombing. **222**, 1303.  
Report of Army and Navy Board on bombing tests, June-July, 1921. **224**, 1641.  
The new menace to sea power. **223**, 1451.  
What the Virginia capes aircraft bombing tests show. **225**, 1824, 1826.

#### Commercial

- Airships vs. steamships. **222**, 1301.

## Aeronautics.—Cont'd

## Dirigibles

- Construction of German *L-64* and *L-77*. **216**, 272.  
 Developments in dirigibles, 1921. **225**, 1838.

## Engines

- Some factors of aero engine performance. **219**, 767.  
 Steam engines for airships. **224**, 1647.  
 Thousand horsepower aero engine. **218**, 610.

## France

- Prospects in French naval aviation. (1921.) **217**, 406.

## Great Britain

- Aeronautics in Great Britain in 1920; a review. **218**, 610.

## Italy

- Air appropriation, 1922. **226**, 1977.

## Japan

- British air experts in Japanese navy. **222**, 1295.

## Navigation

- Airplane direction finding by radio. **217**, 441.  
 Determining ground speed. **224**, 1653.  
 The "distant" compass for aviators. (Illus.) **224**, 1654.

## Records

- Lt. Macready's altitude record. (1921.) **225**, 1840.

## Schools and training

- Flying academy proposed. **219**, 1338.

## United States

- Moran, C. G. Seapower: the Senate and the air. **225**, 1676.  
 A national air policy. **215**, 111.  
 A single air service. **219**, 763.  
 American aviation policy (1921). **220**, 950.  
 Naval aviation in the U. S. **217**, 435.  
 Needs of U. S. in aviation; statement of T. T. Craven before Naval affairs committee. **218**, 612.  
 Next step in commercial aviation. **219**, 769.

## Aeronautics.—Cont'd

- Our aerial mail service. **219**, 765.  
 Preparedness in the air. **218**, 610.

## U. S. Navy

- Reduction of U. S. naval air service. **226**, 1973.  
 Secretary Denby opposed to unified air control. **220**, 949.  
 Should the navy have a bureau of aeronautics? **220**, 948.  
 Air torpedoes. Tests of. **226**, 1982.  
 Aland islands. To remain under Finnish control. **222**, 1316.  
 Alcogas. Alcogas tests, 1921. **220**, 950.  
 Allen, A. M. R. Good steering. **210**, 187.  
 Allen, B. C. Yap. (Illus.) **225**, 17.  
 Allen, Walter H. The twelfth regiment (public works) at Great Lake. **217**, 367.  
 Altitude and azimuth.  
 Carney, R. B. Venus as a day sight. **221**, 1060.  
 Green, J. F. Navigation notes. **214**, 67.  
 Kielhorn, L. V. Approximate altitude and azimuth. **223**, 1387.  
 Rust, Armistead. Slide rules for navigators. **218**, 497.  
 Aluminum.  
 Aluminum alloys. **216**, 277.  
 Its properties and alloys. **220**, 957.  
 Amalgamation of corps.  
 Fisher, J. O. Amalgamation and specialists *versus* Corps. **222**, 129.  
 Ziegler, S. J., Jr. Specialization in Amalgamation. **221**, 1073.  
*See also*: U. S. Navy. Personnel.  
 Anderson, Walter S. Indirect fire for naval guns. **215**, 61.  
 Arc lamps. Something new in arc lamps. **215**, 116.  
 Arctic exploration. Arctic exploration by aeroplane. **224**, 1665.  
 Cruise of the *Quest*. **223**, 1466.  
 Armament, limitation of. *See*: Conference on Limitation of Armament.  
 Armor. British shell and armor at Jutland. **220**, 962.  
 Armor plate. Trials (1921) of German armor plate. **225**, 1843.  
 Armor tests. Shore batteries *vs.* battleships. **223**, 1468.  
 Arnaud, J. J. Underwater trajectories (Discussion.) **223**, 1417.  
 Aveline automatic pilot. Descriptive. **219**, 765.

## B

- Baden.** Gunnery tests. **221**, 1097.
- Ballistics.**  
 Arnaud, J. J. Underwater trajectories. (Discussion.) **223**, 1417.  
 Hawkesworth, A. A. New ballistic corrections. **222**, 1233. Underwater trajectories. **216**, 207.
- Bareboat charter plan of U. S. Shipping Board.** **225**, 1822.
- Barker, W. C. Jr.** Promotion in the navy. (Discussion.) **215**, 20.
- Battleships.**  
 Low, F. S. Fate of the dreadnought. (Discussion.) **218**, 568.  
 Vroom, G. B., and Stevens, W. O. Fate of the dreadnought. **216**, 191. See also correction. **218**, 577.  
 Battleship and the junk heap. **220**, 945.  
 Post-Jutland battleships. **225**, 1803.  
 Seaplane vs. battleships—a French view. **216**, 253.  
 Tabulated comparison of latest design in capital ships (1921). **219**, 786.  
 The backbone of the fleet. **224**, 1646.  
 The big ship survives. **219**, 747.  
 The warships of tomorrow. **216**, 281.  
 Will battleships soon be a thing of the past? **223**, 1457.
- Bayern** (S. S.). *Bayern's* maiden voyage. **225**, 1800.
- Bearing, line of.** Burrage, G. H. Mystery of the line of bearing. **217**, 379.
- Bearings.**  
 Krupp's single collar thrust bearing. **218**, 621.  
 Mitchell journal bearings. **219**, 778.  
 Single collar thrust bearing. **222**, 1308.
- Belknap, Reginald R.** A captain to his crew. **226**, 1857.
- Bermuda.** Value as naval base. **226**, 1953.
- Bingham, D. G.** Indirect fire for naval guns. (Discussion.) **216**, 249.
- Blasdel, F. G.** Solution of the officer personnel situation. **225**, 1779.
- Boats.** Motor boat torpedo carrier. **215**, 125.
- Boilers.**  
 Brueggerman water tube boiler. **225**, 1841.
- Bombing.**  
 Moran, C. G. Seapower: the Senate and the air. **225**, 1676.  
 Illustration of bombing ex-German battleship *Frankfort*. **225**, 1678.

## Book reviews.

- Andrews, L. C. Manpower. **218**, 645. Military manpower. **219**, 818.
- Andrews and Benson. Theory and practise of aeroplane design. **218**, 643.
- Ardoin, Paul. L'Emden et sa fin. **218**, 638. L'escadre allemande du Pacifique. **217**, 457.
- Bedell, Frederick. The airplane. **215**, 151.
- Bernhardi, F. Von. War of the future. **219**, 810.
- Bunker, Harold. Nautical tables. **216**, 295.
- Bywater, Hector. Seapower in the Pacific. **223**, 1486.
- Chambers, T. W. Gyroscopic compass. **219**, 819.
- Cisin, H. G. Modern marine engineering. **218**, 642.
- Clapham, Charles B. Arithmetic for engineering. **221**, 1145.
- Crawford, W. K. Shipbuilder's blue-book. **219**, 803.
- Cugle, C. H. Simple rules and problems in navigation. **218**, 645.
- De Meissner, S. R. Old Naval Days. **218**, 642.
- Doveling, Rene. L'action maritime pendant la guerre anti-germanique. **215**, 153.
- Dumbleton, J. E. Aerial navigation. **219**, 820.
- Fiske, B. A. Art of fighting. **219**, 805.
- Foch, Ferdinand. The principles of war. **220**, 976.
- Frothingham, T. G. Guide to military history of World War, 1914-1918. **215**, 152. True account of the battle of Jutland. **218**, 647.
- Gill, C. C. What happened at Jutland. **218**, 648.
- Glass, E. R. Editor. Machinist's Blue Book. **221**, 1147.
- Gleaves, Albert. History of the Transport service. **219**, 804.
- Goodwin, M. A. Alpha, Beta, Gamma navigation tables. **220**, 979.
- Hall, J. A. Law of naval warfare. **220**, 979.
- Jane, F. T. Fighting ships, 1920. **219**, 811.
- Jellicoe, J. R. Crisis of the Naval War. **218**, 641.
- Jenkins, J. T. Text book of oceanography. **223**, 1504.

## Book reviews.—Cont'd

- Kittredge, T. B. Naval lessons of the great war. **219**, 812.
- Knight, A. M. Modern seamanship, Eighth edition. **226**, 1993.
- Laurens, A. Introduction to the study of submarine warfare. **221**, 1149.
- Leighton, J. L. *Simsadus*. **217**, 461.
- Levin, C. C. Blue book of oil burning and burners. **219**, 819. Marine turbine power plant. **219**, 819.
- Library Assn. London. Subject index to periodicals. **218**, 643.
- Lineham, W. J. Treatise on hand lettering. **218**, 649.
- McNair, F. V. Handbook for Naval Officers. (1921.) **222**, 1319.
- MacBride, J. D. Handbook of practical shipbuilding. **218**, 644.
- Mitchell, Wm. Our air force. **217**, 459.
- Nemo, Captain. Laguerre avec le sourire. **215**, 153.
- Newbolt, Sir Henry. Naval history of the war. **220**, 976.
- Ocean Publishing Company. Blue book of facts of marine engineering, steam, gas, and turbine license. **219**, 812.
- Park, W. E. Treatise on air screws. **218**, 637.
- Perry, R. B. The Plattsburg movement. **223**, 1485.
- Rose, W. N. Mathematics for Engineers, **221**, 1145.
- Rowarth, E. The engineering draughtsman. **218**, 636.
- Runciman, Sir Walter. Drake, Nelson, and Napoleon. **221**, 1146.
- Sargent, H. H. Strategy on the western front. **216**, 296.
- Seaton, A. E. Manual of marine engineering. **222**, 1320.
- Sibley and Delany. Elements of fuel oil and steam engineering. **221**, 1148.
- Smith, C. A. Poe, and how to know him. **220**, 984.
- Taylor, C. C. Life of Admiral Mahan. **220**, 981.
- Vast, H. Little history of the great war. **218**, 646.
- Vela, M., and Janer, J. Balística, exterior telemetria y tiro naval. **215**, 150.
- Wead, F. W. Professional questions and answers for naval officers. **222**, 1319.

## Book reviews.—Cont'd

- Wyllie, R. E. Orders, decorations and insignia. **219**, 803.
- Boy Scouts. Smith, G. A. Sea scouting. **226**, 1901.
- Briand, Aristide. New premier of France, 1921. **217**, 451.
- Bremen (German submarine). *Bremen* fate revealed. **219**, 785.
- Brueggerman water-tube boiler. **219**, 1841.
- Bryan, B. C. Promotion in the navy. **222**, 1251.
- Burrage, G. H. Mystery of the line bearing. **217**, 379.

## C

- Cables. International cable system, 1921. **216**, 286.
- California (U. S. S.). Placed in commission. **224**, 1634.
- Canada.

## Navy

- The Canadian navy in 1921. **224**, 1629.
- Canals and waterways. Rhine-Main-Danube ship canal. **217**, 445.
- Carmine, C. C. Qualifications for leadership. **220**, 857.
- Carney, R. B. Venus as a day sight. **221**, 1069.
- Carr, J. C., Van de. See Van de Carr, J. C.
- Charles, Emperor of Austria. Attempted coup-d'etat, 1921. **219**, 798.
- Charles, ex-Emperor of Hungary. Attempted coup d'etat. **226**, 1089.
- Chase, J. V. New method of coastal navigation. (Discussion.) **222**, 1271.
- Christie gun mount. Description. **215**, 123.
- Cluverius, W. T. Soul of the service (Discussion.) **218**, 573.
- Collins, Elmer B. Position plotting by radio bearings. **216**, 201.
- Colloidal fuel. Its composition, uses and cost. **217**, 439.
- Commerce. Fiske, B. A. Disarmament and trade. **224**, 1539.
- Commodore, grade of. First award of the rank in British naval reserve. **226**, 1956.
- Compass error. Van de Carr, J. C. *T=C-IV*. **225**, 1763.

- Conference on Limitation of Armament.**  
 Agenda of Conference. **225**, 1847.  
 Japan's attitude (Oct., 1921). **225**, 1814.  
 Personnel of delegations. **225**, 1848.  
 Plans for naval reduction. **226**, 1985.
- Constitution (U. S. S.).** Illustration of "Old Ironsides." **218**, 475.
- Coontz, R. E.** Across the continent with an insane man. **225**, 1749.
- Coto incident, 1921.** The Coto dispute. **218**, 634.
- Craven, T. T.** Naval aviation and a united air service. **217**, 307.
- Creighton, J. M.** Europe since the Armistice. **221**, 1029.
- Cummings, D. E.** Aircraft in naval warfare. **225**, 1677.
- D**
- D-6 (U. S. N. dirigible).** Burns. **224**, 1649.
- D-6 (U. S. Naval balloon).** Burns. **225**, 1827.
- D'Annunzio, Gabriel.** Evacuates Fiume. **216**, 291.
- Dato, Eduardo.** Premier Dato assassinated. **218**, 632.
- Debts of nations.** Refunding debts of allies. **222**, 1312.
- Depth of water, and resistance of ships.** **216**, 271.
- Desertion.** Taylor, J. S. Commanding officer, recruiting officer and medical officer, *vs.* desertion. **215**, 39.
- Detonators.** Mercuric azide. **218**, 622.  
 Military initiators. **218**, 622.
- Deutschland (Ger. submarine).** Explosion while dismantling. (1921.) **225**, 1807.
- Diesel engines.** Design of Diesel engines. **216**, 278.  
 Experiments with fuel oil in Diesel engines. **219**, 776.  
 Present position (1921) of the marine Diesel. **215**, 117.  
 Problems in Diesel engine design. **218**, 619.
- Diplomacy.** Vroom, G. B. Place of naval officers in international affairs. **219**, 685.
- Direction finders.** Collins, E. B. Position plotting by radio bearings, **216**, 201.  
 Hunter, H. O'D. Practical test of radio compass shore stations. **217**, 363.  
 Aeroplane radio direction finding. **217**, 441.
- Direction finders.—Cont'd**  
 Fiske, B. A. Disarmament and trade. **224**, 1539.  
 Chemical disarmament. **217**, 442.  
 Disarmament impetus in Japan (1921). **220**, 940.  
 Harding's disarmament proposal and Japan's attitude. (1921.) **223**, 1476.  
 League of nations disarmament proposal. **215**, 146.  
 Limitation is not disarmament. **224**, 1635.  
 Postponement of the world's disarmament. **216**, 282.  
 Powers accept proposal for conference. **224**, 1667.
- Disarmament Conference.** *See:* Conference on Limitation of Armaments.
- Discipline.**  
 Belknap, R. R. A captain to his crew. **226**, 1857.  
 Cluverius, W. T. The soul of the service. (Discussion.) **218**, 573.  
 Fenner, E. B. Discipline. **223**, 1371.  
 Jessop, E. P. Soul of the service. **217**, 351.  
 Taylor, J. S. Commanding officer, recruiting officer and medical officer, *vs.* desertion. **215**, 39.
- Docks.** Surrendered German floating docks. **226**, 1955.
- Dreadnought, fate of the.** G. B. Vroom and W. O. Stevens. **216**, 191. *See also: Correction.* **218**, 577.
- Dukes, Sir Paul.** British spy among the Bolsheviks. **219**, 785.
- Dutch East Indies.** Defense of. **226**, 1983.
- Dyes.**  
 German and British industries and the war. **220**, 930.
- E**
- Eagle (H. M. aircraft carrier).** Completion of. **226**, 1955.
- Earle, Ralph.** Naval aviation and a united air service. (Discussion.) **218**, 561.
- Edmonds, C. H. K.** Aerial cooperation with the navy. **221**, 1114.
- Edwards, W. A.** Naval aviation and a united air service. (Discussion.) **218**, 564.
- Electric propulsion of vessels.** Diesel electric drive installations. **219**, 775.  
 Electric drive. **218**, 618.  
 Points of contention. (1921.) **225**, 1802.  
 Turbo-electric propulsion. **225**, 1804.



- Electric shock.** Effects of electric shock on the human system. **219**, 785.
- Electrical engineering.** Power factor of induction motors. **219**, 777.
- Engines.** New motive plant for submarines. (1921.) **226**, 1963.
- Engines, internal combustion.** Internal combustion engines for ships. **222**, 1300.
- Petrol engine efficiency. **222**, 1306.
- Erzberger, Matthias.** Assassination of. **224**, 1672.
- Europe since the armistice.** J. M. Creighton. **221**, 1029.
- European War, 1914-1918.**
- Peace**
- Knox peace resolution passed in U. S. Senate. **220**, 970.
- Reparation terms and amount. (1921.) **217**, 447.
- U. S. adopts peace resolution. **222**, 1311.
- U. S. treaty with Germany signed at Berlin. **224**, 1668.
- Strategy**
- Frothingham, T. G. Strategy of the World War and the lessons of the effort of the U. S. **219**, 669.
- Trials of war criminals**
- The Leipsig Court and German justice. **222**, 1284.
- The Leipsig trials. **223**, 1431.
- Expeditions overseas.** King, E. L. Overseas expeditions. **226**, 1911.
- Explosives.**
- British naval cordite. (1921.) **225**, 1844.
- Flash-less powder. (1921.) **225**, 1844.
- F**
- Faust, W. H.** Bird's-eye view of admiralty law and practice. **226**, 1919.
- Fenner, E. B.** Discipline. **223**, 1371.
- Fire control.** Hill, H. W. Fire control problems and their solution. **225**, 1765.
- Tactical problems and their solution. **225**, 1765.
- Fisher, J. O.** Amalgamation and specialists vs. corps. **222**, 1209.
- Fiske, Bradley A.**
- Disarmament and foreign trade. **224**, 1539.
- Fiske, Bradley A.—Cont'd**
- Relative importance of Philippines to Guam. **225**, 1676.
- Warfare of the future. **216**, 157.
- Flags.** Austrian merchant flag. 1845.
- Fog signals.** Fog safety devices. **224**, 1647.
- France.**
- Finance**
- Financial position of France, 1919. **215**, 95.
- History**
- Creighton, J. M. Europe since the Armistice. **221**, 1037.
- Imports and exports**
- Volume of French foreign trade, 1919. **226**, 1948.
- Naval Policy**
- Changing elements of seapower (1921). **225**, 1791.
- French naval policy (1921). **223**, 1423.
- Navy**
- French fleet in 1921. **219**, 743.
- French naval notes, Nov., 1921. **226**, 1941.
- French naval problem (1921). **216**, 741.
- French naval progress, 1921. **221**, 1089.
- New French training methods (1921). **225**, 1796.
- Administration**
- French marine ministry, 1921. **218**, 577.
- Frost, Holloway H.** Results and effects of the battle of Jutland. **222**, 1323.
- Frothingham, Thomas G.** Strategy of the World War and the lessons of the effort of the U. S. **219**, 669.
- Fuel.**
- Colloidal fuel. **217**, 439.
- Pulverized peat as locomotive fuel. **215**, 114.
- Coal**
- Powdered coal for power plants. **216**, 275.
- Oil**
- Oil fuel in British Navy. **222**, 1222.
- Fulton, Garland.** Rigid airships (illus.). **224**, 1565; **225**, 1697.

## G

Georgetown University. To train sea experts. **224**, 1637.

Germany.

## History

Creighton, J. M. Europe since the Armistice. **221**, 1042.

## Industry

Germany's third year of peace. **215**, 96.

Industrial and economic situation in Germany. **218** 579.

## Navy

German navy in 1921. **223**, 1429.

German navy in the making (1921). **224**, 1624.

Gilmer, F. H.

On psychology and the navy. (Dis.) **220**, 917.

Psychology and the naval officer. **226**, 1909.

Psychology and the navy. **215**, 77.

Good, R. F. Leadership of men. **221**, 1013.

Goodwin, H. B. New method in coastal navigation. **219**, 723.

Goss, N. H. Amalgamation. **216**, 231.

Great Britain.

## Defense

Scheme of empire naval defense (1921). **216**, 255.

## Foreign policy

British policy in Turkey. **221**, 1142.

## Foreign relations

Anglo-American naval agreement. **220**, 929.

Anglo-Japanese pact dead? **220**, 941.

## History

Creighton, J. M. Europe since the Armistice. **221**, 1030.

## Naval administration

Imperial strategy and a combined staff. **217**, 407.

## Naval policy

British fleet expansion. **224**, 1630.

Economy and security in naval policy. **216**, 257.

Imperial strategy and a combined staff. **217**, 407.

## Great Britain.—Cont'd

Lord Lee on naval policy. (1921.) **219**, 746.

Naval policy of the Empire. **222**, 1288.

The Navy in the Pacific. **218**, 585.

## Naval Reserve

Assignment of admirals in British reserve fleet. **225**, 1807.

## Navy

The British Navy and the strikers (1921). **220**, 928.

## Promotion and pay

Married naval officers. **226**, 1956.

## Royal Air Force

Royal Air Force organization and policy, 1921. **216**, 258.

## Royal Naval Reserve

Reorganization of. **226**, 1957.

Great Lakes naval training station.

Allen, W. L. The twelfth regiment (public works) at Great Lakes. **217**, 367.

Green, J. F. Navigation notes. **215**, 67.

Griffith, Jolin T. Photo. **215**, 1.

Grog, origin of. Thorpe, G. C. Origin of grog. **217**, 377.

Guam. Fiske, B. A. Relative importance of Philippines and Guam. **225**, 1676.

Guidoni, A. Salvage of the *Leonardo da Vinci*. (Illus.) **225**, 1680.

## Gunnery.

Anderson, W. S. Indirect fire for naval guns. **215**, 61.

Bingham, D. C. Indirect fire for naval guns. **216**, 249.

Kinkaid, T. C. Probability and accuracy of gun fire. **224**, 1543.

Leary, H. F. Gunnery and turret design. **223**, 1393.

Dispersion of projectiles. **219**, 780.

The *Baden* as a target (1921). **221**, 1097.

## Guns (anti-aircraft).

Tests on dummy men in gliders. **226**, 1975.

## Guns (ordnance).

Blandy, W. H. P. Elastic strength of radially expanded guns. **220**, 883.

Autofrettage method of gun construction. **216**, 280.

British gun construction (1921). **220**, 958.

De-coppering of guns. **219**, 780.

**Guns (ordnance).—Cont'd**

- Gas deflector tests. **215, 123.**  
The German 45 cal. naval railway gun.  
**218, 583.**

**Mounts and gear**

- Christie gun mount. **215, 123.**

**H**

- Haiti. "Unjustifiable homicides" in  
Haiti. **216, 267.**  
Hara, Takashi (Japanese premier). As-  
sassination of. **226, 1991.**  
Harding, Gamaliel. Statement of foreign  
policy, Mar. 4, 1921. **218, 633.**  
Hawkesworth, Alan S.  
New ballistic corrections. **222, 1232.**  
Underwater trajectories. **216, 207.**  
Heligoland. Heligoland and the war.  
**226, 1949.**  
Helium.  
Use of helium in airships. **224, 1650.**  
Uses of helium gas. **215, 110.**  
Henley, John D. Vroom, G. B. Place of  
naval officers in international affairs.  
**219, 685.**  
Hill, H. W. Tactical and fire concentra-  
tion problems and their solutions.  
**225, 1765.**  
Hinds, A. W. Lessons for the American  
navy from . . . Jutland. **226,**  
**1877.**  
History. Mayo, C. B. Study of history  
from naval officers. **225, 1755.**  
Hoffman, J. Ogden. Recruiting sales-  
manship. **220, 825.**  
Hog Island Shipbuilding Plant. Airplane  
view of. **218, 485.**  
Hunsaker, J. C. Aerodynamics. (Illus.)  
**224, 1519.**  
Hunter, Harold O'D. Practical test of  
radio compass shore stations. **217,**  
**363.**  
Hyde, M. D. The Old Navy. (Discus-  
sion.) **217, 393.**

**I**

- Immigration. Anglo-Saxon Union to  
bar Japanese. **216, 263.**  
Ingram, C. N. Radio communications  
from an operator's viewpoint. **222,**  
**1201.**  
Insane man, across the continent with.  
R. E. Coontz. **225, 1749.**  
International wireless conference, **1921.**  
Questions discussed. **224, 1661.**  
Iowa (U. S. S.). Bombing the radio-  
controlled Iowa. **221, 1112.**  
Ireland, David. Photo. **215, 1.**

**Irish question.**

- From a French point of view. **226,**  
**1943.**  
Ireland and the British Navy. **226,**  
**1952.**  
London conference, October, 1921.  
**226, 1985, 1987.**

**Italy.****History**

- Creighton, J. M. Europe since the  
Armistice. **221, 1037.**

**J**

- JL-12 (attack plane). Description.  
**226, 1972.**  
Jackson, R. H. Loyalty. **220, 877.**  
Japan.  
Japanese census returns, 1921. **218,**  
**635.**  
The poor of Japan and the Japanese  
government. **218, 595.**

**Foreign policy**

- Japanese foreign policy. **217, 454.**  
Premier Hara's defense of Japan  
**217, 420.**

**Foreign relations**

- An Anglo-Yanko-Japanese triangle  
**223, 1440.**  
Clearing Pacific war mists. **222, 1293.**  
Japan and the British alliance. (1921.)  
**223, 1439.**  
Japanese foreign policy and the Yap  
cable. **221, 1143.**  
Turco-Japanese relations. **220, 939.**  
U. S. protest regarding Yap as seen  
in Japan. **220, 942.**

**Naval policy**

- Japanese naval policy, 1921. **225,**  
**1812, 1848.**  
Japanese naval policy in 1921. **218,**  
**595.**

**Navy**

- Japanese navy scrapping old ships.  
(1921.) **224, 1631.**  
Program, 1921. **226, 1959.**  
Strength, 1921. **221, 1105.**  
Japanese in U. S. Statistics. (1921.)  
**222, 1313.**  
Jessop, E. P.  
Officers for shore duty only. **226,**  
**1885.**  
Soul of the service. **217, 351.**  
Jones, John Paul. Vroom, G. B. Place  
of naval officers in international  
affairs. **219, 685.**

- Jones, Wesley L. American shipping. 218, 606.
- Josten, Louis J. Manufacture of . . . rotating projectile bands. (Illus.) 215, 29.
- Jugoslavia. Alexander takes Jugoslav throne. 226, 1989.
- Jupiter (U. S. S. collier). Changed to aircraft carrier and renamed *Langley*. 217, 422.
- Jutland, battle of.  
Frost, H. H. Results and effects of the battle of Jutland. 223, 1327.  
Correspondence between Lt. Comdr. H. H. Frost, U. S. N., and German admirals, Scheer, and Hipper, and Comdr. Von Hase, regarding Jutland battle. 221, 1083.  
Hinds, A. W. Lessons for the American navy from . . . Jutland. 226, 1877.  
Re-enacting the battle for the movies. 223, 1438.

## K

- Kashima (Jap. battleship). Description. 221, 1105.
- Kearney, Lawrence. Vroom, G. B. Place of naval officers in international affairs. 219, 685.
- Kent, H. K. Fleet radio communication in war. 221, 1059.
- Kielhorn, L. V. Approximate altitude and azimuth. 223, 1387.
- King, Edward L. Overseas expeditions. 226, 1911.
- King, John. Photo. 215, 1.
- Kinkaid, T. C. Probability and accuracy of gun fire. 224, 1543.
- Kitchen rudder. Description. 226, 1979.
- Knapp, Harry S. An international outlook. 221, 1023.  
Onward and upward. 224, 1509.
- Koch, R. A. Promotion in the navy. (Discussion.) 218, 559.
- Krafft, Herman F. Sea power and American destiny. (Illus.) 218, 473.
- Krause, R. E. Morale for our "New Navy." 218, 519.
- Grout, Mary H. Perry's expedition to Japan. 216, 215.
- Kuporia Bay. Raided by Bolshevik destroyers, October, 1919. 203, 103.

## L

- Langdon, Warren J. Japan apologizes for killing of Langdon. 218, 635.  
Shooting of Lieut. Langdon. 217, 454.

- Langley (U. S. S.). The U. S. aircraft carrier *Langley*. 217, 422.

## Leadership.

- Carmine, C. C. Qualifications for leadership. 220, 857.
- Good, R. F. Leadership of men. 221, 1013.
- Parker, R. C. Leadership. (Foreword by Adm. H. B. Wilson.) 217, 323.
- Stickney, H. O. "Leadership," and the "Soul of the Service." (Discussion.) 219, 734.
- Upham, F. B. Leadership of men. 218, 487.
- White, R. D. "Leadership." 219, 655.

## League of Nations.

- Assembly organized at Geneva, 1920. 215, 144.  
Establishment of world court and work of the League. (Oct., 1921.) 225, 1849.  
The League and disarmament. 217, 444.  
The league's swaddling clothes. 215, 126.  
U. S. and the League. 225, 1849.
- Leary, H. F. Gunnery and turret design. 223, 1993.
- Leonardo da Vinci (Italian battleship).  
Guidoni, A. Salvage of the *Leonardo da Vinci*. (Illust.) 225, 1689.  
Illustration. 225, 1677.
- Lexington (U. S. S.). Illustration. 216, 157.
- Lion (H. M. S.). Flagship of Reserve Fleet. 226, 1954.
- Lighthouses. New lighthouses on South American coast. 226, 1981.
- Loans, international. Allies' debts. 217, 449.
- Logs. The Pitot tube log. 215, 123.
- Low, F. S. Fate of the dreadnought. (Discussion.) 218, 568.
- Loyalty. R. H. Jackson. 220, 877.

## M

- Machine guns. Heavy machine gun for battleplanes. 224, 1665.
- Mahan, Alfred T. A great naval philosopher. 215, 99.
- Majestic (S. S.). Description. 225, 1810.
- Mandates.  
American position on mandates. (1921.) 219, 792.  
The mandate terms. 219, 794.

**Maneuvers.**

- French post-war battle practice. **226**, 1945.  
 Japanese maneuvers, 1921. **225**, 1811.  
**Manierre, Chas. E.** Graphical solution of problems in nautical astronomy. **224**, 1593.

**Marine engineering.**

- Moore, W. L. Daily analysis of engineering performance. **221**, 1049.  
 Graphic calculation of speed of shafts. **222**, 1309.  
 Tendencies in marine oil engine practice. (1921.) **220**, 953.  
 The teachings of experience. **222**, 1304.  
 Uses of the sonoscope. **219**, 779.  
**Maritime law.** Faust, W. H. Bird's-eye view of admiralty law and practice. **226**, 1919.  
**Martens, Ludwig C. A.** Deported. **216**, 292.

**Maryland** (U. S. S.) Description. **223**, 1442.

**Massachusetts** (U. S. S.). Used as target by shore batteries. **218**, 623.

**Mayo, C. B.** Study of history for naval officers. **225**, 1755.

**McClellan, Edwin N.** Operations ashore in Dominican republic. **216**, 235.

**McClintic, W. S.** Engineering officer-personnel problem. **223**, 1355.

**McGuigan, J. L.** Amalgamation. (Discussion.) **219**, 731.

**McIntosh, Kenneth C.**

Amalgamation and specialists vs. corps. (Discussion.) **224**, 1605.

Psychology in the navy. (Discussion.) **217**, 393.

**Merchant marine.**

Dutch shipping combine. (1921.) **225**, 1846.

Labor question and the merchant marine. **215**, 103.

Status of merchant marine of greater nations, 1920. **219**, 754.

World's tonnage, 1921. **223**, 1450.

**France**

Future of French merchant marine. (1921.) **221**, 1091.

**Germany**

German maritime revival. (1921.) **222**, 1282.

**Great Britain**

Britain's great shipping companies. **219**, 749.

**Merchant marine.—Cont'd****Japan**

Japanese tonnage through Suez. 1920. **219**, 751.

Proposed Japanese ship mergers. **219**, 109.

**United States**

Jones, W. L. American shipping. **217**, 606.

American merchant marine, 1921. **217**, 269.

American shipping in 1921. **217**, 269.

Americanizing the U. S. merchant marine. **224**, 1638.

Inactive Government ships on James river. (1921.) **221**, 1109.

Rescuing our merchant fleet. (1921.) **222**, 1297.

Training our merchant marine personnel. **218**, 603.

U. S. seaman's strike of May-June, 1921. **220**, 947.

**Mercuric azide.** Description. **218**, 1109.

**Metric system.**

Metric system in Japan. **224**, 1638.

Saving the nation's cerebration. **217**, 281.

**Mexico.**

Exchanging educational facilities with Mexico. **218**, 602.

Foreign ships excluded from coast-trade. **226**, 1970.

Mexico back to normalcy. (1921.) **215**, 132.

Mexico's future. **216**, 286.

**Minelayers.** Minelaying vessels. (1921.) **225**, 1804.

**Montenegro.** Merged into Jugoslavia. **226**, 1989.

**Moore, W. L.** Daily analysis of engineering performance. **221**, 1049.

**Morale.**

Krause, R. E. Morale for our navy. **218**, 519.

Russell, C. F. Improving navy morale. **216**, 169.

**Moran, Cyril Godfrey.** Seapower in the Senate and the air. **225**, 1679.

**Morgan, James M.** A mystery of the seas. **220**, 909.

**Motorships.** Economy of the motor ship. **217**, 436.

**Movies.** Jutland battle reconstructed in the movies. **223**, 1438.

**Mystery of the Seas, A. J. M. Merg.** **220**, 909.

## N

- Nautical astronomy.** Manierre, C. E. Graphical solution of problems in nautical astronomy. **224**, 1593.
- Naval administration.**
- Pond, J. E. Relation of personnel to matériel. **221**, 991.
- Scammell, J. M. A combined (army and navy) staff. **224**, 1553.
- Naval architecture.**
- Leary, H. F. Gunnery and turret design. **223**, 1393.
- British and German warship design. **223**, 1433.
- Capital ship design. **223**, 1436.
- French cruiser design. **224**, 1612.
- German warship design. **224**, 1618.
- Making passenger vessels from obsolete destroyers. **215**, 106.
- Warship design and torpedo attack. **221**, 1091.
- Naval education.**
- Mayo, C. B. Study of history for naval officers. **225**, 1755.
- Sims, W. S. The practical naval officer. **218**, 525.
- Combined staff training in Great Britain. **222**, 1287.
- Naval history.** Scammell, J. M. Thucydides and seapower. **219**, 701.
- Naval officer and the civilian.** W. O. Stevens. **225**, 1725.
- Naval research and experiment.**
- Admiralty research. (1921.) **217**, 414.
- Naval experiments. **217**, 417.
- U. S. Naval experimental laboratory. (1921.) **215**, 115.
- Naval strategy.** The future of the battle fleet. **218**, 586.
- Naval tactics.**
- Hill, H. W. Tactical and fire control problems and their solution. **225**, 1765.
- Seymour, R. F. Conduct of a naval battle. **220**, 932.
- Stapler, John. A tactical awakening. **220**, 849.
- Navies.**
- Comparison of naval strength. **226**, 1964.
- Franco-Italian rivalry. **215**, 92.
- Minor navies, 1921. **215**, 135.
- Naval programs, 1921. **224**, 1634.
- Navigation.**
- Chase, J. V. New method of coastal navigation (Discussion.) **222**, 1271.

## Navigation.—Cont'd

- Collins, E. B. Position plotting by radio bearings. **216**, 201.
- Goodwin, H. B. New method in coastal navigation. **219**, 723.
- Todd, Forde A. Factor of safety in Navigation. **222**, 1221.
- Negato** (Jap. battleship). Illustration; description. **218**, 598.
- Nelson, Horatio.** Vroom, G. B. Place of naval officers in international affairs. **219**, 685.
- Nicaragua.** Desires to join Federal Council of Central American Republics. **222**, 1314.
- Nomograms.** Schuyler, G. L. Use of nomograms. **218**, 547.
- North German Lloyd S. S. Line.** New passenger service, Bremen to South America. **226**, 1950.

## O

- Oil.** Dutch oil, lubricant and irritant. **221**, 1136.
- Oil fields.** Alien ownership of American oil-fields. **216**, 294.
- Old Navy The.** J. K. Taussig. (Illus.) **215**, 1.
- Omaha** (U. S. S.). Illustration; description. **217**, 425.
- Overseas expeditions.** *See*: Expeditions overseas.

## P

- Palestine.** Placed under British mandate. **217**, 450.
- Panama.** The Panama-Costa Rican boundary. **220**, 974.
- Panama canal.**
- Free tolls voted. **226**, 1970.
- Tonnage through Panama, 1914-1920. **219**, 752.
- Parker, R. C.** Leadership (Forword by Admiral H. B. Wilson). **217**, 323.
- Pennsylvania** (U. S. S.). Illustration showing flag hoist. **221**, 991.
- Pericles' views on seapower.** Scammell, J. M. Thucydides and seapower. **219**, 701.
- Perry, Matthew C.**
- Krout, M. C. Perry's expedition to Japan. **216**, 215.
- Vroom, G. B. Place of naval officers in international affairs. **219**, 685.
- Petrograd.** Port approaches of Petrograd. **226**, 1981.

**Philippine islands.** Fiske, B. A. Relative importance of the Philippines and Guam. **225, 1676.**

**Potson gas.**

Are we ready for wholesale murder? **223, 1473.**

Chemical disarmament. **217, 442.**

German and British chemical industries and the war. **220, 930.**

War gases. **219, 781.**

**Poland.**

#### Navy

Polish Navy, 1921. **226, 1983.**

**Portugal.** Lisbon revolution, October, 1921. **226, 1988.**

**Pond, John E.** Relation of personnel to matériel. **221, 991.**

**Projectile bands.** Josten, L. J. Manufacture of rotating projectile bands. (Illus.) **215, 29.**

**Propellers, aerial.** Improved airplane propeller. **224, 1653.**

**Psychology.**

Gilmer, F. H. On psychology and the navy. (Discussion.) **220, 917.**

Psychology in the navy. **215, 77.**

McIntosh, K. C. Psychology in the navy. (Discussion.) **217, 393.**

Psychology and the Edison tests. **224, 1665.**

**Psychology and the naval officer.** **226, 1909.**

**Pumps.** Carey oil pump. **215, 124.**

**Purdy, Gilbert H.** Photo. **215, 1.**

#### Q

**Quest (ship).**

Purpose of the cruise of the *Quest*. **223, 1466.**

Voyage of the *Quest*. **225, 1840.**

#### R

**R-6 (U. S. submarine).** Sinks at San Pedro. **225, 1821.**

**R-38 (U. S. airship).**

Destruction of. **224, 1648.**

Report on *R-38* inquiry. **226, 1976.**

**Radio.**

Ingraham, C. N. Radio communications from an operator's viewpoint. **222, 1201.**

Kent, H. K. Fleet radio communication in war. **221, 1059.**

Sloane, C. A. Trans-Pacific Communication. (Discussion.) **222, 1274.**

Tisdale, M. S. Speeding up communications. **223, 1412.**

**Radio.—Cont'd**

German efficiency in radio tube work **224, 1660.**

Steering by wireless. **223, 1466.**

Transmitting photographs by radio **224, 1662.**

**Radiotelegraphy.**

Washington, Bowden. What is the matter with our navy's radio? **215, 21.**

Resonance coils for radio receiving **217, 442.**

Wireless in print. **219, 782.**

**Radium.**

Its rôle in industry. **216, 278.**

Radium in industry. **224, 1666.**

**Recruits and recruiting.**

Hoffman, J. O. Recruiting salesmanship. **220, 825.**

Taylor, J. S. Commanding officer, recruiting officer and medical officer. vs. desertion. **215, 39.**

**Reparations Commission.** Details of allied demands regarding German indemnity settlement. **220, 969.**

**Resistance of ships and depth of water.** **216, 271.**

**Rhone river.** Making the Rhone navigable. **222, 1281.**

**Roma (U. S. airship).** Erection under navy. **226, 1977.**

**Rudders.** Feats of Kitchen rudder. **226, 1979.**

**Russell, C. F.** Improving navy morale. **216, 169.**

**Russia.**

Soviet government offers to recognize Russian national debt. **226, 1989.**

#### Foreign affairs

Relations renewed with Germany **225, 1852.**

#### History

Creighton, J. M. Europe since the Armistice. **221, 1047.**

#### Navy

Russian navy in 1921. **225, 1846.**

Soviet navy, 1921. **226, 1983.**

**Rust, Armistead.** Slide rules for navigators. **218, 497.**

#### S

**S-48 (U. S. submarine).** Launched: description. **221, 1107.**

- alvage.  
 Guidoni, A. Salvage of the *Leonardo da Vinci*. (Illus.) 225, 1689.  
 Submarine salvage with magnets. 225, 1806.  
 Santo Domingo. McClellan, E. N. Operations ashore Dominican republic. 216, 235.  
 Scammell, J. M.  
 A Combined staff. 224, 1553.  
 Thucydides and seapower. 219, 701.  
 Scapa Flow. Von Reuter on the scuttling of the German fleet. 226, 1948.  
 Scher, Admiral Von. Forbidden to deliver address on Jutland. 224, 1622.  
 Schornstheimer, Graser. The super-navy: The U. S. Navy. 224, 1550.  
 Schuyler, G. L. Use of monograms. 218, 547.  
 Schuyler, Garrett L. Some sound phenomena connected with gun fire. 217, 345.  
 Scouts and scouting. Illustration of U. S. scout cruisers 4 to 13. (1921.) 220, 825.  
 Seabear (H. M. S.). Trials. 226, 1952.  
 Seapower.  
 Kraft, H. F. Seapower and American destiny. (Illus.) 218, 473.  
 Scammell, J. M. Thucydides and seapower. 219, 701.  
 Seapower: The Senate and the air. C. G. Moran. 225, 1676.  
 Seearles, P. J. Amalgamation as affecting the civil engineer corps. 226, 1869.  
 Sea scouting. Smith G. A. Sea scouting. 226, 1901.  
 Seymour, R. F. Conduct of a naval battle. 220, 932.  
 Shackleton, Sir Ernest. See *Quest* (ship).  
 Shafting. Thrust meters for marine shafting. 226, 1977.  
 Shenandoah (C. S. S.). Morgan, J. M. A Mystery of the seas. (Illus.) 220, 909.  
 Shipbuilding.  
 Belknap, R. R. Squantum, the victory plant. 216, 177.  
 British and American shipbuilding, 1920; a comparison. 215, 105.  
 Economic condition of British shipbuilding. (1921.) 225, 1809.  
 German shipbuilding progress. (1921.) 224, 1623.  
 Japanese shipbuilding industry in 1921. 220, 943.  
 Shipbuilding.—Cont'd  
 Lloyd's return of new construction. 1921. 226, 1958.  
 World's output, 1920. 217, 428.  
 World's shipbuilding decline, 1921. 217, 426.  
 Japan  
 Shipbuilding and iron manufacture in Japan. (1921.) 221, 1104.  
 Ships.  
 Sailing vessels as cargo carriers. 217, 445.  
 The modern cargo vessel. 219, 755.  
 Ships, concrete. Concrete ship construction without moulds. 224, 1625.  
 Concrete ships satisfactory. 216, 271.  
 Shore duty. Jessop, E. P. Officers for shore duty only. 226, 1885.  
 Silesia.  
 Germany wins plebescite. 219, 797.  
 Silesian question settled. 226, 1986.  
 Simplex salt detector. Description. 220, 956.  
 Sims, William S.  
 The Naval War College. 219, 705.  
 The practical naval officer. 218, 525.  
 Smith, G. A. Sea scouting. 226, 1901.  
 Smoke elimination. Eliminating smoke from steamers. 215, 114.  
 Sonoscope. Description. 219, 779.  
 Soul of the Service. E. P. Jessop. 217, 351.  
 Sound. Schuyler, G. L. Some sound phenomena connected with gun fire. 217, 345.  
 Spain.  
 Navy  
 Spanish navy in 1921. 225, 1844.  
 Spies. A British spy among the Bolsheviks. 219, 785.  
 Squantum, the victory plant. R. R. Belknap. 216, 177.  
 Stability of ships. Gyroscopic stabilizer. 225, 1806.  
 Stabilizers. Sperry Gyroscope Stabilizer. 223, 1473.  
 Stapler, John. Tactical awakening. 220, 849.  
 Stars, identification of. Green, J. F. Star identification by forecasting their position. 215, 67.  
 Steel testing. Magnetic testing of steel. 219, 778.  
 Steering. Allen, A. M. R. Good steering. 216, 187.  
 Steering by wireless. 223, 1466.



- Stevens, William O. Naval officer and the civilian. **225**, 1725.
- Stickney, H. O. "Leadership," and the "Soul of the Service." (Discussion.) **219**, 734.
- "Stool pigeons," sailors not to be used as. **225**, 1821.
- Submarine boats.
- Big gun submarines. **223**, 1437.
- British submarines of 1921. **220**, 926.
- Japanese super-submarines. (1921.) **225**, 1810.
- Submarine monitors. **224**, 1629.
- The ear of the submarine. (1921.) **223**, 1471.
- Supplement (Nov., 1921). **225**, 1676'.
- T**
- Tampa (U. S. C. G. cutter). Trials. **226**, 1961.
- Taussig, J. K.
- Our Navy personnel situation. **222**, 1153.
- The Old Navy. (Illus.) **215**, 1.
- Taylor, D. W. Naval aviation and a united air service. (Discussion.) **218**, 566.
- Taylor, J. S.
- Commanding officer, recruiting officer and medical officer, *vs.* desertion. **215**, 39.
- New wine in old bottles. **217**, 331.
- Promotion in the navy. (Discussion.) **216**, 247.
- Tennessee (U. S. S.).
- Description. **215**, 100. Illustration. **222**, 1153.
- Thorpe, G. C. Origin of grog. **217**, 377.
- Thrust meters. **226**, 1977.
- Thucydides. Scammell, J. M. Thucydides and seapower. **219**, 701.
- Tisdale, M. S. Speeding up communications. **223**, 1413.
- Todd, Forde A. Factor of safety in navigation. **222**, 1221.
- Torpedoes.
- New torpedo to run without wake. **224**, 1664.
- "Trackless" torpedoes. **225**, 1799.
- See also:* air torpedoes.
- Torpedoplane.
- Gunnery and torpedo planing. **220**, 966.
- Illustration of torpedo plane dropping torpedo. **217**, 307.
- The Martin torpedoplane. **215**, 113.
- Who invented the torpedoplane? **220**, 967.
- Treaties.
- French treaty with Turkey, 1921. **220**, 1990.
- German-American treaty ratified. **225**, 1851.
- Proposed treaty between U. S. and Mexico. **221**, 1144.
- Ratification of treaty between Colombia and U. S. (1921.) **220**, 926.
- U. S. Senate ratifies treaty of peace with Germany. **226**, 1988.
- U. S. treaty of peace with Germany (1921.) **224**, 1666.
- Turrets.
- Leary, H. F. Gunnery and turret sign. **223**, 1393.
- Operation of heavy armored turret. **220**, 965.
- U**
- Upham, F. B. Leadership of men. **218**, 487.
- United States
- Foreign policy**
- Getting together with Great Britain. **222**, 1290.
- Harding's inaugural statement of foreign policy. **218**, 633.
- Foreign relations**
- Knapp, H. S. An international outlook. **221**, 1023.
- America and the Anglo-Japanese alliance. **221**, 1099.
- Anglo-American naval agreement. **220**, 929.
- Diplomatic correspondence in Yap. (1921.) **220**, 972.
- If America and Japan went to war—Japanese view. **215**, 107.
- Panama note, March, 1921. **219**, 701.
- Naval administration**
- Pond, J. E. Relation of personnel and matériel. **220**, 991.
- Naval policy**
- Frothingham, T. G. Strategy of the World War and the lessons of the effort of the U. S. **219**, 669.
- Moran, C. G. Seapower: The Sea and the air. **225**, 1676'.
- Our deplorable position in the West Pacific. **225**, 1817.
- U. S. Pacific concentration. **223**, 1447.

## ited States.—Cont'd

## Naval War College.

Sims, W. S. The Naval War College. **219**, 705.

## S. Naval Institute.

Constitution and by-laws amended. October, 1920. **215**, 81.

Minutes of annual meeting, 1921. **226**, 1933.

S. Naval Radio Service. Washington, Bowden. What is the matter with our navy's radio? **215**, 21.

## S. Navy.

Schornstheimer, Graser. The super-navy; the U. S. Navy. **224**, 1559.

Vessels building, October, 1921. **226**, 1962.

## Discipline

Belknap, R. R. A captain to his crew. **226**, 1857.

Jessop, E. P. Soul of the service. **217**, 351.

## Personnel

Blasdel, F. G. Solution of the officer personnel situation. **225**, 1779.

Goss, N. H. Amalgamation. **216**, 231.

Jessop, E. P. Officers for shore duty only. **226**, 1885.

Knapp, H. S. Onward and upward. **224**, 1509.

McClintic, W. S. The engineering officer personnel problem. **223**, 1355.

McGuigan, J. L. Amalgamation. (Discussion.) **219**, 731.

Searles, P. J. Amalgamation as affecting the civil engineer corps. **226**, 1809.

Stevens, W. O. Naval officer and the civilian. **225**, 1725.

Taussig, J. K. Our navy personnel situation. **222**, 1153.

## Promotion and Pay

Barker, W. C., Jr. Promotion in the navy. (Discussion.) **215**, 20.

## U. S. Navy.—Cont'd

Blasdel, F. G. Solution of the officer personnel situation. **225**, 1779.

Bryan, C. A. Promotion in the navy. **222**, 1251.

Foote, P. W. Promotion in the navy. (Discussion.) **215**, 17.

Koch, R. A. Promotion in the navy. (Discussion.) **218**, 559.

Taylor, J. S. New wine in old bottles. **217**, 331.

Promotion in the navy. (Discussion.) **216**, 247.

Vossler, F. A. L. Promotion in the navy. (Discussion.) **215**, 7.

## Traditions and Customs

Taussig, J. K. The Old Navy. (Illus.) **215**, 1.

U. S. navy yards, stations and bases. Pacific fleet bases. **226**, 1963.

## U. S. Shipping Board.

Bareboat charter plan. **225**, 1822.

Shrinkage of assets. **226**, 1971.

U. S. Weather Bureau. Its aid to mariners. **223**, 1467.

## V

Van de Carr, J. C. T=C—W. (Course correction.) **225**, 1763.

## W

World's navies. See: Navies.

## Y

## Yap.

Allen, B. C. Yap. (Illus.) **225**, 1741.

Japan and the retention of Yap. **218**, 630.

ZR-2 (U. S. airship). Bending strength of the ZR-2. **225**, 1825.

Illustration. **225**, 1718.

Largest airship; description. **223**, 1463.

Lessons of the ZR-2 disaster. **225**, 1830, 1842.

## Z

Ziegler, S. J., Jr. Specialization vs. Amalgamation. **221**, 1073.



# Keds



**M**ATCH your "whites" with Keds, the superior canvas rubber-soled shoes. Cool and comfortable, neat and durable, Keds are the ideal summer and tropical footwear for men of the Navy.

**United States Rubber Company**

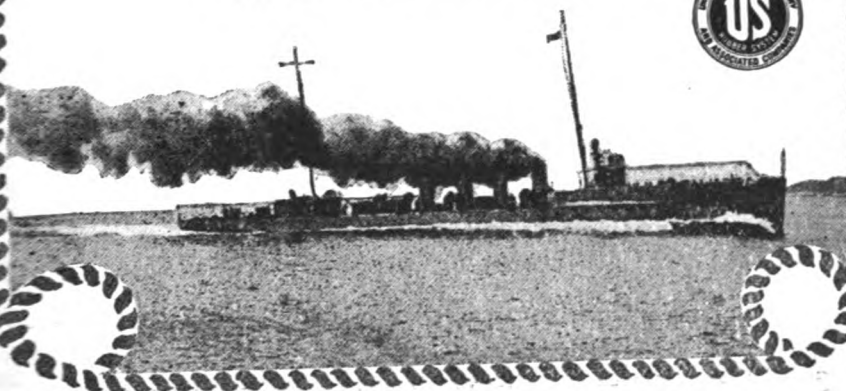

Please mention the PROCEEDINGS when writing advertisers

Google

**U. S. NAVAL INSTITUTE  
PROCEEDINGS  
Number 225**











This book should be returned to the Library on or before the last date stamped below.

A fine of five cents a day is incurred by retaining it beyond the specified time.

Please return promptly.

AUG 27 1928

DUE SEP 27 1928

~~MAY 21 1936~~

~~DUE APR -8 '37~~

DUE MAY 15 '44

NOV 17 '67 H

**CANCELLED**  
17-350

Widener Library



3 2044 094 013 844