

GEOCENTRICITY: CHRISTIANITY IN THE WOODSHED

by

Gerardus D. Bouw, Ph.D.

The Association for Biblical Astronomy
Cleveland, Ohio

GEOCENTRICITY: CHRISTIANITY IN THE WOODSHED

by

Gerardus D. Bouw, Ph.D.

The Association for Biblical Astronomy
Cleveland, Ohio

© Copyright 2013 by Gerardus D. Bouw
All rights reserved

ISBN: 9781890120900

Library of Congress Catalog Number: 2013943867

Unless otherwise noted, all Bible quotations in this book are from the Authorized Version of *Holy Bible*, commonly called the King James Version. Any deviation therefrom is purely accidental.

Printed in the United States of America

Publisher:

Daystar Publishing
P.O. Box 464
Miamitown, Ohio 45041
U.S.A.

Daystarpublishing@yahoo.com

<http://geocentricity.com>

TABLE OF CONTENTS

<i>Preface</i>	i
Chapter 1: Introduction	1
Chapter 2: The Importance of Geocentricity	8
Chapter 3: The Bible and the Flat Earth	16
Chapter 4: The Motions of the World	35
Chapter 5: The Motions of the Earth	43
Chapter 6: The Biblical Firmament	52
Chapter 7: The Sun To Rule by Day	90
Chapter 8: Joshua's Long Day	110
Chapter 9: Hezekiah's Sign	146
Chapter 10: Christological Sun Passages	161
Chapter 11: Sunrise and Sunset	168
Chapter 12: The Throne	180
Chapter 13: Up and Down	203
Chapter 14: Alleged Heliocentric Verses	210
Chapter 15: Sweet Influences	215
Chapter 16: Mazzaroth	226
Chapter 17: The Ordinances of Heaven	233
Chapter 18: He Hangeth the Earth Upon Nothing	239
Chapter 19: Early Geocentric Models	243
Chapter 20: The Birth of Heliocentrism	253

TABLE OF CONTENTS (Continued)

Chapter 21: <i>The Reformation and Heliocentrism</i>	270
Chapter 22: <i>The Early Copernicans</i>	288
Chapter 23: <i>Heliocentrism Takes Over</i>	315
Chapter 24: <i>The Restoration of Astronomy Project</i>	327
Chapter 25: <i>Geocentrists From 1650 to 1950</i>	348
Chapter 26: <i>Newton and Berkeley</i>	398
Chapter 27: <i>Force-Based Proofs of the Newtonians</i>	414
Chapter 28: <i>Proofs Based on Centrifugal Force</i>	419
Chapter 29: <i>Proofs Based on the Coriolis Force</i>	431
Chapter 30: <i>Introduction to Optical Proofs</i>	440
Chapter 31: <i>Aberration</i>	448
Chapter 32: <i>Aberration—Airy's Failure</i>	455
Chapter 33: <i>Aberration—The Gospel of Relativity</i>	466
Chapter 34: <i>Aberration—The Michelson-Morley Experiment</i>	495
Chapter 35: <i>Rotation</i>	521
Chapter 36: <i>Lesser Evidences</i>	533
Chapter 37: <i>The Axis of Evil</i>	557
Chapter 38: <i>Modern Geocentrists</i>	570
Chapter 39: <i>Geocentrists and Their Critics</i>	652
Chapter 40: <i>In the Woodshed</i>	677

TABLE OF CONTENTS (Continued)

Appendix A: <i>On the Hebrew Word, "Mowt"</i>	683
Appendix B: <i>Sunrise/Sunset Passages</i>	689
Appendix C: <i>All Significant Geocentric Scriptures</i>	690
Appendix D: <i>"The Sun Does Move" by James Jasper</i>	719
Appendix E: <i>Derivation of the Geocentric Equations for a Daily-Rotating Universe</i>	740
<i>Chapter Notes</i>	748
<i>Scripture Index</i>	776
<i>General Index</i>	780

DEDICATION

This book would not have been possible without literally hundreds of people who have encouraged its publication. Among those who are no longer with us is Walter van der Kamp whose insight into Scripture spawned the modern geocentric movement. Walter laid a solid philosophical foundation for geocentricity and founded the Tychonian Society, from whose newsletter the *theory of geocentricity* was born. Then, too, there is the late Walter Lang, who, at the encouragement of James Hanson, gave Walter van der Kamp the forum he needed to promote the Tychonian Society.

Special thanks go to Professor and mathematician James Hanson, whose friendship not only led me to a career but also continues to be a trustworthy mathematical sounding board. Others who have assisted in various way include: John Byl, Ph.D. (Astronomy) who has provided valuable critiques of the Theory of Geocentricity; Martin Selbrede, who contributed his valuable insights into modern cosmological thinking; Gordon Bane, who provided past financial support and encouragement which truly gave the *theory of geocentricity* global exposure; Frank Wolff, Ph.D. who helped to complete the book and get it printed and published; and also Floyd Jones for proofing the book "with a fine-toothed comb."

I would be greatly amiss if I did not thank Beth, my wife of more than thirty years for her patience and moral support, particularly over the last seven years when most of my focus was on completing the book. She also did the early proofreadings of the book.

Lastly, but certainly not least, I thank my Lord Jesus, and his Father and mine, and the Holy Ghost for the grace freely given unto me, and for the many wonderful things that they created that I have seen and have yet to see. Thank you for the riches that are mine in Christ Jesus, even eternal life. May the things that are incorrect in this book be soon forgotten so that only truth remains.

Beware lest any man spoil you through philosophy and vain deceit, after the tradition of men, after the rudiments of the world, and not after Christ.

—Colossians 2:8

PREFACE

Time was not that long ago that most houses had a woodshed to house seasoned firewood for the winter. But the woodshed served a couple of other purposes besides storing firewood. Being well separated from the house, the woodshed offered some privacy to boys and girls wanting a private location to do something naughty or forbidden. If you wanted to smoke, you could bum a cigarette and matches and go behind the woodshed to light up. The woodshed was a place of naughtiness, but it was also a place of punishment. Inside the woodshed it was usually the father who applied the *board of education to the seat of learning*.

Now don't misunderstand me. It is not my role to administer any punishment; that is our Father's responsibility. In the entire New Testament there is not any mention, or even the suggestion, that Bible believers are to execute anyone for any sin. The greatest punishments we can inflict are ostracism and turning someone over to Satan that he may learn not to blaspheme. Even heresy is to be punished by excommunication, not execution. So my role in this book is to explain why Christianity is today near death and how she earned that fate. Mine is a call to repentance, to admonish all who may be convicted by this book to turn to the Lord Jesus Christ, whose Scripture has been banished from nearly every local church that claims his name. Whether you believe me or not is of no credit to me. I'm just the messenger exposing what Christianity did in secret behind the woodshed some four centuries ago.

The Reformation of the sixteenth century was a time when men chose to subject the traditions of churches and men to the

norms of Scripture. God's words were to overrule men's. The Reformation set men free through the truth of Scripture and set men at liberty, the liberty that can only be found under grace.

But it was also a time when the newfound freedom of thought allowed the religion of humanism to break free from the confines of the Church of Rome. Humanism (not to be confused with humanitarianism) is a religion that sets man over God and self above mankind. Marxism, Socialism, and Communism are prime examples of the humanist religion in bloom.

Since the vast majority of people prefer fiction to fact, humanism has always promoted itself and conquered through lies, as opposed to Scripture which commands all to walk in the Truth.

The lie that the humanists devised to promote their god over the God of the Holy Bible was subtle enough to deceive all the world's religions, including today's Fundamentalist scholars, since its inception. The lie started to work early in the sixteenth century when a Polish cleric, Nicolas Copernicus, discovered that a third century B.C. Greek philosopher names Aristarchus of Samos proposed that the earth was not at rest at the center of the universe but that, instead, the sun was located at the center of the universe. His model was called "the heliocentric system" because it placed the sun god *Helios* at the center. Heliocentrism went nowhere; the geocentric universe, which had been held as fact since the creation, remained unscathed by its heliocentric rival.

Copernicus, however, saw in Aristarchus' supposition the downfall of Scripture, and, knowing that his idea was heretical to Christianity, sought an occasion to publish it without endangering or inconveniencing his life with the Church of Rome. Copernicus did so when he knew his death was imminent in 1543.

The Copernicans' assault on Scripture did not attack any doctrine considered vital to Christianity. Instead, it focused on a doctrine that most Christians would consider disposable; the fixity of the earth. In those days everyone recognized that Scripture teaches that the earth neither rotates on an axis nor orbits the sun once a year. The Humanist Copernicus, the Protestant Kepler, and the Roman Catholic Galileo all promoted heliocentrism. All deflected

Bible-based objections to the heliocentric model by claiming: "Scripture teaches us how to go to heaven, not how the heavens go."

Galileo fell afoul of the Church of Rome by demanding that she adopt the heliocentric model as a proven fact. Rome refused on the grounds that all the evidence, as well as Scripture, still favored the geocentric universe. Indeed, there was no evidence at all for the heliocentric model. Although the Catholic Church reprimanded Galileo for his arrogance in dictating what she *must* do, the Pope gave him a nice villa and a comfortable pension for life. Even after Galileo was called before the Inquisition a second time for insulting the Pope and breaking the promise he made after the first inquisition, Galileo's pension and villa were not taken away. Today, no one believes the model Galileo insisted upon that the Church of Rome must adopt—that the sun is at the center of the universe—but in 1991 the Pope apologized to Galileo for persecuting him.

By 1650, without any scientific evidence to support it, the heliocentric heresy had won the hearts of the learned men. Scripture was no longer an authority in physical matters (the "how the heavens go" in the above quote) and the assault against Scripture's authority in every other field of knowledge (the "how to go to heaven" part of the quote) was being questioned. Today, Scripture is no longer an authority on anything among the learned men.

In the early eighteenth century the founding of higher criticism of the Bible came to fruition with a French humanist named Jean Astruc. (It is called "higher criticism" because it sounds more authoritative, more impressive than "criticism" by itself.) Higher criticism was the direct result of the Copernican Revolution's attack on the Bible. Having cast doubt on the infallibility of Scripture in the sciences by discrediting the doctrine of the stability of the earth, the attack thus moved to combat the credibility of Scripture upon all areas it touches.

The Copernican Revolution had changed the concept of revolution forever. It had created a cause to rally the humanists as well as other haters of God against the Bible and his God. The Coper-

nican Revolution had done so by removing the earth from its special place, at rest in the midst of heaven, and reduced it to the status of a planet: a wandering star (Jude 13). You see, before the Copernican Revolution, the earth was not considered a planet; it was the hub of creation, which meant that trying to move it was like trying to move the entire universe. Furthermore, if people actually believed that the earth was an insignificant planet orbiting a below-average star, as we are taught today, then mankind, too, could easily be stripped of its God-given liberty, the Holy Bible (the word *liberty* means "by the book," that is, God's book; think "lib" as in library). With that liberty gone, man is left with hopeless despair, having the right questions but no answers (existentialism).

The French Revolution was a direct result of Copernicanism. Although it had been encouraged, in part, by the American Revolution there was one huge difference. The French revolutions were all based on humanism (socialism in particular), whereas the American Revolution was republican in nature and was based on certain scriptural principles. With the French Revolution the authority of the European Reformation Bibles was pretty well gone. Only Britain and America still held the Bible in esteem.

Britain's downfall started in the early 1800s with Charles Lyell, and English lawyer and member of the London Geological Society. Lyell wanted to gain power by fomenting a revolution in England just like the French Revolution and based on the same humanistic principles. In order to do that he had to depose the monarchy and thought his best chance for that was to rid England of its Bible. He decided to attack the evidence supporting a worldwide flood, that is Noah's flood. In his three-volume book, *The Principles of Geology*, Lyell put forth what he knew was a lie, namely, that the present is the key to the past. This is called the "Uniformitarian principle" meaning that noticeable changes will take a very, very long time. The uniformitarian principle is the foundation of all evolutionary speculations. It claims that great catastrophic events covering significant portions of the globe are impossible. In short, evolution is based on another humanist lie.

Charles Darwin applied Lyell's uniformitarian principle to zoology. Darwin confessed that without the Copernican Revolution his speculations would never have seen the light of day. The German Karl Marx applied Darwin's principles to politics and economics. He, too, acknowledged his indebtedness to the Copernican Revolution.

The Austrian Friedrich Nietzsche noted that evolution means that people are evolving to a super man. Hitler, in *Mein Kampf* expanded that to a super race. At the same time the eugenics programs of Margaret Sanger, founder of Planned Parenthood, implemented steps to eradicate the Negroid race.

These are the consequences of the Copernican Revolution. But what of the scientific evidence? After all, we are taught that heliocentrism has been proven.

While the aforementioned events were happening in the nineteenth century, there were troubling experiments being conducted in the field of physics. Some circumstantial phenomena tending to support heliocentrism were discovered in the eighteenth and nineteenth centuries, but starting in the early nineteenth century three experiments were performed that were designed to directly measure the speed of the earth through space.

The first experiment was Arago's starlight experiment which failed to show earth's motion around the sun. The second experiment was related to Arago's, but on a grander scale, and was conducted by Britain's Astronomer Royal, George Airy. It, too, measured a speed of zero. The third experiment is called the "Michelson-Morley experiment." It, too, measured a speed of zero.

For eighty-six years, physicists tried various explanations that would allow the heliocentric model to be true while all the evidence says it is false. Physicists finally settled on Einstein's theory of Relativity as the way to keep the earth moving while making it look as if it stands still. What Einstein did was radical. He invented a geometry that allows every thing in the universe to respond to experiments as if it alone is located, immobile, at the center of the universe. The result is that there is no way to scientifi-

cally determine whether the earth is rotating or orbiting the sun. Physics has thus failed to disprove Scripture when it states that the earth is unmovable. Indeed, the insistence of Scripture that the creation is geocentric plus the fundamental experimental results confirming Scripture led Albert Einstein to invent an absurdity so great that he could legitimately claim that he was himself located immobile at the center of creation. Furthermore, it is impossible to falsify Einstein's relativity. Yet, despite all the evidence, Christian scientists still refuse to accept Scripture over humanism's counterfeit science.

To go back to Christianity in the woodshed: it is now clear that the rejection of the scriptural doctrine of the stability of the earth was a needless objection. We also see that the fruit of the Copernican Revolution brought great turmoil, pain, suffering and death to the world. All of this will fall on those who add, subtract, or change the words of God as recorded in his Holy Bible. This is so stated in Revelation 22:18-19.* It is addressed to Christians, both true and counterfeit, who tamper with God's words. On them the wrath of God will fall most heavily for they should have known better.

Consider their effect on professing Christians since 1870. The churches and their members still profess faith in the word of God, the Holy Bible. But these days such a profession means absolutely nothing. There are more than 230 different bible versions in circulation in the United States; not one of them professes to be Scripture given by inspiration of God. Which one is truly the word of God? "Pick the one you prefer or like the most," is the typical answer to that question.

The problem is that, in America, the Bible was kicked out of almost every facet of life. It was kicked out of our economy in

* Revelation 22:18-19—¹⁸ For I testify unto every man that heareth the words of the prophecy of this book, If any man shall add unto these things, God shall add unto him the plagues that are written in this book: ¹⁹ And if any man shall take away from the words of the book of this prophecy, God shall take away his part out of the book of life, and out of the holy city, and *from* the things which are written in this book.

1913 resulting in the establishment of the Federal Reserve. America's entertainment industry never had any respect for Scripture. The Ten Commandments were kicked out of our legal system by 1958 for fear that our children might read them and obey them. Our government rid itself the Bible in 1962, and our schools told God to "Get lost" in 1963.

But before God was eliminated from those listed institutions, God's word, The Holy Bible, was expelled from this nation's churches. That happened in 1901, when with much fanfare and acceptance, even among the laity, the *American Standard Version* was introduced to replace the so-called "obsolete, most inaccurate, archaic" *Authorized Version* commonly called "The King James Version."

How all these things came about is the subject of this book. It documents how humanists (which are characterized by their claim of superiority over God and everyone else) tricked the churches, their clergy, and their members into abandoning the authority of Scripture in the natural realm. This was accomplished by convincing Bible-believing Christians that some doctrines are essential and others are not. Once that was accepted by the believers, they were ready to abandon what was claimed to be a minor doctrine of Scripture. Even today, either said doctrine is regarded as a minor doctrine or dismissed as not a doctrine at all.

There was a time when Bible believers understood that no doctrine in Scripture is minor. The idea that some doctrines are more important than others is the foundation of Fundamentalism. Fundamentalism was founded on the proposition that conservative churches of different denominations, working together, could defeat liberalism by banding together to defend the alleged "essential" doctrines. It is no wonder that Fundamentalism had absolutely no effect on the growth of liberalism; on the contrary, liberalism infected Fundamentalism with the anti-biblical notion that only the original autographs *are* (were) inspired. Since we don't have them, there is no authoritative word of God. Truth is, without the originals you wouldn't recognize them if you could reconstruct

them. All these are the fruit of rejecting the “disposable” doctrine, the doctrine of the immobility of the earth, namely, *Geocentricity*.

In this book we will show that the churches were fooled, mistaken in rejecting the geocentric doctrine, that every fundamental experiment ever conducted to measure the speed of the earth through space has always returned a speed of zero. We will also present evidence that the earth is near, if not at, the center of the cosmos; and that the cosmos even knows this to be true. We also explore the firmament and the role it plays in keeping the earth still in the cosmos.

This book is written for you who are truly born-again believers. If you love sound Bible doctrine, this book is for you; it will edify you and strengthen your faith. If you have ever wondered about the foundation of God’s creation or had an interest in cosmology or cosmogony, this book is for you. If you’ve wondered why God created us, this book is for you. And for those of you mature in the faith who, in the Laodicean church, find no room except to stand outside with Jesus knocking on its door, this book is definitely for you.

Finally, some things herein are hard to understand. Over the past years and editions I have bathed it with much prayer, but that does not help your faith or understanding, dear reader. I thus leave you with this prayer:

Gracious Lord and Father, I ask for the sake of the words and blood of Jesus that thou wouldst grant a special blessing and grace to all who read this book. I ask a special blessing so that they may read with a mind full of peace, edifying their souls; and I ask for grace that by thy grace the eyes of their understanding may be opened and that their hearts may be drawn closer to thee. And if there be any glory, it is thine, O Lord. Amen.

Mantua, 31 January 2013

Accommodation: the supposition which claims that God goes along with the commonly accepted story even though he really doesn't believe it.

— Pastor David Robinson

1

INTRODUCTION

Four hundred years ago there raged a debate among the learned men of Europe about whether or not the earth orbits the sun. Until then, it was commonly accepted that the sun, moon, stars, and planets were embedded in crystalline spheres centered on the earth. In the debate, the Biblicists held that the sun goes around the earth once a day as well as revolving about it once a year. The secularists maintained that the earth daily rotates on an axis and orbits the sun once a year. This Biblicist view, originally called *Geocentrism*, believed that the earth is at the center of the universe; the humanist view, called *Heliocentrism*, believed the sun to be at the center of the universe. Although to this day the historical, sun-centered heliocentric view is taught as correct, no one believes it today. Instead, today's science claims that there is no center to the universe or that the center of the universe is everywhere. The no-center belief is called *Acentrism*; the center-is-everywhere view is properly called *Pancentrism*.

When geocentrism (the idea that the earth is stationary at the center of the universe) was finally pronounced dead, humanists triumphantly declared their victory signified the death of the Bible and Christianity. However, the victory was not total, for there have always been supporters of geocentrism until this very day. Among the most famous and capable of the early geocentric defenders are Tycho Brahe and three generations of the Parisian astronomers, Cassini.

In the latter half of the twentieth century, geocentrism resurfaced in a new, far more technical form called *Geocentricity*. Among its advocates and supporters, one finds several with earned Ph.D.s in astronomy, mathematics, and physics. Currently, three worldwide organizations serve the geocentric community. All three are mathematically sophisticated and have Ph.D.s on their boards, if not as directors. The oldest is the Tychonian Society, now called the Association for Biblical Astronomy (ABA). It is under the directorship of Gerardus D. Bouw, who has an earned Ph.D. in astronomy. The Association's geocentric stance is based entirely on Scripture although it can argue on evidence and scientific grounds, too. On the heels of the Tychonian Society came the *Cercle Scientifique et Historique* (CESHE) which maintains offices in Belgium and France. Its chairman is Yves Nourissat. The two groups differ on whether the earth rotates on its axis and the size of the universe. CESHE believes that the earth rotates and that the universe is small; the ABA believes that the earth does not rotate and that the universe can be as large as modern science believes it to be. CESHE is devoutly Roman Catholic and was organized to promote the works of Fr. Fernand Crombette. The third global geocentric organization is *Galileo Was Wrong*. Founded and directed by Robert Sungenis, Ph.D., the organization is Catholic and founds itself on the teachings of the Abbess Hildegard von Bingen (1098-1179).

Now the typical reader may be puzzled by the resurgence of an old, "long-dead" idea. After all, has science not proven that the earth rotates on its axis once a day and orbits the sun once a year? Why bring up something that was disproved centuries ago? The scriptural argument against Scripture's geocentric view is one of accommodation; but that makes a liar of God as noted in our chapter quote by Pastor David Robertson:

Accommodation is the supposition which claims that God goes along with the commonly accepted story even though he really doesn't believe it.

At issue is the authority, infallibility, and preservation of Holy Scripture, especially in the light of the pronouncements of science to the contrary. At stake is the authority of the Bible in all realms it touches on: on science, history, politics, law, and government, on morality, truth, the way, and life. The abandonment of the authority of Scripture in the minds of men by the supposed victory of science over the geocentric view of Scripture directly led to the decline of Western civilization that we are now experiencing.

So, is geocentricity the anti-scientific myth that its opponents claim? Is it actually a throwback to the flat earth? Is it the case, as one creationist claims, that geocentrists are heretics teaching an end-time heresy? Or is there something to geocentricity, after all? The truth is that every fundamental experiment ever devised to measure the speed of the earth through space measures a speed of zero. Furthermore, there is no difference between the equations describing the causes and motions of the geocentric universe and those describing the causes and motions in the modern heliocentric universe. (This should be obvious to the reader, for both heliocentric and geocentric theories have to explain the same behavior, namely, the behavior our senses and instruments see.) The modern heliocentric theory acknowledges the geocentric equation (called the *kinematic* equation) as valid but claims that it is unphysical. To make the kinematic equation physical, all modern physics does is to multiply it by one. After multiplying the right-hand side of the "unphysical" kinematic equation by one, modern physics calls the "new" equation *dynamic* and claims that their multiplication by one has made a physical difference. In other words, the kinematic equation describes the motions of the sun, moon, and stars as they appear to our eyes, but after we multiply the equation's left-hand side by one, we now "see" the heliocentric "truth." (See Appendix E.) If the "geocentric" kinematic equation is fictitious, then so is heliocentrism dynamic equation. Likewise, if the Heliocentrist wants to charge geocentricity as unphysical, then for the same reason, the geocentrist can dismiss heliocentrism as an anti-scientific myth.

Yes, the so-called proofs for the rotation of the earth and its orbit around the sun are all due to the imagined difference between kinematic and dynamic physics. The "one," the "unity" by which either side of the kinematic equation is multiplied is m/m , where m is the mass. Clearly, the m 's cancel, and we are left with the kinematic model as the fundamental equation. What this all boils down to is that in both heliocentric and geocentric models the mass is irrelevant in describing the motions (accelerations) of the planets, but the mass *is* relevant in computing the gravitational or inertial forces.

From the birth of modern heliocentrism to this day, its driving principle, its episteme, has always been to remove God from his creation, to make him irrelevant. In order to keep the faith of this episteme, the ends justify the means, even if those means are stupid or insipid. As in politics, in the humanistic, atheistic science that Paul calls "Science falsely so called" in I Timothy 6:20, truth is the first fatality. Since truth is eternal and absolute, it will not stay dead. So the phony scientist must bury it under an avalanche of alleged proofs, of supposed evidence, of sophisticated arguments, and a mountain of bluster, threats, and name calling. And so it is to this day.

The more subtle physicists, many of whom know well that the geocentric evidence is overwhelming, will claim, with some justification, that we can neither prove nor disprove the geocentric universe; but that we likewise can neither prove nor disprove the non-geocentric universe either. The most sophisticated argument designed against the geocentric universe is the theory of relativity. Einstein's relativity theory makes every point in the universe look as if it is at rest at the center of the universe. The sophisticates can then argue that the geocentrists' argument is trivial since Mars could be at the center of the universe just as likely as earth.

The problem facing the relativists is that relativity was invented to keep the earth moving around the sun when every fundamental experiment showed it to be at rest in the universe. That evidence is so overwhelming that some physicists have concluded that physics *conspires* to make it look like the earth is fixed at the

dynamic center of the universe. A conspiracy on the part of physics? Not unless physics is a person and the only person with the power to be behind such a conspiracy is God. I find it easier to believe that there is no conspiracy; that physics merely reflects the true state of affairs of God's creation!

About the Book

In this book we document the development of these arguments designed to keep the earth in orbit about the sun, and the arguments against the rotation of the earth. We will also cover theories designed to explain away the geocentric system or, at least, to hide the fact that we are looking at a geocentric universe. The most famous of these theories is called Mach's Principle, which makes geocentricity as plausible as any other center. Along the way we will discover that the firmament is not synonymous with the universe but is a superdense medium that pervades all of space. It is the firmament that dictates the laws of physics, and it is the firmament that physically controls all motion. Such considerations constitute the substance of this book.

I mentioned the atheistic, humanistic scientists earlier, but not all opponents of the geocentric universe are atheists. For instance, the man who first proposed the physics-conspiracy theory to explain the physical evidence for geocentricity is a professing Bible believer. Their arguments, too, will be aired in this book. But until all the issues are aired out in the open, geocentrists will just have to stick to Acts 24:14:

But this I confess unto thee, that after the way which they call heresy, so worship I the God of my fathers, believing *all* things which are written in the law and in the prophets. [Emphasis added.]

I should also explain a point of style in my writings. I do not capitalize second- and third-person references to God. By not capitalizing them I run the risk of being accused of irreverence, for the practice of their capitalization is widely assumed reverential.

Nevertheless, I do not follow that convention for the following reasons: first, Scripture itself does not so do; second, capitalizing second and third person references to God starts a trend that eventually transposes the honor due God to other things, potentially leading to pantheism. For example, writing "God's House" spreads the honor due God alone to his house. Likewise, God's Word (or the Word of God) properly refers to the Lord Jesus Christ as the second person of the Trinity whereas God's word is the Holy Scriptures, consisting of the written words of God.

Lastly, a word about the figure naming convention used here. The numbering restarts with each chapter and within that chapter figures are referred to as Figure 1, Figure 2, etc. However, if the figure referred to is in another chapter, say Figure 2 in Chapter 20, for instance, then the reference will be to "Figure 20.2."

Assumptions

The purpose of this book is to teach the churches that they erred greatly in the seventeenth century when they transferred the authority of Scripture to science when it comes to dealing with the physical realm. In order to fulfill that purpose, I must hold God to much stricter and higher standards than do modern theologians. To that end, I list the assumptions I labor under when it comes to handling the Holy Bible. I assume that Scripture was written by and preserved by an omnipotent, omniscient, and omnipresent God. There are certain properties a book inspired by such a God should exhibit:

1. Scripture must be free of internal contradictions.
2. Scripture must be free of all logical paradoxes such as the liar's paradox.*

* E.g., in every modern version Titus 1:12 suffers from the liar's paradox when a Cretian says "Cretians are always liars." The paradox arises as follows: Paul says the Cretian speaks the truth, but if Cretians always lie, then the speaker, as a Cretian, must be lying. But if he is lying, then Cretians must always tell the truth and he, as a Cretian, must be telling the truth and so on round and round.

3. Scripture cannot have any historical errors.
4. Scripture cannot have any physical errors.
5. Scripture cannot contain any grammatical errors.
6. Scripture will always be written in a language especially designed to survive the corruption of the words in general use. In effect, inspired Scripture is cast in a sacred or theological language, easily learned by those who will bother to read it. As such, secular meanings of words should not be read back into the sacred text.
7. Scripture is not a product of evolution. By that I mean that there are no copyist or intentional errors in Scripture that are not immediately recognizable (e.g. typographic errors), nor are there any redactions altering the words of God.
8. The inspiration that gave the original autographs survives in subsequent copies and in translation. If this rule is violated, God cannot hold man responsible for doubting his word and disobeying it. This assumption requires that the standard Scripture must always be detectable at all times. Today, the standard Scripture, as proven by the fact that virtually every new version feels obligated to compare itself to it, is the *Authorized Version*.
9. When quoting a man, Scripture is only required to quote him accurately to maintain its inerrancy or infallibility. The content of such a quote, whether the truth or a lie, may thus violate the above rules without affecting the inerrancy of Scripture.

Only the Authorized Version avoids the paradox by saying "Cretians are always liars." Always is the accusative case, which exempts the accuser from the accusation.

THE IMPORTANCE OF GEOCENTRICITY

To hear tell, geocentrism—the ancient doctrine that the earth is fixed motionless at the center of the universe—died over four centuries ago in the face of an overwhelming avalanche of scientific evidence and proof. History, however, tells a different story. The “overwhelming” evidence was in favor of the geocentric theory, not against it.

In 1542 Nicolaus Copernicus, a Polish canon of the Roman Catholic Church, insisted that only the sun and not the earth was worthy to be at the center of the universe despite the clear teaching of Scripture to the contrary. Copernicus’ advocacy of *Heliocentrism*, as his model is called, was based entirely on Greek philosophy. Despite the insistent efforts of vociferous and enthusiastic Copernican supporters such as Johannes Kepler and Galileo Galilei, it took a hundred years for heliocentrism to become the dominant worldview; and it did so with all scientific evidence favoring the best geocentric model and no evidence favoring Copernicus’ model. Throughout the entire seventeenth century, the evidence overwhelmingly favored the geocentric model and denied the Copernican model. The modern claim that the heliocentric model overpowered the geocentric universe model with irrefutable evidence and proof is a myth, the first of many associated with heliocentrism.

The *Copernican Revolution*, as the shift from the geocentric to heliocentric universe is called, was not just a revolution in the field of astronomy, nor was it a revolution of good science overpower-

ing bad science and superstition. The real revolution was against Holy Scripture. If the earth rotates on its axis then the author of Scripture, even the Holy Ghost (II Peter 1:21⁶), verbally inspired a falsehood in Joshua 10:13⁷ when he wrote that "the sun stood still." Likewise, the Holy Ghost, when giving by inspiration the words, "He maketh his sun to rise..." in Matthew 5:45⁸ passed off another falsehood as the truth (John 14:17⁹). The reverberations of the Copernican Revolution still ring today, particularly in the realms of politics and theology; for without said revolution, there could be no higher criticism which assumes God is incapable of writing what he meant to say or meaning what he wrote. Without the Copernican Revolution there would be no Marxism in which the state replaces God. Nor could there be any evolutionism with its bigotry and racism and faith that man will eventually evolve to ultimately overpower God. After all, if God cannot be taken literally when he writes of the "rising of the sun," then how can he be taken literally in writing of the "rising of the Son?" (Malachi 4:2¹⁰) According to "science," both are equally impossible.

Prior to heliocentrism there was *geocentrism*, the ancient belief that the earth is located at rest in the center of the universe. Until well into the sixteenth century most people believed that the earth was immobile at the center of the universe; that was taken for granted to be both scriptural and natural. To question the immobility of the earth was to invite the charge of heresy. The earth was,

⁶ II Peter 1:21—For the prophecy came not in old time by the will of man: but holy men of God spake as they were moved by the Holy Ghost.

⁷ Joshua 10:13—And the sun stood still, and the moon stayed, until the people had avenged themselves upon their enemies. Is not this written in the book of Jasher? So the sun stood still in the midst of heaven, and hasted not to go down about a whole day.

⁸ Matthew 5:45—That ye may be the children of your Father which is in heaven: for he maketh his sun to rise on the evil and on the good, and sendeth rain on the just and on the unjust.

⁹ John 14:17—Even the Spirit of truth; whom the world cannot receive, because it seeth him not, neither knoweth him: but ye know him; for he dwelleth with you, and shall be in you.

¹⁰ But unto you that fear my name shall the Sun of righteousness arise with healing in his wings; and ye shall go forth, and grow up as calves of the stall.

after all, central in God's attention, central to his affection, and central to the purpose of creation. It was to the earth that Jesus Christ came. It was on earth that he died on the cross for the sins of man; and it was in earth that he was resurrected that man may have eternal life. It is on earth where happen those things which "the angels desire to look into" (I Peter 1:12^{*}). How logical, then, the idea that the earth is nestled unmoving at the center of all creation?

But the rise of *heliocentrism* in the sixteenth century changed all that. Gradually the heliocentric belief became the dominant faith so that today, except for considerations under the aegis of relativity or Mach's principle (two secular theories allowing the possibility of geocentricity because all appearances demand it), one is considered scientifically illiterate if one seriously questions heliocentrism at all. The truth is that modern science no longer believes the Copernican idea that the sun is at the center of the universe. Today's consensus has it that there is no center to the universe or, rather, that every place in the universe, whether the center of a supercluster of galaxies or a dizzily spinning proton, looks as if it is neither moving nor rotating at the center of the universe. The modern view is more properly termed either as *acentric* (without center) or more correctly, *pancentric* (with its center everywhere) instead of *heliocentric*. Likewise, the modern view corresponding to geocentrism, which placed the earth at the geometric center of the universe, now places earth at the *dynamic center* (also called the *center of mass*, the *center of gravity*, the *balancing point*, the *pivot point*, and the *barycenter*) of the universe. As a result, the modern form of geocentrism is properly called *Geocentricity*, not *geocentrism* or *geocentricism*. Geocentricity is the theory that earth neither rotates on its axis daily nor orbits the sun annually but is the center on which the rest of the universe turns. Geocentricity is the assurance that the *Bible* can be taken literally, not only when

* I Peter 1:12—Unto whom it was revealed, that not unto themselves, but unto us they did minister the things, which are now reported unto you by them that have preached the gospel unto you with the Holy Ghost sent down from heaven; which things the angels desire to look into.

it tells us “how to go to heaven,” but also when it tells us “how the heavens go”: Galileo to the contrary.

Scholarly Opinions on the Significance of Geocentricity

That the Bible is overtly geocentric has been noted by believer and unbeliever alike. Augustus De Morgan, one of the foremost mathematicians of the nineteenth century, wrote about the immobility of the earth as taught in the Bible:

The question of the earth's motion was the single point in which orthodoxy came into real contact with science. Many students of physics were suspected of magic, many of atheism: but, stupid as the mistake may have been, it was *bona fide* the magic or the atheism, not the physics, which was assailed. In the astronomical case it was the very doctrine, as doctrine, independently of consequences, which was the *corpus delicti*: and this because it contradicted the Bible. And so it did; for the stability of the earth is as clearly assumed from one end of the Old Testament to the other as the solidity of iron. Those who take the Bible to be *totidem verbis* dictated by the God of Truth can refuse to believe it; and they make strange reasons. They undertake, *a priori*, to settle Divine intentions. The Holy Spirit did not *mean* to teach natural philosophy; this they know beforehand; or else they infer it from finding out that the earth does move, and the Bible says it does not. Of course, ignorance apart, every word is truth, or the writer did not mean truth. But this puts the whole book on its trial: for we can never find out what the writer meant, unless we otherwise find out what is true. Those who like may, of course, declare for an inspiration over which they are to be viceroys; but common sense will either accept the verbal meaning or deny verbal inspiration.¹

Likewise, the twentieth-century atheistic philosopher, Bertrand Russell, recognized the crucial challenge which heliocen-

trism presented to the Bible's authority when he wrote of the Ten Commandments that their authority:

...rests upon the authority of the Bible, which can only be maintained intact if the Bible is accepted as a whole. When the Bible seems to say that the earth does not move, we must adhere to this statement in spite of the arguments of Galileo, since otherwise we shall be giving encouragement to murderers and all other kinds of malefactors. Although few would now accept this argument, it cannot be regarded as absurd, nor should those who acted upon it be viewed with moral reprobation.²

Several pages later, Russell writes about the demise of scriptural geocentricity concomitant with the demise of the Bible's authority among Christians. He notes that:

...inconvenient Bible texts were interpreted allegorically or figuratively.³

And still later he credits the Copernican Revolution with the demise of Christians themselves as authorities on matters scientific:

...in the period of time since Copernicus, whenever science and theology have disagreed, science has proved victorious.⁴

Besides philosophers and mathematicians, theologians also admit to the geocentric nature of the Holy Bible. Rabbi Louis Jacobs of London, for example, while writing of the scriptural model of the universe states, "the Biblical picture is clearly geocentric."⁵ In rare moments of candor, even Evangelical theologians will reflect on the problem of reconciling the geocentric nature of the Bible with the heliocentrism of modern science:

To illustrate what we mean by unconvincing hermeneutical procedures, we need only recall the way many conserva-

tives seek to harmonize the Bible with the Copernican view of the universe. When Copernicus first abandoned the geocentric model of the universe for a heliocentric one, the church was appalled. Church leaders appealed to Scripture, which compares the sun to “a strong man running a race whose circuit is from one end of heaven to the other” (Psalm 19:4 and 5^{*}) and which declares that the “world also is established that it cannot be moved” (Psalm 93:1[†]). From these and similar texts they conclude that the sun moves around the earth which remains fixed in its position. They were correct insofar as this is what the text of the Scripture says. Today, however, we can no longer accept this as a scientific description of what happens. Some conservatives, however, feel compelled to reconcile Scripture with reality. Normally they handle the problem by replying that the passages in the Psalms are poetry. But this hermeneutical observation is more erudite than helpful, for poetry is as clear in its meaning as prose. “The world also is established that it cannot be moved” can hardly be a poetic way of saying that the earth is spinning on its axis and gyrating through space in a path determined by the orbit of the sun. The meaning which the older interpreters gave the text is no doubt the meaning the author intended. To admit as much is simply to apply the fundamental hermeneutical canon of the grammatical-historical method.⁶

From these several quotations it is evident just what is the central issue in the heliocentric debate: at issue is the authority of the Holy Bible. Did God really write “true truth,” as Francis Schaeffer called it; or did God deceive for the sake of convenience so that his

^{*} Psalm 19:4-5—Their line is gone out through all the earth, and their words to the end of the world. In them hath he set a tabernacle for the sun, Which is as a bridegroom coming out of his chamber, and rejoiceth as a strong man to run a race.

[†] Psalm 93:1—The LORD reigneth, he is clothed with majesty; the LORD is clothed with strength, wherewith he hath girded himself: the world also is stablished, that it cannot be moved.

words would not appear too cryptic to the ancient mind? However, this begs the question of why God would make it cryptic for us instead of the ancients. Is the Bible clear in its teachings, or do we need scientific "experts" to advise us as to what "God really *meant* to say" but evidently did not have the wits to say properly, forthrightly, or plainly? And if God does write things that are not true in those passages which refer to the immobility of the earth, then how can man trust anything else God writes? How could we possibly know what God "meant" to say or what is true if he does not say what he means in the first place? Or is the heliocentric idea merely another version of Satan's ploy to deceive Eve as recorded in Genesis 3:1, where the devil casts doubt upon the veracity of God's word? And finally, is the evidence for heliocentrism really as overwhelming as the elementary textbooks make it seem? Science historian Thomas Kuhn includes the geocentric model in "these matters" when he writes that:

In the case of textbooks, at least, there are even good reasons why, in these matters, they should be systematically misleading.⁷

Starting in the early nineteenth century and increasingly through the twentieth and into the twenty-first centuries, there was an explosion of knowledge, unprecedented in history, in the light of which geocentrism has returned in a new form called *geocentricity*. The key distinction between geocentricity and geocentrism is this: geocentrism was, as the suffix *-ism* relates, a divisive idea; divisive in the sense that the model did not allow for a universe in which the parts were free to interact. From Aristotle and throughout the Dark Ages the geocentric model was a differentiated model, one in which the planets moved on crystalline spheres and where no astral body could leave its particular sphere and interact with its neighbors without shattering a sphere. Geocentricity, on the other hand, is an integrative model which ties the parts of the cosmos together into a holistic system. Thus, heliocentrism and pancertrism need additional hypotheses to explain cer-

tain celestial and physical phenomena, hypotheses that are not needed in geocentricity. This aspect of geocentricity we shall examine in the latter chapters of the book.

Conclusion

So why is geocentricity an important topic to Bible believers, both Jews and Christians?

1. If it is taught in Scripture, it must be important since there are no insignificant or disposable doctrines in Scripture. If there were, in the very act of writing about them God would waste not only our time but also his own.
2. It was on the issue of geocentricity that science challenged Scripture, and by backing down in the absence of any evidence—let alone proof—against the Holy Bible, believers crippled both the authority of Scripture as well as their own authority as keepers of the words of God in not only the eyes of the world, but even their own eyes. Geocentricity is still the only conflict between science and Scripture. Evolution is not science. That evolution is superstition and not scientific is confirmed by evolutionists' frenetic cries to ban all contrary evidence from the classrooms of the world.
3. Because geocentricity cannot ignore the existence of the universe in its theories, it presents an integrated and far more comprehensive view of the universe.
4. Even though the lack of geocentrists among astronomers caused the evidence for the heliocentric view to predominate for about one hundred-fifty years, later measurements and observations forced a return to the geocentric viewpoint. Unwilling to do that, secular science instead adopted the theory of relativity to keep the earth moving despite itself.

For a true Bible-believer, the first point should be enough. Nevertheless, we shall examine the issues in detail, starting with the assertion that geocentrists are throwbacks to believers in a flat earth.

THE BIBLE AND THE FLAT EARTH

The Bible is not a textbook on science. This slogan, so commonly quoted among the pancentric Christian intelligentsia, seems to have originated with Augustine of Hippo (A.D. 354-430). It is usually invoked as a magic incantation to handle an apparent conflict between Scripture and science. The invocation invariably serves as an excuse for why the Bible need not be taken literally on any particular scientific point. In other words, the saying is invoked to diminish the authority of Scripture in at least the scientific realm. However, II Timothy 3:16^{*} tells us that the Bible is authoritative in all that it touches upon, science included; so one must question the application of Augustine's claim in those places where the Bible does make scientific pronouncements. By treating the Scripture as authoritative in science when it appertains to the first chapter of Genesis, creationists have argued quite well against evolutionists; but there are still questions that have systematically been avoided by Christian scientists over the last several centuries. Two of these are geocentricity and whether the Bible presents a flat earth. In this chapter we deal with the latter.

Historical Introduction

The flat-earth model was widely espoused by the ancients. The Hindus, for example, have a cosmology in which the earth is a flat

^{*} II Timothy 3:16—All scripture is given by inspiration of God, and is profitable for doctrine, for reproof, for correction, for instruction in righteousness.

disk, placed on the back of an elephant named Gaia which, in turn, is standing on a giant turtle swimming in a vast cosmic ocean (Figure 1).



Figure 1: *The Hindu Cosmology*, by Jane Habermas

Even more ancient than the Hindu flat earth model are the Egyptian models.

The Egyptians believed the earth to be flat and surrounded by mountains over which was stretched the naked body of the goddess Nut (Figure 6.3). We'll say more about that in Chapter 6.

Until the sixth century before Christ, the Greeks believed the earth to be flat and shouldered by the giant, Atlas. Cracks in the flat-earth facade appeared about the sixth century B.C. when a Greek astronomer, Erastosthenes, noted that the shadow of the earth is always circular. An eclipse of the moon happens when the moon passes through the shadow of the earth. Since the shadow is always circular in shape, Erastosthenes concluded that the earth must be a sphere (Figure 2).

What of the so-called church fathers? Did they all believe that the earth is flat? Yes, some did. Cosmas Indicopleustes (lit. explorer of India), who lived in the first half of the sixth century, advocated a flat earth in his *Christian Topography* circa A.D. 550 (Figure 3). But he was in a small minority. His flat-earth model was opposed by John Philoponus (490-570), the originator of the scientific method. The most renowned flat-earth advocate of all time is Aurelius Augustine (354-430), who, in his *City of God*, argues for a flat earth when he opposes belief in the antipodes.¹ The antipode from where you are located right now is the spot on the earth directly opposite to your location that is, the place you would break out of the earth if you were to dig straight down through the

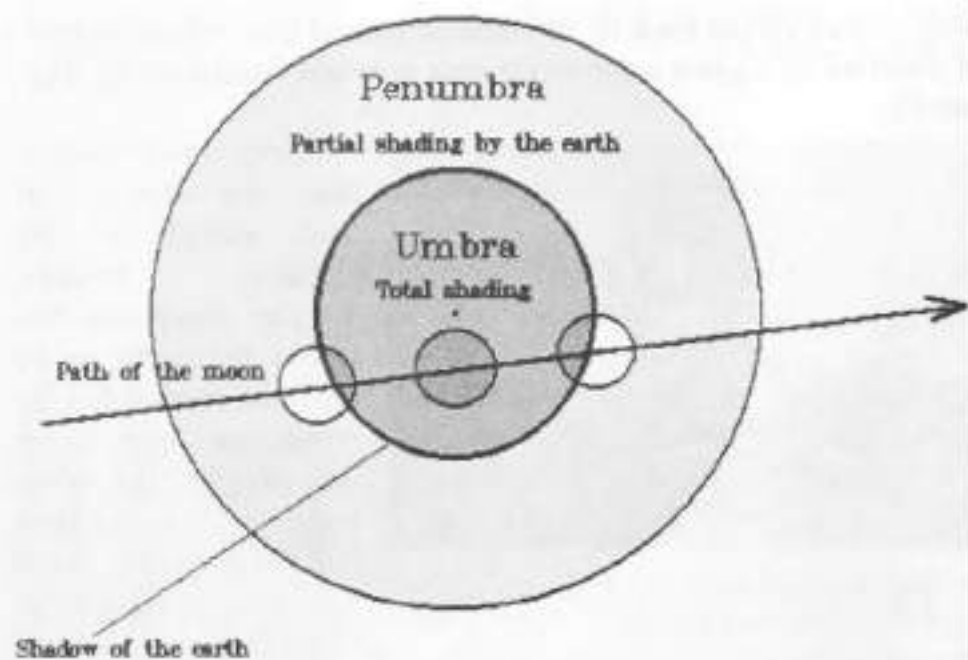

Figure 2: *The Moon Passing Through the Earth's Shadow.* Note the roundness of the umbra projected on the moon.

center of the earth. The two locations, where you are and where your antipode is, are antipodes.

Among the Western church fathers, only Tertullian (c. 140- c. 230), Augustine, and Lactantius (c. 240- c. 320) adhered to a flat earth. Indian scholars knew the earth to be spherical, as did the sailors of Tarshish who had a three-year trading cycle. Three years is about how long it takes to circumnavigate the earth by sail on a trading mission. We read in II Chronicles 9:21 that ships of Tarshish visited Solomon every three years bringing gold, silver, ivory, apes, and peacocks. Although some theologians and geographers thought the earth was flat, sailors, merchants, and astronomers knew it to be spherical.

The Flat Earth Bible Fraud

Most modern scholars claim that the Bible advocates an earth that is flat, rectangular, and placed on several pillars. The pillars,

in turn, are based on a foundation (Figure 4). The scholars reason that since this is how the ancients envisioned the earth, in writing the Bible they must have echoed the scientific dogmas of the time. It is not uncommon to read that in the Middle Ages people believed the earth to be flat and that those who opposed the idea were burned at the stake. It is even told that Christopher Columbus had difficulty getting support for his proposal to journey to the west to reach the Far East because the prevailing opinion was that the earth was flat. But history belies both that the Scripture teaches a flat earth and that the ancients believed the earth to be flat.

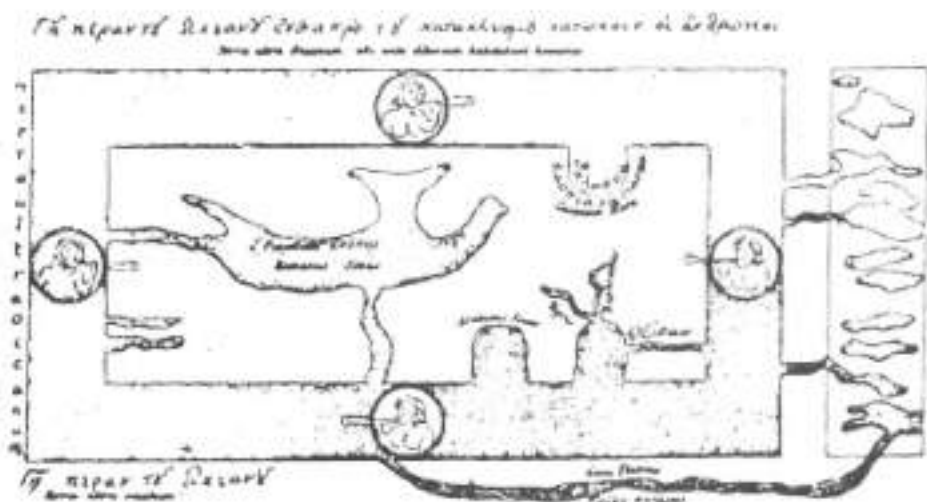

Figure 3: *The Map of Cosmas Indicopleustes.* It is patterned after the tabernacle. At right are the four rivers emanating from Paradise, the Euphrates, Tigris, Ganges, and Nile.

Neither Columbus nor his contemporaries thought that the earth was flat. Whence, then, is the error to the contrary? Historically, it appears that the flat-earth fiction originated with Washington Irving (1783-1859) who introduced it on pages 117-130 of his 1828 book, *The Life and Voyages of Christopher Columbus*. About the same time, the error was propagated in France by Antoine-Jean Letronne (1787-1848).² In the 1820s and 1830s the flat-earth story snowballed, reaching outrageous proportions by the late

1800s when Darwin's defenders delighted to use it to deride their unstudied Bible-believing opponents.⁵



Figure 4: *Typical Modern Opinion Passed off as the Scriptural View.*

The Form of the Earth In Scripture

The opinions of men are never final to the truth. We thus consider what the Scripture itself has to say about the form of the earth.

Figure 4 is typical of the model presented as scriptural by modern theologians. Such illustrations have an air of authenticity but none occur prior to the late nineteenth century. A key piece of evidence belying the model is its absence therein of the foundations of heaven and earth mentioned in Scripture.

Now a careful study reveals that a flat earth is not dictated by the strict wording of the Bible. On the contrary, the Bible was al-

ready referring to the sphericity of the earth some 500 years before the Greeks first thought to question the flatness of the earth. The Bible's model has a spherical earth, with regions of dry land corresponding to continents, and pillars undergirding the earth. Since Genesis 1:10 defines the earth as the dry land, the pillars can be inferred to be the crystalline rock, commonly called the mantle. Furthermore, the Bible tells of an unspecified number of foundations to the earth which range from the roots of mountains, to the core of the earth, to the very foundation of foundations, the Lord Jesus Christ himself. Some of the arguments given in this chapter in defense of the Bible's view of a spherical earth are over four hundred years old, others are presented for the first time; but all belie the view that the biblical earth is flat; the view that is claimed by most of this world's scholars.

By the time of the Middle Ages, scientific opinion was solidly for the spherical earth, although scholars in other fields—particularly Augustinian theologians—still had doubts. Even after America was discovered and Magellan had sailed around the earth, scholarly opinion was still divided on the issue of the shape of the earth; but proponents of the spherical earth were in the majority. Such was reported by the French academician and Christian scientist, Lambert Daneau, who, in his 1578 book *The Wonderfull VVoorkmanship of the World*, defended the sphericity of the earth on the grounds of Scripture and geometry with these words:

...so that in these positions and kindes of places and differences are found in the world, you may conclude that which you would, to wit, that the whole receite of this worlde is not sphericall and rounde.⁴

Here the word "receite" is an old spelling of our modern word, "recite." Daneau claims that despite both biblical and geometric arguments for a spherical earth, there was still no consensus among the people of his day.

Within 70 years after Daneau wrote his book, the Reformation Bible translations were completed throughout Europe. These translations, done by Greek and Hebrew scholars of unsurpassed

capability, gave all people access to the Bible and also provided far stronger biblical support for the sphericity of the earth than the handful of passages used by Daneau and his contemporaries.

So just what does the Bible have to say about the earth's shape? In order to find the answer to that question we need to look at the parts of the earth. The Bible lists the following: the *foundations of the world and the earth*; the *pillars of the earth*; the *corners of the earth*; and the *ends of the earth*. We consider these in order.

The Foundations of the World

The Bible speaks of both the world and the earth as having foundations. The *world* is defined as the order of man in the earth (see Chapter 4). As such, references to foundations and pillars of the world cannot be held as very authoritative in determining the physical shape of the earth. The term *earth*, on the other hand, can refer to the whole earth, or merely to ground or soil, or to a land, or to a country (see Chapter 5). In order to arrive at a complete picture of the form of the earth as presented in Scripture all these meanings must be considered. Although the world-passages are weak, it behooves us to examine those verses that refer to the foundation of the world in order to make certain that they do not contribute to arguments about the shape of the earth.

In Scripture, we find three passages that speak of the foundations of the world. Of the three, two are almost identical. Those two are found in II Samuel 22:16 and Psalm 18:15:

And the channels of the sea appeared, the foundations of the world were discovered, at the rebuking of the LORD, at the blast of the breath of his nostrils. (II Samuel 22:16)

Then the channels of waters were seen, and the foundations of the world were discovered at thy rebuke, O LORD, at the blast of the breath of thy nostrils. (Psalm 18:15)

Both passages indicate that the foundations of the *world* are now hidden but will be discovered at the time of the judgment.

The third reference to the foundations of the *world* is found in Psalm 24:1-2 and tells us just what these foundations are:

¹The earth is the LORD's, and the fulness thereof; the world, and they that dwell therein.

² For he hath founded it upon the seas, and established it upon the floods.

Since *world* pertains to the order of mankind, and since water is absolutely essential to human life, there can be little argument about the truth of the statement that the world is founded upon the seas and not, as pictured by most scholars, founded upon rocky foundations like the foundations of a building. Floods are crucial for fertilizing the soil and for some plants, like rice, for instance. Ultimately the world is founded upon Jesus Christ, from whom streams the living water.

The Foundations of the Earth

When it comes to the foundations of the *earth*, there are more scriptures from which to draw. Many of these report that God laid the foundations of the earth; but each verse adds a little to that simple fact. Psalm 102:25 tells us that God laid the foundations "of old," and Hebrews 1:10 echoes the thought that God laid the foundations of the earth "in the beginning." Job 38:4 states that God laid the foundations of the earth and the sixth verse implies that the foundations are themselves fastened upon something else; Hebrews 1:3 names this "something else" as the Lord Jesus Christ who upholds "all things by the word of his power." Proverbs 8:29 tells us that the earth's foundations were appointed. Proverbs 3:19 reports that the earth was founded by wisdom, while Jeremiah 31:37 indicates that earth's foundations are unsearchable. Micah 6:2 tells us that they are strong, so strong that the earth should never be removed (Psalm 104:5).

In the light of these passages, three conclusions are readily apparent about the foundations of the earth. First, the foundations themselves are fastened upon Christ, the sustainer of the universe. Second, the foundations are themselves located somewhere under the earth; and third, we are limited in what we can learn about them, for Jeremiah 31:37 states:

Thus saith the LORD; If heaven above can be measured, and the foundations of the earth searched out beneath, I will also cast off all the seed of Israel for all that they have done, saith the LORD.

Of these three conclusions, the first is spiritually discerned, the second is obvious, and the third is scientifically verifiable.

Whenever there is an earthquake, shock waves are propagated throughout the interior of the earth. Seismologists use these waves to study the interior of the earth. But there is one area that the waves fail to penetrate, an area which cannot be studied. That area is the earth's core, the very central part or "foundation" of the spherical earth. This is the thing of which the prophet Jeremiah spake. To further illustrate the unsearchability of the earth's core, note that seismologists still argue whether the center of the earth is composed of molten iron or rock. No one knows for certain. And so, the biblical passages on the foundations of the earth stand as authoritative as ever.

The Pillars of the Earth

If the scriptural view of the earth is that of a spherical earth, what then of the "pillars of the earth?" The pillars are mentioned in three similar passages, Hannah's prayer in I Samuel 2:8 being the first:

He raiseth up the poor out of the dust, and lifteth up the beggar from the dunghill, to set them among princes, and to make them inherit the throne of glory; for the pillars of the earth are the LORD'S, and he hath set the world upon them.



Figure 5: *Devil's Tower Provides an Example of Crystalline Pillars.* Note two climbers at left.

Obviously this verse indicates that the earth has pillars and that the world (that which pertains to man) is set upon them, not having any pillars of its own. Note that this verse does not require that the *earth* be placed on the pillars, only that the *world* is "set" thereon. Later we shall find this view to be consistent with the other two Scripture passages. It does not seem to be the case, as historians de Santillanna and Von Dechend argued in their book *Hamlet's Mill*,⁵ that

the pillars of the earth are the two solstices and the two equinoxes. (The *solstices* are the highest and lowest points at which the sun appears in the sky, occurring on the first days of summer and winter respectively; and the *equinoxes* are the times when the sun crosses the equator, corresponding to the first days of autumn and spring.)

Finally, there is one more Scripture reference to consider before concluding this study of the pillars of the earth. Job 26:7 will modify any preconceived notions we may have about those pillars, for it reads:

He stretcheth out the north over the empty place, and hangeth the earth upon nothing.

A flat earth upon pillars and foundations, hanging upon nothing, seems like a contradiction. One usually pictures the foundation to be the primary support for a structure, but here we see that in addition to the pillars and foundations underneath, the earth also hangs upon nothing.

That the pillars are under pressure is clear, for they support the surface of the earth (where the world is) according to Hannah's song. If the earth is spherical in shape, then the earth's pillars must be located between the earth's surface and the core. In particular, the pillars of the earth could simply be radial crystalline rock which pervades the earth's mantle.

Seismic studies reveal that there is a shell of crystalline rock inside the earth, namely, the *mantle*. Occasionally these crystalline forms can be found on the surface of the earth, brought up as lava. The crystals can easily be 15 feet in diameter. There are at least two examples of such rock in the continental United States: one is Pinnacles National Monument in California; and the other, more graphic example, is Devil's Tower National Monument in Wyoming (Figure 5).^{*} Such vertically-oriented crystals could make up the pillars of the earth. I admit this is sketchy, but we have very little solid knowledge of the interior of the earth (Figure 6).

The Corners and Ends of the Earth

If the foundations and pillars of the earth seem to be scientifically reasonable, then what of the four corners of the earth? Isn't that proof of the Bible teaching that the earth is flat? Satellite results from the 1960s and '70s showed that the earth has four bulges. Some Christian apologists have taken these four bulges to be the four corners of the earth; but such is a reach, especially since the bulges are only a few yards above the mean shape of the earth. The problems encountered in understanding the corners of

^{*} To be precise, I am not proposing that Pinnacles and Devil's Tower are the tops of pillars sticking out from earth's mantle. I am proposing that the mantle is crystalline in structure and that those crystals may be packed and oriented the same way as these two examples of re-crystallized lava.

the earth only arise if one ignores the dictionary definition of the word *corner*. The *Oxford English Dictionary* defines “corner” to mean:

An extremity or end of the earth; a region, quarter; a direction or quarter from which the wind blows.

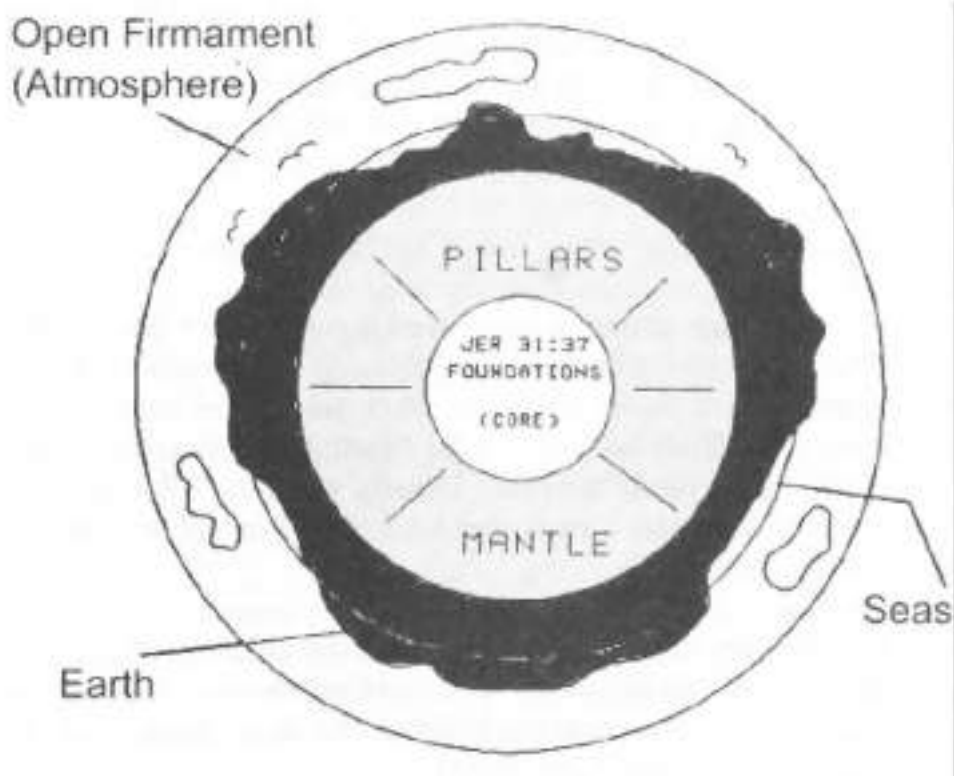

Figure 6: The Form of the Earth According to Scripture

The word *corner* comes from a Latin root *cornu*, meaning “horn.” We see this in English words such as “cornet,” “corn,” and “cornucopia.” Hence the four corners of the earth can be interpreted as referring to the four cardinal directions—north, south, east, and west. Additionally, the “four corners of the earth” can also be interpreted as four “horns” of the earth. One obvious example of such a “horn” is Cape Horn, the southernmost tip of South Amer-

ica. Thus the phrase “four corners of the earth” does not require a flat, rectangular earth.

Besides the “four corners of the earth,” the Bible also mentions “the ends of the earth.” For the ends of the earth, the above dictionary definition contains the resolution within it; for by saying the “ends of the earth” we can simply mean the “extremities of the earth” such as its beginning and its end in time or any antipodes.

Implicit in the above resolutions for both the ends of the earth and the corners of the earth is the assumption that the word *earth* refers to the land mass, country, or continents, not necessarily the globe. Is this scripturally consistent?

What Is the Earth?

We now come to one of the crucial arguments for the sphericity of the earth as presented in the Bible. When people claim the Bible teaches that the earth is flat, they take it for granted that every time the Bible uses the word “earth,” it means the entire globe; but such is rarely the case. Usually when the Bible uses the word “earth,” it means a particular land or country. For example, compare Exodus 10:15:

For [the locusts] covered the face of the whole *earth*, so that the land was darkened; ... and there remained not any green thing in the trees, or in the herbs of the field, through all the land of Egypt [emphasis added]

with verses 12 through 14:

¹² And the LORD said unto Moses, Stretch out thine hand over the *land of Egypt* for the locusts, that they may come up upon the *land of Egypt*, and eat every herb of the land, even all that the hail hath left.

¹³ And Moses stretched forth his rod over the *land of Egypt*....

¹⁴ And the locusts went up over all the *land of Egypt* [emphasis added].

Since the word "earth" can be synonymous with land, country, or nation, the "ends of the earth" refer to the points of land most distant from some central point. For the Bible, this central point is the land of Israel. By examining a globe, the reader can satisfy himself that a great circle, passing through Jerusalem and the north and south poles, cuts the Pacific Ocean in half and leaves four continental "corners" or "ends," namely the Chukchi Peninsula of the former Soviet Union (opposite the Bering Straits of Alaska), Alaska, the southeastern tip of Australia, and Cape Horn of South America. These four geographical locations, as much as any other proposal, can account for the four corners of the earth as the four landmasses most distant from Israel. In the light of such argument, we cannot claim that the Bible presents the earth as a four-cornered square.

This line of argument is supported by Scripture itself, for the first definition of "earth" occurs in Genesis 1:10* where we are told that God calls the "dry land, Earth."

The Circle of the Earth

There are some passages in the Scripture which provide more direct evidence that Scripture espouses a round earth instead of a flat earth. The most famous of the Bible verses supporting a spherical earth is Isaiah 40:22 where it says of God that:

It is he that sitteth upon the *circle of the earth*, and the inhabitants thereof are as grasshoppers; that stretcheth out the heavens as a curtain, and spreadeth them out as a tent to dwell in.... [emphasis added.]

The fact that this verse speaks of the "circle of the earth" can mean one of three things: first, the earth is not a flat square but a flat circle; second, the earth is shaped in a way that is spheroidal but has a square cross-section somewhere, at the equator for instance; and

* Genesis 1:10—And God called the dry land Earth; and the gathering together of the waters called he Seas: and God saw that it was good.

third, the earth is spherical in shape. During the Renaissance, this verse was seen as the key biblical support for a spherical earth.

Isaiah 40:22 is not the only verse which speaks of the circle as descriptive of the shape of the earth. Proverbs 8:27 reads:

When he prepared the heavens, I was there: when he set a compass upon the face of the depth...

The word "compass" can mean a circular enclosure, or it can mean a spherical envelope. Since the verse speaks of the seas which are an extended area covering about three-quarters of the surface of the earth, the spherical enclosure for "compass" is a better interpretation than a circular enclosure.

By itself, the evidence for the sphericity of the earth in Isaiah 40:22 and Proverbs 8:27 is still only circumstantial. But when we combine those passages with the ones about the ends and corners of the earth, then there is a stronger case; to wit, if what the scholars advocate is true, that the Bible teaches that the earth is a flat rectangle, then how can one reconcile that with the aforementioned verses which speak of the circle and compass of the earth? Even the advocates of the flat earth have been forced by Isaiah 40:22 and Proverbs 8:27 to allow that the earth might be a circle. But if that is true, then what of the four corners of the earth argument? A circle has no corners, anymore than does a sphere. So even the flat-earth advocates admit that the four corners of the earth are the four cardinal directions: north, east, west, and south.

In the Twinkling of an Eye

If nothing else, the verses looked at heretofore serve to illustrate that a spherical earth is not incompatible with the Bible. But there are two passages which are stronger still in their support that Scripture promotes a spherical earth. The first is Luke 17:31-36 which reads as follows:

³¹ In that day, he which shall be upon the housetop, and his stuff in the house, let him not come down to take it away: and he that is in the field, let him likewise not return back.

³² Remember Lot's wife.

³³ Whosoever shall seek to save his life shall lose it; and whosoever shall lose his life shall preserve it.

³⁴ I tell you, in that night there shall be two men in one bed; the one shall be taken, and the other shall be left.

³⁵ Two women shall be grinding together; the one shall be taken, and the other left.

³⁶ Two men shall be in the field; the one shall be taken, and the other left.

What do these verses have to do with the shape of the earth? Simply this: they speak of day (verse 31) and night (verse 34) as occurring simultaneously. The activities are listed in the context of one or two global events which, depending on one's dispensational view may be the rapture, which Paul says occurs in the "twinkling of an eye" (1 Corinthians 15:52), or the first of the sickle harvests of Revelation 14. The simplest explanation for this simultaneity of day and night is a spherical earth.

Now Bob Schadewald (1943-2000) criticized me for using Luke 17:31-36, saying that: "the modern (though not the ancient) flat-earth model has day and night occurring simultaneously at different points on earth."⁶ It is true that one can always postulate a curved-space geometry for light rays which would have day and night occurring simultaneously on a flat earth, and this is indeed advocated by today's most sophisticated flat-earth proponents, but it misses the point. (Such geometrical arguments make it impossible to prove or disprove the flat-earth model.) The context of my argument is whether the *Bible* teaches a flat earth and I make my point against the flat-earth models of the times when Scripture was written. When Luke penned Luke 17:31-36, flat-earth advocates were still advocating Schadewald's "ancient" flat-earth models, where the sun went under the earth, or behind a mountain at the edge of the earth, or returned to its rising point by journeying in a

tunnel through the earth. If, as Schadewald assumed, the Bible was written by men, then it is clear that Luke could not have had the modern curved-space flat-earth view in mind when he wrote the passage; and so my argument against Bob's premises stands.

The second of the strong passages is Acts 1:8 where Jesus commissions his disciples to be witnesses "unto the uttermost part of the earth." Note here that the word "part" is singular. A flat earth, either a circle or a rectangle with four corners, should be indicated by "uttermost parts" (plural); but a spherical earth would have only one uttermost part, namely, its opposite side or antipodes, even as Jesus said in Acts 1:8. The case for a spherical earth in the Bible is thus made.

The Flood and the Flat Earth

It was Prof. James Hanson who first pointed out to me that Noah's year-long flood requires a spherical earth. Here is why that is the case.

Consider the Hindu model in Figure 1. Clearly the waters would have fallen off the edge of the earth and could not have covered the highest mountains by fifteen cubits, as stated in Genesis 7:20. Barring a miracle, the waters would have drained off the earth too quickly, taking the ark with it. Genesis 7:24 says that the water remained 150 days (about five months) on the earth before it began to drain. Remember that the common flat-earth story is that ancient sailors, up to the time of Columbus were afraid of being swept over the edge of the earth by the waters spilling over the edge. Clearly, that belief is not consistent with the biblical account of the flood.

In Figure 4, which, in part, reflects the Egyptian idea of the flat earth, the earth is surrounded by a ring of mountains. In that case, the waters would have been fifteen cubits higher than the mountains at the edge of the earth. The waters would overflow the mountains for the next five months and would have eroded the mountains at the world's edge. Moses was thus not influenced by

his Egyptian teachings when God gave him by inspiration the words to write of the flood account.

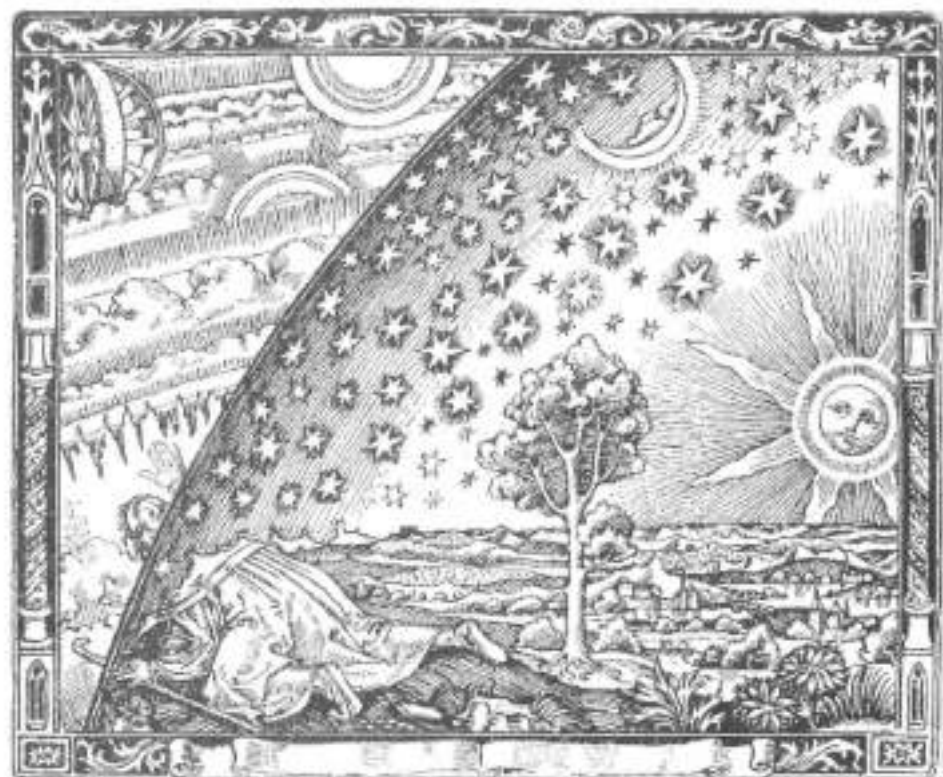

Figure 7: *Flammarion's 1888 Woodcut.* It depicts a pilgrim who has reached the edge of the flat earth, portraying the poplar nineteenth century view of the flat earth.

Conclusion

The Holy Bible teaches that the earth is spherical in shape; that there are pillars which undergird the earth which we propose are the crystalline rock of the mantle; that there are an unspecified number of foundations which range in size all the way from the foundations of the hills and mountains (called *roots* in modern science) to the unsearchable core of the earth and down to the very foundation which is the Lord Jesus Christ himself. This is the view of the earth presented in Scripture.

A key argument for the flat-earth Bible hinges on the flat earth advocate's assumption that when Scripture uses the word "earth," it always means the entire globe. However, "earth" in the Bible, can also refer to a country, soil, or land—a limited area—as attested to by the fact that it needs the word "all" in front of it to mean more than that. Furthermore, God gives the primary definition of earth as dry land, not the globe. Even the account of the flood given in Genesis 7 and 8 is incompatible with the flat earth models, even with today's flat earth models. According to Scripture, the earth is a sphere.

What, then, of those who insist that the Bible does teach a flat earth? Those Bible critics simply have not studied the matter deeply enough. Knowing much *about* the Bible, they know little *of* the Bible, and we are justified in viewing with due skepticism any man who uncritically prefaces his remarks with: "The Bible is not a textbook on science."

Wherefore, if meat make my brother to offend, I will eat no flesh while the world standeth, lest I make my brother to offend.

— I Corinthians 8:13

4

MOTIONS OF THE WORLD

The Holy Bible makes a consistent and important distinction between the world and the earth. It is crucial that this distinction be understood in any discussion involving earth and world. Literally, the word *world* comes from two Germanic roots: *wer*, meaning "man," and *ald*, meaning "age." In Scripture the first occurrence of "world" is found in 1 Samuel 2:8 where, in verses 8-10, we read:

⁸ He raiseth up the poor out of the dust, and lifteth up the beggar from the dunghill, to set them among princes, and to make them inherit the throne of glory: for the pillars of the earth are the Lord's, and he hath set the world upon them.

⁹ He will keep the feet of his saints, and the wicked shall be silent in darkness; for by strength shall no man prevail.

¹⁰ The adversaries of the LORD shall be broken to pieces; out of heaven shall he thunder upon them: the LORD shall judge the ends of the earth; and he shall give strength unto his king, and exalt the horn of his anointed.

Verse 9 teaches us that the world is the strength of man and that it will be ruled by the Lord Jesus Christ (v. 10). Compare Isaiah

24:4* where world is identified with the haughty people of the earth.

Job 37:12 best illustrates the difference between “earth” and “world” when it states:

And [God’s bright cloud] is turned round about by his counsels: that [God’s clouds] may do whatsoever he commandeth them upon the face of the world in the earth.

The clause “upon the face of the world in the earth” indicates that the earth and the world are coupled together so that if the world does not move, then neither does the earth does move and *vice versa*. So we must look at the moving and fixed-world passages to see if they are consistent with the motions ascribed to the earth in the Bible.

Scripture’s references to the immobility of the world can be broken up into two groups: the first group is those that refer to the world to come, while the second group refers to this present world. That these two worlds are not one and the same is clearly presented in Matthew 12:32 where Jesus rebukes those who blaspheme against the Holy Ghost with the words:

...it shall not be forgiven...neither in this world, neither in the world to come.

It is the latter world that is sometimes referred to as the “world without end” in places such as Isaiah 45:17 and Ephesians 3:21. When it comes to this present world, there are only two references in the entire Bible describing its motion or lack thereof: Psalm 93:1 and I Corinthians 8:13.

* Isaiah 24:4—The earth mourneth and fadeth away, the world languisheth and fadeth away, the haughty people of the earth do languish.

Immobility of the Present World – Psalm 93:1

The first of the two references to the stability of this present world occurs in Psalm 93:1, which reads in part:

. . . the world also is stablished, that it cannot be moved.

The word *stablished* may sound strange to the modern ear, but it communicates a very subtle point which, though present in the Hebrew, is lacking in all modern versions which favor the word “establish” instead. *Stablish* means to stabilize; *establish* means to set up. The rendering in the King James Bible reflects God’s continuing, stabilizing influence on this present world. This makes a lot of sense considering that the world is founded upon waters (Psalm 24:1-2). To use the English word “established” in this verse would allow one to draw the erroneous conclusion that God “set up” the present evil world system and now lets it run down on its own. Except for Jehovah, the gods of all other faiths have left the world to the whims of fate. In contrast, the use of the word *stablish* indicates that Jehovah is actively keeping the world from the destabilizing effects of evil. As if to underscore that theme, the next verse of Psalm 93:2 interjects God’s throne into the picture:

Thy throne is established of old: thou art from everlasting.

It is from that throne that God will judge (Revelation 20:11^{*}). We shall have more to say on the matter in chapter 12 where we consider the earth as footstool to the throne of God.

Since Psalm 93:1 says that the world is stablished that it cannot be moved, it weakly follows that the earth on which the world is stablished is not moving either. However, that argument is not conclusive. If this were the strongest verse for the stationary earth, there would be no geocentricity. Because of its weakness, geocen-

^{*} Revelation 20:11—And I saw a great white throne, and him that sat on it, from whose face the earth and the heaven fled away; and there was found no place for them.

tricity's critics in the creationist community have presented Psalm 93:1 as a straw man by pretending that this is the key scripture for geocentricity and then knocking it down.¹ We shall examine the arguments of Creationists against geocentrists in Chapter 39.

Despite the verse's weak support for the geocentric model, it was considered a significant support for geocentrism during the Copernican Revolution. As a result, some heliocentric apologists have felt the need to insert heliocentrism into the verse. Some have postulated that what the verse is *really* saying is that the earth neither can be deflected out of its orbit around the sun nor be perturbed in its orbit. They maintain that what God "really means" is that the *orbit* of the earth is stable rather than that the *world* is established. But is God really such a careless grammarian? If that is what God really meant to say, he could have done so simply by changing the wording. For instance, God could have written "the path of the world is established that it cannot be moved." Furthermore, proper grammar would have required that God use such words as "deflected" or "perturbed" instead of "moved" if, indeed, the passage is intended to refer to the earth's motion through space.

Heliocentrists have two problems with their interpretations. First, heliocentrists confuse the world with the earth; and second, they have violated their own heliocentric physics. Consider: the interpretation brought to bear is that the earth cannot be deflected in its orbit. But every astronomy student knows that the planets are constantly being deflected since they are subject to the gravitational influences of all of the other planets. So heliocentrically speaking, the earth *is* being deflected in its orbit. (In all geocentric theories the earth is not a planet.) Heliocentrically, even earth's very orbit is deflected, which deflection is called the *perihelion precession*. There is then no way that the Bible's presentation can fit the heliocentric mold.

It is informative to look at some of the interpretations of Psalm 93:1 as conceived by various revisionists. Kenneth Taylor, for example, in his *Living Bible* (which Taylor claims is not a Bible yet he titled it a Bible anyhow), goes so far as to equate the "establishing" of the world with the "establishing" of God's throne in Psalm

93:2 and promptly declares that the world is God's throne. This is not only bad translating but bad exegesis and logic as well. Isaiah 66:1 clearly teaches that the earth is God's footstool, not his throne; Psalm 11:4 places God's throne in heaven and not in earth.

Sometimes the revisionists' attempts around the implicit geocentricity of the passage humorously confound them. De Witt, in his *Praise Songs of Israel* renders Psalm 93:1 as:

So the world standeth fast; it cannot be overthrown.

Changing "cannot be moved" to "cannot be overthrown" certainly does remove the stationary world overtones of the verse, but notice that "stablished" has been changed to "standeth fast" which reintroduces the stationary world sense of the passage.

R. K. Harrison, in his *Psalms for Today*, has decided that the word "world" is not proper English because of the geostasis inherent in the passage. Instead of what is properly translated as "world," he opts for a more obscure and archaic meaning for "world," namely, "universe." If "universe" were actually meant here instead of "world" then this would be the *only* such occurrence in Scripture. To assume this on the say-so of heliocentrists is sheer folly. Harrison renders the verse as:

The universe has been established immovably,

So we see that attempts to circumvent the geocentric implications inherent in Psalm 93:1-2 have proven to be weak, contradictory, and occasionally comical.

Immobility of the Present World – I Corinthians 8:13

The second of the two passages which speak of the lack of motion on the part of the present world is I Corinthians 8:13:

Wherefore, if meat make my brother to offend, I will eat no flesh while the world standeth, lest I make my brother to offend.

Since only the Authorized Version renders this verse in a stationary-world context, some will doubtless object that this is just bad translating on the part of the King James translating committee. But the issue is much deeper than simply bad translation. Psalm 12:6-7,⁸ in all Reformation translations, as well as the old Hebrew lexicons, indicates that Scripture can be inerrantly translated and preserved into every language after proper refinement of that language. Only the language of the King James Version is such a refined language, a sacred English language independent of colloquial and literal English. No other tongue underwent such refinement as to extract from it a sacred form of that language. Thus all modern versions, as well as the Reformation translations, read “forever” instead of “while the world standeth” in 1 Corinthians 8:13. Despite this, the underlying Greek idiom is phrased exactly as we find it in the Authorized Version. Thus the Authorized Version’s rendering is consistent with the translators’ resolve to use the same English wording for each Greek wording wherever the context allows.

In summary, then, there are no passages which indicate any motion for this present world; and two verses, Psalm 93:1 and 1 Corinthians 8:13, expressly deny any motion is partaken of by this current world.

⁸ Psalm 12:6-7—“The words of the LORD are pure words: as silver tried in a furnace of earth, purified seven times. ⁷ Thou shalt keep them, O LORD, thou shalt preserve them from this generation for ever.” In conformance to the revision of Scripture-based word meanings in the mid-eighteenth century, this passage is now said to refer to the preservation of people instead of words. For a defense of the A.V. reading see: Thomas M. Strouse, 2007. “The Permanent Preservation of God’s Words, Psalm 12:6, 7,” in *Thou Shalt Keep Them*, Kent Brandenburg, ed. (El Sobrante, CA: Pillar and Ground Publishing), pp. 29-33.

Steadfastness of the World to Come

If no motion is experienced by this present world, then certainly none should be experienced in the perfect world to come. Here, too, we find only two verses with reference to the new world's motion. The two are I Chronicles 16:30 and Psalm 96:10. I Chronicles 16:30 reads:

Fear before him, all the earth: the world also shall be stable,
that it be not moved.

The word "shall" here indicates the future tense so that, by itself, the verse cannot be invoked to indicate that the present world is immobile. But it does teach that the world to come will be stable and unmoving.

Now, heliocentrists say that the verse refers to the orbit of the new earth; but the same arguments as were presented against that interpretation of Psalm 93:1 can be invoked against the heliocentric interpretation here. To indicate heliocentrism, the Masoretic text and all the translations should have used "deflected" or "perturbed" instead of "moved." Significantly, most heliocentrists totally miss that this verse is in the future tense. Heliocentrists attack the verse's validity on the erroneous assumption that the *present world* is here claimed to be immovable.

Psalm 96:10, the second passage about the immobility of the world to come, reads:

Say among the heathen, that the LORD reigneth: the world
also shall be established that it shall not be moved: he shall
judge the people righteously.

This verse is strongly reminiscent of Psalm 93:1. Note that Psalm 96:10 uses the word *established*, whereas Psalm 93:1 uses the word "*stablished*." In the light of what we learned above about the distinction between these two words, the use of *established* here reveals that the world to come will be set up by the LORD in righteousness in such a way that the new world will not need continu-

ous stabilization by God. In other words, it will be a righteous world. This conclusion, too, is absolutely scriptural.

Conclusion

In conclusion, the meaning of the Hebrew word translated in the Authorized Version as "world," *tebel*, is always associated with mankind and is never associated with the universe or firmament. In Proverbs 8:31, *tebel* is translated as the "habitable part of his earth;" thus the definition of world as the order of man upon the face of the earth is as strong in Hebrew as in English. In the New Testament the nature of the world is laid out in I John 2:15-17, where it is identified as humanism with its gnosticism. There is not one single passage in the entire 66 books of the Bible which would lead one to conclude that the world is now or ever will be moving. Instead, we found one reference which directly indicates that this present world is not moving, and two verses which say that the world to come will not move either. Attempts to reconcile these verses with modern heliocentrism make God out to be a poor grammarian and make the reconcilers out to be the clairvoyants of what God actually *meant* to say but did not have the smarts or integrity to say correctly in the first place.

Sanctify them through thy truth: thy word is truth.

— John 17:17

5

MOTIONS OF THE EARTH

Like the biblical passages which deal with the motions of the world, the passages which refer to the motions of the earth can be divided into two categories. But, unlike the “world” passages, there are no “moving earth” references about the “new earth.” Instead, the earth passages can be split into those which pertain to the earth as it is now and those which describe the condition of the earth at the time of judgment.

Motions of this Present Earth — Psalm 104:5

The most famous and yet among the weakest of all geostatic passages is Psalm 104:5, which states that God:

...laid the foundations of the earth, that it should not be removed for ever.

Heliocentrists have assailed this verse from several different angles; yet strangely, none seem ever to have correctly read the verse. Psalm 104:5 is *conditional*: it is not absolute; for we see the conditional “should” which need not reflect the way things are. Having missed that point, heliocentrists have charged that the words “laid the foundations” are improperly translated from the Hebrew; or they claim that the word “removed” is not correct; or they dismiss the verse as mere poetry, as if poetry never conveys literal truth. One of these charges was addressed in the first chapter. The long quote from De Morgan lucidly presents the logical

flaw in the “phenomenological poetry” argument—every word is true, whether poetry or prose, or the God of Truth could not have written it. With this concurs the chapter quote.

What of the first of the charges, the one about the correctness of the “laid the foundations” translation? The critics prefer “set the earth on its foundations.” But this does not in the least affect the implicit geocentricity of the verse. Instead, such an argument introduces an uncertainty about just who “laid the foundations” if God only “set” the earth upon them. As far as the translation is concerned, the correct translation is “laid the foundations” even as we find it in the Authorized Version.

In looking at the second of the arguments, the status of the word “removed,” it is advisable to consult a dictionary. In previous chapters we have noted several cases where so-called archaic or “difficult” words have revealed very subtle shades of meaning, shades which are generally lost on Bible critics. The word “removed” affords us another example. “Removed” means “to shift out of a designated place.” “Move,” on the other hand, means to change position. Thus “removed” indicates that the earth is located in a place which is special to it: a place especially prepared for it, a home, in other words. In fact, the British still use the word “remove” when a family moves from one home to another. This subtle overtone is also present in the Hebrew and so is exactly translated by the use of the word “remove.” Hence there is no problem with the English translation of Psalm 104:5.

For Psalm 104:5, too, it has been proposed that the verse *really* refers to the orbit of the earth, allegedly indicating that the orbit is stable and that the earth shall not be “removed” or “moved” out of it. This raises the same objections that we met in Chapter 4 where that proposal was applied to Psalm 93:1 (pg. 37). Again, God should have written “deflected” or “perturbed from its course” instead of “removed,” for according to modern astronomy the earth is continually being perturbed in its orbit by the gravitational pull of all the other bodies in the solar system. The proposal that the verse refers to the orbit of the earth does not at all bring the text into “conformity” with modern science. There is simply no helio-

centric view which is compatible with any of the various attempts around this passage, let alone with the literal truth of it.

Some of the Reformation translations are even stronger in the geostatic impact of this verse than is the Authorized Bible. The Dutch *Statenbijbel*, for example, reads, "totter" instead of "removed." Some modern versions, such as the NASV, also use "totter"; but in so doing the heliocentrists strongly bring themselves into direct conflict with modern astronomy because, according to astronomy, the earth is perpetually tottering on its axis. One tottering phenomenon is known as the *precession of the equinoxes*. Another example of a tottering earth is the Chandler wobble. The precession of the equinoxes is exactly akin to the tottering of a top or gyroscope. (In the geocentric case the tottering is ascribed to the heavens, not to the earth; but we shall defer such coverage until our consideration of the scientific evidence.) No matter what the heliocentrist tries, there seems to be no way around the conclusion that the verse is geostatic as long as heliocentrism's apologists neglect the conditionality of the verse.

Psalm 104:5 is of such great historical importance in the debate between heliocentrism and geocentricity that private interpretations and attempts at phenomenization abound. Let us examine just a few of these as representative of all. We start with de Witt who, in his *Praise Songs of Israel* presents:

... that it should not be overthrown for ever.

Verkuyl, in his *Modern Language*, the New Berkeley Version in modern English, (ML) agrees, rendering it as:

... so that it should never be overthrown.

Taylor's *Living Bible* (LB) gives the verse as:

... that it should never fall apart.

The *New King James* (NKJV) trashes the finer points of the verse with its rendition of:

... so that it should not be moved for ever.

Likewise, the NIV states that:

...it can never be moved.

Finally, the *Revised Standard Version* (RSV) offers us:

... so that it should never be shaken.

Quickly let us note that contrary to the RSV, the earth does "shake" during an earthquake; and despite the LB, it will "fall apart" at the end time. We could go on and on and round and round with this; but as was noted, the heliocentrist has completely missed the one "out" afforded him, namely, the "should."

Despite the long, hot debate about Psalm 104:5, most of it has been in vain. The resolution of the text does not hinge upon whether or not the earth be "moved" or "removed." Nor does it hinge on whether or not it is the earth that is referred to in this verse or else its orbit around the sun. The simple fact is that the verse is conditional. Despite the centuries of arguing, the verse neither proves nor disproves geocentricity. All Psalm 104:5 says is that God "...laid the foundations of the earth, that it should not be removed for ever." The word *should* is a conditional word, unlike the word *shall* which has a sense of permanence that *should* does not have. If any inference must be drawn, however, it is clear that the inference is geocentric.

The Abiding Earth

There are two other verses in Scripture, that indicate the immobility of the earth. The first of these is Psalm 119:90 which states that:

Thy faithfulness is unto all generations: thou hast established the earth, and it abideth.

The second such passage is found in Ecclesiastes 1:4:

One generation passeth away, and another generation cometh; but the earth abideth for ever.

Both of these verses use the word "abide," a word which in English is not particularly strong in indicating a stationary earth. Historically, however, both verses have been held to support geocentricity. Interestingly, most of this has been done by Jewish scholars rather than Christian scholars. This is because the geocentric implication of these verses is much stronger in Hebrew than in English. Note that in both Hebrew and English the word "abide" has in it not only the sense of waiting, but also a sense of dwelling, which is consistent with the earlier discussion about the word "removed" in Psalm 104:5.

From all the passages of Scripture to which we have turned thus far no strong case can be built in support of geocentricity; but there is certainly no support for heliocentrism there either. In contrast, there is a set of Bible passages which do express definite motion on the part of the earth. These verses all refer to the earth in the context of the judgment. Although the verses afford the earth some motion, they do not at all help the cause of heliocentrism.

The Moving Earth

We now examine the passages which refer to motions on the part of the earth. The first occurs in Job 9:6 which states that God:

...shaketh the earth out of her place, and the pillars thereof tremble.

The second, Psalm 99:1, speaks likewise:

The LORD reigneth; let the people tremble: he sitteth between the cherubims; let the earth be moved.

Isaiah 13:13 contributes:

Therefore I will shake the heavens, and the earth shall remove out of her place, in the wrath of the LORD of hosts, and in the day of his fierce anger.

Finally, Isaiah 24:19-20 is even broader:

¹⁹ The earth is utterly broken down, the earth is clean dissolved, the earth is moved exceedingly.

²⁰ The earth shall reel to and fro like a drunkard, and shall be removed like a cottage; and the transgression thereof shall be heavy upon it; and it shall fall, and not rise again.

Implicit in several of these verses is the notion that this present earth has a *place*, not a *path*. "Place" is hardly a fitting terminology for a moving earth in this context. Again, if a heliocentric context had been intended then would God not have better used such words as "course" or "orbit" instead of "place"? Such wording is not mystical or obscure and is entirely consistent with heliocentrism. If the earth is to be shaken out of its place at the judgment, then at that time the earth definitely will have motion. This concept of a motion for the earth at the judgment is entirely consistent with the rest of Scripture and with all judgment passages which refer to the earth; it is only superficially inconsistent with verses such as Psalm 104:5 where the disallowance of motion is merely conditional.

Note that in Isaiah 13:13 the use of the word "remove" is fantastically consistent on the part of the Authorized Bible. As was noted earlier in this chapter, Psalm 104:5 teaches that the earth "should not be *removed*"; and we saw that the word "remove" has implicit in it the sense of the earth having a special place, a home of its own. The word "move" has no such significance, yet here, in

this verse, the earth's place is again in evidence. There is no contradiction between the earth's being removed, as per this passage, and the statement that it should never be removed in Psalm 104:5, because the latter is conditional. The Bible teaches that it is man's sin which causes the conditions to change so that the earth will ultimately be removed even though it was founded so that it should never be removed.

Psalm 99:1 does not say that the earth is now moving; it only says "let the earth be moved." It indicates the removal of something that is presently hindering the earth from moving. So it is that the verse cannot refer to changes in the course of the earth through space. It presents an earth that is presently immobile. (Strangely, if taken out of context this is the only verse in the Bible where one might remotely conclude that the earth is currently allowed to move; but heliocentrists fail to pick up on it, choosing instead to alter the wording to read: "quiver," "shake," or "quake" instead of "move.")

As far as Isaiah 24:19-20 are concerned, note the presence of the word "removed" in the immediate context of a dwelling (cottage). Remember, too, that the world, not the earth, is said to be immovable in Psalm 93:1. We see the fulfillment of this thought in Revelation 20:11 where it says of the earth:

And I saw a great white throne, and him that sat on it, from whose face the earth and the heaven fled away; and there was found no place for them.

The first heaven and the first earth* are replaced by a new heaven and a new earth. The transfer of the inhabitants amounts to a removal.

We might expect that if the earth is to move at the end times, that there might be some reference to the foundations of the earth

* So referred to in Revelation 21:1, "And I saw a new heaven and a new earth: for the first heaven and the first earth were passed away...." Note that this contradicts those who believe in a pre-Adamic earth, those who insist that this present earth is the *second* earth.

to emphasize the fact of that motion. Psalm 82:5 does give us such a reference when it states that the wicked:

know not, neither will they understand; they walk on in darkness: all the foundations of the earth are out of course.

The context of this passage, too, refers to the final judgment; for the Psalm begins with:

God standeth in the congregation of the mighty; he judgeth among the gods...

and it ends with:

Arise, O God, judge the earth: for thou shalt inherit all nations.

But what of Psalm 82:5's use of the phrase "out of course" with reference to the foundations? Does this not indicate that the present earth has a course and is moving? May we not conclude this even though the verse refers to the judgment? Does this not contradict the other verses which indicate that the earth is not moving? We might indeed be able to draw this conclusion if it were not for the simple fact that this verse does not speak of the earth being out of course but instead speaks of the *foundations of the earth* being out of course.

When it comes to the earth's foundations, we need only consider two: the underlying foundation, which is the Lord Jesus Christ himself, and the core of the earth. The context of the Psalm is the judgment. Christ came to earth to atone for the sins of man and thus to enable the salvation of anyone and everyone who would believe his sacrifice to be both necessary and sufficient. On those who do so falls none of the last judgment. Having the sin of the entire world imputed to him would most certainly be "out of course" for the sinless Jesus. Furthermore, in considering the nature of the earth's core, which is one of its "foundations," it is noted that there are fluid motions in the core of the earth. These

motions maintain, it is believed, the magnetic field of the earth. Major changes in the flows within the core of the earth can have serious consequences.

Technically, for life to persist, earth's magnetic field should be relatively strong. There are several reasons for this, but the most important is that the magnetic field of the earth deflects both the solar wind and cosmic rays. Both bombard the earth with high-energy particles akin to radioactivity. Without the magnetic field of the earth, the incidence of cancer is expected to rise dramatically. The earth's magnetic field is decaying at a rate that indicates it shall vanish in one or two thousand years. This, too, when applied to the earth's core, could be viewed as a foundation "out of course."

Historically, no heliocentrist has ever gone on record favoring Psalm 82:5 as proof for a moving earth; and there is good reason for this. No argument on behalf of a moving earth can solidly be based upon this verse. The context is all too clearly that of the last judgment, just as is the case for all Bible references to a moving earth.

Does Move Mean Move?

One could ask the question of whether the Hebrew word translated "move" actually means *move* in English. Of course it does, and the interested reader is referred to Appendix A for the details.

Conclusion

The end of the matter is this: the earth is not moving; it has a place of its own. But at the great white throne judgment, the earth will be removed; it will flee away and move for the first time in its history. After these events there will be a new heaven and a new earth: one which need not be sustained by the Lord in the same intense way that this present world is sustained; for that new world will have been bought by the precious blood of the Son of God.

⁶ And God said, Let there be a firmament in the midst of the waters, and let it divide the waters from the waters.

⁷ And God made the firmament, and divided the waters which were under the firmament from the waters which were above the firmament: and it was so.

⁸ And God called the firmament Heaven. And the evening and the morning were the second day.

— Genesis 1:6-8

6

THE BIBLICAL FIRMAMENT

It took more than a year and a half to write this chapter. Indeed, the work on this chapter stalled not only the progress on this book but also stalled work on other geocentric projects such as publication of *The Biblical Astronomer*. The only resolution was to start this chapter with an account of my personal struggles with the nature of the Biblical firmament, the firmament God created on the second day of creation. In this chapter, I shall give an account of my discovery that the *Planck medium*, also known as the “vacuum state of space” and sundry other aliases, such as “maximons” and “Wheeler’s space-time foam,” is the firmament God created on the second day of creation. I shall start with the thinking that led me to that discovery and then demonstrate from Scripture, history, linguistics, and science that the Planck medium *is* the firmament created on the second day of the creation week as recounted in the first chapter of Genesis.

The Irresistible Force Meets the Immovable Object

In 1971, while I was a graduate student at Case Institute of Technology, I feared that my concentration in astrophysics at the University of Rochester, followed by my graduate work at Case,

left me with some holes in my education. As a result, I enrolled at Cuyahoga Community College and signed up for two courses, one in psychology and another in logic. Both classes were taught by Case graduate students in their relative majors (psychology and philosophy), and last I heard of them, both were employed as cab drivers, something that I, also, did on two occasions after earning my doctorate.

All I remember of the psych class was one or two relaxation techniques and some of B. F. Skinner's imprinting works. I recollect more of the subject matter in the logic class, including truth tables and the difference between valid and sound logic—not all valid proofs are sound, but all sound proofs are valid. One of the lasting things I learned from my friendship with the two professors outside of class was the logical answer to the old question, "What happens when an immovable object encounters an irresistible force?" The logical answer is, "Everything." That explained many natural phenomena to me, most particularly the Bermuda Triangle where you have an "immovable object," namely the heat in the ocean, and an "irresistible force," namely the sun-driven wind. You end up with an "everything," *viz.* hurricanes and rogue waves in both the water and the atmosphere.

The solution to the question of what happens if an irresistible force meets an immovable object became a founding principle of my research for the next several years. I was coming out of atheism and at the time was more accurately described as an agnostic; I did not know whether God existed or not. I would be in that spiritual state until early 1973.

Attention Span

Here I will only mention my personal recognition of the concept of an attention span. I wrote about the concept and the experiments leading to the discovery of attention span several years ago and published the work in *The Biblical Astronomer*.¹ The theory, developed in 1972, considers all human reasoning to be circular, given our finite knowledge. The attention span is the circum-

ference (in seconds of time) of how long it takes an argument to go full circle.

Attention span complemented another key concept leading to the discovery of the firmament, namely, that theories are constructed around a vacuum state (i.e., a "hole") in our knowledge; something we do not know but wish to learn or discover. In physics, we usually try to discover the form of the hole by *formal* means such as *formal* logic, deriving *formulas*, *formal* definitions, etc. But formulas are not enough. The descriptive structure must also include linguistic structures such as phrases, clauses, sentences, paragraphs, chapters, etc. Christianity recognizes the "vacuum state" or the "hole in us" as the Word. In essence, the quest to fill a hole in our knowledge is a quest for a word or name that fits the hole. I have written at length about these matters also.²

Life on a Neutron Star

After finishing my doctorate work in March of 1973, I drove a cab for three weeks to save up enough money to move to the Monterey area of California. While there, the American Association for the Advancement of Science held its annual meeting in San Francisco. It just so happened that this particular meeting focused on Velikovsky's work, but that had no bearing on my reason to attend the meetings. I was obviously interested in astronomy and hoped to find work. As it happened, I decided to attend the session on condensed stars—stars that are so compressed by their gravitational field that a single teaspoonful would weigh hundreds of thousands of pounds on earth. One of those papers changed my concept of God.

The particular paper I refer to talked about neutron stars. As a star collapses under its own gravity or because the core of the star is pushed inwards by the explosion of an outer shell, the material in the star may get so compressed that the protons and electrons can no longer coexist but are squeezed together to form neutrons. A star in which this has happened is called a *neutron star*. The paper presented evidence that, at least near its surface, the neutrons

can organize themselves into structures analogous to molecules. The paper's reader proposed that these molecular-type neutron globs might evolve into a sort of nuclear life.

The idea that life could be evolutionary conceivable on a neutron star intrigued me. First, the reaction rates in nuclear processes are so fast that any such "life" would have evolved in seconds. Second, the conditions in a neutron star are analogous to the early conditions of the big bang. To me, that suggested that if life was present in the early stages of the big bang, it takes no great leap of faith to assume its presence before the start of the big bang. That further implied that the universe was created by a living entity, not by Chaos, the creator-god of Babylonians, pagans, and Humanists. That, dear reader was the end of my agnosticism. All I had left to do was to discover *which* of the millions of the world's gods was the Creator.

I didn't have to think long or explore very deeply to dismiss the man-gods such as the gods of the Hindus, Buddhists, Taoists, and humanists. Even the god of the Mohammedans I judged too small, for by instituting kismet (uncontrolled and unreasonable fate) Allah showed himself too small to control his own creation, especially since he "wound it up and walked away." That left only the God of the Jews, and, by extension, the God of Protestantism. Of course, all human-form gods were out, which meant that the Pope, God's substitute god on earth (Vicar of Christ), was too small, too; else why would God need a representative on earth other than himself, i.e., other than the Holy Ghost?

It took one reading through the Authorized Version from cover-to-cover and once more through the Gospels to convince me that the God presented there is the one and only God, the only one powerful enough to create the universe and still have no room for himself. My question of "Which of the gods is the Creator God?" was answered.

The Birth of Geocentricity

In 1976 I was introduced to the geocentric nature of the Holy Bible. Harold Armstrong, who was then the editor of *The Creation Research Society Quarterly*, in a note requesting tolerance for each other among Creationists, mentioned that some Creationists, such as Walter van der Kamp, even believed that the Bible teaches that the earth is stationary in the center of the universe. Although I knew very well that there was no proof for or against the geocentric universe, for me to take a stance on this issue I needed to be certain that there was no doubt in my mind that the Scripture is geocentric. At the time I was ignorant of the fact that the Authorized Version is the word of God, so my inquest on matters geocentric centered on the mythical "original autographs." The research consumed sixteen hours a day, six days a week, for three weeks and at the end I could only conclude that Scripture is probably geocentric.

I suppose, dear reader, that if we were face to face you might question, "Probably geocentric?" That is the strongest statement that anyone who believes that the inerrancy and inspiration of Scripture existed only in the original autographs can say. After all, we have never seen them and we don't have them anywhere that we should recognize them. The meanings of the words used in the original languages became obsolete in the eighteenth century when the original word definitions listed in previous Bible dictionaries were discarded, secularized, and redefined. The original autographs are obsolete; indeed, they no longer exist. By the same token, the meanings carried by the words of the manuscripts in the original languages have been corrupted. It is thus no wonder that all I could conclude was that the Bible is probably geocentric. The definitive geocentric verses can only be recognized if one assumes that God gave the Scripture by revelation and that he must and will preserve his words from corruption by man and will not allow counterfeit versions to be inerrant or inspired by the Holy Ghost and, indeed, the Holy Ghost is not even mentioned by them, let alone indwelling them.

Not long afterwards, I did find the strong geocentric verses such as Joshua 10:13. Having committed myself to the presence of an inerrant, preserved Bible from the start of my first pass of reading the Bible from cover-to-cover, I could only believe what was written. I had read the Authorized Bible, and in the course of my reading had proven it the inerrant, preserved word of God consisting of the very words of God. The die was cast; I became, and remain, a geocentrist.

The Plenum Æther

In 1977, after I had concluded that the Bible is geocentric, I searched the stacks of the University of Rochester's library for theories and research detailing what is known of the light-bearing medium commonly called the æther (now generally spelled as *ether*). The most useful book I found was called *Modern Æther Theory*, written by Harold Aspden of Cambridge University.³ Aspden's theory held that the ether is a plenum, an infinitely dense medium, uncreated, which is to say eternal and infinite in extent. Aspden's theory could account for several phenomena not easily accounted for in modern physics, such as the phenomenon called "ball lightning."

For several years thereafter I struggled with the obvious heretical implication of a plenum; that Aspden's ether has the properties of God and is thus indistinguishable from God. The problem is that such a plenum-ether should also have infinite energy or power (omnipotence), resulting in an infinite temperature that is clearly inimical to life. Aspden's plenum could therefore not be a true plenum. Still, Aspden's plenum model makes perfect sense as a light-bearing medium. After several years of mathematical and physical dead ends, I finally decided I would try using logic instead of mathematics to solve the plenum-God problem. As we shall see, that amounts to starting with God; however, it does not mean that logic is God.

The Irresistible Force, the Immovable Object, and God

Upon learning that the logical answer to the question, "What happens when an irresistible force meets an immovable object" is "everything," I recognized immediately that this answer related to the existence of God. Given the shortcomings of Aspden's plenum, I next applied the principle to the theory of geocentricity to solve the problem of how a true, uncreated plenum can coexist with a created plenum. My logic went as follows, and is as close as I can get to a proof for the existence of God.

Try to imagine nothing. We typically imagine darkness or some symbolic way of representing nothing, but to truly visualize nothing is physically impossible. No matter how hard we try, we cannot imagine ourselves out of the "nothing." It is impossible to picture nothing. Besides, we all know from Scripture that nothing is impossible.

So, if it is impossible to imagine nothing, let us try a different tack. This time, let's explore the properties that characterize nothing as a "thing."

1. *Does nothing have a size?* How big is nothing? We might think its size is zero, but that doesn't help, for zero size still has the property of size. Nothing cannot have the property of size.
2. *Does nothing have any power?* How powerful is nothing? Is it powerless, that is, it has no or zero power? But the property of zero power still has the property of power. We see then that our nothing cannot have the property of power, not even the property of powerlessness.
3. *Can nothing have any intelligence?* Can nothing be aware of its environment? If nothing were aware of its environ-

* Matthew 17:20—And Jesus said unto them, Because of your unbelief: for verily I say unto you, If ye have faith as a grain of mustard seed, ye shall say unto this mountain, Remove hence to yonder place: and it shall remove; and nothing shall be impossible unto you. Luke 1:37—For with God nothing shall be impossible. The sentence can be taken two ways, having two shades of meaning. In such cases, "given by inspiration" (II Timothy 3:16) demands that both be allowed unless doing so makes one or the other violate the integrity of Scripture. The modern double meaning of the word "gay" provides us with an example of such a violation.

ment, then it follows that its environment must be aware of it, in which case nothing becomes something. No, nothing can neither know nor sense; it cannot even have the property of intelligence.

4. *Can nothing exist?* It cannot exist because it can't have the property of existence.

We conclude that nothing cannot have any real properties whatsoever not even the property of "thingness," for if it did, it would no longer be nothing but a thing. We see then that nothing is impossible.

But when we say that nothing is impossible, aren't we saying it has the property of impossibility? Yes, that is the one property that nothing can have; it is impossible. If it is impossible, then its complement or inverse, everything, must be possible.

We started this section by examining the properties nothing can have. We noticed that nothing is impossible; it cannot exist. Existence, then, must have the inverse properties. These properties are:

1. For no size, the inverse is infinite size. We call that *omnipresence*.
2. For no power, the inverse is infinite power. We call that *omnipotence*.
3. For no intelligence, the inverse is infinite intelligence. We call that *omniscience*.
4. For no existence, the inverse is infinite existence. We call that *the Great I AM*.

So we see that since nothing cannot exist, we are left with omnipresent, omnipotent, and omniscient Existence. Those properties are the same as God's properties; so let's call the infinite existence before whom there was nothing and after whom there is nothing, *God*.

For the moment, let us focus on the nature of *omnipotence*. Omnipotence is infinite power, everywhere. By definition, omnipotence is omnipresent, for if omnipotence is not omnipresent,

then there exists a place where omnipotence has no power. In that place, the “omni-” (meaning *everywhere*) of omnipotence is violated and omnipotence is no longer omnipotent. We see, then, that omnipotence must be omnipresent.

Now omnipotence signifies infinite power, and power has certain properties. Consider another infinite property of God; God is light. Scripture tells us that no man can see God and live. Light has power, so omnipotence means that God’s light is also infinite in power. That means that the region in which the omnipotence of God is omnipresent has an infinite amount of light, and, by implication, is of infinite temperature. This, of course, brings us to the problem we had earlier, namely that the creation could not exist in a plenum unless God put aside such properties harmful to creation over a small volume (compared to infinity). Our problem thus reduces to how God restricted his light over the region of space we call the Universe to allow humans to exist long enough to accomplish God’s purpose for creation.

One of the properties associated with power is mass. That means that one of the properties of omnipotence is omnipresent, infinite mass. In other words, the omnipresent omnipotence of God requires that he be infinitely dense, where we use the word “dense” in the same sense that gold is denser than water.

History of the Plenum Model

The belief that space is infinitely dense is very ancient, dating back at least 2500 years to the ancient Greeks who, most likely, learned it from the Hebrews exiled in Babylon. The Greeks called it a *Plenum* because in a plenum every volume of space is fully—plentifully—as filled as any other volume of space. The first recorded mention of the plenum dates from the early fifth century B.C.

In the early fifth century B.C., a Greek philosopher named Leucippus put forth a scandalous proposal that maybe there was a limit to how small a volume of space could be cut and still have more matter therein. He proposed that at some small-enough scale,

a volume of space could not be further divided and still include matter. The volume at which that occurred would be the smallest particle making up the material of the universe. That particle he called an *atom* and thus came about the birth of atomic theory. Leucippus proposed that the physical universe is made up of atoms moving in a void.

The defender of the established plenum model, Parmenides, argued that since a void is full of nothing, any two particles would be separated by nothing and you'd be back at the plenum model. In hindsight, Parmenides and Leucippus were both right and we'll return to that later. For now, we observe that we started with nothing, found everything, and are ending up with a next-to-nothing void. The reader has probably recognized that the void is now called *vacuum*, and refers to outer space, where the average density is fewer than two atoms per cubic yard (or meter) of space.

For a few centuries the debate between plenum and the atomic theories raged until Greek philosophers concluded that the plenum model was impossible. After all, they reasoned, we could not move if we were encased in lead; how much less if we were encased in an infinitely dense medium. Thus, to this present time, atoms separated by a void became the predominant model of space.

Still, every now and then over the intervening two millennia, the plenum model would find new life...for a while. After all, the void is a terrible thing. It causes all sorts of problems. Consider the action-at-a-distance problem for gravity, for instance, particularly the case of two bodies attracting one another with a void or vacuum between them. What transmits the attraction between them? What mechanism communicates the presence of one body to the other? Is it a rain of some "bullet-like" bodies, much smaller than atoms, which press the two bodies towards each other? Or is it some sort of strain, like tension on a rubber sheet that is inherent in the void? If, so, the void must have some property able to transmit the strain from one body to the other; but if it has such a property, there cannot be a void between the two particles and the void would not be void. These questions and answers are known

as the action-at-a-distance problem, considerations which show that space cannot be a void. No wonder that the plenum refused to suffocate in the void's vacuum.

To solve such problems with an atomic-void theory, a new form of space-medium had to be invented. First, it was proposed that space was filled with tiny particles called *ultramundane corpuscles* that zipped through space in all directions. To account for gravity, it was assumed that solid bodies absorbed a tiny fraction of the particle flux which would press objects together by particle shadowing. This is Fatio de Duilier's (1664-1753) model (now commonly called Le Sage's model). It was embraced by Isaac Newton as the most likely cause of gravity since it avoided the action-at-a-distance problem of the void. Le Sage's version of the corpuscular model has been resurrected over the last 35-odd years by the talented heuristic mathematician, James N. Hanson, as well as by anti-relativists such as the late and to-be-lamented Apeiron Press' stable of authors who took these matters seriously.

Although the Le Sagean model solves the problem of action-at-a-distance for gravity and could accommodate the particle nature of light, the Le Sagean model could not account for the wave-like behavior of light. This came to a head in the nineteenth century when fundamental experiments with light revealed that light might be a wave instead of a particle. At that time, two physicists, Fresnel and Arago, definitively demonstrated that light behaved as a wave. Waves can only travel through a medium such as air or water. So it looked like there might be something more substantial than a void separating the atoms and corpuscles. A new form of space-medium was proposed specifically to account for the wave-like behavior of light. It is called the *ether*, signifying an intangible medium characterized by lightness and insubstantiality. You'd think that would settle the matter, but it didn't. To this very day, particle-like behavior of light continues to live side-by-side with wave-like behavior. (Le Sage's model and Hanson's work are covered more fully in Chapter 26 on Newton and Berkeley.)

Enter the Firmament

The recognition of the Biblical firmament began around 1898 when the German physicist, Max Planck, was toying around with the fundamental constants; that is, he was combining three constants (the gravitational constant, the speed of light, and the Planck constant) and found out that he could recombine them to define a set of fundamental units which he called "natural" units.* There is a natural unit of length, another of time, another of mass, another for electric charge, and still another for temperature (Table I). It looked as if Planck had discovered a new type of atom, making up a new type of medium. But his new atom is vastly smaller than the atom making up the atomic matter we all know and love. Planck's atom is generally called a *Planck particle*. The Planck particles are tightly compressed one against another forming a medium called the Planck medium. The question arises: are these natural units real or are they an artifact of our physics? I believe they are real because the properties they reveal about the firmament are too immense not to be real. The Planck medium has all the earmarks of being the firmament of Genesis 1.



Figure 1: Max Planck
(NRAO)

Is the Planck Firmament the Firmament of the Holy Bible?

Before we conclude that the Planck medium is the firmament of the Bible, we need to see if the word, firmament, is a proper

* You can create other sets of fundamental units by adding electric charge, e , but the original set of constants, G , c , and h are the most fundamental; so much so that they are sometimes called "God's units."

translation of the underlying Hebrew word. It makes little sense to assume the two are the same unless we find out why God needed to create the firmament in the first place. We will now show that "firmament" is the correct translation and that the firmament is a shield that protects us from the "consuming fire" that God is. It will also help us to ascertain the properties God demands of the firmament as a created plenum.

TABLE I
PROPERTIES OF A PLANCK PARTICLE

Length	$= (h G/c^3)^{1/2} = 1.616040 \times 10^{-33} \text{ cm}$
Time	$= (h G/c^5)^{1/2} = 5.390528 \times 10^{-44} \text{ sec}$
Mass	$= (h c/G)^{1/2} = 2.176570 \times 10^{-5} \text{ gm}$
Temperature	$= (h c^5/G)^{1/2}/k = 1.416859 \times 10^{32} \text{ K}$
Charge	$= \langle m \rangle^{1/2} \langle l \rangle^{3/2} \langle t \rangle^{-1}$ $= 5.62255 \times 10^{-9} \text{ gm}^{1/2} \text{ cm}^{3/2} \text{ sec}^{-1}$ $= (h c)^{1/2} = 11.7 \text{ esu}$

In this table, G represents Newton's gravitational constant, c the speed of light, and h is Planck's angular momentum constant; also, m is the Planck Mass, l is the Planck length, and t is the Planck time. Esu stands for "electrostatic units."

Let's imagine for a moment that we are God. We have something we would like to make known. Clearly, as members of the Trinity: the Father, Word, and Holy Ghost, we have perfect knowledge of all things, so there is nothing we can reveal to each other that we did not already know. However, being an omniscient, omnipotent God, we could create beings to whom we could reveal those things we already know about. The Apostle Paul states it this way in Romans 9:22-24:

²² What if God, willing to show his wrath, and to make his power known, endured with much longsuffering the vessels of wrath fitted to destruction:

²³ And that he might make known the riches of his glory on the vessels of mercy, which he had afore prepared unto glory,
²⁴ Even us, whom he hath called, not of the Jews only, but also of the Gentiles?

If, as God, we want to reveal these things, we first have to create a safe haven for both the vessels of wrath and the vessels of mercy; for since we, as God, are omnipotent, the energy density within us is infinite and would instantly consume any unshielded vessels we would create. We would have to make a space for those vessels of wrath and mercy (the heaven of Genesis 1:1) and then endue that space with provisions to sustain physical life as well as the foundations for wisdom and revelation (light) and then build a shield to protect the vessels we shall create inside the shielded region. I submit to you that said shield was made on the second day of creation and in English is called the *firmament*.

I don't know about you, but as a former professor of computer science, I've dealt with virtual reality quite extensively;^{*} and in my virtual ear I can hear a chorus of objections: "You blankety-blank-blank idiot! Don't you know that Bible scholars have proven that 'firmament' should be translated as 'expanse' and that there is nothing firm about it?"

Another virtual soul cries, "Heresy! Don't you know that the firmament was a water canopy surrounding the entire earth before the flood?" (That theory is now totally discredited by Creationists.)

Still another, secure in his liberalism, snickers: "Don't you know that the firmament is a reference to the ancient Egyptian cosmology, which Moses learned from his Egyptian schooling, where the sky is a star-studded dome, resting atop a circle of mountains and so covering the flat earth?"

Obviously, I don't know any of that.

I suppose we'll have to try to convince these virtual virtuosi with a little history lesson. But first I must deal with the charge by

* Indeed, I'm editing this chapter on a virtual computer, one of three that run on this laptop.

some that attributing physical properties to God is heresy. In particular, is the claim that God is a plenum heretical?

Heretical According to Scripture

The conclusion I was led to—that God is a plenum—is obvious in hindsight given that God is uncreated, eternal, omnipresent, and omnipotent. Still, the conclusion that God is a plenum is a bold one, not to mention fraught with danger, since some may consider it heretical. The problem is that it is perfectly reasonable, and the Lord does appeal to reason in Isaiah 1:18 when he says to Israel, “Come now, and let us reason together.” So, how did I reach the conclusion that claiming God is a plenum is not necessarily heretical?

To answer that we must first define the word *heresy*. Usually Scripture defines a word near or by its first use, and the first time the word heresy appears in the English Scripture is in Acts 24:14 where Paul is defending himself from the Jewish Pharisees and Sadducees before the governor, Felix. Paul confesses to Felix:

But this I confess unto thee, that after the way which they call heresy, so worship I the God of my fathers, believing all things which are written in the law and in the prophets.*

From the principle of first usage it follows that the accusing Jews’ definition of heresy is to believe all things which are written in the law and in the prophets; in short, to believe all things written in Scripture. Even today, the Jews consider belief of all things in the Bible as heresy, for the vast majority esteem the Talmud—

* Modern versions change heresy to sect. The Greek word is the same for both, so I consulted the Latin, using it as a commentary to meet the deficiency in vocabulary of the Greek language. The Latin texts use the word *haeresis* here, which is the very root word of our word, heresy. The Latin can distinguish between sect and heresy, the word *secta* meaning sect. The word heresy is thereby authenticated and the new versions’ “sect” is shown to be a dodge; an attempt to avoid the charge of heresy from Bible believers since the translators stand with the Jews *against* Paul’s confession.

layers upon layers of speculations and commentary—more authoritative than the Tenach (Old Testament). From the context of the verse we see that, scripturally, heresy hinges on faith in the written words of God. Furthermore, remember that Paul was, as he put it, “a Pharisee, the son of a Pharisee” (Acts 23:6).

But heresy lies in the eye of the beholder. The Church of Rome, for instance, declares anyone a heretic who rejects the declarations of its Magisterium, which is the teaching authority of the Catholic Church which, in turn, is said to be embodied in the current bishops of the Catholic Church in union with the Pope. He is branded a heretic whether he was ever a member of the Catholic Church or not. Those thusly accused of heresy face a possible death sentence. In kind, the Jews, too, were seeking the life of Paul before Felix. Most sects esteem heresy a sin worthy of death.

We see, then, that what the world deems heretical is to believe all of Scripture versus the world’s traditions: the traditions of men. However, that is not the Scripture’s definition of heresy. The definition of a heretic in the Bible is someone who knows correct Bible doctrine and knowingly rejects it by contradicting, countermanding, or “correcting” it. That means that what Bible believers consider heresy is for a believer to knowingly teach things contrary to Scripture. Under that definition, an atheist cannot be called a heretic for he makes no profession of believing Scripture, let alone faith in God unless he once espoused Bible doctrines. Furthermore, someone who unwittingly teaches something contrary to Scripture cannot be condemned as a heretic until formally confronted with his heretical belief two or three times (Titus 3:10-11).^{*} Note that even so, *ostracism* is the only penalty; there is no capital punishment to be imposed by man for heresy in the New Testament, not even for those who pervert the words of God (Revelation

^{*} Titus 3:10-11—A man that is an heretick after the first and second admonition reject; ¹¹ Knowing that he that is such is subverted, and sinneth, being condemned of himself.

22:19);* which is a form of the sin unto death (I John 5:16).† The Lord is the executioner in the Age of Grace.

In summary, a heretic is someone who knowingly teaches as Scripture something contrary to Scripture. Such people are usually enamored with an idea or a teaching which they consider a superior (meaning clearer, more understandable, or more authoritative) revelation than that given in Scripture.

The Physical Attributes of God

For several years I pondered the spiritual versus the physical nature of God. It was the mention of the power of God throughout Scripture and most particularly in Romans 1:20‡ that led me to serious contemplation that God not only has a body but also that the physical presence may be manifested in a variety of physical forms. The context of Romans 1:20 is that the eternal power and Godhead may be invisible, but they are made manifest in the creation.

When God created Adam he created Adam in the image of himself (Genesis 1:26-27).§ That image includes the triune nature of soul, body, and spirit, corresponding to the Father, the Word, and the Holy Ghost. As the scripture says, Jesus—in the flesh—is the express image of God (Hebrews 1:3).** How can it be heresy to take these things literally?

* Revelation 22:19—And if any man shall take away from the words of the book of this prophecy, God shall take away his part out of the book of life, and out of the holy city, and from the things which are written in this book.

† I John 5:16b—There is a sin unto death: I do not say that he shall pray for it.

‡ Romans 1:20—For the invisible things of him from the creation of the world are clearly seen, being understood by the things that are made, *even* his eternal power and Godhead;

§ Genesis 1:26-27—And God said, Let us make man in our image, after our likeness; and let them have dominion over the fish of the sea, and over the fowl of the air, and over the cattle, and over all the earth, and over every creeping thing that creepeth upon the earth. So God created man in his *own* image, in the image of God created he him; male and female created he them.

** Hebrews 1:3—...being the brightness of *his* glory, and the express image of his person, and upholding all things by the word of his power....

There are two reasons why people believe that God has no body or form. The first is derived from Gnosticism and the second is based on a misunderstanding of the nature of spirit. Neither is sound.

Gnosticism is the belief that the flesh in particular and matter in general is innately evil. This is based on Plato's philosophy that the idea of something is good (ideal) but the physical form, which is subject to corruption and decay, is not. For instance, the idea of a table, in the mind of its inventor or builder, is good, even immortal in a sense; but the ideal, when implemented in the physical world, is subject to corruption and is thus evil. This rationale for Gnosticism appeals to a certain type of intellectual who then carries said rationale further and concludes that since matter is vile, God would never have manifested himself in vile flesh because if he did, he would have corrupted himself and would no longer be God.

Today, this type of individual is at home with liberalism; and I might add that modern liberalism dates back at least as far as the time of Hezekiah (Isaiah 32:5-6).³ Indeed, religious liberals believe that Gnosticism was the original Christianity and that the New Testament was written a couple centuries after the "historic" Jesus. They believe this because I, II, III John and Jude were written against Gnosticism. But if the New Testament was written in the first century, then Gnosticism could not be the original Christianity but has to be the first Christian heresy. There is, of course, no proof that the New Testament was written after the first century, especially since fragments of the New Testament were found in the Qumran caves sealed circa A.D. 70.⁴

We now undertake the second reason why people discount the physical body of God. One of the most commonly misunderstood properties of God involves that God is called a Spirit in John

³ Isaiah 32:5-6—The vile person shall be no more called liberal, nor the churl said to be bountiful. ⁶ For the vile person will speak villany, and his heart will work iniquity, to practise hypocrisy, and to utter error against the LORD, to make empty the soul of the hungry, and he will cause the drink of the thirsty to fail.

4:24.* Most people see a spirit as a disembodied, amorphous thing that has no form or physical representation. However, that is not what Scripture teaches; it teaches that spirits do have bodies.

Scripture teaches that the spirit of man comes from God and returns to him at death (Ecclesiastes 12:7).† The spirit is given us by God in order that we may have a conscience. The soul, however, is in charge. Thus sin is attributed to the soul. Man's body dies because of Adam's sin; the soul dies for rejecting God's atonement for sin. Man's spirit, which is a portion of God's spirit, should be in charge. Indeed, to be born of the Spirit, of which Jesus speaks in John 3:5, means to allow the Spirit the leadership; thus, any man who wants to worship God "must worship him in spirit and in truth" (John 4:24). The ultimate Spirit is the Holy Ghost, the third person of the Trinity. The spirit is immortal, not the soul, and obviously, not the body. People thoughtlessly talk about "your immortal soul," but the Bible knows nothing of that. Scripture teaches that, "The soul that sinneth, it shall die" (Ezekiel 18:4, 20). So neither the body nor the soul is immortal but the spirit.

The basis for this idea that the spirit has no body or form comes from Luke 24:37-43 where the resurrected Jesus tells his disciples, who were frightened by his sudden appearance among them, not to be afraid:

³⁷ But they were terrified and affrighted, and supposed that they had seen a spirit. ³⁸ And he said unto them, Why are ye troubled? and why do thoughts arise in your hearts? ³⁹ Behold my hands and my feet, that it is I myself: handle me, and see; for a spirit hath not flesh and bones, as ye see me have. ⁴⁰ And

* John 4:24—God is a Spirit: and they that worship him must worship him in spirit and in truth. Modern bibles greatly err when they drop the "a" from "a Spirit." By doing so they allow that all spirits are God; even lying spirits and the spirits of devils. These unclean spirits were created by God, but they are not part of the holy Spirit nor of the Holy Ghost.

† Ecclesiastes 12:7—Then [upon death] shall the dust return to the earth as it was: and the spirit shall return unto God who gave it.

when he had thus spoken, he showed them his hands and his feet. ⁴¹And while they yet believed not for joy, and wondered, he said unto them, Have ye here any meat? ⁴²And they gave him a piece of a broiled fish, and of an honeycomb. ⁴³And he took it, and did eat before them.

Jesus does not say here that a spirit has no body or form; he says that a spirit's body is different from the resurrected body he has. We learn here that whereas a spirit has a visible form, it cannot be handled physically.

Indeed, Zechariah 12:1 tells us that a spirit does have a form and that God forms it inside each of us.^{*} Of course, Zechariah's reference to a form is general; it does not specify the exact shape. Angels are called ministering spirits and there is no doubt in Scripture that they have bodies (Hebrews 1:13-14),[†] but the Holy Ghost is seen in the bodily shape of a dove at the baptism of Jesus (Luke 3:22).[‡] In Matthew 14:26[§] the disciples mistook Jesus, who was walking on the water, for a spirit. Jesus did not correct them to say that spirits are invisible or that they don't exist, and so the implication is clear; spirits do have a form and corporeal presence.

But that a spirit does have a form is not all; it also has a corporeal presence. Scripture tells us of God's form and body through the many mentions of God's face, his hands, and even his wings. Moses saw God's back parts, albeit not his face for that would have killed Moses (Exodus 33:20-23). Clearly, if God has back

^{*} Zechariah 12:1—The burden of the word of the LORD for Israel, saith the LORD, which stretcheth forth the heavens, and layeth the foundation of the earth, and formeth the spirit of man within him.

[†] Hebrews 1:13-14—But to which of the angels said he at any time, Sit on my right hand, until I make thine enemies thy footstool? ¹⁴ Are they not all ministering spirits, sent forth to minister for them who shall be heirs of salvation?

[‡] Luke 3:22—And the Holy Ghost descended in a bodily shape like a dove upon him, and a voice came from heaven, which said, Thou art my beloved Son; in thee I am well pleased.

[§] Matthew 14:26—And when the disciples saw him walking on the sea, they were troubled, saying, It is a spirit; and they cried out for fear.

parts that can be seen, he must have some form, even a physical presence.

Now it can be countered that God is invisible as stated in I Timothy 1:17 and Hebrews 11:27. However, invisibility does not mean that the invisible thing has no form or matter. A mirage is due to an air layer that is invisible but the reality of its physical presence is manifest in the mirage. It seems reasonable that God should be invisible so that no one could accidentally look upon his face. After all, there are things invisible. The wind has certain invisibility, but it is physical. Likewise, the firmament is invisible, but it certainly has substance. Visibility is a human requirement. Jesus said he had seen the Father, the Godhead, (John 6:46);* and lest you think he saw through some mystical spiritual eyes, consider John 14:9 where Jesus says to Philip, "he that hath seen me hath seen the Father." At the time, the disciples were blind when it came to spiritual eyes. Clearly God has a body in the person of the Lord Jesus Christ who came in the flesh (I John 4:2-3)[†]. Paul calls this a mystery in I Timothy 3:16 where he writes:

And without controversy great is the mystery of godliness: God was manifest in the flesh, justified in the Spirit, seen of angels, preached unto the Gentiles, believed on in the world, received up into glory.

Consider the Trinity for a moment. The Father corresponds to the soul, the Word is the body, and the Holy Ghost is the Spirit. The Holy Ghost bears witness of the Word, and the Word bears witness of the Father. The Word came physically in written form in the Old Testament, then physically in the flesh in the person of

* John 6:46—Not that any man hath seen the Father, save he which is of God, he hath seen the Father.

[†] I John 4:2-3—Hereby know ye the Spirit of God: Every spirit that confesseth that Jesus Christ is come in the flesh is of God: [†]And every spirit that confesseth not that Jesus Christ is come in the flesh is not of God: and this is that spirit of antichrist, whereof ye have heard that it should come; and even now already is it in the world.

Jesus, the Christ, and then physically in writing again in the form of the New Testament. His final revelation will come when God's wrath is full, at which time Jesus will inherit the kingdom of heaven, that is, the restoration of Israel. This all implies God has a physical presence, a body, in other words.

Finally, I Corinthians 15:44 explicitly states that a spirit has a body,

There is a natural body, and there is a spiritual body.

A man greatly errs when he claims that a spirit has no form or body. So there is no reason why God cannot be described by the word plenum. It is no heresy then to describe God's omnipotence as a plenum.

It was not until I understood the fundamental principles underlying these matters that I felt safe in allowing that God is a plenum. However, I knew from the start that Harold Aspden's impersonal plenum, mentioned early on in this chapter, couldn't be the true plenum because a plenum is more than physical; it must embrace all, including the metaphysical or spiritual realms. In other words, for you technical readers, the mathematics describing the plenum must be complex. (For those of you who survived two years of high school algebra, complex means it must involve imaginary numbers as well as real numbers.)

Linguistic Arguments for a Solid Firmament

The creation of the firmament takes place on the second day of the creation week. In Genesis 1:6-8 the Scripture records the event as follows:

⁶ And God said, Let there be a firmament in the midst of the waters, and let it divide the waters from the waters.

⁷ And God made the firmament, and divided the waters which were under the firmament from the waters which were above the firmament: and it was so.

⁸ And God called the firmament Heaven. And the evening and the morning were the second day.

Now, there is nothing in the account that requires the firmament to be a *hollow* shell, an expanse.* Yet modern scholarship confidently informs us that the word, "firmament" hearkens back to the cosmologies of ancient Egypt and Babylon. To those peoples, the sky was a shell, particularly a hemisphere that covered the

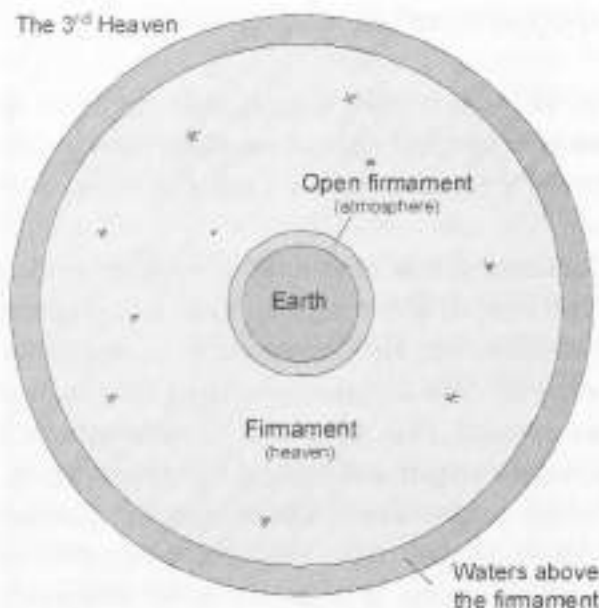

Figure 2: *The Scriptural Firmament*
(Not to scale)

disk of the flat earth as the dome of a serving dish covers the pheasant.

Truth is, I've never been able to confirm the firmament-is-a-shell model in the source documents of any ancient Mid-Eastern cosmology. The closest I've come is the story of Nut, the night-sky goddess who is often portrayed as a naked female stretched across the sky; Nut

swallows the sun on the first day of spring when he enters her mouth, the sun then passes through her star-studded body to emerge from her birth canal nine months later. Other accounts have the birth-death process happening daily. In either case, it is interesting to note that the only way Nut, the creator-mother of

* An interesting thing happens as one draws closer to the edge of the firmament. The firmament's protection of atomic matter fades away so that its extreme density and temperature become manifest. The firmament is impregnable solid at its edge, in effect acting as a shell. This is the reason why the wording of Scripture is somewhat ambiguous when it comes to the concept of the firmament.

Egypt's god, could eat the sun without using her hand is if the sun were a wafer, in which case she need only tilt her head from the position pictured in temple depictions. This is the closest that Bible critics are able to come to support their claim that Moses' firmament heralds from Egyptian cosmology.



Figure 3: Nut about to swallow the sun in spring

The most ancient Egyptian explanation for the universe is that each day the sun embarks and sails across the sky in his eternal bark trying to keep peace and joy in the world. But every evening, after the sun disembarks, the great primordial lotus blossom closes its petals and sinks once more into the waters of the abyss. Darkness reigns throughout the night until the sun god within the lotus is reborn in the morning. Then the lotus rises to the surface of the deep, opens, and the young sun embarks his bark to start

the journey all over again. Just what Moses included from these stories into his creation account of the firmament escapes me, but apparently not the virtuosi.

The dish interpretation of "firmament" dates from the eighteenth century when all the Bible dictionaries were secularized and rewritten. Languages such as Hebrew, Latin, Greek, and English have sacred, as well as secular forms. (The English sacred form survives today in the *Authorized Bible*.) Each sacred language is designed solely to embody the Scripture in that language and is considered sacred to its faithful and not to be corrupted by secularists.

In the eighteenth century, however—as a direct result of the Copernican Revolution’s success in removing the authority of the Bible from the physical realm—there arose a movement whose goal was to “recover” and “correct” what God physically “meant” to say but did not have the wits to say correctly in the first place. The movement, commonly known as “higher criticism,” rejected the established theology that God had given man his words by *revelation* and that God would actively *preserve* his words, even his Bible through his seed. Instead, the critical movement embraced the notion that the Scripture which was given by inspiration of God now exists inerrantly only in heaven and must be *recovered* by a class of *virtuosi* since only they esteem themselves equipped to recognize that which God had given by inspiration but didn’t think worthy of preserving in the first place.

It was this movement with their assumption that only the “book of Nature” is inerrant, that set about to secularize the meanings of the sacred languages by adding, or replacing, or re-coloring the sacred meanings of the Hebrew, Greek, Aramaic, and Latin words with secular meanings. That way these theologians could appear scientifically and historically “respectable.” Most of those *virtuosi* appealed back to pagan cultures to extract the so-called “correct” meaning which God was unable to preserve. And so it came to pass that *firmament*, a word that suggests a solid medium, was replaced with a hollow, metal shell covering a flat earth.

Historical Precedence for the “Firmament” Translation

Now the word “firmament” is a translation into English of the Latin, *firmamentum*. In classical Latin, the word means “something which strengthens or supports.” That was how the underlying Hebrew word, *raqija* was translated into the *Old Latin Bible* around A.D. 130. About twenty years later, ca. A.D. 150, Aquila did his translation of the Old Testament into Greek. He translated *raqija* as *stereoma*, which properly means a firm or solid structure. In Hebrew, the root word underlying *raqija* is *raka*, meaning to

condense, to make firm or solid. These translators apparently support the solid firmament model.

All English translations up through the AV, including the *Douay-Rheims*, chose "firmament" for their translation although most European translations render the Hebrew as "expanse." The latter word is neutral, allowing for either the hollow shell or solid model. Add to that the debate between Leucippus and Parmenides about the plenum vs. atom models, which established the plenum model as the most ancient cosmology, and the linguistic support for the firmament model is secured.

The Firmament As a Created Plenum

Before we consider the firmament as a created plenum, we need to appreciate some of the properties of the Planck particles which make up the "atoms" of the firmament. It is hard to comprehend how tiny a particle of firmament is. If we were to enlarge a Planck particle to the size of a typical marble (about 1 cm), the diameter of the marble would be enlarged to more than 12,500 universes laid side-by-side.⁵ Or, if we were to enlarge the Planck particle to the size of a hydrogen atom, the hydrogen atom would span some ten million earths laid side-by-side, engulfing the entire orbit of Neptune far enough to encroach Pluto's orbit.

Likewise, how much larger is the largest stable nuclear particle we know, the proton, than a Planck particle? A proton's size is 1.32×10^{-13} cm.* Compared to the 1.62×10^{-33} cm size for the Planck particle, the proton is some 10^{20} or one hundred thousand trillion times larger than that of a Planck particle. The figure 10^{20} is said to be "twenty orders of magnitude." Of those twenty orders of magnitude, we are clueless of at least eighteen of them (the Higgs boson is about one-hundredth the size of a proton but its existence has yet to be confirmed). Those twenty orders of magnitude are not

* For the remainder of the book, the reader who has no sense of the size of a centimeter may think of a centimeter as a bit less than half an inch. Given the nature of the calculations and the uncertainties in both the mass and size of the universe, you could as well read, "inch" instead of centimeter.

empty, mind you; they are packed with Planck particles, as is the entire universe, as well as every atom, and every fundamental particle. (See Figure 4.) Those twenty orders of magnitude provide a buffer between atomic matter and the matter constituting the firmament. The heat of the firmament (a hundred-million-trillion-trillion degrees) cannot penetrate it, nor can the extreme density of the firmament be felt by the atomic matter making up our universe. The Planck particles are too small to directly affect the universe in general and us in particular.

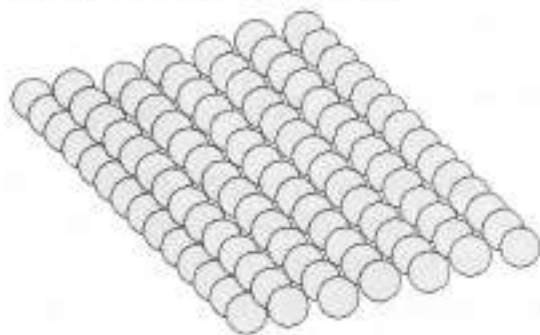

Figure 4: *Two Layers of Planck Particles*
(Figure by Martin Selbrede)

Now, like any good particle, the Planck particle has a mass as well as a size. In this case, the mass is only a couple of hundred-thousandths of a gram (there are roughly 27 grams in an ounce). With a size and a mass, we can compute the density of a Planck medium, that is, the density of the firmament. When we run the numbers, we find that the density of the Planck particle, which will roughly equal the density of the firmament, is about 4×10^{93} grams/cm³.^{*} In comparison, the mass of the universe is estimated at 6×10^{56} gm.[†] That means that if we packed the entire universe into one cubic centimeter—about the size of a small sugar cube—then we would have 56 of the 93 zeroes in the exponent making up the density of the firmament. We'd have to keep packing more and more universes into the sugar cube until we've packed in some 10^{37} universes. Yes, the density of the firmament is 10^{37} universes per cubic centimeter. If the firmament is the same size as is currently estimated for the universe, (a radius of 2×10^{28} cm) then the firmament's mass is a whopping 10^{123} uni-

^{*} 4.220×10^{93} assuming a Planck particle has a spherical shape. If we assume the Planck particle is a cube, the density is 5.128×10^{93} gm/cm³.

[†] Assuming a universe's mass is 6×10^{56} gm (based on the baryon count).

verses. Clearly, the firmament is by far the most massive object that God created during the creation week.

We've previously noted that the Planck particle's mass is 2.2×10^{-5} gm and that its size is 1.62×10^{-33} cm. Also, the particle is electrically charged with a charge of 11.7 esu, meaning that the charge of a Planck particle is almost twelve times the charge on an electron or a proton. It is that charge that is the target of the various "perpetual motion" zero-point-energy machines promoted on the Internet. The firmament's electric charge property is also at the core of Harold Aspden's plenum theory of the ether. Significantly, the Planck particle has no magnetic properties. To me, this implies that the electric fields in the universe will exhibit wave properties while magnetic fields will foster particle properties.

In Table 1 (pg. 64), which tabulates the Planck particle properties we see that the Planck particle is on the hot side. The Planck particle has a temperature of 1.4×10^{32} K. It so happens that the "black-body" radiation curve of a body at the Planck temperature has its peak at the Planck length.* For comparison, the black-body peak for the temperature of the universe is located at 2.7 K and is called "the cosmic background radiation."

So, why are we not instantly vaporized by the firmament? Two reasons: firstly, the Planck particle is the size that a particle of a Planck mass (2×10^{-5} gm) would have if it were compressed into a black hole. That implies that the surface of a Planck particle will behave similarly to a black hole, namely, that no light, heat, or radiation can escape from it. Even though the Planck temperature is of the order of 10^{32} Kelvins, none of the radiation can escape the surface of the particle. Secondly, even if radiation were to escape from the surface of a Planck particle, its wavelength is far too short—by twenty orders of magnitude—to affect the universe of atoms. Besides, it is simply reabsorbed into the firmament before it travels more than a Planck length or two. As a result, we are

* You may be familiar with the normal curve such as we find in the counts of IQ scores. The energy of photons similarly pile around a peak which is called the Planck temperature. The curve traced out by the photon counts is called the *black-body radiation curve*.

quite safe from being vaporized by the firmament...at least for now.

Clearly, the firmament is by far the most massive thing God created. Its mass is estimated at 2×10^{179} gm. Is it any wonder, then, that the firmament dictates the physics of the universe?

But if the firmament is that dense, how can we move through it? It was the atheist Bertrand Russell who answered that question. He discovered that in a true plenum motion could exist provided it is cyclical and the plenum and its motions are eternal and uncreated.⁶ But the firmament is not a true plenum, so how can we move through it? The answer is that the universe of atomic matter must perceive the firmament as if it were a true plenum. Likewise, the motions allowed through the firmament must *all* be cyclical. Thus all atomic particles behave as waves. Waves are cyclical and so are allowed to move through a plenum. In the firmament's case, the wavelengths of the atomic particles and photons are too long for the firmament to detect them, just as the wavelength of light is too long for the molecules of glass to detect and absorb them. In turn, any straight-line motion through the vacuum of space cannot be detected by the firmament.

All particles act as waves insofar as the firmament is concerned. A particle at rest relative to the firmament acts as a standing wave (the type of wave started by plucking a guitar string) and its wavelength is called a "Compton wavelength." For instance, the Compton wavelength of a Planck particle is a Planck length. For a particle moving through the firmament, its wavelength is known as the "deBroglie wavelength." The moving wavelength of a particle is shorter than its static, Compton wavelength. As a nuclear particle moves faster and faster through the firmament, its energy increases which makes the particle appear more and more massive.* Likewise, its wavelength gets shorter and shorter. Once the nuclear particle's energy-laden mass approaches the Planck mass and its wavelength approaches a Planck length, the nuclear particle and the Planck-particle ocean detect each other; and the

* Remember, $E=mc^2$; energy is mass and mass is energy.

hapless moving particle, now traveling close to the speed of light, is absorbed into the firmament.

Earlier we saw that the Compton wavelength of a proton (that is, its size) is about 20 orders of magnitude longer than that of a Planck particle. We know next to nothing of the spatial properties in those 20 orders of magnitude, but we do know that it is filled to capacity with the stuff of the firmament. To allow motion through a dense, created plenum, it is sufficient that the particles' wavelengths be very much longer than those of the particles making up the created plenum. Twenty orders of magnitude minimizes the chance that the proton and Planck particle will ever sense each other unless the proton moves so fast that its effective mass approaches the Planck mass, at which point the proton will be absorbed into the firmament. Those two conditions, the huge difference in wavelengths between Planck particle and proton and the resistance a mass encounters as it moves faster and faster through the firmament, serve to guarantee that no nuclear particle can ever be detected by the firmament and vice-versa. That, in turn, means that we can move freely through the firmament.

In the ways we have outlined in the previous paragraphs, we see that—to atomic matter but not necessarily to mankind—the created firmament is indistinguishable from God, who is the true, uncreated plenum. We end up with a true, infinitely dense plenum, which is a property of the omnipotence of God, and a created plenum, the firmament, which serves as a barrier between God and us to shield us from God's omnipotent properties. In that sense, the firmament is a false god. For two reasons: first, the firmament's function as a barrier between us and the loving mercy of God, and second, its God-like property, God did not declare the firmament "Good" in the day that he created it (Genesis 1:8).

Light and the Firmament

What about light waves and the firmament? Earlier we saw that the ether, an ephemeral concept, was postulated solely to ac-

count for the propagation of light. Can the firmament be responsible for the transmission of light? The answer is, "Yes."

At least three types of waves can exist in the firmament. These are: *transverse waves*, *longitudinal waves*, and *thermal waves*. Whether or not these waves actually occur in the firmament will not be argued here. Let me just state that in the firmament these waves are mechanical, not electromagnetic, although their appearance in the universe of atomic matter will likely be electromagnetic. Thermal waves are not relevant to this report although they possibly play a role in the firmament's shielding function.

Transverse waves are waves that manifest themselves in two dimensions. A rope tied to a doorknob and then shaken up and down is a transverse wave. Light is also a transverse wave. When the standard classical expression for transverse waves is applied to the firmament, the speed of the wave equals the speed of light to at least five significant digits. This implies that the firmament plays a pivotal role in the transmission of electromagnetic waves through space. It also means that the firmament dictates the physical behavior and properties of light waves.

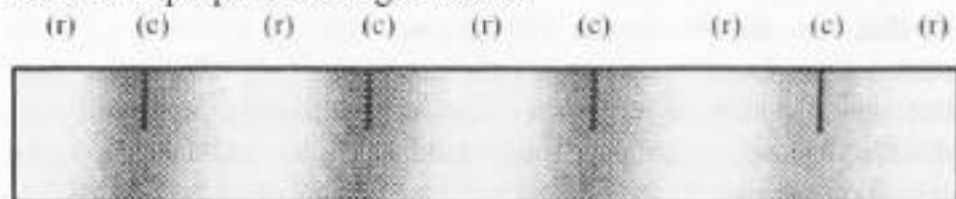

Figure 5: A Longitudinal Wave

Longitudinal waves are compression waves, such as sound waves or shock waves. This waveform squeezes particles together into a region of high pressure (compression). The compression depletes the surrounding areas of particles. That creates a void, a low-pressure area (rarefaction) on both sides of the high-pressure area (Figure 5). The particles pushed back into the low-pressure area are compressed to a high-pressure area, and the process repeats itself by radiating outwards from its source. A slinky is an example of a longitudinal wave.

If we consider the compressed volume of the longitudinal wave to have the pressure of the firmament and the rarefaction volume to have the average pressure in the universe, then the speed of longitudinal waves through space is 3×10^{39} cm/sec, which is 10^{29} times the speed of light. At that speed, the signal crosses the universe in roughly 10^{-11} second or one one-hundred-billionth of a second. A longitudinal wave of this sort is unknown to modern physics. It could be a fundamental temperature wave, or a wave that travels in the scale-dimension. These things are well beyond the scope of this book. In any case, a frequency of 10^{11} cycles per second (Hz) is, in my opinion, the likely cause of the cosmic microwave background radiation, or temperature of the universe. Modern astronomers believe that radiation is left over heat from the big bang.

It is clear that there is a relationship between the firmament and the speed of light. Most likely, the firmament is the light-bearing medium, the "ether" for which physicists and astronomers alike have searched. According to the observed behavior of light, the earth stands still in the universe. That observed behavior of light means that we no longer need to postulate the existence of ether as the conductor of light; the firmament fits that bill. It is not clear how the firmament controls gravity, but as the firmament has the property of omnipresence insofar as the material universe is concerned, as such, gravity may be due to pressure-dynamics within the firmament itself.

Modern Interpretations of the Firmament

To show that the firmament model is the superior model of the Planck medium today, we need to show that the modern interpretations thereof are flawed. So, let's look at today's secular interpretations of the firmament.

At present, the firmament goes under many different names. Some of these are: *vacuum state*, *Planck medium*, *spacetime foam*, *zero point energy (ZPE)*, and *Markov's maximon fluid*. The particles making up the firmament's medium also have various names.

Most prominent among them are: *Planck particles*, *maximons*, *massive superstrings*, and *virtual particles*. All these aliases for the firmament and its particles suggest that there is no consensus among cosmologists on the nature of the firmament.

The most common interpretation of the firmament is the vacuum state theory. That theory claims that the firmament is a sea of "virtual particles." According to the theory, a virtual particle, which we've referred to as a Planck particle, is said to pop into existence from nothing, persist for a Planck time (about 5×10^{-44} sec.), and then pop out of existence again. The firmament is thus pictured as an ocean of fictitious particles ceaselessly popping in and out of existence. The popping region is referred to as "space-time foam." In the firmament model, the particles are *real*; their existence is permanent, not ethereal or transitory as are the virtual particles of modern cosmology.

It turns out that the space-time foam of virtual particles does not behave as required by theory. On such a tiny scale, the mechanical motions of the virtual particles popping into and out of existence fluctuate so violently, so randomly, and so energetically, that all kinds of bizarre structures, such as wormholes,* develop. But there is no limit to the size that these structures can have, so if the virtual spacetime-foam model is correct, then these strange structures should grow larger and larger and should readily be detected, yet none are detected.

The result implies that the particles are real, not virtual. It is the popping into and out of existence that causes the instability because the virtual particle model is unstable to *real* constraints. If the particles are real, however, their constraint is one of detectability, not one of existence; that is, the particle is only visible at a Planck time. We conclude that the firmament's Planck particles are real particles having a real existence and that consequently, the firmament is real.

Now some may wonder what my view is on the phenomenon that is interpreted as space-time foam. I see this as the particle so-

* Wormholes are tunnels in space-time joining two distant regions in the universe or parallel universes.

lidifying from the future into the past where the particles are deposited into 8-dimensional sheets I call time sheets.⁶ Entropy (you may find it easier to think of entropy as information, knowledge, or history), from the future, present, and past, is heated to the Planck temperature by the energy flowing from the past through the present. When the Planck temperature is reached, the entropy becomes a Planck particle at which time the information or present state is frozen into the particle as it collapses into its black hole status. This happens at the same time throughout all the volume of the universe. The 8-dimensional holographic sheet is deposited onto the stack we call the past, and it disappears 5×10^{-44} seconds later when the next sheet solidifies on top of it. Note: no particles popped out of existence in this theory. In effect, the kinetic energy (energy of a moving body) of the firmament keeps the process going. The entire process of time takes one Planck time and repeats itself 2×10^{43} times every second over the entire volume of the firmament.[†] The formation of these sheets requires light and gravity, both of which are not subject to entropic decay.⁷

Rotation of the Firmament

Experimental evidence shows that the firmament rotates once every 23 hours and 56 minutes with the earth located at the dynamic center of the firmament. If the firmament were not rotating in the true plenum, then there would be no way to distinguish it from the true plenum and the creation would instantly vaporize. The rotation fulfills Russell's requirement that only cyclical motion is allowed.

⁶ The 8-dimensional theory of the firmament is called *Topological Geometro-dynamics*. It views each sheet as the projection of our 4-dimensional universe onto a plane with two imaginary (involving the square root of negative one) axes.

[†] Parallel universe theories would say 10^{37} times per second. It is no coincidence that the density of the firmament is also 10^{37} universes per cubic centimeter. Parallel universe advocates actually believe that the many universes are spawned by the firmament each second. Atheistic cosmologists hold to the many universes (multiverse) model while those who believe in God believe there is only one universe.

If we design an experiment to measure the relative rotation of earth and firmament, we get a positive result. The first to do the experiment was Georges Sagnac who conducted it in 1904. Sagnac did find evidence that can be interpreted as the ether rotating about the earth, but it can equally well be interpreted that the earth rotates in the firmament. There is presently no way to distinguish whether the earth rotates in the firmament or the firmament rotates with the earth on its axis. The only way to tell is to go outside the universe and compare the motions in the universe with the status there. The observed rotation period is 23 hours 56 minutes, a sidereal (star-rise to star-rise) day, as opposed to a solar day of 24 hours (sun-rise to sun-rise).

Let's make sure we have this straight. When scientists conduct experiments to determine the speed of the earth moving through a light-bearing medium, its speed registers zero. To account for this, we are given several "just so stories,"⁸ of which I shall list only three. We are told that there is no light-bearing medium, so we cannot measure any speed. Or we are told that the speed registers zero because the motion of the apparatus shrinks in the direction it is moving. Or physics conspires to make it look as if the earth is at rest in the midst of the firmament. On the other hand, if we conduct an experiment to discover the relative speed of *rotation* of the earth through the light-bearing medium, we get a positive result. For some reason, the motion of the apparatus is *not* shrunk by its relative rotational speed through space and the scientists are as silent as a turkey farm on Thanksgiving as to why the same experimental principle works for rotation but not for orbital motion.

The most obvious explanation for these two experimental results is, for the first experiment, that the earth does not move through the firmament. Thus all experiments designed to detect that motion will fail because the firmament anchors the earth in the

⁸ The *Just So Stories for Little Children* was written by Rudyard Kipling and published in 1902. The book is a collection of fantastic stories of how animals got certain features. Today, a "just so story" is a fanciful or *ad hoc* explanation for the origin of a thing.

dynamic center of the firmament. To those who accuse physics of "conspiring" to hide the motion of the earth through space I ask, "What's the difference between a conspiracy of physics or reality? There is no difference; in either case, the earth is at the dynamic center of the firmament that controls the physics. (For the rotation experimental result, see Chapter 35, "Rotation" for details.)

The Barycenter

So far I've been calling the place of the earth as located at the dynamic center of the firmament. But there is another term meaning the dynamic center, which is *barycenter*. You see, it never happens that a lighter object revolves around a heavier object; both revolve around their common center of mass, the barycenter. The barycenter is merely a point in space, somewhere between the orbiting bodies, around which each body revolves. Thus there is a barycenter about which the sun and Mercury both orbit with a period of 88 days. There is a different barycenter about which the sun and Jupiter orbit with a period of 11 years, and so on for every planet. For the solar system, for instance, the barycenter is not very far inside the sun. The sun's orbit around that barycenter is complicated; it is not a clean orbit.

If the earth is at the barycenter of firmament and universe, then the gravitational fields of the firmament, universe, and earth are superimposed upon one another. Any attempt by the universe to dislodge the earth or alter its rotation or position will be opposed by the firmament as an attempt to detect and move it. The firmament will resist the universe's attempt to move it by transferring the reaction to the universe which is the lightest thing perceived by the firmament. The firmament's reaction to the universe's imposition thus appears to be on behalf of the earth which is located exactly at its center. This behavior is akin to how a gyroscope rights itself back to its original path when deflected by changing the orientation of its axis.

Conclusion

We have ranged far and wide in this chapter, starting with nothing, and finding everything by taking the inverse of absolute nothing. We found that the everything had the particular properties of an infinitely dense medium called the *plenum* and discovered that these properties are identical to the properties of God: omnipresent, omnipotent, immortal, and omniscient and so can be identified as God.

From there, we looked at the history of the plenum and void models of space. We found that one could not exist without the other since light and matter have both particle and wave properties. We discovered not only the true nature of motion through a plenum but also that a created plenum has to exist. We concluded that created plenum, a peculiarly "counterfeit" plenum, is the firmament of the Bible. We identified the reason why God created the plenum and saw that the firmament shields the creation from God's plenum properties by endowing the firmament with counter-properties, such as the firmament's extreme density and opacity that protects the creation from being vaporized by God's light.

Next we confirmed by historical analysis the correctness of the translation, *firmament*, in the English Bible. From that we conclude that the Bible is authoritative in everything it touches upon, including science. The Copernican Revolution's effort to rid the world of the Holy Bible is thus exposed as the sham it is.

We saw, too, that the firmament rules all the physics in the universe and that, insofar as fundamental experimental observations are concerned, the firmament always shows the earth at rest. In the course of our analysis, we discovered that the ethereal ether is unnecessary since it is redundant. The firmament is responsible for the wave properties of light.

From fundamental experiments and observations, it appears that the universe controls physics so that the earth is kept at the barycenter of the universe. Heliocentrists prefer to say that physics somehow *conspires* to make it look as if the earth is at the center of the universe. Even if there were no firmament, the universe would

still fight any attempt to change the earth's central position. From that perspective, it makes sense that the earth is located at the barycenter of creation.

We also found that the modern scientific interpretation of the firmament as a sea of foamy virtual particles is fatally flawed because it lacks real constraints to suppress a menagerie of problematic structures that should be observed but are not.

This leaves the geocentric, Biblical model of the firmament as the most viable explanation for the Planck medium. Having thus started with nothing, we end up with two plenums; an uncreated one and a created one.

As a created plenum, the Planck medium is the only candidate for the Biblical firmament of the first chapter of Genesis. It shields the creation from God's fervent heat and serves as an anchor that stabilizes the earth. Since the firmament dictates the physics of the universe, it is the cause of the phenomenon that physics "seems to conspire" to anchor the earth at the dynamic center, the barycenter, of the creation. The Copernican Revolution was thus mistaken in concluding that the Bible need not be believed when it touches on scientific matters; the Bible is an infallible authority on all topics it covers.

To him that made great lights: for his mercy endureth for ever: The sun to rule by day: for his mercy endureth for ever: The moon and stars to rule by night: for his mercy endureth for ever.

— Psalm 136:7-9

7

THE SUN TO RULE BY DAY

The obvious starting point for geocentricity is Genesis 1. The first question to ask a self-professed Bible-believing heliocentrist is, "Just what did the earth orbit for the first three days?" Those creationists who follow Scofield's pre-Adamic race theory (also known as the gap theory) say that earth orbited the sun during the first three days of creation and that the sun, moon, and stars came out from behind the clouds on the fourth day and that there was no creative act performed on that day.¹ When confronted with the fact that the Bible clearly states that the sun, moon, and stars were *made* on the fourth day, they will say that the skies cleared on the fourth day so that the sun was *made* to appear on that day, but that it was really created a great many years before the first day of the recreation that started in Genesis 1:3-5.*

* The day-age theories, which were designed to conform the Bible to 19th century evolution, can no longer fit their evolutionary sequence to the sequence presented in the biblical account. The Holy Bible says that the plants were created before the sun; evolution says the sun was formed billions of years before the plants. Likewise, the pre-Adamic world theories claim that "replenish" in 1:28 means "refill." Modern dictionaries now list "refill" as a primary meaning, but only after two centuries of abuse by pre-Adamic race advocates. The *Oxford English Dictionary* gives its original meaning, as, to abundantly fill a prepared environment. We see the same use in Genesis 9:1 where God has miraculously restored the plants to receive the animals and man from the ark. After all, how else could the dove have found an olive leaf?

Most followers of the young earth, old-earth, and pre-Adamic-world views do not accept geocentricity. These groups are offended by it for, you see, geocentricity makes the present earth a special place; while the goal of modern science, through the Copernican and evolution revolutions, is to remove any sense that the earth is anything special in creation. To appear learned and be acceptable to today's mad, mad, mad, mad world, you must tow the heliocentric line. Don't believe it? Think of how often someone is reprimanded and whipped in line by being accused of being a flat-earther or a geocentrist.

Most denominations and cults that arose after the Copernican Revolution were designed to profit from the removal of the earth from the center of creation. The Seventh-Day Adventists and Mormons are of that ilk; both are extremely antagonistic to the geocentric universe. Mormons believe that there are a great many inhabited planets in the universe. Each planet has a "Father" god (who was once human) who has a great many wives (culled from the dead women of earth and other planets) and sires his own Jesus and his own Satan (not to mention the souls of the entire population) to play out salvation on his own planet. Likewise, Seventh-Day Adventism's, prophetess, Ellen Gould White (1827-1915) taught that the battle between Jesus and Satan is universal, and that Jesus, via his Holy Spirit,* has a full-time job going from planet to planet dying for each inhabited planet's sins. In both religions, an earth located at the center of the universe is anathema.

When it comes to the day-age and pre-Adamic race faithful, there is a built-in reluctance to geocentricity. Both groups modify Scripture with science, which makes it easy to dismiss the geocentric scriptures as phenomenological. So the question of what did the earth orbit the first three days of creation has significance pri-

The most damning evidence against the pre-Adamic world theories is found in Revelation 21:1 where this present earth and heaven are referred to as "the first heaven and the first earth."

* Cults know nothing of the Holy Ghost, even though the distinction has been drawn in English translations for nigh a millennium.

marily to special creationists who profess belief in the inerrancy of Scripture.

The Function of the Sun

Genesis 1:14-19 describes the creation of the sun, moon, and stars on the fourth day of creation:

¹⁴ And God said, Let there be lights in the firmament of the heaven to divide the day from the night; and let them be for signs, and for seasons, and for days, and years:

¹⁵ And let them be for lights in the firmament of the heaven to give light upon the earth: and it was so.

¹⁶ And God made two great lights; the greater light to rule the day, and the lesser light to rule the night: he made the stars also.

¹⁷ And God set them in the firmament of the heaven to give light upon the earth,

¹⁸ And to rule over the day and over the night, and to divide the light from the darkness: and God saw that it was good.

¹⁹ And the evening and the morning were the fourth day.

We read that the sun, moon, and stars were created for the earth, to be for signs, for seasons, for days, for years, to give light upon the earth, and to rule: the sun by day and the moon and stars by night. These bodies were also to separate light from darkness. Clearly, their purpose is geocentric. This means that the earth is the most important astronomical body in the universe.

One objection against a literal reading of these verses is the statement that the sun and moon are great lights. Many stars are brighter and bigger than the sun and even the smallest of the planets is larger than the moon. But the word "great" need not refer to size or luminosity; it can also refer to great in purpose. As we shall soon see, the sun is a type of Christ and the moon is a type of the Bride of Christ. Certainly that typology is great in the Lord's view and his purpose, as it should be in our eyes, too.

Heliocentrically, the Sun Cannot Rule the Day

Regarding the ordinance that the sun is to rule the day, physicist and Professor Harold Lewis Armstrong (1921-1985) made a very pertinent observation. In a letter to the author dated 19 March 1977 Professor Armstrong wrote:

Genesis 1:16 says that the greater light, which everybody, I think, grants to be the Sun, was to rule the day. The Hebrew word is the ordinary one to state that *e.g.* a king rules over a country; ... But what, in this context, is the day? According to 1:5 it is the light. In other words, it is day wherever it is daylight; and that applies to interplanetary space. Even out beyond Pluto it is daylight; the light from the Sun there is still much stronger than full moonlight here on Earth.

How, then, does the Sun rule this territory? To rule a territory could mean to control what happens in it. The Sun, then, controls what happens in interplanetary space, *viz.:* the motions of the planets. It controls also the motions of the irregular or occasional objects there, *viz.:* comets and meteoroids, and nowadays an occasional rocket. In other words, the motions of these things are ordered to the Sun, and (although it is now hindsight) that could have been deduced from Scripture. So their motion, with respect to the Sun, could well be the same as it is by the heliocentric theory (which can be called Newtonian, not Copernican or Keplerian); consequently nothing about those motions can serve as evidence against the Tychonic [geocentric] theory.



Figure 1: Prof. Harold Armstrong.

However, these arguments could not give Scriptural support to a completely heliocentric theory. For the lesser light, which, I think, almost everyone takes to be the Moon, was to rule the night. Now according to the heliocentric theory, and the interpretation adopted, the Sun would be ruling both day and night; for in controlling the motion of the Earth it would be controlling the motion of the dark side as well as that of the light one. But the Tychonian theory does not encounter any such difficulty. (See Figure 2.)

Professor Armstrong also introduces a deeper concept of day than what we normally think. He thinks that day is anywhere that the sun shines. We shall further pursue that in the "Ends of Heaven" section on page 102.

Psalm 19

Some crucial, geocentric, Christological sun references are found in the first six verses of Psalm 19:

- ¹ The heavens declare the glory of God; and the firmament sheweth his handywork.
- ² Day unto day uttereth speech, and night unto night sheweth knowledge.
- ³ There is no speech nor language, where their voice is not heard.
- ⁴ Their line is gone out through all the earth, and their words to the end of the world. In them hath he set a tabernacle for the sun,
- ⁵ Which is as a bridegroom coming out of his chamber, and rejoiceth as a strong man to run a race.
- ⁶ His going forth is from the end of the heaven, and his circuit unto the ends of it: and there is nothing hid from the heat thereof.

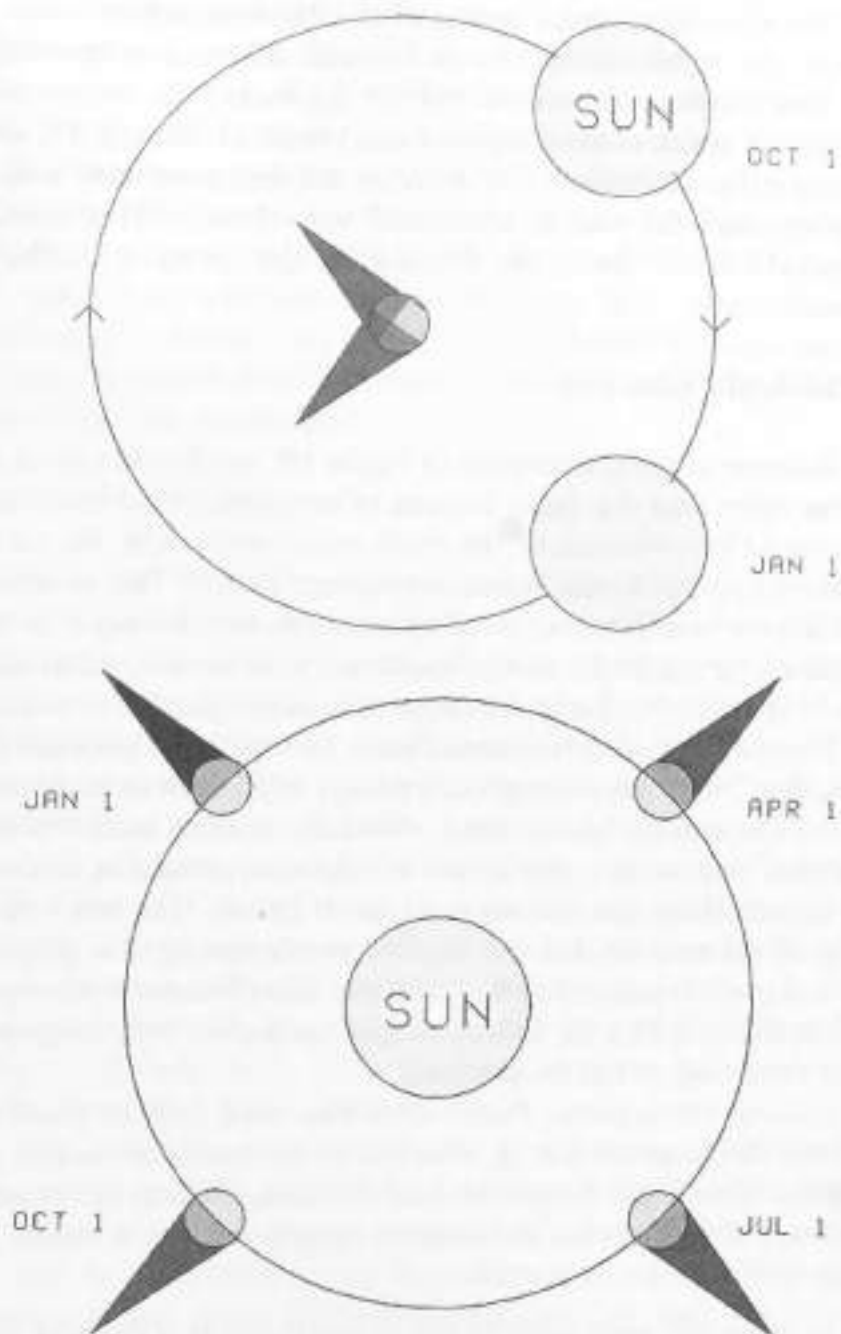

Figure 2: Top—geocentric Case—as the sun goes around the earth in the course of a year, night, caused by the shadow of the earth, is not subject to the sun. **Bottom—heliocentric Case**—the night orbits the sun, so the sun rules the night, too.

The first four verses speak of the heavens while verses 4b through six speak of the sun in heaven. These correspondingly find their mates in the second half of the Psalm, *viz.* verses seven through 10, speak of the scriptures and verses 11 through 14, speak of Jesus in the scriptures. The heavens are thus associated with the scriptures and the sun is associated with Jesus. This parallels Psalm 119:89's "For ever, O LORD, thy word is settled in heaven."

Criticism of Psalm 19:6

Because of the Christology of Psalm 19, we should expect it to receive more than the usual amount of criticism. That is certainly the case. One criticism of the sixth verse arises with the second and third English words, which are "going forth." This is actually one Hebrew word, *motsa*. Modern versions use the word "rising" instead of "going forth" even though *motsa* is never used to mean, "rise." Specifically, Scripture never uses *motsa* to refer to sunrise.

The Authorized Bible starts Psalm 19:6 with the personal pronoun, "his," thus reinforcing the typology of the sun as bridegroom and the Christology of the verse. Modern versions start this verse with "its," and so deny the person of Christ as present in this verse and, in turn, deny that the sun is a type of Christ. The sun's circuit (verse 6) takes it around the zodiac, yearly tracing the gospel as told in the stars: today, starting with the fish (Pisces, an allusion to the fish fished for by the fishers of men) and ends with the pouring out of the living waters (Aquarius).

Among theologians, Psalm 19:6 was once held as proof that the Holy Bible could not be believed in the realm of natural philosophy. The Right Reverend John Wilkins, Bishop of Armaugh in Ulster, defended the heliocentric system with this verse. He pointed out that the verse reads:

as if the sun were actually hot in itself; and as if the heat of the weather were not generated by reflection, but did immediately proceed from the body of the sun.²

Wilkins believed that the sun is a mirror reflecting the light and heat that emanated from a lake of fire located in the center of the universe. Just how that superstition came into being is related in the Chapter 20, entitled "The Birth of Heliocentrism." Suffice it for now that the originator of the idea was Philolaus, a student of Pythagoras. Furthermore, Wilkins also believed the sun to be inhabited. Today we regard Wilkins' misplaced faith as ludicrous; but men, even scientists and theologians, who reject the plain meaning of Scripture, are prone to be deluded by every wind of doctrine, no matter how ludicrous. After all, one has to be insane to think one can correct God.

The Circuit of the Sun

The word "circuit," as it appears in Psalm 19:6 has two meanings in English. First, it can mean a *closed* path and second, it can designate an area of legal jurisdiction (consider the circuit-riders of frontier days: trial judges who regularly went from town to town in their jurisdictions; likewise there are circuit-riding preachers). The same two meanings are present in the Hebrew word, *tekoofaw*,³ here translated as "circuit" in the Authorized Version. As a result, the verse has both meanings and insofar as it speaks of judgment, we find the next clause, "and there is nothing hid from the heat thereof," to be in agreement with the New Testament teaching that the present universe will be destroyed with fervent heat and that the condemned will be consigned to the lake of fire (Revelation 20:14-15; II Peter 3:10, 12). We shall return to that topic in the next section, "The Ends of Heaven."

The geocentric impact of Psalm 19:6 lies in the fact that the sun, not the earth, is described as moving. More specifically, the sun is said to be moving in a circuit. The word "circuit" means any real or imaginary curve that is traced by something going around a closed area. Heliocentrists argue that since the distance from earth to sun is small in comparison to the size of the universe, the "circuit unto the ends of" heaven cannot possibly refer to the motion of the sun around the earth since such a short distance can-

not be described as anywhere close to the size indicated by the "ends" of heaven. For that reason heliocentric apologists propose that the circuit refers to the orbit of the sun about the galactic center (the center of the Milky Way, see Figure 3). But this argument ignores the fact that the orbit of the sun about the galactic center, given the immensity of the universe, is not much larger than the earth-sun distance the heliocentric apologists objected to earlier. One cannot escape the geocentricity of the verse by any such argument about the ends of heaven.

If you assume the heliocentrists' interpretation that Psalm 19:6 refers to the motion of the sun about the center of the Milky Way, then a new set of problems arises. First, the passage refers to the circuit of the sun; and by definition, a circuit is a closed path. In order for the path of the sun about the galactic center to be called a "circuit," the universe must first be old enough to allow for its closure. Now the orbital period of the earth relative to the center of the Galaxy is of the order of 250 million years, which means that the circuit requires an old universe; otherwise we are 6,000 years into a 250-million-year journey awaiting the return of Christ. This is a special problem for those who insist both that the universe is about 6,000 years old and who proffer a galactocentric interpretation for Psalm 19:6.

A second problem with the galactocentric interpretation of Psalm 19:6 arises from the supposition that the sun's orbit about the galactic center is closed, that is, a circuit. But the sun's path about the center of the Milky Way cannot be referred to as a "circuit." The pretty picture of all the planets orbiting the sun in paths that close upon themselves works somewhat for planets, but it does not work for stars in a galaxy. Figure 3 illustrates the typical, jagged orbit for a star in a galaxy. As seen from above, the orbit appears to be closed (i.e., it seems to cross itself), but that is only an illusion introduced by projecting the orbit on a sheet of paper. It is not a closed path. You see, in addition to the 250-million year period, the sun also bobs up and down out of the plane of the galaxy, like the eye of a sewing machine needle, with a period of about 32 million years. Hence, where the path appears to cross, the sun is at

different heights relative to the galactic plane (into and out of the page in Figure 3). So the sun's galactic orbit cannot ever enclose an area and so could never be called a "circuit." We conclude then that the Bible is either wrong in using "circuit" to describe the motion of the sun, or the Bible is referring to a motion other than that of the sun about the galactic center. Clearly, the latter is the only viable choice.

Figure 3: *Galactocentric orbit.* The dotted line traces out a standard 250-million-year orbit about the center of the Milky Way, M . In actuality, if the sun

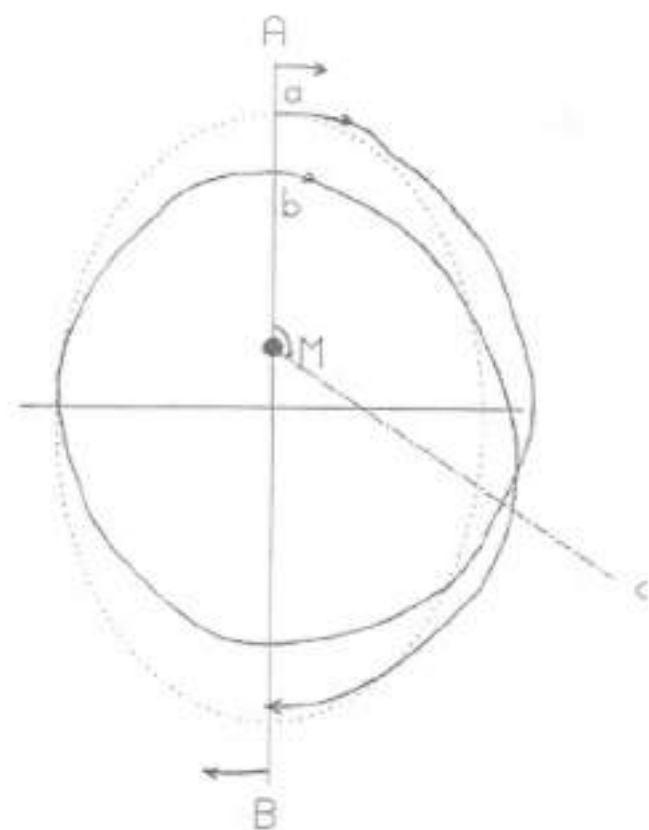

were to start at a , it follows an irregular path like that traced by the solid line. Technically, the orbit is complete at b , but note there that the sun has not described a closed path and so has not completed a "circuit." This is so for two reasons: first, the line AB rotates (to point c during the sun's orbit) and also the sun "bobs" up and down out of the plane of the galaxy, like a sewing needle, with a period of 32 million years. Additionally, the sun's path varies erratically as it has "close" (one or two light years apart) encounters with neighboring stars and passes through the mass-concentrations of

the spiral arms, which are concentrations of dust and gas.

To illustrate the third problem with the galactocentric circuit we ask, "What is so special about the galactic center as a reference frame?" The typical heliocentrist must answer: "Nothing." As far

as modern astronomy is concerned, the galactic center is every bit as arbitrary a frame of reference as is the placement of the sun (or earth) at the center of the universe. Some, such as Dr. D. Russell Humphreys, do believe that the Milky Way is located at the dynamic center of the universe.⁴ By doing so, heliocentric creationists hope to accommodate the overwhelming geocentric evidence without having to embrace geocentricity itself. Besides, there is a fly in the galactocentric ointment in that the Galaxy itself appears to be orbiting the Supercluster, a collection of clusters of galaxies that forms a belt in earth's sky, the center of which is commonly called "the Great Attractor." So, why not pick the center of the Supercluster as the center of the universe? But this obscures the word "circuit" even more by increasing the circuit period to many tens of billions of years, and the path of such an orbit⁵ is even more erratic than the sun's path about the galactic center, thus fitting the definition of circuit even less.

Now an astute reader may ask if the sun's daily motion about the earth might close upon itself. In that case, the term "circuit" could refer to the sun's daily path traced in earth's sky. Most of the time the circuit is closed; but at the time the sun crosses the equator, that is, around the first days of spring and fall, the sun's north-south speed is too great to close the loop, and so, the *daily* path cannot be the circuit referred to in Psalm 19:6.

Throughout the course of the year the sun moves from north to south and back again. The sun traces a 47-degree span in the course of a year. We see this with the changing seasons. In summer the sun is high in the sky; in winter it stays closer to the horizon. Figure 4 holds the key to the circuit of the sun.

In the course of a year, the sun traces out a helix in earth's sky.* The combination of daily and yearly motions is responsible for that. Now it happens that the plane of the yearly motion of the sun about the earth rotates slowly enough relative to the stars (a process called *precession*), and at 886,000 miles in diameter the sun is large enough that from one year to the next, the sun passes

* The word, *helix*, derives from this motion described by the sun after the Greek name of the sun, *Helios*.

through the same volume of geocentric space, that is, the same volume of the firmament. Thus the yearly cycle qualifies as a circuit. Figure 4 traces the circuit of the sun. The circuit is one year in length, circles the earth, and forms a closed path within the volume of the sun.

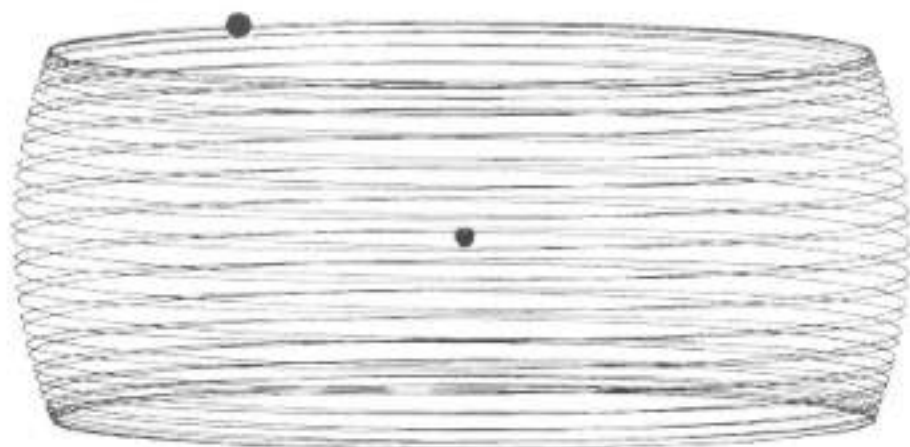

Figure 4: *The Sun's Daily Path Throughout One Year*

Shown with sun in the first day of Summer position (black circle at upper left) and the earth in the midst, the path of the sun is shown as it would appear if there were only 36 days in a year. On the first day of winter the sun is directly opposite its summer position (bottom right foreground), on the bottom loop, above the O of the "One" in the italicized title.

The yearly path of the sun best fits the circuit referred to in Psalm 19:6. The path of the sun's circuit passes through the zodiac, returning to nearly the identical place each year, well within the volume of the sun (see Figure 37.5). We have thus identified the circuit of the sun and it is geocentric. On the other hand, no one has yet come up with a scientifically and hermeneutically "acceptable" apologetic for Psalm 19:6 in a heliocentric framework. The passage remains both Christological and geocentric.⁶

Speaking of the zodiac: there is a long tradition (and it fits the stated purpose that the stars were for signs and for seasons) that the constellations tell the gospel story. Insofar as this is true, we note here that the zodiacal constellations are geocentric. They do not exist when looking from places more than a few light years from earth in the Milky Way.

The Ends of Heaven

Having identified the circuit of the sun, we now turn to consider the ends of heaven. Recall the reading of Psalm 19:6,

[The bridegroom's *i.e.* the sun's] going forth is from the end of the heaven, and his circuit unto the ends of it: and there is nothing hid from the heat thereof.

As a type of Christ, the clause, "His going forth is from the end of the heaven" can readily be understood in two senses. The first sense of "from the end" is the beginning of time. Salvation's story stems from the foundation of the world (Matthew 13:35*), from the time of Christ's going forth. The first sense of "end" thus refers to the beginning of the heaven. The second sense of "end" is that of space. Jesus came to earth from the third heaven, from beyond the edge of the universe. That, too, can be considered the end of the heaven. Both senses apply to the sun's going forth from the end of time and the heaven.

We now turn to the "ends" of heaven, describing the circuit of the bridegroom-sun. Recall from a few pages ago the discussion about the size of the circuit of the sun: that heliocentrists think it too small to refer to the relative orbit of the earth and sun; that the sun's orbit around the center of the Milky Way is a more likely interpretation. We, however, concluded that only the annual motion of the sun forms a circuit whereas larger orbits, such as the sun's orbit of the Milky Way, cannot fit the definition of a circuit. The question is, "Where are the ends of heaven?" Again we encounter two senses, one involving space and the other involving time.

The heaven has a beginning (Genesis 1:8) and it has an end (II Peter 3:13; Revelation 21:1). Thus the sun's circuit, as a type of Christ's circuit, runs from the foundation of the world (Matthew 13:35) on the sixth day of creation, namely the creation of man,

* Matthew 13:35—That it might be fulfilled which was spoken by the prophet, saying, I will open my mouth in parables; I will utter things which have been kept secret from the foundation of the world.

until the end of heaven at the Great White Throne judgment (Revelation 20:11).

The spatial sense of the ends of heaven is more complicated. Earlier, while considering the rulership of the day by the sun, we noted that the late Queens University physics professor, Harold Armstrong, observed that scripturally the scope for the sun's domain extends as far as the day, that is, as far as its light extends; no matter how faint. If the scope of the sun's domain is to the ends of the heaven, then it must extend to the edge of the universe, which is consistent with Armstrong's observation.

On the surface the claim that the sun's circuit extends to the edge of the universe is radical, to say the least. One is not amiss to look for more proof of that postulate, or to search the scriptures for an opposing statement. That Scripture means it so is confirmed by the rest of the sixth verse in the psalm: "there is nothing hid from the heat thereof."

The Heat of the Sun

We have already noted that the reference to the sun's heat reminds us of the Great White Throne judgment of Revelation 20:11. There the "earth and the heaven fled away; and there was found no place for them." The fate of the first heaven and earth is foretold in II Peter 3:12; they shall be molten with "fervent heat."

The sun's heat is radiant heat. There is no air between the sun and the earth to conduct the heat to us. Instead, the heat from the sun is transmitted by the light from the sun. That form of heat transference is called *radiant energy*.

The heat of the sun reaches everywhere its light reaches, even to the edge of the universe. The volume of space reached by sunlight is part and parcel of the day the sun is said to rule in Genesis 1:16, thus the reference to the heat of the sun is consistent with the circuit's effect extending to the edge of the universe.

* II Peter 3:12—Looking for and hasting unto the coming of the day of God, wherein the heavens being on fire shall be dissolved, and the elements shall melt with fervent heat.

Now evolutionary-minded readers may balk and say, "The sun is only six billion years old; how can its light extend to the outer edge of space some 13 to 20 billion light years out? That is not a problem for Scripture because the Bible teaches that God stretched out the heaven (Isaiah 40:22; 42:5; Psalm 104:2 etc.). Modern astronomy refers to that as *inflation*. When the stellar universe—the starry heaven—expands, the speed of light increases. Modern astronomy places the inflationary expansion of the universe at a small fraction of a second after the start of the Big Bang, but the first inflationary models—developed in the early 1970s—reached our present universe with a diameter of twenty billion light years in less than 100,000 years.⁷ Just about any age and any size can be fit by inflationary theory. Simply put, a universe stretched out to forty billion light years in diameter and having an apparent nuclear age of twenty billion years but with a true age of 6,000 years is entirely possible.

Scripturally, the sun and stars are the same age, give or take a few hours. So the sun's light will have reached out as far as the furthest star, galaxy, or quasar we can see. Today, we are not encouraged to think in grander terms than our everyday experiences. Evolutionary-minded man considers himself to possess the ultimate extent of all knowledge—ever. The insistence by evolutionists that all evidence and discussion contrary to evolution be banned only serves to highlight the bankruptcy of their faith.

Kinematically, meaning when it comes to velocities and accelerations, there is no conflict between the modified Tychonic model's proposal that the entire universe partakes of the sun's circuit and the science of cosmology. Dynamically, when we add mass to the kinematic view, we deal with inertial forces and must deal with the inertial forces of the universe. We saw in the previous chapter that the distinction between kinematic and dynamic is an illusion. Both kinematic and dynamic, in a daily-rotating universe, will cause all objects, be they galaxies or photons, to trace the same path as the sun in their respective places in the firmament. (See Appendix E for details.)

How the Circuit Works

Before proceeding, let us review what it means to have the entire universe partake of the sun's circuit. We are brought up with the notion that the earth orbits the sun in an elliptical orbit, in a counter-clockwise direction as seen from the north, and at an average distance of 93 million miles from the sun. As seen from earth, however, the sun appears to orbit the earth in a counter-clockwise elliptical path (not a real orbit) at an average distance of 93 million miles. This latter case is the geocentric case. In both cases, from the sun's perspective the sun perceives the earth as orbiting around it once a year and it is convinced that the law of gravitation is properly working.

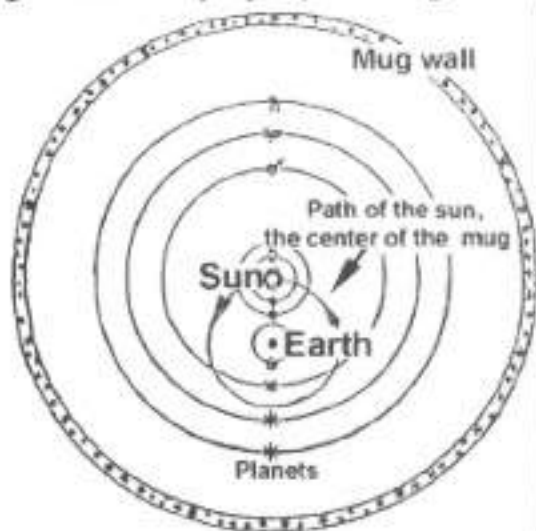

Figure 5: *The motion of the mug illustrating the motion of the universe and sun to fulfill the sun's rule of the day.*

Now the sun is convinced that gravity is properly working because if gravity were unbalanced, the sun would know it because the gravitational field of the rest of the universe would tell it so. This "telling" property is called *inertia*. The universe tells you the same when making a sharp turn in an auto slides you over to the outside of the circle. But the sun does not "get the message" in the geocentric case because the inertia, the gravitational

field of the universe is also sticking with the sun in its yearly path. Perhaps you prefer to think of it the other way, that instead of the sun moving with the universe, the universe moves and drags the sun with it. Either way works just fine.

Finally, it is important to realize that orbital motion is different from rotational motion. For this illustration, take a mug or cup

with an ear (Figure 5). In the figure, imagine the handle of the mug aligned with the three stars (planets) at the bottom of the mug wall. Sit down with the mug on a smooth table surface. Spin the mug so that the ear rotates on the table. You will be able to see all sides of the mug. This is *rotation*. Next, grab the mug by its ear. Slide the mug in a circle on the table so that the ear stays aligned with your arm. This is *revolution*. Now imagine that the mug is the universe and that the earth is located on the table at the center of the circle traced out. The sun is located at the center of the bottom of the mug. The circle is 93 million miles in radius and one cycle represents one year.

Related Scriptures

Now that we have a better handle on the mechanics of the sun ruling the day, let us search the scriptures for corroborating testimony of what we have before us now. Some are rather superficial, such as Romans 8:28,

And we know that all things work together for good to them that love God, to them who are the called according to his purpose;

and Romans 8:22,

For we know that the whole creation groaneth and travaileth in pain together until now;

both of which show that the entire creation is involved with the purpose of God, particularly with his creation which includes the sun, moon, and stars.

Now consider Psalm 136 verses 8 and 9:

⁸ The sun to rule by day: for his mercy endureth for ever:

⁹ The moon and stars to rule by night: for his mercy endureth for ever.

Nothing new here; at least on the surface. But recall that the lordship of the sun includes shedding its light on the earth. In that

sense, the sun is the light of the world—physically. Jesus spoke of another light of the world. Since the sun is a type of Christ, it is no surprise that Christ is the light of the world spiritually. John 9:4-5 states:

⁴ I must work the works of him that sent me, while it is day: the night cometh, when no man can work.

⁵ As long as I am in the world, I am the light of the world.

We perceive here that while Jesus is openly on earth, it is day. When he is gone, it is night. According to the fifth verse of John 9, night fell with Jesus' ascension—which is itself geocentric—into heaven as recorded in both Luke 24:51, and Acts 1:10.

The Moon and Stars to Rule the Night

With nightfall, the moon and stars resume their reign; but who or what do they signify? In scriptural typology the moon is a type of the Bride of Christ, reflecting the Sun's light into the night. She is said in Psalm 89:36-37 to be a faithful witness, associated with the seed that serves Christ:

³⁶ His seed shall endure for ever, and his throne as the sun before me.

³⁷ It shall be established for ever as the moon, and as a faithful witness in heaven. Selah.

Christ's seed is clearly identified in Psalm 22:30 where it is accounted for a single generation (Jesus has brethren, but no children). The seed and its generation are mentioned dozens of times throughout Scripture, most particularly in the introduction of the New Testament, where in Matthew 1:1 we read as introduction to the New Testament: "The book of the generation of Jesus Christ." That generation is typed by the moon in Psalm 136:9.

As citizens of the kingdom of God we have the Holy Ghost* in us, and as he testifies only of Jesus, the Holy Ghost sheds through

* Etymologically, ghost is a contraction of God's host (g'host). It reflects the Bible teaching that the spirit in each of us, saved or lost, came from God (Ecc.

us a ghostly light, which makes us now the light of the world (Matthew 5:14). A ghostly light, however, cannot be perceived by the eye but can only be discerned spiritually (I Corinthians 2:14). The one blinded by the god of this world—the natural man—perceives not the light but only our saltiness (Matthew 5:13; Luke 14:33-34, etc.). Salt in a wound hurts as it purifies. The natural man focuses on the hurt and lashes out at the salt; that we learned at Jesus' feet. We are presently in the night when the moon, as a type of the Bride, sheds forth the light as well as it is shed by the stars, which are angels (Revelation 1:20), the ministering spirits of Hebrews 1:13-14, particularly the seven spirits of the churches in Revelation 1-3.

The Dominion of the Ordinances of Heaven

Of particular significance here is something God said to Job which Elihu recorded in Job 38:33,

Knowest thou the ordinances of heaven? canst thou set the dominion thereof in the earth?

It makes sense that the ordinances of heaven would include the functions listed at the creation of the heavenly bodies on the fourth day of creation. Then, too, there is the will of God. Jesus prayed in Matthew 6:10, "Thy will be done in earth, as it is in heaven." It is clear from the prayer that God's will is not always performed in earth. God will enforce his will on earth in the Millennium when Jesus establishes the kingdom of heaven. Later, in the new heaven and earth, God's will is established in earth when God rules the earth and all the heavens from the New Jerusalem. But natural ordinances have no free will, so they are obeyed. Thus, if one considers the ordinances, the "laws," of astronomy—particularly the law of gravity—they are established in earth. So there is something subtle in Job 38:33 that is easily overlooked. Let us restate the verse in a way that does not affect the meaning:

12:7) and makes us living souls even as Adam in Genesis 2:7. The Spirit inspires the second birth, the spiritual birth Jesus taught to Nicodemus in John 3.

Knowest thou the ordinances of heaven? canst thou set the dominion of the ordinances of heaven in the earth?

We do know that the laws of physics are the same in the universe as they are in earth. What God is thus saying to Job is that the dominion, the lordship, of the physical ordinances of heaven is *vested in the earth*. The “laws” of the universe do not govern earth; on the contrary, the laws of the universe are governed by the earth.

This is a difficult concept to understand; it is even harder to believe. Nevertheless, it is consistent with scriptural geocentricity and solves some severe difficulties in cosmology, such as the single-universe solution to the equation that allows for multiple solutions, that is, multiple universes, otherwise known as parallel universes or the *multiverse*. That earth governs the ordinances of heaven also simplifies some of the difficulties encountered by cosmologists in how man perceives the creation and how he interacts with it on deep intellectual levels. Simply stated, there are no parallel universes in Scripture; the possibility of their existence is erased by the geocentricity inherent in Job 38:33. Geocentricity is the key to the holy grail of cosmology: the unified field theory or the theory of everything.

We will examine the ordinances of heaven in more detail in Chapter 17.

O fools, and slow of heart to believe all
that the prophets have spoken ...

— Luke 24:25

JOSHUA'S LONG DAY

After leaving Egypt and wandering in the Sinai wilderness for forty years, Israel entered the land of Canaan late March to mid-April, 1448 B.C. The Israelite leader, Joshua, had a clear-cut task set before him: to completely eradicate all the previous inhabitants of the land. The story is quite familiar to every Sunday school student: how the Israelites marched around Jericho until the city fell, the subsequent defeat of Israel at Ai followed by the judgment of Achan, the fall of Ai, and the ruse of the Gibeonites who tricked the Israelites into an unholy alliance. When the surrounding nations heard of that alliance, they attacked the Gibeonites who then sent to Joshua for help. The account of the battle that followed occupies about half of the tenth chapter of the book of Joshua where verses twelve through fourteen tell of the peculiar event which is commonly called *Joshua's long day*:

¹² Then spake Joshua to the LORD
in the day when the LORD deliv-



Figure 1: *Joshua Commands the Sun*

ered up the Amorites before the children of Israel, and he said in the sight of Israel, Sun, stand thou still upon Gibeon; and thou, Moon, in the valley of Ajalon.

¹³ And the sun stood still, and the moon stayed, until the people had avenged themselves upon their enemies. Is not this written in the book of Jasher? So the sun stood still in the midst of heaven, and hasted not to go down about a whole day.

¹⁴ And there was no day like that before it or after it, that the LORD hearkened unto the voice of a man: for the LORD fought for Israel.

Reactions of the Commentators

The geocentric implication of this passage is obvious. Instead of the sun's motion through the sky being due to the rotation of the earth, here it states that the sun and moon daily move around the earth. The sun is commanded not to move or rise; it is not the earth which receives the commandment to stop turning. Over the last 400 years, this has been the source of much consternation among the commentators and Bible critics—both higher and lower. Their reactions fall into two main categories: those who wish to make the event to be fiction and those who try to accommodate the account to modern science's insistence that the earth rotates daily on its axis. In either case, the apologists insist that it is science that is correct, and it is the Bible which is in error and which must be conformed to modern belief.

Those who try to accommodate Joshua's long day to science also fall into two categories. The first group includes those critics who try to blame the geocentric "flaw" in Joshua 10 on faulty transmission of the text or, at least, to faulty translation or a misunderstanding of what God *meant* to say. The second group consists of those who try to make of the event an illusion or else a quite natural occurrence. Generally, both groups will admit of a miracle, but not all will admit to a miracle in the sky; and all make the miracle something less than the Bible claims it to be.

The Fiction Faction

Bible critics who claim that Joshua's long day is a fiction or allegory have contributed a great deal to our understanding of the event. Their main goal was to disprove the account by proving either that there are no independent accounts of the long day so that Joshua 10 stands alone, or else to show that Joshua's account is nothing more than a local sun-stopping myth. The latter, for example, would be demonstrated if all the world's sun-stopping accounts reported that the sun stopped in the daytime. Because of the critics' efforts, we now have a wide selection of tales to evaluate; and they do prove useful in understanding Joshua's long day as a global event. We shall look at those geographically unrelated accounts later in this chapter.

One of the fundamental assumptions of the fiction faction is that the Bible is the product of the human mind. This assumption is really what lies behind the agenda to collect the sun-stopper accounts. If Joshua's long day is pure fiction, then the Scripture can safely be relegated to the trashcan of history as nothing more than a pack of fables. After all, if Joshua 10:12-14 cannot be trusted, what can be trusted in the Bible? The Bible claims itself inerrant. Either it is or it is not. The fiction faction has decided that Joshua's long day, if not the whole Bible, is bunk. What's interesting is that most of those who have decided that the Bible is bunk are not yet ready to banish the Bible to the landfills of history.

Adjusting the Language

Not all Bible critics are ready to throw out the Bible on the basis of the apparent conflict between the geocentric implications of Joshua's long day and modern science's heliocentric insistence. Many bend over backward to accommodate the Bible to science on this and other points. As far as Joshua's long day is concerned, some have suggested that the effect was psychological, that the day only *seemed* supernaturally long. Deane made that proposal with these words:

...the Israelites may well have regarded the events of that one day as equivalent to the work of two, and thus in course of time it came to be believed in current tradition that the day was prolonged to twice its usual length, though Scripture itself nowhere supported the statement.¹

There is one basic problem which must be dealt with by all who would wish to maintain that the actual time elapsed involved fifteen hours or less of daylight. Given the geography of the battle site in Joshua 10, the Israelite army as a whole marched well over thirty miles. Any army would be hard pressed to march thirty miles in one day, let alone to fight as well. The larger the army, the slower it moves. Yet if Deane is correct, not only did the army march thirty miles, but it also fought a full-fledged battle as well, and all that in twelve hours of daylight (it being late March or April when these events took place). Deane, of course, assumes that men and not God authored the Bible. If that is the case, the Bible can be safely ignored since God cannot be held accountable for the blunders of humanity.

It is very common to find commentators claiming that the Hebrew is mistranslated or misunderstood whenever the Bible disagrees with their notion of what it should say. When applied to Joshua's long day, for example, one proposal is that the words "stand still" are better translated as "be silent" or "be still." Doing so led the nineteenth century astronomer Maunder to claim that Joshua meant nothing more than that there be an end to the blazing noonday heat. According to Maunder, the miracle was the sudden appearance of storm clouds from the Mediterranean Sea.² To this Bernard Ramm concurs.³

Collett argues the same, claiming that the Hebrew should be translated "be inactive" or "be silent." He then makes this astoundingly unscientific statement:

We have already seen that light is vocal, and it is generally held among scientific men that it is the action of the sun upon the earth that causes the latter to revolve [sic] upon its axis.⁴

In Collett's opinion, light not only speaks, but sunlight shining on the earth is what causes the earth's rotation. So, according to Collett, when the sun stopped shining at Joshua's request, the earth stopped turning because there was no longer any sunlight to keep it turning. Both opinions are scientifically preposterous, particularly the latter.

Boling⁵ presents us with a look at the schizophrenia inherent in the "be silent" proposal. He translates Joshua 10:13 as the "Sun was *stilled* and Moon stood fixed." Boling believes that the Hebrew may also mean, "to be clouded over." So he concludes that Joshua's long day was an eclipse of the sun. Despite the above "to be clouded over," Boling acknowledges that the Hebrew might mean to "be still." He finally concludes that the Hebrew can only mean to "stay put," to "hold a position," or to "strike a pose";⁶ in other words, to stand still.

But the introduction of clouds to cover the sun could not in the least account for the report of the thirteenth verse that the "sun stood still" and the "moon stayed." The only way that the Hebrew word *dawmam* could be translated as "silent" would be if the sun were making so much noise that it was disrupting the battle and Joshua's concentration. And, lest anyone doubt God's ability to tell us plainly when the sun is covered with clouds, we present Ezekiel 32:7 for his consideration:

And when I shall put thee out, I will cover the heaven, and make the stars thereof dark; I will cover the sun with a cloud, and the moon shall not give her light.

Nevertheless, having Joshua say "be silent" or "stand still" to the sun does not change the content of the thirteenth verse where the sun is said to stand still. Generally, the commentators can get Joshua off the "scientific" hook, but they have no luck at all get-

ting God off the hook in the thirteenth verse; it still reads that the sun "hasted not to go down about a whole day."

Consider the Ferar Fenton version from the early twentieth century as another example of a man trying to correct the words of God. Fenton rendered the twelfth and thirteenth verses of Joshua chapter 10 as:

¹² Joshua also called to the Ever-living on that day: "Jehovah! Give the Amorites to the face of the children of Israel!" and he added, "Sun! In the eyes of Israel be still at Gibeon, and Moon! in the valley of Ailan!"

¹³ And the sun and moon stood still, till the nation had mastered its foes! Is not this recorded in the true Record?—that the sun stood still in mid sky, and hastened not to set for about a full day?

Fenton saved Joshua from making the geocentric "error" of thinking that the sun goes around the earth by having the words "in the eyes of Israel" be part of the quote rather than the commentary. Fenton may have saved Joshua's pride, but God is still left "holding the bag" in the thirteenth verse, where the commentator's words have not been changed. And Fenton wrote in his foreword that his version was the "first ever" in which the translator "used his brain"!

The Jewish Commentators

Oddly, only the Gentile commentators "know" enough Hebrew to see that Joshua told the sun to be still: it seems to have escaped the Jewish commentators. Jewish scholars, both those who believed in the miracle and those who did not, draw no such distinction in their writings not even among heliocentrists. One of the Jewish commentators is Philo, who is notorious for bad paraphrasing and interpolating his own ideas into the Jewish text and history. His account of Joshua 10 follows:

And when Jesus arose to rule over the people, it came to pass in the day wherein he fought against the enemies, that the evening drew near, while the battle was strong, and Jesus said to the sun and the moon: O ye ministers that were appointed between the Most Mighty and his sons, lo now, the battle goeth still, and do ye forsake your office? Stand still therefore today and give light unto his sons, and put darkness upon our enemies. And they did so.⁷

Note: no mention of “be silent.”

Manasseh Ben Israel summarized the mainline Jewish opinions on Joshua’s long day this way:

Rabbi Levi Ben Gershon [Spain, circa 1300], philosophizing in the extreme, holds that the sun did not stop..., it is the agency of the mind that performs miracles...so that the miracle consists in taking revenge in so short a period.⁸

In Spain, in the last half of the twelfth century, Maimonides taught that Joshua’s long day was “a most perfect day, that is like the longest summer day.” In other words, Maimonides did not believe it was a miracle. On the other hand, most Rabbis did believe in a long day, though they differed in opinion on how long the day ultimately was. Rabbi Joshua Ben Levi of Jerusalem about A.D. 200 advocates 24 hours for the day, a regular day. Three hundred years earlier, about 100 B.C., Rabbi Eliezer, also of Jerusalem, argued for a day of 36 hours. Rabbi Samuel Bar Nachman (Rabbah, ca. 290 - ca. 320) held to a 48-hour day. So Jewish opinion was as divided as Christian opinion about the length of Joshua’s long day.

The consensus of the early Jewish commentators is clear: none invoke the “be silent” approach. So they agree with Boling’s conclusion, mentioned earlier, that “be silent” and its variant forms are not valid translations of the Hebrew. As a result, the rationale for adjusting the language to accommodate Joshua’s long day to science’s authority is thrown into doubt. There seems to be no basis left for doing so.

The "It's Only Natural" Faction

The second of the accommodation groups is those who advocate a naturalistic explanation for Joshua's long day. We have already seen one such explanation when we looked at the suggestion that the Bible's language be adjusted to mean that Joshua's long day was nothing more than a cloud cover to cool the heat of the day. Related to this idea, and also stemming from the "be silent" interpretation, is the opinion that Joshua's long day is an eclipse of the sun.

Was Joshua's Long Day an Eclipse?

An eclipse of the sun happens when the moon passes in front of the sun as seen from earth. If one is within about 100 miles from the center of the moon's shadow, one may see a *total eclipse* of the sun, at which point the sun's disk is fully obscured and one sees a halo (called the *corona*) around the sun. An eclipse of the sun still inspires fear and awe among peoples of all nations. As a result, even though Babylonian astronomers were able to predict eclipses at the time of Joshua, scholars still consider it reasonable to suppose that Israel's enemies were terrified out of their wits by the sudden appearance of an eclipse. So it is that some critics claim that it was the eclipse, not God, that caused Israel's enemies to flee.

Robert Dick Wilson (1856-1930) is regarded by many as the foremost linguistic scholar of the nineteenth and twentieth centuries. In 1930, he published an essay dealing with Joshua's long day.⁹ Fully aware of the error of rendering the Hebrew as "be silent," Wilson took another common approach among Bible critics, which is to look to a similar language to get the meaning he wanted. In his case, he looked to the Babylonian.

Before we examine Wilson's work, let us give an example of how this approach can turn out. Many Jewish writers have remarked on how similar English and Hebrew are if one considers only the consonants of English words. It is said that of all the

modern languages, English is the closest to Hebrew. Now suppose I am translating some British-English text into American-English and I come upon the British sentence "She hit me!" Now we all *know* that girls are not supposed to hit people; only boys hit people, so the "she" must be wrong. I conclude that the author of the original English sentence cannot have *meant* what he wrote. Perhaps a copyist error has crept into the text. On the basis of the similarities between English and Hebrew, I conclude that they are cognate languages, so I can consult the Hebrew to ascertain the correct meaning of "she." Now in Hebrew, the word "he" means "she" in British, and the word "she" is equivalent to the British "he." So, since British English is cognate to Hebrew, the "correct" translation into American of "She hit me!" must be "He hit me!" Such use of cognate languages to determine "correct" translations of "difficult" Bible passages is done all too frequently.

After replacing the meanings of Hebrew words with their corresponding Babylonian meanings, Wilson concluded that:

...the day of the battle had two comings-out of the sun, one at sunrise and the other at midday, when it came out from behind the moon; and that it had two goings-in, one when it went behind the moon and the other at sunset.¹⁰

On that basis, Wilson provides us with the following translation of Joshua 10:12-13:

¹² Be eclipsed, O Sun, in Gibeon, And thou moon in the valley of Ajalon!

¹³ And the sun was eclipsed and the moon turned back, while the nation was avenged on its enemies. Is it not written upon the book of Jashar? And the sun stayed in the half of the heavens, And set not hastily as when a day is done.¹¹

Note that the geocentric "error" has been transferred to the book of Jasher. Wilson had thus spared himself the shame and

embarrassment of being regarded as an ignorant Bible thumper, for he writes:

I confess to a feeling of relief, as far as I myself am concerned, that I shall no longer feel myself forced by strict exegesis to believe that the Scriptures teach that there actually occurred a miracle involving so tremendous a reversal of all the laws of gravitation. It can readily be understood how the Jewish interpreters of latter times, either through ignorance, or because of their overwhelming desire to magnify their own importance in the scheme of the universe, should have embraced the opportunity that the ambiguous terms of this purely scientific account afforded them to enhance the magnitude of the divine interference on their behalf.¹²

Wilson is not alone in his belief that Joshua's long day was an eclipse of the sun. Boling¹³ promotes the eclipse of September 30, 1131 B.C. as the very eclipse. Unfortunately, that eclipse is more than 200 years too late, given the biblical chronology.¹⁴ Eugene Faulstich is of a different opinion. He prefers the eclipse of April 19, 1421 B.C.¹⁵

Although an eclipse makes sense if Joshua wanted to frighten his enemies and to diminish the heat of the day, there are some problems with this approach. Insofar as the heat of the day is concerned, any relief granted the Israelites would also be granted Israel's enemies. More importantly, an eclipse is of a short duration, lasting at most eight minutes. Since the eclipse was already scheduled in God's timetable, how can Joshua 10:14 report that God had listened to the voice of a man? Faulstich answers this by saying that God had Joshua's request in mind when he created the sun and moon and when he set the moon into orbit around the earth. In any case, there is no miracle involved, only a natural event.

The strongest support the eclipse advocates claim is found in Joshua 10:12, where Joshua tells the sun to stand still *over* Gibeon and the moon *in* the valley of Ajalon. Since there is only a matter of a few miles separating the two sites, how can the verse be liter-

ally true unless both the sun and moon were directly overhead? In that case, the moon must have been covering the sun, the very situation known as an eclipse.

In response, it must be noted that Joshua is speaking as a man (verse 12) and thus not speaking an inspired revelation. Joshua could be using the language of appearance, an error which God cannot afford to commit. Note that the date is mid- to late-April. The sun at the time is overhead along a circle no further north than one touching the southern-most tip of the Red Sea. Even at its furthest point north (the first day of summer) the sun is overhead only in a circle running through southern Egypt. Gibeon is a good seven degrees further north. The sun is never overhead at Gibeon and never has been in all recorded history. The second thing we note is that the moon is far larger than the valley of Ajalon. Taking Joshua's statement literally would have flattened the entire scene as the moon came down to rest *in* the valley. It is obvious that Joshua could see the moon "in" the valley in order to tell it to stand still. If the moon were close enough to the sun for an eclipse, Joshua would not have seen the moon until the eclipse was actually under way. Why did he not then tell it, too, to stand still "over" the city of Gibeon? So we conclude that Joshua was speaking from his viewpoint when he told the sun to stand still *over* Gibeon and the moon *in* the valley of Ajalon, and that God did not put the words into his mouth in Joshua 10:12. (Also see verse 14.) By contrast, in the thirteenth verse God does not repeat Joshua's error of speaking phenomenologically.

The Refraction Rationalization

One of the rationalizations for Joshua's long day is that it was an optical illusion. Keil and Delitsch are among those who hold that both Hezekiah's sign and Joshua's long day were optical phenomena:

an optical stoppage of the sun, or rather a continuance of visibility of the sun above the horizon.¹⁶

Basic behind this proposal is that the rotation of the earth did not stop but that God miraculously bent the light rays of the sun and moon so that, in Canaan at least, the sun and moon appeared to remain above the horizon. Yet the plain wording of the text is that the "sun stopped" and "the moon stayed"; it does not say that God "kept the light of the sun and moon" shining over the battlefield. Now God could have said that, but he did not.

The Gradual Slowdown

Until about the middle of the twentieth century, most critics of Joshua's long day had the earth suddenly stop its rotation. Such a catastrophic change, unless it were supernaturally controlled, would have to occur very slowly or else the earth would be torn to pieces and the oceans would leave their basins and wash over the continents. Recognizing this problem in the mid-nineteenth century, Gaussen¹⁷ commented extensively on how God could slow down the earth's rotation for Joshua without causing those earthly catastrophes. In the twentieth century, the strongest proponent of the rotation slowdown was Immanuel Velikovsky who proposed for Joshua's long day that the earth was tidally slowed in its rotation by a close passage of the planet Venus and that the rotation sped up again to its original speed when Venus left.¹⁸

Now there is no hint in Joshua 10 that there was any gradual slowing of the diurnal rotation, but we can present an analogy which will enable an appreciation of the problem as it is commonly defined. Since the equatorial rotation speed of the earth is about 1,000 miles per hour, which is roughly the same speed as a supersonic jet fighter, we can use the slowing of a jet plane for comparison. Suppose there is no turbulence buffeting the jet plane and suppose that there is a saucer of water in the plane. The problem is to stop the plane without sloshing the water out of the saucer. A little experimentation shows that one may decelerate the dish at about half a mile per hour per second without spilling the water. If so, we conclude that it would take about 35 minutes to stop the jet

plane without the water leaving the saucer. Such may work for a saucer, but oceans are much deeper and have much more energy. Small shifts in the ocean bottom have been known to cause huge waves, for example. Still, 35 minutes, though optimistic, is not an unreasonable response time to Joshua's request.

An additional problem with the slowing-down-rotation theory is that the atmosphere does not behave as nicely as the ocean in this regard. The air near the earth's surface would slow down first, but the air aloft would keep going, dragging the air below with it. The slowdown time needed to avoid 1,000 mile-per-hour winds scouring the earth's equator amounts to days, a most unreasonable time to respond to Joshua's request. Lest the reader conclude that the geocentric explanation has no such problem, we note that the geocentric case suffers the same problems. Insofar as the slowing-down of the earth's rotation is concerned, there is no way to escape the conclusion that Joshua's long day was a miracle.

The Tippie-Top

Increasingly, pro-heliocentric apologists have tried to explain the sun's stopping to such a degree that the actual intent of the passage is unrecognizable. For instance, Howard Rand suggested that the axis of rotation of the earth changed in such a way that for about one day the battle site became earth's rotational north pole.¹⁹ Although not original with Rand, the idea has gained popularity lately because of Velikovsky's writings.

In Rand's tippie-top scenario, some event inside the earth or else the fly-by of some planetary body caused the earth's rotational poles to move in such a way that, for one day, Joshua's battle site was at the north pole. One obvious problem is that the moon would still be seen to go around the sun during the battle. But the text says that the moon, too, stood still.

Not so obviously, Professor James Hanson, then at the Cleveland State University in Cleveland, Ohio, showed mathematically that Rand's is not a possible explanation. Furthermore, Hanson showed that Velikovsky's explanation for Joshua's long day—that

a close pass by Venus past the earth slowed the earth's rotation and that as it retreated from earth, the earth's rotation sped up again—is physically impossible unless Venus were still orbiting earth today in an orbit even closer to the earth than is the moon.²⁰ In fact, none of the naturalistic proposals put forth to account for Joshua's long day are physically possible. The simple choice remains: Joshua's long day is either a miracle, or it is pure fiction.

The Book of Jasher

There is one other tact which a handful of commentators have taken in order to allegorize or otherwise explain away Joshua's long day, and that is to assign parts of Joshua 10:12-14 to the book of Jasher mentioned in the thirteenth verse. Those commentators claim that there never was a miracle, that Joshua merely asked the sun to be "stilled," and centuries later some nameless "editor" incorporated into Scripture the fictional account of the sun standing still from an uninspired book entitled the *Book of Jasher*.

The word, *jasher*, means "upright" or "just." The term could just as well refer to the Bible itself as to any other book. Nevertheless, there is a book in existence today which some claim is the very *Book of Jasher* mentioned in Joshua. This seems extremely unlikely, however, since that *Book of Jasher* was apparently written sometime after the time of David as it contains several poems attributed to David. Most Christian commentators believe the book to be a forgery, written because the biblical reference afforded the occasion for its creation. The text of the *Book of Jasher* exalts the heroic deeds of the great men of Israel, but the men exalted therein were not necessarily righteous men, the title to the contrary. Then, as now, a nation's "great men" are seldom righteous and just. It appears, then, that the real *Book of Jasher* referred to in scripture is either the Bible itself, as the book of the upright and righteous, or else it refers to a long-lost book.

Joshua's Long Day Around the World

Having concluded that Joshua's long day is a miracle, we may ask whether or not it was restricted just to Judea or whether it was global in scope. Certainly a "missing day" would generate considerable consternation among the peoples of the world, provided it was a global event. Are there other accounts of a long day or even a long night? Indeed, we can find stories of a long night as well as a long day. We can even find tales where the sun hung near the horizon for a long time. All the accounts taken together allow us to ascertain the time of day when Joshua told the sun to stand still.

Some of the world's accounts of the long day are vague and unspecific while others are quite clear. Among the former are those which relate only that people knew that the sun, moon, and stars can reverse their motions. An example of one of these is the account referred to by Augustine in *The City of God* where he quotes the *Aeneid* about a witch who:

...can reverse the wheeling of the planets, halt rivers in their flowing.²¹

Joshua's Long Day in Africa

Toward the end of the last century, Charles Adiel Lewis Totten (1851-1908), then a retired Professor of Military Science from Yale University, published a controversial study on Joshua's long day.²² The book deals extensively with Joshua's long day and Hezekiah's sign. In recent times attempts to discredit it center more on the person of Totten than they do on the mathematics and science involved. Totten was the editor of *Our Race*, a publication devoted to the promotion of what today is called "British Israelism." Totten's stance was, however, eminently more realistic and moderate than that taken by today's British Israelitism movement. Robert Olden²³ said Totten obtained most of his material from J. B. Dimpleby of South Hackney, England, who was the premier chronologist of the British Chronological Society. Lest Totten be

accused of plagiarism, Dimbleby is cited numerous times in Totten's works. Totten has been accused of worshipping the Great Pyramid of Giza, from which, it is claimed, he received his inspiration for his work on Joshua's long day. Actually, the pyramid worship sounds more like Dimbleby, for a reading of Totten's works on the Great Pyramid reveals none of the mysticism with which Olden accused him.

Flawed though some of Totten's works might be, in his book, he relates two independent and geographically distinct accounts of Joshua's long day. One of Totten's sources is a report by the Greek historian Herodotus who wrote that when he visited Egypt, the priests there showed him an ancient manuscript which told the story of a day which lasted about twice as long as a normal day. Now the Egyptians had water clocks that could accurately measure the duration of the day; others, dependent on the motion of the sun, moon, and stars, would have no independent way to measure time. The second of Totten's sources is from the Chinese, and we shall present that later.

For the Egyptian account, we find that the French classical scholar, Fernand Crombette (1880-1970), translated some Egyptian hieroglyphics telling of Joshua's long day.²⁴ The text starts out with an edict from the king to exempt from taxation those who had been victims of a flood some two weeks earlier. Evidently the flood had been caused by an unusually high tide. The cause, according to the Egyptian hieroglyphics, was:



Figure 2: *Charles Totten*

The sun, thrown into confusion, had remained low on the horizon, and by not rising had spread terror amongst the great doctors. Two days had been rolled into one. The morning was lengthened to one-and-a-half times the normal period of effective daylight. A certain time after this divine phenomenon, the master had an image built to keep further misfortune from the country.

Hephaistos . . . grant protection to your worshipers. Prevent the words of these foreign travelers from having any effect. They are impostors. Let these enemies of the sacrifices to the images be destroyed in the temples of the great gods by the people of all classes. Make life harder for these cursed worshipers of the Eternal. Punish them. Increase the hardships of these shepherds. Reduce the size of their herds. Burn their dwellings.

Rameses, our celestial ancestral chief; you who forced these wretched people to work, who ill-treated them, who gave them no help when they were in need: cast them into the sea. They made the moon stop in a small angle at the edge of the horizon. In a small angle on the edge of the horizon, the sun itself, which had just risen at the spot where the moon was going, instead of crossing the sky stayed where it was. Whilst the moon, following a narrow path, reduced its speed and climbed slowly, the sun stopped moving and its intensity of light was reduced to the brightness at daybreak. The waves formed a wall of water against the boats that were in the harbor and those that had left it. Those fishermen that had ventured onto the deck to watch the waves were washed into the sea.

The tide, which had risen high, overflowed into the plains where the herds were grazing. The cattle drowned represented half the herds of Lower Egypt. The remains of abandoned boats broken against the sides of the canals were piled up in places. Their anchors, which should have protected them, had been ground into them. Quite out of control, the sea had pene-

trated deep into the country. The expanding waters reached the fortified walls constructed by Rameses, the celestial ancestral chief. The sea swept around both sides of the region behind, sterilizing the gardens as it went and causing openings in the dikes. A great country had been turned into a wilderness and brought into poverty. All the crops that had been planted had been destroyed and heaps of cereal shoots lay scattered on the ground.

The Crombette account may be significant for several reasons. It reports that the moon "climbed slowly," which would be correct if the moon kept its orbital speed but stopped its daily motion. If the length of time that the sun stood still was 24 hours, the moon's orbital motion about the earth would carry it roughly as far in earth's sky as the width of a fist held at arm's length. This is allowed by Joshua 10:13's weaker statement on the moon, "and the moon stayed," instead of the stronger "stopped," for "stay" may mean "to linger or wait to witness an event." Likewise, Crombette's interpretation that the moon was going to the spot where the sun had risen is thus explained by having the moon continue its eastward orbital motion and its being located west of the sun, perhaps near last quarter.

Whether or not the tides mentioned in the Egyptian account were really tides or a storm swell cannot be said. It is possible that the tidal bulge kept moving, but if that is the case, one would expect the tide to weaken, to spread out, which makes it unlikely that the narrows of the Nile delta and the narrowness of the canals mentioned caused a bore wave, for then such should always have been the case under normal tidal conditions. It is possible, although unlikely, that the breakup for the tidal bulge may have caused waves which interfered with each other and that Egypt's dikes might have broken at one or two points by constructive interference, thus the resulting flooding. In light of all the evidence, it seems most likely that the events mentioned in Egypt were the result of a severe storm swell in the Mediterranean caused by the very storm that formed the hailstones mentioned in Joshua 10:11:

And it came to pass, as they fled from before Israel, and were in the going down to Bethhoron, that the LORD cast down great stones from heaven upon them unto Azekah, and they died: they were more which died with hailstones than they whom the children of Israel slew with the sword.

Upon reading "in the midst of heaven" in Joshua 10:13 most commentators conclude that Joshua's long day started at noon yet in the Crombette account, the sun is mentioned low in the eastern sky. The Scripture itself does not mention the time when Joshua spake. For comparison with the Egyptian account, and complementing it, there is a West African story of a long night.²⁵ In that account, the night lasted excessively long because the owl overslept and did not awaken the sun. This agrees with the Egyptian account and suggests that the sun may be about half-way up to its highest point in the sky where it crosses the Zenith Circle about noon; in other words, the Israelite time the sun stopped was roughly 9:00 in the morning.

The Chinese Account of Joshua's Long Day

Totten's second secular source about Joshua's long day is based on what seems to be a recently lost ancient Chinese manuscript. In 1810, John Gill presented this account:

In the Chinese history²⁶ it is reported, that in the time of their seventh emperor, Yao, the sun did not set for ten days, and that men were afraid the world would be burnt, and there were great fires at that time; and though the time of the sun's standing still were enlarged beyond the bounds of truth, yet it seems to refer to this fact, and was manifestly about the same time; for this miracle was wrought in the year of the world 2554, which fell in the 75th, or, as some say, the 67th year of that emperor's reign, who reigned 90 years.²⁷

Now the year of the world 2554 is identical to my independently derived biblical chronology for the date of Joshua's long day.²⁸ Incidentally, note that a 90-year reign (not Yao's age) is thoroughly consistent with the 110 to 120 year ages achieved by Moses, Aaron, and Joshua who would have been contemporaries of Yao.

Despite the solid-sounding account by Gill, Chinese manuscripts surviving into the twentieth century do not match Martin's description (Martin was Gill's source for the account). The first mention of the long day associated with emperor Yao was Hübner's in 1733.²⁹ Although Hübner was quoted throughout that century, no copy of his work exists today. Those manuscripts that have survived to the present differ from Hübner's in at least two ways: first, there is no mention of the ten-day day duration, and second, the reign of Yao is reported to be 100 years, not 90.

Although there is no mention of the ten-day long day in surviving Chinese accounts, there is one in the "Brahman Yast," one of the books of the *Avesta*. That reference is not, however, to a past event. Instead, it is a prophecy. The *Avesta* says that 1600 years from the date of the Persian culture (corresponding to about A.D. 1200), Hushedar will be born and, at age 30, he will command the sun to stand still for 10 days and nights. Obviously, the prophecy never happened; still it is strongly reminiscent of the Chinese account and may either have confused Hübner or else may reflect the actual Chinese account used by Hübner.

Joshua's Long Day in North America

Tales relating to Joshua's long day abound in North America. Almost all of the tribes in North America tell of a long night. The only exceptions are those related in the chapter on Hezekiah's sign. Olcott³⁰ has collected five of particular interest. 1) The Ojibways tell of a long night without any light.³¹ 2) The Wyandot Indians told missionary Paul Le Jeune of a long night.³² 3) The Dogrib Indians of the Northwest tell of a day when the sun was caught at noon and it instantly became dark.³³ 4) The Omahas say that once

the sun was caught in a trap by a rabbit that checked its traps at the break of dawn, presumably before sunrise.³⁴ (This may be Hezekiah's sign, too.) 5) Lastly, the Bungee Indians from the Lake Winnipeg area of Canada also tell of a long night.³⁵

In addition, the tribes of the Painted Desert region also tell of a long night,³⁶ as does the Tête de Boule tribe (Iroquois) tell of how Teikabis set a snare for the sun which, when caught, instantly became dark and the darkness persisted until a mouse chewed through the snare to release the sun.³⁷

The preponderance of long night tales in the Americas would rule out the speculation that Joshua's long day was a miracle which was local to Canaan. It also rules out the speculation that the story migrated around the world, for then it would everywhere be a long day, not a mixture of long days and long nights.

The Long Night in the Central and South Americas

Turning to the south, we find that Central and South America similarly experienced a long night. In the *Annals of Chauhtitlan*, the Mexican Indians tell of a long night. The Aztecs wrote of an extended period of time when the sun did not rise. According to their account, there had been no sun for many years.

... So a conclave of the gods was called in Teotihuacan, and there it was decided that one of them should offer himself as a sacrifice that once again the world might have a sun ... The sacrificed gods had disappeared in the brazier's flames, but as there was no sign of the sun, the remaining wonder when it would first appear. At long last, the sun burst forth ... But the sun, despite his brilliant light, did not move; he hung on the edge of the sky, apparently unwilling to begin his appointed task.³⁸

Likewise, in their national book the *Popol Vuh*, (which translates into "Book of the Princes,") the Quiche-Mayans of Guatemala wrote about the people's reaction to a long night with these words:

They did not sleep; they remained standing and great was the anxiety of their hearts and their stomachs for the coming of the dawn and the day ... "Oh, ... if we only could see the rising of the sun! What shall we do now?" ... They talked, but they could not calm their hearts which were anxious for the coming of the dawn.³⁹

Now in recent years it is fashionable to assail the above translations on the grounds that they are biased towards the Judeo-Christian history of the world. For example, the Aztec god who sacrificed himself was to have the honor of becoming the sun. His condition for rising was that the gods kill themselves, which they ultimately were forced to do.⁴⁰ It seems to the critics that this is a creation myth rather than an account of Joshua's long day, but the nature of Central American folk tales is very complex. For example, according to the myth there had been a sun before, and it had not risen for so long that people feared it dead. So how is it a creation account?

A similar situation exists with the *Popol Vuh*. According to some, that entire work is nothing more than one long creation myth. But the creation of man comes very late in the *Popol Vuh*, long after people have existed and had many adventures. The text quoted above from Goetz and Morley lies embedded in a lengthy section which starts with the longing and waiting for the sun, digresses into the origin of fire, and makes mention of the parting of the sea for the newly-arrived forefathers before resuming the story of the long wait for the dawn. If this is a creation account which occurred before the creation of man and which speaks of the creation of the sun, why are there many priests and tribes in existence? Why the reference to the forefathers who existed then if man had yet to be created? Such situations are typical in the literature of that region and time, and it may easily be understood in the light of the purpose of these tales: they exist to tie together salient pieces of history. So it is, too, with the Aztec tale. There was a long night, but the story has been expanded almost beyond recognition. Simi-

larly with the *Popol Vuh* there is evidence of changes in the tale even over the last few centuries.

As for the charge that early translators were biased, are the anti-Christian translators not equally biased for their view? The fact remains, there are references here to a long night, entirely consistent with the many accounts around the world if Joshua's long day is true. If the translators' charges of Christian influence was correct, then the tales would all have been of a long day, not night.

Besides the accounts of a long night in North and Central America, there is also at least one story of a long night in Peru. According to Montesinos, the collector of the tale, the sun was hidden for nearly 20 hours in the third year of the reign of Titu Yupanqui Pachacuti II because of sin in the land.⁴¹ Titu Yupanqui Pachacuti II ruled about 1400 B.C. The best date for Israel's entry into the Promised Land is 1444 B.C.

Long Sunrise and Sunset Accounts

We have reported on stories of a long day and stories of a long night: are there any stories of a long sunrise or a long sunset? There may be some uncollected stories of a long sunrise in Africa, but none have surfaced. There is, however, a story of a long sunset in the Fiji Islands. J. G. Frazer tells of a tradition on the island of Lakomba in the eastern Fiji Islands where there is a hillside with a patch of weeds on it. The story goes that natives will tie the weeds together in order to keep the sun from going down. It is said that the sun did, indeed, stop from setting at one time.⁴² Olcott reports that Fijian travelers, fearing they may not reach their destination before sunset, will tie the reeds on that hill together to restrain the sun. Apparently, the source for that tradition was the sun stopped at sunrise during Joshua's long day.⁴³

The story of the arrested sunrise is found in Hawaii, where Maui used a vine to trap the sun to slow it down. However, he traveled to the east to snare the sun at sunrise, not to the west to snare it at sunset; this account either is a source of or derives from the Peruvian account we'll cover in connection with Hezekiah's

sign. As in the Peruvian account of Hezekiah's sign, Maui also built two towers to hold his snare. (See Chapter 9.)

There is a Japanese account that may be a tale of the sun stopping in the early dawn. It involves the sun goddess Amaterasu and her rude, wild, and uncontrollable brother Susanoo who was banished to the underworld by his father. Amaterasu and Susanoo had a violent feud which ended in a contest for which both claimed victory. Eventually Amaterasu had enough and fled to a cave called Iwayado (Earth), rolling a gigantic boulder at the entrance only she could remove. As the incarnation of the sun disappeared into the cave, darkness covered the world.

The gods and goddesses of heaven assembled to persuade her to come out because her absence would have critical consequences upon the earth. After all, eternal winter and eternal night will bring cold and famine, fear and distress, despair and death to the world. Each of the gods and goddesses took turns at coaxing Amaterasu out of the cave, but she ignored them all. Finally, the spirit of merriment, Uzume, the goddess of dawn, hatched a plan. She hung a large bronze mirror on a tree facing Amaterasu's cave. Then Uzume danced on an inverted washtub, drumming the tub with her feet. All the male gods roared with laughter, and Amaterasu became curious. When she peeked out from her long stay in the dark, a ray of light escaped and Amaterasu, was dazzled by her own reflection in the mirror. While she was distracted, the god Ameno-Tajikarawo pulled her from the cave which was quickly sealed with a rope. Surrounded by merriment, Amaterasu's depression vanished and she agreed to return her light to the world. The gods lynched Susanoo and peace was restored in heaven.

Olcott mentions another version of this story where the goddess left the cave through entreaties and supplications.⁴⁴

If this is a long-day story, it would have come from the panhandle of Alaska or the northwest coast of British Columbia. Being in the spring and the sun rising in the east as its diurnal motion resumed, ice crystals in the western sky could have reflected the sunlight like a mirror. Those are called "sun dogs," and the color

imposed on it by the dawn would give it a bright, bronze colored hue which may have led to the story of the mirror.

Of course, Alaska is not Japan, so there is some speculation here as to the location of the events. We consider that if this is a long-day account it must fit the evidence consistent with the rest of the world. It is entirely possible that the Japanese, as an island nation, sailed the Aleutians and eastward and may have had settlements on the west coast of North America. The tale is only known on the north island of Japan which may have been settled by Chinese or Japanese traders at the end of Michael Oard's ice age, ca. 1800 B.C.

Most commentators claim this is a myth about the creation of the dawn, but like so many dismissals assigning tales of Joshua's long day and Hezekiah's sign to the category of creation myths, the dawn already existed prior to the start of the sun's retreat into the cave and so cannot be a creation myth.

Although there are several other traditions of stopping the sun, most are remotely, if at all, connected to Joshua's long day. In Australia, for example, if a native wanted to stop the sun he would place a piece of sod in the fork of a tree facing the sun. Similar traditions exist in Africa and in Central America. A tradition of that nature in Japan meant nothing more than the belief that a man's friends would await dinner for him if he was going to arrive home late. Still, underlying all but the last of these traditions is the idea that the sun did stop at least once upon a time.

The Extra-Long Night

Three peoples have a tale of a night which may have lasted more than a day. The Japanese account mentioned earlier has more events than might reasonably fit into a single day. The same may be said of the long-night tale of the Cherokee Indians of North America, which tale also tells of the sun hiding in a cave and being tricked out.⁴⁵

An account of a long night in Lithuania was collected by Jerome of Prague when he visited the peoples of the area in the

early fifteenth century. There he discovered a tribe which had migrated from the east and which told tales of a night lasting several months. This most likely refers to the long Arctic night. A two-month night is experienced about the latitude of Point Barrow, Alaska.

There are two possible reasons for these accounts. All could be related to the Japanese account, although it seems not to set a duration for the sun's absence, and could reflect either a volcanic eruption which darkened the sky over Japan and Siberia for months on end or else, it could be a tale of the long Arctic night, almost six months long at the pole. Perhaps the accounts relate to these natural events. In any case, in their duration, they stand in stark contrast with the other long-day and long-night tales from around the world.

Joshua's Long Day and the Computers

In the late 1970s and early 1980s two stories appeared in print about a computer finding a missing day. The first is told by Harold Hill in his book, *How to Live Like a King's Kid*.⁴⁶ In Hill's own words:

When NASA's Goddard Space Flight Center here at Greenbelt, Md. first went on the air, a horrendous technical boo-boo surfaced, causing a complete shutdown [of the computer] after less than an hour's operation.

I was called in as an outside consultant and came up with a "quick-fix" that saved the day for them.

After things fired up I stayed around as an interested observer, to catch the very beginning of our Space Exploration activity. That was somewhere back in the sixties. ...

A large team of IBM technicians was present to debug the system and get it running. No one really knew much except that it looked O.K. on paper.

It was during that time that I heard about the aberration in the location of the Heavenly bodies that led to the Bible account of how the MISSING DAY incident came about.

I was not the one who came up with the Bible answer, nor do I know the names of those involved. I simply reported it as it came to me and used it in my lectures on the Bible and Science, which I frequently deliver in schools and Colleges in Science Seminars.

A Newspaper reporter in Spencer, Indiana [Mary Kathryn Bryan in 1970] came across a copy, and fed it into the major News Services. To date I have received over 10,000 letters from all parts of the world.⁴⁷

Many have correctly pointed out that computers do not stop "and put up a red flag."⁴⁸ Some have reported that Hill has retracted his story, but that is not true. Hill still maintains its veracity even though NASA has disavowed any knowledge of him, and others have charged him with various degrees of fraud. It has also been suggested that Hill had based the story on Totten's book,⁴⁹ but Hill claims not to have known of the Totten book at the time.⁵⁰ However, the main problem with Hill's story is that it would require an independent date determination for some event such as an eclipse of the sun prior to Joshua's long day in order to find a missing day. The most ancient of these observations does not go back as far as 1,000 B.C., let alone 1,448 B.C., the most likely date for the long day. Still, Hill's story raised quite a bit of interest.

A second computer account of a missing day appeared in the Swedish *Goteborgs Tidningen* on March 15, 1981. According to that story, Stig Flodmark of the University of Stockholm had discovered that the earth's axis had flipped on May 3, 1375 B.C. and associated that with Joshua's long day. This proposal is the same as that of Rand who was mentioned earlier in this chapter. According to Flodmark, an Ugaritic astronomer described the event and gave the date. Flodmark refers to a book entitled *Tidal Friction and the Earth's Rotation*.⁵¹ The comment by the author of the quoted paper, F. R. Stephenson, in summarizing the Ugaritic ob-

ervation, is "Sun put to shame; went down in daytime." This hardly describes a tippie-top phenomenon, especially with Gibeon at the rotational north pole for the day, for the sun would have been circumpolar for the Ugaritic astronomer; it would not have gone "down in daytime."

Related Verses

Joshua 10:13 does not stand alone in Scripture. There are several similar verses. One of those is found in Habakkuk 3:11 which states:

The sun and moon stood still in their habitation: at the light of thine arrows they went, and at the shining of thy glittering spear.

Now Habakkuk 3:11 is a double reference: in the first instance, it refers to a future event foreseen by Habakkuk; and in the second instance, it points back to the taking of Canaan, back to Joshua's long day. As such, we may consider it as a unit with Joshua 10.

An apparent prophetic reference to Joshua's long day is found in Job 9:7 which seems to foretell the events described in Joshua 10. It is evident that Job was most likely a contemporary of Abraham or, at least, Job lived no later than Joseph or his sons.⁵² The verse reads as follows:

[God] commandeth the sun, and it riseth not; and sealet up the stars.

The Date of Joshua's Long Day

We noted that the entry into the promised land was early April of 1448 B.C. Can we ascertain the month and day of Joshua's long day with any degree of certainty? It turns out that we can come close.

When the Israelites entered the Promised Land it was the tenth day of the first month (Joshua 4:19), shortly before the time of the Passover which is at the time of the full moon. Now in 1448 B.C. the new moon and the first day of spring closely coincided, the first day of spring being March 19.5 at the time;⁵³ so we can date the very entry into the promised land as Thursday, March 29, give or take a day.

The events, which are described between the Passover and the battle at Gibeon, all took time. The Passover celebration itself took a week; the fall of Jericho took seven days; the fall of Ai took at least four days; the construction of the altar on mount Ebal and the copying of the law probably took a week or more; the trickery of the Gibeonites took still more time; the communication of that trickery to the Gibeonites' neighbors and the subsequent formation of an alliance, not to mention their march to Gibeon, all took time. It is reasonable to assume that over a month passed between the celebration of the Passover and Joshua's long day. This is entirely consistent with the geometry of sun and moon presented in Joshua 10 where the moon seems to be west of the sun and both visible in daylight. Given that the time for the event was about 9:00 a.m., the moon was most likely near or after its last quarter. More specifically, then, it appears that Joshua's long day happened somewhere between May 8 to May 15 of 1448 B.C.

The Commentators Concluded

It should be painfully clear by this time that not only was Joshua's long day a real miracle, but also it presents man with a great problem: either God writes what he means and means what he writes, or he does not. Most Christian scholars over the centuries have fostered the impression that God needs them to make his truth known, that God is incapable of explaining certain matters to man without their help. This is why most churches hold tradition over the authority of the Bible. Joshua 10:12-14 strikes at the heart of this heresy.

In the twelfth verse of Joshua ten, it can be argued that when Joshua spoke, he was simply ignorant of the rotation of the earth and thus assumed the sun and moon were moving. Hence he spoke geocentrically. This would not introduce an error in the Bible since this is a direct quote. All that inerrancy requires is that the quote be an accurate quote. That's fine and well for Joshua, but what of the thirteenth verse? Who is the author who reports that the "sun stood still, and the moon stayed?" The Bible says that "all scripture is given by inspiration of God" (II Timothy 3:16). Verses 13 and 14 of Joshua then present us with the point of view of the author, and that author is God himself. God cannot lie, so this point of view must be true. If the perspective is not true, then either God is lying or someone else is responsible for the wording. If the author is not God then who is he? And just what is that person doing putting words in God's mouth? If this verse cannot be trusted, then how can we trust any other Bible passage? Could not the same shadow of doubt be cast onto any other particular passage of scripture? And what, then, becomes of the Bible's witness of itself in such passages as II Timothy 3:16-17? Or if the commentator is God himself, is he speaking phenomenologically or anthropocentrically? Or is that impossible?

For the moment, let us assume that God is speaking either anthropocentrically or phenomenologically. Let us further suppose that this is not the only place in the Bible where God does so but that, in particular, he does so in all geocentric passages. Then what does that mean? Just what does it mean to speak *anthropocentrically* or *phenomenologically*?

Anthropocentrism literally means "man-centeredness." In this view God puts himself in man's place and speaks from a human perspective. Given that the Word became flesh and dwelt among us, this is not at all far-fetched, but does this really excuse the God of Truth, who is the Truth, from writing the whole truth and nothing but the truth? God forbid! Note how simply God could have avoided the contradiction between heliocentrism and geocentricity if instead he had started the thirteenth verse with: "And the earth stopped its turning" God does not go out of his way to avoid

difficult wording just for the sake of simplicity (Proverbs 1:22^{*}). Nor does He express the science of the Bible in simple terms. Take Job chapter 38, for example, where two or three “puzzling” and “poetic” passages have in recent years been found to be literally true; yet most of the chapter is completely above man’s comprehension. Simply put, God does not speak anthropocentrically because God is not a man.

Phenomenology is a science which deals with appearances rather than with actual existence (the study of the latter is called *ontology*). Phenomenology is based on the observation that appearances can be deceiving. Thus when one claims that Joshua 10:13 is *phenomenological*, one effectively claims that God is not presenting the situation as it *actually* is but only presents it as it *appears to be*. If the appearance is not the same as actual fact, then in the final analysis God is not relaying accurate information about the situation. For the sake of “convenience,” God wrote an untruth. God presented the appearance of the situation as the truth rather than presenting the truth as the truth: this is what one means when one says that the Bible speaks *phenomenologically*.

One time, as I described my research into Joshua’s long day, a biologist insisted that the long day was a hallucination that beset Joshua and his army. When I told him that the phenomenon was observed worldwide, his response was that it still had to be a mass hallucination and that he had faith that eventually the young science of phenomenology would explain how half the world could hallucinate a long day and the other half a long night.

Phenomenological or anthropocentric: either the sun stood still or the earth stood still; either God inerrantly inspired the wording or he did not; either the Bible is trustworthy or it is not. There is no middle ground. There is no room for compromise. After all, both the anthropocentric theory of inspiration and the phenomenological-language theory are forms of *accommodation* where God is said to accommodate his wording to the understanding of the

^{*} Proverbs 1:22—How long, ye simple ones, will ye love simplicity? and the scorers delight in their scorning, and fools hate knowledge?

common man. Good though that may sound on the surface, accommodation still maintains that God goes along with the popularly accepted story even though he really knows it is not true.

The whole issue would be moot if, as the liberals and infidels claim, the Bible was written by men and not God. Belief in the human authorship of Bible earmarked the Sadducees in Christ's day and still earmarks their spiritual descendants, the liberals, today. The Pharisees recognized the truth about the authorship of the Bible but failed to live up to that fact. When confronted by the truth of their hypocrisy they became enraged rather than repentant. Today's Pharisee is no different, reacting with violent rage when confronted by these matters. Still, let God be true and every man a liar (Romans 3:3).

Putting It All Together

When it is all put together, we know more about Joshua's long day than we know of most other events recorded in the Bible. The best date seems to be within four or five days either side of May 12, 1448 B.C., sometime between 8:30 and 9:30 a.m. This we may conclude from plotting all of the long-day, long-night, and the long-sunset accounts on a globe. Such extensive observations preclude the conclusion that the event was an optical illusion restricted to the land of Israel. It also disallows the notion that Joshua's long day is fictitious, for the testimony of the peoples around the world is entirely consistent with its reality. That some peoples have tales of a long night while others tell of a long day yet none have both a long-day and a long-night tale signifies that Joshua's long day is not one account, originating in the mid-East, which has migrated all over the world; for if such were the case, then all nations would tell of a long day and none would tell of a long night, let alone a perfectly-placed long sunset. So we must conclude that Joshua's long day was a real, historical event and not some fiction.

Despite the testimonies of various peoples around the globe to the reality of a long day or night, and despite the geographic con-

sistency of the data in terms of day and night, why should the majority of scholars dismiss this wealth of evidence as mere superstition? How could there be more substantial evidence? On the other hand, we shall have occasion to document examples where modern science has accepted the testimony of one individual of dubious integrity and rejected common sense. There's a screw loose somewhere.

Actually, the heliocentric/geocentric debate is not new, nor is it secret, but the stakes are high and rarely mentioned; for absolute authority is itself at stake. Just who is authoritative and in what? If doubt can be cast on the Holy Bible as an authority in the area of science, then that leaves scientists as the final authority in that area. All too often science is merely a tool of politicians with little regard for truth if the truth is not expedient. The anthropogenic global cooling panic of the 1970s and the anthropogenic global warming scam at the turn of the millennium, not to mention the absurd macro-evolution, all serve as prime examples of science subverted by politics. Thus it can be said quite literally that today's science is tomorrow's superstition and the day-after-tomorrow's point of derision. That was as true in the sixth century B.C. as it is true today.

Conclusion

There appears to be solid evidence from the Bible and from folklore around the world that there was one day which, depending upon geographical location, presented the inhabitants of the earth with an unusually long span of daylight or night. Attempts to explain this phenomenon by naturalistic means have all failed because no mechanism known to physics can absorb the earth's spin energy and momentum (or the universe's from a geocentric point of view) in such a short period of time without causing great upheavals such as the oceans spilling over the continents. Most scholars, be they agnostic, Christian, or atheistic, choose to ignore the ancient witnesses, Scripture included. Such a phenomenon as Joshua's long day is an embarrassment to their intellect because it

can only happen with divine intervention. The embarrassing truth is that God, and not man, is the ultimate intellect. The Copernican Revolution is based on the assumption that man is the measure of all things. That man is the measure of all things is the central tenet of the religion of humanism.* But then true science does not claim to have all the answers: it freely admits that its authority is ultimately found wanting. We are forced to conclude that the Bible is the final authority on all matters that it touches upon. But that is impossible if God said that the sun stopped when it was *actually* the earth which ceased to rotate. And is the heart of the matter.

Attempts to phenomenalyze Joshua's long day or to make it allegorical thus fail. First, attempts to phenomenalyze Joshua's long day and Hezekiah's sign fail on historical grounds. Phenomenalization efforts are geared to denying the reality of the event, but the witness of the world's folklore can only assert that the long day was a real event, global in scope. Second, the only reason to phenomenalyze the long day and the sun's ten-degree return, which is commonly called "Hezekiah's sign," is that these things are impossible in man's understanding and wisdom. We are taught from cradle to grave by our rulers, teachers, and ministers that science has proven the earth rotates and orbits the sun. Given these things are facts; the Bible cannot be true unless we change the interpretation of the Bible to line up with scientific proof. The problem is that science has proven nothing of the kind. The daunting "proofs" for heliocentrism—the geostationary satellite, the Foucault pendulums in museums around the world, eastward rocket launches, weather patterns, and all such effects—prove nothing more than that there exists a relative rotation of earth and cosmos. In no way can it prove which, either earth or cosmos, does the rotating. We assert this claim now without proof. Our proof will constitute much of the rest of this book.

* The humanists of the American Humanist Association all deny that theirs is a religion; but the AHA was organized circa 1935 as a 501C-3 *religious tax-exempt organization*. Thus, by their own and government decrees they are a religion, a religion that believes the hope of man lies with humanism's god-man, that is, with himself.

The world is presented with a real historical event in Joshua 10:12-14. The central issue is that of the infallibility of the Holy Bible. God wrote in verse 13 that the "sun stood still and the moon stayed." Either God meant what he wrote, or he did not. There is no excuse for God to misrepresent the matter because he is the God of truth; therefore all things he says and does must reflect that fact. So God cannot utter an untruth and we must conclude that the Bible teaches, in Joshua 10:13 and elsewhere, that the universe rotates around the earth once per day, carrying the sun, moon and stars with it, regardless of what introductory astronomy texts may say. We shall see later that the advanced texts belie the introductory texts on the matter of the rotation of the earth. For the time being, the choice is either the Bible or the introductory astronomy texts: which do you believe?

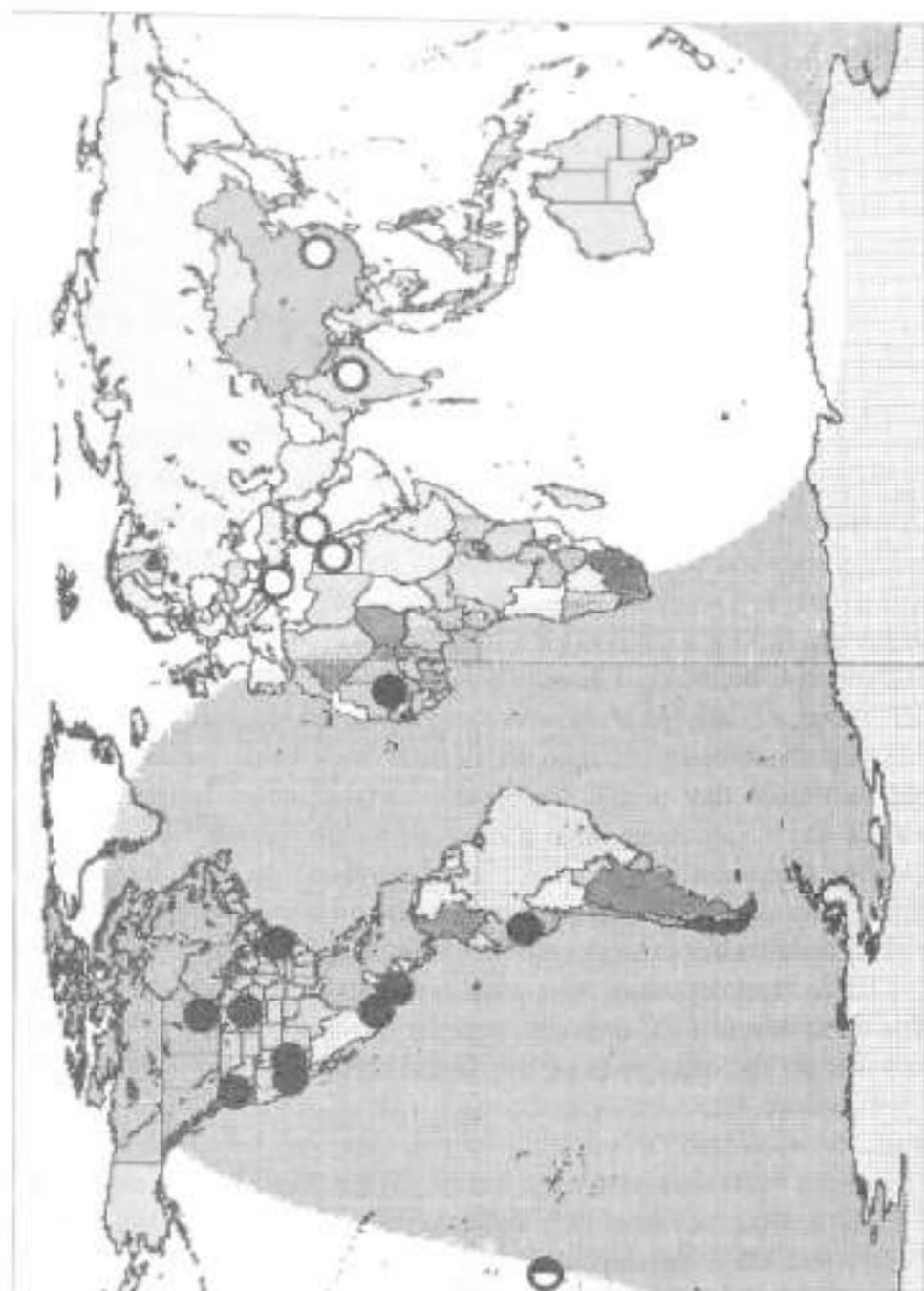

Figure 3: *Joshua's Long Day Around the World.*

Open circles map accounts of a long day

Dark circles map accounts of a long night

The half-filled circle locates an account of a long sunset.

And Hezekiah answered, it is a light thing
for the shadow to go down ten degrees.

— 2 Kings 20:10

9

HEZEKIAH'S SIGN

Three times, in three different places, the Scripture tells the story of Hezekiah's terminal illness, his appeal to God for recovery, and God's gracious promise of recovery accompanied by a sign to assure Hezekiah of the truth of God's promise. The three places are II Kings 20:8-11, II Chronicles 32:24, and Isaiah 38:1-8. Historically, believing Christians and Jews have taken the sign at face value, namely, that the sun went back ten degrees in its daily path and from there retraced its regular westward motion. If so, that particular day would have been forty minutes longer than a normal day. But those who do not know the power of God will disagree that such is the correct interpretation. In this chapter we shall examine the various interpretations and denials of the sign, as well as confirming evidence collected from around the world.

Bible commentators who want either to deny the reality of the sign or to invent a naturalistic explanation thereof almost all concentrate on the first two of the three accounts. We begin with II Kings 20:8-11:

⁸ And Hezekiah said unto Isaiah, What shall be the sign that the LORD will heal me, and that I shall go up into the house of the LORD the third day?

⁹ And Isaiah said, This sign shalt thou have of the LORD, that the LORD will do the thing that he hath spoken: shall the shadow go forward ten degrees, or go back ten degrees?

¹⁰ And Hezekiah answered, It is a light thing for the shadow to go down ten degrees: nay, but let the shadow return backward ten degrees.

¹¹ And Isaiah the prophet cried unto the LORD: and he brought the shadow ten degrees backward, by which it had gone down in the dial of Ahaz.

It's All the Shadow's Fault!

If all we had to work with was the above text, it may legitimately be argued that since only the *shadow* on the sundial ("dial") is mentioned, only the shadow on the sundial went back and the sun did not participate in producing the sign. That day was then a normal 24-hour day as far as the rest of the world was concerned. The sun did not change position in the sky; only the sundial's shadow went back. Effectively this makes the sign an "optical illusion" which could be witnessed only on the sundial which Hezekiah's father, Ahaz, had built. If this were all that the Bible says about the event then we would be justified in concluding just that.

It Was Confined to Judah!

The second account, found in II Chronicles 32:24, adds no details to the event; it merely confirms its reality by saying:

In those days Hezekiah was sick to the death, and prayed unto the LORD: and he spake unto him, and he gave him a sign.

After Hezekiah's recovery, Isaiah 39:1-8 reports that, Merodach-baladan, king of Babylon, sent ambassadors to Hezekiah to inquire about the sign and Hezekiah's miraculous recovery. Hezekiah regally received them and showed them all the riches with which the Lord had blessed him. This flagrant demonstration of pride displeased the Lord, for in the thirty-first verse of II Chronicles 32:31 we read:

Howbeit in the business of the ambassadors of the princes of Babylon, who sent unto him to enquire of the wonder that was done in the land, God left him, to try him, that he might know all that was in his heart.

Noting the use of the word "land" to describe the location of the sign, some heliocentric apologists have concluded that the sun's apparent position in the sky was only visible in the land of Israel. Advocates who say that only the dial's shadow was affected see this verse as confirmation since the purpose of the miracle only pertained to the land of Israel. This makes the sign an optical illusion visible only from Jerusalem or Judea. Given just the two accounts seen thus far, such a conclusion may be deemed feasible.

The Sun Did It After All!

The third account of Hezekiah's sign is found in Isaiah 38:1-8 where only the last two verses shed any new light when it is there written:

⁷ And this shall be a sign unto thee from the LORD, that the LORD will do this thing that he hath spoken;

⁸ Behold, I will bring again the shadow of the degrees, which is gone down in the sun dial of Ahaz, ten degrees backward. So the sun returned ten degrees, by which degrees it was gone down.

The eighth verse forces a radical modification of the above conclusions, for it states that the sun, not just the shadow, returned and retraced its path. This eliminates all conjecture that only the shadow on the dial was affected and also explains why most heliocentric apologists ignore the Isaiah passage.

Thus we are left with two alternatives: first, that the sun actually went back ten degrees as the Bible says; or second, in light of the reference to the "land" in II Chronicles, that the sun appeared to go back only in the land of Judah. But this second alternative

discounts the fact that Isaiah 38:8 states quite explicitly that the "sun returned ten degrees." If it was only an optical phenomenon and not a real returning, should it not have been reported as such?

So what of the reference to "land" in II Chronicles 32:31? Does it not appear to contradict the sun's *actual* regression implicit in Isaiah 38:8? Note, however, that the II Chronicles passage speaks of the "wonder" instead of the "sign." It



Figure 1: Hezekiah's Sign from the Coverdale Bible.

was the *wonder* that was done in the land. The wonder, as a whole, includes God's speaking to Hezekiah and his miraculous recovery, as well as the solar sign. Since Hezekiah was king of the land at the time, it would certainly be correct to refer to the wonder as being "done in the land" without limiting the scope of the effect of the sign to the land of Judah.

The straightforward reading of the three accounts of Hezekiah's sign indicates that the sign was global in extent and that the sun went back ten degrees in the sky, thus lengthening that day by forty minutes for the entire world. It also indicates that the sun did the moving and not the earth. Furthermore, it implies that the sign may have been observed in other countries beyond Israel.

Degrees or Steps?

In their efforts to make Hezekiah's sign more "in accord with modern science," the authors of today's bible versions have oft-times compounded their problems with the Scripture, for they always prefer their faith to be in science than in the literal truth of

Scripture. One ploy has been to cast doubt on the authority of the Hebrew Masoretic text. The translating committee of the *Revised Standard Version*, for example, totally ignored the Hebrew wording and, on the basis of one Syriac manuscript, replaces “by which it [the shadow] had gone down on the dial of Ahaz” with “by which the *sun* had declined on the dial of Ahaz.” (Emphasis added.) By changing the subject from shadow to sun they present the ludicrous image of the sun descending the sundial as if it were walking down a series of steps. This linguistic error they repeat in Isaiah 38:8 after adding a footnote to the effect that the Hebrew is “obscure.” Of course it is obscure—if one rejects the literal sense of what is written and still wants to assert its veracity.

The use of the word “degrees” has also been challenged. In his book, *The Astronomy of the Bible*, Edward W. Maunder¹ constructed an elaborate scenario based on the use of “steps” instead of “degrees.” Maunder speculated that the “steps” were part of the temple and that the Bible does not really refer to a sundial at all. He proposed that an accidental arrangement of temple pillars cast a shadow on a staircase built by Ahaz as a private entryway from his palace to the temple. In the course of the day, the shadows of the pillars would appear to “ascend” the staircase. In Maunder’s opinion, the “sign” was a routine, daily occurrence and involved absolutely no change at all in the motion of the sun.

There are three problems with Maunder’s speculation.

1. Ahaz so hated the Lord that he had the temple boarded up. It is most unlikely that he would build a special staircase linking the palace to the temple.
2. Isaiah 38:8 specifically specifies that the shadow was on a “sun dial,” so it could not be on steps.
3. There is good reason to doubt that “steps” is the correct translation of the Hebrew word *mahalah*, and that “degrees” is the correct translation.

Concerning the third problem above, in English, the word “degree” means one three-hundred-sixtieth ($1/360^{\text{th}}$) part of a cir-

cle. Superficially, this would seem unique to modern times, for one might reasonably expect that today's system of measuring angles is different from that of the ancient Hebrews. One wonders just what fraction of a circle is represented by the Hebrew word, *mahalal*; especially since it also appears in the prefaces to many of the Psalms.⁷ Bible critics insist that no one can know the correct meaning of *mahalal*, but it turns out that the Babylonians measured angles with a unit of measure whose name is identical to the Hebrew word under consideration. Interestingly, that Babylonian unit amounts to 1/360th of a circle. This is exactly the definition of our modern degree. Thus the King James translation is correct and modern versions miss the mark by changing "degrees" to "steps." Ten degrees means ten degrees after all; and given that information, we know that the sun instantly turning back ten degrees would lengthen that particular day by forty minutes.

Attempts at Naturalistic Explanations

Attempts to explain away Hezekiah's sign as a non-miraculous event have produced some very unusual proposals. Some have suggested that there was an earthquake at Jerusalem which tilted the ground just enough to tip the sundial by ten degrees so that the shadow appeared to "go back" ten degrees. But then why was there no mention of the earthquake? It would certainly have been noted by Isaiah. Earth tremors are not unusual in the environs of Jerusalem which weakens the value of the sign as a sign.

Others have suggested that the sundial was improperly mounted; that as a result, the shadow only *appeared* to retrace its steps at certain times of the day. But if such were a daily occurrence then it would be no sign at all. Furthermore, no one has ever demonstrated just how a sundial might be mounted so that a shadow would retrace itself during the course of the day; such a "mis-mounting" is physically impossible. Certainly no regular

⁷ The Authorized Version always translates *mahalal* as "degree."

sundial could accomplish such a feat, although Christopher Schissler of Augsburg, Germany, did in 1578 construct a bowl-shaped sundial which, upon water being poured into its bowl, will make the shadow of a wire go back as much as twenty degrees. It was not built as an explanation of the miracle but as a demonstration device.²

Another naturalistic proposal is that there was a partial eclipse of the sun that day at Jerusalem. An eclipse of the sun happens when the moon passes between the sun and the earth, and a partial eclipse occurs in those places where the sun is partly obscured. As a result, the speculation proposes that the shadow was "off-center" for the duration of the eclipse. Such a proposal may sound good on the surface but there are two serious problems with it. First, if such an effect does happen during an eclipse, then it would at most amount to half of a degree, certainly not to ten degrees. Secondly, the closest total solar eclipse during the reign of Hezekiah, an eclipse visible from Jerusalem, was 11 January 689 B.C. That eclipse was more than twenty years too late. Hezekiah was long dead by that time, let alone having another fifteen years to live. In short, there is no plausible naturalistic alternative; we are left with no reasonable choice but to take the text literally.

One could, of course, dismiss the sign as a fabrication, or even as a mass hallucination. We dealt with the latter in the previous chapter while examining Joshua's long day. We may ask, "Are there any other accounts of a similar event elsewhere in the world's folklore?" We answer that question in the affirmative.

Hezekiah's Sign in India

The Hindus have a long epic poem called the *Mahabharata*. The more widely known *Bhagavad Gita* is itself just a part of that epic poem. In section 146 of the *Mahabharata* there is an account of a war which the Hindus date as having happened about 3102 B.C. The story goes that the war was won by the forces of good because of a ruse by the sun god. It had been foretold that the evil forces would win if the battle did not end by nightfall. The battle

proceeded until the sun set in its normal manner and the evil forces began their celebration. Unbeknownst to them, however, the forces of good had made a pact with the sun and as per agreement, the sun retraced its path, rose in the west, and stayed above the horizon for the greater part of an hour. This is precisely what would be expected if Hezekiah's sign was worldwide and occurred mid-afternoon Jerusalem time (about 3 p.m.).

But what of the date? 3102 B.C. is a far cry from Hezekiah's reign which was roughly 700 B.C. Actually, even Hindu scholars themselves discredit the 3102 B.C. date for the war mentioned in the *Mahabharata*. The majority of scholars date the war as happening sometime between 1500 B.C. and 800 B.C. Even at that, a date of 700 B.C. is not all that unlikely; nor is it inconsistent with available evidence. The poem seems to have been written about the sixth century B.C., around the time of Daniel. Even the history of the epic poem is fraught with exaggerated claims, and this is entirely consistent with the degree of unreliability of Indo-Persian historical reporting. For example, one hundred years after being conquered by the Greeks, the Persian historians had no recollection of ever having been conquered by anyone.

And so the *Mahabharata* account appears to describe the same event as Hezekiah's sign but from a different geographical location than Jerusalem and with an appropriately different time of day, as would be expected for a real event.

Hezekiah's Sign in China

Not only do we have the Hindu account of Hezekiah's sign, but also we have a parallel account from China. According to Alfred Forke,³ Huai-nan-tse tells us that in the fifth century B.C.:

When the Duke of Lu-yang was at war against Han, during the battle the sun went down. The Duke, swinging his spear, beckoned to the sun, whereupon the sun, for his sake, came back and passed through three solar mansions.

This would have happened in western China. Further east, in the capitol, it would have been dark throughout the duration of the sign. Hezekiah's sign may account for another ancient Chinese report which states that at the time of Kingcungus, the planet Mars went back three degrees.⁴ There is a problem with the "three degrees" for the regression of Mars. Since the Chinese degree is $1/365.25^{\text{th}}$ of a circle, the three degrees are not nearly enough to match the ten degrees of Scripture; but the measure would have been an estimate since there would have been no background stars relative to which to measure the angle. Furthermore, there may have been a delay of a half hour before a measurement relative to the ground could be made, assuming that the Chinese had both clocks and tables of planetary positions, which seems unlikely. There is yet another account, also mentioned in Forke, which tells that the king of Ch'in promised Prince Tan his freedom if the sun would go back, which it did.

The Bamboo Annals constitute a surviving collection of bamboo strips recording the history of the Yellow River Valley prior to Emperor Shi Huang Di (221-209 B.C.), who ordered their destruction. One of the surviving strips reports that "During the first year of the reign of King Yi, in the first month of spring, the sun rose twice at Zheng."⁵ Astronomers assume that this describes a total eclipse of the sun occurring just at sunrise. As such, they date the eclipse at sunrise of April 21, 899 B.C. All that may well be true, but the description, or perhaps the translation, leaves a lot to be desired. For instance, is a solar eclipse always called a rising in the language of the time? If so, there is no question; if not, it leaves open the possibility that here we have another account of Hezekiah's sign the first rising occurring at regular sunrise and the second rising after sunset when the sun came back up in the west.

Hezekiah's Sign in North America

If it is the case among the Chinese and Indians that the sun should set and come back up, what about tales of the sun rising and going back down. For these we must search the Americas. Robert

Lowie reports such a Shoshone tale: the story of Cottontail.⁶ In the story, Cottontail devised a plan to kill all humanity and the sun. Digging a hole, he waited for the sun to rise. But the sun saw him and quickly dove back under. After a while the sun rose again; and after several failed attempts at killing the sun, Cottontail succeeded in knocking a piece of the sun off with a club. The world was set ablaze and the fire chased Cottontail who eventually found a fire-proof weed in which to hide. After leaving the weed, the heat of the ground burned off three of his legs. Hopping on the fourth he built a shelter for the night. During the night it snowed, and the next day the sun changed Cottontail from a man into a rabbit.

The inconsistencies in the story are obvious: men don't have four legs, for example. But embroidery aside, here we do have an account of a sunrise followed by a solar retreat followed by another sunrise a while later: precisely as required by Hezekiah's sign if one were in eastern North America.

The Menominee Indians of Michigan tell a tale of the sun rising and then reverting to darkness. In their story, two brothers were out hunting. One became tired and stopped to rest, but he did not get much rest because the sun kept teasing him. In revenge, the brother obtained a hair from his sister and stretched it across the sun's path. Upon arising that morning, the sun was snared and started to choke. As a result, the sky became dark. A helpful mouse chewed through the hair and rescued the sun, thus restoring light to the earth.⁷

Still another account reflecting Hezekiah's sign is told among the Indians of Northern California. According to their legend, the sun accidentally fell from the sky just about sunrise. A quick mole caught it before it touched the earth. After some time, help arrived, and they were able to restore the sun to the sky.⁸

Although the actual sunrise, retreat, and re-rising of the sun probably occurred far to the east, (or possibly the west coast of South America) for the California Indians, it also happened some 2,600 years before these stories were recorded. This is ample time for a tribe to have moved west.

Hezekiah's Sign in the Central and South Americas

Turning our attention further south, a hesitation to rise on the part of the sun is recounted in Aztec folklore but appears as part of an account of a very long night. The two events may have been combined into one story later in Aztec history.⁹ In the *Popol Vuh* there is an account of the horizon reddening and a subsequent darkening:

But as it was about to dawn and the horizon reddened: "Make it dark again, old one!" the buzzard was told.

"Very well," said the old one, and instantly the old one darkened the sky.¹⁰

In South America, Zechariah Sitchin¹¹ reports, Andean legends tell of a "brightening darkness." Although Sitchin takes it as a reference to Joshua's long day, the term "brightening darkness" seems more reasonable for a brightening with a subsequent return to darkness than it is for a lingering dawn. If so, then this likely is an account of Hezekiah's sign.

It is recorded¹² that in the Peruvian Andes there stand two ruined towers on opposite hills of a pass. Clamped to the walls there are iron hooks which, tradition has it, held a net designed to catch the rising sun. The local Indians report that the sun was caught once and held with a chain that allowed it only a little bit of up and down motion.¹³ How it was released, for how long it was held, or how many times it bobbed up and down is not recorded.

The Peruvian tale seems to have traveled to Polynesia, for the Polynesians tell how their chief god, Maui, traveled far to the east to trap the sun in a net between two walls he had built for that purpose. It has long been suspected that the islands of the Pacific were settled from western South America, which is consistent with Maui's travels.

We see here, as in the North American accounts, that the tales may have moved around geographically and have been embroi-

dered quite a bit; but the basic theme is the same: the sun rose, went back, and then rose again. In some of the accounts the sun did not retreat far enough to the east to set, stopping its retreat very near to the horizon. The conclusion is that the terminator (the line separating day from night) ran somewhere through the eastern United States and western South America.

Other Accounts

It is unlikely that many peoples would have noted a lengthened night since only the Egyptians had clocks, and a clock would be necessary to notice a forty-minute lengthening of the night. Few people in the Pacific Ocean basin, for example, would have been awake to see the stars turn back ten degrees.

One may question whether the stars participated in the retrograde motion. If there are remnants of truth scattered throughout folk tales, we may conclude that they did. According to one Greek legend, Zeus settled an argument between two brothers as to which would become king of Mycenæ by reversing the course of the sun, Helios:

Helios, already in mid-career, wrested his chariot about and turned his horses' heads towards the dawn. The seven Pleiades, and all the other stars, retraced their courses in sympathy; and that evening, for the first and last time, the sun set in the east.

Although the time of day at the start of the myth is correct for Hezekiah's sign (about 12:30 in the afternoon in Greece), adding at least seven hours to the day is inconsistent with the sun going back only ten degrees. Perhaps the Greek's time estimate was inspired by the tract *Sanhedrin* 96a. According to the tract, God allowed only two hours of daylight the day of Ahaz's death so that there would not be any time for mourning or proper burial of that wicked king. The tract continues that the ten lost hours were restored by Hezekiah's sign. Such an influence on Greek mythology is to be

expected since, in order to be a great philosopher in the eyes of the Greeks, one had to make a pilgrimage from Greece to Egypt with a layover in Babylon. Despite all of this, the Bible clearly states "ten degrees," not ten hours; and it only takes forty minutes for the sun to move ten degrees.

One will also find mention of a Maori tale of the sun being slowed at sunrise in New Zealand. This has been associated in the literature with Joshua's long day, but it must be pointed out that if it is sunrise in New Zealand, it is still night in Israel. The Maori account is most likely one of the Maui accounts mentioned earlier. However, the New Zealand Maoris settled there much more recently than Hezekiah's sign and exterminated all the prior inhabitants. The current inhabitants are believed to have come from Borneo.

It seems unlikely that the site of the slowed sunrise should be New Zealand if the inhabitants of the time were all wiped out. (There were several waves of immigrants and exterminations in the history of the islands.) Thus the tale must have originated or come from the current Maoris' homeland, Borneo. What is intriguing about that is that Borneo was in the region of Hezekiah's sign where the sun would have set, came back up and set again (see Figure 2). Unfortunately, the story, as told, does not allow us to draw that conclusion.

The Time of the Sign

Taking all of the above accounts at their face values, it is possible to plot them on a globe to determine what time of day it was at Jerusalem when the sign happened. Doing so makes several things clear. The Chinese accounts seem the most reliable with the Indian account either originating from the easternmost borders of India or else being imported from Burma or China. It is not uncommon for Indian folklore to be borrowed from the Chinese, so the latter assumption is reasonable. The terminator is in the proper position at about 1:30 p.m., Jerusalem time, give or take a half hour. Furthermore, it must have been in either late March to early

April or else early in mid-September. The early spring is the most consistent with the snow mentioned in the Shoshone tale, for what that is worth. (See Figure 2.)

Conclusion

Given these separate racial accounts, all of which are rather consistent with the day-and-night geography, there is no way to avoid the conclusion that there was a day in history when the day was lengthened by about forty minutes. One may argue as to whether the earth temporarily reversed its daily rotation or that the sun and cosmos retraced their daily paths by forty minutes, but unless one does not fear to call God a careless writer, the inescapable conclusion is that the universe, sun included, backed up ten degrees and then resumed its regular motion about the earth.

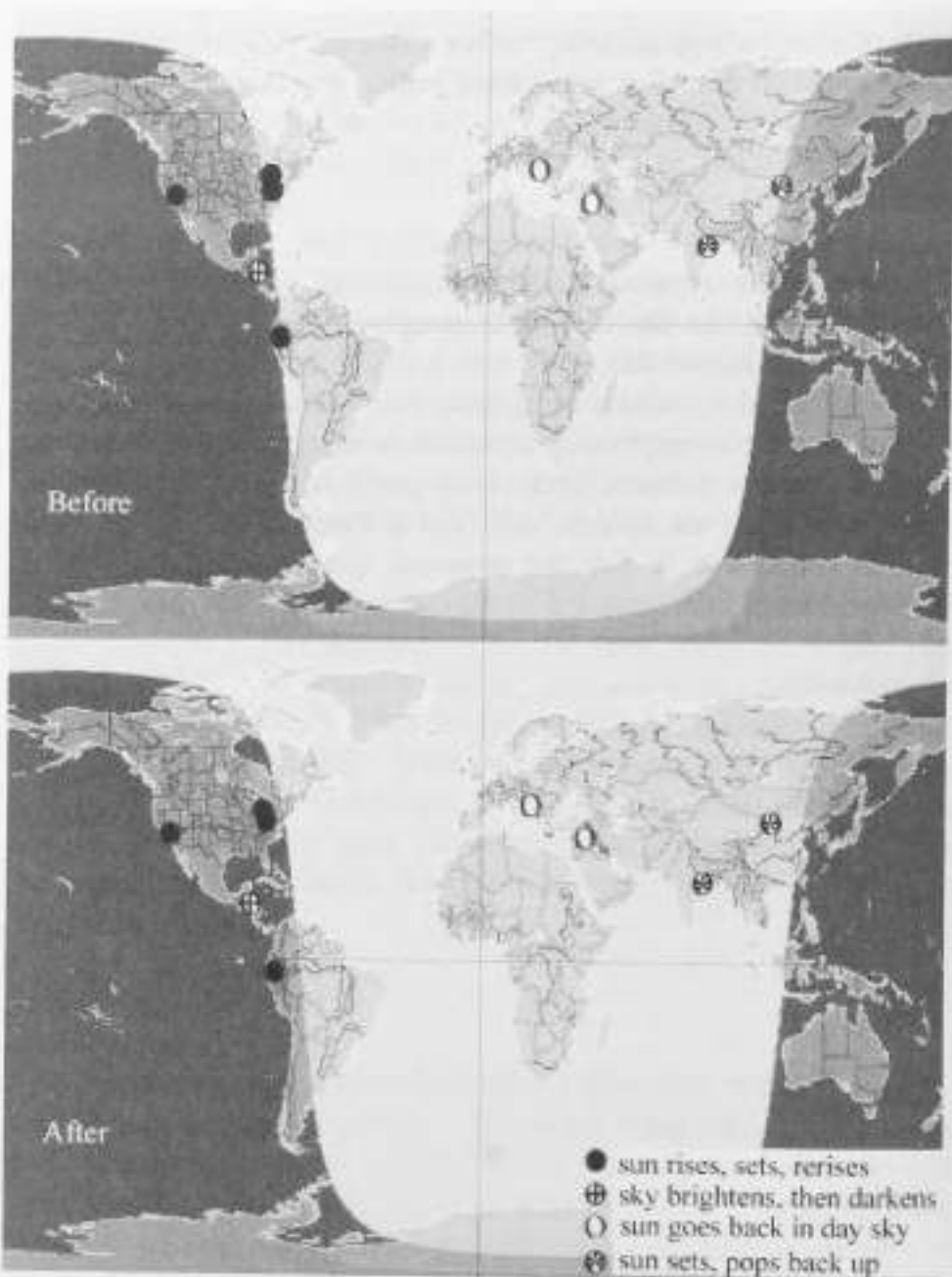

Figure 2: *Hezekiah's Sign Before and After.*

The story of Christianity tells about a plan of salvation centered upon a particular people and a particular man. As long as someone is thinking in terms of a geocentric universe and an earth-deity, the story has a certain plausibility.

— A. J. Burgess¹

10

CHRISTOLOGICAL SUN PASSAGES

The scriptures speak of the promised Messiah, the Christ, the Anointed One who is to come to earth to redeem a people unto himself. The Bible leaves no room for doubt but that the Messiah is Jehovah incarnate. Scripture uses several symbols for the Messiah such as the "Branch" and the "Lamb of God." The Messiah is also referred to as the "Morning Star" (Revelation 22:16), the "Day Star" (II Peter 1:19), the "sun" (Psalm 19:4), and the "Sun of righteousness" (Malachi 4:2). In this chapter and the next, we consider those verses which tie together the sun and the Messiah. In Chapter 7, where we examined the sun's rule over the day, we concentrated on one major area of the sun's Christology when we considered Psalm 19: in this chapter we consider a wider variety of Christological sun passages. But first, let us establish the significance of geocentricity to Christology, the things of Christ.

The Significance of Geocentricity to Christology

In the chapter quote, Burgess touches the issue which was crucial in the humanists' fight for heliocentrism and against the churches during the sixteenth and seventeenth centuries. Burgess later expands on the chapter quote:

As soon as astronomy changes theories, however, the whole Christian history loses the only setting within which it would make sense. With the solar system no longer the center of anything, imagining that what happens here forms the center of a universal drama becomes simply silly.²

As implied by Burgess' quotes, the vanquishing of the geocentric theory in favor of heliocentrism is perceived by many as the death knell of, if not Christianity, at least the authority of Scripture. And is that any wonder? for the earth is truly central in the purpose of God throughout the scriptures. Furthermore, of the symbols used to represent Burgess' "particular man," i.e., Jesus who is the focus of history, many are geocentric and none are heliocentric. If the geocentric symbols are in error, then how may one trust anything in Scripture? After all, if no one prior to Copernicus could conclude from Scripture that the earth rotates and orbits the sun, how can anything else in Scripture be trusted?

Consider Psalm 84:11 as an example of a passage where Christ is identified with the sun:

For the LORD God is a sun and shield: the LORD will give grace and glory: no good thing will he withhold from them that walk uprightly.

Many there are who profess that Jesus Christ is not the LORD God and that this verse, as a result, is not Christological; but besides this verse, the Messiah is called *The mighty God* in Isaiah 9:6 as well as several other places such as Revelation 1:8. (Note verse 18 there—when did the Almighty die if Jesus was not the Almighty?) Hence we must include this passage as Christological. After all, Jesus is the light of the world, even is the sun to the natural eye, and his faith is a shield against the fiery darts of the wicked (Ephesians 6:16).

Isaiah 13:10

The nineteenth Psalm, presented in the seventh chapter, is not the only place in Scripture where Christ is compared to the sun.

Another such passage is Isaiah 13:10 where we again encounter the phrase "his going forth" with reference to the sun:

For the stars of heaven and the constellations thereof shall not give their light: the sun shall be darkened in his going forth, and the moon shall not cause her light to shine.

The setting of this verse is the time of judgment and parallels the events described in Revelation 6:12-16. The verse speaks of a time when the Lord shall hide himself in thick darkness. The sun, in consistent typology, is also darkened.

One could argue that Isaiah 13:10 refers to the course of the sun through space, and certainly that is true; for in Psalm 19:6, we see that the sun's path is a circuit. That such a thing could only be true in a geocentric context was demonstrated in Chapter 7. The point is that this verse describes the sun as moving and indicates that the sun's motion has been going on for some time. Isaiah 13:10 is thus an example of a geocentric Christological verse.

Judges 5:31

Still another biblical reference to the "going forth" of the sun is found in Judges 5:31 where we read:

So let all thine enemies perish, O LORD: but let them that love him be as the sun when he goeth forth in his might.

This verse is found in the song of Deborah and Barak and has obvious Christological overtones. The pronouns "him," "he," and "his" all refer to Christ the Lord. Here, too, the point is that the sun is described as moving. One could, of course, argue that Deborah and Barak are speaking from a human perspective and thus speak phenomenologically. This argument would appear to do no particular violence to God's literary prowess since he would simply be reporting the facts, namely, quoting what the two judges of Israel said without endorsing the truth thereof. Questions about in-

spired quotes and allied Christology aside, this argument can have no effect on the narrative voice such as found in Isaiah 13:10.

Leviticus 22:7

Some geocentric Christological verses are subtle. Leviticus 22:7 is one of those:

And when the sun is down, he shall be clean, and shall afterward eat of the holy things; because it is his food.

The prior passages describe how a man is cleansed from various types of uncleanness. Most of those involve washing with water and then being unclean until the evening or after the sun goes down. The phrase, "the sun is down," has indirect geocentric impact for it implies that the sun went down. But that is not the only geocentric evidence this verse presents. Christologically speaking, the sun is a type of Christ. The setting of the sun correlating with the cleansing of that which is unclean takes us to the death of Jesus. On the cross, Jesus took all our sin and uncleanness upon himself, becoming unclean unto his death. The "sun is down" represents Jesus in the grave while his spirit was in the heart of the earth (Matthew 12:40). Today we are baptized into his death (Romans 6:3) and so were cleansed with his death, even his blood, on the evening of his burial (note the time of day in Matthew 27:57 v.f.). The scope of Christ's cleansing of the unclean is presented in Acts chapter ten, starting at the eleventh verse where it applies to the beasts which had been declared unclean by the law but now clean, and to the Gentiles which are now clean by the shed blood of Christ.

The geocentric impact of the doctrine is that Jesus, typed by the sun, "set" and went "down"; and not we and not the earth. For the typology not to be broken, it requires that the sun went down and not that the earth turned away from Christ, the sun.

Malachi 4:2

The final Christological sun passage which we shall consider is the one that is most obviously Messianic in impact and that is Malachi 4:2—

But unto you that fear my name shall the Sun of righteousness arise with healing in his wings; and ye shall go forth, and grow up as calves of the stall.

In Malachi 4:2 the Sun is said to do the rising, not the earth turning toward the sun as modern astronomy would have it. This reflects Christ's resurrection from the tomb at sunrise Jerusalem time. And so it is that if the sun does not truly "rise" (that is, move), that the typology is destroyed in both Malachi 4:2 and Psalm 19:6. It makes the resurrection only "apparent" or "phenomenological."

The typology of the sun as moving fits perfectly with the scriptural teaching that Christ came to earth and will come again and that we do not go to him. In short, if the Bible speaks phenomenologically or figuratively when it says that the *sun* "arose," then how can we, as believers, require that it present a literal truth in reporting that the *Son* "arose"? To challenge the validity of the word *rise* in any part of Scripture is to challenge its validity in all parts, most particularly its use in referring to the resurrection. We'll have more to say about that in the next chapter which deals with sunrise and sunset passages of Scripture.

Is Geocentricity Figurative in the Bible?

Finally, although it has no direct bearing upon the geocentricity of the verse, we consider the reference to the wings of Christ as present in Malachi 4:2. Heliocentrists have widely argued that if the motions of the sun are to be taken literally, other things like God's face, hands, arms, feet, legs, breast, and wings must also be taken *literally*. Augustine was so appalled by such an anti-Gnostic

conclusion that he utterly condemned all who believe that God has real hands and feet. Clearly, we need to consider the charge.

There are numerous references throughout Scripture where God is said to have human features and some non-human ones, too. In the Old Testament alone, God's wings are mentioned no fewer than ten times. Consider John's description of the Almighty in Revelation 1:13-17 for example.* Can there be room for doubt that God has a man-like figure when the Bible reports "one like unto the Son of man"? The thirteenth verse of the first chapter of Revelation equates that man-like form with the Almighty God. Those who argue that it is blasphemy to believe that God has hands and feet, let alone wings, maintain this position on the grounds that John 4:24 teaches that God is a Spirit and then add, without a shred of scriptural support, that a spirit has no form. To defend their Gnostic position, they invoke Luke 24:39, claiming Jesus says that a spirit does not have flesh and bones. However, Jesus does not say that a spirit has no form but on the contrary, the very wording he chose ("a spirit hath not flesh and bones *as ye see me have*" emphasis added) indicates that a spirit *does* have form, and hence, by implication, can have hands and feet. In I Samuel 28:14, too, the spirit of Samuel is not only recognizable as the form of an old man; but he is even described as covered with a mantle.

Zechariah 12:1 explicitly teaches that a spirit has form for there it is recorded that:

The burden of the LORD for Israel, saith the LORD, which stretcheth forth the heavens, and layeth the foundation of the earth, and formeth the spirit of man within him.

* Revelation 1:13-17—And in the midst of the seven candlesticks one like unto the Son of man, clothed with a garment down to the foot, and girt about the paps with a golden girdle. ¹⁴ His head and his hairs were white like wool, as white as snow; and his eyes were as a flame of fire; ¹⁵ And his feet like unto fine brass, as if they burned in a furnace; and his voice as the sound of many waters. ¹⁶ And he had in his right hand seven stars; and out of his mouth went a sharp twoedged sword: and his countenance was as the sun shineth in his strength. ¹⁷ And when I saw him, I fell at his feet as dead. And he laid his right hand upon me, saying unto me, Fear not; I am the first and the last.

Clearly, if God “forms” man’s spirit, then man’s spirit must have a form or else the text is nonsense.

Given these arguments and given the wealth of references to God’s bodily parts, how can anyone maintain that God does not have hands and feet or even wings? Is anything too hard for the Lord? Most assuredly, God has hands and feet. His hands and feet bear the nail prints of Calvary. As for his wings, Malachi 4:2 tells us that these will only be seen by believers, those that “fear my name,” those who have the Holy Ghost dwelling within them. After all, the Holy Ghost is typed by a dove and doves have wings, don’t they?

... and he saw the Spirit of God descending like a dove, and lighting upon him (Matthew 3:16).

Can there be any doubt as to the literal nature of the “healing in his wings”? Certainly, if these things be true, the fixity of the earth is equally true. For more on this topic see the section dealing with heresy in Chapter 6.

Conclusion

The Scripture presents the sun as a type of Christ Jesus, the life sustainer and Messiah. If so, the earth types mankind. But the earthly man is dead in trespasses and sins and cannot save himself. Although many will claim that heliocentrism’s view of the earth orbiting the sun is a stronger scriptural type of the relationship between God and man, since the Garden of Eden there has not been a single time where mankind as a single entity has obeyed Jesus the sun. Jesus had to come to earth to save mankind from sin; we cannot go to him. Thus the sun is described as moving from sunrise to sunset and back again and completing a circuit from the ends of heaven. Nevertheless, if we are to assume that the word “rise” when applied to the *sun* is not to be taken literally; how then can we insist that the application of “rise” to the resurrection of the *Son* must be taken literally? Heliocentrism questions the resurrection.

The sun was risen upon the earth
when Lot entered into Zoar.

— Genesis 19:23

SUNRISE AND SUNSET

By far the most numerous passages overtly speaking of the daily motion of the sun about the earth are those which refer to sunrise or sunset. Embedded in these very words is the idea that the sun does the rising and the setting and that the earth is but a passive participant in the process. We shall not examine these passages in great detail; there is no need for that. The geostatic nature of the words “sunrise” and “sunset” is universally acknowledged.

Statistical Considerations

Appendix B lists all the occurrences of the words “sunrise” and “sunset” in the Holy Bible. The list can be grouped into five categories:

- The first of the five categories lists 26 references where the sun is referred to as either “going down” or “setting.”
- In the second category there are 20 references. Each of these refers to the sun as “risen.”
- The third category speaks of “sunrising” as a specific event or time of day. It has 11 references.
- The fourth category is directional and has 4 references that speak of the sun being “down” and 4 speak of it being “up.” We group these together in a single category because as geocentric references they are weak insofar as

there is no mention of how the sun got to its “up” or “down” state.

- The fifth category is not overtly geocentric in nature either. Twenty-nine times Scripture speaks of the position of the earth as under the sun. In a sense, this category is strictly geocentric as opposed to geostatic. The other categories teach an earth that is geostatic.

Differences between Geocentricity and Geocentrism*

Let's focus on the fifth category. Geocentricity requires that the earth be located at the dynamic center of the universe (technically, this means that the earth is at the *barycenter* of the universe—see Chapter 6). The geometric position of the earth is secondary in geocentricity although it is primary in geocentrism. That is why some of the groups that refer to their stance as *geocentrism* allow for a rotating earth albeit not an earth orbiting the sun. Rotation has nothing to do with the location of the earth to such groups as the French geocentric group, CESHE. Both geocentricity and geocentrism require that the cardinal directions, including up and down, must refer to the center of the earth. The fifth category thus lists all those Bible passages that use the phrase “under the sun.” Given that the sun moves around the earth once a day, the phrase “under the sun,” of necessity, dictates that the earth is located at the origin of God's frame of reference; that is, in a stationary, fixed position in the universe.

Statistically, the phrase “under the sun” occurs 29 times in the Bible, all of them in the book of Ecclesiastes. The word “sun” appears 162 times in Scripture in addition to 11 occurrences of the word “sunrising.” Of these 173 references, 29 occur in the afore-

* The physical evidence for geocentricity is overwhelming. Relativity was invented to keep the earth in orbit around the sun while every attempt to detect the motion of the earth through space returned a speed of zero. When it comes to the geometric center of geocentrism, the best we can observe is that the earth is within one or two hundred million light years from the geometric center of the universe. That amounts to within less than 1.5% of the center of the universe.

mentioned phrase, “under the sun.” Of the remaining 144 solar references, 57 are overtly indicative of the motion of the sun and another eight indirectly point to the sun’s daily motion. Additionally, there are those verses, like Psalm 19:6 which we referred to earlier in Chapter 7, entitled “The Sun to Rule by Day,” which speak of the sun as “going forth.” These have not been tallied in the sunrise/sunset passages. Overall, well over half the references to the sun are geocentric in nature. As of this writing, the author’s current count of verses with geocentric significance stands at 280, not counting references to “up” and “down” centered on the earth. (See Appendix C for the annotated list of the 280 geocentric verses.)

SOME KEY SUNRISE-SUNSET VERSES

Matthew 5:45

Dr. Thomas Strouse, Dean and Professor *Emeritus* of Bible Baptist Seminary in Cromwell, Connecticut, wrote an exegesis of cosmological passages in Scripture which support geocentricity.¹ His title, *He Maketh His Sun to Rise*, is taken from Matthew 5:45:

That ye may be the children of your Father which is in heaven: for he maketh his sun to rise on the evil and on the good, and sendeth rain on the just and on the unjust.

Dr. Strouse has this to say about that passage:

This simple statement employs two verbs, “make rise” and “send,” with the Father as the subject of both. The objects of these two action verbs are sun and rain, respectively. The Christian is immediately faced with a dilemma—take the simple proposition at face value, or interpret part of it phenomenologically. Many Christians would assume that the Father really makes the earth rotate since they have been taught that dogma their entire lives. And yet they would not interpret the

verse to teach that the rain is stationary, supposedly as the sun, and that the earth moves towards the rain. Consequently, they would employ two different systems of interpretation on this verse, not recognizing their hermeneutical inconsistency (II Timothy 2:15).

Christians, unknowingly at times, continue to carry secular or evolutionary baggage in their perspective of life and resist biblical instruction. Certainly in the last four hundred years, the majority of Christians have embraced the Copernican world view of heliocentricity, not based on lay biblical exegesis, but based on scholarly surmising and Christian peer pressure. This acceptance of "science falsely so called" (I Timothy 6:20) does not honor the Lord, and does contribute to the destructive criticism of the inspiration and inerrancy of Scripture (II Timothy 3:16).

Matthew 5:45 is geocentric because it equates the grace of God with the rising of the sun. People who make the phrase, "for he maketh his sun to rise" phenomenological would never do the same to "sendeth the rain" by insisting that we approach the rain instead of the rain approaching us. The grace in this verse is given to saint and sinner alike. God has given the gift of life to both, yet we are all born despising the lives God gives us. We complain about unfairness, lack of recognition, lack of respect, lack of money, lack of prestige, and we even find fault with God about the condition into which our own rebellious spirits have led us after we told God we do not want his meddling in our lives. The grace of God is a free gift of God (Ephesians 2:8), emanating from God to us. To insist that the sun's rising is caused by our moving towards the sun is thus tantamount to denying free grace and thus claiming we have to work to earn God's grace.

Psalm 104:19

One of the sunrise/sunset passages we consider, Psalm 104:19, is particularly strong as well as scientifically puzzling:

He appointed the moon for seasons: the sun knoweth his going down.

The Christology of the verse is evident since the Bible makes it clear that the Son (as typed by the sun) knows "*his* going down." Of course, this refers first to our Lord's descent from heaven to earth as the Word made flesh in the virgin's womb in 2 B.C., then second to his death, burial, and descent into the heart of the earth (Matthew 12:40). Third, it refers to our Lord's second advent when he descends from heaven to claim his Bride and to make war against the antichrist. The scientific impact of this passage lies in the pronouncement that somehow the sun "*knoweth* his going down." It is inadvisable to dismiss this reference as poetic and thus without truth—for poetry is every wit as truthful as prose. Also, as man's knowledge has increased, the number of such poetically-dismissed passages in Scripture is steadily declining. For the time being, however, the scientific connotation of the verse must remain a mystery. In any case, how can the sun know his going down if he is not "going down" but if instead the earth is turning?

Ecclesiastes 1:5

There is a third sunrise/sunset passage which we shall consider which occupied a central place in the Reformation debates between geocentrism and heliocentrism. That passage is the fifth verse in the first chapter of Ecclesiastes:

The sun also ariseth, and the sun goeth down, and hasteth to his place where he arose.

In Ecclesiastes 1:5 we encounter the same allusion to the burial and resurrection of Christ that we earlier encountered in Psalm 104:19. The verse is quite explicit in claiming that the sun is moving, for it even adds that he "*hasteth*." Certainly this verse is not

literally true if heliocentrism is true. Again, if the passage is not true then in the final analysis, either God did not inspire it or else God is a liar. Claiming that God did not inspire it makes him out to be a liar anyhow for he claims authorship of all of these passages in the context of II Timothy 3:16-17.*

Now there are those who claim that since the passages surrounding Ecclesiastes 1:5 cannot be taken literally, that Ecclesiastes 1:5 should not be taken literally either. This argument is a vestige of the sixteenth and seventeenth century debates favoring heliocentrism; and it is now mindlessly parroted, for in the intervening centuries science has learned that every one of the surrounding verses is literally true. We shall examine them if for no other reason than that said examination will serve as an example of the statement made earlier about the declining number of "poetic" passages in Scripture.

The first verse in the first chapter of Ecclesiastes is certainly literal enough:

The words of the Preacher, the son of David, king in Jerusalem.

The second verse is likewise literally true although its truth may not be immediately apparent:

Vanity of vanities, saith the Preacher, vanity of vanities; all is vanity.

The theological problem here lies with the term "all." Originally, theologians objected to this verse because they thought that the word "all," if taken literally, would charge the Lord God himself with vanity. To avoid this, theologians dismissed the entire book, as well as Proverbs, as at best a lesser inspiration. The argument was that Solomon, as an idolater wrote from man's perspective and

* II Timothy 3:16-17—All scripture is given by inspiration of God, and is profitable for doctrine, for reproof, for correction, for instruction in righteousness: That the man of God may be perfect, thoroughly furnished unto all good works.

not from God's, even though Solomon had repented and was no longer king when he wrote Ecclesiastes (Ecclesiastes 1:12).

Today we know that the theologians' reservations against the second verse is groundless. Logically, there is no such thing as "the set of all sets." The set of all sets cannot be a member of the set of all sets. That means that the set of all sets follows different rules than the individual sets making up that set of all sets. Specifically, the infinite God cannot be included in the "all" referred to in Ecclesiastes 1:2. So our modern set theory exempts God from being included in the "all" of the verse and thus he is not there branded as "vain."* We also do not have to speculate about whether or not Solomon was in or out of the "will of God" when he penned Ecclesiastes. The second verse, in writing that all is vanity, writes a literal truth.

Next comes the third verse:

What profit hath a man from all his labour which he taketh under the sun?

Except perhaps for "under the sun," which is the point at issue anyhow, the question is quite literal and can be answered in a literal way.

The next verse is Ecclesiastes 1:4:

One generation passeth away, and another generation cometh: but the earth abideth for ever.

That generations come and go is literal enough. The only problem one might have is with the earth "abiding for ever," but that phrase was covered in Chapter 5 on the motions of the earth.

* The atheist Bertrand Russell proved this property of the set of all sets. Earlier, in Chapter 6 on the firmament, we noted Russell's work on the existence of the plenum and how it made possible a logical proof of the existence of God. Despite himself, Russell was one of the greatest apologists for Christianity in the twentieth century.

Since the first four verses are literally true, then on that basis there should be no problem with the literal truth of the fifth verse. But what of the sixth verse? Perhaps the figurative part starts there:

The wind goeth toward the south, and turneth about unto the north; it whirleth about continually, and the wind returneth again according to his circuits.

Not until the twentieth century did man finally learn that this verse is literally true. In the northern hemisphere's temperate zone (where most of the world's people live), the prevailing winds blow from west to east. In addition to this, the wind moves from north to south on a slower but also much grander scale. Along the surface of the earth's northern hemisphere the wind has a north-to-south component while several miles above the ground it flows from south to north.



Figure 1: Wind circulation as observed and taught in Ecclesiastes 1:6.

Additionally, depending upon whether the air is massed into a high-pressure area or a low-pressure area, air circulates in a counter-clockwise or clockwise direction. Termed *cyclones* and *anticyclones*, these circulating masses of air all attest to the literal truth of this verse even though the rotational directions are reversed in the southern hemisphere. Now wind is a type of the Holy Ghost and that typology is evident in the sixth verse where "his circuits" alludes to Christ, as we saw in our study of Psalm 19:6.

We could go on to show the literal truth of every verse in the chapter, but we shall conclude with Ecclesiastes 1:7 which is also of scientific significance:

All the rivers run into the sea; yet the sea is not full; unto the place from whence the rivers come, thither they return again.

At the time Solomon penned these words it is doubtful that man knew much about convection, condensation, and evaporation; yet here we have a scientifically accurate description of the water cycle. Rivers flow into the ocean and the water of the ocean evaporates only to be precipitated as rain, dew, hail, or snow upon the land. There the waters flow together into rivers which flow back to the ocean, starting the cycle all over again. Clearly, the seventh verse is a literal truth.

We see, then, that contrary to the heliocentrists' claims, Ecclesiastes 1:5 is surrounded by verses which are literally true. As a result, the fifth verse cannot be shrugged off so easily as to claim that it is embedded in verses which are all figurative and not literal.

Job 9:7

We now consider two more examples of sunrise/sunset passages. Some biblical passages deal with the state of the sun during the great tribulation and judgment. Job 9:7 is one such reference. In it we read that God:

...commandeth the sun, and it riseth not; and sealeth up the stars.

The prior verses give the context as the time of God's wrath poured out upon the earth. The point here is that it is the sun, not the earth, which is commanded to stop. If the earth rotated, then the earth should be commanded to stop, not the sun.

Habakkuk 3:11

The second of the sunrise/sunset examples involving the tribulation and judgment is Habakkuk 3:11. The fifth through ninth verses Of Habakkuk 3 set the stage for the eleventh verse, which reads:

The sun and moon stood still in their habitation; at the light of thine arrows they went, and at the shining of thy glittering spear.

This refers to a future incident of which Joshua's long day is a type. Regardless of when one may wish to place this event, the fact remains that the sun and moon are described as standing still in their habitation, that is, in their respective tabernacles in heaven (Psalm 19:4). Admittedly, this could be taken to mean that the sun's motion about the center of the Galaxy ceased (or will cease) as well as the moon's motion about the earth; but in light of all the previous passages which speak directly of the motions of the sun and moon around the earth, the geocentric interpretation is by far the most likely.

Linguistic Considerations

Finally, we look at the liberal theologians' defense of heliocentrism versus the scriptural doctrine of geocentricity. Evolutionary apologists have for centuries maintained that the words "sunrise" and "sunset" are the product of the evolution of language. They suppose the languages of the earth all stem from grunts and groans emitted in the remote past. Gradually, they claim, the languages became increasingly complex. But this is not the view presented in the Holy Bible. The scriptures teach that the world's languages came from one common language (possibly Hebrew) which was *confounded* (not *confused*; there is a great difference between the two terms!) at the tower of Babel's construction site (Genesis 11:1-9). It is ironic that these two examples, *viz.* sun-

rise and sunset, evolutionists hold up as a product of the evolution of language have not “evolved” one iota. The same holds true for every other geocentric word we have examined. The words have not changed or been modernized at all.

Suffice it to say that the Bible’s account seems far more realistic than the evolutionists’ on the grounds of both the second law of thermodynamics (that things, including languages, degenerate over time) as well as historical observation; for we see the world’s languages becoming *less* sophisticated in time, not more. Take English as an example. The subtle distinction between the words “thoroughly” and “thoroughly” has long been forgotten, yet the difference was considered crucial four hundred years ago.* Anyone who would take the trouble to find out just why the Authorized Bible used “odd” phraseology at times would soon be amazed at how much detail, explicitness, and fine structure the English language has lost just in the last four hundred years. There is no language in the world which is naturally or evolutionarily improving. True, more and more words may be hybridized or absorbed from one language into another, but the sentence structures and parts of speech are fast losing distinctiveness.

If God, as the Bible teaches, created Adam’s language as well as confounded the languages at Babel, then why did he not “natu-

* Both thoroughly and thoroughly mean “fully, completely, perfectly.” Thoroughly has a sense of “in a way that penetrates, that goes right through.” It is thus oriented to coming from the outside in. Thoroughly is interior. It has a sense of “through the whole thickness” and so works from the inside out to the surface. A key distinction in some passages lies in the fact that “thoroughly” has also a sense of “from beginning to end, for the whole length of time.” This brings the lifetime of the object into view with thoroughly, which is not the case with thoroughly.

Consider an example. II Timothy 3:16 says of the purpose of Scripture, “That the man of God may be perfect, thoroughly furnished unto all good works.” The use of “thoroughly” here signifies from the inside out, forever, meaning that the Spirit of God residing in believers teaches them from the inside out. Modern versions alter thoroughly to thoroughly whereby they invert the meaning to educating the believer from the outside in with human truths not necessarily true or eternal.

rally" accommodate them to accept the "truth" of heliocentrism? God gave man an innate capacity to understand things like colors and shapes; why could he not have done the same for the relative motions of the earth, sun, and stars? It would appear that the heliocentrists not only make God out to be a clumsy grammarian and sloppy in his typology, but he either cannot or will not bother to create a true language, i.e., a language that does not succumb to requiring false appearances over truth. God could have created and confounded the languages to accommodate the truth of heliocentrism, if truth it be.

Consider this example to show how very simple it would have been for God to structure the English language so that it naturally includes heliocentrism. It may sound jarring to our ears, but the word "sunrise" would "more correctly" be "tosun," or "sunward" which would acknowledge that the rotation of the earth would carry us toward the sun at sunrise. Likewise, sunset could be called "fromsun" since at that time we move away from the sun in a heliocentric framework. This is no more cryptic or difficult than any of the the questions God asked Job in Job 38.

Conclusion

The Bible verses which speak of the rising and setting of the sun afford us the largest bulk of passages directly supporting the scriptural doctrine of geocentricity. Again, the issue boils down to the same point we have noted in previous chapters. Either God meant what he wrote or he did not mean what he wrote and would, presumably, revise his original wording if he were to write the passage today. And if he would recant today of what he wrote in times past, then where is truth?

The heliocentric theory, by putting the sun at the center of the universe, ... made man appear to be just one of a possible host of wanderers drifting through a cold sky. It seemed less likely that he was born to live gloriously and to attain paradise upon his death. Less likely, too, was it that he was the object of God's ministrations.

— Morris Kline¹

12

THE THRONE

When the news that Copernicus had published his book promoting the heliocentric system reached the ears of the Reformers in 1543, their first reaction was to express their disapproval of his heliocentric model of the universe. Most notable was the response of Dr. Martin Luther who expressed some anxiety about possible consequences of the theory if it should ever be accepted as true. Throughout the history of the debate between geocentric and heliocentric position of the earth, Christian and Jewish theologians alike expressed a moral uneasiness about demoting the earth's station in creation. Two areas of concern were voiced: a decline in the authority of Scripture and a decline in moral values as the universe would go from absolute to relative. This is the subject of this chapter.

Early Responses to the Decline in Morality Concern

After a couple of decades of Copernicanism, the heliocentrists started to argue that since no moral upset seemed in the offing, the geocentrists must be wrong in their moral reservations against

heliocentrism. But in that claim the heliocentrists were grossly premature. First, heliocentrism did not become the dominant opinion the day Copernicus' book was published. It wasn't until around 1650—one hundred years after its publication—that the shift from geocentrism to heliocentrism as majority opinion was accomplished. Second, history shows that it takes at least one generation (here, at least forty years) for the long-term effects of a change in morality to mature. Thus to gauge the effect of heliocentrism, we must look beyond the first generation which completely adopts it; we must look at least forty years after 1650 to evaluate the impact of heliocentrism on public and private morality. Only then can we see if the Reformers were correct in their moral trepidations about heliocentrism.

Just how such moral degeneration could result from such a subtle shift in worldview is not intuitively obvious. Nevertheless, the concern of the Reformers and other Christians has proven to be well-founded; for through the work of Johannes Kepler (1571-1630), the Copernican Revolution directly spawned the view that man is but a mere machine, a cosmic accident. Heliocentrism is widely acknowledged as the foundation of the impersonal, mechanistic, materialistic universe and the existentialist view that human life is purposeless and thus, by extension, worthless. How this shift in moral outlook developed historically will be discussed later in this book, but we have already noted its foundation in a quote by Burgess in Chapter 10, who correctly states that Christianity without geocentricity is just plain "silly":

The story of Christianity tells about a plan of salvation centered upon a particular people and a particular man. As long as someone is thinking in terms of a geocentric universe and an earth-deity, the story has a certain plausibility. ... As soon as astronomy changes theories, however, the whole Christian history loses the only setting within which it would make sense. With the solar system no longer the center of anything, imagining that what happens here forms the center of a universal drama becomes simply silly.²

To understand the reasoning behind the Reformers' uneasiness about heliocentrism we start at Isaiah 66:1 where we are told that the earth is the Lord's footstool:

Thus saith the LORD, The heaven is my throne, and the earth is my footstool: where is the house that ye build unto me? and where is the place of my rest?

The theme of the earth as footstool is extended in Acts 7:49 (which is not a quote of Isaiah 66:1 but an elaboration):

Heaven is my throne, and earth is my footstool: what house will ye build me? saith the Lord: or what is the place of my rest?

Note that the two places mentioned, heaven and earth were the first things created (Genesis 1:1). Here I must speculate a bit. I think that the heaven mentioned in the first verse of Genesis is not the atmosphere but is the third heaven that Paul wrote of in II Corinthians 12:2.* The third heaven is where paradise is now located according to II Corinthians 12:4, so it seems the most likely location for the Lord's throne. The second heaven is the firmament created in the second day of creation, and the first heaven is the open firmament referred to in Genesis 1:20,[†] which we call the "atmosphere."

Moral Relativism

It is usual for a throne and its footstool to be at rest relative to each another. As Professor James Hanson put it: "Footstools are

* II Corinthians 12:2—I knew a man in Christ above fourteen years ago, (whether in the body, I cannot tell; or whether out of the body, I cannot tell: God knoweth;) such an one caught up to the third heaven.

[†] Genesis 1:20—And God said, Let the waters bring forth abundantly the moving creature that hath life, and fowl that may fly above the earth in the open firmament of heaven.

not footstools if they are moving."³ It is also normal for there to be some distance between throne and footstool. The Bible refers to the "room" in which these two items are found as a "habitation" and it does so on two occasions. The first of these is Psalm 89:14 where it states that:

Justice and judgment are the habitation of thy throne: mercy and truth shall go before thy face.

The second occasion is Psalm 97:2 which adds:

Clouds and darkness are round about him: righteousness and judgment are the habitation of his throne.

From these two verses we find three spiritual attributes that are present in the habitation of the throne of God, namely justice, judgment, and righteousness. The throne is not moving relative to its habitation, thus these three habitation-attributes are constant and omnipresent; they never change. Likewise, by the analogy of the footstool, these three attributes are also not moving with respect to the earth since the earth, as footstool to the throne, is at rest relative to the third heaven where God's throne is located. This means that the space between footstool and throne, the middle heaven, which we call the universe and firmament, and where the sun, moon, and stars are located, must do the moving and rotating.

When heliocentrists insist that the earth is moving through the second heaven relative to the habitation or throne, the attributes of justice, judgment, and righteousness are viewed as moving with the earth. As the attributes move with the earth we do not see them as constant throughout the firmament since they are not there according to Scripture. If we divorce the footstool from the throne, then the three attributes become part of the earth, carried with the earth through the universe independent of the throne of God.

Now this affords two conclusions: either there are absolute moral standards which are universally true and which are not affected by the earth's motion so that they would only "appear" to

accompany the earth in its dizzying path, or the standards can be viewed as part and parcel of the earth since they share its motions. The latter concept makes moral precepts to be just another earthly fixture, like a mountain or a building, and in no way absolute. This is the modern moral view called "moral relativism." It allows one to conclude that the Scripture's moral norms are not absolutely-defined attributes but are culturally-defined opinions. From there, it is only a small step to the conclusion that all morality is relative and that there are no moral absolutes. In other words, the modern concept of moral relativism is inferred from belief in the earth's motion.

Many Christians and moralists may wish to invoke the omnipresence of God in order to reconcile a stable throne with a moving footstool, but those who do so must also confront the fact that God speaks in overtly geocentric tones throughout the entire Bible. They must also answer the question, "How can a footstool move when the Lord and his throne do not?" Furthermore, they must also confront the fact that God cannot lie, even for convenience's sake; for if God did ever utter a lie, then the creative power of his Word is so great that the "lie" would immediately become the truth.

At first sight, the above reasoning relating heliocentrism to the philosophical concept of moral relativism may appear far-fetched, but there is additional support for the inference besides the comments of the Reformers.

Effects of Moral Relativism

When I first saw the cause of moral relativism presented in the prior section, I thought I was the first to notice it. It was several years later that I discovered others had seen it, too. Frank Allaben, of whom we shall have more to say when we look at geocentrists from 1650 to 1950, not only saw it, but also saw that modern higher criticism followed the Copernican Revolution as night follows day. In 1900 he wrote:

The physical heavens and earth stand in a relation which adumbrates the moral relation subsisting between the scene of God's presence and the scene of man's activities. This moral relation is summarized in the statement: "The heavens are [*sic.*] my throne, and the earth is my footstool" (Isa. 66:1); the first being characterized as the source of Creator-dominion and government, as well as the source of blessings, goodness and mercy of the creature; while the earth is characteristically the theatre of God's display of his attributes before all creation, and the scene of the execution of his counsels in view of eternity—the passive and unworthy recipient of heaven's bounty.⁴

Later in his book, Allaben writes of higher critics:

The dominant style of the De Wette-Reuss-Vatke-Keunen-Welhausen school, with Cheyne-Driver-Biggs echoes, and numerous others, and numerous variations, in England and America—represents the third somersault of "higher criticism," and its fourth contradictory phase! (And I take no account in this remark of the perpetual contradictions in detail, among the numerous infallibilities of each school.) The philosophy of the present school is very simple; We assume that modern science has shown that the law of upwards development [evolution, *Ed.*] underlies human history; but the Hebrew Scriptures perversely contradict this dogma, claiming that Israel started with a perfect law and departed from it, plunging into idolatry, instead of starting as nomad idolaters and evolving the Mosaic law out of their inner consciousness. The Hebrew Scriptures thus teach the heresy of degeneration, in place of evolution; therefore the testimony of the Hebrew Scriptures is incredible on its face, and the scientific way to arrive at the truth is to pronounce the records "pious frauds," always believing the opposite of what is written! Q. E. D.⁵

Those called lower critics are also guilty of these same charges. After all, if the Bible is the inerrant, preserved word of God, consisting of the words of God, then who are we to criticize or to correct those words? Will we not risk falling victim to the only curse in the New Testament, that is, Revelation 22:18-19?

¹⁸ For I testify unto every man that heareth the words of the prophecy of this book, If any man shall add unto these things, God shall add unto him the plagues that are written in this book:

¹⁹ And if any man shall take away from the words of the book of this prophecy, God shall take away his part out of the book of life, and out of the holy city, and from the things which are written in this book.

Changing the words of God in the ways forbidden in the Revelation passage is the rule today, rather than the exception.

The Plumbline⁵

If the earth is rotating, let alone the profusion of other superimposed motions, a plumbline at the Temple from the mercy seat would seldom, if ever, point to God's throne with New Jerusalem. Such a line, when seen from the throne, would aimlessly flail about. But in Scripture, this line points to God's throne, thus showing the fixity of the earth with respect to the third heaven. That God's third heaven is fixed, we shall have to take at his word, for only God the creator can supply the reference. The plumbline, in turn, holds the *plummet*, a lead ball. In Isaiah 28:17* this plumbline over Jerusalem connects Jesus (verses 9-13) with the righteous on earth. In Amos 7:7† the LORD shows Amos the

* Isaiah 28:17—Judgment also will I lay to the line, and righteousness to the plummet; and the hail shall sweep away the refuge of lies, and the waters shall overflow the hiding place.

† Amos 7:7-9—Thus he shewed me; and, behold, the Lord stood upon a wall made by a plumbline, with a plumbline in his hand. And the LORD said unto me, Amos, what seest thou? And I said, A plumbline. Then said the Lord, Behold, I will set a plumbline in the

plumbline of Isaiah 28 and prophesizes that the promised tribulational desolation (verse 9) "will not again pass by them any more." The "wall" of verse 7 upon which stands the LORD must be temple wall showing the cosmological heavenly alignment of the place where God puts his name. Zechariah calls attention to this plumbline when prophesying the rebuilding of the temple (Zechariah 4:10). He associates the plummet with the cosmic events of Revelation 1 through the seven candles, "...for they shall rejoice, and shall see the plummet in the hand of Zerubbabel with those seven; they are the eyes of the LORD, which run to and fro through the whole earth."

The plumbline reflects the same relationship between the throne and its footstool as we saw earlier with the three habitation-attributes. The plumbline is an expression of judgment, providing a standard for uprightness that Scripture uses to describe a righteous man as in Job 1:8 where it is written:

And the LORD said unto Satan, Hast thou considered my servant Job, that there is none like him in the earth, a perfect and an upright man, one that feareth God, and escheweth evil?

The plumbline points along a line extending from earth to the third heaven (Jesus being the plumbline and our way to heaven) and it also points from the third heaven to earth, bringing judgment upon



Fig. 1: Plumbline

midst of my people Israel: I will not again pass by them any more: And the high places of Isaac shall be desolate, and the sanctuaries of Israel shall be laid waste; and I will rise against the house of Jeroboam with the sword.

Jerusalem, as we see in II Kings 21:13.* Note that the word “line” in that verse as well as in Psalm 19 and many other places is a geocentric notion; the line extends from the third heaven to Jerusalem and this makes no sense if the earth is rotating relative to the second heaven.

Revolutions

Really, all of these observations about higher and lower Bible criticism and moral relativism stem from the Copernican Revolution in that the Copernican Revolution radically altered the world’s concept of revolution. Where revolts once ran the risk of countering an absolute, namely, God’s authority; after Copernicus, revolution came to be the accepted method for changing the status quo. After all, if there is no absolute final authority other than some vague Judeo-Christian deity, or the capricious deities of the Greeks, Romans, and other pagans, then man is the measure of all things and we can revise the Judeo-Christian God’s golden rule, “Do unto others as you would have them do unto you,” to the world’s golden rule: “Those with the gold, rule.” Today’s world views the Judeo-Christian God as the most intolerant, vicious, and capricious of all gods, and with this assessment agree some 233 modern Bible versions designed to make the words of God more palatable to a sin-laden world that couldn’t care less about the truth, the way, and the life. That is the fruit of Bible criticism.

So, let us consider the development of modern criticism.

The Birth of Higher Criticism

In the early seventeenth century, the concept of *revolution* obtained a different shade of meaning than it had thitherto. The concept of revolution, as then applied to celestial bodies, ended up with a much broader social meaning, changing in not only mean-

* And I will stretch over Jerusalem the line of Samaria, and the plummet of the house of Ahab: and I will wipe Jerusalem as a man wipeth a dish, wiping it, and turning it upside down.

ing, but also value and significance. It was subsequently applied to the areas of politics and theology. This came about not so much because of the upset of the Ptolemaic worldview but because Copernicus had succeeded in making a clearly heretical teaching palatable to not only the Roman Catholic Church, but also to Protestantism as well. Copernicus, Kepler, and Galileo had succeeded in discrediting the Bible as an authority in the realm of science. This called into question the authority of the Bible in every topic it touched upon.

Kepler picked up the Copernican idea and worked on it to the point that philosophers and historians both acknowledge him as the father of the modern mechanistic, Godless worldview. Kepler envisioned the creation, man included, as pure machine. As such, life loses all meaning and value. So devastating was the effect of the Copernican Revolution that Galileo, though forbidden to teach the ideas of Copernicus as fact (he was not forbidden to teach Copernicanism as theory), overtly threw the Copernican heresy into the face of the pope in 1633 and got away with it.

After the Galileo affair, the Bible was no longer considered authoritative in the realms of science, philosophy, and day-to-day reality. Less than 200 years after surrendering the Bible's authority in the realm of physical science, man surrendered its spiritual authority at the hands of the German school of higher criticism, a way of criticizing the Bible which supposedly is based on natural revelation, that is, upon "scientific" principles. Consequently, the Bible became viewed as merely "containing the word of God," that is, a mixture of God's words and man's words. Once upon a time the Holy Bible had been received as the revealed words of God; now men claim without fear or thought that the Bible is only infallible in what it claims about "salvation," and that its scientific and dietary claims are quite erroneous. Others maintain that the Bible "*is inerrant only in its original autographs*" which "original autographs" no longer exist anywhere on earth. These men fail to realize the nonsense of saying, "*is inerrant,*" about originals that no

longer exist.* This latter claim obviously denies both the infallibility of the present Bible and the preservation of the Bible.

With the former critical view, that Scripture is inerrant only in the spiritual realm and not in the realm of the natural, we find Galileo who stated, "Scripture teaches men how to go to heaven, not how the heavens go." Protestant and Catholic alike echoed "Amen!" The subsequent dismissal of the Bible as authoritative in the natural realm established two priestly castes: the *interpreter-critic* caste, who either tell believers what God *meant* to say or who graciously condescend to teach believers what the long-lost-and-certainly-never-seen-by-him "originals" say; and the *interpreter-scientist* priestly caste who read from the fabled *Book of Nature* to "correct" the errors in the written word of God. I know of no case where the interpreter-scientist has used the Bible to correct the Book of Nature. The spiritual realm is now totally dissociated from the physical realm and as a result, modern science is now fraught with superstition, political agendas, and science fiction.

So it was that with all sound theology summarily dismissed, science opened itself to every crackpot idea under the sun. The occultist, Emmanuel Swedenborg, regularly had spiritual communication with the inhabitants of the moon, stars, and planets who told him that the solar system originally started out as a collapsing cloud of gas and dust which subsequently split into rings that fell together to form the sun, moons, and planets.⁷ Laplace plagiarized Swedenborg's revelation, made some minor modifications, and to this day, under the name *Nebular Hypothesis*, it remains the standard superstition of how the solar system formed, despite that physics has again and again shown it to be an unworkable model. And with that, the revolution of science falsely so called against science truly so called ended. The Copernican Revolution had accomplished its goals: scientific experiments, observations, and facts were replaced with Greek philosophy, hallucinations, visions, dreams and half-baked theories that men believed because they are more beautiful than true.

* There is an old truism that says, "When a man messes with God's Book, God messes with his mind."

The Copernican Revolution Spills over Its Banks

The revolution of the sciences spilled over into the political realm. Both the American and French Revolutionary wars stemmed more or less directly from the Copernican Revolution. Great Britain had its revolutions, too, but they had been comparatively bloodless. In frustration certain early nineteenth century parties thirsted for the bloody revolution to come to Britain as it had come to France: a revolution which would make Britain safe for the "free thinking" humanist. "Free thinking," by the way, is a euphemism for foul-mouthed, bigoted, intolerant, narrow-minded, superstitious, name-calling railers who oppress all who feel free to think about and conclude for the existence of God. (See any publication put out by any officially atheistic group.) The nineteenth century British case will serve us well to illustrate the morality of modern science and the rationale behind its beliefs.

In the first half of the nineteenth century, the British monarchy still ruled by the *divine right of kings*, the idea that since God appoints rulers, the king rules in God's stead. This idea, which is not at all scriptural, was defended by William Paley (1743-1805) in his work popularly known by the title *Paley's Natural Theology*. The divine right of kings had sometimes been interpreted to mean that the king could do no wrong and was thus free to satisfy any of his whims without having to account to anyone. Paley claimed that the Bible was on his side, even though the word "natural" in the title of his book should have given him away. Paley simply abused certain scripture passages and ignored Romans 13:1, which clearly teaches that the king is ultimately responsible to God. Pointing out this very simple fact should have been enough to discredit the divine right of kings when that right was used as a license for evil.

But the political party which was out of power in early nineteenth century Britain had no use for God and his Bible. Under the auspices of the London Geological Society a young lawyer named Charles Lyell (1797-1875) published a three-volume work entitled *The Principles of Geology*. In an effort to promote his work, Lyell asked a fellow radical, Charles Babbage, for his endorsement of

the book. Babbage's response, dated May 3, 1832, has a strange ring to it:

I think any argument from such a reported radical as myself would only injure the cause, and I therefore willingly leave it in better hands.

What of the cryptic reference to "the cause?" As Grinnell phrased it, Lyell's work was:

...in support of political liberalism – although ostensibly it was an objective work in science free from any political implications. In his letter of May 3 to Lyell, Babbage was explaining why he would not write a favorable review of the book. Quite wisely, the Whig scientists, like Babbage, Lyell, Scrope, Darwin and Mantell, did not want the public to know that that which was being promoted as objective truth was little more than thinly disguised political propaganda.⁸

In his book, Lyell proclaimed his *uniformitarian principle*: the "present is the key to the past," as the only true scientific principle. This principle now undergirds all theories of evolution even though it is increasingly falling into disrepute. Yet for Lyell it was a way to deny the authority of Scripture by attacking the reality of the Noachic Flood. The flood had thitherto been held as the cause of the deposition of layers of sediments and fossils; and for that cause, it is still more than adequate today. But in order to discredit the divine right of kings and thus set the stage for a bloody violent revolution in England, Lyell determined to undermine the supposed biblical foundation for the divine right of kings by discrediting the Bible.

Lyell made it possible for the theory of evolution to come out of its hiding place in sociology and for evolution and sociology to meld into the natural sciences. In 1859 Lyell encouraged Charles Darwin (1809-1882) to write his book on evolution (which some claim was plagiarized from a manuscript written by A. R. Wallace

and sent to Darwin for review). Darwin was no stranger to evolution. He had learned it from the writings of his grandfather, Erasmus Darwin (1731-1802), who was ever the avowed enemy of God and the Bible. By making man out to be the end result of countless cosmic accidents occurring over millions of years, any vestige of purpose or meaning for human life that might have survived the mechanization of Kepler's universe, was now gone. After Darwin and Lyell, man was demoted to nothing more than a machine, and a cosmic accident at that.

After Darwin's book was published, the superstition of evolution banned God ever further from man's study for truth. With God excommunicated from the "natural sciences," Karl Marx was able to write his book, *The Communist Manifesto*, which quickly became the chief political instrument in the dehumanization and mechanization of man in this the twentieth century. In the 1920s Lenin expressed his indebtedness to Copernicus for making the world safe for Marxism and Communism.

Applied Evolution

Not long after Darwin and Marx, the German philosopher Nietzsche combined their evolutionary, sociological notions into one concept and concluded that man must be evolving into superman. Nietzsche was anything but a great thinker and not nearly as bright as his admirer, Adolf Hitler, who correctly reasoned that there cannot be such a thing as evolution into a superman but that the evolutionary end-product must be a "super race." What people like Hitler, Stalin, Amin, and Mao TseTung each has done to achieve his idea of a "super race" is history. It is applied evolution, complete with the survival of the fittest.

Hundreds of millions died in the twentieth century to purify the various races and tribes. Billions will likely die for the same end in this, the twenty-first century. Without the fear of God, there is no hope for mankind. Consider the case of Ludwig Boltzmann.

Murphy, Boltzmann and the Second Law

We've all seen copies of Murphy's Law and its corollaries. Usually Murphy's Law is stated as "If anything can go wrong, it will go wrong"; but true to Murphy's Law, the statement was not made by Murphy. Who was Murphy and whence his law?

Edward Aloysius Murphy was a U. S. Air Force Captain working on the rocket sled project back in 1949. One day he noted that a technician was installing accelerometers backward on a rocket sled. As a result, Captain Murphy's law was born as: "If there's more than one way to do a job and one of those ways will end in disaster, then someone will do it that way." Later the rocket sled driver, then Major John Paul Stapp, framed Murphy's Law into its current wording. So you see, Murphy was an optimist!

Now consider the case of Ludwig Boltzmann, born 14 February 1844, who was a famous Austrian physicist. Ludwig was among the staunchest advocates of "Murphy's Law" in the early twentieth century. He believed it so much that he committed suicide because of it at Duino on 5 September 1906.

It seems that as Boltzmann pondered the philosophical meaning of the second law of thermodynamics (commonly called "entropy"), he got so depressed by the hopelessness of "it all," that he killed himself. Now don't get the wrong idea; Boltzmann was not some poor deluded ignoramus on the matter. It was he who generalized the second law and took it out of the realm of thermodynamics and into the realm of information theory and statistical mechanics. In that sense he is most famous for deriving the current formula for entropy as " $S = k \ln w$."

Anyhow, before his suicide, Boltzmann lamented that his work on the second law would neither be appreciated nor believed. He realized that such is actually a consequence of the second law itself. Boltzmann's understanding of the second law lead him to the conclusion that man has no hope of saving himself because the second law dooms the universe. What finally pushed him over the edge to kill himself was being passed over for a position he had earned in favor of a patent clerk, of all things. The wealthy indus-

trialist Planck family had ousted Boltzmann for their newest protégé, Albert Einstein. Nowadays, "everyone" says Boltzmann was wrong, that all physicists believe the second law. But do they? If scientists believe the second law then why, in 1976, was the Noble Prize awarded to Ilya Prigogine for his *unsuccessful* efforts to circumvent the second law to allow for the theory of evolution?

Unfortunately for Boltzmann, although he was correct in concluding that his law would not be believed by scientists, he did not realize the extent to which he, himself, would disbelieve the second law. Think about it: could death create death? Could chaos create chaos? In short, could the second law create the second law? Thus there must be a Creator God if anything is to exist!

How do these stories relate to geocentricity? The simple connection is this: one of the predictions of the second law is that the truth is far less likely to be believed than is fiction. God is less likely to be believed than the Devil's lies, and the Bible is less likely to be believed than the fantasies of deluded scholars. One more example will serve to make the point.

Relativity and Moral Relativism

Whether advertently or inadvertently, relativity has contributed much to the moral dilemma facing modern man. Einstein and his followers proclaimed that relativity was not and is not a theory about morality: that relativity has nothing to do with moral relativism: the ancient idea that an action may be moral in one context but immoral in another; that there are no moral absolutes.⁹ The promoters of relativity claim that such a connection between moral relativism and relativity is the result of faulty understanding, that relativity does not at all say that all physical knowledge is relative and that Einstein held certain things as absolute in his theory. For example, Einstein claims the speed of light as an absolute speed limit for physical objects. Still others say that there is indeed a connection between moral relativism and relativity. Among these is Dean Turner who writes:

Without uniform time or cosmic moment, the notion of any universally binding distinction between past, present, and future would be logically and empirically inconceivable. ... And as a consequence, there could be no universally valid ideals for making binding moral distinctions, i.e., that are clearly applicable to *everyone everywhere* at a *given* time. ... In fact, I encounter several students in my classes every year who invoke Einstein's theory to justify their hatred of anti-moralism.¹⁰

This conclusion was indirectly corroborated by no less a personage than the atheistic philosopher, Bertrand Russell:

The collapse of the notion of one all-embracing time, in which all events throughout the universe can be dated, must in the long run affect our views as to cause and effect, evolution, and other matters. For instance, the question whether, on the whole, there is progress in the universe, may depend upon our choices of a measure of time. If we choose one out of a number of equally good clocks, we may find that the universe is progressing as fast as the most optimistic American thinks it is; if we choose another equally good clock, we may find that the universe is going from bad to worse as fast as the most melancholy Slav could imagine. Thus optimism and pessimism are neither true nor false, but depend upon the choice of clocks.¹¹

Of these statements one can only conclude that good and bad are relative and that they depend upon one's perspective; and this is precisely what Turner encountered in his students. And, I might add, Turner is not alone in his observation. I have seen the same behavior in my students to the point that now most college students believe that there is no such thing as an absolute and cannot be reasoned out of that belief because they can no longer think; they can only react in the presence of their herd. So modern man faces the prospect that there is no purpose to life, that morality is actually

relative and that what is morally right today may be wrong tomorrow or *vice-versa*.

Is there then no absolute? Logically it can be shown that there must be at least one absolute. To see this, consider the statement: "There are no absolutes" and note that it is self-contradictory; for if there are no absolutes then it is **absolutely** true that there are no absolutes and the statement itself becomes an absolute. The usual escape to this is to claim that there are no absolutes except for the fact that there are no absolutes. But this leads to what is called a *self-referral paradox* and leaves one with two absolutes, the absolute fact that there are no absolutes save one, and the statement of that fact. Hence there must be at least one absolute.

With such a logically contradictory philosophy and associated life-styles, is it any wonder that this is an age of despair? Such contradiction means that man is not dealing with reality but only with an imaginary world of his own making. Modern psychiatry calls that "psychotic." Others call it "virtual reality." The modern philosophy of existentialism has only questions; it has no answers. The Reformers foresaw the consequences of the Copernican Revolution and warned against it. The sound warning went unheeded for 450 years, and has become a target of ridicule.

Now I do not claim that heliocentrism is primarily responsible for man's moral dilemma today, but its acceptance did pave the way for a worldview which denigrated absolute moral authority to be subservient to man's limited, fallible mind. heliocentrism's removal of the Bible as absolute authority paved the way for the acceptance of the political lies of evolution and Marxism into man's worldview. The result gave man a lower view of himself and forced him to frame for himself ill-structured questions which can have no answers. Such is the legacy of modern heliocentric science.

Astrology and Heliocentrism

There is an additional type of moral degeneracy that results from heliocentrism's insistence on an earth that rotates on its axis,

revolves about the sun, and bobs its way around the center of the Milky Way. Astrology is an example of an occult belief tied to heliocentrism.

Astrology is an occult practice because it denies that God is ultimately in control of all events everywhere, and on earth in particular. Astrology insists that events on earth are controlled by the relative positions of the sun, moon, and planets as seen against the zodiacal backdrop. Astrology has no room for God.

Heliocentrists claim that astrology is tied to geocentrism and geocentricity, but that is false. Astrology is tied to the signs of the Zodiac, which traces the paths of the sun, moon, and planets throughout the courses of their respective years. Because the earth appears central to the zodiac, heliocentrists assume that the astrological system is a geocentric one. But the earth cannot be considered central in astrology for astrology maintains the events that transpire on earth are determined by the stars. We see this in our own language in words such as "disaster," which means "a bad star." Thus astrology deems the earth a base, subordinate object; subject to the sun in particular since the starting point for an astrological horoscope is the sign the sun was in when a life or event started. Second in importance is the position of the moon, and then the planets come into play. The earth is central to astrology in only one way; the sun, moon, and the host of heaven are believed to determine the fates of men and outcomes of events on earth.

If the major object in astrology is the sun, one would expect that depictions of the astrological figures of the zodiac should have the sun at their center, not the earth. This is very much the case. Throughout the Mideast there are mosaic floors that depict the twelve zodiacal constellations with an object in the center. Many of these floors are the remains of Hellenistic, Jewish synagogues. We find such mosaic floors in cities such as Tiberias, Sepphoris, and Beit Alpha. Most of the mosaics depicting the zodiac have the sun in the midst of the zodiac; none have the earth in the center. (See Figure 2.) Invariably the sun is depicted in the form of the sun god, Apollo, riding a flaming chariot. No such floor depicts the earth at the center of the zodiac. The floors date from the first



Figure 2: *The Byzantine mosaic floor of the Beit Alpha Synagogue, in Beit Alpha, Israel, depicts the sun god, Apollo, with his four horses in the center of the zodiacal signs. Such mosaics are common and most depict the sun at the center of the zodiac but none picture the earth at the center.*

few centuries in the Christian era, a time when the commonly accepted, scholarly model was still the geocentric model. Thus, the astrological depiction of the universe places the sun at the center of the starry sky. All these factors link heliocentrism to astrology. There is no such link between astrology and geocentricity.

One last thing should be noted while considering the connection between astrology and heliocentrism. Modern heliocentrism

started with Copernicus. Copernicus held several positions of importance not only throughout his life but also at the same time. At the time he published his heliocentric view, Copernicus held an ecclesiastical position as well as serving a patron who supported his astronomical aspirations. In return for that support, Copernicus was called upon to draw astrological charts for important events. We can honestly conclude that not only was astrology traditionally viewed as heliocentric, but astrology also financed the birth of the Copernican Revolution.

The Throne and the Firmament

Before we conclude the section on the throne of God, we should examine the relationship between the throne and the firmament. That relationship is presented in the first chapter of Ezekiel verses 22 through 28:

²² And the likeness of the firmament upon the heads of the living creature was as the colour of the terrible crystal, stretched forth over their heads above.

²³ And under the firmament were their wings straight, the one toward the other: every one had two, which covered on this side, and every one had two, which covered on that side, their bodies.

²⁴ And when they went, I heard the noise of their wings, like the noise of great waters, as the voice of the Almighty, the voice of speech, as the noise of an host: when they stood, they let down their wings.

²⁵ And there was a voice from the firmament that was over their heads, when they stood, and had let down their wings.

²⁶ And above the firmament that was over their heads was the likeness of a throne, as the appearance of a sapphire stone: and upon the likeness of the throne was the likeness as the appearance of a man above upon it.

²⁷ And I saw as the colour of amber, as the appearance of fire round about within it, from the appearance of his loins even

upward, and from the appearance of his loins even downward, I saw as it were the appearance of fire, and it had brightness round about.

²⁸ As the appearance of the bow that is in the cloud in the day of rain, so was the appearance of the brightness round about. This was the appearance of the likeness of the glory of the LORD. And when I saw it, I fell upon my face, and I heard a voice of one that spake.

In Chapter 6, in a footnote, I mentioned that at the edge of the firmament the firmament's protection of atomic matter fades away so that its extreme density and temperature become manifest. The firmament is impregnably solid at its edge. This is reflected in the vision that Ezekiel saw in the passage we just quoted. In verse 22, the firmament refers to a space terminating at a solid boundary, even as the firmament described in Genesis 1:6. The 22nd verse tells us that the edge is crystalline, a "terrible crystal," frozen solid. It stretched over the heads of the four creatures. Above the firmament is the throne of God, "the appearance of the likeness of the glory of the LORD," Ezekiel reports. We see that the living creatures are under the firmament, protected from the environment above the firmament where is the throne of God.

The throne's location on the firmament is reminiscent of Exodus 24:10 where the nobles of Israel: "...saw the God of Israel: and there was under his feet as it were a paved work of a sapphire stone, and as it were the body of heaven in his clearness." That the throne is above the firmament reinforces our conclusion that the throne is in the third heaven. It also validates our model of the firmament as a created plenum designed to protect God's creatures from his power as "a consuming fire" (Deuteronomy 4:24; 9:3 and Hebrews 12:29).

Conclusion

In conclusion, what disturbed the Reformers about heliocentrism and why they tried to combat it was that they recognized

however dimly, that moral relativism and superstition would have a more favorable climate for growth in a heliocentric culture than in a geocentric one. The Reformers foresaw that heliocentrism would weaken man's perception of the Bible as the authoritative word of God. Although their fears were not manifested in their lifetimes, eventually the Copernican Revolution led to higher criticism of the Bible, to the evolutionary worldview, and ultimately to communism and socialism. We shall speak more on these matters in the course of examining the historical developments of the geocentric and heliocentric models.

The bottom line is that if the earth is dead center of the universe, then the scriptural doctrine that there is an absolute frame of reference and an absolute standard of morality, pervading all space, is eminently plausible. If sun and earth drift aimlessly through space as a cosmic accident, then all motion is relative, there is no absolute space, and it is equally likely that there is no absolute standard of morality. Without an absolute standard of morality, the most one can claim is that morality is relative to the earth, relative to culture, or a matter of opinion only. After all, who can say but that the next universe or the next time may require a different morality? Morality is then situational, appertaining only to a given situation at a particular time. The lack of absolute moral standards leaves only immorality and this is what the Reformers foresaw and feared. That is, however, the state of affairs that predominates American media, society, and the world today.

Truth shall spring out of the earth; and righteousness shall look down from heaven.

—Psalm 85:11

13

UP AND DOWN

The central tenet of geocentricity is that the earth is at the dynamic center of the universe. If that is so, then the Bible should describe all directions with reference to the center of the earth. In particular, words like “up” and “down” should be consistently applied to the earth. Though this may seem trivial, it is a point of consistency with the geocentric teachings of Scripture and is necessary for the Bible to teach geocentricity.

Up and Down in Scripture

A straightforward tally of occurrences reveals that the word “down” occurs 1,131 times while the word “up” occurs about 5,340 times in forms specifying upward or downward direction. All told, that makes about 6,471 references. Not all of these are strong directional references. Some refer to “growing up” or the “lifting up” of head or eyes. Quite a few positional references in Scripture regard Jerusalem above all points on earth. Perhaps that is prophetic, pointing to the time when the 1500-mile high Jerusalem will come down to earth (Revelation 21:16). The Scripture uses the phrase “go up to Jerusalem” from not only locations inside Israel, but also from Egypt, Persia, and Babylon. Likewise, any direction away from Jerusalem is considered down from Jerusalem. Jerusalem on earth is a type of Jerusalem above, according to Gala-

tians 4:26.* Sometimes a verse quotes a fallible human and should not be counted as evidence for geocentricity. Nevertheless, most up and down verses are directional and so must be given full weight as absolute references.

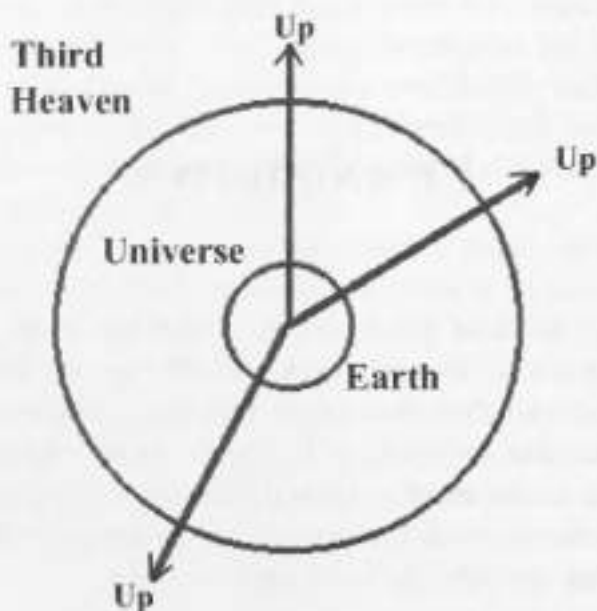

Figure 1: *Geocentric Coordinate System As Seen From the Third Heaven. (Not to scale.)*

The main geocentric up and down references are from God's point of view in the third heaven. It could be argued that from a heavenly perspective, anywhere in the physical universe is viewed as "down," but there is no reason to assume so. Figure 1 presents the Scriptural geocentric coordinate system in which every place in the universe is consistently referred to as "up" from God's point of view. This is because all three, the earth, the universe, and the third heaven are centered on the earth.

If the centers of the earth and the third heaven no longer coincide then the third heaven's "up," that is to say, from God's per-

* Galatians 4:26—But Jerusalem which is above is free, which is the mother of us all.

spective is not necessarily “up” from the earth’s perspective. Figure 2 shows a reference system where the center of the third heaven is below both the center of the universe and the center of the earth. The only time that “up” from the earth would coincide with “up” in the third heaven is if the third heaven’s up went through point A on the earth.

The fact that the Bible refers to heaven as being “above” and the earth as being “below” is indicative of a cosmic reference frame used in Scripture; for if God had not meant to indicate an absolute coordinate system then the words “above” and “below” should always be qualified with the words “the earth” to remove the doubt, “Up with respect to what?” In other words, the Bible

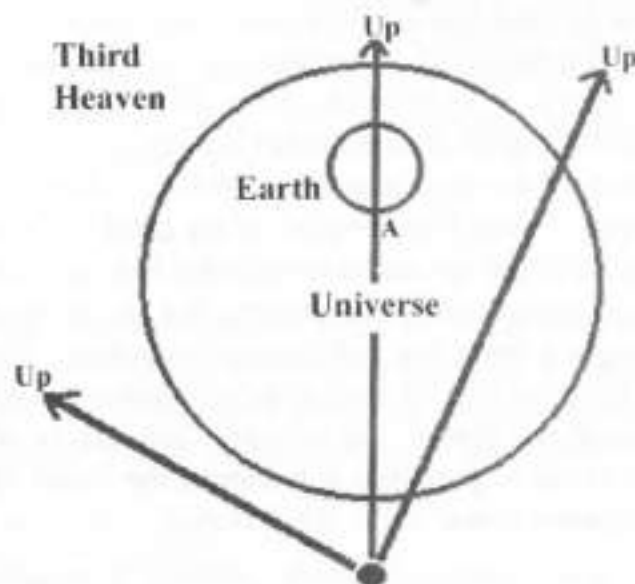

Figure 2: *Non-geocentric Coordinate System as seen from the Third Heaven.* There are “up” directions that are “down” as seen from earth.

could avoid the issue of an absolute coordinate system or frame of reference by consistently using “above the earth” and “below the earth” instead of just “above” and “below.” Likewise, instead of

“up” and “down,” the Bible could have used “up from the earth” and “down to the earth” or variants thereof.

Invariably, God uses an absolute cosmic reference frame with its origin on the earth. Interestingly, the reference frame’s origin is not so much the very center of the earth as it is the general vicinity of Jerusalem. Note how the cardinal directions of north, south, east, and west are all referenced to Israel even though not all events happen in Israel. Hence, Psalm 74:12 speaks of God “working salvation in the **midst** of the earth,” implying a central position. There are more references in the Bible to the “midst of the earth” and the “midst of the land.” These always refer to the dry-land area of the earth as opposed to the water plus land surface.

Although by far the most numerous, the “up” and “down” references actually form one of the weaker supports for geocentricity in the Bible. One would clearly understand that the terms “up” and “down” on Mars point respectively away from and to Mars’ center, for example. The point is that the application of these terms from the perspective of the third heaven (as well as “above,” “beneath,” “under,” “over,” “upon,” and “midst of the earth”) implies that the center of the earth and the center of the third heaven coincide. This is entirely consistent with geocentricity; but the terms are cosmically meaningless from the heliocentric coordinate system. Besides, there is no “up” or “down” to an omnipresent God except he select the coordinate system. Whichever God selects, would it not immediately come to pass that it **becomes** the frame of reference just by the creative power of his word alone?

The Double Revelation Theory

Despite the abundance of geocentric and geostatic references in the Bible, there are many who still maintain that the Bible is not geocentric. This they do primarily on the supposition that God cannot lie *in nature*. Such apologists believe that God wrote two books, the Bible, and the “Book of Nature.” Although most of them will deny it, in practice they hold that the “Book of Nature”

should supersede the Bible if there is any conflict between the two. At the very least, they maintain that natural revelation be held authoritative over the Bible in the realm of nature, and the Bible be held authoritative over matters spiritual.

One example will serve to illustrate how subtle such self-contradiction on the part of heliocentrists may be. In their book, *The Moon*, John Whitcomb and Don De Young state that between natural science and the Bible:



Figure 3: *The Christian Philosopher, who reads both the Bible and the Book of Nature*

Apparent contradictions do exist. ... No contradictions can be resolved in the mind of true Christians by relegating them to the “pre-scientific world view” of Biblical writers, for they were simply the spokesmen of the divine Author who inspired them.¹

Their profession is correct. Later, however, Whitcomb and De Young tell a different story:

Finally, and perhaps most famous of all, are biblical statements that refer to “the rising of the sun.” ... Does this mean that the Scriptures teach geocentrism? Not necessarily, for this is a language of appearance so appropriate that it cannot be improved upon even by astronomers of our day.²

Note the reference to the “language of appearance” in the above quote. What that means is that God tells us how things appear instead of the way things truly are. Although Whitcomb and De Young say that we should not resolve Bible problems by “relegating them to the ‘pre-scientific world view’ of Bible writers,” that is exactly what they do with geocentricity; they invoke the language of appearance that they believe is a pre-scientific “vestigial organ” in the evolution of languages; the two men contradict themselves.

The Bible, on the other hand, clearly teaches that “natural revelation” is flawed; for in 1 Corinthians 2:14 it is written:

But the natural man receiveth not the things of the Spirit of God: for they are foolishness unto him: neither can he know them, because they are spiritually discerned.

What is more “of the Spirit of God” than the Holy Bible? at least, according to the Bible itself (II Timothy 3:16-17).^{*}

Now one may object that the natural man is an unsaved man, and certainly unsaved men belong in the category of natural man. We who profess the inerrancy of Scripture tend to overlook that we still have two natures: the old man and the new man (Colossians 3:9-10).[†] The old man, that is our fleshy nature, is the natural man whereas the new man, that is our spiritual nature, is the spiritual man. These two war together as long as we are alive in this flesh. Those who claim that the Christian philosopher should “read” both the book of nature and the word of God has forgotten that the old

^{*} II Timothy 3:16-17—¹⁶ All scripture is given by inspiration of God, and is profitable for doctrine, for reproof, for correction, for instruction in righteousness: ¹⁷ That the man of God may be perfect, thoroughly furnished unto all good works.

[†] Colossians 3:9-10—⁹ Lie not one to another, seeing that ye have put off the old man with his deeds; ¹⁰ And have put on the new man, which is renewed in knowledge after the image of him that created him.

man is to be reckoned as dead (Romans 6:11)^{*} and to be put off because he cannot be trusted with the truth (Ephesians 4:22[†]), his father being a liar (John 8:44[‡]).

Yet, has science not proven that the earth goes around the sun? We showed in Chapter 6 on the Firmament (also see Appendix E) that there is absolutely no scientific proof that the earth either rotates or revolves. Thus, we maintain that the evidence favors geocentricity.

Conclusion

The most numerous verses of geocentric import are those that refer to directions up and down. Most are of marginal significance to the geocentric perspective; but a few, those that are based from the third heaven beyond the edge of the universe, use the words up and down in a way that is only consistent if the earth is central to it, and at least dynamically central to the universe. Furthermore, since the mind of man is subject to the fall and cannot possibly correct God's word, the Holy Bible, the fabled Book of Nature, cannot be relied upon to correct the written word of God which is incorruptible and directly given by inspiration of God. Even so, when it comes to geocentricity, creation bears witness to the immobility of the earth when every experiment designed to measure the speed of the earth through space returns a speed of zero.

^{*} Romans 6:11—Likewise reckon ye also yourselves to be dead indeed unto sin, but alive unto God through Jesus Christ our Lord.

[†] Ephesians 4:22—That ye put off concerning the former conversation the old man, which is corrupt according to the deceitful lusts.

[‡] John 8:44—Ye are of your father the devil, and the lusts of your father ye will do. He was a murderer from the beginning, and abode not in the truth, because there is no truth in him. When he speaketh a lie, he speaketh of his own: for he is a liar, and the father of it.

It turneth itself...

— Job 38:14

Young's Literal Translation

14

ALLEGED HELIOCENTRIC VERSES

Over the last 400 years several Bible passages have been proposed in support of heliocentrism. This is done exclusively by heliocentric Christians in their zeal to make the Bible more palatable to the atheist and agnostic who have so little difficulty in accepting the obvious geocentricity of the Bible.

Despite the insistence of these heliocentrists, no passage has gained any, let alone universal acceptance. There is not even agreement among heliocentrists as to which references, if any, support heliocentrism. The entire foundation for heliocentrism is modern "science." This is not the case for geocentricity where there is not only scriptural support but also scientific support. Since there is no universal agreement among heliocentrists on any heliocentric verse in Scripture, can we conclude anything else but that the proposed verses are primarily due to flights of fancy on the part of their advocates?

Job 38:14

A passage once held to promote heliocentrism, though now largely abandoned, is Job 38:14.¹ This verse is embedded in a moderately complex tapestry of pronouns so that the surrounding verses, twelve through fifteen, should be quoted in order to ascertain the meaning of the fourteenth verse:

¹² Hast thou commanded the morning since thy days; and caused the dayspring to know his place;

¹³ That it might take hold of the ends of the earth, that the wicked might be shaken out of it?

¹⁴ It is turned as clay to the seal; and they stand as a garment.

¹⁵ And from the wicked their light is withholden, and the high arm shall be broken.

A few heliocentrists point to the phrase, "It is turned" and conclude that this refers to the turning of the earth. Let us examine that passage more closely.

That the dayspring is a type of Christ we know from Luke 1:78 and 79 where Zacharias praises God for the Christ child, whose coming he refers to with the words:

⁷⁸ ... whereby the dayspring from on high hath visited us,

⁷⁹ To give light to them that sit in darkness and in the shadow of death, to guide our feet into the way of peace.

Notice the wording. The dayspring—the Lord Jesus Christ—does the visiting in verse 78 of Luke, and the commanding of the morning in Job 38:12 also has inherent in it the sense that it is the morning and the dayspring that move. So the twelfth verse in Job 38 is actually a geocentric prologue to a supposedly heliocentric verse. The dayspring knows his place, not only here on earth but also at the right hand of the Father.

An analysis of the pronouns in the passage reveals that it is the earth that is "turned as clay to the seal" and that the "they" of the fourteenth verse refers to both the morning and the dayspring. When it comes to the word "turned" in "it is turned as clay to the seal," the heliocentric apologist refers to a dubious use of some ancient signet rings that have been found. Now a signet ring is used to seal an official or secret paper or parchment document. The seal is pressed down on the clay or wax to make an impression therein, an imprint. The heliocentrist maintains, without support of

any kind, that a clay tablet was rotated under the ring and that it is that rotational motion which is referred to in the fourteenth verse; but this makes no sense.

Consider the ancient seal in Figure 1, which is shown twice actual size. Pressing the seal onto clay leaves an imprint of the unicorn and the lettering. However, rotating that seal makes a mess of the wax or clay and so it would for any seal. There is no proof that either ring or tablet were ever rotated to form a seal, it would be too easy to counterfeit as the pattern would be a mess; it would never be the same. So any analogy of turning as clay to a seal with the supposed rotation of the earth is circumstantial at best, supported only by a private interpretation of the word “turn” in verse fourteen.



Figure 1: Indian Seal of a Unicorn: dated circa 1700 B.C.

Other Forms of Turning

In English the word “turn” need not always mean, “rotate.” We say that milk *turns* sour, for example, but milk does not start to spin as it “turns” sour, nor does it spin faster and faster as it gets more and more sour. *Turn* is also used in the sense of returning to prior behavior. So it need surprise no one that the Hebrew word used here, *haphak*, is rarely if ever used in any overt sense of turning. *Haphak* is generally used in the sense of *repentance*, turning from your sinful ways to righteousness. *Haphak* is also used as a *turning* of the hand in order to help someone. *Haphak*'s most active form is found in Judges 7:13 where *haphak* is used to describe a cake of barley tumbling into the Midianite camp.

Other Reformation translations are no help to the heliocentrists here either since their corresponding languages lack the ambiguity of the English word “turn.” Diodati, in the Italian, reads “*mutti in diverse forme*” which literally means “mutated into di-

verse form.” The Dutch *Statenbijbel* reads “*verandert*” which is roughly equivalent to the English word “changed” and literally means, “to be othered.” Thus the Reformation translations are totally consistent with the English Authorized Bible and they are totally at odds with the interpretation of the heliocentrists.

Other objections, too, could be raised against a heliocentric interpretation of Job 38:14. First, there is the presence of the conditional, “might,” which appears twice in the thirteenth verse and which, coupled with the fact that the reference is to the judgment, means that the dayspring is not presently shaking the wicked out of the earth and that thus the earth is not now being “turned as clay to the seal.” Secondly, the use of the expression “is turned as clay to the seal” requires a constant expenditure of energy in order to keep the turning going. This is contrary to Newton’s first law of motion which states that a moving (or rotating) body will keep moving (or rotating) as long as there are no forces imposed upon it. Newton’s laws, of course, are the very cornerstone of the heliocentrists’ so-called proofs of the motions of the earth. If the verse is heliocentric, it would violate Newton’s first law, yet this is what Young did in the chapter quote when he claimed that the earth “turneth itself” is the best translation of *haphak*. To be heliocentric and still to be scientifically correct, the verse should read “it is turning as clay to the seal.” Thirdly, all Reformation translators had the word “rotate” at their disposal, yet none were led to use it in connection with this verse; not even the Holy Ghost himself in the original Hebrew.

The True Meaning

What, then, is the true meaning of the verse? There is an obvious meaning which could not be expressed more clearly than in the present wording. As a seal is pressed on clay or wax, the clay moves to fill in the grooves cut into the seal. In so doing, the clay wells up in a convection-like motion—a turning motion—and fills in the seal’s grooves. This interpretation is entirely consistent with Job 38:14 as well as the actual use of a seal. Although most mod-

ern versions read, "changed" instead of "turned," the motion of the clay under a seal is more accurately defined as "turning" since the clay remains clay and does not "change" into anything else. Such a turning motion of the earth could be responsible for uncovering the graves of the wicked at the last resurrection, which is consistent with the context of the verse. A "change" will not open graves and so is inconsistent with the context.

Of course, the greater context is the destruction of the last day. It may be that God is describing the dissolution of this present earth which will make way for the new earth.

Even in this present earth there is abundant evidence of a clay-to-the-seal type of "turning" on the part of the earth. There are rock beds which have been folded and bent as if they were pushed aside by tremendous weight. These are especially prevalent in mountain regions where some of the more severely disturbed are commonly referred to by geologists as having been "overturned." Such phenomena also occurred at the continental split of Peleg's day.

Conclusion

The heliocentrists' attempts to promote Job 38:14 and other passages as indicative of the rotation of the earth makes God out to be either a clumsy grammarian or a poor scientist, ignorant of the laws of physics that he, himself, instituted, namely, Newton's first law of motion. No alleged heliocentric verse has withstood the test of time and this one is no exception. Nevertheless, there are some more heliocentric candidate verses to examine before we can consider our Scripture survey complete.

Canst thou bind the sweet influences of
Pleiades, or loose the bands of Orion?

— Job 38:31

15

SWEET INFLUENCES

Chapter 38 of Job contains five references to celestial objects and powers that have a bearing on geocentricity. Job 38:31-33 says:

³¹ Canst thou bind the sweet influences of Pleiades, or loose the bands of Orion?

³² Canst thou bring forth Mazzaroth in his season? or canst thou guide Arcturus with his sons?

³³ Knowest thou the ordinances of heaven? canst thou set the dominion thereof in the earth?

In this chapter we shall examine the thirty-first verse. In the sixteenth chapter we consider Mazzaroth and Arcturus, and in the seventeenth chapter we shall examine the ordinances of heaven.

To begin, we shall consider the "sweet influences of Pleiades." The Pleiades is a very pretty little star cluster (see Figure 1) which is located in the northern hemisphere and can be seen in the night sky during late fall and winter. It would not at all be amiss to look no deeper into the meaning of the text than that such a pleasant little cluster by its very appearance be considered as exerting a "sweet influence." Many Bible critics have claimed that "sweet influences" is an incorrect translation of the Hebrew. The basis for this criticism lies in the wording of the *Septuagint* (LXX), a colla-

tion of a handful of poor-to-middling translations of the Hebrew Old Testament into Greek done in A.D. the second and third centuries.

Sweet Influences or Bonds?

The *Septuagint* translation of the start of Job 38:31 is:

And dost thou understand the band of Pleias?

Note that the LXX says nothing about binding sweet influences. It speaks of understanding a singular band. It behooves us, then, to examine what the *Douay-Rheims* says since it is supposed to be based on the LXX:

Shalt thou be able to join together the shining stars the Pleiades?

The *Douay-Rheims* matches neither LXX nor Authorized Version.

The *Septuagint* understanding "the band" instead of binding "sweet influences" is the version preferred most by the authors of books written about the astronomy of the Bible. The reason is that, if the underlying Hebrew word were band, then we would have a ready interpretation for the text, namely, that the band is gravitational. If "sweet influences" is meant, then the explanation is not as straightforward, albeit a lot deeper spiritually. Thus, the *Septuagint* reading is preferred by most authors.

The Hebrew word translated as "sweet influences" is *ma'adannah*, (Strong's H4575) which Strong claims comes from *'anad*, (H6029) meaning to bind or tie. The Authorized Version, supported by the *Geneva* and the *Dutch Statenbijbel*, selects *'adan* (H5727), which is also the root word for *ma'adan* (H4574), meaning, "delight."* Indeed, the feminine of *ma'adan* is *ma'adannah*, which exactly matches the underlying Hebrew.

* It should be noted that the A.V. translating committee is the only one to consult with astronomers on the matter of this passage's translation.

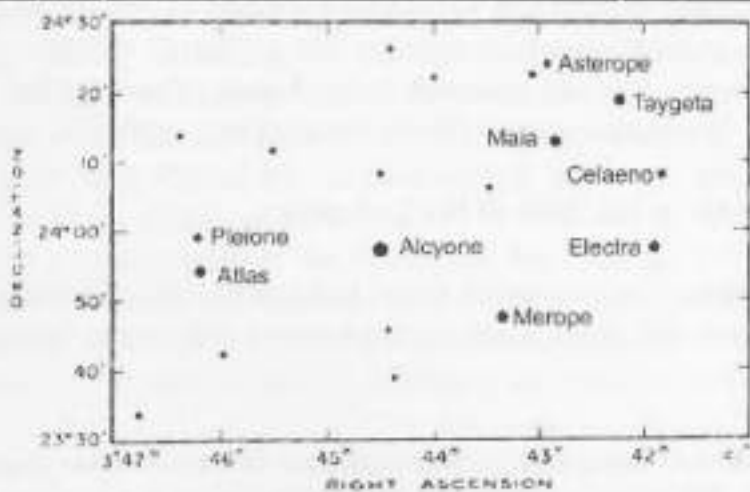

Figure 1: *The Pleiades*. Except for Alcyone, the names are not ancient.

It seems that in order to pass as a "recognized scholar," Strong placed *ma'adannah* as a separate word, assigning it its own number, H4575, instead of identifying it as the feminine form of H4574. The Hebrew thus supports the A.V. translation, delightful, i.e., sweet influences whereas Strong follows the mythical LXX.

History of the "Band"

Since "bands" or "bonds" is more to their liking, critics assume that the meaning of the original Hebrew must have been lost in time and that we should believe the *Septuagint* reading over the literal Hebrew.

The reading's popularity stems from the Roman Catholic Church's insistence that the *Septuagint* is the most authoritative text of scripture, to be preferred over the Greek and Hebrew texts. From the early eighteenth century on, Roman Catholic humanism* has ruled the universities of Europe and the Americas, so the pervasiveness of the modern opinion of identifying the sweet influences as gravitational bonds is readily understandable. The issue has nothing to do with truth; it has everything to do with final authority.

So it came to pass that heliocentrists point to Job 38:31 as referring to gravitation which is, after all, a "band" of sorts. This misinterpretation of *ma'adannah* as the bonds of gravity has quite a history. We shall examine that in the next two sections.

The Pleiades as the Hub of the Universe

Attempts to associate the sweet influences of the Pleiades with gravity have led theologians and scientists into some interesting

* Humanism here refers to man as the measure and final authority on all matters; particularly, that humanism which claims man's traditions are the final arbiter on the words of God and all matters of history, science, philosophy, theology, politics, mythology, and education.

speculations. It has even been postulated that the Pleiades are located at the center of the universe.

The brightest star in the Pleiades is called Alcyone. In Greek *alcyone* could mean the center, hub, or pivot, but another possible meaning is derived from *halcyone*, which means calm, peaceful, heavenly.* Halcyone is also the name of the kingfisher family of birds.

In Greek mythology, one has to cross the Alcyonian Lake in order to reach the under world, Hades. Pausanias¹ reported that even Nero, who having made stadia (a stadium measures 607 feet) worth of rope could not measure the lake's depth. And even though the waters of the lake are peaceful and quiet, any swimmer who tried to cross it was dragged down and swept away.

From the Alcyonian Lake influence, the Pleiades are associated with the feast of the dead on the first of November as celebrated by the Roman Catholic Church in Europe, the Celts, and the natives of Peru. Among native Australians the date sparked a three-day celebration in honor of the Pleiades.

Modern astronomers pay more attention to the Arabic names of the constellations. They regard them as more authentic or ancient than the Greek names. They do so to avoid the historical evidence that the most ancient star names stem from the Hebrews. In that way they conclude that the name for the star Alcyone is *Al Wasat*, which, according to the historic Arab astronomer Ulug Begh, means "the central one." The Arab, Hafiz, reported that the Pleiades were the seal or seat of immortality, that is, of Paradise. This view was shared by the Berbers of Morocco, some of the Moors, and the Dyaks of Borneo.

The pervasiveness of the belief that the Pleiades are the spiritual center of the universe led the German astronomer, Johann Mädler (1794-1874)² to conclude that the universe revolved around Alcyone.[†] The reason behind Mädler's speculation was that sev-

* Note how this dovetails with the A.V.'s "sweet influences." From *halcyone* we get the English "halcyone days" meaning heavenly days.

[†] Englishman Thomas Wright (1711-1786) postulated that the Milky Way is a band of stars and looks flat because the sun lies inside a flattened slab of stars.

eral years before, Sir William Herschel noted that stars seemed to be streaming past the sun away from the constellation Hercules. This he interpreted as due to the sun's motion towards Hercules.* Today the motion Herschel discovered is said to be due to the sun's orbital motion about the center of the Milky Way. But the Milky Way's center was unknown in the early nineteenth century and so Mädler suggested the Pleiades, which, as seen from earth, lie in the opposite direction from the center of the Milky Way. Because of his reliance on the Arabic star names, Mädler presumed Alcyone was the center of the universe. His idea proved so popular that, despite its being discredited, resurfaced several times during the twentieth century.

Sweet Influences, Bonds, and Gravity

Despite the relief some may feel in their faith that Job 38:31 refers to the gravitational bonds of the Pleiades, such relief is premature. In the gravitational interpretation, God asked Job if he could bind the Pleiades. The Pleiades star cluster is gravitationally bound, so the gist of God's challenge is to ask if Job can do the same.

The implied "bind" of the Pleiades can hardly refer to gravitational bonds. If the sweet influences of the Pleiades are to be interpreted as gravitation, we have a problem. Gravity is a grave matter; there is nothing particularly sweet about it. The influence of gravity is useful up to a point, but we hardly call it pleasant, especially when we fall. The word, gravity, is closely related to the word, grave. The fear and pain of death can hardly be called a sweet influence.

Wright also proposed that certain fuzzy objects were other milky ways in the Universe. Later, Immanuel Kant coined them "Island universes" and that is what Mädler meant by "universe." After Mädler, the term captured the imagination of the public and persisted a third of the way into the Twentieth Century.

* This phenomenon is known as "start streaming." In the geocentric framework the stars drift by the earth instead of the earth moving with them.

What, then, does the Bible mean by “sweet influences”? Elsewhere the Bible refers to the Pleiades by its other common name, the *Seven Stars*. In Amos 5:8 we read:

Seek him that maketh the seven stars and Orion, and turneth the shadow of death into the morning, and maketh the day dark with night: that calleth for the waters of the sea, and poureth them out upon the face of the earth: The LORD is his name

The same seven stars are referred to again in Revelation 1, verses 16 and 20 as well as the first verse of the second and third chapters of Revelation. In Revelation, the seven stars are associated with the angels of seven churches, the seven proponents of the gospel. In several nations the Pleiades are associated with Noah's Flood. In particular, the Hebrews associate the cluster with the promise God made to Noah in Genesis 9:11-17 where God promised never again to send a global flood. Was there ever a sweeter influence than the gospel whereby sinful man may be saved, sanctified, sealed, and delivered? Bonds and chains are for the prisoners under the law not for those under grace. Attempting to equate the “sweet influences” of Job 38:31 with Newtonian gravity removes the prophetic reference to the gospel of Jesus Christ.

The Bands of Orion

Job 38:31 continues with God asking Job if he can: “... loose the bands of Orion.” Here, too, heliocentrists read “gravity,” only in this case it does refer to “bands.”

Orion is the most prominent constellation in the sky. It rises several hours after the Pleiades and folklore commonly associates the two constellations; Orion is said to be chasing the Pleiades (Figure 2). Although some men, particularly advocates of the *gospel in the stars*—the belief that the constellations tell the gospel story—like Seiss³ and Bullinger,⁴ maintain that Orion is a type of Christ; in fact the Hebrew name for Orion, *Kesil*, means “big fool.” The verse thus refers to the bands of a fool. About the constella-

tion of Orion, the hunter, the Hebrews teach that after the flood Nimrod, the hunter, claimed the constellation as his own, applying it to himself. Nimrod, of course, is credited with founding the ancient Babylonian religious system which persists to this very day.⁵ Since a fool is unredeemed, we do not see any "sweet influences" there but we do see the bands of sin and death.

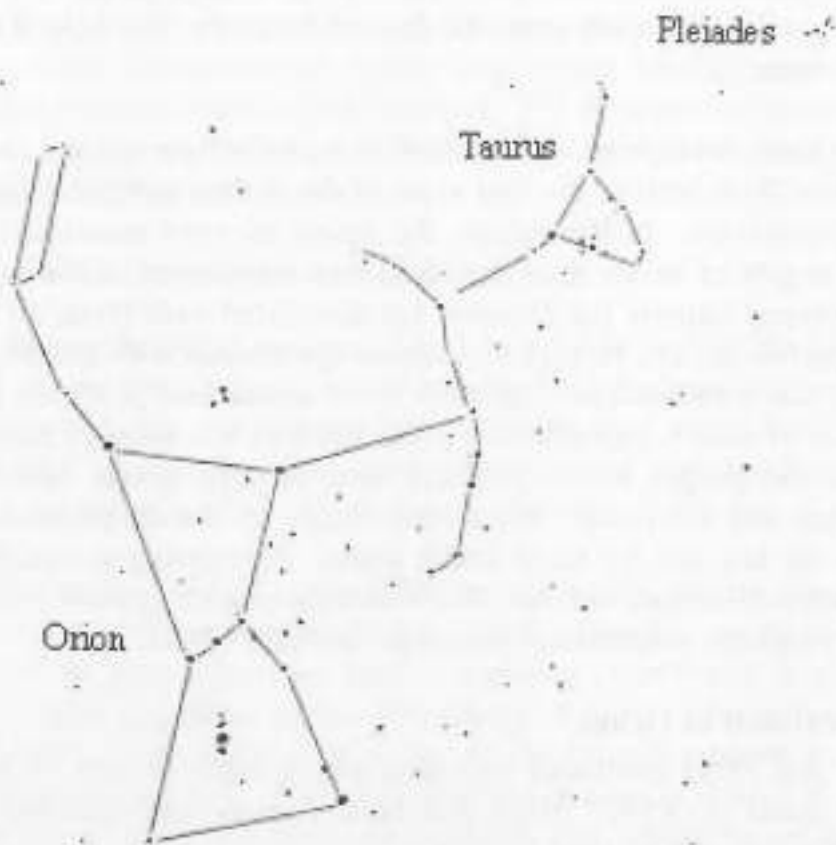

Figure 2: *The constellations of Orion, Taurus the Bull, and the Pleiades as they appear in the sky*

But what of gravity? Some have suggested that the bands of Orion refer to gravity. The constellation of Orion is so huge, covering such an immense volume of space, that it is not at all gravitationally bound. In other words, gravitationally speaking, there are no "bands" to be "loosed" for the constellation of Orion. So to

equate the "bands of Orion" with gravitation is stretching things, to say the least. Proverbs 27:22 sums up the whole Orion matter:

Though thou shouldest bray a fool in a mortar among wheat with a pestle, yet will not his foolishness depart from him.

The Pleiades, Orion, and Geocentricity

Throughout the above accounts, those who know Scripture will see in the Pleiades references allusions to the Bride of Christ. The doctrine is that it is the churches—the true Bride of Christ as described in the Holy Bible and none other—which occasions that the earth is located at the center of rest in the universe. It was for that Bride that Jesus Christ, God incarnate, came and shed his blood for her redemption. Her members, even those who believe on the Lord Jesus Christ, are assured eternal life, even the resurrection from the dead.

Finally, when she is complete and ready, the Lord Jesus Christ will return for his Bride and she will be his wife forever. But for now she is hunted and persecuted by "Orion,"—the giant of this world—until the day of her redemption. Although her end in this world is drawing nigh, she is still the light of the world and indwelt by the same Holy Ghost* who came upon her betrothed, Jesus Christ, in the form of a dove (Luke 3:22[†]). And just as Lot kept the wrath of God from falling on Sodom and Gomorrah, so the Bride, the body of Bible believers, is staying the wrath of God in the world today.

The gospel of grace the Bride offers the world—that eternal life and forgiveness of sins are the free gift of God to the sinner who will but believe it—embodies the sweet influences spoken of

* The Holy Ghost in the Old Testament is found in the tabernacle as the candlestick in the Holy place. Its seven lamps are the seven Spirits of God said in Revelation 1:4 to be before his throne.

[†] Luke 3:22— And the Holy Ghost descended in a bodily shape like a dove upon him, and a voice came from heaven, which said, Thou art my beloved Son; in thee I am well pleased.

in Job. The seven stars mentioned by the prophet Amos are the seven Spirits of God that together constitute the Holy Ghost who dwells in each believer and is the source of the charity that bonds the whole body of the bride and Christ in perfectness (Colossians 3:14).*

When we look at the lore associated worldwide with the Pleiades we find threads of all the elements connected with the Church in the Holy Bible. There can be little doubt that the original pattern, perhaps dating back to Adam who was the first astronomer among Jewish and early Christian writers, is at least in part preserved in the world's myths and tales of the Pleiades. We find then, in the Pleiades, a strong type of the Church of God.

Conclusion

Job 38:31, although held as evidence for heliocentrism in Scripture, fails to support any heliocentric interpretation. Instead, we find only geocentric overtones. Certainly, gravity cannot be read into either the "sweet influences" or the "bands" mentioned in the verse. But even if gravity were meant, the verse would still not imply heliocentrism. The replacement of "bands" or "chains" for "sweet influences" with reference to the Pleiades star cluster is not supported by the Hebrew wording but is drawn from the mythological *Septuagint*, the text of which cannot be traced back any earlier than the third century A.D. Job 38:31 is not at all heliocentric, not even given the heliocentric claims for the verse, for the motions of the earth and sun are nowhere in evidence. We conclude that the sweet influences of the Pleiades refers to the gospel of Christ as taught by the seed that serves him (Psalm 22:30;† Matthew 1:1a,‡ A.V. only) even the forgiveness of sin and the gift of eternal life in perpetual joy.

* Colossians 3:14—And above all these things *put on* charity, which is the bond of perfectness.

† Psalm 22:30—A seed shall serve him; it shall be accounted to the Lord for a generation.

‡ Matthew 1:1a—The book of the generation of Jesus Christ...

The bands of Orion, on the other hand, refer to the bondage of sin even as the angels that left their first estate in rebellion (Genesis 6:1 v.f.) were bound at the start of the Flood (II Peter 2:4). Although Job 38:31 is popularly promoted as a verse referring to gravity, and thus in support of heliocentrism, we see that the contrary is the case and that the Scripture verse is geocentric.

Canst thou bring forth Mazzaroth in
his season?

—Job 38:32

16

MAZZAROTH

Having found no evidence for heliocentrism but evidence for geocentricity in Job 38:31, we proceed to the thirty-second verse. Job 38:32 has also been promoted as heliocentric. Job 38:32 starts out with:

Canst thou bring forth Mazzaroth in his season?

Insofar as the question itself is concerned, the implicit answer is “No,” neither Job, nor any other man, can bring forth Mazzaroth in his season.

But, we may wonder, what is *Mazzaroth*? To tell the truth, no one really knows. The word itself has been transliterated from the Hebrew, not translated. The translators of the Authorized Bible had good reason to transliterate it and not to attempt a translation; they didn’t know either. All we can gather from the verse is that Mazzaroth is brought forth for a season.

Mazzaroth as the Zodiac

Most modern commentators opt for the translation of “Mazzaroth” to mean “zodiac.” But Hebrew has a perfectly good word for the zodiac, *zadok*, and it is not at all related to the word, Mazzaroth. The Hebrew for zodiac translates into English as “the righteous way,” which refers to the band of twelve constellations

through which the courses of the sun, moon, and planets appear to pass through the sky (see Figure 1). To equate the zodiac with Mazzaroth is at best only a partial truth, however, for there is more involved in the word "Mazzaroth" than just the constellations of the zodiac.

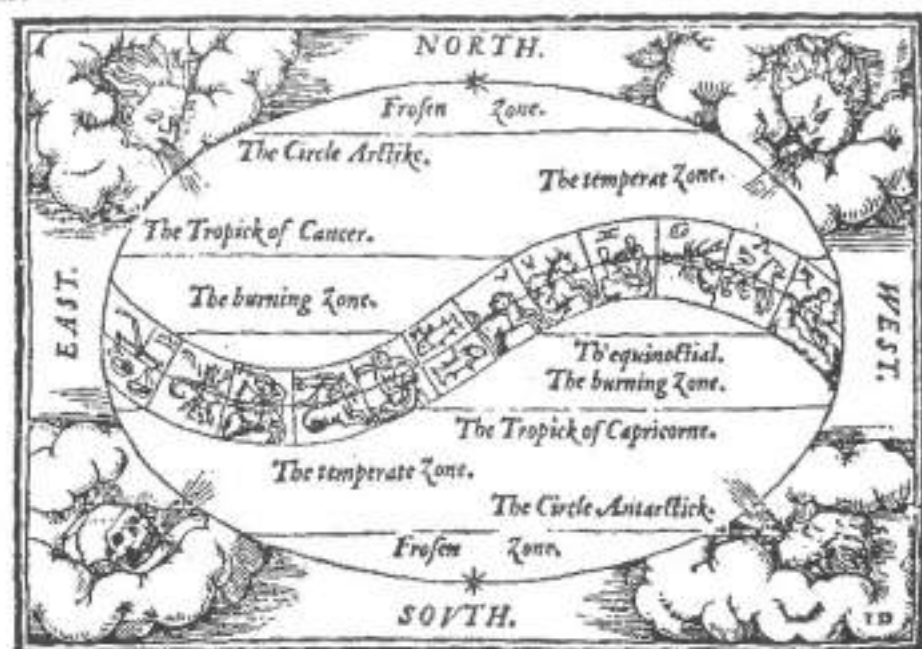

Figure 1: The Zodiac Projected on the Climate Zones of Earth

A complete discussion of the meaning of the word "Mazzaroth" is not possible here, however, we can decompose the word and compare it to similar words. The idea is to sketch the meaning of the word with just enough background to understand its significance, especially in the context of geocentricity.

To start, there is a related Hebrew word, *mazzalah*, which appears in the Bible, in II Kings 23:5. There it has been translated as "planets":

And [Josiah] put down the idolatrous priests, whom the kings of Judah had ordained to burn incense in the high places in the cities of Judah, and in the places round about Jerusalem; them

also that burned incense to Baal, to the sun, and to the moon, and to the planets, and to all the host of heaven.

This verse supports the contention that the term "Mazzaroth" may have something to do with the zodiac, but it also broadens its meaning; for it generalizes the word to include all the constellations through which the moon and planets, and all the host of heaven appear to pass as seen from the earth.

At the time that the Bible was translated into English, only five of the planets were known: Mercury, Venus, Mars, Jupiter, and Saturn (earth is not a planet if it does not move). Since then, two more planets have been discovered: Uranus and Neptune. These planets all stay within the boundaries of the constellations that comprise the zodiac.

When Pluto was discovered in 1930, it was counted among the planets, but Pluto's orbit is highly inclined or tilted to the zodiac. The inclination of Pluto's orbit is so great that it does not pass through all of the zodiacal constellations but misses some of them, passing either too far north or too far south. Since the 1980s additional planets have been found and these led to the demoting of Pluto from planet to dwarf planet. These, like Pluto, have highly-inclined orbits that are only loosely confined to the plane of the ecliptic, the zodiac. We see, then, that unless we confine ourselves to the naked-eye planets, we have problems associating Mazzaroth with the zodiac as the way of the planets.

Splitting the word Mazzaroth apart, we find *Ma* which means "what," or "thing," and *zarah* which means "compass," as in a circular path. But *zarah* can also be translated as "castaway," a negative term. The "compass" meaning may have significance for the "season" God grants for Mazzaroth. And the castaway reference could also relate to Satan, who will at the end of the Jewish Millennium be released for a short season to deceive the nations before the creation of the new heavens and earth (Revelation 20-21).

Again, we really do not certainly know the meaning of the word Mazzaroth other than that it is vaguely associated with

planets or the host of heaven; but I tend to favor the castaway anti-Christ interpretation because it fits the singular "season" in Job 38:32 as well as the guiding of Arcturus. The interpretation is also not sullied by the vagaries of what constitutes the zodiac given the distribution of planets, dwarf planets, planetoids, comets, asteroids, meteoroids, and interplanetary dust. My interpretation is also strengthened by the apparent association between Mazzaroth and the worship of the planets of II Kings 23:5.

Others have proposed more obscure interpretations for Mazzaroth. Some think that Mazzaroth refers to the four cardinal points along the ecliptic that define the seasons. The day that the sun passes from south to north of the equator is called the *vernal equinox*; the northernmost point reached by the sun is called the *summer solstice*; the point at which the sun passes from the northern hemisphere into the southern hemisphere is called the *autumnal equinox*, and the *winter solstice* occurs when the sun is at its southernmost point. These dates mark the first days of spring, summer, fall, and winter respectively: the four seasons. That may explain the seasonal aspect of Mazzaroth, but it does not explain why season is singular.

In addition, the place where the ecliptic crosses the equator moves to the west, completing one rotation in about 25,800 years. That phenomenon is called, "precession of the equinoxes." It is the procession of the seasons, including the precession of the equinoxes that can also contribute to the "bringing forth of Mazzaroth."

Although Mazzaroth is embedded between two verses which have achieved limited acclaim as heliocentric, Job 38:32 itself belies heliocentrism. Let's look at the start of the verse again:

Canst thou bring forth Mazzaroth in his season?

Consider the phrase "bring forth." If one or a set of constellations is meant then what interpretation can there be but that the constellations are doing the moving? The heliocentric view is that

the earth does the moving and that the sun only appears to move against the fixed backdrop of stars, the zodiac. But if Mazzaroth is taken to mean zodiac, or any extension thereof, then the usage of "bring forth" implies that the so-called "fixed stars" do the moving and not the earth. This distinction means that the stars, too, and not just the sun have a seasonal motion or "bringing forth." Admittedly, the verse does not explicitly say that the stars are moving but asks the question as to whether Job can bring them forth. The association of Mazzaroth with the seasons, on the other hand, would give circumstantial support to the idea that the stars are moving simply because the seasons change.

Arcturus and His Sons

The same argument about the "bringing forth" can be applied to the clause which follows in Job 38:32:

...or canst thou guide Arcturus with his sons?

Arcturus is the brightest star in the constellation of Bootes, the shepherd (Figure 2), and is located beyond the end of the handle of the Big Dipper, also known as the sheepecote. As usual, modern commentators insist that "Arcturus" is a bad translation; they prefer the transliteration *Ayish*. The Hebrew word *Ayish* should be translated as "bear," they claim. This claim comes about by replacing the original Hebrew's meaning, assembler, with the Arabic meaning of *Ash*, which relates to bear.¹

Now the star at the tip of the handle of the Big Dipper is called *Benet Nasch* (also spelled *Benet N'Asch*). In Hebrew and Arabic this means "son of *Ash*." The Hebrew can translate to "son of the assembler or gatherer." Since *Benet Nasch* is part of the constellation Ursa Major (the Big Bear), we have a clue to what constellation or star the Lord refers to in Job 38.

The bowl of the Big Dipper is pictured as a sheepfold. The stars making up the handle of the Big Dipper are three sheep that are usually pictured as going into the fold. But what if instead

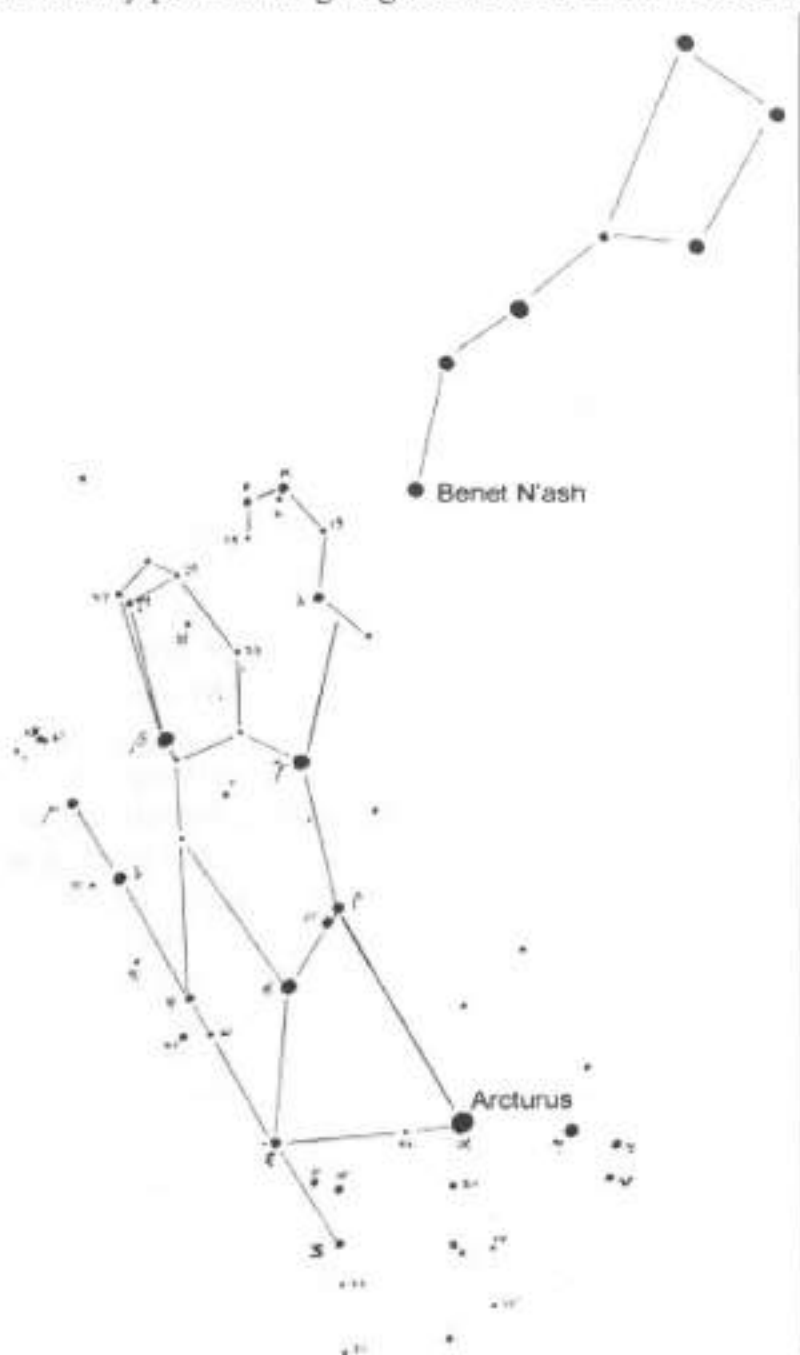

Figure 2: *Arcturus in Boötes and the Big Dipper*

they are coming out of the sheepfold following a ram and heading for the shepherd Bootes? If you follow the handle of the Big Dipper down, away from the bowl, you arrive at the bright star, Arcturus. The picture we are left with is that of a lead ram, followed by his sons are heading for the Shepherd with the sheep soon to follow.

Until the nineteenth century Arcturus was the only acceptable translation of the Hebrew. Additional evidence could be given to show that *ash* is "Arcturus," but that is not necessary to bolster the geocentric argument that the phrase "guide Arcturus with his sons" means that Arcturus and sons—whether constellations or stars—move and not the earth.

Conclusion

Insofar as Job 38:32 is concerned, we have found no support for heliocentrism. Instead, verse 32 provides additional support for geocentricity if *Mazzaroth* is a band of seasons, as pictured in Figure 1. Likewise, the stars Arcturus and his sons are said to be moving. The Bible thus remains consistently geocentric.

We also examined the possible interpretations of *Mazzaroth* but could come to no certain conclusion. The only option is to leave the word as it is, namely, transliterated and untranslated.

Finally, we looked at Arcturus and his sons and were a bit more successful in interpreting that puzzling passage. But if you, dear reader, disagree; well, that's fine, too.

Thy will be done in earth, as it is in heaven.

— Matthew 6:10

THE ORDINANCES OF HEAVEN

We now conclude our examination of Job 38:31-33 as verses that some claim support modern heliocentrism. Verses 31 and 32 have proven to be supportive of geocentricity instead of heliocentrism. Verse 33 introduces what most heliocentrists consider to be the bastion of heliocentrism in the Bible; the ordinances of heaven:

Knowest thou the ordinances of heaven? canst thou set the dominion thereof in the earth?

We saw earlier that Christian heliocentrists, upon hearing of the *bands* of Orion and the *sweet influences* of Pleiades in Job 38:31, immediately think they refer to gravitation. It is no surprise, then, that when the Bible mentions "ordinances of heaven," heliocentrists immediately think of the law of gravity. Christian heliocentrists believe that scriptural references to the ordinances of heaven refer to the laws of physics in general and gravitation in particular. Physicists assume that the ordinances of heaven wield dominion over earth, even as they have dominion in the stellar heaven. It seems not to enter into heliocentrists' minds that some of these ordinances may have spiritual applications, too.

Ordinances Celestial and Terrestrial

It is not difficult to show that there is more to the interpretation of Job 38:33 than gravitation. God asked Job if he, Job, could “set the dominion” of the ordinances of heaven “in the earth.” The ordinances of heaven go far beyond the laws of astrophysics. They include spiritual ordinances, too, as we saw when we looked at the sweet influences of the Pleiades in Chapter 15. Psalm 119:89, for example, says “For ever, O LORD, thy word is settled in heaven.” God’s word is settled in heaven and revealed in earth. This is a spiritual principle. The word of God is not lost that it should needs be “rediscovered,” as publishers of modern versions insist, every time some new manuscript or archaeological discovery affords the excuse for a new Bible version. That the words of the Lord, as settled in heaven, are revealed and preserved in earth is itself a revealed truth, not a discovered truth.

Note the particular phraseology in Job 38:33: “set the dominion of the ordinances of heaven in the earth,” implies that the earth has dominion over the ordinances of heaven, be they spiritual or physical. It is a small thing for heaven’s ordinances to have dominion over the tiny earth, but it is a much more magnificent thing for tiny earth to have dominion over heaven’s ordinances. The wording does not allow the ordinances of heaven to have dominion over the earth.

We first proposed the idea that the earth has dominion over the universe in Chapter 6 when we noted that the firmament will fight any attempt to move the earth in any way, shape, or form. So, when it comes to gravity, the location of the earth at the firmament’s center of mass makes the earth’s gravitational field one with the firmament’s. Talk about location, you realtors....

One may object that this line of reasoning is weak, but there are other indications in Scripture that imply that the ordinances of heaven referred to in Job 38 do not have dominion in the earth. Take our chapter quote, Matthew 6:10 for example:

Thy kingdom come. Thy will be done in earth, as it is in heaven.

Why would Jesus teach his disciples to pray that God's will be done in earth if it can't help but be done as Calvin taught? And are the ordinances of heaven not part of God's will, especially when they are used to symbolize the permanence of God's covenant in Jeremiah 33:20, 21, 25 and 26? Those verses read:

²⁰ Thus saith the LORD; If ye can break my covenant of the day, and my covenant of the night, and that there should not be day and night in their season;

²¹ Then may also my covenant be broken with David my servant, that he should not have a son to reign upon his throne; and with the Levites the priests, my ministers. . . .

²⁵ Thus saith the LORD; If my covenant be not with day and night, and if I have not appointed the ordinances of heaven and earth;

²⁶ Then will I cast away the seed of Jacob, and David my servant, so that I will not take any of his seed to be rulers over the seed of Abraham, Isaac, and Jacob: for I will cause their captivity to return, and have no mercy on them.

In verse 25 above, the Lord draws a distinction between the ordinances of heaven and the ordinances of earth, as if to say that these two sets of ordinances are not necessarily the same. This supports the conclusion proposed earlier from Job 38:33. Such a distinction between the things of earth and the things of heaven is also drawn in I Corinthians 15:40-41 where Paul wrote:

⁴⁰ There are also celestial bodies, and bodies terrestrial: but the glory of the celestial is one, and the glory of the terrestrial is another.

⁴¹ There is one glory of the sun, and another glory of the moon, and another glory of the stars: for one star differeth from another star in glory.

To claim that these latter verses merely refer to the different brightness of the sun, moon, and stars is to ignore both the context of I Corinthians 15:40-41 which is the contrast of this earthly body with a resurrected body.

All of the aforementioned verses draw a distinction between things celestial and things terrestrial. These differences are also inherent in the ordinances of heaven and the ordinances of earth. Thus the ordinances of heaven cannot be restricted or equated to what is popularly called the "laws of physics." Actually, the so-called "laws of physics" are not "laws" at all, for if they were then God would break the "law" every time that he performed a miracle. Take the "second law of thermodynamics," for example. One of the implications of the "second law" is that the dead cannot be resurrected; nevertheless, Jesus resurrected Lazarus and others and thus violated the "second law." When Jesus walked on water, he violated the law of surface tension of water, as well as the law of gravity. When God spoke the universe into existence, he violated the first law of thermodynamics, which states that energy (or matter) can neither be created nor destroyed. Thus the "laws" of physics are "laws" only in the traditions of men. From God's perspective, they are mutable laws or ordinances.

Other Ordinances of Heaven and Earth

Some of the ordinances of heaven and earth are explicitly stated in the Bible. Among the ordinances of earth are those mentioned in Genesis 8:22:

While the earth remaineth, seedtime and harvest, and cold and heat, and summer and winter, and day and night shall not cease.

These ordinances appertain to spring and fall, the climate zones, and the seasons.

It has been argued that because of Genesis 8:22, Joshua's long day could only have been an optical illusion at best.¹ The gist of the argument is that if Joshua's long day and Hezekiah's sign are not optical illusions local to Israel, then day and night shall have ceased and so God would have violated his promise of Genesis 8:22. But read the verse carefully. It says that day and night shall not cease; it does not say that they shall all be of exactly the same duration. Nor does the scripture say that they cannot be paused. A day does not "cease" simply if it is lengthened.

Likewise, it is written in Daniel 2:21 that God:

. . . changeth the times and the seasons . . .

If Joshua's long day violates God's promise to Noah, then this verse also violates that promise. Clearly, then, there is no inconsistency between the "ordinances of heaven" as mentioned in the Bible and the doctrine of geocentricity as consistently taught in Scripture. Nor, for that matter, do variations in the length of the day nor in the length of seasons contradict Genesis 8:22. After all, day and night, as periods of light and darkness, are each six months long at the earth's poles, but only about 12 hours long at the equator. If Joshua's long day violates God's covenant in Genesis 8:22, then what does a day at the poles do? At the North and South poles there is only one day—one sunrise and one sunset per year.

Jeremiah 31:35-36 specifies some of the ordinances of heaven, particularly those of the sun, moon, and stars:

³⁵ Thus saith the LORD, which giveth the sun for a light by day, and the ordinances of the moon and of the stars for a light by night, which divideth the sea when the waves thereof roar; The LORD of hosts is his name:

³⁶ If those ordinances depart from before me, saith the LORD, then the seed of Israel also shall cease from being a nation before me for ever.

Here the ordinances include how light is produced and for what purpose. Nothing is said about any ordinances involving gravitational motions or lack of motions on the part of celestial bodies.

The ordinances of the sun, moon, and stars were specified at the time of their creation in Genesis 1:14-15, where we read:

¹⁴ ...to divide the day from the night; and let them be for signs, and for seasons, and for days, and years:

¹⁵ And let them be for lights in the firmament of the heaven to give light upon the earth...

Genesis 1:16 adds that the sun is to rule the day and that the moon and stars are to be co-regents over the night. These, then, are the ordinances of heaven that are referred to in Jeremiah 33 and Job 38.

Conclusion

In summary, we find in connection with Job 38:33 that the Bible isolates the following ordinances of heaven: first, that the sun is a light for the day; second, that the moon and stars are for lights at night; third, the ordinances include the means by which said light is produced; fourth, the celestial bodies are for signs; fifth, they are also to be for seasons and sixth, that the seasons as well as day and night (as periods of light followed by darkness) shall not cease until the end of the earth shall come. These are the ordinances of heaven which the Bible identifies for us. They are set in earth, meaning that the ordinances of heaven were established for the earth and are ruled by the earth which has dominion over them as instituted by the Lord God himself.

Because they are set in earth, and were created for the earth, the ordinances of heaven are geocentric, not heliocentric. We conclude that God's questions to Job in Job 38:31-33 are not heliocentric as has been claimed but are, instead, the questions that point to a geocentric creation. Job 38 contains not a shred of evidence for heliocentrism: only for geocentricity.

He stretcheth out the north over the empty
place, and hangeth the earth upon nothing.
—Job 26:7

18

HE HANGETH THE EARTH UPON NOTHING

Having spent the last four chapters examining alleged heliocentric verses, we have yet to find a single heliocentric verse in the Bible. We now look at the last of the verses that have been offered as proof or evidence of heliocentrism in the Bible. Job 26:7 (the chapter quote) is often used by heliocentrists as evidence that the Bible knew of gravitation long before Sir Isaac Newton. In Chapter 3 we explored the role of Job 26:7 in determining the Bible's concept of the shape of the earth, and specifically the context of the pillars of the earth, but using the verse for gravity is a new twist. Have we finally found an astronomical reference to gravity in the Bible with Job 26:7?

To answer this question we note that historically there are two views of gravitation: first is the Newtonian view that gravity is a force, and second is the view of Einstein which holds gravity as inherent in the fabric of space. Whether gravity is seen as a force or a "bend in the space-time continuum," the word "nothing" does not seem at all descriptive of gravity. How, then, can heliocentrists persist in holding up Job 26:7 as evidence for the earth's being supported by gravity?

The way out of this dilemma for the heliocentrists is to equate gravity with the idea of a "rope" upon which the earth is hanging.

In that case there must be two ends to the "rope." The earth is at one end, but according to Job 26:7 the other end is not fastened upon anything. However, as every schoolboy "knows," the theory of gravity requires that the sun be attached to the other end of the "rope." To be entirely consistent with the verse, if we assume that Job 26:7 is indeed evidence for the earth being suspended in space upon a gravitational "rope," then the "thing" on the other end of the rope, namely the sun, is counted in Scripture as "nothing." Clearly, the sun is a "something," not a "nothing."

One can further pursue the speculation that Job 26:7 refers to gravity. The new approach claims that the verse does not refer to the earth directly but indirectly via some indefinite number of intermediate "nodes" (gravitational centers) of which the sun is most obvious. The gravitational "rope" which holds the earth starts with the earth and has the earth hung upon the center of mass of the earth-moon system.* Then that center of mass is hung upon the center of mass of the solar system, which lies about two-thirds of the way out from the center of the sun to its surface. That, in turn, is gravitationally connected to the center of mass of the Milky Way, which is connected to the center of mass of the local group of galaxies which connects to the center of mass of a local cluster of galaxies which is linked to the local supercluster, and so on and on ending who-knows-where. But neither Newtonian nor Einsteinian gravitation will allow such an ultimate suspension to end on "nothing"; there is always some center of mass upon which gravitation must be "fastened."

We see, then, that there are two possible conclusions if the "hangeth the earth upon nothing" of Job 26:7 is taken to refer to gravity. The first is that the force of gravity is "nothing," in which case "nothing" holds the universe together (a teaching clearly contradicted by Scripture); or second, that the sun, or the galactic center, or whichever center of mass is the final one, is equated to

* Such a center of mass, which is stationary relative to two orbiting bodies, is called the *barycenter*. Geocentricity assumes that the earth is at the barycenter of all objects in the firmament.

“nothing.” The latter assumption claims that the last link in the chain of orbits is “nothing.” In effect, this makes the universe “nothing,” for its center of mass is the last link in the chain. Clearly, the claim that Job 26:7 is heliocentric when it refers to gravity is “nothing.”

How to Hang the Earth Upon Nothing

A closer look at Job 26:7 reveals that it is actually a geocentric verse. There is only one way that the earth could be hung “upon nothing” and that would be if the earth were actually located at the center of motion of the firmament. In that case there is nothing that can be pointed to as being at the other end of the “rope,” be that “rope” gravitational or otherwise. Indeed there is no “rope” in that case; the earth is purely suspended and not supported in any sense by any celestial body. At the center of motion of the universe, the dynamic center also known as the barycenter, the earth is suspended “weightless,” just as an object located at the center of mass in the earth would be weightless. One of the significant aspects of an earth suspended at the center of a rotating universe or firmament is that any force that tries either to twist or to move the earth will be resisted both by the firmament and the universe.¹ The firmament has a grip on the earth, but the grip pulls equally from all sides and thus the earth is suspended; hung from nothing. So in the final analysis, Job 26:7 is another geocentric verse and is not heliocentric at all.

Gravitation is certainly not an unscriptural idea, but it strains credulity to “prove” heliocentrism by claiming that certain biblical references to the stellar heaven refer to the actions of gravity and thus endorse Kepler’s and Newton’s laws and so discount thousands of implicitly and explicitly geocentric Bible verses. There is absolutely no scriptural support for heliocentrism whatsoever. Each allusion to the motions of heaven and earth in Scripture is geocentric.

Conclusion

We have reached the end of the section dealing with Scriptural testimony for and against geocentricity. We have documented hundreds of scriptural references that are explicitly or implicitly geocentric and geostatic. We have also examined the handful of Bible verses purported to support heliocentrism and found that support not only absent, but also that each supports geocentricity instead.

In the final analysis, the central issue in the geocentric question is the authority of Scripture: its inerrancy and its providential preservation. Either God means what he has written, or he does not. If God does not mean what he writes or writes what he means, then how can he be taken seriously? If God does not inspire literal truth when he mentions the *rising* of the sun, then how can he be taken seriously when he writes of the *rising* of the Son? Without the doctrine of geocentricity, the Gospel is wide open to the charge that it is nothing more than an allegory or fable.

How is it, then, that with all the scriptural and historic evidence attesting to the reality of geocentricity, that heliocentrism came to claim the upper hand? Is the scientific evidence for it so great that the Copernican Revolution is a done deal? The first of these two questions is answered in the next several chapters of the book. The second question is the concern of the last chapters of the book.

We now know that the difference between a heliocentric theory and a geocentric theory is one of relative motion only, and that such a difference has no physical significance.

—Sir Fred Hoyle¹

EARLY GEOCENTRIC MODELS

Before we examine the historical development of heliocentrism, we should look at the most ancient of models, the geocentric ones. Outside of Scripture, the most ancient cosmologies are said to be the flat-earth Egyptian, where the sun is said to traverse the sky along a mountain path at the edge of the earth under cover of the sky goddess, Nut. However, the models and shipping lanes of the traders who sailed the seas for barter appeared to know nothing of a flat earth. That these traders were the Hebrew's nearest neighbors should not surprise us given the round-earth model of Scripture. We shall delve no further into the Babylonian and Egyptian cosmologies because they cannot be classified as geocentric since they allow no creation beyond the earth itself.

The Elements of the Greeks

As we detailed in Chapter 6, circa 500 B.C. Greek philosophers first introduced the atomistic theory. Is it possible to divide a block of wood so far that what remains is no longer wood? Such speculations led to the discussion of elements. Just as letters of the alphabet can spell our every word in a language, are there elements that can combine to make every item in creation?

From such considerations, the Sicilian, Empedocles (492-432 B.C.), postulated the existence of four elements, spiritual essences, as it were, that make up all matter. The four are: earth, water, air, and fire. (Later a fifth element was added to the list: æther.) The basest of the four elements is earth, so it was considered to be at the center of the cosmos. Next came water, which is present in earth and in air. Air, the third element, is present in water (when it boils, for instance) and in fire. The fire was regarded as existing at the outer edge of creation.



Figure 1: *Empedocles*

Now Empedocles' model should not be dismissed as a footnote in history. His four-element model for the earth, which was endorsed by Aristotle, held sway on European thought through the Renaissance. Empedocles' model is geocentric in the sense that the basest element, earth, is regarded as located at the center of the universe. However, it was not a cosmological model because the moon was located above the sphere of fire.

The Crystalline Spheres

The second geocentric cosmology was the crystalline spheres model. It was a Greek invention that was founded on three principles. The first principle was that the circle and sphere were perfect. The second was that crystal produces the purest musical sound. The third principle was rather an assumption: that the heavenly bodies were flawless, unspotted, and perfect matter. The harmony of the spheres took it for granted that the entire universe works harmoniously together as a whole. This led to the music of

the spheres notion, namely, that the motions of the sun, moon, planets, and starry heaven produced a most divine music, the likes of which is unheard of here in earth.

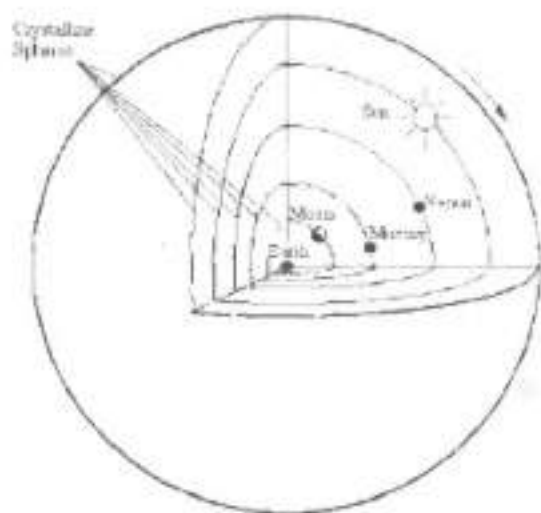

Figure 2: *The Crystalline Spheres*

In the crystalline spheres model, the universe consists of a set of eight crystalline, concentric spheres. The moon is positioned on the innermost of the seven spheres. Next comes Mercury, then Venus. The fourth shell held the sun. After it came the shells of the outer planets:

Mars, Jupiter, and Saturn. The outermost sphere, sometimes regarded as the prime mover, is the sphere that has all the stars mounted on it. Christian variants later added the third heaven beyond the stellar crystalline shell.

The crystalline sphere model was the prominent geocentric model well into the seventeenth century. When geocentricity's critics talk about geocentrism being discredited by Galileo's observations of the phases of Venus and the satellites of Jupiter, it is the crystalline spheres model, not the Ptolemaic model, which they discredit. Heliocentrists transfer that defeat to geocentricity, even though geocentricity has nothing in common either with the crystalline spheres model or with our third geocentric model, the Ptolemaic system.

The Ptolemaic Model

The Ptolemaic model, compiled by Claudius Ptolemy (90-168), a Greco-Egyptian mathematician and astronomer (Figure 4), is never pictured in the illustrations that purport to depict it. The Ptolemaic model is difficult to illustrate. It is far easier to present a cross-section of the crystalline spheres model and claim it is the Ptolemaic model. That is why real illustrations of the Ptolemaic model show only one planet (Figure 3).

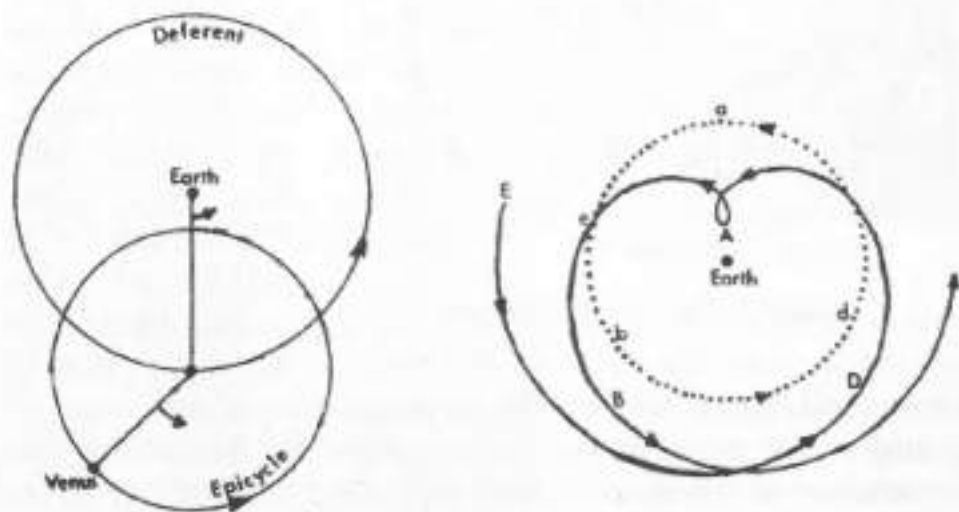

Figure 3: Epicycle

The left side of Figure 3 shows the typical diagram of the Ptolemaic model for one planet, Venus in this case. The Ptolemaic system models the motions of the planets by the use of a circle centered on the earth which circle is called the planet's *deferent*. The planet itself circles a point that slides around the circumference of the deferent. That sliding circle is called an *epicycle*. Epicycles are circles whose centers lie on the circumference of another circle.

When the two circular motions are combined, the planet follows the bold path shown in the right half of the diagram. That path is called a *cycloid*. The dotted line shows the sun's yearly path about the earth and capital and lower-case letters respectively

show the relative positions of Venus and the sun in their orbits. Note: in the Ptolemaic system the earth was not truly at the center of the deferent but was slightly offset. Ptolemy did not know the distances to the planets; had he known them, the path of the sun about the earth would be the deferent with the epicycle's radius equal to the distance between the sun and the planet, as in Figure 5.

Figure 5 shows that when we set a single deferent, which traces the yearly path of the sun about the earth, each planet's epicycle is its own orbital motion about the sun's position on the deferent. (The earth is not a planet in any geocentric system). Smaller epicycles are added to each planet's orbit to account for the fact the orbit is elliptical and perturbed by other planets. The numbers represent the distance from the sun to the planet in millions of miles.



Figure 4: *Claudius Ptolemy*
After a Medieval Woodcut

Ptolemy did not know the distances and so could not envision the true diameters of the deferent (earth-sun distance) and the epicycles. The numbers in Figure 5 are the distances from the planet to its deferent point, the sun, in millions of miles. Note that the radius of the deferent with the earth at (or near) its center is 93 million miles from the earth.

We see then that the real Ptolemaic model is not negated by Galileo's observations of the phases of Venus and the satellites of Jupiter. Each satellite would follow its own epicycle centered on its own planet.

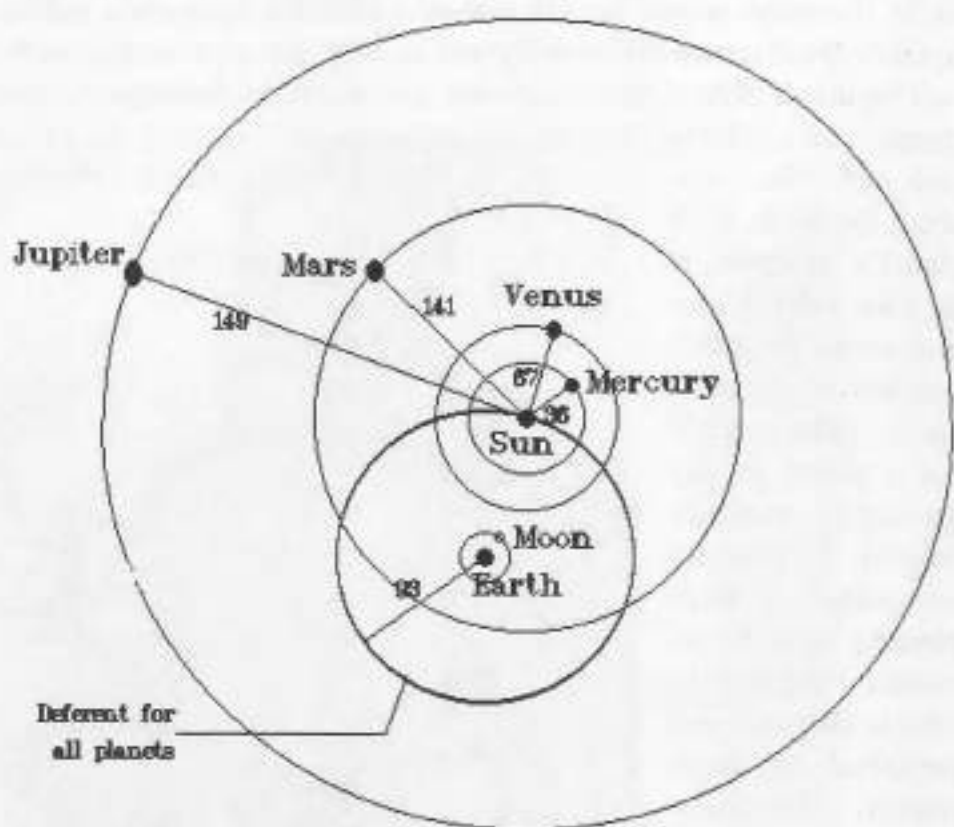
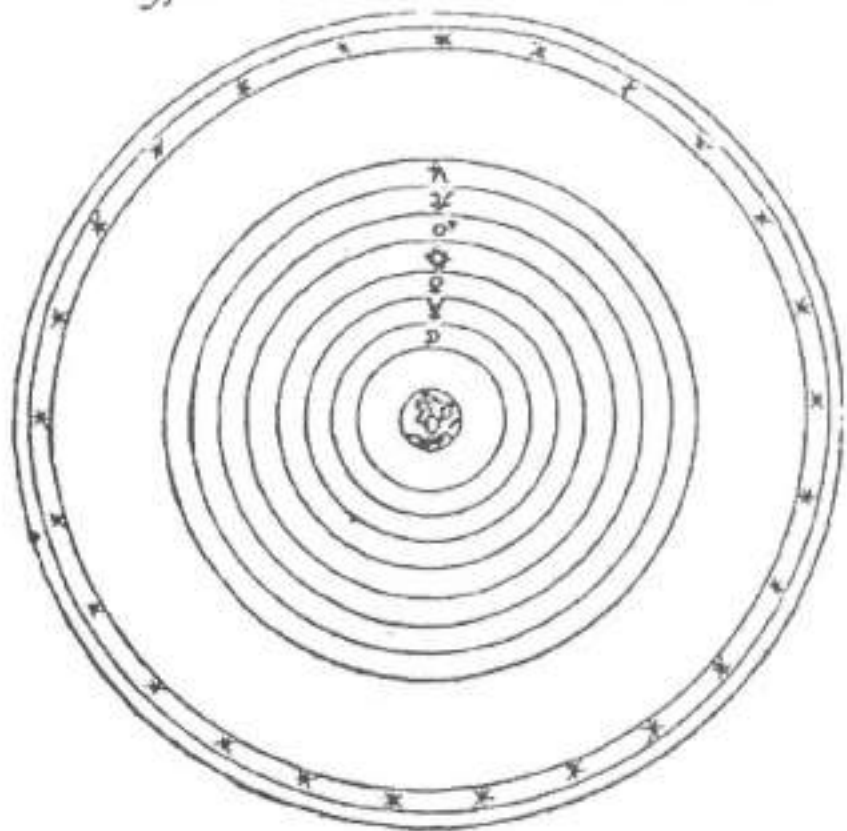

Figure 5: *The True Ptolemaic Model.*

The Medieval Hybrid Geocentric Model

Figure 6 is a typical figure that is passed off as the Ptolemaic model in texts since before the Copernican Revolution. It is about as accurate a picture of the Ptolemaic model as Figure 4 is a portrait of the real Claudius Ptolemy.

Systema Mundi iuxta Ptolemaum.*The Ptolemaic system from Morin.***Figure 6:** *Typical, but Totally Erroneous Depiction of the Ptolemaic System*

In the real Ptolemaic model, the motion of each planet is characterized by a deferent on which is superimposed an epicycle, as depicted in the left half of Figure 3. The Ptolemaic model does not consist of a series of concentric circles as depicted in Figure 6. How come, then, that text books pass off a series of concentric circles as the essence of the Ptolemaic system?

The popular depiction of the Ptolemaic system is based on a much earlier version of a geocentric model, attributed to Aristotle, which was a consolidation of the four-element model of the envi-

rons of the earth with the Crystalline Spheres model. In the course of time, geocentrism was identified with that hybrid model. That this is so is reflected in Apian's version of the Ptolemaic model (Figure 7).



Figure 7: Apian's Version of the Ptolemaic Model

Note in Figure 7 that the earth, at the center of the illustration, shows earth and water. The circle above earth shows clouds and air and the circle above that shows fire. Above the fire is the circle of the moon. Again, there is not a hint of deferent or epicycle re-

quired of the Ptolemaic model, but the figure is entirely compatible with the crystalline spheres model. As a crystalline spheres model, Apian's model has ten spheres, not ten orbits. Beyond Saturn's sphere is the starry heaven, the firmament. Beyond the firmament is the crystalline ninth heaven above which is found the Prime Mover or "First Cause" sphere. Beyond the tenth sphere there is the abode of God and his elect.

Why do authors persist in presenting the concentric-circle model as if it were the Ptolemaic model? Because that model is easy to demolish. It makes a perfect geocentric straw man: obviously nonsensical and so easy to defeat. The first man to disprove the crystalline spheres model was Tycho Brahe with his comet observations. If the crystalline spheres were real, the comet would have smashed them as it traveled past earth. Some thirty years later, with the invention of the telescope; the phases of Venus provided additional proof against the crystalline spheres model.

There was no way the crystalline spheres model could have been adjusted to allow the comet and Venus proofs against it, but that was not the case for the Ptolemaic model. Tycho Brahe used his comet observations to modify the Ptolemaic model. His modified model is called the *Tychonic System* and it is essentially the system depicted in Figure 5. The Ptolemaic model presented in the popular literature bears little relationship to the actual, computational model devised by Claudius Ptolemy because the latter, with minor adjustments, can meet all observed phenomena, something that cannot be said of the crystalline spheres model.

Conclusion

We looked at the geocentric models that were developed by the Greeks. We noted that earlier models, such as the Egyptian cosmology were not true geocentric models since their entire cosmos is restricted to the earth and its sky. The earliest known model was the system based on the elements of earth, water, air, and fire, which played a crucial part in the geocentric model embraced by

the sixteenth century clergy and scholars who were enamored on Greek philosophy and arts: *i.e.*, the Classics.

The second generation of Greek cosmic structure is the crystalline spheres. It, too, was crucial to the sixteenth century geocentric model.

The third generation of geocentric models culminated with the Ptolemaic system. Although claimed to be the authoritative model of the cosmos in the sixteenth century, it was used only as a computational device while the crystalline spheres model held sway over the imaginations of Medieval and post-Medieval men. Today, the Medieval hybrid model is a useful device to discredit modern geocentricity in the minds of those ignorant of the science, theology, history, and episteme (the guiding principle to a specific goal or purpose) of geocentricity. In other words, the hybrid model makes a perfect geocentric straw man.

What was then the cause of so greate disagreement among the Christians concerning this matter? Forsooth it was the Heathen Philosophie, with the preceptes whereof they were not only then instructed and infected, but many also of them being stuffed, beewitched and deceived therewith, (in respect that they ascribe most vnto this art) would graunt and admit nothyng whiche they suppose to bee repugnant to the principles thereof.

—Lambert Daneau¹

THE BIRTH OF HELIOCENTRISM

In the first nineteen chapters of the book, we considered the Scriptural statements which support geocentricity as a biblical doctrine. We saw that the straightforward readings of Scripture strictly support the conclusion that the Bible has a geocentric view of the universe. In the next several chapters, we consider the origin, history, and development of heliocentrism, its advocates and its critics.

Background

Back in the sixteenth century the French science writer, Lambert Daneau, lamented the increasing influence of Greek, Egyptian, and Babylonian philosophers on Western thought (see chapter quote). The Reformation's emphasis on the Holy Scripture had demonstrated the absolute bankruptcy of these ancient philosophies when compared to the righteousness and grace of the Holy Bible. Daneau's lament is an old one, reminding us of the third century of New Testament Christianity when the Alexandrian heretic, Origen,

attempted to elevate Egyptian, Babylonian, and Greek philosophies to the same inspirational level as Scripture. Origen's heresy has always found support among prideful, educated men, who consider themselves the measure of all things. *Humanists*, as these men are called, were those against whom Daneau's lament was directed; and for a century-and-a-half after the start of the Reformation, humanists waged unsuccessful war against the Holy Bible for control of the minds of the masses. But today, unfortunately, the authority of the Holy Bible is almost nonexistent even among those who call themselves Bible believers. The defeat of the Bible's authority in the realm of science played a large role in the defeat of the Bible's authority in all other matters of faith and practice; and the beginning of that defeat, the first victory of the humanists, was the defeat of what seemed like a minor doctrine of Scripture, the doctrine of geocentricity.

The influence of pagan philosophers persists to this day. Only the names of the most influential ones have changed. In Daneau's day the final scholastic authority was Aristotle (384-322 B.C., Figure 2); today it is Plato (429-347 B.C.). Although Daneau's quote refers to the various sixteenth century superstitions against the Biblical creation account, his words equally apply to the doctrine of geocentricity or every other conflict between science falsely so called and the Bible.

In this chapter, we outline the origin of astrology and the worship of the sun, moon, and stars—the host of heaven. We shall trace its Babylonian origins through Egypt and thence to Greece where it pervaded the very philosophers who motivated Origen and disturbed Lambert Daneau. Along the way we shall examine the prophet Daniel's influence on these matters and trace them through Roman times.

Pagan Origins

The first recorded heliocentrists were pagans who were aware of the Hebrew scriptures but held them in mediocre esteem. There

is evidence that some of the Greek philosophers, such as Pythagoras (570–490 B.C.), knew of the Hebrew writings, but they deemed these to be merely one nation's opinion and so synthesized their own views accordingly. However, the Greeks were eclectic enough to incorporate the Hebrew scriptures insofar as those conformed to their worldview. The oldest surviving written accounts of heliocentrism are all Greek. By itself, this does not necessarily mean that the Greeks originated heliocentrism; for the germ of heliocentrism can be traced back to ancient Babylon, where it is implicit in their worship of the sun. It thus behooves us to examine heliocentrism's earliest pagan roots.

Babylonian Origins

Babylon was a city-state founded not long after Noah's flood. The Holy Bible records that Babylon already existed when Nimrod started his reign about 154 years after the Flood,^{*} for it reports of him that "the beginning of his kingdom was Babel..." (Genesis 10:10). Nimrod (known to the Greeks as Ninus, which is also the name for Nineveh) and his wife, Semiramis, are infamous among the ancient historians for originating of all sorts of debauchery and idolatry; most notably the worship of the host of heaven. Ancient Jewish historians recorded that Nimrod even went so far as to claim that the constellation of Orion (Figure 1) was a divine reference to himself.[†] The same early historians also credit Nimrod and Semiramis with instituting the worship of the moon and sun.

* Ctesias of Cnidus a late fifth century B.C. Persian, physician, and historian wrote a history based on ancient Persian records that date the start of Nimrod's reign in 2182 B.C. That date falls 154 years after the end of the Flood. If 154 years seems too short for enough population to arise, mathematician James N. Hanson has shown that within the first 150 years after the flood, the world's population could exceed forty million people (Hanson, J. N., 1977. "An Analysis of the Post-Flood Population Growth," *Creation Research Society Quarterly*, 14(1):62-69, Table 1.

† Nimrod's usurpation of the constellation confirms that at least some of the constellations were both ancient and served as pictograms illustrating a divine

Beginnings of Astrology

Associated with the Babylonian worship of the host of heaven is the belief that said host—namely the sun, moon, planets, and stars—directly influence and control human affairs. Today this belief is commonly called *astrology*. By the time that Nebuchadnezzar came to power, about the seventh century B.C., Babylon had developed its worship of the host of heaven to an astrological “science.”

Babylonian royalty alone was allowed to have its astrological charts drawn. This special privilege allowed the astrologer-priests to control the kingdom of Babylon, for thus they controlled the heads of state. Now astrology required some observation of the sky and an analysis of the motions of the stars and planets; that is, an on-going *astronomy*. The Babylonian priests (and their Egyptian counterparts) were responsible for keeping track of the motions of the planets, sun, moon, and stars, ostensibly to produce astrological charts. Despite their development of astrology as adjunct to their worship of the host of heaven, the Babylonians did not achieve the pinnacle of astrology. That distinction had to await the rise of Rome.

Like all the world’s beliefs, astrology is based on one or more foundational principles. For astrology, the episteme (as such a

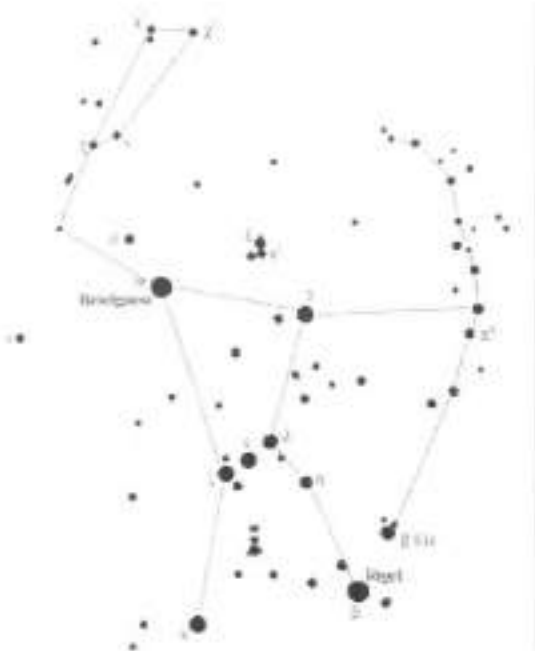

Figure 1: Orion with Club and Shield

prophecy; supporting the contentions of gospel in the stars advocates both ancient and modern. Because of Nimrod’s audacity, the Hebrews call the constellation, *Kesil*, meaning “big fool.”

foundational principle is called) is the *principle of correspondences*. The principle of correspondences can be summarized by the expression "as above, so below." In other words, the principle of correspondences amounts to the belief that the heavens dictate events here on earth. The anti-scriptural nature of this belief is obvious from our analysis of the ordinances of heaven in Chapter 17. In that chapter we saw that Scripture teaches that earth has dominion over the heaven—the opposite of what astrology teaches, which is that heaven has dominion over the earth.

Despite the fact that modern science prides itself on long ago having abandoned the principle of correspondences, we find that the principle has not been abandoned so much as it has been synthesized. Instead of the episteme, "as above, so below," science now believes "as below, so above." On the surface this sounds like the Scriptural view of the dominion of the ordinances of heaven. But the modern episteme of science, "as below, so above," is not the same as the scriptural view that ordinances of heaven are set in the earth.

The modern scientific view incorporates both today's astronomical episteme and astrology's ancient episteme. The "as below, so above" episteme comes into play when scientific principles are discovered and studied here on earth. These terrestrial "laws" of physical science are then assumed to apply to the universe, too. Likewise, when new "laws" are discovered in the universe (such as the expansion of the universe) then the results of those celestial laws are also applied to the earth. That way, both astronomy's and astrology's epistememes are in force.

Over the past 200 years, another overarching episteme of modern science is to banish God from the ordinances of physics, thus rendering God irrelevant at best and an annoyance at worst. This is precisely how God is perceived by many of today's scientists. In the western nations' educational system, God is considered irrelevant. In the eastern lands, God is viewed as a nuisance, and, judging from the ferocity of the oppression of Christians around the world, a much feared nuisance at that. Modern science

wants to dismiss God as a myth; yet it fears him. Science is thus, in a real sense, schizophrenic; one could even say, insane.

With its foundation in the worship of the host of heaven, it was astrology that nurtured the seed of heliocentrism for many centuries. In a world where all the evidence of the senses—the turning of the sky, the yearly path of the sun about the earth, the phases and motion of the moon—dictated geocentricity, astrology contained in it the potential for negating the reason of senses by reordering the importance and significance of the celestial bodies; for if the astrologers were to keep their control over the rulers and peoples of this world, they must make those rulers believe that the earth is insignificant when compared in any way with the host of heaven. That is why, in places like Bet Shean, Sepphoris, and Tiberias in Israel, where archaeologists have found Hellenistic Jewish synagogues with mosaic floors of astrological motif, those floors all depict the sun, in the form of the Greek god Apollo, in the very midst of the twelve signs of the zodiac (see Figure 12.2). The earth is nowhere represented at the center of any zodiacally-tiled floor.

Daniel

Nebuchadnezzar (c634-562 B.C.) is well known as the king of Babylon who destroyed the kingdom of Judah. At that time some of the children of Jerusalem were taken to Babylon. Among them was Daniel.

Daniel's position in the Babylonian Empire was second only to the king. Daniel was skillful in all understanding and cunning in knowledge, understanding science, languages, and the learning of the Chaldeans (the educated and priestly class). It is no overstatement to say that in his day, Daniel was the wisest man in the Middle East, if not the entire world.

After the death of Nebuchadnezzar, Daniel's influence decreased; so by the time that Nabonidus ruled the kingdom, Daniel was forgotten. The excesses of Nabonidus left him hated by both the priesthood and the general population. As a result, Nabonidus

was forced into self-imposed exile while leaving his drunkard son, Belshazzar in Babylon as co-regent in charge of the empire's officials and the Babylonian Army.

Before long, the monarchy decayed into a kleptocracy. Belshazzar's rule became so corrupt that no pretense of honesty or the traditional values remained. Religious morals were despised, the local economies failed, and the ruling class imposed massive tax burdens on both rich and poor—the surest sign of corrupt governments.

Eventually Belshazzar saw the handwriting on the wall (Daniel 5:5 v.f.) and Daniel's skill in languages and his wisdom was remembered. Thus Daniel became the second in the kingdom under Belshazzar, who died that same night.

The absolute abhorrence for the monarchy disaffected many parties within Babylon. Among those who sought relief in Cyrus II was Gobryas, the governor of the province of Gutium. Gobryas allied his army with that of Cyrus and on the night of October 16, 539 B.C., while Belshazzar puzzled over the handwriting on the wall, Cyrus' army began the invasion of the city of Babylon.

Now Babylon was a 3136 square-mile city, surrounded by a wall 87 feet thick and 300 feet high. Rather than tackle the moat and wall, Cyrus and his army used the canal system that brought water to the city from the Euphrates River. Cyrus completely subdued Babylon. Not a single warning was given and no alarm sounded. Except for the execution of Belshazzar, not one drop of blood was spilt by either side.

Cyrus put Darius in charge of Babylon and Darius put Daniel second in the kingdom. Thus Daniel's influence extended into the empire of the Medes and Persians.

Medo-Persian Influence

After the demise of the Chaldeans (the Babylonian priesthood) their science passed on to the Persians. The Persians were so impressed by the Medes (modern Kurds), who lived to their west, that

they merged with them to form the Medo-Persian Empire. After the demise of Babylon, there arose a new religion. Founded by Zoroaster (also called Zarathustra), Zoroastrianism is a form of fire worship and persists to this day.

As far as we know today, it was certain Greek philosophers who first postulated that the earth was not at rest at the center of the universe; and the first of the Greeks on record as doing so, did so shortly after being exposed to the Babylonian and Egyptian teachings about the time of Daniel and after with the ascent of Zoroastrianism.

Overview of Greek Influence

If there is one overriding attribute that has characterized the Classical Greeks throughout their history, it is their quest for wisdom. Even today the search for wisdom is viewed as the true manifestation of wisdom; and this superstition led to the great revivals of Greek classicism in Renaissance and post-Renaissance Europe. Sad to say, the search for wisdom only indicates the absence of wisdom, for one does not seek what one already has. So there can be no grain of truth or wisdom found in the Greek classics except it came there by accident. As we shall see when looking at Kepler (Chapter 22), we are ultimately forced to conclude that Greek classicism will only lead one to the foolish, bitter purposelessness of existentialism.

The way to modern heliocentrism had its origins with the Pythagoreans. Now Pythagoras (570-490 B.C.) was a Greek philosopher who undertook the then-fashionable pilgrimage to Egypt and returned by way of Babylon to study. Pythagoras was impressed by the mathematical and geometrical mysticism of the priests of those nations. In fact, he was so impressed that upon returning to his homeland, he founded his own school on the island of Sicily.

The Lake of Fire

As far as is known, the first to conjecture that the earth was not fixed immobile at the center of the universe was Philolaus (470-385 B.C.), a student and later an instructor at Pythagoras' school. Philolaus was born a hundred years after Pythagoras and was a contemporary of Plato (429-347 B.C.). Philolaus' theory was not truly heliocentric, however, for he did not place the sun at the center of the universe; nevertheless, Philolaus' theory is the first recorded that displaced the earth from the center of the universe and so it is the spiritual ancestor of modern heliocentrism.

Philolaus believed that the earth was too base a place to hold any central position in the universe. Instead, he reserved that central position for the eternal lake of fire that was limited by the center of the cosmic sphere. In his model, the sun, moon, earth, planets and stars each circled the central lake of fire in circular orbits, which were inclined to one another. To Philolaus the sun was a giant mirror reflecting the light and heat from the central lake of fire. The reason why the lake of fire itself could not be seen, Philolaus conjectured, was that the known world constantly faced away from it, just as the moon always keeps the same face to the earth. So the lake of fire could only be seen from the antipodes of the earth, as measured from Greece.

From a Christian perspective, the mention of a lake of fire is particularly intriguing because such a lake of fire is mentioned in chapters 19 and 20 of the Revelation. This has caused some Bible critics to speculate that the Apostle John borrowed the lake of fire from Philolaus; still others wonder if the ancient Hebrews and Babylonians knew of the lake of fire or if this is just a coincidence.

The Old Testament makes no direct reference to the lake of fire of the Revelation; but that does not necessarily mean that the lake of fire was unknown to the Hebrews of that time. In fact, the lake of fire is alluded to several times in the Old Testament. Psalm 140:10 is one example:

Let burning coals fall upon them: let them be cast into the fire; into deep pits, that they rise not up again.

A second indirect example is found in Proverbs 30:16, which speaks of "the fire that saith not, It is enough."

For a direct mention of the lake of fire in the Old Testament we turn to Isaiah 66:24 where men:

[S]hall go forth, and look upon the carcasses of the men that have transgressed against [God]: for their worm shall not die, neither shall their fire be quenched; and they shall be an abhorring unto all flesh.

These references all speak of the fiery fate that awaits the wicked; and these verses are reminiscent of the lake of fire and provide support for the premise that such a concept was not foreign to the Israelites, even at the time of Daniel.

Yet even had the lake of fire been unknown to the Hebrews of that day, we may yet be able to trace whence Philolaus derived his notion of a lake of fire. Now Pythagoras, the founder of the school where Philolaus studied and taught, was the talented, well-educated son of Mnesarchus, a gem dealer. Pythagoras left his native Samos, Greece for Egypt to study under the Egyptian priests. While there, the Persians invaded Egypt; Pythagoras was captured and sold to Babylon. In Babylon he met the magi who became his teacher. At the time, Daniel was 65 and it seems entirely likely, given the magi's response to the birth of Jesus the Christ that Pythagoras would have been privy to Daniel's visions that were recorded in the book of Daniel.

There arises, then, the possibility that Daniel was the source of the knowledge of the lake of fire which Philolaus postulated to be at the center of the universe. Although the book of Daniel does not explicitly mention the lake of fire, we are told there that Daniel's vision of the end times included the last judgment as well as the es-

tablishment of the new heaven and earth (Daniel 7:13-14). In between these two events, hell, death, and all those whose names shall not be found in the book of life will all be thrown into the lake of fire (Revelation 20:14-15). So it is reasonable to suppose that Daniel saw the lake of fire, and there is no reason to conclude that just because he was not led to mention it in the book of Daniel, he might not have mentioned that terrible fate to his colleagues. Pythagoras would have carried the vision back to Greece and mentioned it to his students who taught it to Philolaus.

The Philolaic system, although not a heliocentric one, is not a geocentric one either. Nevertheless, the Philolaic system survived until the end of the seventeenth century before it became a footnote in history. There is certainly no evidence that the Philolaic model gained any great acceptance among the Pythagoreans. Yet it is a significant development, for not only was it the first time someone had seriously proposed that the earth might not be at rest in the center of the universe, but it also reflected a growing preoccupation among the Pythagoreans with fire and light as symbols of purity and truth: a preoccupation which became central in the sixteenth century arguments for heliocentrism.

The Platonic Influence

There is no evidence whether Plato shared Philolaus' ideas about the lake of fire; but in Plato we do find the influence of the Cabala, the mystical doctrines of the Rabbis often based on esoteric interpretations of Scripture. We also find in Plato a form of sun worship. In Plato's *Republic* there is a dialog which promotes the idea of the sun playing the same role in illuminating the physical realm as the "good idea" or "form" plays in illuminating the realm of ideas; to wit:

"[W]hich of the gods in heaven can you put down as the cause and master of this, whose light makes our sight see so beautifully and the things to be seen?"

"The same as you do," said he, "and everyone else; it is plain that you mean the sun!"

"Shall I suggest how sight is related to divinity?"

"Well, how?"

"Sight itself is not the sun, nor is that in which it is, which we call the eye."

"It is not."

"But sight is the most sun-like, I think, of the organs of sense."

"Much the most."

"Moreover, the power which it has is always being dispensed by the sun like an inundation, and sight possessed it?"

"That is quite correct," he said.

"Surely, now," I said, "my meaning must appear to be that this, the offspring of the good which the good beget, is in relation to the good itself an analogy, and that the good effects, by its influence, in the region of the mind, towards mind and things thought, this the sun effects, in the region of seeing, towards sight and things seen."

Even though there is no evidence that Plato was a heliocentrist, we do find the above dialogue in the *Republic* presented as proof for the sixteenth century's concept of heliocentrism. We shall return to that subject when we look at the Copernicus' rationale in the next chapter.

Aristarchus of Samos

Although Plato viewed experimentation and physical evidence with contempt, not all early Greek philosophers shared his point of view. One of those was Aristarchus of Samos (c.310-230 B.C.). In those days, the chief objection against heliocentrism was that raised by Aristotle (384-322 B.C., Figure 2) namely, that the sun, stars, and planets did not have a detectable parallax. (Parallax is the effect that foreground objects appear to move against a more distant background when an observer shifts position (Figure 3).

Aristarchus of Samos did devise a clever way of detecting the parallax of the sun. To perform his observation he had to make very careful and accurate measurements of the phases of the moon (Figure 4). He did obtain a result for the solar parallax from his observations, although today it is recognized that his results were more accidental than true.

With his spurious result in hand, Aristarchus argued that he had removed Aristotle's main objection against heliocentrism; and so it

was Aristarchus of Samos who became the first recorded heliocentrist, for he suggested not only that the earth orbits the sun, but also that in addition the earth spins on its axis once a day. Aristarchus of Samos made his proposal in 261 B.C., about 200 years after Philolaus' non-geocentric model.

Despite Aristarchus' observational "proof" of heliocentrism—and he did view it as a proof—the idea did not catch on. Probably this was so because his contemporaries and successors were more intelligent than Aristarchus for they knew that his was not a proof at all, but that the same result would be obtained in the geocentric case, too; for whether one assumes a geocentric model or a heliocentric one, the sun will show parallax either way.

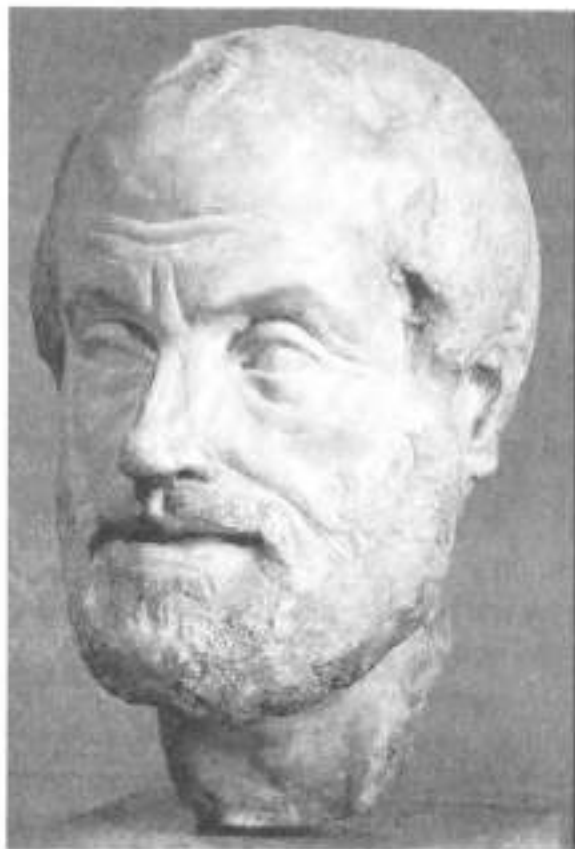

Figure 2: Aristotle

Heraclides of Pontus

Some historians of science are of the opinion that Heraclides (Hercules) of Pontus (388-310 B.C.) antedated Aristarchus as the first to believe that the earth rotates on an axis; but Heraclides was a very vain man and an unscrupulous student of Speusippus (407-339 B.C.), Plato, and Aristotle. Most of the works attributed to him may actually be due to others who were also named Heraclides. There is thus reason to doubt the speculation that Heraclides of Pontus was the first man on record to advocate that the earth rotates. As a result, Aristarchus gets credit for that first also.

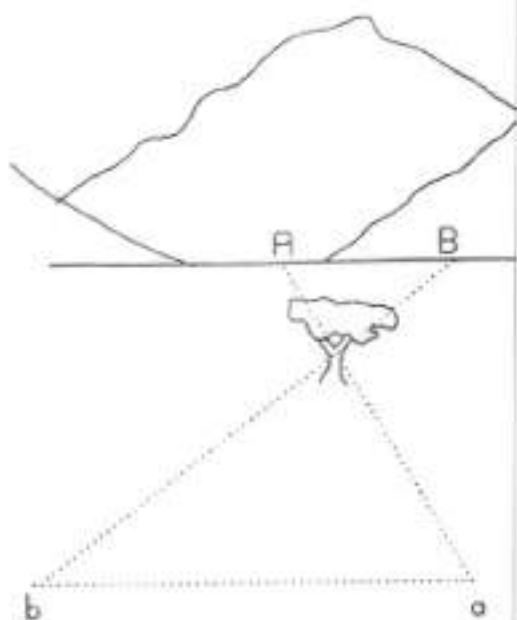

Figure 3: Parallax. At point *a*, the foreground tree appears against the distant mountains at point *A*. Moving to point *b* causes the tree to appear against the background at point *B*. Half the angle from *a* to tree to *b* is called the *parallax*.

Hipparchus

After Aristarchus, around about 130 B.C., the Greek astronomer Hipparchus (c. 170-c. 120 B.C.) reviewed the evidence for and against geocentrism and concluded that the earth is stationary, that it is spherical in shape, and that the sun, moon, stars, and planets all circle the earth with the planets also moving in smaller circles called *epicycles* (circles which are centered on a point which point is on the perimeter of another circle). His model was later perfected by the Greek astronomer, Ptolemy (A.D. 90-168), who in

about A.D. 150 developed the model which is still called the *Ptolemaic system* (Figure 19.5).

After Hipparchus the Roman Empire arose and introduced its own ideas and constraints on the heliocentric hypothesis. Those ideas would further wed heliocentrism to the subtle form of sun worship that was inherent in Plato, but the precedence for heliocentrism had been set; and that precedence was to play a crucial role with Copernicus in his arguments for heliocentrism.

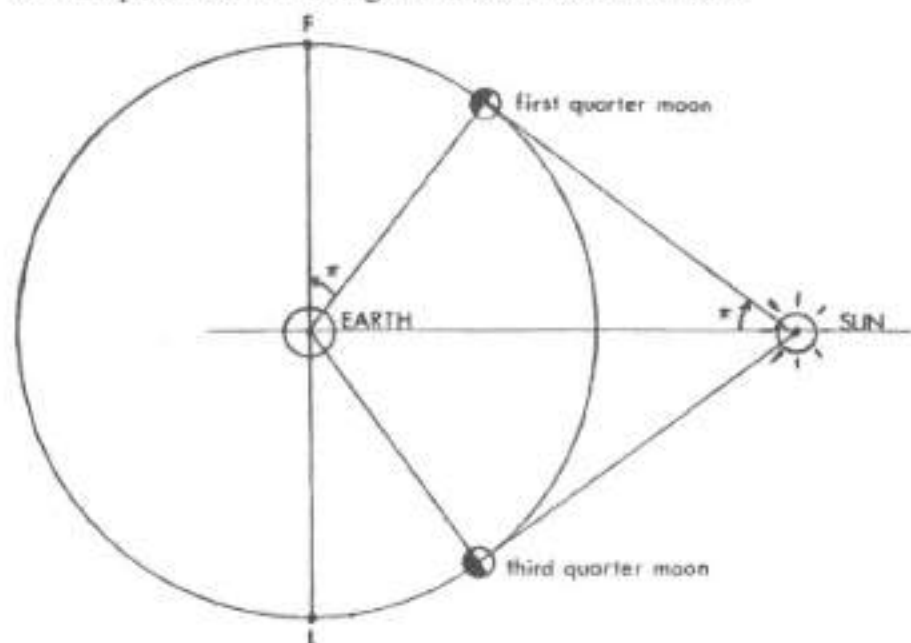

Figure 4: *The Sun's Parallax Determined from Lunar Phases.* If the sun were infinitely distant, then the first and last quarters would occur at points *F* and *L* respectively and should occur one quarter and three quarters respectively through the lunar month. By exactly timing the occurrence of first and last quarters, the angles π can be determined. This angle is the parallax of the sun.

The Roman Influence

The Greek Empire fell to the Romans about 150 B.C. One of the characteristics of the Romans was their unquestioning acceptance of all the gods of all the peoples of the world. Although the Medo-Persians had promoted the ideas of ecumenism and national-

ism, it was the Romans who put them into practice. So it is not surprising that the Romans quickly assimilated the Greek pantheon as their own. Added to that, the Romans worshipped and prayed to the household of the dead, their departed "saints," and to times and seasons.

The Roman synthesis of religions came to a head in Caesar Augustus around 31 B.C. For centuries before then, Rome had had a council of priests which had the charge of Rome's religious activities. A member of that council was called a *pontifex*, which means "bridge maker." The pontiffs considered themselves intermediaries between God and man. In 31 B.C. Caesar Augustus became the first emperor to declare himself head of the council of priests, the *Pontifex Maximus*. With that he set the stage for what was soon to become the practice of emperor worship. As Pontifex Maximus all religions had to be subject to the leadership of the emperor; and since neither Judaism nor Christianity allows the worship of a man, both those religions were strongly persecuted by Rome. Later the emperor was promoted to the chief god of the world.

Eventually Rome's Pontifex Maximus' claim to be the supreme god in both the secular and spiritual realms led to a set of dualistic theories, most of which persist to this day. For example, to this day it is said that God wrote two books, the *Book of Nature* and the *Holy Bible*. Such is called the "double revelation theory." The double revelation theory is held by all who wish a "scientific" theory to overrule the literal sense of Scripture, such as the six days of creation in Genesis chapter one. Support for the double revelation theory is drawn from Augustine's notion that "the Bible is not a textbook on science." Promoters of these beliefs only invoke them in those cases where they deem it desirable for their "science" to overrule the literal sense of scripture. These double-minded (James 1:8), double-revelation perspectives were Roman contributions, founded on and extrapolated from the theories of the Greeks and Medo-Persians, and directed into the dualism embodied in the Pontifex Maximus.

There is one other contribution which the Roman Empire introduced into heliocentrism and that was the addition of the title *Sol Invictus* (the Invincible Sun) upon the Pontifex Maximus. From Caesar Augustus on, the two titles went hand-in-hand.

Conclusion

We discovered that heliocentrism arose from fire worship; inspired by the Greek theory of elements and its association between fire and æther, which Greece regarded as the heavenly substance. The Greeks synthesized their natural philosophy by drawing from Egyptian, Babylonian, Medo-Persian, and Hebrew cosmologies. Yet despite the rhetoric of Aristarchus, Greek philosophy did not embrace the heliocentrism.

Rome inherited the Babylonian, Medo-Persian, and Greek cultures as had been envisioned by Nebuchadnezzar and recorded in the second chapter of Daniel. Rome's contributions provided a rationale which not only allowed Copernicus to formulate heliocentrism but even encouraged him to do so. Just how that happened is related in the next chapter. Ultimately Rome's contribution, particularly the double revelation theory, led to heliocentrism's acceptance as "fact" in the complete absence of any evidence in support. With all revelation and wisdom defined by and emanating from the self-serving Pontifex Maximus, it is no wonder that the Roman Empire's legacy to the western world was a thousand years of ignorance called the Dark Ages.

The founders of modern science and philosophy were anything but skeptics. They were, instead, committed spokesmen of the new truths clearly proclaimed in the *Book of Nature*, which they supposed revealed secrets to all who earnestly applied themselves in good faith and deciphered the signs so lavishly made available by the Author of Nature. Nature's Book, in their view, was written in numbers and never lied, whereas the Testaments were written in words which were easy and tempting to misconstrue. Men like Galileo and Descartes were vastly more certain about the truth revealed to them by number than they were by the interpretations placed upon Scriptures and the commentaries of theologians.

—Benjamin Nelson¹

21

THE REFORMATION AND HELIOCENTRISM

A casual student of history might reach one of two conclusions about the Reformation: the first is that true Christianity had been lost for over a millennium and that the Reformation was a time when men rediscovered the true faith; the second is that Romanism is the true faith and that the Protestants are late heretics which have departed from the Roman faith. Neither is the case. True, the Reformation was a limited return to biblical authority on the part of some in the church of Rome, but the Reformation was more than a new discovery or religious movement. It was also a humanist movement.

Setting the Stage

The invention of the printing press in the fifteenth century placed the printed word in the hand of upper-middle-class man

such as merchants. It was the resulting increased literacy, more than any other single factor, that the Spirit of God used to bring about the success of the Reformation. The Bible was about to reach the common man in his native tongue via the printed page. Throughout the prior centuries, the true Scripture had been kept and preserved by an omnipresent minority which had borne various labels. For centuries, these groups had sent forth their missionaries to preach the gospel of salvation by grace alone; but the history books, written and kept by their enemies, simply never mentioned the Bible believers' successes and only occasionally recorded their "heretical" activities.

Now humanism* has been a strong faction in the Roman Catholic Church since at least the early thirteenth century, if not since its inception under Constantine. Technically, a *humanist* is anyone who disavows the deity of our Lord Jesus Christ, maintaining only the Lord's humanity. Today the term, humanism, has lost that clear definition, but in the Middle Ages the original concept of humanism was still intact. Humanists were attracted to the Church of Rome because all Roman Catholic countries are sacral societies. A sacral society is one in which there is no separation between society, church and state. When the state and society are one and the same, it is the state's view that the state itself is "the people" (e.g., Marxism, which is a form of Satanism),² so that those who disagree with the state are, by definition, not "people." Thus, in order for non-religious people to obtain a voice, wealth, or power in a Catholic sacral society, it is necessary to become involved in the power structure of the National Church—to become one of the

* By humanism is meant the cultural and intellectual movement of the Renaissance that emphasized secular concerns as a result of the rediscovery and study of the literature, art, philosophies, sciences and civilization of ancient Greece and Rome. Within humanism there was a Classical movement whose goal was to conform all arts, sciences, and philosophies to ancient Greek and Roman models and standards. Thus it is often reported that humanism is a backwards-looking movement, that is, a movement that always looks back at the "good old days." (Contrast Ecclesiastes 7:10.)

“people.” And so the humanists were embedded in Catholicism and existed in a strained love/hate relationship with that church.

There were two groups of humanists in Roman Catholicism during the Middle Ages: one group worshipped the Queen of Heaven while the other wanted to eliminate all remembrance of church and deities altogether. Just before the Reformation began the two factions were highly polarized, even though Aquinas' works were an attempt at placating them. But the ideas of Aquinas could only carry humanism so far and no farther. As soon as the Reformation happened, and as soon as it became evident that the Roman Catholic Church was too weak to assassinate Luther, the dissident humanists seized their opportunity and declared their independence from the “mother church” by latching onto the coat-tails of the Reformers. They went so far as to ask the Reformers, such as Martin Luther, to support their violent political revolutions. Luther never did honor any of the humanists' requests for support of their “reform” movements, although some other Reformers, most notably Melanchthon and Calvin, were not as wise as Luther in their dealings with the humanists.

The bloody turmoil and political revolts fomented by the humanists throughout northern and central Europe during the Reformation provided the backdrop for the acceptance of heliocentrism. In order to completely break from Catholicism, the humanists had to take over those roles which had traditionally been under the control of Rome. In particular this included science and theology. Heliocentrism became the cutting edge in that power struggle. As we noted in the previous chapter, heliocentrism entered through astrology, for there was virtually no astronomy anywhere throughout the Dark Ages except it were related to astrological activities and, somewhat incidentally, to navigation.

Early Copernicus

Despite the Bible's opposition to the practice of astrology, the art was still commonly practiced during the Reformation and well

into the seventeenth century. In order to draw up an accurate astrological chart, the astrologer needs accurate tables for the motion of the sun, moon and planets. This, in turn, means that elaborate calculations had to be performed in drawing up the tables to be used in making astrological charts. Furthermore, with the discovery of the New World, navigation by the sun, moon, planets, and stars created a new emphasis on accurate computation of astronomical positions. The more skillful mathematicians of the time were kept quite busy in these calculations but some mathematicians, like Canon Nicholas Copernicus (1473-1543) had the time and inclination to wonder about the nature of the motions of the sun and planets. Of the three figures historically held to be responsible for the advent of heliocentrism: Copernicus, Kepler, and Galileo; the first two were principally employed as astrologers for most of their lives.

In the time of political and religious turmoil accompanying the Reformation, the humanist Copernicus:

...not only became the towering figure in the history of science, but the man who accidentally and unconsciously imposed the one central concept of modern history: the idea of revolution.³

Nicholas Copernicus was born the son of a banker-merchant. He was educated in the classics at Bologna where he studied under the Platonist Maria de Novarra (1454-1504) and under the liberal humanist theologian Codrus. Codrus is remembered most for uttering such modern-sounding proclamations as: "the hereafter is nothing more than an old wives' tale."⁴ Despite this secular background, it is still widely reported that Copernicus was a very pious and religious student; but that report is belied by the first book he ever published, for in 1509 he published a translation of the bawdy letters of the Byzantine poet, Simoncatta.

Later in life, Copernicus became the secretary and chancellor of the Chapter of Warmia. From that post he succeeded to Canon

of Frauenburg. Through such ecclesiastical positions he became quite conversant with both Roman Catholic and Protestant doctrines. Given such a background, there is no doubt that Copernicus was well aware that the notion of heliocentrism was both a church and a biblical heresy.⁵ Nevertheless, by 1512 he had formulated his doctrine of heliocentrism, although he dared not publish it for fear of the Inquisition.

The Copernican Model

The heliocentric model that we now call the *Copernican model* was not original with Copernicus. In the prior century Nicholas of Cusa (1401-1464), Georg Peurbach (1423-1461) and his student Johannes Regiomontanus (1436-1476) had openly promoted it. Copernicus was well aware of their work. Yet we find Copernicus writing that when the heliocentric idea first occurred to him, he recoiled from it because he knew it to be heretical.

In time, Copernicus became progressively more enamored with the heliocentric system and devised a set of intellectual objections to the ancient geocentric model. Copernicus reasoned that God would not construct a universe in such an “unworthy” way as a geocentric one. He estimated, for example, that it would take 10,000 circles (deferents and epicycles) to make the motion of the sun, moon, planets, and stars.* Certainly, Copernicus argued, this is too large a number—too complicated—to be worthy of the Creator.

Now when writing about the Copernican Revolution, modern popularizers of astronomy are quick to tell us that the Ptolemaic model was unwieldy, requiring hundreds or even thousands of “circles” or epicycles and epicyclets. That is not true and even Copernicus realized that.⁶ Thirty-four was the number of “circles” that Copernicus’ model had a year before his model was introduced

* Bear in mind, the 10,000 number includes the roughly 5,000 stars visible to the naked eye.

in his *Commentariolus*, and he realized that the Ptolemaic model had fewer epicycles than did his heliocentric model.*

Today's orbital computations still use the circles Copernicus referred to (in both geocentric and heliocentric computations) but they are no longer called "deferents," "epicycles," and "epicycles"; instead, they are now given the more imposing title of "Fourier series terms." In modern astronomy Venus has the most terms of all the planets, numbering over 250 epicycles.

When it came to consideration of the universe, Copernicus, in his introduction, assumed God is not willing (or able) to keep track of such a complicated system of motions. We see, then, that Copernicus took it for granted that he alone knew which model of the universe was worthy of God and which model was unworthy of God. Undergirding Copernicus' extra-biblical standard was his Platonic training, for Copernicus used the Greek classical view as the standard whereby man should decide what is true and what is false in both nature and Scripture.

Appealing to the Greeks

Armed with the classical humanistic reasoning about the divine unworthiness of the geocentric model, Copernicus' next step was to search the Greek and Roman classics for any precedence of his heliocentric concept. He knew that it would help his heliocentric cause immensely if he could find support for his position in the ancient Greek writings. After all, Origen, Augustine, and Aquinas all

* The number 34 comes from Copernicus himself. Harvard professor and astrophysicist Owen Gingerich wrote: "...the entire calculational procedure for the *Alfonsine Tables* [tables predicting the position of planets using the Ptolemaic model] depends on a clever approximation invented by Ptolemy to handle a single epicycle on an eccentric circle. ...Copernicus must have realized that with his small epicycles he actually had more circles than the Ptolemaic computational scheme used in the *Alfonsine Tables* or for the Stoeffler ephemerides."⁶ (Emphasis added.)

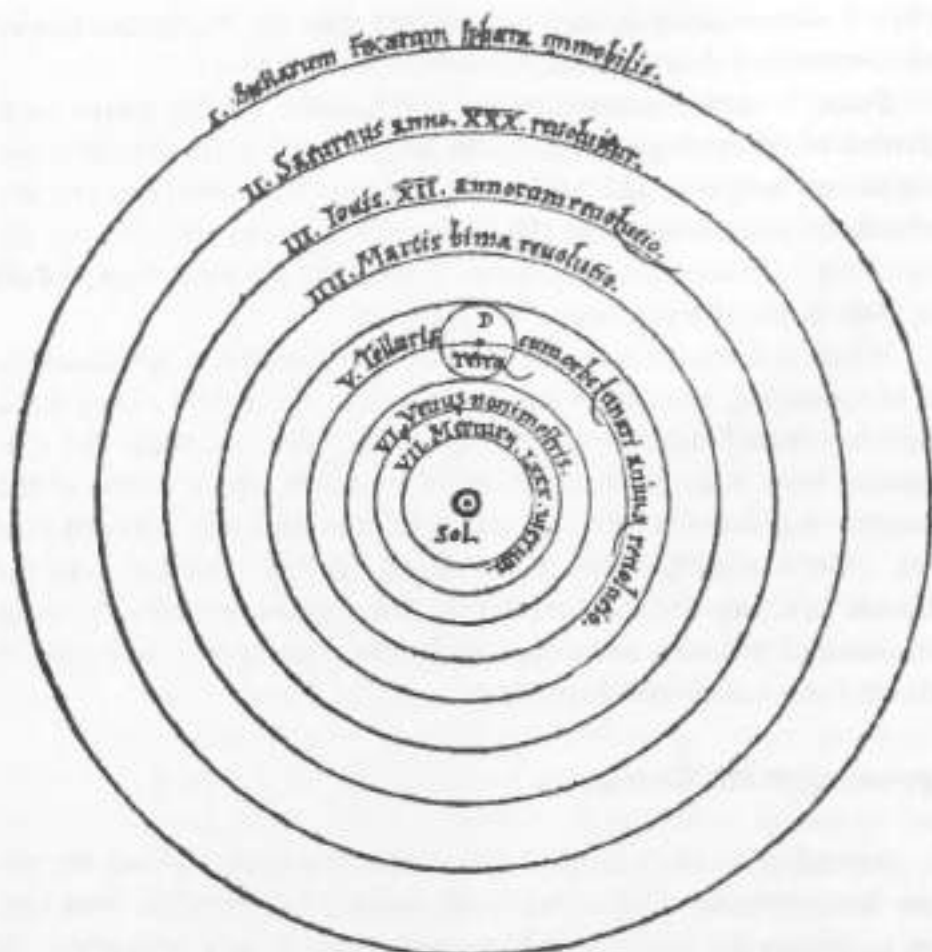

Figure 1: *The Copernican Model as depicted by Copernicus himself in his 1543 edition of De Revolutionibus.*

argued that the Bible is not a textbook on science and therefore could be fallible when speaking on scientific matters. They also agreed that the opinions of the ancient Greek philosophers far outweighed what the Bible had to say. Yet there was one point of disagreement between Copernicus and the aforementioned church “fathers”: whereas the latter all agreed that God had written two great books, the *Book of Nature* and *The Holy Bible*, Copernicus insisted that God had written only one book: the *Book of Nature*.⁷ We find

in Copernicus all the conditions spoken of in 1 Corinthians 2:14 where we read:

But the natural man receiveth not the things of the Spirit of God: for they are foolishness unto him: neither can he know them, because they are spiritually discerned.

Copernicus' search of the classics was not doomed to disappointment. He first came across the writings of Philolaus (Chapter 20) and sometime later across those of Aristarchus of Samos; but Copernicus' primary support came from Plato, in particular from Book Six of the *Republic* where Plato states that the sun is to the physical realm as the good idea is to the abstract realm. (For the complete quote see Chapter 20, p. 263):

...which of the gods in heaven can you put down as the cause and master of this, whose light makes our sight see so beautifully...[just as] the good effects...the region of the mind ...[so]...the sun effects in the region of seeing....⁸

Copernicus' formulation of heliocentrism and his search through the Greek classics occurred quite early in his life,⁹ but his book was not finished until 1536, and even then it was to be another seven years before it was published. Copernicus' heliocentrism was renowned long before the book was finished. In 1533 John Widmannstadt had presented Copernicus' ideas to Pope Clement VII. The Pope's reaction was quite positive and the Pope's words had been related to Copernicus; but it was a letter from Cardinal Schonberg, the head of the Inquisition, which spurred the completion of Copernicus' book. In his letter, Schonberg wrote:

If you fulfill this wish of mine you will learn how deeply concerned I am for your fame, and how I endeavor to win recognition of your deeds. I have closed you in my heart.¹⁰

Copernicus' Book

Schonberg's appeal spurred Copernicus to finish his book, but that same year Clement VII died and a new head of the Inquisition was appointed. In response to the resulting uncertainty of how his work would be viewed by the new Pope, Copernicus delayed publication until 1543. The first copy of his book is said to have reached him on his deathbed.

Copernicus titled his book *De Revolutionibus*, meaning "On Revolutions," and dedicated it to Pope Paul III.* The preface was written by a Lutheran theologian named Andreas Osiander (1498-1552). Most modern historians of science deplore the Osiander preface and presume that, had Copernicus lived, he would have renounced the preface; but they ignore the contents of two letters: one from Osiander to Copernicus¹¹ and a second from Osiander to Rheticus¹² who was co-editor of the book. Both letters are dated April 20, 1541, and lay out the strategy Osiander had concocted to deflect criticism of the book which criticism was expected primarily to come from two groups, namely, the Aristotelians and the theologians. In the letters Osiander wrote:

...Aristotelians and theologians will be easily placated if they hear that the same motion as perceived can be explained by means of different hypotheses...¹³

It was Osiander's suggestion that the Copernican view be labeled a hypothesis but all the while to treat it as a fact. This strategy, proposed in the Osiander preface, is exactly the strategy that allowed the Copernican view to eventually dominate.

Copernicus' introduction to his book, *De Revolutionibus*, reveals much about his motivation in writing the book as well as listing reasons why he preferred the heliocentric model to the geocen-

* The full title in use now is *De Revolutionibus Orbium Coelestium*, which translates to "on the revolutions of the heavenly spheres," Osiander added the last two words.

tric. From the introduction it is clear that the primary influence on Copernicus was Plato. Copernicus advocates the deity of the sun, for he quotes as his ultimate authority the classicists in their idolization of the sun:

In this most beautiful temple of God how could the sun be given a better place to illuminate the whole all at once? Rightly he is called the Lamp, Soul and Ruler of the Universe. Hermes Trismegistus* calls him the Visible God while Sophocles's Electra calls him the All-seeing One. Let us place it upon a royal throne, let it truly guide the circling family of planets, earth included. Such a picture—so simple, clear and beautiful.¹⁴

From this we see that Copernicus' appeal is not to logic but to lust, beauty, and pride. His final appeal is to the pagan philosophers, not to fact and not to Christian principles.

De Revolutionibus From the Bible's Perspective

By appealing to humanist authorities for his defense of his theory, Copernicus demonstrates the truth of Proverbs 26:24-25 which reads:

²⁴ He that hateth dissembleth with his lips, and layeth up deceit within him;

²⁵ When he speaketh fair, believe him not: for there are seven abominations in his heart.

The seven abominations in the heart of Copernicus as he wrote the introduction were these:

* Hermes Trismegistus, whose name means thrice-great messenger of the gods, is an elusive figure. Nothing is known for certain about him. He has been dated anywhere from Enoch's time (before the Flood) to A.D. the third century.

1. First, the universe is not the "temple of God," for Isaiah 66:1 says of the temple or house of God: "...the heaven is my throne, and the earth is my footstool: where is the house that ye build unto me?" indicating that the heaven is only a throne and not a temple. I Kings 8:27, II Chronicles 6:18, and II Chronicles 2:6 all state that "...the heaven of heavens cannot contain thee." Nowhere in scripture is the universe ever said to be the temple of God. Evidently, in Copernicus' view, God is limited to the size of the universe. His god is thus finite, not infinite.
2. The second of the seven abominations in Copernicus' heart is the claim that the sun is ruler of the entire universe. Scripture clearly teaches that the sun rules the day, but not the night; hence another departure from scripture on the part of Copernicus and another abomination as far as the Bible is concerned. (See Harold Armstrong's argument in Chapter 7, "The Sun to Rule by Day.")
3. The third abomination is attributing a soul to the universe. That is tantamount to pantheism. The universe does not possess a soul, and even if it did it is quite certain that the sun would not be that soul. Souls are an attribute and possession of animate objects, not of inanimate matter. It was argued in years past that the soul of the universe is the composite of all the living souls within it, but the soul of the saint is not the same as the soul of the reprobate, so that the idea of one universal soul is repugnant to scripture. As Lambert Daneau expressed it:

...by this [assumption], the goodness and wisdom of God, who giueth unto euerything, and ingraffeth within them their proper and distincte vertues, is not only obscured, but utterly extinguished, and plucked out of mennes mindes: whiles wee attribute these vertues, the administration and gouernment of those thinges, not to GOD hymselfe, but unto a certaine other nature and soule, con-

trarie to that whiche wee are taught too beeleeue and confesse, Psalme 147. and 15. and 16. verses: To the Ephesians the 3. chapter verse 20. and Iob the viii. chapter the 5. verse.¹⁵

4. The fourth of Copernicus' abominations lies in the title "All-seeing One" which usurps a title more properly belonging to God. But except for some shortsighted translations of Genesis 16:13 in modern versions, Scripture never applies the term *all-seeing* to God. All-seeing is an attribute that cannot consistently be applied to God because the Bible clearly teaches us that God can cast things from out of his sight as is attested to by Jeremiah 7:15:

And I will cast you out of my sight, as I have cast out all your brethren, even the whole seed of Ephraim.

Likewise, in Lamentations 3:50 the same thing is implied by the statement "Till the LORD look down, and behold from heaven." The claim that the God of the Bible is not all-seeing is not a limitation of God's power; on the contrary, it indicates that God also has the power to willfully refuse to regard. Likewise God is capable of forgetting that which he will, for in Hebrews 8:12 and 10:17 he writes: "And their sins and iniquities will I remember no more."

5. The fifth of Copernicus' abominations is that he allows the sun the title of "Visible God." The sun is a type of Christ, it does not embody God; neither is it God. God manifested himself only in the person of the Lord Jesus Christ. God is, after all, a person and not a thing. The title "Visible God" properly belongs to Jesus Christ when he is on earth.
6. Sixth, Copernicus says: "Let us place it [the sun] upon a royal throne." This statement reveals that Copernicus is clearly aware that he is fomenting revolution; for if he truly believed that men were wrong in their geocentric beliefs, then the sun

would have occupied the central “throne” of the universe from the beginning and there would be no need to “place” the sun on a throne it already possesses. Instead, Copernicus proposes that we replace whoever is on the throne with the sun; as if it is in man’s power so to do. Likewise the statement: “Let it truly guide the circling family of planets, earth included” implicitly acknowledges that before Copernicus the heliocentric model had the sun *falsely* guiding the planets, earth included. Furthermore, Copernicus would have us believe that mankind has it within his power not only to enthrone the sun, but also to “let it truly” guide the planets and the earth.

It could, of course, be argued that Copernicus was merely being poetic: but poetry flows from the abundance of the heart and, spiritually speaking, the content of his poetry reflects a false heart. Even as pure poetry, the appeal is to the irrational and the pride of man, not to the rational. Yet it is Copernicus’ claim that his model is more rational than the geocentric universe. If this were true then no appeal to the irrational would be necessary. Why make it appear that the reader has it within his power to *truly* endow the sun with new and noble characteristics? One can only conclude that, wittingly or unwittingly, Copernicus is calling for a revolution, one that will institute a form of sun worship akin to the religion of modern evolution which endows the sun with the power to create life. This abomination echoes Satan’s boast against the Lord in Isaiah 14.

7. The seventh and final abomination in the heart of Copernicus as expressed in his introduction is found in the last sentence of the quote; namely, it is the assumption that truth is necessarily simple. This assumption is belied by Proverbs 1:22 where wisdom cries: “How long, ye simple ones, will ye love simplicity?” The most advanced theories in physics and astronomy are far from simple, even when dealing with fundamental, comparatively simple events such as tides.

We have examined the rationale for heliocentrism that Copernicus presented in the introduction to his book. We saw that there was nothing even remotely scientific in it and that instead it appealed to emotions, proposing a revolt against God. One may, of course, accuse this author of exaggeration and misrepresentation, but if that is so, why did the theologians of his day react similarly?

Luther's Response to Copernicus

For the most part the Reformers ignored Copernicus. The immediate responses of a few of them have been reported. Martin Luther's is characteristically the most caustic. His famous comment is recorded in the *Table Talks* and was uttered on June 4, 1539, several years before the *Revolutionibus* was published:

There was mention of a certain new astrologer who wanted to prove that the earth moves and not the sky, the sun, and the moon. This would be as if somebody were riding on a cart or in a ship and imagined that he was standing still while the earth and the trees were moving. [Luther remarked:] "So it goes now. Whoever wants to be clever must agree with nothing that others esteem. He must do something of his own.

This is what that fellow does who wishes to turn the whole of astronomy upside down. Even in these things that are thrown into disorder I believe the Holy Scriptures, for Joshua commanded the sun to stand still and not the Earth (Joshua 10:12).¹⁶

Luther's statement tends to be soft-peddled by modern scholars who wish to apologize for Luther. It is true that Luther said much worse about other people, but Luther could scarcely foresee that Copernicus would ever be taken seriously. As for Copernicus, his arrogant response to Luther's was:

To attack me by twisting a passage from Scripture is the resort of one who claims judgment upon things he does not understand. Mathematics is written only for mathematicians.¹⁷

In other words, according to Copernicus, mathematics supersedes the Bible. As for the “twisting a passage from Scripture” reference, as can readily be seen by reading Joshua chapter ten, the passage was not at all “twisted” by the Wittenberg Reformer (see Chapter 8).

Response of Melanchthon

History also records the words of the Reformer Philipp Melanchthon to Copernicanism. His response: “Wise governments ought to repress the impudence of their intellectuals.”¹⁸ Melanchthon pointed to the Bible, specifically referring to a number of Psalms as well as Ecclesiastes 1:5. In addition, he appealed to the obvious motion of the sky and concluded his train of thought with these words: “Fortified by these divine testimonies, we cling to the truth.”¹⁹

When it came to the authority of scriptural revelation over natural revelation, Melanchthon had this to say:

Although certain people ridicule the citing of divine testimonies in physical matters, we consider ourselves only honest to unite philosophy with heavenly dictates and to consult divine authority in such obscure matters of the human mind, wherever we are able. The Psalmist clearly affirms the sun to move...[here Melanchthon quotes Psalm 93:1]...let us be content with this clear testimony concerning the sun.²⁰

From this we see that the Reformers did require that theories be conformed to both Scripture and natural evidence and not just to the natural, humanist mind.

John Calvin

In addition to Luther and Melanchthon it is widely reported that John Calvin also spoke out against Copernicus,²¹ but no evidence has been found. Although searched for by several modern investigators, the alleged quote by Calvin against Copernicus originates in A. D. White's *History of the Warfare of Science With Theology in Christendom*.²²

Now here is a fine point: although Calvin may not have spoken out directly against *Copernicus*, he did speak against *Copernicanism*. Bouwsma reports that:

Calvin did write that those who "assert that 'the earth moves and turns'... [are] motivated by 'a spirit of bitterness, contradiction, and faultfinding;' possessed by the devil, they aimed 'to pervert the order of nature.'²³

Initially, theologians believed that the heliocentric view was to be speculation or hypothesis, as Osiander's preface stated, especially since it was not backed by empirical evidence. Pearcey and Thaxton observed:

Once again, a heliocentric view was considered to be speculation not backed by empirical evidence. There's even some indication that the theory was based more on "Neo-Platonic sun mysticism" than science.²⁴

Note that Calvin's comments related to nature, not Scripture. It is not out of character for Calvin to have spoken so because he was generally quite impressed by science and well accustomed to accommodating the Bible to science if there was any apparent disagreement between the two fields.²⁵ In his commentary on Genesis 1:16, for example, we read the following about the two great lights:

Moses wrote in a popular style things which, without instruction, all ordinary persons, endued with common sense, are able to understand; but astronomers investigate with great labor whatever the sagacity of the human mind can comprehend... Nevertheless, this study is not to be reprobated, nor this science to be condemned, because some frantic persons are wont boldly to reject whatever is unknown to them. For astronomy is not only pleasant, but also very useful to be known: it cannot be denied that this art unfolds the admirable wisdom of God. ...Moses, therefore, rather adopts his discourse to common usage.²⁶

That Genesis 1:16's use of "great" when describing the sun and moon is not figurative in the sense that Calvin would have us believe was demonstrated in Chapter 7: "The Sun to Rule by Day." Yet, according to Calvin, either Moses is entirely responsible for the "error" in the passage and God did not inspire it, or God does not tell the-whole-truth-and-nothing-but-the-truth if that truth should prove to be inconvenient to the mind of the common man. According to Calvin, for the sake of expediency God is not above letting an untruth slip in here or there and still call it the truth.* As we shall see, it was this view—that God does not necessarily mean what he writes when it comes to the sciences—which opened the door to the acceptance of Copernicus' opinion of the universe by Christians.

On earth's lack of rotation, Calvin's quote is consistent with the geocentrists, for in his commentary on Psalm 93:1 he wrote:

The heavens revolve daily; immense as is their fabric, and inconceivable the rapidity of their revolutions, we experience no concussion—no disturbance in the harmony of their motion.²⁷

* Jesus speaks in John 17:17—Sanctify them through thy truth: thy word is truth.

There is no evidence that Calvin ever changed his mind about geocentrism; but neither is there evidence that he did not change his mind, either. Throughout his life geocentrism was the prevailing concept, so most likely the former is the case.

Conclusion

We saw that modern heliocentrism originated from a man, a humanist, who knew it was a pagan concept and a Bible heresy. He chose heresy.

Originally it was intended to teach Copernicanism as theory or mathematical expediency. The Reformed theologians didn't buy it. We quoted several who spoke against Copernicanism. There were other, less famous Reformers who spoke out against Copernicanism. We have recorded the comments of only some of the famous Reformers; but it is clear from the books and articles of the time that the heliocentric hypothesis did not go unchallenged, and that by far the most opposition came from Protestant nations. As far as the Church of Rome was concerned, Copernicanism presented no challenge; besides, Copernicus had dedicated the book to the Pope. Not until some sixty years later would the Vatican be forced to take issue with the Copernican idea, but in the meantime, the debate about its merits was restricted to Protestant Europe.

Next in line are the scientists...they feel that they are the only men with any wisdom, and all other men float about as shadows. How senilely they daydream, while they construct their countless worlds and shoot the distant sun, the moon, the stars, and spheres, as with a thumb and line.... They can never explain why they always disagree with each other on every subject. In summation, knowing nothing in general they profess to know everything in particular.

—Desiderius Erasmus¹

THE EARLY COPERNICANS

During the course of the sixteenth century, with the reality of the Reformation firmly established, the bankruptcy and shortsightedness of the Aristotelian view became more and more evident. The old-guard Aristotelian humanists had to dismiss the classical philosophy upon which their worldview was constructed and replace it by Platonic humanism. No third alternative existed for the humanists because then, as now:

...humanism was a backward looking movement, forever trying to revive a dead classical past and rejecting the living medieval present.²

In that context we shall now examine early adopters of the Copernican model and, where possible, survey their views of Scripture.

Thomas Digges (1546-1595)

The first English public supporter of Copernicus was Thomas Digges who, in the 1576 edition of his father's perpetual almanac,

A Prognostication Everlasting, added among several appendices one entitled *A Perfit Description of the Caelestiall Orbes according to the most aunciente doctrine of the Pythagoreans, latelye revived by Copernicus and by Geometricall Demonstrations approved*. In previous editions, his father had presented the Ptolemaic model in his almanac. In the appendix, Digges not only depicted the Copernican model as the ultimate reality, but also had the stars distributed out to infinity, a proposal which runs into scriptural as well as logical problems. Little is known about Digges' stance on Scripture.

Digges' Copernican model is pictured in Figure 1. The text in the outer shell reads:

This orb of stars fixed infinitely up extends itself in altitude spherically, and therefore immovable the palace of felicity garnished with perpetual shining glorious lights innumerable, far excelling over [the] sun both in quantity and quality the very court of celestial angels, devoid of grief and replenished with perfect endless joy, the habitacle for the elect.

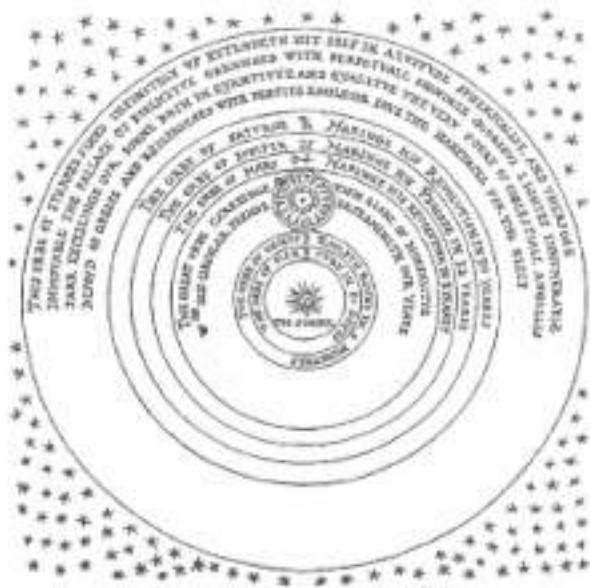

Figure 1: Digges' Concept of the Universe.

William Gilbert (1540-1603)

Another early English supporter of Copernicus was William Gilbert. Unlike Digges, however, who seems not to have mentioned Scripture in his work, Gilbert did reveal his view of Scripture in the following quote taken from his book, *De Magnete*:

Nor do those things which are adduced from the Sacred Scriptures seem to be especially adverse to the doctrine of the mobility of the earth; nor does it seem to have been the intention of Moses or the Prophets to promulgate any mathematical or physical niceties, but to adapt themselves to the common people and their manner of speech, just as nurses are accustomed to adapt themselves to infants, and not to go into every unnecessary detail. Thus in Gen. i. v. 16, and Psal. 136, the moon is called a great light, because it appears so to us, though it is agreed nevertheless by those skilled in astronomy that many of the stars, both of the fixed and wandering stars, are much greater. Therefore neither do I think that any solid conclusion can be drawn against the earth's mobility from Psal. 104, v. 5; although God is said to have laid the foundations of the earth that it should not be removed for ever; for the earth will be able to remain evermore in its own and selfsame place, so as not to be moved by any wandering motion, nor carried away from its seat (wherein it was first placed by its divine artificer).³

Note the similarity to statements made in Calvin's commentary on Genesis 1:16, which we quoted at length in Chapter 21. Gilbert compromises: he ignores Divine inspiration, attributing the geostatic "error" to Moses and the prophets, thus assuming that the Holy Ghost cannot inspire "true truth" through these men. Furthermore, both Calvin and Gilbert ignore the fact that the word "great," applied to the sun and moon in Genesis 1:16, contextually refers to their purpose in creation, not their brightness; for we saw in Chapter 7 that the Bible use of the word "great" in connection with the sun and moon need not refer to either their brightness or

their size but to their function in the creation. Consider David and Goliath, for instance; which was the greater? Likewise, there is no need for God to accommodate the wording to popular speech, for the meaning would be equally clear if the word "great" had been omitted from the passages and thus have avoided the supposed error.

Gilbert, as almost all Reformers, also missed the conditional state of Psalm 104:5, which verse cannot be taken as a proof text for geocentricity, as we saw in Chapter 5. Furthermore, although the technology of Gilbert's day could not see it, he is also mistaken in judging the earth to be imperturbable in its orbit and rotation. As we saw in our lengthy discussion of Psalm 19:6 in Chapter 7, modern astronomers routinely view the earth as being perturbed in both orbit and rotation.

Johannes Kepler (1571-1630)

A third early supporter of heliocentrism was Tycho Brahe's protégé, Johannes Kepler. Kepler's contribution to science is two-fold. Firstly, he determined that the shapes of the planetary orbits are ellipses or flattened circles instead of circles (Figure 2) and he formulated three "laws" about that observation. Secondly, Kepler introduced the mechanistic worldview into modern science and philosophy: the idea which treats man and cosmos as mere machines. The idea was not new with Kepler, however, for Arzachel of Toledo had suggested that much for the *Ptolemaic* model back around A.D. 1080. Arzachel's proposal may be found in his *Toletan Tables*, a book of planetary positions. Reinhold (1511-1553) had also suggested elliptical orbits for the planets long before Kepler was born. But back then, the time was not ripe to abandon the Greek superstition of the perfection of the circle, and the prevailing scientific opinion up to Kepler's day was that the planets moved in circles. So pervasive was the idea of circular orbits that even Copernicus had the earth and planets moving in circles. In fact, strictly speaking, he did not have the sun at the center

of the universe but found that he was forced to place the center of the earth's orbit there instead!

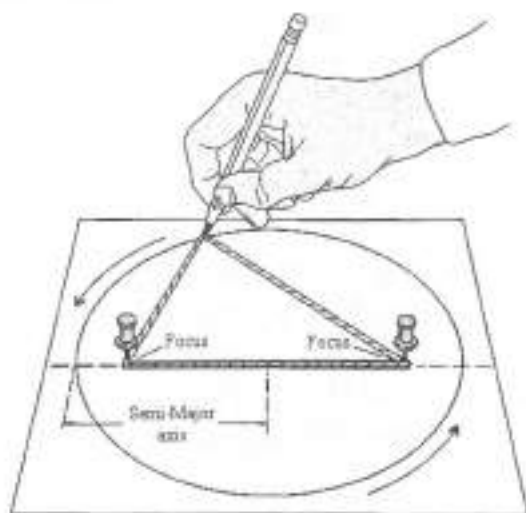

Figure 2: *Parts of an Ellipse*

The reasoning behind the notion that the planets had to move in circular orbits was the Greek idea that the circle is perfect. The basis for this belief was that every point on a circle is exactly the same distance from the center of that circle. This ancient superstition of the perfection of the circle, which classical and medieval thought insisted upon, actually kept Kepler from

recognizing the elliptical nature of orbits for many years.

Kepler believed the earth to be a planet and that it revolves about the sun in an elliptical orbit. He deemed such to be evidence against Tycho's model, but the fact that the planets move in nearly elliptical orbits does not at all invalidate or disprove the Tychonic model;^{*} nor even the Ptolemaic model as far as that goes. Ptolemy's use of the deferent and equant serve to move a planet so that it closely traces out Kepler's elliptical path as seen from the sun, as well as Kepler's equal area law. The only modification to Tycho's cosmology would be that the planets move about the sun in elliptical orbits and that the sun would carry them in its annual orbit about the earth in its own elliptical orbit.

^{*} We shall examine the Tychonic model at length in the chapter 24.

Kepler's Laws

Kepler spent his life trying to find an arithmetic law which he believed to be the underlying law describing the structure of the universe. In his book, *Mysterium Cosmographicum*, Kepler outlined his purpose in these words:

My aim is to show that the heavenly machine is not a kind of divine, living being, but a kind of clockwork [and] how these physical causes are to be given numerical and geometrical expression.⁴



Figure 3: Johannes Kepler

Kepler's view stemmed from the Pythagorean concept of the harmony of the spheres. Using Tycho's observations, Kepler eventually discovered three "laws."⁵ The third of his "laws," called the law of areas, resulted from Kepler's search for harmonic ratios (fractions). It states that the cube of a planet's orbital period (or its year), when divided by the square of its distance from the sun, is a constant. After Kepler's discovery of the third law, he was firmly convinced that geometry and music had guided the Creator of the universe. Theologically speaking, Kepler was incorrect, for his approach makes God subject to the laws of geometry and harmony; but these are things God created. To Kepler, though, they far exceeded God in wisdom and magnificence. Kepler claims that geometry is God when he states:

Geometry, coeternal with the divine mind before the origin of things, God Himself (for what is there in God that is not God

Himself) has supplied God with the examples for the creating of the world.⁶

Note the pantheism inherent in the parenthetical clause, "for what is there in God that is not God Himself." Also here, in the impersonal authority of geometry, we find the foundation for the modern opinion that the universe in general, and man in particular, is nothing more than a machine.

The Universe as Machine

Although the universe can be viewed as a machine, it is not purposeless. God had a purpose in creating the universe and man is key to that purpose (Romans 9:22-24). It was Kepler's view of the universe as a clockwork set in motion by God and abandoned to run down, which heralded the decline of man in man's own eyes; for the logical conclusion of Kepler's (and Copernicus') worldview is that the universe is maintained by the impersonal geometry instead of by a personal God. This led directly to the modern "age of despair." Historians of science concur that modern existentialism is the logical result of Kepler's mechanistic worldview and Kepler's geometer-god; and modern man is left with a haunting sense of purposelessness and powerlessness.

Like Copernicus, Kepler did not hold to heliocentrism for any reason but faith in the Greek classic studies. Johnson writes:

Kepler himself, for reasons connected with his acceptance of the Pythagorean belief that the sun was the noblest body and therefore most fit to occupy the center of the universe, was ever the ardent Copernican.⁷

This is evident when Kepler writes:

The Sun not only stands in the center of the universe, but is its moving spirit.⁸

With both Kepler and Copernicus the issue is that of sun worship: should the universe be considered to be ruled by God or by the sun? By calling the sun the "moving spirit" of the universe, Kepler removes God from having any motivating or sustaining power in the universe. This runs contrary to Colossians 1:17: "And [Christ] is before all things, and by him all things consist." The expression "all things" must include all motion.

Kepler Versus the Bible

When it comes to the geocentric passages in the Bible and the authority of scripture, Kepler was every wit the double-revelationist. Kepler wrote these words about the geocentric verses of the Bible:

...astronomy discloses the causes of natural phenomena and takes within its purview the investigation of optical illusions. Much loftier subjects are treated by Holy Writ, which employs popular speech in order to be understood. Within this framework and with a different purpose in view, only in passing does the Scripture touch on the appearances of natural phenomena as they are presented to (the sense of) sight, whence human speech originated, and proceed to do so even though it was perfectly clear to everyone that optical illusions are involved. Not even we astronomers cultivate astronomy with the intention of altering popular speech. Yet while it remains unchanged, we seek to open doors of truth. That the planets are stationary or retrogress; the sun stands still, turns back, rises, sets, goes forth from one end of heaven like a bridegroom coming out of his chamber and goes down into the other end (of the heaven), mounts to the midst of heaven, moves against certain valleys and mountains—these expressions are used by us along with laymen, that is, with the visual sense, even though not one of these locutions is literally true, as all astronomers agree.⁹

Evident in this passage are the following errors:

- 1) It is beneath God's dignity to speak accurately; that is, he is too busy to be bothered;
- 2) Human speech evolved from the sense of sight, speech not being part of God's original creation. Yet God is reported to have spoken the universe into existence, and the human languages came about by the confounding of languages at the tower of Babel. Also, Adam was created with full linguistic capabilities;
- 3) Since "even astronomers" do not intend to alter speech, how much less would God intend to alter speech either;
- 4) God is not above penning a "literally" false statement, that is, God is "literally" a liar;
- 5) In addition to those obvious errors in Kepler's prose, we find more subtle ones, to wit: Kepler maintains that scripture touches on the "appearances of natural phenomena" "only in passing," but Hezekiah's sign is explicitly mentioned in three places and is alluded to in a fourth, and one of those references consists of an entire chapter—hardly a "passing reference." Likewise Joshua 10:13 reinforces itself when it repeats that the "sun stood still," just in case we missed it the first time;
- 6) Kepler also confuses the fifth and sixth verses of Psalm 19 in his attempt to paraphrase those verses, and;
- 7) Kepler lied when he wrote that "all astronomers agree" to his phenomenological interpretations of scripture and especially to his heliocentrism, for less than half of the astronomers in Kepler's day agreed with Kepler, a far cry from "all." Kepler admits the Bible's geocentricity but refuses to believe it. He writes of the Bible that we must: "weigh its words on the precision balance of natural science."¹⁰

Kepler on Kepler

With such a low view of the Bible, is it any wonder that in announcing to the world his discovery of the third law, Kepler wrote a torrent of flamboyant words:

What I prophesied twenty-two years ago...what sixteen years ago, I urged as a thing to be sought; that for which I joined Tycho Brahe, for which I settled in Prague, for which I have devoted the best part of my life to astronomical contemplations, at length I have brought to light, and recognized its truth beyond my most sanguine expectations. It is not eighteen months since I got the first glimpse of light, three months since the dawn, very few days since the unveiled sun, most admirable to gaze upon, burst upon me. Nothing holds me; I will indulge my sacred fury; I will triumph over mankind by the honest confession that I have stolen the golden vases of the Egyptians to build up a tabernacle for my God far from the confines of Egypt. If you forgive me, I rejoice; if you are angry, I can bear it; the die is cast, the book is written, to be read either now or by posterity, I care not which; it may well wait a century for a reader, as God has waited six thousand years for an observer.¹¹

Are we to believe that God waited six thousand years for a vase thief? And what "sacred fury"? Kepler's introduction reads more like Satan's taunts of Isaiah 14:13-14 and Ezekiel 28:2 than it does of the good, godly man that some claim Kepler to have been.

Since these are the taunts of Satan, is there any other connection between Kepler and the occult? It turns out that there is. It is no secret that Kepler's mother, Katherina, was tried for witchcraft and that Kepler helped in her successful defense against the forty-nine charges against her. What is less commonly known is that Kepler's mother was raised by a kinswoman who was executed for practicing witchcraft.¹² At one time Katherina requested her fa-

ther's skull from his grave from the sexton of Eltingen Churchyard. Her intent was to get the skull silvered to give to Kepler for a goblet.

Although trained for the Lutheran communion, Kepler was never ordained because of unorthodox theological views. Those views are reflected in a 1597 manuscript entitled *Cosmic Mystery* in which Kepler promoted the Copernican system. A 1609 book called *Lunar Geography* or, more popularly, *Kepler's Dream*, tells of demons who drug people using opiates so that they can survive the sudden acceleration of a journey to the moon along the earth's shadow at the time of a lunar eclipse. The purpose of the journey is to demonstrate the rotation of the earth. While living at Linz (c.1613) the Lutheran pastor there refused to allow Kepler to participate in Holy Communion. The reason? Kepler's dabbling in "the forbidden arts." The Linz pastor may have had other reasons; as we shall see in the next chapter, Kepler's actions surrounding Tycho's death were less than Christian.

Kepler and the Counterfeit Data

Though it is popular now to hold Kepler forth as one of the great Christians of his time, those who have read his works know that he was far from that. Now we discover, especially to the horror of his Christian promoters, that he even lied about the data he used to "prove" his theory of how the planets move about the sun according to Dr. William H. Donahue who has translated much of Kepler's works from Latin to English.¹³

In chapter 53 of his book, *The New Astronomy*, Kepler claimed he used parallax (see Figure 20.3), which takes a known distance between two points and then calculates the distance to a third point above or below the line by measuring the angles in the triangle formed by the three points. The resulting distances, calculated over time, traced the paths of planetary motions and showed that the orbits were elliptical, not circular.

Kepler claimed that the calculations provided independent proof of elliptical orbits. He presented his findings in a large chart.

Dr. Donahue worked through the numbers to make sure he understood Kepler's chart. Instead of his math agreeing Kepler's data, Donahue's numbers disagreed with Kepler's. After repeatedly getting the wrong answers for the numbers displayed on Kepler's chart, Dr. Donahue realized that the numbers in the chart were not the results of independent observations derived by triangulated planetary positions, but by calculations using Kepler's area law itself. "He was claiming that those positions came from the earlier theory," Dr. Donahue said. "But actually all of them were generated from the ellipse."

Historians of science all rushed in to excuse Kepler. They claim that such deception is excusable simply because he was a "giant" of science who shaped modern science and that, in his day, to quote Dr. Owen Gingerich, his act: "...may simply have been a legitimate flourish meant to persuade recalcitrant colleagues of the correctness of his insight." Hmm. It's all right because his theory turned out to be correct. But it would have been wrong if his theory were wrong. Situational ethics, anyone?

Galileo Galilei (1564-1642)

But support for heliocentrism did not center just on Kepler. Thus far we have focused our attention mostly on the very early supporters of Copernicus in Protestant countries where initial opposition was heaviest. After all, Copernicus had dedicated his book to the Pope (Paul III) and a Pope (Clement VII) as well as a former head of the Inquisition had even encouraged its publication.

Left to its own devices, Roman Catholicism would have quietly absorbed heliocentrism as a theory in the same way that it has now absorbed evolution. However, it was not left in peace. Galileo's outspoken, impatient insistence that the Church of Rome accept heliocentrism as a proven fact rather than a theory forced Rome's hand.

The exact date of Galileo's conversion to heliocentrism is not known, but it seems to have been between the years 1593 and 1597

during which time Galileo was a professor at Padua.¹⁴ Galileo made a number of significant contributions to modern physics and astronomy. In the latter field his most notable achievement was the systematic application of the telescope to make a variety of astronomical observations. Galileo insisted that several of his telescopic observations were proofs of heliocentrism. Initially he was ignored. Most of the early



Figure 4: Galileo Galilei

opposition he received was because he challenged the ancient Roman and Greek superstition that the celestial bodies, namely the sun, moon, and planets, had to be spotless. Galileo saw that the sun occasionally exhibited spots. In response to his announcement of sunspots, a cleric addressed him with the words:

I have read Aristotle's writings from beginning to end many times and I can assure you that I have nowhere found anything similar to what you describe; go, my son, and calm yourself; be assured that what you take to be spots on the sun are the faults of your instrument or of your eyes.¹⁵

Such an attitude is characteristic of men enamored on an established scientific theory when they are suddenly confronted with contrary evidence. Having spent their entire careers defending a pet theory, any evidence that negates that theory in effect says to them that they have wasted their lives; they regard it as life threatening. We see similar reactions from evolutionists today who will not countenance any evidence against evolution even though there

is no evidence at all for macro-evolution (e.g., a lizard lays two eggs and male and female birds hatch out).

Galileo's Proofs of Copernicanism

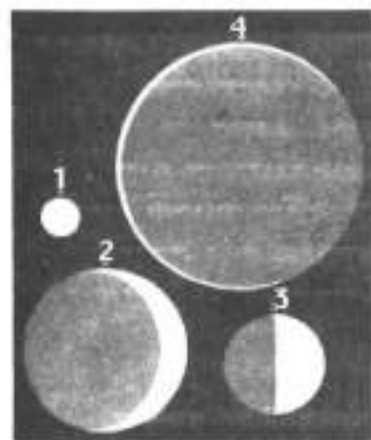

Figure 5: *Phases of Venus.* (1) is the full Venus when it is on the far side of the sun. (3) is when Venus is even with the sun. (2) is when Venus is about $\frac{1}{4}$ of the way around its orbit towards the earth. (4) is when Venus is nearly between the earth and the sun.

(USN Observatory)

Why, if the rebuke proffered others was so much greater, do modern historians of science present Galileo as a persecuted martyr? To understand that we need to examine the "proofs" of heliocentrism that Galileo offered. The first of the proofs proposed by Galileo for heliocentrism was his observation that the sun rotates on its axis with a period of about one month. He argued that this was a proof because he erroneously supposed that the rotation of the sun would drive the universe; in particular, that it would drag the planets around the sun. Although Galileo had no real physical principle for his conclusion (he held it purely for metaphysical reasons), he insisted upon it anyhow. But it was the Jesuits of his day that he had to convince and they recognized that Galileo was motivated purely by metaphysical arguments and lacked

proof; hence they failed to openly rally to his support.

The second proof which Galileo held out for heliocentrism was his observation that Jupiter had four satellites orbiting it (Figure 6). This was another argument by analogy, for the Aristotelians maintained that one reason why the earth could not be in motion around the sun was that if it were so moving, then the earth could not drag the moon along with it around the sun. Galileo argued that if Jupiter could drag its satellites along with it in its jour-

ney around the sun, then the earth must drag the moon along with it in its orbit about the sun. Galileo's second argument countered only one of the Aristotelians' "evidences" and again, as the Jesuits realized, it was not a proof at all for the motion of the earth.

A third proof of heliocentrism offered by Galileo was the fact that the planet Venus exhibits phases similar to those of the moon (Figure 5). Galileo incorrectly maintained that the Ptolemaic model could not account for the phases of Venus and Mercury. Actually, his argument is correct as long as one insists on the crystalline spheres geocentric model. If one allows Tycho's version of the Ptolemaic model then the argument falls flat and Galileo's third proof of heliocentrism turns out to be no proof at all. Furthermore, all three of Galileo's "proofs" for heliocentrism could just as well "prove" the Tychonic universe. So Galileo's "proofs" were not proofs at all. This fact was recognized by the Jesuits as well as the Inquisition before which Galileo ultimately appeared twice.

Despite this, Galileo continued to insist that his were actual

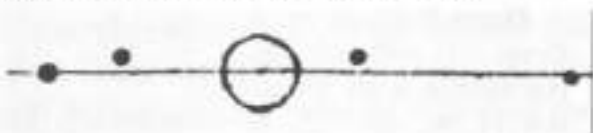

Figure 6: Galileo's sketch of Jupiter and Its Four Major Moons

proofs and furthermore, he insisted that the Roman Catholic Church

officially recognize them as such and that it officially recognize heliocentrism as an indisputable fact. It was his insistence on these points, plus his arrogance in insisting that he alone was right and his insistence that the burden of proof lay on the old traditional view, not on the upstart Copernican view, which got him into trouble. Those claims challenged both the authority of his Mother Church as well as the rule of science which places the burden of proof on the new theory, not the old.

Galileo Versus the Roman Catholic Church

When the issue of heliocentrism did finally come to a head in the Roman Catholic Church it was the second decade of the seventeenth century. In 1615, Galileo was called before the Inquisition for his arrogance and his challenge to the authority of the Roman system. The stories of the hard, cold, callused persecution of Galileo by the church could not be further from the truth. Galileo was provided with transportation to Cardinal Bellarmine's tribunal and he was not shown the Inquisition's torture chambers. There is no record that Galileo met with Pope Paul V, who ordered his appearance before Bellarmine. All we know is that Galileo was warned that the heliocentric idea could not be defended as fact. There were no other constraints placed on Galileo. Basically, it meant that the heliocentric model could be taught as a postulate or theory. It could be used as a mathematical expediency but could not be taught as allowed by Scripture. Furthermore, the Pope gave Galileo a nice villa and a pension to support him. All this changed later, but for now we note that Galileo's appearance before the Inquisition led to a condemnation of Copernican heliocentrism in February 1616.

The Congregation of the Index

Galileo's efforts on behalf of heliocentrism did have the effect of temporarily placing Copernicus' book on the Papal Index of banned books. *De Revolutionibus* could, however, be published if certain changes were made in the text. The conditions under which *De Revolutionibus* could be published appeared in 1620 and modified the decree of the Congregation of the Index dated March 5, 1616, which decree had banned *De Revolutionibus* from being read by Roman Catholics until appropriate changes had been determined. Along with Copernicus' book, said 1616 decree had also included two other books: one of them, by Astunica, was entitled *In Job Commentaria* and had been published in Toledo in 1584.

Both Copernicus' book and Astunica's fell into the same category in that they were suspended from publication pending correction for promoting:

The false Pythagorean doctrine, absolutely opposed to the Holy Scriptures, concerning the mobility of the earth and the immobility of the sun.

The third of the books in the 1616 decree was a work of the Carmelite Paolo Antonio Foscarini (1580-1616) entitled *Lettera Sopra L'Opinione de' Pittagorici e del Copernico, della Mobilita della Terra e Stabilita del Sole, e il Nuovo Pittagorico Sistema del Mondo*, (Naples, 1615). It was not subject to the same conditions as the other two books, for it could not be revised. The 1616 ruling stated that works which taught heliocentrism as fact had to be corrected, but works which declared the dogma of heliocentrism to be conformable to Scripture were to be utterly condemned. Hence, of Foscarini's book, the Index states that it was:

to be wholly prohibited and condemned [for seeking] to show that the aforesaid doctrine is consonant with the truth and is not opposed to the Holy Scriptures.

Yet that is what Catholic heliocentrists of all stripes do today. Even Creationists insist that the heliocentrism is consonant with Scripture and that geocentricity is opposed to Scripture. Of that we shall speak later.

The Index on Copernicus

In 1620 permission was granted to publish the work of Copernicus with certain alterations. Interestingly enough, in the introduction to the emendations, Copernicus is called a "noble astrologer," reflecting the respect which the Roman Catholic Church had

for him. It reiterates that the previous suspension of publication was because:

Sacred Scripture, and its true and Catholic interpretation are offended (which in a Christian man can hardly be tolerated) by his failure to treat [his model] *as a hypothesis*, and his assertion of it as "*beyond doubt*."

The corrections are then stated as relating:

to those places where he makes hard and fast assertions concerning the position and mobility of the earth rather than discussion by hypothesis.

In the following text, which is a translation of the Latin decree, the notes are not in the original but have been added for clarification of some rather obscure allusions. Here is the text of the Index on Copernicus:

(In the Preface, towards the end) *Copernicus*. If by chance there be vain babblers who, though ignorant of Mathematics, yet take it upon themselves to sit in judgment thereof on account of a certain passage of Scripture, which they badly twist for their purpose; and who dare to criticize and censure this teaching of mine: I ignore them completely, even despising their judgments as rash. For it is not obscure that Lactantius, although a prominent writer in other fields but ill versed in Mathematics, spoke childishly of the shape of the earth in deriding those who declared the earth to be a sphere. Thus it should not seem strange to the learned if some look upon us in

* Lactantius Firmianus (c. 260-e. 340) is called the "Christian Cicero." Born in Africa, he is reported to have converted to Christianity in middle age and in the opening decade of the fourth century he became the tutor of Crispus, the eldest son of Constantine the Great. Copernicus introduces his name in such a way that it appears that Lactantius argued against the sphericity of the earth from Scripture; but Lactantius' knowledge of Scripture was very slight, and his main arguments lay elsewhere. Hence Copernicus' argument is fallacious. Note that Copernicus picks on an obscure, shady figure in Christianity, not on other, greater, defenders of the flat earth such as Augustine.

the same way. Mathematics is written for Mathematicians, to whom our labors will seem, if I am not mistaken, to contribute something conducive even to the ecclesiastical Republic... *Emend.* Delete everything from "If by chance" through "to whom our labors" and replace it by "But our labors."

(Chap. 5. vol. i. p. 3) *Copernicus.* If, however, we consider the matter more carefully, then it will be seen that the matter has not yet been settled and, therefore, should certainly not be condemned. *Emend.* However, if we consider the matter more carefully it is inconsequential whether we regard the earth as existing at the center of the universe or far away from the center insofar as solutions to celestial motions are concerned.

(Chap. 8. vol. i.) The whole chapter may be deleted as it professes the truth of the motions of the earth, while refuting the reason of the ancients which reasons prove its immobility. However, since it seems to speak problematically; to satisfy the studious and to preserve the sequence and unity of the book; emend it as follows: (p. 6) *Copernicus.* Why, then, hesitate to concede to it motion which is by nature congruent with its form, all the more so the whole universe moving whose ends we are ignorant of; and why not confess that the sky presents the appearance of daily rotation while the earth truly possesses it? And so these things are, as if spoken by Virgil's Aeneas: "We are carried from the harbor." ...*Emend* to read: "Hence I cannot concede motion to this form, the more so because the universe, of whose ends we are ignorant, would collapse, and what appears in the heavens is just as if ..."

(p. 7) *Copernicus.* Add also that it seems really absurd to ascribe motion to that which contains and locates, and not to that which is contained and located, namely, the earth. *Emend.* Add also that it is no more difficult to ascribe motion to that which is contained and located, namely the earth, than to that which contains it.

(p. 7) *Copernicus*. From all these things it is apparent that the motion of the earth is more probable than its immobility, especially its daily rotation which is as one of primary properties. *Emend.* Omit from "From all" to the end of the chapter.

(Chap. 9. vol. i. p. 7) *Copernicus*. Since there is nothing to prohibit the mobility of the earth, it seems to me that we should consider if it possesses several motions and thus could be regarded as one of the moving stars. *Emend.* Since I have assumed that the earth moves, it seems to me that we should consider if it possesses several motions.

(Chap. 10. vol. i. p. 9) *Copernicus*. We are not ashamed to accept ... that this is powerfully verified in the motion of the earth. *Emend.* We are not ashamed to assume...that this is consequently verified in the motion.

(Chap. 10. vol. i. p. 10) *Copernicus*. So superbly divine is this work of the Best and Greatest. *Emend.* Delete these words.

(Chap. 11. vol. i.) *Copernicus*. Earth's triple motion demonstrated. *Emend.* The hypothesis of the triple motion of the Earth and its demonstration.

(Chap. 20. vol. iv. p. 122) *Copernicus*. On the sizes of the three stars, Sun, Moon and Earth. *Emend.* Delete the words "three stars," for the earth is not a star as Copernicus makes it out to be.

All in all there were a mere dozen emendations which the Cardinals of the Index required of the *Revolutionibus* for it to be published. It would appear that the Cardinals were more in the business of saving face than in enforcing their 1616 decision. The declaration was so weak that later both the Jesuit Riccioli (of whom more later) and the Copernican Protestant John Wilkins were equally positive that the Roman Catholic Church never pronounced any decision on the book of Copernicus.

Galileo and the Inquisition

The story of Galileo did not end with the aforementioned actions of 1615. In 1623, Galileo came to Rome and had six interviews with the new Pope, Pope Urban VIII. It was at these meetings that Galileo was given permission to write about the Copernican theory, as long as he treated it as a hypothesis. During those visits, Maffeo Barberini (1568-1644), for that was Urban's real name, argued for the geocentric system on the grounds that God is omnipotent and thus not limited to the Copernican model. Pope Urban was so impressed by Galileo's intelligence and style that he became Galileo's patron and financed him.

However, Galileo's arrogant attitude got the best of him. In 1632 he published a pro-Copernican book entitled *Dialogue Concerning the Two Chief Systems of the World*. In the book, a character named Simplicio, a dedicated Aristotelian, had all his Aristotelian arguments systematically destroyed in the first 400-odd pages of the book. Galileo then put the very words in Simplicio's mouth that the Pope had spoken against Galileo in 1623, namely, that an omnipotent God could make a geocentric universe.

Thus in 1632 the patronage relationship was broken. This time Galileo was arrested; less for teaching and preaching heliocentrism as for the breaking of his word to both the Pope and the Inquisition.

As at his first appearance before the Inquisition, Galileo was treated cordially and was again only reprimanded. The legend that Galileo had to grovel before the seven Cardinals, and that as he stood up he muttered, "But it does move" under his breath is probably apocryphal. After the second time, the Catholic Church gave Galileo a pension and a villa to live in.

To put Galileo's inquisition in perspective, a bit of history is advised. The Inquisition was started by Pope Innocent III about A.D. 1200. Never disbanded or renounced, it went into recess in response to public outrage in 1800. Unlike almost all who appeared before it, Galileo escaped with his life. Some have estimated that during the 600 years it was in session the Inquisition

killed an average of over 100,000 people a year, although that figure is likely way too high.¹⁶ Galileo's survival of two confrontations with the Inquisition stands in stark contrast with the stories of his terrible treatment so popular in modern science. The worst the Inquisition ever did to Galileo was at his second appearance when he was given a tour of the torture chambers.

The Church of Rome on Heliocentrism Since Galileo

Heliocentrism did ultimately carry the day, and the Roman Catholic Church lifted its condemnation of Copernicanism in 1835. Ironically, today there is virtually no one who believes the Copernican model at all. The sun is no longer regarded as being at the very center of the universe; thus the condemnation of the Copernican model could have stayed in effect and the Roman Catholic Church could have proven itself to be correct. However, the Pope's 1835 action caused a conflict with the truth. Here's how: when Pope Paul V composed the condemnation of the Copernican heliocentrism in 1616 he forgot [?] to include the words *confirmavit et* at the end of the condemnation. This meant that the condemnation was not complete and this enabled the 1835 reversal.

In 1870 this omission was used as an argument to promote the dogma of the infallibility of the Pope: that the Pope can make no error when he speaks *ex cathedra* (from the throne) in his capacity as the *Pastor Aeternus* (Eternal Pastor).¹⁷ Yet, in 1616 the Papacy had not made an error in condemning the Copernican system, for Copernicanism is not true; but then it did make an error in the 1835 rescission. Since the infallibility of the Pope is to the Roman Church a more important dogma than is geocentricity, the Pope has had to go with heliocentrism ever since, all the while hoping that no one will notice that the 1835 reversal was a total blunder.

In 1979 Pope John Paul II asked the pontifical academicians to form a commission to re-examine Galileo's case. Since one of his main goals was the improvement of relations between the Roman

Catholic Church and science, the outcome was predictable. On Friday, September 22, 1989, while speaking at a bridge in Pisa, the Pope said:

How can one not recall at least the name of that great man, who was born here and from here took the first steps towards an imperishable fame? I speak of Galileo Galilei, whose scientific works, unfortunately obstructed at first, are now recognized by all as an essential stage in the methodology and, in general, on the journey towards the world's knowledge of nature.¹⁸

Two days later the Pope addressed professors at Pisa University. The next day, on the 25th of September, the Sapa-Reuter news agency reported that the Pope admitted that the Roman Catholic Church had wronged "the very great Galileo Galilei."

But was Galileo on trial for his Copernican beliefs or was there a hidden agenda at work? In 1985, perhaps as part of the ongoing investigation into the Galileo affair, Redondi¹⁹ reported on a then newly-found document that asks whether a passage in a paper which Galileo had published was compatible with the dogma of the mass as that dogma had then recently been defined by the Council of Trent. Redondi noted that Rome had previously accepted Copernicanism and so he suggested that Galileo got into trouble for proposing that the universe is made up of immutable atoms. That belief counters the central dogma of the mass—transubstantiation—which requires atoms to be mutable. Redondi further believes that Galileo was caught up in a power struggle between the Pope and the Jesuits and that it was the Pope's suggestion that Galileo plead guilty to a lesser charge of heliocentrism instead of the mass problem. That way, both Galileo and the Pope escaped being charged with heresy by the Jesuits.

In 1994, Pope John Paul II officially apologized to Galileo for the Church's mistreatment of him, claiming that, "Our understanding of the world's physical structure was imposed by the literal

sense of sacred scripture.” Thus the Bible, not Aristotle got the blame. And that is supposed to have settled the matter once and for all; scientists and the Roman Catholic Church are now reconciled. Or are they?

Back in March of 1990, while the Galileo affair was still under investigation, Cardinal Ratzinger said that the church was more faithful to reason than Galileo himself, and went on to state that geocentrism is correct. Since then, Cardinal Ratzinger became Pope Benedict XVI.

Today’s scientific establishment berates the religious scientific establishment of the early seventeenth century for its treatment of Galileo. By implication we are led to believe that *they*, the open-minded keepers of scientific knowledge, would *never* do such a thing if the shoe were on the other foot. They prize themselves on being free thinkers.

So how is it that in early 2008, when Pope Benedict was to visit the Vatican’s University of La Sapienza in Rome, the broad-minded, tolerant professors of La Sapienza brought a protest letter to the Pope in January of that year canceling Benedict’s visit because of his 1990 pro-geocentric statement? By their refusal to allow the Pope free speech, the professors at La Sapienza showed the world that they are infinitely more closed-minded and intolerant than were Galileo’s critics. After all, they not only gave Galileo a hearing, they also set him up for a comfortable life by giving him a villa and a pension.²⁰

Such is the state of the Roman Catholic papacy under the leadership of today’s liberal scholastics. But that is what happens when the practitioners of science falsely so-called have control (I Timothy 6:20).*

* I Timothy 6:20— O Timothy, keep that which is committed to thy trust, avoiding profane and vain babblings, and oppositions of science falsely so called.

Galileo Versus the Bible

As for his view of the authority of the Bible, Galileo proved to be no better than any of his predecessors. In a letter which he wrote to Castelli and dated 21 December, 1613, he wrote:

It was moreover necessary in Scripture, in order that it be accommodated to the general understanding, to say things quite diverse...from absolute truth.... Hence it appears that physical effects placed before our eyes by sensible experience, or concluded by necessary demonstrations, should not in any circumstances be called in doubt by passages in Scripture that verbally have different semblance, since not everything in Scripture is linked to such severe obligations as is every physical effect.²¹

Galileo, like Copernicus, Kepler, Augustine, Aquinas, Calvin, and Origen before him claims that God does not write *absolute* truth or even truth, for that matter, in the Bible. In a letter to Dini, in the spring of 1615, Galileo wrote that Psalm 19:4 should be amended from reading "In them hath he set a tabernacle for the sun" to reading instead: "God placed his tabernacle in the sun."²² No Bible version, no matter how perverted has ever taken Galileo's version because it is totally indefensible; it is just plain wrong. About the argument that the scripture's wording must accommodate itself to popular speech, we have written before in Chapter 1.

In the letter to Dini, Galileo proceeds to "prove" that the sun is the motivating spirit and life-sustainer in the universe. This view he had in common with both Copernicus and Kepler. It is not original with any of them, for it dates back at least as far as Pliny.²³

Galileo, a Geocentrist at Last?

There is some puzzling evidence which may be construed that later in his life Galileo may have tempered his insistence on the

truth of heliocentrism. In a letter dated March 29, 1641, and written in response to a letter from Rinuccini²⁴ about Pieroni's observation of the apparent annual motion of certain stars,^{*} Galileo wrote:

The falsity of the Copernican system must not on any account be doubted, especially by us Catholics, who have the irrefragable authority of the Holy Scriptures interpreted by the greatest masters in theology, whose agreement renders us certain of the stability of the earth and the mobility of the sun around it. The conjectures of Copernicus and his followers offered to the contrary are all removed by that most sound argument, taken from the omnipotence of God, He being able to do in many, or rather infinite ways, that which to our view and observation seems to be done in one particular way, we must not pretend to hamper God's hand and tenaciously maintain that in which we may be mistaken. And just as I deem inadequate the Copernican observations and conjectures, so I judge equally, and more, fallacious and erroneous those of Ptolemy, Aristotle, and their followers, when, without going beyond the bounds of human reasoning, their inconclusiveness can be very easily discovered.²⁵

Although stopping short of overtly renouncing heliocentrism, Galileo did seem to recognize that it was not, after all, the final word of truth. This is not to say that Galileo became a geocentrist; for he indicated that the traditional geocentric theories were even less accurate than the Copernican model. Perhaps when Galileo wrote the letter he hoped that he could get back in the good graces of Pope Urban VIII.

Strangely, as though deliberately, Galileo never once referred either to the Tychonian cosmology or to the elliptical orbits of Kepler's cosmology. At the time of Galileo's death in 1642, scientists

^{*} Although he apparently did not recognize it, Pieroni appears to have observed stellar aberration a century before Bradley. See Chapter 32.

were about equally divided between the Tychonian and Copernican models; but the trend was clearly towards the heliocentric heresy.

Conclusion

Early supporters of Copernicanism relied on Greek philosophers and natural revelation for support of their Copernicanism. If theology entered the picture, it entered only to claim that God cannot lie in nature because geometry is a higher truth than divine revelation. Even the Roman Catholic Church and all Protestant denominations surrendered to the new Copernican theology.

When it comes to Scripture, the statements made by the Copernicans sound as if they all came from the same script. It is as if they had all corresponded or met together to arrive at the best ways to deflect the challenges of their opposition.

...the God-centered outlook of the middle ages had been replaced by the man-centered outlook of the Renaissance.

—Ivan King¹

HELIOCENTRISM TAKES OVER

In the first hundred fifty years after Copernicus perhaps no one individual had quite the promotional effect for heliocentrism than had René Descartes (1596-1650). Descartes promoted a vortex theory as a way to drive the planets about the sun. An electric mixer serves for an example of a vortex. As the blade whips around, the liquid is stirred up. If the bowl is not anchored, the bowl will start rotating with the mixer. Descartes viewed the blade as the sun and the earth's orbit as the bowl. A vortex is the same mechanism that Galileo claimed as "proof" for the earth's orbital motion around the sun when he noted that the sun rotates on its own axis. In the vortex theory the solar system is viewed as a whirlpool in which the planets are carried around the sun by the spin of the whirlpool. The spin of the sun in the midst of the vortex was deemed the cause of the planetary motions as well as the cause of the vortex itself.

Descartes' idea can be imagined in the following way: imagine a circular swimming pool full of still water with a basketball floating in the center of the pool. Several small ping-pong balls are floating at different distances from the basketball. Now imagine that the basketball starts spinning. Eventually the water in the swimming pool will start to circulate in the direction of the basket-

ball's spin. The circulating water will carry the ping-pong balls along with it so that these will be seen to orbit the basketball. Initially, the closer the ping-pong balls are to the basketball, the faster they will be seen to orbit the basketball.

It is, of course, impossible for one of the ping-pong balls to go around the basketball in a shorter time than it would take the basketball to spin around once; and it is at this point that Descartes' theory breaks with observed physical reality, because we know that satellites can orbit a body in less than its "day." For example, satellites can orbit the earth in about ninety minutes, which is far less than the twenty-four hour minimum period allowed by the vortex theory. Furthermore, the basketball would stop spinning long before it could start any sizable fraction of the water to circulate. This is simply due to the water drag on the ball, a phenomenon known as *friction*; but until Isaac Newton came along, Descartes' theory was the predominant heliocentric explanation for the motion of the planets, even though it was dead wrong.

Riccioli and the Craters on the Moon

Others who contributed to and supported heliocentrism during the seventeenth century included Riccioli, a Jesuit professor of philosophy, astronomy, and theology at Bologna who in 1651 published a book entitled *Almagestum Novum*. In his book Riccioli proposed a system for naming the craters on the moon. In his nomenclature, Riccioli proposed that the northernmost craters be named after ancient astronomers and that the southern ones be named for recent astronomers. At the time Riccioli published his book the Jesuits were still officially geocentrists, albeit most were covertly heliocentrists at heart. Hence Riccioli had to officially present his nomenclature in a geocentric framework; but instead of ignoring the heliocentrists altogether, he incorporated them into the nomenclature. By the way he did his nomenclature, he showed that he was truly a heliocentrist.² To appease the Catholic Church's official geocentric stance, Riccioli named the crater with the long-

est rays "Tycho" (Figure 1). Other geocentric astronomers' names were also placed in the same region of the moon. That region is mountainous and bright; in fact, it is so mountainous that it is difficult to see craters there. And so Riccioli assigned their names to oblivion.



Figure 1: *The Rayed Crater Tycho*

On the other hand, Riccioli assigned the heliocentrists to Oceanus Procellarum (The Sea of Storms) where he placed the names of Copernicus, Kepler, Galileo,* and Aristarchus. To them he assigned bright craters, craters that stood out sharply against the dark floor of Oceanus Procellarum. In fact, the name of Aristarchus, the first heliocentrist among the Greeks, was assigned to the brightest earth-facing crater on the moon. So we can see that in 1651 the opinion of the Jesuits and, by their influence, of the majority of scientists of that day, had turned away from Tycho and the Bible towards the subtle sun worship of Copernicus.

Copernican System Versus Tychonic System

In the popular press the Copernican Revolution is presented as a triumph of evidence and reason over mindless tradition and superstition; but the reality is quite different. Even though the tide of opinion swung from Tycho to Copernicus in the middle of the seventeenth century, there was no solid reason for doing so. At the

* The crater, which Riccioli originally called "Galileo", is presently called "Reiner Gamma," which is a bright crater, not the dull crater that today bears the name of Galileo.

time there was only circumstantial evidence to choose one model over the other, and that evidence actually favored the Tychonic model (see Figure 24.2). Some observations made in later years were erroneously held up as proofs of heliocentrism and continue to be held up as "proofs" into the twentieth century; but today we recognize that they are not proofs at all. Most of these so-called "proofs" came after Newton and stemmed from his work; but a few occurred before Newton; and some even set the stage for the acceptance of Newton's theories.

Among the early circumstantial evidences favoring the Tychonic model was the absence of a stellar parallax: the apparent back-and-forth motion of a star as seen against background stars which motion is due to the orbital motion of the earth around the sun. To account for this, heliocentrists had to increase the distance scale of the universe to such a size that parallax would be unobservable. This is sometimes presented as further evidence for the Copernican model, but some of the earlier Ptolemaic versions had also held the universe to be of immense size.

The argument about parallax is this: if the earth moves around the sun in an orbit some 186,000,000 miles in diameter, then at least the nearest stars should exhibit some form of parallax. The failure to detect any parallax meant either that 1) the earth stands still at the very center of either a small or a large universe, or 2) that the stars are so far away that the diameter of the earth's orbit is trivially small by comparison. For almost three hundred years the absence of a stellar parallax provided the geocentric model with an observational edge over the heliocentric ones, especially so in the 150 years before Newton, the very time during which heliocentrism took the upper hand. This serves to illustrate that the acceptance of heliocentrism was not at all based upon observational evidence but was based primarily on philosophical or theological prejudice.

Nathanael Carpenter

While the world's opinion was shifting to the acceptance of heliocentrism, there were few works by educated Christian people to support geocentricity. Most defenders of geocentricity were rather double-minded about it in that they would adhere to the immobility of the earth but would allow the earth to rotate. One such advocate was Nathanael Carpenter (1589-1628?). In his book, *Geography Delineated Forth In Two Books*,³ which was published in 1625, Carpenter argued for the Tychonic universe; but he also argued for the rotation of the earth. In so doing he repeats the error of Galileo, Copernicus, Kepler, Augustine, and Origen who deny that God really means what he writes and writes what he means, and that he does not write "true truth" in the realm of science if it is the least bit inconvenient for him to do so. Perhaps the Christian scientists of that era did not take heliocentrism seriously; or perhaps then, as now, they were blinded by the sophistry of the "church fathers" such as Augustine, unto whom most Reformers looked as a final authority in matters of faith and practice.

Proofs Against the Bible

One of the interesting side effects of heliocentrism in the seventeenth and eighteenth centuries was the notion that the moon, planets and stars (yes, and even the sun) were inhabited. This idea is reflected in the names of the lunar mare ("seas") and oceans. In fact, the "fact" that the moon was inhabited was at the time considered to be absolute proof against the inspiration and infallibility of Scripture. The reasoning was that with the moon and stars all inhabited, there was nothing special about the earth that God should pay particular attention to events here as opposed to say, the events on the moon or the giant planet Jupiter. Today we know that no place in the solar system has life on it but the earth; but in the sixteenth and seventeenth centuries the existence in the "plurality of worlds" was considered a proven fact by humanists.

Valentin Boss summarized the discord between the plurality of worlds and Scripture by using Christian Huygens as an example. Huygens was a supporter of the idea that the universe is infinite in extent and peopled by infinite multitudes of inhabited planets:

For all the apparent show of impartiality, therefore, Huygens' objectivity is defined by the nature of the "conjecture" he is trying to prove. Christianity has existed throughout the centuries on the assumption that man is the pinnacle of God's creation. If an expanded universe and the probability of intelligent beings on other worlds does not destroy the uniqueness of Christ, it certainly jeopardized Christian theology. Huygens attempts to evade this dangerous issue by circumventing religious considerations. He draws all his arguments from secular concepts or "ideas" such as reason, justice, morality, and so on. The paradox of his position is that in order to prove what *prima facie* may seem absurd, he must emphasize the absolute rationality of our own solar system.⁴

The danger to Christian thought, then, was not necessarily the idea of a large universe, but the idea of the plurality of worlds; worlds for which Christ had to die, too; at least that was how Huygens saw it.

John Wilkins

Blatant though the discrimination against geocentrists may have been in scientific circles then as now, intolerance against geocentricity is greatest in theological circles. To see how that came about we must look at the theological debates regarding heliocentrism that took place during the seventeenth century, culminating with the Protestant theologian, John Wilkins.

The theologians after Descartes and Huygens strove to endorse heliocentrism and to apologize on behalf of God and the Bible to a scientific community which was steadily becoming more humanis-

tic and thus increased in its bigotry against of the Bible and the Judeo-Christian God. The chief work of the heliocentric apologists is that of the Anglican Bishop, John Wilkins (1614-1672). Although Wilkins' work antedates that of the Newtonians, it did form the chief cornerstone of the Newtonian heliocentric arguments against the Bible. Partly this was so because Wilkins' work was not published until 1708 when Newtonianism was on the rise. Given its importance to the acceptance of heliocentrism, it behooves us to look at the work in some detail; for we will find there many of the same key elements still used by modern heliocentrists and have an opportunity to observe just how subject to the whims of fashion and time scientific theories and established opinions truly are.

Wilkins was an ardent advocate of the plurality of worlds. He believed that the moon was inhabited by intelligent beings and that other civilizations existed on other planets and stars. Wilkins wrote a two-volume treatise to present his concept of the cosmos and to counter the geocentric doctrine. In the first of his two volumes Wilkins argues for the habitability of the moon; whereas in his second volume, he counters the arguments of Alexander Ross (1590-1654), who we will meet in Chapter 25, and other defenders of the geocentric universe. All of Wilkins' scientific arguments on behalf of heliocentrism can be demonstrated as false today, and they were not even widely accepted in his own day. Unfortunately



Figure 2: *The Right Reverend John Wilkins.*

this cannot be said for his theological arguments for although they are as ill founded as his scientific arguments, they are still widely held today.

As an example of the way in which Wilkins subjected the Bible to seventeenth century science, consider his argument against Psalm 19:6. The verse reads:

[The sun's] going forth is from the end of the heaven, and his circuit unto the ends of it: and there is nothing hid from the heat thereof.

Wilkins argues that this verse has to be taken figuratively since it speaks, to quote Wilkins:

as if the sun were actually hot in itself; and as if the heat of the weather were not generated by reflection, but did immediately proceed from the body of the sun.⁵

In other words, Wilkins' "proof" against the literalness of Psalm 19:6 rested on his belief that the sun shines by reflected light and is actually a cold object, just as Philolaus had advocated about 450 B.C. Besides, if the sun were hot it could not be inhabited. No scientist today believes that the sun is cold and inhabited. All of Wilkins' arguments fall equally short of the mark, even though they employed the "best science" of his day.

Admittedly, the above example did not use the best science of Wilkins' day. As an example of an argument which does use the best science of the time, consider Wilkins' argument against the truth of Genesis 15:5 where the stars are said to be innumerable:

And [God] brought [Abraham] forth abroad, and said, Look now toward heaven, and tell the stars, if thou be able to number them: and he said unto him, So shall thy seed be.

By a simple calculation, Wilkins estimated that there are 71,209,600 stars in the universe.⁶ He then points out that there have been more Jewish and Arab people descended from Abraham than that. Today we know better; Wilkins' estimate of 72 million stars in the universe is a gross underestimate. After all, as Ecclesiastes 3:11 states: "no man can find out the work that God maketh from the beginning to the end."

In other arguments to support heliocentrism, Wilkins ignored verses of Scripture which modify the ones he holds out in support for heliocentrism. For example, he states, on the strength of II Kings 20:11, that Hezekiah's sign involved only the shadow on the sundial, and that it does not refer to any actual retrograde motion of the sun. Thus he ignores Isaiah 38:8 which expressly states that the sun moved back in its path (see Chapter 9).⁷

Wilkins also argues from history. He claims, for example, that there are no secular historical accounts of Joshua's long day and Hezekiah's sign.⁸ But as we saw in Chapters 8 and 9, there are many such accounts and, furthermore, some of these were available to Wilkins had he but searched for them.

Pi Equals Three?

Wilkins also argued from mathematics, turning to the famous "pi-equals-three-in-the-Bible" problem.⁹ This argument for an "error" in the Bible is extremely popular with scientists and theologians today who claim it as proof positive that the Bible is garbage. Since so few have argued on behalf of the Bible on this matter, it is profitable to look at the argument in detail. The relevant Bible passages are I Kings 7:23-24 as well as II Chronicles 4:2 which read:

²³ And [Solomon] made a molten sea, ten cubits from the one brim to the other: it was round all about, and his height was five cubits: and a line of thirty cubits did compass it round about.

²⁴ And under the brim of it round about there were knobs compassing it, ten in a cubit, compassing the sea round about.

² Also he made a molten sea of ten cubits from brim to brim, round in compass, and five cubits the height thereof; and a line of thirty cubits did compass it round about.

It is clear from the text that the ten cubits were measured from one

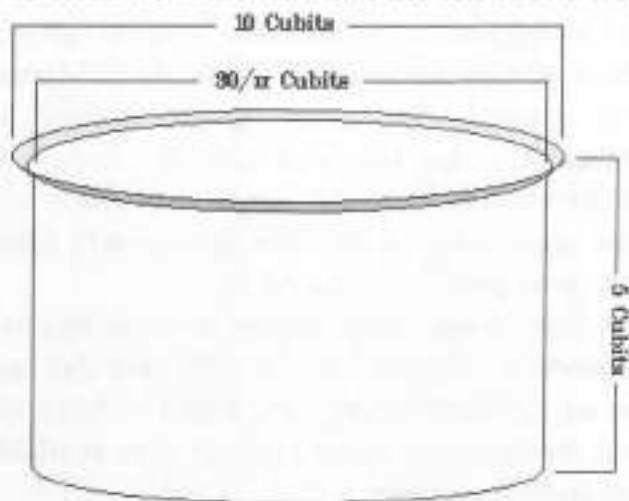

Figure 3: *The dimensions of the molten sea.*

brim to the other. Now a brim is, by definition, a type of lip which protrudes beyond the actual sides of a container. Note that the word "it," when used in the expression "it was round all about, and his height was five cubits" can refer only to the

molten sea, and not the brim. Otherwise the brim would have been five cubits high and we would have no measurement of the size of the molten sea itself. By all the rules of proper grammar, then, when the word "it" occurs the next time, it should refer to the same subject unless a different subject has been interposed. The next occurrence of the word "it" is in the clause "and a line of thirty cubits did compass it round about." Hence the body of the molten sea, not its brim, is referred to here. The picture (Figure 3) is that the brim of the molten sea was ten cubits in diameter and that said diameter extends over and beyond the diameter of the cup-portion of the molten sea which part has a circumference of 30 cubits (witness 300 knobs, ten to a cubit). This reconciles the mathematical "discrepancy" and also allows God to escape having to fill the heavens of heavens with the paper it would require to write out the

exact sizes (that is, to write out the ratio of the circumference of a circle to its diameter, π , to infinitely many decimal places). But this reconciliation Wilkins will not allow, for he flatly rejects it, without any support or analysis, by claiming:

it is a mere shift, there being not the least ground for it in the text.¹⁰

Wilkins lists many more “discrepancies” in the Bible by comparing it with natural revelation or with his own reasoning powers; but all of these he arrives at by either demonstrably faulty reasoning, poor science, or by referring to the error-riddled, Septuagint-based Vulgate which sorely disagrees in those passages with the Hebrew, Aramaic, and the Greek texts. In so doing Wilkins falls into the same trap as have numerous twentieth century advocates of heliocentrism who draw from the modern versions for support of heliocentrism without realizing that these same versions were rendered heliocentrically—original languages to the contrary—precisely to give “biblical” support to heliocentrism.¹¹ We examined this approach in Chapter 8 on Joshua’s long day.



Figure 4: *The Molten Sea of Solomon's Temple, Showing the Brim.*

Conclusion

As stated before, Wilkins' book is the most definitive work to date for heliocentrism when it comes to theological objections. Despite this, there is not a single point that Wilkins makes in his book which cannot be shown to be in error. But at the time of Newton there was no such definitive work for the geocentric case. Perhaps the most authoritative person to defend geocentricity at that time was Cassini,¹² of whom we have more to say in Chapter 25; but for the most part, authors who have written on behalf of geocentricity have compromised with the science of their day on such things as the alleged rotation of the earth¹³ or else they have argued well from Scripture but argued so poorly from science so as to discredit their biblical arguments.¹⁴ Thus it came to pass, as stated in the chapter quote, that the God-centered outlook of the Reformation was replaced by the man-centered (anthropocentric) outlook of this day. With the focus of science shifting from God and his creation, man soon forgot the warning of Leonard Euler, one of the greatest mathematicians of all time, who wrote to a German princess about Scripture and math that:

...in our researches into the phenomena of the visible world...we [are subject to] weaknesses and inconsistencies so humiliating...[that] a Revelation [Scripture] was absolutely necessary to us; and we ought to avail ourselves of it, with the most powerful veneration.¹⁵

Truly it has been said that both higher and lower critics of the Bible owe a great debt of gratitude to Copernicus, Kepler, and Galileo; for without them, challenges to the authority and authenticity of Scripture would have been much, much harder.

I will rather labor to satisfy the heavenly appearances with our other hypotheses because if I have the favor of the Author of heaven, I will work expressly for the restitution of the celestial motions that the truth may be known. This will far exceed the Ptolemaic and the Copernican systems and rather correspond to the truth itself.

—Tycho Brahe¹

24

THE RESTORATION OF ASTRONOMY PROJECT

Ironically, one man's efforts to disprove heliocentrism ended up nesting a Copernican cuckoo. The man was Tycho Brahe (1546-1601, Figure 1) and the cuckoo was Johannes Kepler (1571-1630). Born on December 14, 1546, at Knudstrup in the then Danish province of Scandia, Tycho studied at Copenhagen, Leipzig, Rostock, and Augsburg. In the course of his short life he made several important contributions to the science of astronomy. Among these is a report on the supernova (exploding star) of 1572 which, in recognition of his meticulous work, has come to be known as "Tycho's Star." Tycho was also the first man to disprove the chrystalline spheres model of the universe when his measurements showed that comets were not atmospheric phenomena but were objects further away from us than the moon. All else being equal, Tycho Brahe contributed more to astronomy than had any man before him. And all of this came about by a desire to prove Copernicanism wrong and Scripture correct.

In Tycho's mind, the Copernican Revolution destroyed the science of astronomy. His ultimate goal was to restore the geocentric astronomy and he called that the Restoration of Astronomy Project. Thus the "other hypotheses" of the chapter quote are the inerrancy of Scripture, that the earth neither moves nor rotates, and that the earth's place in the universe corresponds to its importance in Scripture.

The Early Tycho

Throughout all but the last year of his life, Tycho was characterized by severe personality problems. He was a very arrogant man, and his arrogance caused him to lose not only his nose (in a duel) but also his pension and fiefdom when Christian IV became king of Denmark. Exiled from Denmark by the loss of support, Tycho proceeded on to Rostock and Wittenberg, finally ending up in Prague. Tycho's chief contribution to astronomy was a set of meticulous observations of planetary positions. Tycho was a genius at instrumentation and his were the most accurate of all positional observations made before the introduction of the telescope. To reduce his observations to a set of formulae, Tycho hired a mathematician, a young man named Johannes Kepler.

Tycho sincerely believed Copernicus to be wrong and he hoped to disprove heliocentrism by making the most accurate observations of the planets' positions. His reasoning against Copernicus was two-pronged: Tycho objected on Aristotelian grounds but, as the chapter quote reveals to us, his prime objective was scriptural. His most important physical objection was the immense distances and incredible sizes of the fixed stars as well as the inevitable mathematical consequences of the Copernican theory.²

It was clear to Tycho that the Bible demanded geocentricity; but such was not clear to Kepler. As for the Aristotelian objections which were leveled at heliocentrism, suffice it to say that the pagan philosopher, Aristotle, is a prime example of the utter bankruptcy

of Greek astronomy. None of Aristotle's objections against the motion of the earth was the least bit sound.

Tycho's Model

Tycho Brahe proposed a refinement of the Ptolemaic model; a purely geocentric model. Tycho's model had all the planets orbiting the sun in much the same manner as Copernicus had them but in Tycho's model the system of sun and planets revolved about the earth as a coherent unit (Figure 2). Tycho first published his model in 1588 in a treatise entitled *De Mundi Aetherei Recentioribus,*

Phaenomenis; but the publication was

distributed only to his friends, and it was primarily concerned with the comet of 1577, not with Tycho's geocentric cosmology. Nevertheless, Tycho's model was very innovative in that he made the deferent of the planets all the same, namely the orbit of the sun about the earth. He then matched each planet's "epicycle" to the



Figure 1: Tycho Brahe

Nova Mundani Systematis Hypotyposis

*ab Authore nuper adinuenta, qua tum vetus illa Ptolemaica
redundantia & inconcinnitas, tum etiam recens Coperniana
in motu Terra Physica absurditas, excluduntur, omniaque,
Apparentiis Cælestibus aptissime correspondent.*

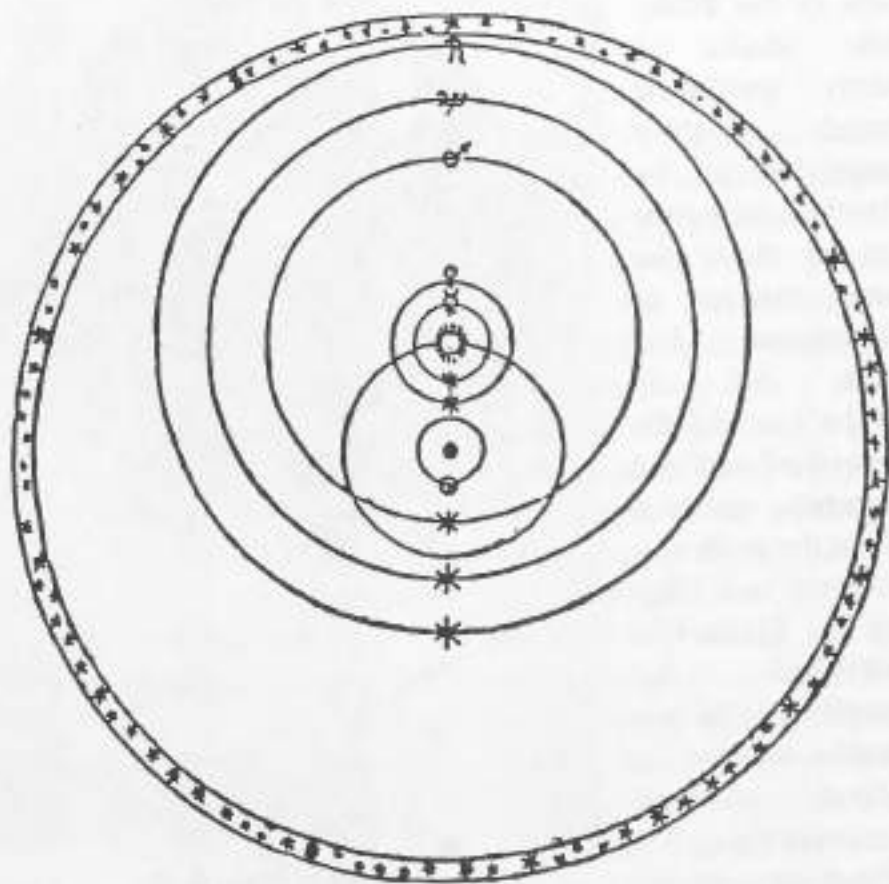

From the second Issue of the *Progymnasmatum* (1610). This diagram first appeared in Tycho's *De Mundæ Aetheris recentioribus Phaenomenis* (1588).

Figure 2: *The Tychonic Model*

planet's path about the sun. Tycho's model was the predominant model of the universe until about 1650 when Copernicus' model overshadowed his. The reason for the change of models was that by 1650 the theologians had surrendered to the Copernican heresy that the word of God should be overruled by the science and philosophies of men.

Technically, both Copernicus' and Tycho's models fit the observations equally well; and even by the time that opinion turned against Tycho's model in the 1650s, there was no solid physical proof for or against either model. The Tychonic model had observational evidence in its favor: first, our senses *see* the firmament rotating about the earth once a day; and second, even the most careful telescopic measurements failed to show the parallax, the apparent shift of a foreground star against background stars. The only argument heliocentrists presented for their model (besides arguments against the crystalline spheres model which was pagan and unscriptural in the first place) was that since the earth does not shine by its own light, it seems more likely that the earth is a planet. But this is merely an argument by analogy and is not a sound argument. After all, even back then one could argue that little of what scientists believed and avowed a century before was still believed. Nature has proven to be a much less reliable "book" than the Bible: Galileo, Kepler and Copernicus to the contrary. Even in the twentieth century Tycho Brahe's model of the universe is still among the best alternatives to heliocentrism. As Sir Fred Hoyle has put it:

We know that the difference between a heliocentric theory and a geocentric theory is one of relative motion only, and that such a difference has no physical significance.³

But back in the seventeenth century such insight was sorely lacking.

Tycho's View of Scripture

In most history of astronomy books, Tycho Brahe is bathed in a cloud of ridicule. Usually, ridicule is the last resort—short of murder—of someone who has lost the reasoning phase of an argument. It behooves us then to look at the view Tycho had of Scripture, the book of the spiritual man as well as his view of the authority of the “Book of Nature,” the book of the natural man.

It is rarely acknowledged that Tycho Brahe was a defender of the view that Scripture is the first authority while the “Book of Nature” (natural revelation) is a distant second. This is what Tycho Brahe wrote about the authority of Scripture over natural revelation:

The reverence and authority due the sacred scriptures is and ought to be greater than that of dragging them in for dramatic display. For although they adjusted themselves to the common method of understanding in physics and some other matters, yet let it be far from us to think of them as speaking in *such* a common manner that we do not believe them to be speaking truth. Thus, Moses, even if he does not refer to the deep things of astronomy when treating the creation of the world in the first chapter of Genesis because he is writing for the common people, nevertheless does introduce that which our astronomers can concede.⁴

Taken out of context this quote may not seem strongly supportive of the premise that scientific theories must conform to scriptural statements where they overlap. In the example Tycho gives he defines the adjustment “to the common method of understanding” as a limit to the *depth of understanding* imparted by the Author of Scripture. The occasion for the quote is a letter to Christopher Rothmann who suggested to Tycho what is now the modern view, namely, that Scripture has no relevance to the question of the earth's motion. Kenneth Howell comments on Tycho's statement:

Rothmann had claimed that the biblical language was gauged to the understanding of common people who did not have access to esoteric astronomical knowledge. It cannot therefore be expected that the Bible will yield information which will be helpful to the astronomer. Tycho's response admits that the Bible uses a common method of description in scientific matters but that this does not imply that its words must not be taken seriously. For Tycho this would be treating the Bible as if it were simply another human document which need not be taken authoritatively when speaking about astronomical matters.⁵

Tycho Brahe's words and faith in Scripture stand in stark contrast with those of the heliocentrists who spare no opportunity to strip Scripture of any authority in the realms of nature, philosophy, and history. Copernicans wanted to confine the authority of Scripture only to the realm of the spiritual and supernatural, and even these they soon took away. Francis R. Johnson explained the reasoning behind their stance:

The mystical attitude which saw God as the great geometer and looked upon the mathematical harmonies to be found in the material world as direct revelations of the Deity, also had its roots in Platonism, and was the source of the inspiration of the wonderful workmanship of the Creator.⁶

For two hundred years now, the chief paradigm of science has been to eliminate all knowledge of God from science and to confine Scripture to the realm of superstitious mythology. Secular, anti-Christian men on control of science do this because they believe that the mathematics they see in nature do not apply to the spiritual realm. In this they are sadly mistaken, but in their ignorance of the nature of spirit they cannot apprehend the complex aspect of creation ("let him that readeth understand" —Mark 13:14), for there

are more things in heaven and earth, dear skeptic, than are dreamt of in your philosophy.⁷

Tycho in History

Tycho Brahe has a reputation of arrogance, irascibility, and stubbornness, say historians. Yet his friends acquaintances said he was kind, gentle, and charitable; easy to befriend. On his deathbed he charged his family to be charitable. It is clear that when it comes to Tycho's personality history has chosen to side with the reports of Tycho's enemies instead of the accounts of those who knew him well.

In order to disprove Copernicus and prove the geocentric universe, Tycho not only marshaled every bit of astronomy to his aid but also every discipline of science including alchemy (now called chemistry) and theology. Tycho's focus won him many enemies, some even in high places, but he had family connections that could stay his enemies' hands. Such was his temper.



Figure 3: *Tycho in His Observatory*

Tycho spared no expense in fulfilling his astronomical goals. He built an observatory on the Danish island of Hven and equipped it with large instruments used to measure angular distances between the stars. His equipment was the best ever built in the era of naked-eye astronomy. His goal was to make accurate measurements of the planetary motions and positions of the stars to once and for all eliminate the heliocentric system.

The Death of Tycho: First Version

It seemed likely that such a proud man would suffer the fate many historical texts assign him. Indeed, because of a political conflict he was exiled from Hven to Prague where he was appointed Imperial Mathematician to the emperor Rudolf II. The story goes that during a banquet hosted by Peter Vok Ursinus Rozmberk, Tycho drank too much and, having to hold it in because leaving the party was considered rude, he did not leave until it was too late. He took ill with fever and attacks of giddiness and suffered for ten days until 24 October 1601 when he died of urinary poisoning. At the end, when his suffering lessened, he gathered his family about him and they sang hymns, prayed, and he charged them "to have care of all those in want without distinction" and to live piously and honorably. Tycho bequeathed his log books and instruments to his heirs, hoping that the sale of them would make up for the money that Emperor Rudolph owed him and had no intention of paying. Tycho died at Benatky, the story goes, after a long history of bladder trouble.

If the above account of Tycho's death seems incongruous with Tycho's rough reputation, perhaps this is the cause. A year or so before his death Tycho had a change in personality. Much to the amazement of his associates, including Kepler, the arrogant and volatile Tycho Brahe diminished; he was a changed man. Tycho's change of behavior has all the earmarks of a new-birth experience, and there is further circumstantial evidence in support for that conclusion. If so, then of all the intellectual "giants" who fought the

great geocentric debate that first century, namely: Copernicus, Kepler, Tycho, and Galileo; Tycho Brahe was the only practicing Christian in the group. (We presented Kepler's and Galileo's opinions of the authority of Scripture in Chapter 22.)

A couple of months before his death, Tycho had introduced Kepler to the emperor who, upon Tycho's recommendation, hired Kepler as mathematician. Kepler, however, considered that a fate worse than death for, as he put it, he was himself a "fierce hater of work" and he would now have to work for his salary. Thus Kepler despised Tycho's gift of the emperor's support. To Kepler it meant giving up his grand cosmological ambition; he needed Tycho's observations but Tycho, who had been burned before by being too generous with his data, played that card close to his vest; too close, as far as Kepler was concerned.

Indeed, Kepler had not been earning his keep for some time. Kepler spent much of his time traveling to obtain academic or clerical positions and to amass third party support to force Tycho into giving him the data he coveted and considered his own. Tycho had already loaned Kepler the data for Mars, but that only whetted Kepler's appetite. Kepler dismissed the 54-year old Tycho as too old to make meaningful contributions to "the restoration of astronomy," as Tycho called his quest.

Summoned to Tycho's deathbed, Kepler promised to present his mentor's observations in light of the Tychonic model. Johannes Kepler did publish Tycho's observations posthumously in 1602 as part of Kepler's own *Astronomiae Instauratae Progymnasmata*, but Kepler did not entirely keep his promise to Tycho; for although the Tychonic model was mentioned in the book, and although the observations were basically presented in the Tychonic setting, Kepler insisted on including a footnote stating that his personal preference was for the Copernican model. Despite Kepler's disavowal, the Tychonic cosmology rivaled Copernicanism until about 1650.

The Death of Tycho: Second Version*

For centuries, Tycho's biographers reported variations of the first version of his death. Most of these ignored or downplayed the suspicion widely voiced across Europe at the time that the Great Dane had been murdered. But in 1991 and in 1996 strands of hair from Tycho's beard and head were analyzed by modern forensic techniques and the suspicion that he was murdered was resurrected.

On November 4, 1601, Tycho's body was laid to rest. Tycho's friend, Dr. Johannes Jessenius delivered the oration. He gave a biographical sketch which praised Tycho for his excellence of character, his kindness to strangers and the poor, and the strength of his faith. As a friend, Jessenius described Tycho as easily befriended, who did not hold grudges but was ever ready to forgive. He also spoke of the plagiarism of Tycho's Tychonic system by Ursus, and the state of the family at Tycho's "unexpected death." Before the nobles and people of Prague, Jessenius described Tycho's equipment and the record of his observations which Tycho had left to his heirs but which were still with "Master John Kepler, within whose hands all these have remained so far."

Jessenius described Tycho's fatal illness. Tycho had experienced no symptoms of illness prior to the night of the banquet. During the banquet he grew increasingly ill. Now it is important to note that since Tycho had no symptoms, there is no reason for him to medicate himself with any product containing lead or mercury. Once home he went straight to bed with a raging fever and excruciating pain. For most of a week he lay in agony, passing in and out of delirium. At the end of the week he started to regain his robust health. It was then that he willed his data to his family. The following morning he was found dead. Because of Tycho's physical strength and lack of prior illness the rumor that he was poi-

* The forensic evidence and details are taken from the original 1996 announcement of the analyses conducted on hair from Tycho's beard and head by the Laboratory of Forensic Chemistry in Copenhagen (beard analysis) and Lund Nuclear Microprobe facility at the Lund University, Uppsala, Sweden.

soned spread throughout Germany and reached as far as Norway. At 54, Tycho was still considered young even as a 54-year old is still regarded young today.⁸ (The longevity rates in Tycho's time were low because of the high incidence of child mortality and also because the Little Ice Age was at its coldest which, with the concomitant dampness, really boosts the mortality rate.

Upon Tycho's death, Kepler fled Tycho's house, taking with him all Tycho's logbooks representing forty years of Tycho's work. Tycho had willed all his works to his family. Kepler, however, coveted the observations and desired to have them as his own. Tycho had loaned Kepler the observations of Mars,⁹ but Kepler vehemently coveted the rest of the observations, to which Tycho had promised him access but had withheld thus far, probably because of Kepler's vehement insistence and his unwillingness to return even a single sheet of the Mars data. Having been burned once by Ursus, Tycho wanted to be certain that Kepler would not steal them. The more Kepler tried underhanded ways of obtaining what was promised him before Tycho was ready to give it, the more Tycho's suspicions arose and the more he delayed in fulfilling the promise.

It is clear that Kepler was to have access to the data that he stole because of the promise the dying Tycho elicited from him to publish the results using the Tychonic model, but Kepler wanted more than access to the data; he wanted to own it. With the rationale of a thief—"It's mine because Tycho owes it to me,"—Kepler absconded with the books. Kepler never fully returned them, no matter what the courts said and no matter the pleas of the rightful heirs. Thus was the integrity of Johannes Kepler.

Tycho's Tomb is Opened

In 1901, on the three hundredth anniversary of his death, Tycho's tomb was opened. At the time, Prague wanted to restore

⁸ Because it is the easiest planet to follow, Tycho's Mars data constituted the best and most complete data he had on any of the planets, thus it was his most valuable possession.

the sepulcher and investigate a long-standing rumor that Catholic insurgents had removed Tycho's corpse in 1620 when the Roman Catholic Church conquered Bohemia. When the tomb was opened in 1901, it held male remains with part of his nose missing, but no gold and silver nosepiece. It also held remains of a female, presumably Tycho's wife, Kirsten, who died in 1604 and was buried "next to her husband." Since no bladder stone was found in the sarcophagus it was clear that one report of the cause of Tycho's death was wrong. It was the German doctor, Johannes Wittich who said that Tycho died of urea in the blood because he could not pass a bladder stone. Wittich is also the source of the burst-bladder explanation for Brahe's death. We now know that the bladder cannot burst. While Tycho's body lay exhumed, a sample of Tycho's beard was taken and stored in what is now the Czech National Museum.

In 1991 there was a Danish flag ceremony over Tycho's crypt in the Teyn Church in Prague. The newly appointed Danish Ambassador to the Czech Republic attended the ceremony. The director of the Czech National Museum took the occasion to present to the ambassador a small wooden box, a gift to the Danish government. In the box were a piece of Tycho's shroud and the exhumed remains of his beard. A note explained that the objects originated from the 1901 exhumation.

When the box arrived in Denmark, Claus Thykier, the director of the Olé Rømer Museum in Copenhagen arranged for the beard remains to be transferred to the Institute of Forensic Medicine at the University of Copenhagen. The goal was to shed some light on the persistent rumors that Tycho had been poisoned. An atomic absorption analysis was conducted on the beard and tested for the presence of arsenic, lead, and mercury. The laboratory made a startling discovery; during the same time in which the dinner party took place, Tycho ingested a massive dose of mercury that left deposits in his hair at a level 100 times normal levels. That was enough mercury to kill all but the healthiest individuals. Strong support was lent to the ancient charge that Tycho was murdered,

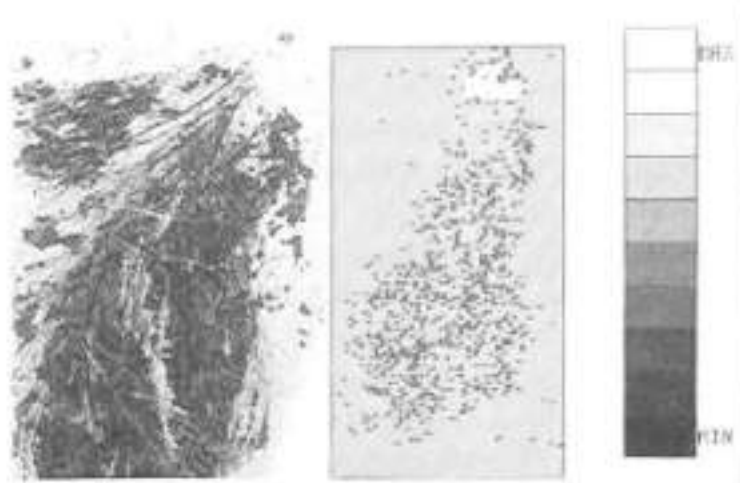

Figure 4: At left is a picture of Tycho's beard collected in 1901. At right is a plot of the amount of mercury in the beard. See text for an explanation of this graphic.

for although Tycho's medicinal concoctions involved mercury, the mercury medicines he sold did not contain any fatal mercury salts, at least not in the finished product. Figure 4 plots the amount of mercury in or on Tycho's beard from the atomic absorption analysis. The white area shows a region in the beard with an extremely high concentration of mercury, a hundred times normal. The mercury showing there was ingested at the time of the party and spread over the next week or so. It is not the lethal dose.

Five years later, in 1996, which marked the 450th anniversary of Tycho's birth, a second analysis of Tycho's hair was undertaken. At the time, the Landskrone Arts Museum, located near the city of Lund, in Sweden, was having a Tycho Brahe exhibition. The museum loaned some of Tycho's hair to the Lund University to conduct a refinement of the 1991 Copenhagen atomic absorption analysis. The problem with atomic absorption analysis is that it cannot accurately pinpoint the location of the elements in the hair so that it could not give an accurate time-line as to when the foreign substances were introduced.

Contrary to popular belief, hair does not continue to grow after death. It stops growing at the moment of death. Knowing the rate

of growth of a hair, if the hair still has its root, the time between introduction of the mercury into the hair and the death of the individual can be determined. Thus in 1996, the hairs were transferred to the Lund Nuclear Microprobe facility at Lund University where Jan Pallon analyzed them by microprobe analysis (PIXE, short for particle-induced X-ray emission). The microprobe tells which elements are present in the sample, and also where each element is located. Several hairs were searched for the presence of lead and mercury. Jan Pallon reports on the result of one particular hair:

One of the hair strands, which also contained the hair root, exhibited a very high local concentration of mercury (Hg). The location of the mercury was close to the hair root. Careful investigations of the Hg-distribution across the hair strand also shows that Hg is situated inside the hair. The origin of the Hg must thus be the blood, from which it was rapidly built into the growing hair. Studying the Hg-concentration along the hair from the root towards the tip is then actually a study in time; as the hair grows with constant speed the distance from the root can be converted to time. It can also be seen that the raise in concentration of Hg was very quick, maybe five to ten minutes. The same is true for the fall-off, which is in accordance to the known high metabolism of the hair roots. (This has been verified in experiments where radioactive tracers were distributed to mice, five to fifteen seconds later the radioactivity could be seen in the hair of the mice.) Assuming that the hair was growing up to the point of death, the Hg must have been given to Tycho Brahe only one day before he died. The Hg-exposure had a duration of less than one hour.⁹

The plot of the PIXE analysis (Figure 5) shows that the mercury spike occurred about thirteen hours before Tycho's death. That spike was in addition to the spike of mercury discovered in 1991, which was associated with the feast. The time, a week earlier, is off the chart to the right.

The forensic evidence gives a different story about Tycho's death than the story reported in the history books. The first attempt to kill Tycho was done at the banquet with what is normally a lethal dose of mercury. The poison took effect right away but failed to kill Tycho. He suffered for eight days and showed significant recovery on the ninth day. But on the evening of the tenth day he was poisoned again, this time without hope of recovery. His organs shut down as he slept and died the morning of the eleventh day.

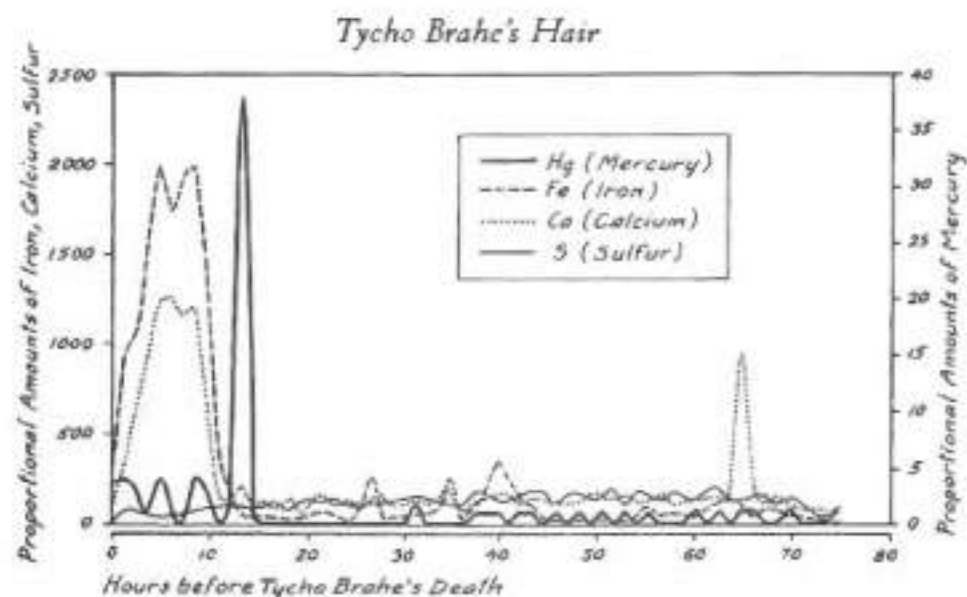

Figure 5: The amounts of mercury (Hg), iron (Fe), calcium (Ca), and sulfur (S) along the length of the hair with the root attached.

Who Did It?

At this time there are three explanations for Tycho's death. The one that is most common is that he accidentally took a fatal dose of mercury for a bladder or prostate ailment. For a man of Tycho's experience with mercury production (he sold the medicines he made), it seems highly unlikely that he would overdose on mercury since the only mercury medicine he would take would be

the end product of one of his recipes. The end products were not poisonous, but some of the stages in their production involved poisonous salts. Even a small amount of liquid mercury can pass through the intestinal tract without anything more than a laxative effect. Indeed, for centuries liquid mercury was used as a laxative. The ancients were not ignorant of the benefits and dangers of mercury, although the EPA is supremely ignorant of the knowledge of the ancients not only in that field but most everything else, too. The accidental poisoning of Tycho Brahe is unlikely enough, but for it to happen twice ten days apart strains credulity.

This leaves the most likely option, that Tycho was murdered. Who would have reason to want Tycho dead? There are three who would: the Roman Catholic Church, the king of Denmark, and Johannes Kepler.

The rationale behind the proposal that the Church of Rome killed Tycho is that Tycho had a strong influence on the emperor Rudolf who is depicted as weak-willed and silly. The motive is that if Tycho were dead, Rudolf would abandon Protestantism and support the Roman Church. The theory is not the least bit credible, however, because a weak emperor would not have taken Tycho's advice against the powerful Jesuits who are masters at overthrowing governments. All that is under the assumption that Rudolf was a Protestant, which he was not. James A. Connor, in his book, *Kepler's Witch*, wrote this about Rudolf:

Although Rudolf was a strong Catholic and promoted the works of the Jesuits and the Capuchins in his kingdom, he preferred peace and was at heart more concerned with the occult, with piercing the veil of the mystery of life.¹⁰

Thus, by the testimony of a former Jesuit priest, Rudolf was not influenced by Tycho, or Kepler for that matter. Else why would both of them have problems drawing their promised salary from the emperor?

The second suspect was Tycho's beloved cousin, Eric Brahe, who was visiting the Brahe family at the time of Tycho's death. When King Friedrich II of Denmark died, his son Christian IV ascended to the throne. Although King Friedrich had been a friend of Tycho, King Christian was not. Christian believed that Tycho had an affair with his mother and that possibly Tycho was his father. As a result of Christian's antagonism, Tycho was forced to leave Denmark, moved to Prague, and became mathematician to Emperor Rudolf II. Christian IV is believed to be the Hamlet in Shakespeare's play, although an earlier Danish king is also a possible, and in my opinion a more likely candidate for Hamlet, given that the play, "Hamlet" was written especially for the state visit by the king of Denmark to King James I.

In a press release dated January 23, 2009, Peter Andersen of the University of Strasbourg reported that he found the diary of Count Eric Brahe, who was not only Tycho's cousin but also a Swedish diplomat in the service of the Danish crown. The diary records many meetings with the king's brother, Hans, on whose order, it is thought, Eric Brahe went to Prague to poison his cousin. However, a suspicion by the king and correspondence with the king's brother does not mean that Eric Brahe murdered his cousin. Apparently the diary does not mention the murder directly. Professor Andersen believes that Tycho "ingested a large quantity of the liquid* metal about thirteen hours before his death, coinciding with the visit from his cousin."¹¹

The third person who would profit from Tycho's death is Johannes Kepler. Although Tycho viewed Kepler as a friend, Kepler despised Tycho. Kepler viewed Tycho as an impediment to Kepler's glory and destiny. Kepler boasted of stealing the "golden vases of the Egyptians" in the introduction of his 1619 work. The reference may be an allusion to Tycho's observations that Kepler stole from the family after Tycho's death.

* I have my doubts about "a large quantity of the liquid metal" when the fatal salts would be easier to disguise.

It is, of course, impossible to know for certain who murdered Tycho. What makes it even more difficult today is the confused reporting of the mercury evidence. I have tried the best I can from both the resources I have on hand and those found on the Internet to give a clear history of the discovery of the poisoning. Most reports mention the PIXE analysis but illustrate it with the atomic absorption analysis. As a result most authors mention only the last poisoning as if it is the only piece of evidence and the only dose Tycho ingested. Also, Kepler is almost never mentioned as a suspect even though he had the most to gain from Tycho's death. Most writers allow only the accidental poisoning. Those who do so do not report the double poisoning. As it stands now, it looks like Kepler is the most likely suspect, but it is clear that reasonable doubt exists for all three "suspects." The death of Tycho also illustrates the depth of emotion that accompanied the debate between Copernican heliocentrism and Ptolemaic geocentrism at the time of the Reformation.

The Tomb Reopened

On 15 November 2010, a research team consisting of Danish and Czech academics opened the tomb and again exhumed Tycho's body. The team was led by Aarhus University's assistant professor of archaeology, Jens Velle. Velle's private goal, which I surmised from various press releases, was to exonerate Kepler. His stated goal was to look for more conclusive evidence as to the cause of Tycho's death. They also took samples of Tycho's wife's remains.

A year later, in November 2011, the group reported the work was stalled for lack of funds. However, on 15 November 2012, a press release announced the publication of the first results of the 2010 exhumation. I have a preprint of the paper which was accepted for publication on 13 August 2012. The senior author is Kaare Lund Rasmussen, Associate Professor of Chemistry at the University of Southern Denmark. The paper lists ten authors.¹²

The paper concludes that no lethal trace of mercury was found in either Tycho's hair or bones. They do report a "slight increase" in the abundance of mercury near the root of one hair sample and conclude that it may

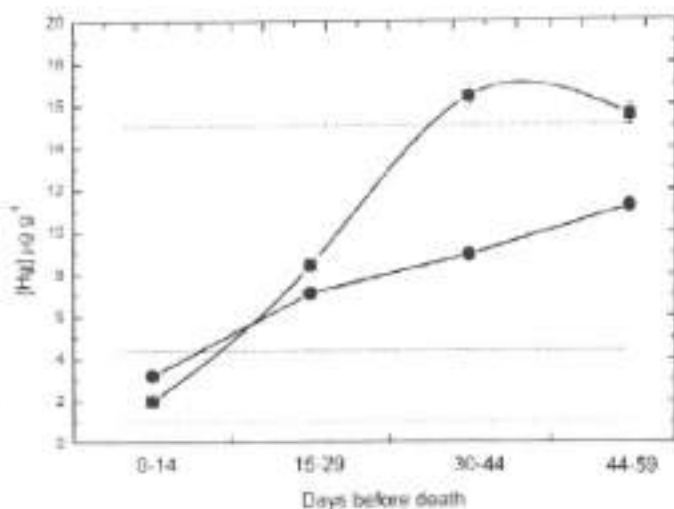

Figure 6: *The 2010 Exhumation Results*

have been self-medication just before his death or else possible embalming with a medium containing mercury but the dose is non-lethal.

Clothes with mercury traces on them are said to be responsible for the 2004 PIXE result. However, no mention is made of the 100 times normal abundance of mercury of our Figure 4. There is no way I know of that clothes that contain a mercury abundance that falls within the normal range for humans can contaminate root hairs by a factor of 100. The spike in our Figure 5 is also ignored, albeit the 1991 and 2004 papers are referenced.

Finally, Rasmussen's Figure 2 (here reproduced as Figure 6), plots the results of the 2012 PIXE analysis. It corresponds to Figure 5 but instead of a continuous trace spanning three days, it spans 59 days with **only four data points!** Figure 5 spans only the one fifth of the distance between the leftmost points (0-14) and the left edge of the Figure 6. The result nearest the hair root is the average of Tycho's last 14 days! The cutting of the hair into 5-mm lengths and then averaging the mercury concentration within that length makes one highly skeptical of Rasmussen and company's credibility. Not only that, but Rasmussen et al. dismiss the direct experi-

mental evidence of our Figures 4 and 5 as “speculation.” That may fool the media, but it lacks the ring of scientific truth.

Given such results, I cannot dismiss the second version of Tycho’s death on the basis of Rasmussen’s analysis. Given the lack of sufficient evidence to the contrary, I have no choice but to retain the second version of Tycho’s death as the most likely version or, at least, as a feasibility.

Conclusion

Although Aristotelian cosmology played a role in Tycho Brahe’s Restoration of Astronomy project, Scripture played the predominant role. Tycho’s goal was to conform the science of astronomy to the geocentric view of Scripture. He did that by building large and accurate instruments, developing new observational techniques including the addition of Nunez scales* to his instruments. Tycho then set about to make the most accurate naked-eye measurements ever of planetary positions and positions of other stellar bodies.

To convert his data to test his model of the solar system, Tycho hired Johannes Kepler. Upon Tycho’s death, Kepler stole Tycho’s observations and used them to refine the data on the planetary orbits. However, the observations were not accurate enough to reveal Mars’ orbit to be elliptical, but they did allow Kepler to formulate his three laws of motion. Generally, Kepler’s laws are thought to prove the Copernican system, but that is not the case. Witness that Tycho’s model of the solar system was the predominant model until circa 1650 when the Copernican model took over. At that time, the evidence—particularly the absence of parallax—favored Tycho’s model given that there was no observational evidence to support the Copernican model.

* Nunez scales were an early version of the vernier scale in use today to squeeze an extra digit of accuracy from a measurement. Mathematician Pierre Nunez (1492-1577), invented the Nunez is the most likely source of Tycho’s “vernier” instrument.

In particular, the modern crusade to discredit the Bible had its roots in the Church-astronomy controversy over geocentrism.

—Avi Rabinowitz¹

GEOCENTRISTS FROM 1650 TO 1950

Modern geocentricity was born in 1967. That does not mean, however, that there were no defenders of the geocentric universe between the general acceptance of heliocentrism in 1650 and 1967. Most geocentric defenders were such because they clearly saw that the infallibility of Scripture requires earth's stasis and that advocacy of the heliocentric view undermines the absolute authority of the Bible, even as theoretical physicist Avi Rabinowitz noted in our chapter quote. Those geocentrists were defenders of the stability of the earth because of Scripture, and overall they were sound in their defense of the geocentric view when arguing from the Bible. However, the geocentric advocates rarely understood the subtleties of the scientific arts underlying the heliocentric model.

The Cassinis²

The most capable geocentrists between 1650 and 1830 were a family of astronomers who directed the Paris Observatory. Their story starts with Giovanni Domenico Cassini (1625-1712). Born in Italy and educated by Jesuits, Cassini was appointed professor of astronomy to the University of Bologna in 1650. Among his



Figure 1: *Giovanni Cassini in Bologna.*

achievements were the discovery of four of Saturn's moons and the division in Saturn's ring known as the Cassini division. Certain oval curves that Giovanni proposed to replace Kepler's ellipses for geocentric planetary orbits are called, *Cassinis*. Whereas an ellipse is the locus of all points such that their sum of its distances from the two foci is constant, in a Cassini oval the locus of all points is such that the product of its distances to the foci is constant.³ In 1669 King Louis XIV appointed Cassini to the directorship of the new Paris Observatory.

Pope Clement IX was not pleased with the appointment but relented on the grounds that it be temporary. Cassini became a French citizen two years later and a dynasty was founded. While at the Paris Observatory, Cassini was involved in the first successful determination of the speed of light.

In 1712, Giovanni Cassini died and the directorship of the Paris Observatory passed to his son, Jacques Cassini (1677-1756). He wrote several treatises on astronomy. One reported on a determination of the size of the earth and another presented the first tables predicting the positions of the satellites of Saturn.

Jacques Cassini was succeeded in the directorship of the Paris Observatory by his son, César François Cassini (1714-1784). César focused on the surveyor responsibilities of the Directorship and in 1744 began construction of a great topographical map of France.

Upon César Cassini's death, the directorship passed to his son, Jacques Dominique Cassini (1748-1845). In 1793 he completed his father's map of France. Jacques' plans to renovate the Paris Observatory were ruined by order of the National Assembly in 1793. He was forced to resign his directorship and subsequently thrown into prison for seven months. Upon his release he retired to Thury where he wrote until his death at age 97.

Jacques Dominique Cassini's fall from grace was due to his loyalty to King Louis XVI, a victim of the French Revolution, which revolution was one of several that was spawned by the atheistic-humanistic view of science induced by the Copernican Revolution. The history of astronomy written by Jacques' co-worker (on the project which came to determine the length of the meter), Jean Baptiste Joseph Delambre (1749-1822), exhibits much hostility against the Cassinis, probably for their geocentric stance, which even today still flies into the face of the advocates of political revolutions, and also because such criticism endeared Delambre to the revolutionaries who promoted him.

Nineteenth Century German Geocentrists

In the latter half of the nineteenth century there was among the German intelligentsia a resurgence of the geocentric model; Tycho's in particular. Like the Cassinis, this was a secular movement with rarely any reference to the Holy Scriptures or even theological or philosophical matters.

The resurgence was fueled by improvements in the telescope, which exposed orbital behavior that appeared to violate Newton's law of gravity. Two particularly hard problems were the perihelion precession of Mercury and star streaming. The latter was discovered by William Herschel, who observed that the stars appeared to stream past the earth, which he interpreted to mean that the sun was most likely not at the center of the universe. Then, too, there was the mystery of how a comet's tail could defy gravity and point away from the sun.

The most significant of these problems was the perihelion precession of Mercury discovered by Urbain Jean Joseph Leverrier (1811-1877) in 1859.⁴ Leverrier discovered that the entire orbit of Mercury was rotating with respect to the stars and that its rotation speed was faster than could be accounted for by Newton's law of gravitation. The discovery was not the surprise that it is made out to be. Newton had solved the same phenomenon in the moon's orbit (perigee motion) in detail in his 1686 *Principia* Book I, Section IX. Likewise, Newton provided a dynamical solution of the so-called "*anomalous motion* of the planet Mercury in 1687, long before its discovery by Leverrier.⁵ Newton's gravitational force formula was not the usual inverse square but contained an additional additive term (an inverse cube term) accounting for the earth's oblateness.

Despite Newton's accounting for the phenomenon, astronomers of the nineteenth century through Einstein, and even to this day, are generally of the mistaken opinion that Newton's gravity cannot account for the precession, also known as the *perihelic rotation*. As a result, after Leverrier's discovery some advocated the abolition of action-at-a-distance theory of gravity. By that is meant that Leverrier's followers no longer believed that gravity was due to attraction between two bodies but due to a pressure in the ether, which pressure is due to particles flowing in all directions through space. Each body absorbs some of the particles, shielding its neighbor from the full flux of the particles, thus creating a pressure that pushes them together. Others advocated the total abolition of gravity and looked to the promising new field of electro-magnetic theory to provide the force needed to keep the solar system together.

Insofar as star streaming was concerned, the greatest difficulties for geocentrists arose from an inability to see the proper geometry of the solar system in such a stream. This led some geocentrists to claim that centrifugal force was no longer needed. As for the comet's tail, today we know that light hitting dust particles will push the particle, so the fine dust in a comet's tail, will be pushed

away from the sun by the impact of light on the dust. Today that phenomenon is called *radiation pressure*.

In any case, German astronomers and physicists took a hard second look at Tycho's model and gave serious attention to it. However, by 1885 the ruthlessly totalitarian humanist-evolution revolution with its theological co-conspirators, namely the higher and lower critics of Scripture, led to a *de facto* banning of absolute truths from all "recognized" scholarly disciplines. Thus they suppressed the "second look" at geocentricity.

In 1900 the German geocentric debate was taken up in the United States, but although it enjoyed a short time of popularity, the climate that banned serious consideration of the stability of the earth in Europe entered the United States and all questioning of the mobility of the earth or the 6,000-year old universe was ridiculed off the stage. (Ridicule is the critics' only recourse, for after Relativity there were no longer any sound, physical arguments against the Tyconic model or against a 6,000-year-old universe.)

We shall now examine the principal men and ideas that made up the nineteenth century geocentric movement. We begin in Germany.

Johann Heinrich Kurtz (1809-1890)

Kurtz's first book was *Die Astronomie und die Bibel. Versuch einer Darstellung der biblischen Kosmologie, sowie einer Erläuterung and Bestätigung derselben aus den Resultaten und Ansichten der neueren Astronomie* (Mitau, 1842); in later editions the book was considerably enlarged and the title was changed to *Bibel und Astronomie, nebst Zugaben verwandten Inhalts. Eine Darstellung der biblischen Kosmologie und ihrer Beziehung zu den Naturwissenschaften* (5th ed., Berlin, 1865; Eng. transl., *The Bible and Astronomy*, Philadelphia, 1857). Kurtz's work shows the great interest Kurtz took in natural science. He tried to prove the central position of the earth in the history of the universe and show how

the universe is connected with, and subordinate to, the progress and completion of man's salvation.

In the latter half of the nineteenth century, Kurtz succumbed to the intellectual foppery of higher criticism. No mention is recorded that Kurtz ever recanted of his geocentric position, however. Indeed, his fifth edition was published well into his wandering into theological liberalism.

August Tischner (1819-?)

Tischner was not so much a geocentrist as he was an anti-Copernican. He accepted the rotation of the earth and believed that the earth was drawn through space with the sun. Even so, Tischner's publications provided fuel for the geocentric fire.

Not much is known about August Tischner beyond what he wrote in his two surviving books. His most overtly anti-Copernican book was published in 1885 under the title of *Sta, Sol, Ne Moveare*.⁶ Apparently, Tischner also published an English and possibly a French translation of the book, for in the same year and from the same publisher, there appeared an English version of the book under the title, *The Fixed Idea of Astronomical Theory*.⁷

Tischner's main argument against the Copernican model is based on Sir William Herschel's discovery of star streaming. Today astronomers associate star streaming with the sun's motion around the center of the Milky Way. The modern view did not come into focus until the early twentieth century, however, so Tischner and his contemporaries did not know the nature of star streaming. Tischner's objection was that if the sun streams through the stars, then the sun is moving.⁸ If the sun is moving, then why, asks Tischner, do Copernican astronomers insist that the sun is not moving and, indeed cannot move? That is the essence of his "fixed idea" of astronomy. Tischner more or less accurately concluded that if the sun is in a stream with other stars, the orbits of the planets are helixes instead of closed ellipses. From that he concluded that there is no such thing as centrifugal force. Tischner

did not, however, understand the nature of the sun's motion through space or, how the solar system looks to stars streaming past the earth. Tischner envisioned the planets' orbits as forming a cone that trailed behind the sun like the tail of a comet trails its nucleus. This error persisted in most of the German-based geocentric models until the 1930s.

In the final analysis, Tischner was not a true geocentrist, but he was a true anti-Copernican. To this end, Tischner starts his book with the following clarification:

We do but reject the present astronomical view of the world along with the Copernican hypothesis. According to the hypothesis of Copernicus, the sun is fixed in the centre of the universe; observations prove, however, that he is not fixed, but moves. Now, if we know, that the sun moves, why are we always to treat him "as at rest?" On this account astronomers are bound to give a rational explanation.⁹

In other words, no astronomer truly believes the Copernican hypothesis any more. The sun is not at the center of the universe; indeed, it is not even at the center of the solar system. Copernicus and Galileo were dead wrong in their insistence that the Copernican model was proven. Today, the Copernican model has been totally invalidated on all counts. The same was true in Tischner's day but no one admitted it.

The most interesting and significant part of Tischner's book is the section that presents the opinions on Copernicanism of several of the leading German scientists of his day. An unnamed doubter of the Copernican model travels about seeking the opinions of prominent intellectuals. Although Tischner's doubter is not identified, we find several of the same recollections in Schöpffer's writings where they are told in the first person. Perhaps some are Tischner's interviews and others are Schöpffer's. Those reported by Tischner are: Alexander von Humbolt, Johann Encke, Karl von Raumer, and Johann von Lamont, and Karl Gauss. Their stories follow.

Alexander von Humboldt (1769-1859)

Alexander von Humboldt was a German, born in Berlin, and a famous naturalist. He is best known for his exploration of Latin America; indeed, Darwin's journey to South America and the Galapagos Islands was designed to profit from von Humboldt's popularity. In the process of his explorations, von Humboldt founded the field of biogeography and wrote a five-volume set of books, collectively called the *Kosmos*, which covered all the sciences.

The following interview with von Humboldt is reprinted with minor changes from Tischner:¹⁰



Figure 2: Alexander von Humboldt.

One who doubted the possibility of the Copernican system desired to be enlightened about it, and went to Alexander v. Humboldt, who was indeed ever the first refuge of those seeking information, and was, too, so complaisant that he sent nobody away, that he even conscientiously answered each letter. The visitor was cordially received by Alexander v. Humboldt,

and when he laid before him his doubt about the Copernican system, got for answer the memorable words: "I have known, too, for a long time, that we have no arguments for the Copernican system, but I shall never dare to be the first to attack it. Don't rush into the hornets' nest. You will bring upon yourself the scorn of the thoughtless multitude. If once a famous astronomer arises against the present conception, I will communicate, too, my observations; but to come forth as the first against opinions which the world has become fond of—I don't feel the courage.

We see thus that during a time when the world was violently heliocentric, scholars still knew that the geocentric model had not been disproved and that the heliocentric model had no evidence that could be claimed as proof. The next man interviewed by Tischner's doubter reflects the opinion of a lesser, scornful mind.

Johann Franz Encke (1791-1865)

Encke was a student of Gauss. He discovered the existence of short-period comets (comets with periods under 71 years) and the Encke division in Saturn's ring. His work on comets earned him the directorship of the Berlin Observatory in 1835.

Tischner tells of the encounter between the doubter of the Copernican system and Johann Encke:

From Humboldt our doubter went to Encke. Here, indeed, he was not cordially received. In a surly manner Encke declared that astronomers had something better to do than to meddle with hypotheses: he had no time to teach every one who had any doubts; there were books enough about astronomy—these he should read. The doubter replied that he had already read the books written for the general public by Littrow and Mädler, but he had found in them no reliable information. Encke re-

marked on that, that if these books did not satisfy him, he, too, could not give him further advice.

One might think that our doubter would typically receive an answer like he received from Encke, but that is not so; even today.

Karl Georg von Raumer (1783-1865)

Karl von Raumer was a geologist, geographer, and expert mineralogist. History has overshadowed him by his statesman-politician brother Friedrich. In 1827 he was named professor of the Natural Sciences at Erlangen which post he held until his death. Tischner wrote the following of von Raumer's meeting with the doubter:

In 1854 our doubter visited Karl von Raumer at Erlangen, who avowed to him openly that he, too, was not fond of the Copernican hypothesis, but had never dared do more than utter vague objections against it. Thus in his "Croidades,"* p. 119, where he writes: "Now, indeed, each schoolmaster, according to hearsay, teaches that the earth moves around the sun, without thinking in the least about exerting himself and his scholars to perceive the planetary movement." When the



Figure 3: *Karl von Raumer.*

* The author has unsuccessfully tried to find the "Crusades" title referred to by Tischner. This does not mean that there never was such a book, however, since all of von Raumer's works from 1819 through 1822 are missing.

doubter left von Raumer, the latter congratulated him on his purpose of helping truth to her rights; he was, however, doubtful whether it would in a short time be possible to vanquish the fanaticism of the world.

Johann von Lamont (1805-1879)

Johann von Lamont was an astronomer and physicist who studied the magnetism of the earth. He discovered a 10-year cycle related to the sunspot cycle and discovered the electric current in the earth that closed the electric circuit that forms earth's magnetic field. Lamont is author of the *Handbuch der Erdmagnetismus* (1849). Tischner resumes his accounts:

At Munich our doubter visited von Lamont, director of the observatory. Von Lamont said to him: "You and the world in general are in error; never yet has any real astronomer spoken of a Copernican system; we only know a Copernican hypothesis. Whether this may be true or erroneous does not matter at all for each genuine astronomer." The doubter replied that he knew very well, but then surely one should not abandon lay people to the presumption that astronomy takes the Copernican hypothesis for a truth. "I have never meddled with lay astronomy," said von Lamont; "if Littrow and Mädler instill superstition into the people by selling hypothesis for truth, that is their affair."

Karl Friedrich Gauss (1777-1855)

Gauss was a mathematician and scientist and by far the most famous and capable of all the men listed in this essay. The normal curve encountered in statistics and test results is called a "Gaussian curve" after its discoverer, Karl Friedrich Gauss. The unit of magnetism, the gauss, was invented by him and named after him. So

what does one of history's greatest mathematical astronomers have to say to our doubting friend?

At Göttingen our doubter made the acquaintance of the astronomer Gauss, who met him in the most friendly manner, aided him with books and allowed him to apply to him at each time when he thought himself to have need of his counsel. The doubter communicated to Gauss the course of his investigations made hitherto; he told him of his having found



Figure 4: *Karl Gauss*

that all the great thinkers, such as Schelling and Hegel, have criticized the exuberant claims of the Copernicans, while only little spirits and uneducated folk claimed the right of not only scorning as a fool, but even persecuted with wild fanaticisms, those who did not agree with the chorus of general opinion. Gauss avowed to the doubter that every new discovery in astronomy filled him with new doubts about the dominant system. When our doubter communicated to him that Alexander von Humboldt had declared he would likewise arise immediately against the present conception, if some famous astronomer would declare himself against the dominant system, Gauss answered: "Aye, if I were twenty years younger!"

With Gauss, August Tischner's tales of the Copernican doubter end. When Tischner wrote his book in 1885 he ended his first section with these words:

The astronomers of our days say: Everybody will understand that an astronomer of the present time cannot take up any

other system than that of Copernicus, though it were but by way of trial. They assert that the system of Copernicus is the only possible one, the eternal foundation of all further progress of astronomy, that with the system of Copernicus the whole of astronomy stands or falls, and that without it we must renounce all explanation, all scientifically founded prediction.

And that sums up the situation through this very day.

Dr. Carl Schöpffer* (bef. 1830 - aft. 1881)

Dr. Carl Schöpffer was most likely the greatest geocentrist of the nineteenth century, yet little is known about this geocentric and illustrious German astronomer and physicist. The earliest works I have found by him all date from 1854. The first, entitled: *Lehrbuch der Physik für das weibliche Geschlecht, besonders für Lehrer und Schülerinnen der höheren Töchterschulen*, (Braunschweig: Ramdohr) was a textbook on physics and the natural sciences that encouraged all women to learn physics and the natural sciences in school. A Dutch reviewer identified only as C. J. M., writing for a Dutch historical guide to literature (DBNL), says Schöpffer's book has some merit but cannot be recommended because of too many "factual errors." Schöpffer's geocentric leanings are not mentioned in the review.

One "factual error" to which the Dutch reviewer took particular exception was Schöpffer's explanation for why the sky is blue. Schöpffer claimed that the sky is blue because blue is a mixture of black and white. We can wink at that erroneous theory today, but the reviewer's critique is unjust, for the true cause of sky color, *viz.* Rayleigh scattering of light, was not recognized until Baron John Rayleigh (1842-1919) identified it while he was Cavendish Profes-

* Schöpffer is the correct spelling of the name. De Peyster misspells it as Schoepffer on the cover of his book; others anglicize it as Schoepffer or Schoepfer.

sor at Cambridge University between 1879 and 1884. That was thirty years after Schöpffer wrote his explanation, which was the common explanation of his day. Literary people should know better than to take text out of context, but because today's science is regarded as infallible, it is hard to recognize that scientific ideas, too, should not be taken out of their context, in this case, their time and culture.

The second work that Schöpffer published in 1854 was *Blättern der Wahrheit* (Pages of Truth), published at Göttingen. It is there I found Schöpffer's first statements against the Copernican system (Vol. 1, pp. 354-356). Schöpffer wrote the following account of what led him to doubt the motions of the earth:

In an introductory speech Dr. Menzzer at Quedlinburg showed that until then there had been no proof for the Copernican hypothesis, the so-called proofs being, after close investigation, just as many confutations, until the Foucault pendulum showed the rotation of the earth uncontrovertibly. The pendulum was tied, the string was burnt, the swinging began, but the pendulum deviated to the left, instead of to the right. It was hastily brought to rest. New burning of the string. This time the deviation was the one desired, and we were invited again to be present in the church the next morning at eight o'clock, to be convinced that the deviation agrees with the theory. On the following morning, however, we saw that the pendulum during the night had changed its mind, and had from the deviation to the right again returned to the left. To me this new proof did not seem to be quite in order. My belief in the Copernican doctrine was shaken by the speech of Dr. Menzzer, and I concluded to go to Berlin for an explanation.¹¹

Prof. Schöpffer did go to Berlin and settled there. His quest for a resolution to the Foucault pendulum problems* may well have

* The problems with the Foucault pendulum persist to this day. The adjustments applied to make the pendulum behave "correctly" are documented in Chapter 29.

led him to meet with von Humboldt. It is likely that Schöpffer was Tischner's doubter; at least for the exchange with von Humboldt.

Schöpffer's third work, published in 1854, was entitled, *Die Bibel lügt nicht!* (Nordhausen, Adolph Büchting).¹² The full title translates as: "The Bible does not lie! Exposition of the Mosaic Creation Account, or Proof that the Literal Biblical Teaching of the Creation of the World is Consistent With the Slightest Scientific Detail."

One might expect that Schöpffer would be suppressed by the scientists of his day, but Schöpffer's work was renowned. Madam H. P. Blavatsky was born in Russia as Helena Petrovna Hahn (1831-1891). In 1875 she founded the Theosophical Society in New York City. A three-part series of articles against Buddhism appeared in the *Ceylon Catholic Messenger* on October 25, 26, and November 1 of 1881. Blavatsky wrote a long critique of the *Messenger* series, the article, and its author, Colonel Henry S. Olcott. In the critique she also mentions Schöpffer. Of him she wrote:

Some ignorant Buddhist priests may deny at present as ever the sphericity of the earth and its rotations. But so do the Roman Catholic bigots and monks to the day and more than ever since the days of Galileo. Professor Schöpffer, an eminent astronomer of Berlin, denies the heliocentric system and Father Grégoire of Cairo did so. The Jesuits avoid speaking of that rotation which befools the infallible Bible and Joshua's "Miracles."¹³ [Sic.]

The most influential of Dr. Schöpffer's works was written in 1869. It constitutes the foundation of almost every geocentric work published from then to 1950. It was entitled *Die Widersprüche in der Astronomie* and it was published in Berlin.¹⁴ The full title loosely translates as, "The contradictions in astronomy originating from the acceptance of the Copernican system are vanquished."

We find then in Schöpfner a geocentrist respected in his time who wrote on a variety of subjects. Whereas other geocentrists of the time specialized in rebutting those who invoke poetic license or figurative speech against the clear teachings of the Bible, Schöpfner attacked the science of Copernicanism with reasonable success. But the theories of science are built on shifting sands. Science is influenced by politics and economics as well as peer pressure through peer reviews and the publish-or-perish attitude of insipid university administrators. Eventually, then, all scientific arguments for or against the geocentric system will fail even as the alleged proofs of the Copernican system failed. Science not founded on Scripture is doomed to failure.

The Story of Gustav Friedrich Ludwig Knak (1806-1878)¹⁵



Figure 5: *Gustav Knak*
(Evangelisch Zentralarchiv Berlin)

The story of Gustav Knak seems tragic in the world's perspective. It goes to show how dangerous a testimony of preferring the Bible's word over science's word can be.

Pastor Knak lived and pastored in Berlin. He was a very aggressive witness for Jesus Christ in a city and nation close to being given over to a liberal, progressive, self-satisfied world. Pastor Knak wrote many songs and poems. Some of his hymns are still sung today, mostly in Germany, but also in America.

So the man was no dimwit and was not without talent.

One day in 1868, a liberal pastor in the Berlin synod asked Knak if, for example, he would believe that the earth stands still and the sun moves around the earth, as the Bible teaches. Knak found nothing wrong with it and immediately answered, "Yes, I do believe it. I do not acknowledge any other world view than that of Holy Scripture." The first words out of the mouth of the questioner were: "Knak, you are stupid."

Dr. Hermann Theodor Wangemann, in his 1895 biography of Pastor Knak, relates what happened next:

Not twenty-four hours had passed since Knak's statement, when his name, like a fire, went through all public papers. This simple confession by a simple pastor of his belief in the Biblical worldview was the *nonplus ultra* of provocation, insanity, and pastoral pride, considered as the highest danger for the education of the people. Knak was called a reverse or backward Luther, a drummer who alarmed the whole scientific world. He could really have been proud of the fact that with four words he created that much dust. At a Hamburg district meeting when they were discussing the four words, a statement was made: "Rather Turk than Parson."

Knak had the best education Berlin could offer. He was born and educated in Berlin, studying science from the highest authority. Berlin itself was a city of highest intelligence, but now other highly educated cities around the world gave it the mocking nickname Knakopolis. Instead of "Oh nonsense," literary sections of newspapers substituted "Oh, Knak!" For months Knak became the butt of comic satire. He was a sun-pusher, *Frater Solis* (Father Sun), and men outdid themselves to ridicule him.

Public mockery followed Knak everywhere. Letters and telegrams arrived addressed to the sun pusher, head sun pusher, or master Knak. They were signed Galileo and Copernicus. One asked him to please stop the sun so that a wedding would last longer. Another requested a change in the weather. Some were

filled with vulgarities. A New Year's greeting was signed with the name Mephistopheles.

Knak's colleagues tripped all over themselves to distance themselves from Knak, but to no avail. Because of the brouhaha about Knak there were jokes, obscenities, and speeches against conservative preachers. Students threatened Knak and his family with bodily harm and vandalism of his home. The antagonism from the students was so great that Knak tried to mollify them with the words: "One can be a believing theologian without having to be limited intellectually."

The Berlin city council, under the directorship of Mr. Kochhann, convened with the city's intellectuals to plan a response. A hundred nineteen names of professors, lawyers, city counselors, agreed to a resolution which started out with the claim:

The Holy Scriptures, the book of religious life, is not relevant to the laws of natural science. The earth is revolving around the sun!

It was all to no avail. The more the liberals protested, the worse it got. The word spread around the globe. The name of Knak became infamous. And what was the cause of the bruit? A pastor whom they judged an ignoramus had answered one private question with his private opinion concerning the stability of the earth with five words, "Yes, I do believe it." This private opinion, not imposed or forced upon anyone, which no one had to believe, had driven the city of Berlin and half the world to madness.

In time, Knak's liberal colleagues said, "You have made fools of all of us," and "Knak has done tremendous damage to us." And so it should be. An arrogant, proud, liberal pastor had challenged a David who overturned his point of view. The science which the liberal giant represented was mocking the witness of Scripture. Knak had openly and freely confessed that the Holy Bible is a revelation from God, and in his answer told the world that all the theories and wisdom of the world's science are too weak to survive a

simple confession, too weak to overthrow a single word of Scripture.

In the eyes of those who make science their idol, Knak's confession was an unheard of insult, an outrage. Since the idolaters could not give a reasonable answer, they reverted to mockery, persecution, insolence, ignorance, and riot.

Prof. Virchow, a leader of the synod who had once proudly proclaimed that, "The old heaven is no more, science has forever done away with it and they will never regain it whatever they might try" banned Knak from the pulpit, claiming Knak was insolent and ignorant, and an outrage "unfit ever to climb into a pulpit again." The Protestant church paper had rushed to press the claim that Joshua 10 was not an historic report but a citation in a heroic poem, therefore to be considered as poetic talk. The Protestant churches will always know to acknowledge the "mature and undoubted results" of scientific progress.

In the same year, and in response to the initial furor, Knak and a friend, Gustav Lisco, published a booklet on the geostatic matter.¹⁶ The booklet has not been translated into English. Knak also wrote a tract with his friend, Hermann Theodor Wangemann who after Knak's death became his biographer.¹⁷

Other than a few friends, Knak was unprotected from the onslaught on his character. A few papers would demand justice. Knak found kindred spirits in the missions to the heathen, especially in China. A blind, orphaned Chinese girl named Madden once wrote him:

I have heard from our dear pastor that you do have to suffer shame by the unbelieving people for the name of the Lord Jesus just as the Scripture says: "For thy sake we are killed all the day long; we are accounted as sheep for the slaughter." And as the sacred song says, "If only I have thee I will not ask for heaven and earth, even if body and soul should perish, even so thou, God, art the comfort of my heart and my part."

How are you doing? I hope the Lord will bless you and help you. Best and hearty regards. Yours, Madden.

Throughout the entire furor, Knak maintained his composure. When he was ridiculed he prayed for his enemies. His strongest retort was in a telegram sent to a mocker. The telegram only contained the words of Galatians 6:7-8:

⁷ Be not deceived; God is not mocked: for whatsoever a man soweth, that shall he also reap. ⁸ For he that soweth to his flesh shall of the flesh reap corruption; but he that soweth to the Spirit shall of the Spirit reap life everlasting.

To his best friend he wrote of those years of persecution:

How happy am I that we can struggle together and consider the shame of Christ a greater wealth than the treasures of Egypt. The joy in the Lord is my strength. Our matter must really be bothering Satan very much that he barks again and again and gnashes his teeth. What a terrific influence the goddess of science has one can really see when getting together with brethren that are somewhat afraid to step too close to this Diana [of the Ephesians: c.f. Acts 19:24-40 —*Ed*]. Oh, that the sling stone of David would throw this boasting giant to the ground soon.

Knak had spoken the truth and set on fire the rage of the world, but rage is an expression of frustration, the last resort of those who have lost all reason and will not face the truth.

Thus far we have examined only the German geocentrists and anti-Copernicans. It is to be expected that through the Lutheran Church and German emigration to the New World, the debate would enter the United States. We shall examine that next.

Prof. Joseph W. Holden (1816-1900)

Well, no, he really wasn't a professor, you see; for he only had an elementary school education: but his friends and neighbors dubbed him "Professor." The story goes that about 1850, Joseph W. Holden placed a pan filled to overflowing with water on a fence post and noted in the morning that not a drop of water had spilled.* But because the water had not spilled, the Professor concluded that the earth is not moving and that it must also be flat.

In 1893, dressed in a red vest and top hat, he presented his proofs at the Chicago World's Fair, whence he returned to his hometown of Otisfield, Maine. When he died he left \$3 to the East Otisfield Free Baptist Church for a Sunday school picnic. Instead of a one-time affair, the picnic has become an annual affair, held on the last Sunday in August. Up to 200 people attend. They place a bow on the Professor's grave and read the inscription on his tombstone: "Prof. Joseph W. Holden, born 8-24-1816, died 3-30-1900. Prof. Holden the old Astronomer discovered that the Earth is flat and stationary and that the sun and moon do move."

Nathan Salant tells a story of a more recent version of Prof. Holden's water pan. This one involved baseball player and practical joker William Herman "Germany" Schaeffer (1876-1919):

Perhaps Schaeffer's best move was the time he bet Davey Jones that the world does not rotate on its axis. The pair returned to their hotel room, whereupon Schaeffer filled the bathtub to the top with water, told Jones to look at it, and went to sleep. The following morning, Schaeffer dragged Jones into the bathroom and triumphantly showed him the bathtub, which

* This is a subtle experiment; it assumes that the turning of the earth would twist the water out of the pan. But if you stop to think about it, you could balance a pan of water on a smoothly-spinning merry-go-round without the water spilling as long as it was angled into position properly—as Holden would have done to stabilize it in the first place. It is the jerkiness of motion that spills the water, not a smoothly on-going turning.

was still full of water. While spinning a glass full of water, and pointing at the drops that spilled over the sides of the glass, Schaeffer pointed out that if the earth rotated, the water would also have spilled out of the tub. Jones conceded defeat and paid!¹⁸

John Jasper (1812-1901)

John Jasper was the most famous black preacher of the nineteenth century. In 1840 Jasper was ordained but during the ordination procedure it was discovered that he could not read. The church broke state law when they taught him to read. Black men were not allowed to preach in regular churches unless supervised by white ministers. Jasper was the only black preacher licensed to preach to black and white alike before the Civil War. During the closing days of the Civil War, Jasper was asked to preach to the Confederate soldiers of all races in the hospitals around Richmond, Virginia.



Figure 6: *John Jasper*

In 1867 John Jasper founded the Sixth Mount Zion Baptist Church in Richmond. The church began with nine members. Fifteen years later there were more than 1,000 members, and at his death they numbered nearly 2,000. Jasper's last words were, "I have finished my work. I am waiting at the river, looking across for further orders." He died after preaching on Sunday morning, March 28, 1901.

Jasper's most famous sermon, which he preached by invitation more than 250 times, is entitled "De Sun Do Move." It is reported that he even preached it before the entire Virginia General Assembly. A version of the sermon is reproduced in Appendix D. In the sermon, Jasper also advocates a flat earth reasoning, in effect, that

if scientists cannot square the circle, what do they know of the shape of the earth? (Squaring a circle, which is to construct a square of the same area as a circle from the circle in a finite number of steps with straight edge and compass, was proven to be impossible in 1882.)

John Watts de Peyster (1821-1907)

J. Watts de Peyster was a Brigadier-General during the Civil War, and a brevet Major General who had a list of honorary and earned degrees, viz. M.A., Litt. D., Ph.D., and L.L.D. In 1900 he published a book entitled *The Earth Stands Fast: A Lecture Delivered by Professor C. Schöppfer [sic]*.¹⁹ The book is in two parts.

The first 21 pages are Schöppfer's lecture while the remainder of the book is Frank Allaben's treatise on the nature of planetary mechanics, of which we shall speak next. De Peyster is the translator of Schöppfer's lecture.



Figure 7: J. Watts de Peyster in 1888

Frank Allaben (1867-1927)

Frank Allaben is primarily remembered as a genealogy publisher. He founded the Frank Allaben Genealogical Company of

New York City. Allaben was also an author who published a biography of John Watts de Peyster in 1908. The book went through four editions. He also wrote guides to genealogical research and tracing ancestries, as well as many family genealogical records. A collection of poems was published posthumously in 1931 and ran through two editions.

Mr. Allaben championed an electromagnetic theory of gravity, which he derived to a large extent from Schöpffer and Tischner. The model considers the earth a magnet about which the sun moves in a heliacal path. The sun, Allaben believed, is electrically charged so its movement induces electric forces that drive the moon and planets and, possibly, also the stars. The theory requires a small universe, so all distances are deemed suspect and Newton's theory of gravity is rejected. The explosive development of electromagnetic theory in the nineteenth century lent credence to Allaben's theory, although by the early twentieth century the shortfalls of electromagnetic theory as the cause of or a replacement for gravity were readily apparent. Allaben's theory is argued most strongly in the supplement to *The Earth Stands Fast: A Lecture*, which supplement was also published by de Peyster and was entitled *Algol: the Ghoul or Demon Star, A Supplement to the Earth Stands Fast, (1900)*.²⁰

Friedrick Emil Pasche (1872 – 1954)*

Frederick Emil Pasche was born in April 8, 1872 in Bayersberg, Brandenburg, Germany. His parents immigrated to the United States nine years later settling in Mayville, Wisconsin. After four years at Concordia College, Milwaukee, Pasche graduated from Concordia College, Fort Wayne, in 1891. In 1895 he graduated from Concordia Seminary, St. Louis and entered the ministry. That same year he married Martha Widdenheft. The couple had

* Pastor Pasche's first name, in German, is spelled "Friedrick," in the Library of Congress and in some Lutheran references; however, the spelling in his book is Anglicized as "Frederick."

eleven children, three daughters and eight sons, not counting a boy who died in infancy.

In 1899 Pasche accepted a call to Sioux Falls, South Dakota, where, in addition to his pastoral ministries he also taught in the Christian day school. It was there that Pasche wrote his 1906 textbook on astronomy. There followed a series of calls and moves until he finally retired in 1940 after 45 years in the ministry, including 32 years of parochial school teaching. All in all, Pasche wrote two major books on astronomy in addition to a booklet, and two devotional books: *Daily Bread* and *Things Above*, and a series of articles for the *Concordia Theological Quarterly*.

In 1906 Pasche published a book entitled *Die Bibel und Astronomie*.²¹ The book was written in German, the language of the Missouri Synod at the time. The quotes presented here are translations from the original German text. Every effort has been made to assure the accuracy of each translation. Also, scripture references have been changed to conform to the standard used in this book and verse numbers in the Psalms have been changed from the German numbering to the English verse numbering. The title page says of this book:

Proof that not a single one of the approximately sixty passages making reference to the standing still of the earth and the movement of the sun and all the stars can be given an expository reading implying that the opposite could possibly be true.

Pasche is particularly strong in attacking the accommodation theories, the dismissals of the Bible's geocentricity by claiming that God was either too incompetent or too lazy to inspire true truth in the "God-breathed" original autographs. For instance, on page 19 of his book, Pasche wrote the following about Psalm 19:5-6:

[If] David speaks only according to the mistaken conceptions of his time...oh, but then God would indeed be a poor teacher! Is that something a sensible schoolteacher would do? In teach-

ing, would he try to establish a truth by employing comparisons and illustrations which actually teach the opposite, which are based on totally erroneous concepts, which, should the scholar somehow learn the truth, would lead to confusion regarding the teacher and his truthfulness, his knowledge, and his teaching competence?

It is difficult to find much information about the Rev. Pasche on the Internet. There is no biographical sketch of him that shows up in any search engine. It is as if the man never existed. It is not surprising that his work is suppressed by modern Lutherans given their present apostate position. The old guard in the following protest letter written in 1952 protested the adoption of heliocentrism that marked the end of the traditional Missouri Synod Lutheran's geocentric position:

It is well said that Rev. F. E. Pasche's *Bibel und Astronomie* offers "proof that not a single one of about sixty verses, in which the earth is said to stand still, and the sun and all stars are said to move, may be interpreted in such a way as if really the reverse were the case." Such "interpretation" is not exegesis but eisegesis.* It brings into Scripture a world-view which no one has ever found in Scripture and according to this alien importation reverses the plain meaning of what Scripture actually says. The plea that "Scripture accommodates itself to human concepts," that is, rightly understood, that it speaks in intelligible language, is not valid when such concepts are supposed to be inherently erroneous. Scripture never accommodates itself to **erroneous** human concepts. Moses could have made the "Copernican" world-view intelligible to the people of the sixteenth century B.C. as readily as Copernicus made it intelligible to the people of the sixteenth century A.D., **if only this world-view had been true to fact.** The proper scope of

* Eisegesis is an interpretation, especially of Scripture, that expresses the interpreter's own ideas, bias, or the like, rather than the meaning of the text.

the Scripture is not to teach history, geography, natural science, but is given in John 5:39; II Timothy 3:15 v.f; I John 1:4; etc. When Scripture, however, **incidentally** touches upon these matters it is still inviolable truth (John 10:35), and to "interpret" the pronouncements of Scripture even on these matters in accordance with supposed knowledge derived from sources outside the Scriptures (human hypotheses) is to dishonor the divine and self-interpreting Word. We of the Orthodox Lutheran Conference,* operating, as we do, without benefit of "the human element" or "human factor" in Scripture, will, by God's grace, not be equipped to get out of Scripture any other meaning than that which the Holy Ghost put into it.²² (Emphases in original.)

Since Pasche's *Die Bibel und Astronomie* was used at Concordia and other Lutheran schools, it follows that the unofficial Missouri Synod position was geocentric well into the Twentieth century. Officially, the Synod declined to endorse either geocentricity or Copernicanism. Nevertheless, strong though Pasche's scriptural arguments may be, his scientific ones are not nearly as strong. Part of the reason for that is that science is inconstant and ever inconsistent. What was a scientific "fact" a hundred years ago may be a discarded relic in today's science. Phlogiston, the sun as a mirror, the inhabitants of the sun, moon, and other planets, the spontaneous generation of life from the corpses of dead animals; these were all well-established scientific "facts" in their day but are now relegated to the dust bin of history. Another reason why Pasche's and others' scientific arguments supporting the geocentric universe fall short is that they pay no attention to, nor take the time to understand the arguments for the scientific positions of their time. Likewise, almost all who argue against the geocentric paradigm do

* The Orthodox Lutheran Conference split from the Lutheran Church Missouri Synod on September 26, 1951. As such, the OLC no longer exists. Small separatist associations of Swedish and Norwegian Lutherans and the Wisconsin Synod still adhere to geocentricity and consider heliocentrism an abomination.

so without ever having examined the geocentrists' arguments and rationale. This is an innate characteristic of human nature and exposes one's self to the charge of hypocrisy.

In 1915 Pasche published a 51-page booklet entitled *Fifty Reasons: Copernicus or the Bible*. This work was published in English and consists mostly of scientific arguments. Most are easily dismissed, but a few are still valid. In his closing statement, Pasche says this about faith in the majority opinion:

Many *know* that there is no proof for the Copernican hypothesis, but they are blinded by the cry: "It is accepted throughout the civilized world!" (Dr. Carl Pierson, "The Grammar of Science," 1892.)* The most common objection raised against the Biblical system is the *general agreement of the learned*. But voices must be weighed, not counted.

The pride of modern science denies infallible revelation, yet blindly assumes that "science" is eternally infallible. How, then, can science know truth?

That such is not just the judgment of a geocentrist is attested to by the following statement published in the *Catholic Encyclopedia* under "Faith" and written by an English Dominican about the same time as Pasche's *Fifty Reasons* was printed:

If, now, the will moves the intellect to consider some debatable point—*e.g.*, the Copernican and Ptolemaic theories of the relationship between the sun and the earth—it is clear that the intellect can only assent to one of these views in proportion that it is convinced that the particular view is true. But neither view has, as far as we can know, more than probable truth, hence of itself the intellect can only give in its partial adher-

* Carl Pierson (1857-1936) was a leading pioneer in statistics and probability. Pierson used his statistics to solve everything, even establishing a foundation for euthanasia (mercy killing) and eugenics (selective breeding of humans in the futile hope that the human race may improve).

ence to one of these views, it must always be precluded from absolute assent by the possibility that the other may be right. The fact that men hold more tenaciously to one of these than the arguments warrant can only be due to some extrinsic consideration, *e. g.*, that it is absurd not to hold to what a vast majority of men hold.²³

Pastor Pasche died on 21 May 1954 in Hancock, Minnesota. Funeral services were held on 24 May at Zion Church, Horton, and conducted by Berthold Hein. At the time, the Pasches had 43 grandchildren and 26 great-grandchildren.

Prof. Louis Lange

J. R. L. Lange wrote his first anti-Copernican book in German in 1895.²⁴ After reading de Peyster's *The Earth Stands Fast*, Lange started a correspondence with both General de Peyster and Frank Allaben. In 1901, Louis Lange wrote a pamphlet in English. The title was *The Copernican System: The Greatest Absurdity In the History of Human Thought*. In the sixteen-page pamphlet, Lange invoked Revelation 6:13 as proof of a small, electrical universe with the words, "Christ says that the stars shall fall from heaven."²⁵ Lange correctly notes that without the Copernican Revolution there would be no theory of evolution or higher criticism of the Holy Bible.²⁶

In his geostatic writings, Lange is quite flamboyant, at times even flippant. He is the most antagonistic of the authors mentioned in this chapter. Lange wrote the pamphlet while living in Pacific Grove, a suburb of Monterey, California. There he ran a business selling do-it-yourself Spanish and German lessons for fifty cents each. In 1897 he wrote *Introduction to Spanish: A Working Knowledge of Spanish in a Week*. In 1899 he wrote *The Twentieth Century System for the Study of Languages*.

Lange's supposed proof against the rotation of the earth is that above the Pole Star, Polaris, stars rotate to the west while below it

they rotate to the east. By some twist of logic he, along with Allaben and de Peyster, concluded that such is the true state of affairs if the sky rotated but not if the earth rotates with its axis pointed to Polaris. The twist of logic makes sense, however, if these men assumed that the stars were very near the earth.

Lange argued that the stars we see going around the Pole Star during the night couldn't be accounted for in the rotating earth model. He describes his point of view as follows:

If the earth turned on its axis we should observe an entirely different appearance or phenomenon in the northern heavens (also at the south-pole). This can be demonstrated in a practical way. Take a disk...about twelve inches in diameter. Naturally points must be upon it to represent stars. Fasten the disk to the ceiling of the room. Then describe a circle in the room around a table, which stands directly under the disk (this is not a very difficult experiment to make). The difference between the actual and seeming or apparent turning of the disk will then be manifest.²⁷

Lange made a crucial mistake. He confused rotation and revolution. Indeed, in his next paragraph Lange correctly states that his description has "all the signs of a *real* revolution." But when it comes to the daily motion of the stars about the Pole Star we are not talking about revolution but of rotation. To see rotation in Lange's ceiling-mounted disk we need to stand right under it, look directly at its center and pirouette counterclockwise.

Now Lange admits that the sky would look as we see it if we were located at the North Pole, but if we were located in New York City and if the earth rotated, then earth's rotation carries us from the western side of Polaris to the eastern side and back again so that Polaris would be seen to proscribe a large circle in the sky, which we do not observe. That is what Lange describes in his table model. We call the effect he predicts, *parallax*. But according to the astronomy of Lange's day, the stars are many light years from

earth and Lange's expected parallax, though real, is so small that the instruments of his day could not detect it. Given that, why would Lange expect a parallax? Did he really believe the universe to be that small? To find the answer to those questions we turn to the work of Lange's contemporary, Charles de Ford.

Charles Sylvester de Ford (1860-1954)

Circa 1900, Charles de Ford and his wife farmed and taught school in Missouri. They were members of the Church of God (Adventist), a small denomination headquartered in Stanberry, Missouri. De Ford was prominent in the church and wrote several tracts and a pamphlet defending their denomination's doctrines. At that time, quite a few Seventh Day Adventists were flat earthers.

Sometime after moving to Mount Hope, Washington, in 1902, de Ford wrote an anti-Newtonian book entitled *A Reparation: Universal Gravitation a Universal Fake*.²⁸ Of the first two editions not one copy seems to have survived. The third edition was printed in 1931 and a few copies survive.

Although de Ford's book purports to dispose of gravity, its main emphasis is devoted to presenting a flat earth. In no way can de Ford's book be considered geocentric, for in his flat-earth-small universe cosmology the earth is a finite circle and the sky is a parallel volume above it.

De Ford's book does give insight into Lange's geocentric vision. What de Ford contributes to our understanding of the geocentric model at the beginning of the twentieth century is disclosed in his analysis of the sizes of the sun and moon. By a series of fallacious *fata morgana*-inspired geometrical arguments that invoke mirages and refraction (e.g., when a straight stick appears bent in water), de Ford reduces the diameter of the sun from 866,000 miles to 36 miles and its distance from 93,000,000 miles to 3,000 miles. A mid-nineteenth century predecessor of de Ford claimed the sun was less than a thousand miles above the surface of the earth, so the idea of such a tiny universe was not original with de Ford. De

Ford's claim that the astronomical bodies are merely thousands of miles away instead of many light years away gives insight into Lange's Pole Star argument. Distances that small, which are millions of times smaller than the ones we know today, are perfectly compatible with the parallax view that Lange's table model presented as his best evidence for a non-rotating earth (see page 380).

Returning to de Ford's arguments, de Ford demonstrates a familiarity with the literature of the flat earth advocates of the century before his. His scholarly research, though misapplied, is impressive. It is so impressive that the Fortean Society, a group that fearlessly investigates and, when necessary, debunks the paranormal, derives its name from his. The Society even sells the reprint of *A Reparation* issued by the skeptic Robert Schadewald (1943-2000) in 1992.

The British Works

Thus far we have examined primarily German and American anti-Copernicans, but they were not alone. There were geocentrists in England, too. Some of them introduced innovations that accompanied geocentric arguments for decades. Others married anti-Copernicanism with the flat earth. We shall examine some of them now.

Alexander Ross (c. 1590-1654)

Alexander Ross is perhaps best known as the man who first translated the Koran into English. For this he was both applauded and excoriated in his day. But it was his defense of Aristotelian physics that earned him unmerited ridicule over the intervening centuries since his death.

In his day, Ross was a gadfly to the "virtuosi," the word that designated scholars and physicians of his day. Ross attacked them on two fronts: his defense of Aristotle and his defense of Scripture as an authority on science. Although his defense of Aristotle proved powerless, his defense of Scripture forced the virtuosi to

consider the theological implications of their new sciences. On the theological issues, Ross' attacks were so clever and insightful that Richard Westfall called him "the vigilant watchdog of conservatism and orthodoxy."²⁹

Ross' first anti-Copernican work was entitled *Commentum de Terrae Motu* (Commentary on a Moving Earth) which he published in 1634. In response, four years later, in 1638, the Right Reverend John Wilkins published *The Discovery of a World in the Moon*, which was followed two years later with *A Discourse Concerning a New Planet*. Both books argued for the Copernican astronomy. The first argued that the Bible cannot be believed in matters of science because the sun, moon, planets, and stars are all inhabited whereas the Bible says that the earth is a special place. The second book argued that the Bible cannot be believed because it says in Psalm 19:5 that the sun is hot whereas it is merely a mirror reflecting the light and heat from the central lake of fire and that the Bible says π equals three. (See the section on Wilkins in Chapter 23 for a more detailed commentary on Wilkins' arguments.)

Ross, who was a supporter and personal friend of King Charles I of England and for that was exiled to the Isle of Wight from 1636 until his death, took several years to respond to Wilkins' second book with a pamphlet entitled *The New Planet No Planet: or the Earth No Wandering Star; except in the Wandering Heads of Galileans*.³⁰ On the second page of his pamphlet Ross wrote to the virtuosi, "You say it's but a novelty in philosophy, but I say it intrenches upon divinity, for divinity tells us that the standing of the sun and moving of the earth are the miraculous works of God's supernatural power; your new philosophy tells us that they are the ordinary works of nature." The wording appears to contradict the geocentric stance, but Ross' goal is to stress that the intent of the new sciences was nothing less than to overturn the authority of God with the authority of man through humanism. In the above quote he asks why they will not confess the heliocentric system as a miracle but insist that it is a natural occurrence without God. He continues:

Whereas you say that astronomy serves to confirm the truth of the Holy Scripture you are preposterous; for you will have the truth of Scripture confirmed by astronomy, but you will not have the truth of astronomy confirmed by Scripture; sure one would think that astronomical truths had more need of Scripture confirmation than the Scripture of them.³¹

Today, Ross is ridiculed for his beliefs, even though they were commonly held in his day. Wilkins, on the other hand, had no argument that survives to this day except for his $\pi=3$ argument, which Wilkins knew was fallacious but insisted on using anyhow (see Chapter 23). It only goes to show what happens when the victor writes the history books. Kuhn noted that: "Some men whose first interests were religious, moral, or aesthetic, continued to oppose Copernicanism bitterly for a very long time."³²

Thus Ross's defiant stance, proudly flourished before the Primate of All England, is important for what it might confirm about the deep philosophical conservatism inculcated by certain early seventeenth-century curricula such as that at King's [College, Cambridge, England], even as his specific cosmological beliefs inevitably invite modern ridicule.³³

Richard Baxter (1615-1691)

Richard Baxter was a non-conformist ordained Anglican who wrote more than 160 books. His opposition to a bishop's authority extending over more than one church is what first earned him the label of non-conformist. Later, he strove for a Restoration Church of England which would be moderately Episcopalian, including Presbyterians, Congregationalists, and moderate Baptists not as sects but as members of one fellowship. For his non-conformity, Baxter, like Bunyan, was severely persecuted under the rule of King James II.

Baxter took issue with the same arrogance of science challenged by Alexander Ross. The main difference between the two of them is one of style: Ross was vehement, Baxter was calm in his arguments. In his *The Arrogancy of Reason against Divine Revelations Repressed*, Baxter considered why some men will not believe the truth of a revelation. He concluded that they would not believe the truth of a revelation because they cannot understand how the thing revealed is caused. Men are impatient for knowledge but are bound to know things through their evidence. No arguments for the authority of Scripture will suffice until men see for themselves.

If the wisest men in the world tell them that they see it or know it; if the workers of miracles, Christ and His Apostles, tell them that they see it; if God Himself tells them that He sees it; yet all this does not satisfy them unless they may see it themselves. ...Every man has an understanding of his own, and therefore would have a sight of the evidence himself, and so have a nearer knowledge of the thing, and not only a knowledge of the truth of the thing by the testimony of another, how infallible soever.³⁴

Baxter understood that the natural man can never see the spiritual.

Henry Stubbe (1632-1676)

In 1670 a series of pamphlets appeared which ridiculed and denounced the virtuosi in the bitterest way. They were all published by physician Henry Stubbe. Over the intervening centuries, Stubbe's publications were considered the most vitriolic of all anti-Copernican literature. The Royal Society was his favorite target. He accused the Society of destroying the weapons with which Christianity had been defended by repudiating the old philosophy and scholastic divinity. Stubbe rejected the Society's claim that the study of material things prepares the mind readily to acknowledge

immaterial beings and gladly to praise God for the richness of his creation. Stubbe argued that if the Lord is regulated by the rules of geometry and mechanical motion in the government of the creation—a common claim made by Copernicans—that God could do no miracles.³⁵

In his *Censure upon Certain Passages Contained in the History of the Royal Society*, Stubbe countered the common assertion that the learned man's praise of God is more acceptable to God than the blind wonder of the ignorant. Westfall states it this way:

With St. Paul he replied that any work done without the inspiration of grace is worthless. No matter how much and how well an experimental philosopher studies the creation, he will not thereby become more acceptable to God than a man who studies the Scripture with humility and reverence and seeks to be accepted through the merit of Christ. A "Psalm of David," Stubbe declared, "the Te Deum, the Magnificat, in a blind and ignorant but devout Christian, will be better accepted than a Cartesian anthem."³⁶

"Probably by accident, when one considers his cynical nature," Westfall writes, Stubbe "uncovered some of the deep religious questions that natural science provoked."³⁷

In the first decades of the twentieth century, evidence came to light that casts doubt on the motivation behind Stubbe's tirades.³⁸

A [manuscript], "Life of Dr. Baldwin Hamey," a leader of the Royal College of Physicians in the 17th century, written by his nephew and now lodged in the library of the R.C.P., says that Hamey, fearing that the Royal Society would infringe upon the sphere of the R.C.P., hired Stubbe to attack the young organization. I have found a letter written from John Wallis to Henry Oldenburg, dated October 25, 1670, the year of Stubbe's pamphlets, which reported that Dr. Pierce, president of Magdalen College, Oxford, sent Stubbe a piece of plate

worth five or six pounds “for his good service” (Royal Society, *Guard Book W 1*, fol. 113). A series of letters from Stubbe to [atheist] Hobbes, written in 1656-57 when Hobbes was carrying on a pamphlet war with Wallis, further exposes Stubbe’s character. Stubbe wrote as an intermediary for the Independent faction in Oxford [independent from the Church of England, that is] urging Hobbes on to the attack, secretly furnishing him with scandal, telling Hobbes at the same time that he would have to disavow him in public (British Museum, Add. MS 32,553, fols. 5-34). In all, Stubbe appears as a clever but wholly venal scoundrel.³⁹ [Comments in square brackets added for clarification.]

In the end, Stubbe was highly successful and earned his money well. The Royal Society was not able to answer his challenges. The Royal Society had to address two key points. First, the new post-Copernican science promoted intellectual arrogance; man became the measure of all things. In particular, he preferred his ideas to the revealed word of God. Second, the mechanical atomistic philosophy appeared to be headed for pure materialism. The Society’s ultimate response was to combine their science with their religion. The offspring of that combination was *higher criticism*, a form of natural religion, the religion of choice of the natural man.

In 1671 Stubbe wrote *An Account of the Rise and Progress of Mahometanism, and a Vindication of him and his Religion from the Calumnies of the Christians*. He could not find a publisher but it was privately printed and circulated about 1674. Stubbe drowned in Bristol in 1676 and is buried in Bath.

John Wesley (1703-1791)

By the mid-eighteenth century, the Newtonians had convinced most of the intelligentsia that the Copernican theory was a proven fact, but not all were convinced. In 1753, Samuel Pike noted that:

Many Common Christians to this day firmly believe that the earth really stands still and that the sun moves all round the earth once a day: neither can they be easily persuaded out of this opinion, because they look upon themselves bound to believe what the Scripture asserts.⁴⁰

John Wesley considered the Copernican and Newtonian theories “ingenious conjectures” that would yield no “more than Probabilities” about “things at so great a distance from us.”⁴¹ Wesley

regarded natural revelation, that is, the “Book of Nature,” as less than reliable in revealing truth. In particular, he believed that about Copernican theory, Wesley’s comment dismissing Copernican and Newtonian science as incapable of yielding “no more than probabilities” is prophetic. Today the fields of Quantum Mechanics, Cryogenics, and Thermodynamics



Figure 8: *John Wesley*

are among many founded on the mathematics of probabilities. Wesley thus foresaw that science is incapable of coming to absolute truths as long as it rejects even the possibility of God.

Bartholomew Prescott (before 1800-after 1849)

Bartholomew Prescott was a Liverpool accountant. In 1803 he published his first anti-Copernican book, *A Defence of the Divine System of the World*⁴² which reduces the distance scale of the universe, albeit by different methods than Lange and de Ford's methods.

In 1822 and 1823, Prescott published the first and second volumes respectively of a two-volume set of anti-Copernican books.⁴³ The titles tell it all. The full title of the first volume is, *The Inverted Scheme Of Copernicus; With the Pretended Experiments Upon Which His Followers Have Founded Their Hypothesis Of Matter and Motion, Compared With Facts, and With the Experience Of the Senses: and the Doctrine Of the Formation Of Worlds Out Of Atoms, By the Power Of Gravity and Attraction, Contrasted With the Formation Of One World By Divine Power, As It Is Revealed In the History Of the Creation*. The book's preface was an open letter to Sir Humphrey Davy, a chemist and president of the Royal Society of London for the Improvement of Natural Knowledge, known simply as the Royal Society (founded 1660). This was not an unusual idea to attract the attention of the public to the author who usually would not be recognized by the Royal Society.

The second volume, published a year later, was entitled: *The System of the Universe, in Which the Unchangeable Obliquity of the Ecliptic; the Solar and Lunar Equations, Deduced from Circular Orbits; and the Direct, Retrograde and Stationary Appearances of the Minor Planets, are Mathematically Demonstrated, on the Basis of the First Chapter of Genesis*. It, too, had a letter prefixed to it, this time being addressed to the Astronomer Royal, John Pond, Esq. F. R. S. (Fellow of the Royal Society). Facing the title page of the second volume was a depiction of Tycho Brahe's model of the planetary system.

William Lander (1763-1843)

William Lander was a brazier in the town of Mere, Wiltshire, England. He is primarily known for his manufacture of musical instruments of which only one, a Serpent in C, survives. It may be found in the collection of Joe R. and Joella F. Utley, (1999) in the National Music Museum, The University of South Dakota at Vermillion.



Figure 9: William Lander

In 1833, Lander published a book entitled, *David and Goliath*.⁴⁴ Mr. Lander was seventy when the book was printed. The book is strong on scriptural arguments but Lander cannot accept the large distances. He does confess that the sun is referred to as the great light, and the greater when compared to the moon, but he does treat the references as if the text said "greatest." One example of his argument for a small size and nearness of the moon:

We are told of stones thrown out from volcanoes in the moon; supposed to reach us in about three days from the beginning of the fall. Yet, with all the accelerated motion which they must necessarily acquire in falling, they are found to penetrate the

earth only about a foot or two into the earth. This is very extraordinary. I should suppose that falling with such amazing swiftness, they would be buried so deeply as never to be found.⁴⁵

On page 25 of his book, Lander presents an argument to decrease the distance from earth to sun to about four earth radii. To do this, he switches from a geocentric coordinate system to one fixed to the surface of the earth at sunrise. However, the resulting position for the sun at four earth radii changes the location of local noon for the original geocentric coordinate location fifteen degrees to the west. That means that a place 90 degrees to the east of the sunset point will have experienced the sun overhead an hour before noon on the clock. Thus, instead of 90 degrees, the angle between noon and sunrise is now 75 degrees in Lander's universe.

Lander does correctly draw the heliacal motion of the sun about the earth. His scriptural arguments are very good, but his treatment of ratios and his geometrical argument are seriously flawed. His artwork is superb and the book is well illustrated.

James Hopkins' Alternatives to Gravity

We noted earlier that in both the German and American anti-Copernican literature, Newtonian gravity was dismissed, being replaced by an electromagnetic model. An early publication that advocated an electrical solar system is that of James Hopkins published in 1849. The title of the book is: *The Solar System Truly Solved; Demonstrating, By the Perfect Harmony Of the Planets, Founded On the Four Universal Laws, the Sun To Be an Electrical Space; and a Source Of Every Natural Production Displayed Throughout the Solar System; With Diagrams and Mathematical Problems, Carefully Laid Down and Revised.*⁴⁶ Hopkins was a school master and was probably not a geocentrist and maybe not even an anti-Copernican, but the problems that beset Newtonian gravity after the death of La Place invited the search for a replace-

ment theory of gravity, and the mysterious and powerful electromagnetism theory just starting to be developed at the time was a prime candidate for the vacancy.

Hopkins says this about his theory:

I am satisfied that I have given the true laws constituting the Sun to be space; and I call upon those disposed to maintain the contrary, to give true laws showing him to be a body: until such can be satisfactorily established, I have an undoubted claim to the credit of my theory, That the Sun is an Electric Space, fed and governed by the planets, which have the property of attracting heat from it; and the means of supplying the necessary pabulum by their degenerated air driven off towards the central space the wonderful alembic in which it becomes transmuted to the revivifying necessities of continuous action; and the central space or Sun being perfectly electric, has the counter property of repulsing the bodies that attract it. How wonderful a conception! How beautiful, how magnificent an arrangement! O Centre! O Space! O Electric Space!

Hopkins appears to be the source of those geocentrists who advocated that the sun and planets were electric or magnetic in nature. Even to this day, electromagnetic theories are invoked to replace the standard gravitational universe under the names of "plasma universe" and "electric universe." "Electric" is merely another name for plasma, but its ancestor can be traced at least as far back as Hopkins' 1849 book.

Today the effort to unite these two forces and others into one is called the quest for the Unified Field Theory. Einstein spent the final years of his life trying to find it. The Grand Unified Theory of the 1980s is generally regarded as the closest candidate qualifying for the Unified Field Theory although some would advocate massive superstring theory; but the only one to smoothly link gravity and electromagnetic theories is the theory of David Bergman and Charles Lucas which derives gravity from electromagnetism as

a fourth order effect: that is techno speak for saying that they are part and parcel of the same thing.⁴⁷

William Edgell (1861-?)

In 1919 William Westfield, which some suspect to be a pseudonym of William Edgell, published a booklet entitled *Does the Earth Rotate? No!* Mr. Edgell's booklet, *Does the Earth Rotate?* was published five years earlier, in 1914. Both booklets are anti-Copernican and both advocate a flat earth. Westfield's disproof for the rotation of the earth involved a tube he had installed in his garden. The tube pointed to Polaris. He reports:

I have this tube fixed in my garden, size 3 feet 6 in. by 3/4 in., directed to the fixed Pole Star, and I can view the star *continually*. Why? Because the star is fixed in the heavens and because the earth is a fixture also.

Edgell mentions that the same instrument is located in his garden, thus the two men are most likely one and the same.

Both books assume that the universe is so small that parallax would carry Polaris out of the tube's view. I know of no good way to explain the perspective-problem encountered by these men, but I do know that it is not unique to geocentrists for I have also seen the same perspective-problem in some of the arguments of the-lunar-landings-are-a-hoax critics. Nevertheless, I shall try to explain the problem these men have with perspective; why, even if the stars were as nearby as Lange and Edgell propose, Polaris would not move out of the tube's field of view.

Suppose one is standing in the middle of a railroad bed, between the tracks. We know that the tracks appear to meet in the distance. However, according to these men, in the heliocentric system the tracks should not appear to converge in the distance but should keep the same angular distance from each other. In other words, if the tracks were separated by a hand's span as measured

by a hand held one foot from the nose, they should still be separated by the same hand span at the horizon. In the geocentric system these men take the converging of parallel lines as proof that the earth stands still. In the case of moon landing hoaxers, the hoax advocates insist that the shadows tending to meeting in the distance is proof of multiple floodlights illuminating the scene instead of light from the sun 93,000,000 miles away from the scene.⁴⁸ Clearly, if two pipes were mounted parallel to each other, one over each train rail, the apparent difference between them would converge so that both would see the same vanishing point on the horizon.

If, as Lange and Edgell believe, the sun is but a few thousand miles above the earth, and that the stars are not much further beyond them, and if, as they observe, the direction to Polaris does not change over the course of a day in the towns of England, then that would still prove nothing for the geocentric system over the Copernican system. For whether the sky rotates about the earth, or the earth rotates on its axis, it makes no difference to the location of Polaris when viewed through a fixed tube.

MISCELLANEOUS GEOCENTRISTS REAL AND IMAGINED

Hon. Edward Howard

Edward Howard of Berkshire may have been a legitimate title and name or he may have assumed a name to present himself as an English aristocrat. It was usual at the time for nobility not to enter into such debates under their own names, but it was not unusual at that time for authors to assumed the "Hon." (Honorable) title to project more authority and to draw attention to their work. Even today we find that in Christian circles where an author may preface his name with the title of "Doctor" without telling the reader that his doctorate is honorary and not earned. Generally, anyone ad-

drinking the graduating class at a college or university is granted an honorary degree. It seems that this may have been a device Edward used to mislead the reader into assuming he is one of the illustrious Howards of his day.⁴⁹

In 1705 Edward Howard published a book entitled *Copernicans of All Sorts Convicted*.⁵⁰ Besides being an early treatise on magnetism as a driver of the planets, the book is best known for Howard's insistence that eclipses are impossible to explain under the Copernican hypothesis. That argument was resurrected in the twentieth century by Marshall Hall, of whom we will speak in a later chapter where we examine late-twentieth century geocentrists. Howard also asked how a man can "go 200 yards to any place if the moving superficies of the earth does carry it from him?" In other words, if, as in the latitudes of these United States, the earth rotates eastward at 740 miles per hour, how can we ever catch up with something to the east of us? This is not a scriptural question but a design to defend Aristotle's cosmology.

Etienne Lécuyer de La Jonchère (ca. 1700-?)

Etienne Jonchère was an engineer of some renown in France. In 1718 he proposed the construction of an important canal in Burgundy. About 1734 he published a work entitled *Découverte des longitudes estimées généralement impossible à trouver*, which translates loosely as "a technique to estimate longitudes in that are otherwise impossible to find." Back in the early eighteenth century such a technique was invaluable to shipboard navigators.

Jonchère's foray into the battle between the geocentrists and the heliocentrists was translated and published in English in 1728.⁵¹ The most valuable thing about Jonchère's book is not his arguments but the six claims he lists by which the heliocentrists of his day, and the French in particular, used to substantiate their theory. First of all, the author's introduction gives us the state of affairs on the geocentric-heliocentric front in the first quarter of the

eighteenth century. We note that there was still no proof, no convincing evidence for the Copernican heliocentric model:

Although the Scripture formally denies the *mobility* of the earth, and the Church, in all ages, has been strenuously endeavouring to destroy the opinions of all the *philosophers* and *astronomers* who would establish it; yet the notions and sentiments concerning the *motion* of the *earth*, have not failed so to possess people's minds, that at this day none dares call them in question.

Since, therefore, neither the Scripture nor the Church are able to prevent the establishment of this notion, which has been maintained by the greatest men, it might seem prudence in me not to attempt entering the list in its opposition. Nevertheless, I am determined upon the enterprize; and happy should I deem myself if in destroying an opinion so universally received, I could render to the Scripture all the luster of truth, whereof, by these contrary sentiments, it has thus long been deprived.⁵²

You will note that the sentence structure is rather laborious, and I have maintained the English spellings albeit not the Germanic-type capitalization. I have preserved the emphasis, however.

The six proofs that the (French) Copernicans put forth in those days are as follows:

1. That the earth, being only, as it were, a point in comparison with the sun, it is natural to suppose, that it must rather turn around that immense planet [the sun], than that the sun should turn round it.⁵³
2. That it is more easy and rational for the earth to revolve around the sun, in 365 days, 5 hours, 48 minutes and 52 seconds, and at the same time round its own center in 24 hours, than to make the sun perform a diurnal revolution round the earth.⁵⁴

3. That if the earth does not turn round its center in 24 hours, and annually round the sun, the sun, planets, and stars must daily make a most immense revolution; and, consequently, utterly incomprehensible; considering their excessive distances: whereas the earth, by its rotation on its own axis, (which is nothing comparatively) avoids all those prodigious and inconceivable revolutions.⁵⁵
4. That the diurnal and annual revolution of the earth do not require any proper motion of its own: since as the earth swims, as it were, in the matter of the sun's vortex, it is hurried along by that matter, and forced naturally to make all the requisite revolutions, without therein cooperating itself, in any manner whatever: insomuch, that though the earth really had divers motions, it cannot be affirmed to have any at all.⁵⁶
5. That the earth, in all probability, being no other than a planet, like Jupiter, Saturn, etc., it is not conceivable that those bodies, which are abundantly greater than the earth should be subject to a diurnal revolution round it, while, by a particular privilege, that smaller body remains immovable: it is more natural to imagine, that this planet, like the rest, makes its diurnal revolution round the sun.⁵⁷ [*Sic.*]
6. That the conformity of the earth with Jupiter and Saturn, round which satellites revolve, as does the moon round the earth, leaves us no room to doubt, that the earth makes the same revolutions round the sun, as we know Jupiter and Saturn do, which are abundantly greater.⁵⁸

The gist of Jonchère's rebuttal is to challenge the distance scale of the solar system and to point out, correctly so at the time, that no star has exhibited any parallax. John Morgan, the translator of Jonchère's work, summarizes the results in such a way that the stars are no more than 1,500,000 miles from earth.⁵⁹ In the final analysis, Jonchère's booklet amounts to little more than a wholesale denial of opposing evidence.

Adolph Hitler (1889-1945)

A small minority of geocentricity's critics, in their zeal to counter geocentricity, have charged that Adolph Hitler was a geocentrist. I have not been able to substantiate that charge. Neither have those few who have brought the matter to my attention. Still, other geocentrists have reported encountering the same charge. Of course, the charge is made by the anti-geocentric as an appeal to emotion, encouraging the hearer to conclude that anything that Hitler believed is suspect. One wonders how that squares with Hitler's belief that people need food to live.

Nevertheless, here is what Hitler had to say about the Copernican and Ptolemaic theories:

For Ptolemy, the earth was the centre of the cosmos. That changed with Copernicus. Today we know that our solar system is merely one solar system amongst many others. What could we do better than to allow the greatest possible number of people like us to become aware of these marvels?⁶⁰

That hardly sounds like a geocentrist.

The context of the above quote was a discussion of building a planetarium, observatory, and astronomical museum at Linz. Ptolemy was to have a lesser dome and the dedication of the greater dome was not specified but Hitler did say, "Kepler lived at Linz, and that is why I chose Linz as the place for our observatory."⁶¹ If Hitler were a geocentrist, why would he build his monument to astronomy in the city that Kepler made famous? Clearly, the answer is that Hitler was not a geocentrist.

Let us then ask a loaded question to the detractors of geocentricity who would impugn it with Hitler's name. Since Hitler was a modern acentrist, are you now ready to reject the modern view because Hitler espoused it? If not, you are a hypocrite.

Conclusion

We are taught in school that Copernicus proved the earth orbits the sun and that the earth rotates once a day on its axis. We know, too, that Copernicus' book was placed on the Roman Catholic Church's index of forbidden books not for its own sake but because Galileo kept insisting that the Copernican system is a proven fact instead of an unproven hypothesis. All the while, there was not one single observation that did not fit the Tyconic model exactly. Indeed, the absence of parallax supported the Tyconic model and opposed the Copernican model. Yet, by 1650 all of Europe preferred the Copernican model to Tycho's model, and the only "reasonable" reason for that is that the Copernican model "disproved" the Holy Bible.

Nevertheless, there has been a thin red thread since 1650 that still hangs on to the geocentric model. The red thread has included people ranging from noblemen, professional astronomers, to dirt-poor farmers. Some were moved by contention, others by convention, and still others by Scripture. Some were guided by reason and others by their feeling. Those who argued on a scientific basis were doomed to failure since modern science is founded on the sands of a barrier island in a hurricane zone, which makes its theories subject to demolition by the storms of politics, economics, and favoritism. Anti-Copernicans, like Edgell, de Ford, and Lange, who restricted themselves predominantly to scientific argumentation and used Scripture merely to support their pet theories were benignly neglected. Those like Pastor Knak, who argued only from Scripture, were subjected to ridicule and persecution. The closer a man stuck to Scripture, the more the persecution and ridicule. Their suffering is what stained the thread red.

By 1950 there were still some supporters of Pasche's geocentric stance left in the Orthodox Lutheran Conference, and I know of several in the Missouri Synod that still hold to the geocentric stance; but the schools, whoring after certification, have surren-

dered to the acentric Leviathan. The story of how the evidence for the heliocentric model waxed and waned between 1728 and 1916 will next be told. Suffice it to say for the moment, that after the advent of the General Theory of Relativity in 1916, all arguments against the geocentric universe became null and void. It took geocentrists a while to recognize that fact, but recognize it they did; and the result was a theory that subordinates science to Scripture and that works amazingly well.

Newton's Dynamics goes essentially beyond all observations. It is universal, exact and abstract; it arose historically out of myths; and we can show by purely logical means that it is not derivable from observation-statements.

—Immanuel Kant¹

NEWTON AND BERKELEY

After more than a century of Copernicanism, the humanistic scientists of the western world began to interpret astronomical phenomena in such a way that the more careless among them started seeing "proofs" of heliocentrism in certain natural phenomena. Most of the alleged proofs stemmed more from Copernican zeal than science. The professors of phony proofs idolized Newton and so were called *Newtonians*. One would expect that Newtonians would follow the principles and methods of Newton, and so they did, but they followed neither his philosophy nor his theology. In short, they were sloppy thinkers, doling slop for truth.

Early on, the Newtonians were caught up with a debate between Isaac Newton (Figure 1) and Bishop George Berkeley (1685-1753, Figure 2). When the dust settled, Newton and Berkeley had more in common between themselves than they had with the Newtonians. Modern geocentricity arose from the ashes of that debate.

Sir Isaac Newton (1642-1727)

Even today, Sir Isaac Newton remains a towering figure in the realm of science. But much of what is said of Newton is distorted to fit into today's image of what a scientist *should* be instead of the

scientist he truly was. One of the great enigmas to the modern mind is why Newton would write more about Bible prophecy and chronology than all his other works combined. Some dismiss it as senility while others hate him for it and slave to destroy his reputation. Because so few of his theological writings are available to researchers, there is a great deal of speculation surrounding Newton's religious beliefs. A lot of this is exacerbated by the debate between Continental Europe and the British Isles about who invented the calculus. This debate became a religious one; with Catholics claiming that the calculus was invented by the German Gottfried Wilhelm Leibniz (1646-1716), an ecumenist who wrote in French and Latin and sought the reunification of Lutheran, Protestant, and Roman churches; and the Protestants favored Newton.

From the few published religious writings of Newton, I gather that he was a closet Baptist and followed the Baptist approach to truth. Some of those distinguishing characteristics of Baptists include the separation of church and state;* the priesthood of all believers; the primacy of the Holy Bible in all matters upon which it speaks; that baptism is by immersion and is in obedience to Christ with no saving power; that salvation is by grace only and cannot be earned by works, it being a free gift of God; that all believers are saints; that salvation through the shed blood of Christ is eternal and cannot be lost; and that the scriptural church is a local church in which only believers may be accepted into the membership. Newton's refusal to accept an appointment to Trinity College is sometimes said to prove his anti-Trinitarian view, but if he were a Baptist he would have turned it down because it required him to be ordained in the Anglican Church—a state church. After all, when the requirement for him to take Anglican orders was waived, Newton

* By "separation of church and state," Baptists mean that the state must not interfere with the free exercise of any local church. In particular, that means the state cannot tax any local church, of any faith; for taxation is little more than a control mechanism. It also means that no religion can be tolerated that insists that it must be the national religion. This is so because all national religions place the state above God.

had no problem with the name Trinity. Therefore, I conclude that Newton was a Baptist.



Figure 2: Sir Isaac Newton

Newton's only departure from the Anabaptist-Baptist line may have been in the matter of the Trinity. Newton could well have had some doctrinal problems with the Trinity in light of John 14:28 where Jesus said, "My Father is greater than I." If God is infinite and if the members of the Trinity are one (Scripture nowhere says they are *equal*, just that they are *one*), how can one of them say another is greater? The answer was not discovered until the 19th century when mathematician Georg Ferdinand Ludwig Phillip Cantor (1845-1918) demonstrated two infinities, a smaller infinity and a larger infinity. He labeled them \aleph_0 , called aleph-null, and \aleph_1 , called

aleph-one. The second is infinitely larger than the first, thus serving to explain Jesus' claim that the Father is greater than he in John 14:28.

The smaller of the two infinities is \aleph_0 , which is the set of all integers. \aleph_0 is also equal to the set of all rational numbers, where a rational number is a number that can be expressed as an integer or a quotient of integers. Thus $1/2$ has a quotient of 0.5, which contains one integer, 5. By contrast, $1/3$ has a quotient of $0.3333\dots$ *ad infinitum* and cannot be expressed as an integer since we need an infinite number of threes to express its exact value. So the quotient of $1/2$ is *rational*, while the quotient of $1/3$ is said to be *irrational*. The next larger infinity is \aleph_1 , which is the set of all irrational numbers. Numbers such as π , $\sqrt{2}$, and e are irrational. What makes the two infinities "one" is that the concept of counting runs through all of them.*

In reply to Newton's supposed lack of understanding of the Trinity, most Bible-believers would simply note here that Jesus is speaking in the flesh in which state he has put aside his Godhood and leave it at that. Even though virtually all of Newton's religious works remain unpublished and unexplored, we can say that whatever Newton may have thought about the Trinity in his early days, we can infer from his *Optics* that late in life he was a Trinitarian.

Newton believed that space and time are absolute.² He called the firmament, which is the fabric of space and time, "God's sensorium." It was from that position that Newton derived his three laws of motion:

* In this attempt to illustrate how one infinity can be larger than another we used two infinities. The two alephs are related as follows, $\aleph_1 = \aleph_0^*$. We could define other alephs, such as $\aleph_2 = \aleph_1^*$, which could represent all the possible curves passing through every point in every space. Much of this is still beyond our understanding for even the brightest mathematical minds cannot agree on our two original infinities. Be careful not to make too much of this, dear reader. Remember, God is infinite, but infinity is not God.

1. Unless acted upon by an external force, a body either is at rest or moves in a straight line with constant velocity;
2. Force minus the change in momentum per second equals zero. The change in momentum is the firmament's reaction to the force;
3. Whenever a first body exerts a force on a second body, the second body exerts a force of equal size in the opposite direction;

and his formulation of the universal law of gravity,³ which can be stated the following way:

Between any two objects, there is a force of attraction that is proportional to the product of their masses. If the distance between the objects increases, the force of attraction between them decreases as the distance squared. Hence tripling one's distance from the center of the earth would cause one's weight to decrease to one-ninth of what it is on the earth's surface.

Beyond his three laws and his law of gravitation, Newton wrote on many other subjects. Earlier we noted that the bulk of his writings were about biblical topics, but he also wrote extensively on optics and alchemy (now called chemistry).

After his death Newton was severely criticized by his anti-Trinitarian disciple, William (Wicked Will) Whiston (1667-1752). Whiston is the translator of today's editions of the *Works of Josephus*.^{*} Whiston berated Newton for his "slavish" adherence to

^{*} Whiston earned the nickname "Wicked Will" with his antics and heretical beliefs. In addition to his attacks on Newton after the latter's death, his translation of Josephus affords us an example. Prior translations of Josephus placed the date of Herod's death in January of 1 B.C. In Whiston's day, however, scholars thought it more likely that Josephus was mistaken and that the 4 B.C. date for Herod's death was correct. Thus Whiston changed Josephus' 1 B.C. date to 4 B.C. Nevertheless, January 28, 1 B.C. is the most likely date of Herod's death, for according to the Roman calendar Herod was still alive during Augustus' silver jubilee in 2 B.C.



Figure 3: Bishop Berkeley

the Masoretic Text and the King James Bible, accusations that support the conclusion that Newton was a Baptist at heart.⁴

Newton and the Newtonians

Newton's laws were not readily accepted by the scientific and theological communities. Those who accepted Newton's laws were called *Newtonians*. Yet the Newtonians believed many things which Newton did not believe or even claim. For example: Newtonians were Keplerian in their view of the universe as

a machine, and they believed that a mathematical formula was the essence of reality. In other words, Newtonians held that if a formula could be derived from certain principles, and if it correctly predicted natural events, then those principles were proven beyond any doubt. The Newtonians' chief antagonists were Newton himself and the Irish Bishop, George Berkeley (1685-1753, Figure 2). Despite some differences, Newton and Berkeley did agree on several essential points. One of those is that God supports and maintains the universe (Hebrews 1:3^{*}) in its entirety and a second is that there is an ultimate explanation for all things. Newton and Berkeley also knew full well that a mathematical theory need not reflect the underlying nature of a physical event. For claims like that, which were beyond the scope of the Newtonians' attention span, Newton and Berkeley were accused of being anti-intellectual. Worse, there is a point that Copernicus, Kepler, and Galileo, as

^{*} Hebrews 1:3—[Jesus] being the brightness of his glory, and the express image of his person, and upholding all things by the word of his power, when he had by himself purged our sins, sat down on the right hand of the Majesty on high.

well as most modern scientists completely overlook. To quote Berkeley on the matter:⁵

a mathematical hypothesis...can easily be misinterpreted as claiming more, as claiming to describe a real world behind the world of appearance.⁶

Newton's Letters to Bentley

The Newtonians to the contrary, Newton knew that gravity was not an innate property of matter, for in his second letter to Bentley, Newton wrote:

You sometimes speak of Gravity as essential and inherent to Matter. Pray do not ascribe that Notion to me; for the Cause of Gravity is what I do not pretend to know, and therefore would take more time to consider it.⁷

In his third letter to Bentley, Newton repeats and elaborates on this view:

That Gravity should be innate, inherent and essential to Matter, so that one Body may act upon another at a Distance thro' a *Vacuum*, without the Mediation of anything else, by and through which their Action and Force may be conveyed from one to another, is to me so great an Absurdity, that I believe no Man who has in philosophical Matters a competent Faculty of thinking, can ever fall into it. Gravity must be caused by an Agent acting constantly according to certain Laws; but whether this Agent is material or immaterial, I have left to the Consideration of my Readers.⁸

In holding action-at-a-distance (as one body acting upon another through an intervening vacuum is called) as an absurdity,

Newton stands at odds with the vast majority of modern scientists who hold to action-at-a-distance. But this they have accepted unquestioningly from the Newtonians. Newton advocated that gravity was transmitted through some substance. This substance is commonly called the *ether* (also spelled "æther"). Modern science denies the existence of the ether yet they speak of *fields*, which have no substance.

Newton and Boyle

From Newton's letters to Bentley we see that Newton did not know the cause of gravity. He claimed only that his theory seems to work. In a letter to the alchemist, Robert Boyle, Newton did venture out with a bit of speculation about the nature of the ether and its relation to gravity. In that letter Newton wrote:

I shall set down one conjecture more, which came into my mind now as I was writing this letter. It is about the cause of gravity. For this end I will suppose æther to consist of parts differing from one another in subtlety by indefinite degrees: that in the pores of bodies there is less of the grosser æther, in proportion to the finer, than in open spaces; and consequently, that in the great body of the earth there is much less of the grosser æther, in proportion to the finer, than in the regions of the air: and that yet the grosser æther in the air affects the upper regions of the earth, and the finer æther of the earth the lower regions of the air, in such a manner, that from the top of the air to the surface of the earth, and again from the surface of the earth to the centre thereof, the æther is insensibly finer and finer. Imagine now any body suspended in the air, or lying on the earth: and the æther being by the hypothesis grosser than the pores, which are in the upper parts of the body, than in those which are in its lower parts, and that grosser æther being less apt to be lodged in those pores, than the finer æther below, it will endeavour to get out and give way to the finer æther be-

low, which cannot be without the bodies descending to make room for it to go out into. ...

For my own part, I have so little fancy to things of this nature, that, had not your encouragement moved me to it, I should never, I think, have thus far set pen to paper about them.⁹

Actually, Newton vacillated somewhat regarding the existence or nature of the ether. In both the early and late stages of his life he was pro-ether; but between roughly 1670 and 1700, because of the way the vortex theory was used to abuse the Bible in France, Newton opposed the popular ether theories.

Newton and Berkeley

As was stated earlier when we talked about the Newtonians, the most vocal and influential opponent of Newton in his later years was the Irish Bishop, George Berkeley. Actually, Berkeley assailed Newton less than he attacked the Newtonians; but his points were well taken and his views influenced several nineteenth century physicists, of whom Ernst Mach was the most prominent.

Berkeley, as Newton, knew that the concepts of acceleration, force, attraction, and gravitation are all mathematical hypotheses and, as such, are only computational aids that do not necessarily have any *causal* connection with the real world. Berkeley held that mathematical hypotheses or constructs do not necessarily claim and, indeed cannot claim, that there exists anything in nature that corresponds to the construct. In other words, just because one can formulate an equation, it does not follow that the equation is truly indicative of some process or natural law. This view was a major departure from the Pythagorean view where the geometry of a situation is taken as the whole essence and truth of that situation. Thus, to Berkeley and Newton, mathematical procedures are concerned with questions of usefulness, not questions of truth.

On the several points mentioned above, Newton and Berkeley stood together against the Newtonians who got their start from the theories of Newton but departed from Newton's philosophical persuasions. Even before Newton's death the Newtonians carried the day in their disagreement with their namesake, and even Newton and Berkeley did have their differences. Whereas Newton believed in absolute space and absolute motion, Berkeley did not. Berkeley maintained that motion is purely relative; that things move relative to one another. Thus two passengers sitting on the same carriage do not move relative to each other, but they do move relative to the ground and the town through which the carriage is passing. In the final analysis, according to Berkeley, all things move relative to the stars or the universe. In essence this makes the universe the absolute standard of rest against which all motions are to be measured, but most relativists never seem to notice or acknowledge this. More than a century later, Berkeley's views would be rediscovered and broadened by Ernst Mach; but in the meantime, the Newtonians regarded Berkeley as much an oddity as they did Newton.

Science of the Newtonians

What finally did arise from the philosophical debates between Newton, Berkeley and the Newtonians was the conclusion that science is a matter of interpretation. The Newtonians would disagree with this and scientists may laugh with scorn and deride the theologians for their lack of certainty as to different interpretations of Bible texts, but these same scientists turn a blind eye to the fact that scientific explanations progress in the same manner. Popper is wrong when he states that:

...science aims at *true* theories, even though we can never be sure that any particular theory is true.¹⁰

True enough, science does not deal with absolutes and so it is not a way to ascertain absolute truth because science can never be certain

that any particular theory is true; but Popper to the contrary, science does not aim at true theories for the sole reason that science cannot say what—or more properly, *Who*—truth is.

Science is practiced by people who have devoted their lives to building an edifice with which they are both conversant and comfortable. True revolutionary ideas seldom come from established scientists. After all, heliocentrism came from a man whose bread-and-butter was his clerical office and his astrological charting; while modern geology came from a lawyer whose goal was the overthrow of the British government (Charles Lyell, 1797-1875),¹¹ and evolution came from a disinterested clergyman (Charles Darwin, 1809-1882). These were all outsiders looking in, not “recognized authorities” in their respective scientific fields. No, science does not aim at “true” theories; instead, it aims either at convenient theories, theories which fit into certain prevalent or preconceived notions, or else it aims at “beautiful” theories. Science is purely a matter of opinion. Belief in the scientific method—hypothesize, test the hypothesis, then accept or reject the hypothesis based on the test result—is nothing more than a leap of faith and is rarely done in practice. Most science is conjectural in nature, starting with and stemming from the myths of the ancients. Both Newton and Berkeley recognized this fact, which Kant alluded to in the chapter quote,

Newton's Dynamics goes essentially beyond all observations. It is universal, exact and abstract; it arose historically out of myths; and we can show by purely logical means that it is not derivable from observation-statements.

But this the Newtonians could not acknowledge, and it was also lost on Copernicus, Kepler, and Galileo.

Newton's View of Gravity

Newton considered his theological writings the most important of all his works, but it is his formulation of gravity for which he is most remembered. Newton made no claims to know the nature of gravity. That claim is made of Einstein, but in the final analysis Einstein, too, did not know. So we are left with the question, "just what is gravity?" About that question Newton wrote:

It is inconceivable that inanimate brute matter should, without mediation of something else, which is not material, operate upon, and affect other matter without mutual contact....¹²

Newton regarded as unphysical the idea of a force acting upon two bodies with only a vacuum between them. Today only a handful of physicists would agree with Newton. Newton believed that there is some intervening medium which transmits the force through space. Of the handful of theories which have been proposed to account for Newtonian gravitation, the two most physical are that of Nicolas Fatio de Duillier (1664-1753, Figure 3), a Swiss mathematician, and another originating with the ancient Greeks that results from viewing the ether as a *plenum*, an infinitely dense medium. We presented the plenum model in Chapter 6, "The Firmament" but here we shall only concern ourselves with de Duillier's model which is most commonly known as Le Sage's Theory after the name of the Genevan, George-Louis Le Sage (1724-1803, Figure 4) to whom de Duillier willed his papers upon his death.



Figure 4: Nicholas de Duillier

Le Sage's Theory of Gravity

Le Sage's theory involves a simple story of plagiarism. Fatio de Duillier first proposed the theory, and at his death he bequeathed all his scientific papers to Le Sage. Le Sage promoted de Duillier's work as original, and the theory has been called by his name ever since.¹³

According to the theory,¹⁴ the universe contains two types of atoms or components. The ether is made up of what Le Sage termed *ultramundane corpuscles* while physical bodies, such as the earth, are constructed as various lattices of *mundane corpuscles*. De Duillier showed that if the universe is flooded with rapidly moving ultramundane corpuscles moving in all directions, and that if the ultramundane corpuscles occasionally collide with mundane corpuscles, that bodies such as the earth would partially shield objects on its surface from part of the universe's corpuscular flow. As a result of the shielding, the imbalance in the corpuscular flow presses objects to the surface of the earth and it is this pressure that we call gravity. The theory continued that as a result of the shielding, two planets would be pressed toward each other and that the resulting pressure between them would translate itself as a force identical to Newton's law of gravity. In other words, Le Sage's theory of gravity is a physical way to produce Newton's gravitational formula.

During the 1980s James Nolen Hanson (1933-) reexamined Le Sage's approach and greatly expanded it. Hanson's work was able



Figure 5: George-Louis Le Sage

to account for phenomena not otherwise accounted for such as Daniel Long's ring-and-ball result¹⁵ and the anomalous results observed in pendulums in deep mine shafts. These anomalous results can all be accounted for by gravitational shielding, the very essence of Le Sage's gravitational model.

The ultramundane corpuscles of the theory are very small and are in some respects akin to the modern idea of the neutrino. If the ultramundane corpuscles collide with each other and with mundane corpuscles; and if these collisions are hard or inelastic (that is to say that they do not bounce off each other but stick together after impact), then the necessary flux of corpuscles to account for gravity would melt any solid object in a fraction of a second according to William Thomson, also called Lord Kelvin (1824-1907).¹⁶ This time is so short that it would not allow the earth to exist at all. But if the corpuscles are allowed to experience elastic collisions, that is, if they are viewed as bouncing off each other without sticking together, then Kelvin allows that the heating of a body is not a major problem. Given the observation that there is no such thing as a perfectly elastic collision, the force of gravity should be gradually decreasing in Le Sage's model. Although there is some doubt as to the veracity of the observation, such a decline in the gravitational strength was reported by Thomas van Flandern (1940-2009) while at the United States Naval Observatory.¹⁷ Indeed, such a decline in gravitational strength could account for some, if not all, of the phenomena now attributed to the invisible dark matter.

In 1905, George Darwin (1845-1912) calculated the Le Sagean gravitational force between close bodies and concluded that Newton's gravitational law would only hold if the corpuscles were stopped dead in their collisions with the bodies.¹⁸ Darwin's conclusion confirms the heat problem with Le Sage's theory. Unfortunately, Le Sage's model is the only testable model of gravity we have. Einstein's curved space model is circular, *viz.* gravity is due to the curvature of space and the gravitational field of a mass is what curves space. That teaches us nothing about the nature of

gravity. Various explanations have been proposed to keep the universe cool in the Le Sagean model of gravity, and such explanations are by no means exhausted. An experiment capable of deciding the veracity of the theory has been devised and has been presented a number of times in the *Bulletin of the Tychonian Society*, but it has yet to be performed.¹⁹

Le Sage's theory can be true in either a geocentric or a heliocentric universe. It serves to illustrate the metaphysics of modern gravitational theory which has no explanation for gravity. By contrast, Le Sage's theory involves a real, physical gravity. A mathematical treatment of Le Sage's theory has been undertaken by James Hanson; but his work has yet to be published. Among published analyses of Le Sage's theory the most comprehensive and readily available is the work of the Brazilian, André Assis (1962-).²⁰ Hanson's approach does explain quite a few puzzling experimental results which have been recorded this century, particularly the perihelion precessions for *all* the planets, and the change in period of pendulums during solar eclipses and in mine shafts. In comparison, Newton's and Einstein's theories have no physical basis. Terms like "a bend in the space-time continuum" are contentless, solving nothing; for what makes objects "roll" down the bend? Theories like that cannot be meaningful; especially not if, as Einstein did, we throw out the ether. We shall have more to say of such matters in later chapters. For now, suffice it to say, along with Hoyle and Narlikar, that when it comes to gravitation, modern science deals with anything but physical reality. Is it any wonder that gravitation is still a complete mystery, science being unable to ascertain the nature and source of gravity let alone being able to answer the question of what gravity really is.²¹

Conclusion

In conclusion, we note that Newton discovered the law of gravity but could not find any cause for gravity. Newton was aware of de Duillier's theory and entertained it as a possibility. At

least, as a reasonable cause for gravity it did not violate causality as did the gravity of the Newtonians after Newton. Today, of course, we are told that gravity is caused by the curvature of space, but we shall examine that in the context of relativity in Chapter 33.

It was the Newtonians, not Newton, who were responsible for claiming that gravitational effects such as the tides and the orbit of the earth about the sun could be invoked as proofs of the Copernican system. Newton was more cautious, however, and would make no such rash claims. Yet the false proofs of the Newtonians are still in vogue today in the forms of wind patterns, the Foucault pendulum, and geostationary satellites. We shall look at the Newtonian's alleged proofs of heliocentrism in the course of the next few chapters.

The ultimate strategic question of modern science is this: At what point should one acknowledge that scientific explanation has gone as far as it can go? That is, at what point ought a theistic philosophical explanation be accepted as a satisfactory one where no merely empirical one appears possible?

— Dean Turner¹

FORCE-BASED PROOFS OF THE NEWTONIANS

After Newton, and contrary to the objections of both Newton and Berkeley, the self-avowed followers of Newton, commonly called *Newtonians*, concluded that the revolution and rotation of the earth were *proven facts*. Newton, himself, did not offer any such proofs and rejected all proofs proffered. Because the Newtonians continued in their insistence that the Copernican model was proven, during the two centuries after Newton the Newtonian's proofless proofs for the Copernican model seemed to mount to such overwhelming heights that the biblical doctrine of the stationary earth was nearly eradicated among scientists. Not until the early nineteenth century, when problems arose with the Newtonians' model of the universe, was there a resurgence of the geocentric model, specifically, of the Tychonic model (see Chapter 24).

The Newtonian "proofs" fall into four categories:

1. Those that are based on centrifugal force;
2. Those that are based on the Coriolis force;
3. Those involving both centrifugal and Coriolis forces;

4. Those that are based on electromagnetic phenomena such as light.

I'm afraid that at this point I have to wax a bit technical. Those of you who have taken a high school physics course should do fine. We start out with the Newtonians' definition of force, namely force equals mass times acceleration or, symbolically: $F=ma$. The use of the bold face in this definition indicates the F and a are *vectors*.

A vector is a symbolic representation of anything that acts in a particular direction with a certain magnitude or strength. For instance, suppose you are driving due east on a freeway at 60 miles per hour. A vector representation of that situation would be an arrow pointing to the east (or to the right) with a length corresponding to 60 mph (Thus 6 inches long if the scale is 10 mph per inch). If you slowed to 30 mph, the arrow would still point to the east (right) but would now be half the length (3 inches) that it had at 60 mph. Thus a vector represents both the magnitude and direction of an action imposed on an object.

Returning to the Newtonians' definition of force, note that the mass m is not a vector. (It is called a *scalar* because it only has magnitude but acts in no direction.) In particular, m is a constant of proportionality.

Force is needed to change an object's location or direction of motion. You exert force to lift a box from the floor. As you hold it aloft, you feel a downwards force, called *weight*, because the gravitational field of the earth exerts an *acceleration*, usually denoted as $-g$, where the minus sign indicates a downwards direction.

If, while holding the box, you were to spin around, you would also feel a force pulling the box outward from your body. We commonly call this *centrifugal force*. If we set the box on a rotating platform such as a carousel and then step onto the carousel, pick up the box and walk with it, we would feel a force that fights to deflect us from a straight path. That force is called the *Coriolis force*. Finally, and back on solid ground, if the box contained a

spinning gyroscope and we manipulated the box in various ways such as turning it upside down, the box would react in strange ways. The force that thus reacts to our motions in the gyroscopic case is called the *Euler force*.

Real and Fictitious Forces

In modern, heliocentric physics there are two types of forces: *real* and *fictitious*. Real forces are said to be “Dynamic” while fictitious forces are described as “Kinematic.” A real force is called a “Force.” A fictitious force is called an “Effect.”

Think back to the centrifugal-force case of our experiment. The inward force you exerted to keep the box next to you when you spun yourself with the box in your hands is considered a real force and is called the “Centripetal force.” The outward force you fought to keep the box next to you was due to a fictitious force called the “Centrifugal “effect.” Still, you felt that outward, “fictitious” force didn’t you? So how come we have two types of forces: real forces, also known as “Inertial forces” and their equal and opposite *effects*, also known as “Fictitious forces”?

The difference between real and fictitious forces is an artifact of the Newtonians’ chicanery to populate the Copernican system with proofs. In the theory of geocentricity, there is no distinction between real and fictitious forces; both are real, inertial, that is to say, gravitational forces. Furthermore, in geocentric theory inertial force is a synonym for gravitational force, specifically the gravitational field which I call the “Cosmic gravitational field.”

Newton’s original definition of force was stated as a change in momentum but we will not go that far here.² Instead, we shall write Newton’s definition of force as $F - ma = 0$, which today is rewritten as $F = ma$. The way Newton wrote his formula as a zero sum because for every force there is an equal and opposite reaction. Thus the net force of the action less the reaction is zero. Also, the way Newton stated his definition puts no constraints on the nature of F .

It is telling that the centrifugal force case, namely our box-spinning example above, is the only one that names both "effect" and "force." In that example, the centripetal, inward force is deemed real and the centrifugal, outward force is deemed fictitious. Note that the mass of the box did not change. That means that the force, F depended only on a , the acceleration. It was acceleration with respect to the firmament that is considered real. In that case, the mass was irrelevant, for if the mass of the box figured to a real force when you pulled it towards you but a fictitious force which you countered by your pull, then we have the following equality: $F_i = F_o$ where F_i is the inward force or the "real" centripetal force and F_o is the outward force, the "fictitious" centrifugal force. From the Newtonians' definition of force we can rewrite this equality as $ma_i = ma_o$ where the box's mass, m disappears if we divide both sides by m . *Only acceleration matters, not mass.*

To arrive at a generalized force equation, we combine the forces we considered above into a general statement:

$$0 = \text{Imposed force} - \text{centrifugal} - \text{Coriolis} - \text{Euler forces.}$$

This is the geocentric definition of force. Each term is of the form mass times acceleration, so each term includes an m and we can divide both sides by the mass and be left with pure accelerations.

The study of the behavior of the acceleration version of the generalized force equation is called *Kinematics*. Multiplying both sides of the acceleration equation by the mass yields *Dynamics*. There is no argument that geocentricity is kinematically correct, even among the Newtonians; the argument is whether or not geocentricity can handle the dynamic case, that is, the generalized force equation. But as summarized in Appendix E, the dynamic case is simply the kinetic case with one side multiplied by one, i.e., m/m . It is hard to see why the dynamic case would be more significant than the kinetic. The only reason is because philosophically we think of mass as more significant than acceleration, but

what if acceleration was all there was to force and the mass is just added baggage? It's another legitimate way of looking at force.

Conclusion

Geocentrically speaking, the firmament is the main player in what determines accelerations. We think that the most massive object is the "boss" when it comes to forces, but in this chapter we show that the distinction between the dynamic and kinematic views of force is artificial, the dynamic equation being the product of judiciously multiplying the kinematic equation by one. As a result, arguing that the sun is the most massive thing in the solar system and so must overrule the less massive earth as the "boss" of the solar system is no longer sound. Even so, there is one created thing that is so massive that it can overrule the entire universe, let alone the sun, and that "thing" is the firmament. After all, one cubic centimeter—the size of a small sugar cube—of the firmament is more massive than a ten trillion trillion trillion universes. Despite that immensity, most people choose to believe that the firmament can be ignored when it comes to gravitational forces and dynamics. We postulate that dynamics for the universe's daily rotation about the earth is inherent to the firmament.* How did God implement geocentricity as part and parcel of the firmament? We're still running that maze. For the time being all we can say is that God simply made it that way. And he is infinitely greater than the firmament, let alone infinitely wiser than we.

It is time to introduce the Newtonian proofs based on the "fictitious centrifugal" force.

* The theory of relativity long ago showed that the universe could be geocentric for the case of the rotating earth. Indeed, our website has long listed references to that effect. But relativity is not designed to handle rotating systems. To see why this is so, the interested reader is referred to *The Einstein Papers* from which our chapter quote originates.

In a universe which, like ours, contains many bodies, there can be innumerable subsystems that are effectively isolated from one another. This is true of the solar system within the Galaxy, Each subsystem, considered by itself, can have non-zero energy and angular momentum. However, if the universe is finite, the individual energies and angular momenta of its subsystems can add up to zero. In a universe governed by Newton's laws this would be an implausible fluke. But if the universe is governed by the Machian law, it must be the case. It is a direct consequence of the law. What is more, the Machian law predicts that in a large universe all sufficiently isolated systems will behave exactly as Newton predicted. In particular, they can have non-zero energy and angular momentum, and therefore seem to be obeying Newton's laws in absolute space and time. But what Newton took to be an unalterable absolute framework is shown in the Machian theory to be simply the effect of the universe as a whole and the one law that governs it.

—J. B. Barbour¹

PROOFS BASED ON CENTRIFUGAL FORCE

Centrifugal force is the outward pull felt on a swing or while making a sudden turn in an automobile. Even Newton used centrifugal force as a proof, albeit not a proof of heliocentrism but as a proof of absolute space. Imagine a cup of water. The surface of the water will be flat. Now stir the water. As the water circles faster and faster in the cup, its surface becomes more and more concave. Since the water is rotating with respect to the firmament, Newton concluded that the concavity provided evidence of an absolute, immovable space. The force that distorts the surface of the water is commonly called *centrifugal force*.

Most of the Newtonians' proofs for heliocentrism based on centrifugal force involve an orbit of some kind. These alleged proofs include the equatorial bulge of the earth and the stationary satellite. So let's start with a look at how an orbit works.



Figure 1: *At five miles per second, a near-earth satellite falls toward earth at the same rate as the earth's surface curves underneath it. Thus the satellite stays at the same height above the surface of the earth and remains in orbit.*

In Figure 1, the earth's surface curves 16 feet in five miles. If a rock is released from a height of 16 feet, it will take one second to hit the ground. Now if we could send a rocket moving horizontally at 5 miles per second, then in the second it travels 5 miles it also falls 16 feet towards the earth; but at the same time the earth also curves 16 feet underneath the rocket. The rocket appears to stay a constant height above the surface of the earth. That is how an orbit works.

In Figure 1, the earth's gravity pulls the rocket down to earth's center. The force exerted by the earth and acting on the rocket is due to earth's gravity and is called centripetal force. But we also know from experience that if you twirl a sling and stone above our head, you feel an outward force pulling on your hand. That force is called the centrifugal effect. If the earth pulls on the rocket to keep the rocket circling the earth, then there must also be an upward force. Why is the outward centrifugal force then called an "effect"?

As explained in Chapter 27, according to modern physics, centrifugal force is not a *real* force but a *fictitious* force and is thus referred to as the centrifugal *effect*, not centrifugal force. Technically, the centrifugal effect is the acceleration caused by the change in direction of a body, such as a stone whirled in a sling or as encountered by the water molecules stirred in the cup. Even though it is called a fictitious force, the outward force is a real, gravitational force that is commonly called "Inertia." In the case of whirling a stone in a sling, the inward force applied by your hand is called the "Centripetal force" and matches the outward centrifugal force.

When the sling is released, you stop applying the centripetal force that pulls the stone around you; the cosmic gravitational field that supplied the matching centrifugal force also stops its pull and the stone flies straight to its target. In the geocentric case, both centripetal and centrifugal forces are *real* forces and therefore I call them both forces throughout the book except for such a case where I need to explain the difference lest heliocentrists reading this explanation may not "get it" and conclude that I don't know what I'm talking about. There's nothing new or radical in what I say here; all I'm doing is pointing out that the Newtonian Emperor, garbed in his finest heliocentric proofs, is wearing no clothes.

Inertia Then and Now

Newton was the first to reduce force to an equation. As we saw in Chapter 27, Newton came up with a very simple formula, namely, $F - m a = 0$.^{*} Here F represents the force, m is the mass, and a is acceleration. In plain English, the equation says that for every action (F) there is an equal and opposite reaction ($-ma$). Thus the action minus reaction equals zero. The formula is called Newton's law of inertia. In the case of the rock swung overhead, the centripetal force is exerted by your hand on the rock of mass,

* Again, the bold letters signify a vector quantity. By *vector* is meant any force that acts in a specific direction with a certain strength, known as its *magnitude*. (See chapter 27.)

m , producing an acceleration that bends the rock's path into a circle. The inertia of the universe expresses itself as the centrifugal force. That is the simplest explanation we have for inertia and gravity; both are caused by the presence of a cosmic gravitational field.

It took a long time for physicists to conclude that gravity was responsible for inertia. Other suspected causes of inertia included the ether, electromagnetism, and space itself. Newton thought inertia was due to absolute space, which absolute is, as we saw in Chapter 6, a property of the firmament. It was Bishop Berkeley who first argued that all motion is relative, but the Newtonians dismissed Berkeley as a religious buffoon. The firmament is absolute space; but the atomic universe is relative space. In the final analysis, inertia is synonymous with gravity and we could conclude that there is only gravity, there is no inertia. But we have these conventions; traditions, if you prefer.

In 1970, C. Gregory Hood² revived Berkeley's argument when he discovered that by rephrasing Newton's laws using variables measured relative to two interacting masses (the "two-body problem," as astronomers call it), "the law of inertia is no longer required." Also, use of the relative variables "allows time and space invariance to include observers who are accelerating" or decelerating. That magnificently obscure verbiage of the previous sentence means nothing more than that the use of Hood's relative variables shows that it does not matter which is turning, the rock about your head, or the universe, with you included, all spinning around a stationary rock. The results are the same. Hood's approach reduces Newton's three laws to one law—the law of gravity. This means, as Hood writes, "the law of inertia need never be appealed to."³ Invoking inertia amounts to invoking gravity, so we do not need both concepts; inertia is no longer a mysterious property of space but is, instead, a needless concept, being nothing more than a synonym for gravity. We drew the same conclusion in Chapter 27.

Hood's discovery only pertained to the atomic universe, not to the firmament. This confirms what we said earlier, that the atomic universe is relative space while the Planck-particle firmament is

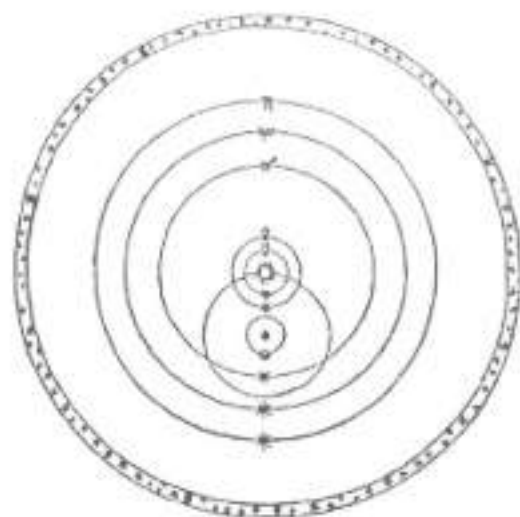

Figure 2: *Schematic of the Modified Tychonic Model*

absolute space, absolute insofar as a light's wave properties and the originator of all gravitational fields are concerned. The atomic universe manifests light not as a wave but as a photon-particle. Likewise, if the earth is at the center of mass, also known as the barycenter of the firmament, and if the earth's gravitational field originates or is rooted into the firmament's gravitational field, and if also the earth is at the bary-

center of the universe, then the earth's gravitational field is rooted to both the firmament's and the universe's gravitational fields, thus constituting a unified cosmic gravitational field. However, things really get interesting if the earth's and firmament's gravitational fields are superimposed but the sun is at the atomic universe's barycenter. Then each particle in the universe, in addition to its motions imposed by its local environment, would also have imposed upon it an average motion that parallels the yearly pattern the sun traces out in earth's sky. That model corresponds exactly to the Modified Tychonic system (Figure 2) which is Tycho's original model except with the outer, starry shell centered on the sun instead of centered on the earth.

Mach's Principle

In the nineteenth century the German natural philosopher, Ernst Mach (1838-1916), built on Berkeley's theory and proposed that the universe's gravitational field is the cause of inertia. (Most of what Mach wrote about relative motion came from Berkeley.⁴) Beyond that, Mach claimed that without the universe there would

be no gravity at all. Still, Mach had no direct proof even though Einstein christened Mach's perspective as *Mach's principle*, by which name it is still known today. Mach's principle says that Newton's law of inertia—his definition of force—is caused by the gravitational presence of all the matter of the universe.⁵

Mach's principle can be considered an alias for *geocentricity*. That conclusion has been true all along, albeit rarely spoken. Most people labor under the mistaken assumption that a geocentric universe would have a physics that is radically different from a heliocentric one, but that is not true. The matter of just how untrue that is, we shall defer until after the presentation of the various proofs. For now we conclude that both the centrifugal and centripetal forces have a common cause, even the gravitational field of the cosmos and both are real, gravitational forces.

We now examine the centrifugal phenomena that Newtonians claim as proofs of Copernicanism.

Earth's Oblateness

The first of the centrifugal force "proofs" promoted as a proof of the rotation of the earth is the oblateness of the earth. As the earth rotates, the reasoning goes, the centrifugal force at the equator pulls the earth's figure out of shape. In 1671, two years after Dominique Cassini was appointed director of the Paris Observatory (see Chapter 25), King Louis XIV sent Jean Richer (1630-1696), to Cayenne, the capital city of French Guiana on the northeast coast of South America. Richer was part of a team sent to measure the parallax of Mars, which did serve to establish the size of the solar system, but he was also commissioned to take measurements of the period of a pendulum's swing at different latitudes. In Cayenne, Richer noted that his pendulum clock ran slower than it did in Paris. Later, Newton used Richer's measurements to show that the earth was an oblate or flattened sphere. Newton's laws provided a ready explanation for that effect, for according to Newton, the centrifugal force of the earth's rotation causes the earth to bulge at the equator. This bulging is called the "Oblateness of the

earth.” As a result of the bulge, the equator is 26 miles (43 km) further from the center of the earth than are the poles and so the force of gravity is less at the equator than at the poles. This, in turn, caused Richer’s pendulum to run slower at Cayenne.

The Newtonians claim that the oblateness of the earth is proof that the earth rotates. The reasoning goes that the universe provides an *inertial frame of reference*. What that means is that the mass of the universe establishes a force, a gravitational field, which affects bodies within it. That universal gravitational field is believed to pull the earth out of shape to bulge at the equator. The equatorial bulge is nothing more than the centrifugal force acting on the atoms and molecules of the earth and plastically deforming the shape of the earth from a sphere to an oblate spheroid. Originally, when the Newtonians declared that the oblateness of the earth was proof of the rotation of the earth, inertia was a property associated with absolute space. Inertia was not recognized as due to gravity until the early 1800s. In Hood’s examination of relative motion (see above), inertia disappeared, meaning that we will get the same results whether the earth is daily rotating in the universe or the universe daily rotates about the earth. Thus the Newtonians were wrong; the oblateness of the earth offers no proof for either heliocentric or geocentric theories.

The Geostationary Satellite

Our second example of a centrifugal force “proof” of Copernicanism is the case of the geostationary satellite. In this case, people assume that since the satellite hovers above the same spot on earth, it should fall to earth in a geocentric system.

First, we consider some terminology. A *geostationary orbit* is a circular prograde

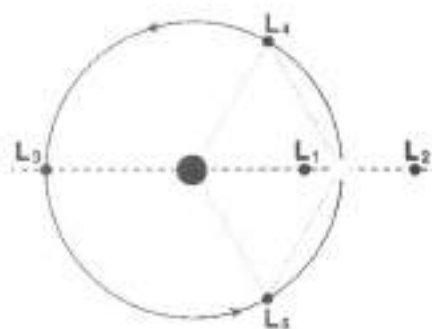

Figure 3: The Five Lagrangian Points for Sun (center) and Earth (right)

(eastward) orbit in earth's equatorial plane with an orbital period equal to that of the earth's day. This is achieved at an orbital height of 22,187 miles (35,786 km) above the equator. A satellite in a geostationary orbit will appear fixed above the surface of the earth, *i.e.* at a fixed latitude and longitude. In practice, the orbit has small non-zero values for inclination to the equatorial plane and eccentricity, meaning that no orbit is perfectly circular, causing the satellite to trace out a small figure 8 in the sky. Ideally, a geostationary satellite hovers above a point on the equator.

Stationary satellite is another term often applied to a geostationary satellite, but it begs the question, stationary with respect to what? Of course, stationary with respect to the earth may be meant, and in that sense, geostationary satellites are stationary satellites, but there are other places where a satellite can be stationary relative to the earth and yet not orbit the earth. There are five such places called *Lagrangian points*. We know that orbits closer to the sun require an object to go faster to stay in orbit. Mercury, for example, is about 40% of the distance from the sun to the earth and orbits the sun in 88 days. It would seem that we could not have an earth-stationary satellite between the earth and sun, but there are several in existence. If the distance is just right, about four times the distance to the moon or $1/100^{\text{th}}$ the distance to the sun, the sun's gravitational pull and the earth's gravitational pull will cancel each other, and a spacecraft at that location will need just one year to go around the sun to keep its position between the sun and the earth. This is called the *L1 Lagrangian point* (cf. Figure 3). The SOHO (Solar and Heliospheric Observatory) and ACE (Advanced Composition Explorer) satellites, both of which monitor the solar wind, are located at the L1 Lagrangian point along the earth-sun line. These are stationary satellites relative to the earth, but they are not in orbit about the earth.

The third term refers to *geosynchronous satellites*. Any satellite with a 24-hour period is geosynchronous. Thus all geostationary satellites are geosynchronous, but not all geosynchronous satellites are geostationary. Instead of hovering over one point on the equator geosynchronous satellites can cross over the same point on

the equator once a day. Geosynchronous satellite orbits can have any inclination to the plane of the equator, including those in a polar orbit, which means they pass directly over each pole once an orbit, that is, once a day. The only requirement of a geosynchronous satellite is that it have an orbital period of 24 hours.

From the above terminology we see that the correct term to describe a satellite that hovers over the same point on the equator is *geostationary*. Our question then is, in a geocentric system, why does the geostationary satellite not fall to earth?

Note that a geostationary satellite is stationary with respect to the earth, but it is not stationary with respect to the stars, that is, relative to the cosmic gravitational field. From the universe's point of view, the geostationary satellite stays up because it is orbiting the earth with a period of 24 hours. Thus the satellite cannot fall to earth; its centripetal and centrifugal forces are balanced. Remember, both those forces are real, gravitational forces in a geocentric universe. The centripetal force is caused by earth's gravity, and the cosmic gravitational field contributes the centrifugal force. We can truly say that it is the cosmos as a whole that keeps all satellites in orbit, including the stationary satellite.

Is it possible to put a satellite in orbit about the earth's equator which satellite will always stand still relative to the stars? (That is, the satellite would appear as a fixed star in a constellation located over the equator.) Such a satellite would be in a retrograde orbit, going from east-to-west with a 24-hour period instead of the usual west-to-east (prograde) orbital direction. It turns out that it is not possible to put a satellite in such an orbit because there is no east-west centrifugal force to counterbalance the earth's gravitational force. Such a satellite will fall to earth, regardless of whether or not the earth is rotating! The only stable orbit is one which has no east-west component, namely a satellite in a polar orbit which makes that a geosynchronous satellite.

In a geocentric universe it is centrifugal, gravitational force that keeps all satellites in orbit. In particular, then, it keeps the geostationary satellite up, too.

Orbital "Proofs"

It is perhaps much easier to accept that the cosmic gravitational field is responsible for the Coriolis and centrifugal effects than that it is also responsible for the sun's yearly motion about the earth. As men, we are predisposed to believe that the biggest object has the greatest influence. Thus the big nations lord it over the small ones, the big man will beat a small man in a fist fight, and the big sun will rule the small planets. Thus the sun, being the most massive object in the solar system, is supposed to be the ruler of the entire solar system.

In each of the above examples of big dominates small, we blindly assume the perspective of natural religion (naturalism), the religion that emerged among European scientists and philosophers in the seventeenth and eighteenth centuries as a result of the Copernican controversy.⁶ In a naturalist's view, might makes right, and to believe that the earth is the center of creation is ridiculous egotism, if not the height of arrogance. Yet, as history would have it, even natural religion had to compromise when confronted by geocentric evidence of the universe; naturalism even had to invent a new branch of physics, theoretical physics, and change the laws of motion to fit the geocentric evidence into the heliocentric model. Those actions resulted in the special and general theories of relativity. (See Appendix E for a derivation of the underlying principles that allow the earth to be at rest at the center of creation. The derivation in Appendix E shows that in a daily-rotating universe, the stars will follow the paths we see them have in the sky in the same type of "proof" used by the Newtonians.) If the same orbital equation proves both heliocentrism and geocentricity, clearly it is not a proof at all.

We spoke earlier in this chapter of Mach's principle. Mach's principle is the polite way of saying geocentricity in today's scholarly society. Several physicists have constructed mathematical models of the universe that conform to Mach's principle. Not all are equally successful, but perhaps the most successful is that published by Barbour and Bertotti in 1977.⁷ Another successful im-

plementation of Mach's principle was derived by Assis.⁸ Einstein had this to say after reading the Machian-inspired 1918 paper by Josef Lense and Hans Thirring:⁹

It shows that the presence of the shell of inert mass increases the inertial mass of the material point inside it. This suggests that the inertia of a material particle is *entirely* due to the influence of all other masses through an interaction of some kind.

In a geocentric universe, the earth is that "material particle" Einstein mentioned in the quote. With the earth at the center of mass, or barycenter of the universe, it is as if all the mass of the universe is invested in the earth. This does not mean that the earth is the most massive thing in the universe, mind you; it means that objects away from the center of mass of the universe, *perceive* the earth as immovable. Indeed, as Misner, Thorne, and Wheeler implied in comments they made, it is as if the whole universe fights to keep the earth fixed at its central station.¹⁰ The best we can say of that "interaction of some kind," as Einstein put it, is that it is gravitational in nature. That is what Barbour and Bertotti contributed to Mach's principle. Underneath the verbiage lies the conclusion that mass itself is due to the presence of the universe and that in an empty universe, a lone object would have no mass at all, regardless of how big it is.

We see then that proofs of Copernicanism based on orbital behavior are not proofs at all. As things now stand in science, proofs are almost impossible to come by.

Conclusion

In this chapter we looked at the proofs for Copernicanism based on centrifugal force. Many of these proofs are still found in today's textbooks although their inefficacy as proofs has been known to physics and astronomy for more than a century. We examined the earth's oblateness, the geostationary satellite, and orbital proofs and found that they exist in both the geocentric and

modern, acentric universes; furthermore, the equations derived from these models are fundamentally the same.

Working strictly from the equations, geocentricity is perfectly possible as documented in Appendix E. But when it comes to proofs for or against either geocentricity or heliocentrism, there is not much hope.

The surprising truth is that ALL FOUCAULT PENDULUMS ARE FAKES. Most of them are fakes because they are forced to do what they do, rather than doing what comes naturally, and all the rest of them are fakes insofar as they are used as proof of the earth's rotation. [Emphasis sic.]

—Richard Elmendorf¹

PROOFS BASED ON THE CORIOLIS FORCE

Whereas centrifugal effects operate towards or away from the center of motion, Coriolis effects manifest themselves perpendicular to the direction of motion in a rotating system. The Coriolis effect is named after the first man to recognize its effects on ocean currents, the French scientist Gaspard-Gustave Coriolis (1792-1843, Figure 1). Like the centrifugal force, the Coriolis force is a fictitious force in the heliocentric model. In the theory of geocentricity, it is a real force, induced by the cosmic gravitational field.



Figure 1: *Gaspard-Gustave Coriolis*

The Coriolis force deflects a mass relative to the surface of the earth according to the following rules:

1. If the mass' velocity is parallel to the rotation axis, there is no Coriolis force to act on the mass;
2. If the mass' velocity is straight inward to the axis, the mass is deflected in the direction of the rotation;
3. If the mass' velocity is straight outward from the axis, the mass is deflected against the direction of rotation;
4. If the mass' velocity is in the direction of rotation, the mass is deflected outward from the axis;
5. If the mass' velocity is against the direction of rotation, the mass is deflected inward to the axis.

The Coriolis force is pictured in Figure 2 where it is demonstrated on a turntable. The top part of the figure shows the path a free-sliding, friction-less disk (black dot) would take on the counter-clockwise rotating turntable when pushed straight out from the center of the turntable towards the red dot. By the time the black dot arrives at the spot where the red dot was (the black dot's pictured position), the red dot has made a quarter of a counterclockwise turn. In the perspective seen from the room, the black dot slid in a straight line while the disk rotates a quarter turn underneath it. In the bottom part of the figure, we see the path of the black dot as seen from the red dot, that is, from the point of view of an observer on the disk. The black dot starts moving towards the dot but then veers to the right. This is the effect the Coriolis force has in the northern hemisphere. In the southern hemisphere the Coriolis force swerves objects to the left.*



Figure 2: *Coriolis Force on a Turntable.*

* The comparison of the veering to the left or right can be terribly confusing. As seen from the North Star, in both northern and southern hemispheres the black dot is seen to deflect to the right. An observer in the southern hemisphere is

In a geocentric universe, where the universe rotates about the earth once a day, the fictitious forces are real, gravitational forces. In that case, the cosmic gravitational field carried the disk with it in its rotation about the earth so that, in the universe's view, the disk follows the straight line shown in the upper section of Figure 2. In earth's view, the universe dragged the disk's path to the right, describing the path shown at the bottom of Figure 2. Both geocentric and heliocentric views give identical results, so the Coriolis force cannot be invoked as proof for the heliocentric or acentric views. If the Coriolis force proves the modern cosmology, then it also proves the geocentric model.

Of course, the earth is not a disk but a sphere. If you picture the upper part of Figure 2 with the rotating disk centered on the North Pole, and that the black dot starts heading for the red dot on the equator, then in six hours, the black dot would have traveled in a straight line as far as the starry universe is concerned, but as far as people on earth, and specifically a person on the equator at the red dot are concerned, the black-dot "missile" missed the red-dot target by six hours. Projecting the path the black dot traced from pole to equator onto the plane of the equator gives us the path in the bottom picture.

In the examples that follow we shall confine ourselves to the northern hemisphere. For the southern hemisphere, change left to right, and right to left, and clockwise to counterclockwise and vice versa.

The largest effects induced by the Coriolis force involve horizontal motion. In the northern hemisphere, motion parallel to the surface of the earth will veer to the right; in the southern hemisphere, it will veer to the left. There is no Coriolis effect along the surface on the equator, but there is an upward Coriolis effect which is a maximum at the equator, is non-existent at the poles, and takes on intermediate values from equator to pole. An upward motion will deflect to the east and a downward one to the west (same direction in both hemispheres). The upward deflection is not nearly

upside-down with respect to the North Star and so sees the dot from the "underside" where it is perceived as deflecting to the left.

as pronounced as the horizontal effects, but it has its uses nevertheless. The upward-downward effect exists at all latitudes; it is greatest at the equator and zero at the poles. The same effect applies if an object is going directly eastward in which case it deflects upward (feels lighter), and a westward-bound object deflects downward (feels heavier); the effect is the same in both hemispheres. These two effects are in addition to the regular horizontal motions deflecting to the right in the northern hemisphere and to the left in the southern hemisphere. However, whether the particular Coriolis force is large or small, it is equally predicted in the geocentric as well as in the modern models. The difference lies in the origin of the force; in the geocentric case it is due to the gravitational field of the universe, and in the acentric case, it is a fictitious force which is attributed to the inertia of the universe.

Weather and Ocean Patterns



Figure 3: *Low-pressure Area Over Iceland Showing the Coriolis Force*

Weather patterns give us the most obvious evidence for the Coriolis force. At mid-latitudes, such as the U.S.A., for a wind speed of about 30 feet per second (20 miles per hour or 10 meters per second), the Coriolis force would cause a clockwise air circulation pattern about 120 miles (200 km) in diameter with a period of about 14 hours. For ocean water with a current of 6 inches (10 cm) per second, the clockwise Coriolis-induced flow-circle would be a bit more than a mile (2 km) in diameter.

In a low-pressure area, also called a cyclone, the air around it wants to flow to the center of the low-pressure area. As it flows to

the center, it is deflected to the right, setting up a clockwise flow (Figure 3). In a high-pressure area, also called an anticyclone, the wind wants to go out from the center of the high-pressure area and veers to the left, forming a counterclockwise flow. Since high-pressure areas are usually cloudless, they are not easy to photograph. In the southern hemisphere the above rules are reversed.

People may invoke cyclonic and anticyclonic effects as proof of the rotation of the earth, but such a claim shows either ignorance of the nature of the Coriolis phenomena or willful deception.

The Drain Myth

There is a persistent myth that states that because of the Coriolis force, bathtubs drain counterclockwise in the northern hemisphere and clockwise in the southern. But that is not true. We saw above that for a 6-inch per second drain speed, the water cyclone induced by the cosmic gravitational field would need a bathtub more than a mile in diameter to show the Coriolis effect. Other effects determine how water drains from a bathtub. Effects such as the direction in which water was poured into the tub, the geometry of the tub, and even temperature differences in the water can determine which way the drain will flow.

Under very carefully controlled circumstances where the tub is conical, symmetric, allowed to totally settle, and more than a yard (meter) in diameter, the drain can spin fast enough that the Coriolis force figures in; but that is rarely the case.

The Foucault Pendulum

The Foucault pendulum is another example used by the Newtonian school as proof of heliocentrism. This, too, is caused by the Coriolis force.

As a youngster in school I was told, "A little knowledge can be a dangerous thing." The Foucault pendulum is an excellent example of the truth of that adage. Visit any science museum in the world and most likely you will find a Foucault pendulum there.

that, as the guide says, “proves the rotation of the earth.” Sure enough, the pendulum moves the way the guide says it does, so it must be true, right? After all, a museum would not deliberately deceive the public, would it? Well, with just a little knowledge of the Foucault pendulum, you may just be deceived into thinking that it does prove the rotation of the earth and that God’s word is nonsense.

In 1851 Jean Bernard Leon Foucault (1819-1868) suspended a 61-pound ball on a 223-foot long steel wire from the top of the dome of the Pantheon in Paris. He started it swinging and provided modern introductory physics and astronomy texts with another “proof positive” that the earth rotates (Figure 4).

To visualize this “proof,” imagine a pendulum mounted at the North Pole. As it swings the earth “turns” steadily underneath it so that, if the pendulum is allowed to scratch the snow with each swing, in twelve hours the pendulum will have scratched out a circular area in the snow underneath it. (The pendulum at the pole does take 24-hours to make a complete rotation but since both halves of the line are scratched in each swing it takes only 12 hours to fill the circle.)

Introductory physics and astronomy texts, as well as museum exhibits may present the Foucault pendulum as proof of the rota-

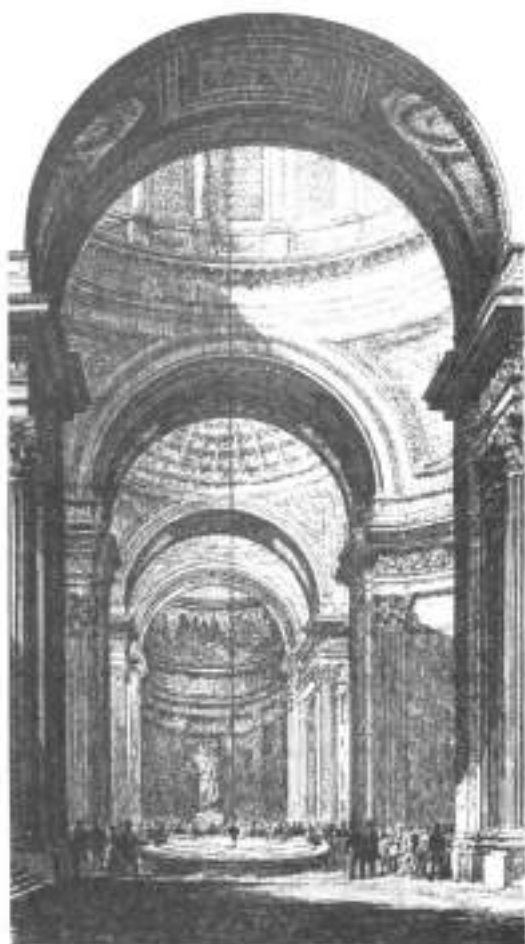

Figure 4: *Foucault's Pendulum Demonstrated in 1851 in the Pantheon.*

tion of the earth; but we have noted that the gravitational field of the universe allows the pendulum to precess the same way if the earth stands still and the universe rotates around it. In part because of the heliocentric bias, the physicists of Foucault's day did not derive the equations of motion in a geocentric system to demonstrate that the two models yield the same result but mindlessly claimed the Foucault pendulum as "proof" of the earth's diurnal rotation.

As we saw in Chapter 25, geocentrists at the time of Foucault's demonstration took issue with the way the pendulum did not conform to Foucault's simplified explanation. According to Foucault, the pendulum starts out with a north-south swing and differences in the speed of the earth's rotation, faster on the south end than on the north, sets the pendulum swinging counterclockwise. Once the swing was in the east-west direction, however, the north-south explanation no longer holds. Foucault's "simple" explanation was insufficient to explain the entire Coriolis force-induced behavior and the misunderstanding stood for almost a century. Furthermore, sometimes, if not mounted properly, the pendulum swung clockwise instead of the expected counterclockwise. Until Foucault installed a "kicker" in his pendulum's mount, his pendulum, too, swung as uncertainly as those witnessed by Tischner, which were described in Chapter 25. These problems fueled geocentrists' imaginations with conspiracy theories, and all because of oversimplifying the true behavior of the pendulum.

If the pendulum is allowed to swing long enough, it ends up swinging in a circle, not a rotating plane. This, too, is not predicted in the usual derivation of the Foucault pendulum's behavior. From 1967 to 1972 I worked and studied at the Case Western Reserve University's Warner and Swasey Observatory in East Cleveland. In the exhibit hall, by the front door, was a Foucault pendulum. Of course, students being students, we would set it swinging and watch its behavior in passing. After several hours, however, we, too, noticed that it would end up swinging in a circle. At the time we thought it was due to friction in the mount.

In 1976, when intrigued by geocentricity's possibilities, I decided to derive the pendulum's behavior as rigorously and as generally as I could. The equation of motion started out with the bob swinging in the expected plane but eventually the pendulum swung in two directions, the normal big swing, and a slowly increasing swing perpendicular to the main swing. Over time, the Foucault pendulum's swing became a widening ellipse until finally it ended up swinging in a circle, even as we had observed so many times as graduate students at the observatory.

So, you may ask, why do we not see the swing decay into a circle in the pendulums mounted in museums and observatories worldwide? In order to avoid difficult questions those pendulums either have a hammer installed at the mount that keeps the pendulum swinging in a plane or else there is a corrective electromagnetic "kick" applied by an electromagnet embedded in the floor at the bottom of the swing. The various tricks used to avoid embarrassing questions are documented in Richard Elmendorf's book, *Heliocentric Humbug! A Critical Investigation of the Foucault Pendulum*.² Although the casual reader may get the impression that Dick Elmendorf thinks the Foucault pendulum is a forgery, such is not his claim. After all, the pendulum twists the way it does because of the *relative* rotation of earth and stars, so it should work the same way in both geocentric and heliocentric universes. Indeed, theory confirms that observation.

Beyond the decay of the Foucault pendulum's swing from a plane to a circle, other effects can cause it to deviate from its computed path. That includes the gravitational fields of the sun, moon, center of the Milky Way, and Jupiter, not to mention air currents in the room and, if the ball is conductive, electromagnetic feedback from the earth's magnetic field.³ The claim that the Foucault pendulum proves the rotation of the earth falls short of the truth.

The Coriolis Force in the Theory of Geocentricity

In Chapter 7, where we looked at the sun's rule over the day, we presented the circuit of the sun as a helix traced out as a com-

bined motion of the sun's yearly motion and the daily rotation of the firmament (see Figure 7.4). The sun's yearly path is illustrated in Figure 37.5. The yearly path shown there is due to a Coriolis force generated by a wave which is described in Chapter 37. According to the theory, every particle in the universe except the earth, which is at the center of the circle described by the sun's reaction to the Coriolis force experiences the same Coriolis force as the sun, and so exactly parallels the sun's yearly path.

Conclusion

We saw first that any centripetal force pulling an object into a circular orbit or arc was opposed by the cosmic gravitational field in the form of centrifugal force. Although the centripetal force could be gravitational in nature, as it is for objects falling to or about earth, it need not be as is the case when steering a car in a curve; the resulting centrifugal force opposing the centripetal force is always a real, gravitational force. We equated inertia with the cosmic gravitational force; something that is now widely accepted among astronomers and physicists.

When it came to the Coriolis force, we dealt with bodies moving in a rotating system. The historic (heliocentric) interpretation of the Coriolis force dismisses it as a fictitious force induced by inertia. Geocentrically speaking, there is no such thing as inertia; there is only the cosmic gravitational field. The Coriolis force is induced by the cosmic gravitational field apparently to conserve angular momentum.

It is not possible to claim proof for either heliocentrism or geocentricity from the Coriolis force. Except for Scripture, there is now no way to know which rotates: the earth or the firmament.

Terrestrial experiments show terrestrial motions, whereas celestial experiments show no motion. Nobody will say this, not even Maxwell.

—James N. Hanson¹

INTRODUCTION TO OPTICAL PROOFS

So far, the Newtonians' proofs of Copernicanism have all been gravitational in nature. We now look at the so-called proofs of the earth's motion based on properties of light. It was in the realm of optical phenomena that heliocentrism lost its historic edge over the geocentric system. But to understand just how that happened we must identify the order of the experiment and the history of ideas concerning the transmission of light through space.

If light consists of a stream of particles, then the transmission of light is *ballistic*, such as a bullet fired from a gun, and light needs no medium to guide and transmit it. However, if light consists of waves, then light needs a medium to undulate and transmit it, just as sonar needs water and sound needs air. Wave motion is said to be *undulatory*. For the undulatory theories of the transmission of light, the medium transmitting the waves has historically been called æther; now more commonly spelled "ether."

Then too, we have the experimental *order* of experiments and observations of light. By order, I mean the size of the exponent of the speed in the experiment. So a velocity v , is equivalent to v^1 and is thus said to be of first order, v^2 is of second order, v^3 is of third order and so on. Since most light-based experiments measure the speed of a body relative to the speed of light, we are usually meas-

using the ratio v/c , where v is the velocity of an object and c is the speed of light. Since the exponent on both v and c is unity, we say that experiments involving v/c are of *first-order*. In general, first-order experiments involve light traveling in one direction. Second-order experiments involve a round trip, that is, the light goes one way to a mirror and is reflected back whence it came.

We start this chapter by examining several early experiments conducted on both terrestrial light and starlight. What we will discover in the next few chapters is that the light experiments are not supportive of the Copernican system. Indeed, experiments conducted on terrestrial light show terrestrial motions, whereas experiments performed on celestial light show no motion. In short, the evidence strongly favors geocentricity.

Fresnel Drag

At the turn of the eighteenth to nineteenth centuries, physicists debated whether a beam of light consisted of a stream of particles or a string of waves. Among those holding the wave view were two famous French physicists, François Jean Dominique Arago* (1786-1853) and Augustin Jean Fresnel (1788-1827). Fresnel based his theory on a sim-

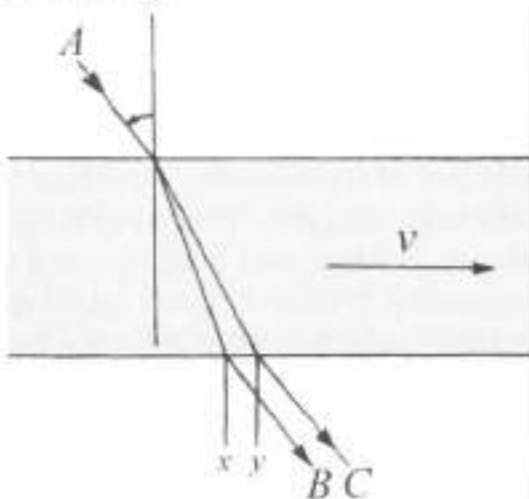

Figure 1: *Fresnel Drag in a Glass Plate.*

The path AB is the one that would be taken if the slab of glass were at rest. The velocity v of the slab, however, drags the wave so that it emerges at point C , following the path AC .

* Arago was more than a physicist; he was also a soldier and politician. In the late spring of 1848, for six-and-a-half weeks, Arago served an interim term as Prime Minister of France. He is thus listed as the 25th Prime Minister of France. Arago was a Republican and resigned his post at the Paris Observatory rather than to swear allegiance to Napoleon III. So great was the respect for Arago that Napoleon refused his resignation and ordered his men to leave Arago alone.

ple observation: when a light beam passed through a stationary plate of glass, the beam went straight through it. But if the plate is moving, it drags the light along with it for the time it takes the light to pass through the thickness of the plate. The dragging effect is called *Fresnel drag* (Figure 1).²

In 1818, Fresnel presented his wave theory of light in a paper which he submitted to a competition sponsored by the French Academy. In the paper, he introduced a theory of diffraction.³ His theory representing light as a wave ran counter to the prevailing opinion which held that a beam of light consisted of a stream of hard little particles. Whether light consisted of particles or waves had been a point of contention since at least Newton's day.

Siméon Denis Poisson (1781-1840), a member of the Academy's judging committee for the competition, was very critical of Fresnel's wave. Trying to discredit the wave theory, Poisson used Fresnel's own theory to derive the seemingly impossible prediction that a bright spot should appear behind a circular or spherical obstruction. That prediction, he felt, would be the last nail in the coffin for Fresnel's theory. However, Arago was also a member of the judging committee and he favored the wave theory of light.

Arago's Experiments

At his very first opportunity, Arago shone light through a pin-hole and let it fall on a circular disk. The wave theory predicted that each point on the circumference of the disk would act like a lens to focus the light unto the center of the shadow, there forming a bright spot (Figure 2). And that is exactly what Arago observed, verifying Fresnel's theory on the spot, as it were. Fresnel won the

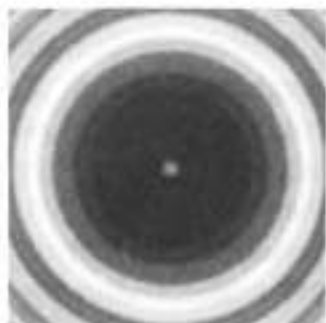

Figure 2: *Interference pattern with the Spot of Arago at center.*

³ Diffraction is the bending of light waves around obstacles and the spreading-out of waves passing through a small opening.

competition. The wave theory had predicted the spot which the particle theory of light, also called the ballistic theory, could not explain. Today, that spot is known as the spot of Arago. Ironically, it is also called "Poisson's bright spot."

In 1810, Arago performed Fresnel's drag experiment using starlight instead of terrestrial light to see if the plate would drag the starlight with earth's 18.6 miles-per-second (30 km/sec) orbital motion through space. Arago found that in every case of reflection and refraction of starlight he tried, the result was the same. It was as if the starlight originated in his lab, that is, as if the earth is stationary in space. Specifically, this meant that the ether through which the glass plate is supposedly moving if earth and plate were orbiting the sun, left no trace of earth and star's relative motion.³ In other words, the experiment confirmed the stationary earth.

Thirty-six years later, Sir George Gabriel Stokes (1819-1903) took yet another look at Fresnel drag with Arago's starlight effect in mind and concluded that instead of the ether being partially dragged along by the glass, it was compressed therein.⁴ Stokes postulated that Fresnel drag also occurred with the planets and the earth. To quote Stokes:

I shall suppose that the earth and the planets carry a portion of the ether along with them so that the ether close to their surfaces is at rest relative to those surfaces, while its velocity alters as we recede from the surface, till, at no great distance, it is at rest in space.⁵

In other words, Stokes imagined that something drags, or entrains, the ether with the earth in its path around the sun, thus explaining Arago's results.

Evidence against Stokes' explanation was published by Albert Michelson (1852-1931) in 1897,⁶ but Stokes could still be right if the earth's magnetic field, for example, provided the drag. Indeed, in the past several decades, ether-entrainment, as the drag is now called, has been resurrected to explain a variety of heliocentric and relativistic "problems," each of which is solved if the earth is sta-

tionary. But we shall leave the modern views until later, when we shall examine the relativity theories.

In 1893 Sir Joseph Larmor (1857-1942) showed that Fresnel drag could also result if it is assumed that the amount of light transmitted by the slab of glass has to be the same whether or not the slab is moving.⁷ Such theoretical work, which proposes alternative explanations for an already physically-explained phenomenon is common in light-based experiments attempting to prove the motion of the earth about the sun. The problem is that only one of them can be true; but which one? (Recall Newton and Berkeley's refusal to accept the Newtonians' mathematical models as proofs.)

The conclusion drawn from all these experiments is simply this: Arago's experiment, using starlight or sunlight, shows the earth is at rest in the light-wave-bearing medium. On the other hand, Fresnel drag—regardless of its cause—shows that the same optical experiment conducted



Figure 3: *François Arago*

with earth-based light sources shows motion through the same ether that fails to show it for starlight. The simplest explanation is that the earth is at rest in the ether; however, that conclusion is not allowed since it supports Scripture, so other explanations must be devised.

Finally, there is one more experiment Arago performed which we should consider. Arago reasoned that if he were to look at a star near the ecliptic directly to the east at sunrise, the speed at which the light entered his telescope would sum to the speed of the speed of light plus the speed at which the earth was approaching the star in earth's orbit around the sun. Six months later, when the star would be in the west at sunset, the speed of the light hitting the telescope would be the speed of light less the earth's orbital speed. The difference between the two speeds six months apart is 60 kilometers per second or 37.2 miles per second, twice earth's supposed orbital speed. Now, as the speed of light changes, the place where the star comes into sharp focus also changes.

For an entire year, Arago observed a star and kept a record of the location of where the focus of the star fell. To his surprise, the star was always in focus at the same spot; in other words, the speed of light was all that figured into the focusing of the telescope; the orbital speed of the earth is zero. This was just one more experiment demonstrating that the earth was not orbiting the sun but standing still.* (Today's explanation is that light always arrives at the same speed, regardless of the speed of its source or detector. An alternate solution is a geostatic light-wave bearing medium, namely the firmament.)

Now the above are all first-order experiments. Second-order experiments seem to show that the speed of light through a medium such as glass is less than the speed of light through a space empty of atoms, that is, a vacuum. In the case of glass, the speed of light is about two-thirds that of a vacuum. In 1941, Julius Stratton (1901-1994) published his analysis of such second-order ex-

* Arago would not have eye-balled the location of the focus by sight, as you or I would if we were merely looking through a telescope. Instead, Arago would likely have used a lens-maker's tool called a *knife-edge*. With a knife-edge, the eyepiece is deliberately out of focus and the knife is slowly passed through the light beam. Too far out of focus and one side or the other of the star's out-of-focus disk will disappear first, but if the knife is exactly at the focal point, the out of focus star disk will uniformly fade as the knife is passed across the beam. This method was used for astrophotography and is still the best way to take sharp pictures through a telescope or lens.

periments and concluded that the propagation speed of light through the glass is actually the same speed as in a vacuum, but that a superposition of effects in the glass makes it appear that the propagation speed is slower than in a vacuum.⁸ This opens the possibility that a similar superposition of effects in the ether can cause the speed of light in a vacuum to appear to be about 186,272 miles per second (300,000 kilometers per second) while light's actual speed is infinite.⁹ Since we have seen that the speed of light is dictated by the firmament,¹⁰ the finite speed of light seems to be ingrained in the structure of the firmament and theorems that try to slow light down from infinite speed introduce unnecessary complications.

Conclusion

In the lab, a laser beam will shine straight down through a piece of plate glass and land on a spot under the glass. If the same laser beam shines through the same plate but the plate is moving at the time, it is as if the plate dragged the light along for as long as it was in the glass and the spot lands at a different location than when stationary. However, if we use starlight instead of a laser, we expect that the plate, moving around the sun, should drag the light with it. But every time we try that, the light goes straight through as if the star was located in the lab. In other words, the experiment is what you would expect if the earth is geostatic; not moving through space.

Heliocentric explanations for this geocentric phenomenon were totally lacking until the end of the nineteenth century when Fitzgerald proposed that objects contract in the direction of motion. But even so, there remain problems that the Fitzgerald contraction, cannot solve.¹¹

In Chapter 25, on geocentrists from 1650 to 1950, we remarked that one of the leading factors behind the geocentric revival of the nineteenth century Germany arose from problems involving electromagnetic theory and fundamental experiments on light. We are now in a position to see that these problems origi-

nated from the works of Arago and Fresnel. We can now categorize those problems for further analysis.

The first category involves those experiments that either failed or succeeded in their attempt to detect terrestrial motion. The general rule for that category is: if the motion is relative to earth, it is detectable; if it is relative to the firmament or the sun, it is not detectable. What Arago and Fresnel experimented with belongs to a family of phenomena called *aberration*. In what follows we shall first examine aberration as an astronomical phenomenon. After that, we shall look at a second category, those experiments that attempted to find the motion of the earth through the ether. Those experiments are broadly categorized as Michelson-Morley-type experiments. In the third category of experiments we will look at electromagnetic field effects to determine the cosmic motion of the sun and earth. Fourthly, we will examine the category of experiments and observations dealing with the relative rotation of earth and ether.

The next two chapters deal with the first group of optical problems for heliocentrism. The first chapter is an introduction to aberration and the following chapter presents one variant of Arago's moving plate experiment with starlight, namely Airy's failure.

You get the most flak when you're directly over the target.

— An old saying among Air Force bomber pilots

ABERRATION

Aberration was the first of the alleged proofs adopted by heliocentrists. Although first observed before Newton's birth, it took a long time for the phenomenon to be properly identified.

Introduction

What is aberration? Imagine rain falling on a windless day. Since there is no wind, the rain falls vertically. To protect yourself while you are standing still, you would hold your umbrella directly above you. Now, suppose that you start to walk. Although the rain is still falling down vertically into the puddles on the street, you have to tilt the umbrella slightly in front of you to keep off the rain. Because of your forward motion through the falling rain, the rain now appears to be coming not from a point in the sky directly above you, but somewhat in front of you. Indeed, at night, when you drive a car through the rain, the raindrops illuminated by your car's headlights appear to fall from a position in the sky well in front of your car.

In the astronomical case, aberration is caused by the finite speed of light. Replace the rain with starlight and yourself with the earth and your umbrella with a telescope and you have the astronomical explanation for aberration of light. If the star is located directly over the pole of the sun, then the star traces out an almost

circular path. Indeed, the path does have the same shape as the earth-sun orbit.

Alexis Claude Clairaut (1713-1765), a French mathematician and physicist, gave this illustration for astronomical aberration:

Imagine rain to be falling vertically, and a person [standing on the ground] carrying a thin perpendicular tube.... If the bearer be stationary, rain-drops will traverse the tube without touching its sides; if, however, the person be walking, the tube must be inclined at an angle varying as his velocity in order that the rain may traverse the tube centrally.

Here the rain is starlight, the tube is the telescope, and the person is the earth.

Another common illustration, first printed by Pierre Louis Moreau de Maupertuis (1698-1759), a French mathematician, physicist, and astronomer, is that of a sportsman who, when aiming at a bird on the wing, sights his gun some distance ahead of the bird, the distance being proportional to the velocity of the bird. However, this illustration really states the explanation for the geocentric explanation rather than the prior heliocentric illustrations which have all assumed that the earth moves, not the star. In this case, the bird represents the star, and the gun the telescope, and the sportsman represents a stationary earth.

To see that both geocentric and heliocentric explanations of aberration give identical results, consider what used to be called "the parallelogram of velocities" (Figure 1). In Figure 1, A denotes the starting place for the earth, B denotes the objective (lens) of the telescope BA, and the line AB points in the true direction of the star. In the time it takes for the light to enter the telescope at B and travel down the tube to the eyepiece at A, the earth moves from A to C. Clearly, the light



Figure 1: *Parallelogram of velocities.*

traveling the line BA will not reach the eyepiece at A because the eyepiece will have moved to C. For the starlight to pass through the telescope tube so that the light arrives when the eyepiece reaches point A, the telescope must be pointed ahead of the star, along line AD. What happens is that the lens of the forward-pointing telescope will be at A when the light enters the lens and, as the light travels down the telescope tube, the telescope's lens will have reached point C when the eyepiece arrives at A, allowing the observer to see the star. Only when the telescope is aligned parallel to DA will the light reach the eyepiece.

In the geocentric case, the starlight moves from D to B in the time it takes for the light to go down the telescope tube and reach the eyepiece at A. In this case, the starlight hits the objective at D and travels down the tube hitting the eyepiece at A. Note that in both cases the light arrives at the eyepiece at point A. That is because the line DC also points to the star. The only difference is that in the heliocentric explanation the earth moves to the left, from A to C whereas in the geocentric explanation the star moves to right, from D to B.*

The aberration value, represented by the angle BAD in Figure 1 is $20''.49552$.[†] That value is the semi-major axis of the ellipse traced

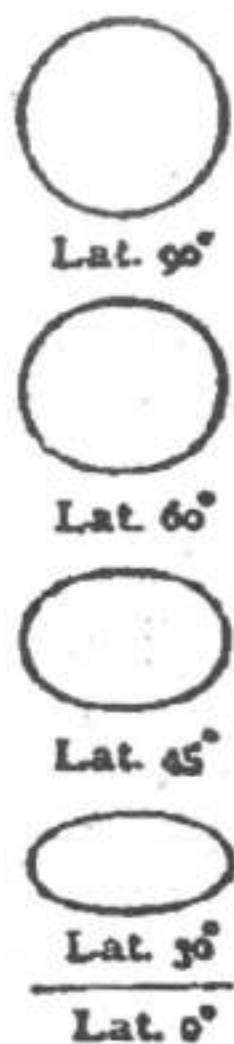

Figure 2: Aberration and Latitude

* There is a real problem with this illustration when it comes to the Special Theory of Relativity. Relativity was designed to "solve the aberration problem," but it fails, as we shall see in a later chapter on relativity.

[†] I write $20''.49552$ instead of $20.49552''$ for the benefit of any American and English engineers reading this book. The first notation speaks of seconds of arc, where there are 3600 seconds in a degree. The second form speaks of a length just short of 20.5 inches.

out during the course of a year by a star's aberration (Figure 2).¹ The aberration of the sun is the same value as quoted for stars above. However, the moon's aberration is $-0''.704$ as seen from earth. Depending on its latitude measured from the ecliptic, that is, from the zodiac, every star in the sky traces out the same-sized ellipse as seen in Figure 2.

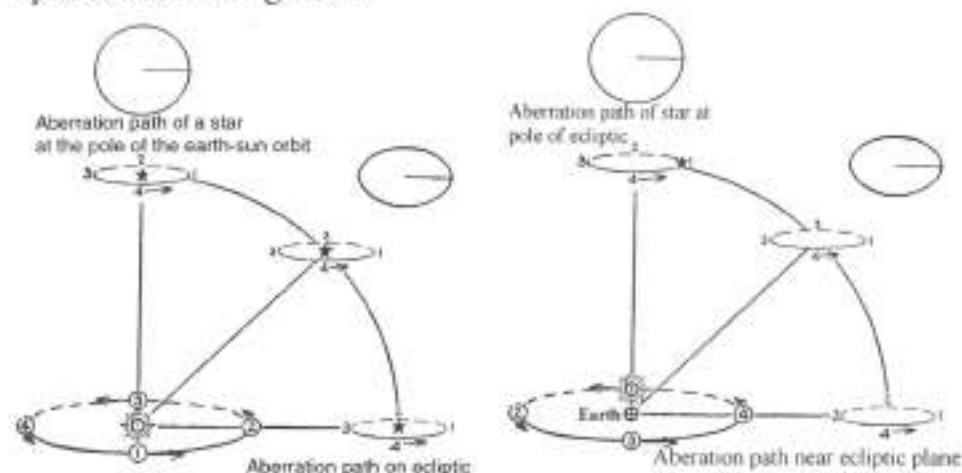

Figure 3: *Stellar aberration from the geocentric perspective (left) and heliocentric perspective (right). Note that the ellipses traced out are identical.*

History of Aberration

In 1640, about the time of Galileo's death, Giovanni Pieroni (1586-1654) discovered that certain stars appeared to shift position over an angle of about 40 seconds of arc with a period of one year.² In 1669 Robert Hooke (1635-1703) noted that the star Gamma Draconis showed an annual variation in its position. Ole Rømer (1644-1710), in a letter to Christian Huygens dated 30 December 1677, mentions "a suspected displacement of the apparent position of a star, due to the motion of the earth at right angles to the line of sight."³ Sometime later, in 1694, the celebrated astronomer John Flamsteed (1646-1719) observed a similar variation in the Pole Star. The latter three men interpreted the motions of these stars as due to parallax.⁴ For some reason—probably because their observations implied a universe too small to fit the he-

liocentric opinion or because the observations implied a finite speed for light—the observations of Pineri, Hooke, and Flamsteed were ignored until 1725.

The modern explanation for aberration began in the years 1725-6 when Samuel Molyneux (1689-1728) and James Bradley (1693-1762) continuously observed the star Gamma Draconis through the years 1725 to 1728.⁵ Bradley discovered that the star followed a path that described a small ellipse that took a full year to make a complete loop (Figure 3). For a while, Bradley thought that aberration was the long-sought stellar parallax delayed by three months.⁶ For that to be so, the universe must be 90 light-days in radius or half a light year in diameter and all the stars must lie within roughly 200 million miles (300 million km) of the outer edge of the universe. Bradley decided against the parallax idea and thought it more likely that the apparent motion of the star was due to the finite speed of light. Others also thought the phenomenon Bradley discovered was parallax, but most astronomers knew that aberration and parallax do not behave the same way.

Figure 3 also presents the geocentric case for aberration. The left panel gives the geocentric case. Look closely at the sun and earth locations in the bottom left versus the bottom right panel. In both cases the sun starts out on the far side of the earth. Bear in mind that the star follows the same path as the sun in the geocentric case. The proof that the models are the same is that the star positions and numbers are identical (same location and sequence) and the relative positions of earth and sun are the same for each star number. At the bottom left, the numbers trace the path of the sun; at bottom right, the heliocentric case, they trace the path of the earth. (Figure 3 is an excellent mind sharpener.)

Aberration Today

You would think that with such a simple explanation for aberration, that any debate about its nature would be superfluous. But Scripture warns us against such simplicity when in Proverbs 1:22 it says: "How long, ye simple ones, will ye love simplicity? and the

scorners delight in their scorning, and fools hate knowledge?" And sure, enough, aberration is far more complicated than the simple picture presented us as evidence for the motion of the earth in orbit about the sun. After a long, involved, and difficult mathematical treatise on aberration, physicist Thomas Phipps counters the simple explanation for aberration this way:

Finally, it should be said that we have barely scratched the surface of the subject of aberration. There is planetary, solar, and lunar aberration, "streetlight" aberration, etc., that we have not touched upon. If these seem a simple matter, easily reduced to textbook formulas, rest assured that this is in itself an aberration. In all cases, in interrogating the quantum pure state of the "propagating" photon, we are poking our foot into the basic fabric of the world...and need to tread gently.⁷

It should come as no surprise, then, that the geocentric explanation, too, is more complicated than meets the eye. Anyone who has taken high school physics will recall vectors. A vector is represented by an arrow of a certain length, such as we see in Figure 4. Here the arrow labeled c represents the direction the light is traveling at speed c , and the length of the arrow labeled v_e represents the earth's presumed orbital speed and direction. Ideally, the length of each arrow should represent the speed of the object, but since the light arrow's length would be 10,000 times the length of the earth's arrow, we have exaggerated the length of v_e . In short, a vector is an arrow that represents the direction and amount (amount of speed in this case) of a force. The arrow from the star (*) diagonally across the parallelogram represents the speed and the direction the light has when it



Figure 4: Aberration as a Vector Parallelogram

hits the telescope. The diagonal vector is called the *resultant*. For the geocentric explanation of aberration, it is sufficient to point out that if the earth stood still and the star moved from right to left (v_*) at the same speed as the earth moves from left to right in the heliocentric case, that we end up with the same resultant, which is to say, if aberration proves the Copernican model, then it equally proves the geocentric universe.

Conclusion

It is clear from the parallelogram of velocities that both the earth-orbiting-the-sun and the stars-accompanying-the-sun-in-its-yearly-motion yield identical results. In that case, no proof can be claimed by either heliocentric or geocentric view.

I wish I could say that were the end of the matter, but it is not. According to relativity, the resultant, the hypotenuse of Figure 4 and the line labeled c should be the same length. Of course, this can only be true if $v_{\oplus} = v_* = 0$.

The bottom line is that I have to agree with Phipps when he complains that aberration is not at all understood and that among the men who least understood it was Albert Einstein. But our defense of geocentricity does not require us to understand all there is about aberration. We only need to show that geocentricity is consistent with what we do know about aberration.

For the reader resolved to eschew theory and to admit only definite observational facts, all astronomical books are banned. There are no purely observational facts about the heavenly bodies. Astronomical measurements are, without exception, measurements of phenomena occurring in a terrestrial observatory or station; it is only by theory that they are translated into knowledge of a universe outside.

— Sir Arthur Eddington¹

ABERRATION: AIRY'S FAILURE

In Chapter 30 we saw from Arago's experiment that the speed of light is different in various media such as water and glass. We introduced the concept of Fresnel drag, where the medium carries the light with it as the light passes through that medium. In the subsequent chapter, we applied that principle to explain aberration observed through a telescope. We presented a simple, yet commonly accepted interpretation of aberration as a phenomenon that detects the earth's motion around the sun. We also showed that, in the standard interpretation of aberration, the phenomenon could equally well prove the stationary earth. In this chapter we look at aberration as seen through a telescope filled with media other than air.

Fizeau's Experiment

In 1851, French physicist Armand Hippolyte Louis Fizeau (1819-1896) conducted a hallmark experiment.² In the years be-

fore 1851, Fizeau showed that the speed of light through glass was different for different colors. That meant that the ether would have to have different properties for different colors. Fizeau attributed the color difference to elastic properties in the ether. His 1851 experiment was designed to discover the elastic and other properties of the ether. Consider Figure 1.

In the experiment, a light, S_1 , shines upon a half-silvered mirror H . The half-silvered mirror allows half the light to pass to M_1 where the light is reflected up to M_2 , then to M_3 , and on to H where half the beam passes through the mirror to a detector, D while the other half resumes the loop to M_1 and so forth. The other

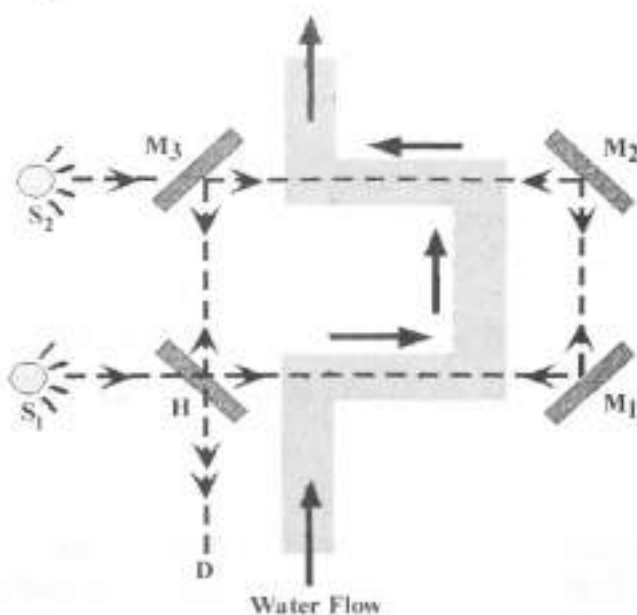

Figure 1: Schematic of Fizeau's Apparatus.

half of the light that hits H initially from S_1 is reflected down to the detector where the different path lengths guarantee a detectable interference pattern consisting of alternating light and dark lines called *interference fringes*. By sending a parallel beam of light from S_2 through a half-silvered mirror, M_3 , another beam is sent through the two tubes in the opposite direction, the interference fringes are strengthened.

When water flows through the glass tube from bottom to top, Fresnel drag sets in and drags the light from S_1 to M_1 and again from M_2 to M_3 . Likewise, the light from S_2 to M_2 is slowed by the flow of the water and from M_1 to H . Changing the speed of the water changes the positions of the fringes if there is Fresnel drag,

otherwise the fringes will stay the same as they were when the water was in the tube but not flowing. The fringes confirmed Fresnel drag.

Martinus Hoek's Experiment

In 1868, Dutch physicist, Martinus Hoek (1834-1873) conducted an experiment similar to Fizeau's except that Hoek split a single beam of light into two beams and had it going around in a path that was partway through air, and partway through water.³

Hoek assumed that the earth orbits the sun and expected to see interference fringes (alternating light and dark bands) in his eyepiece. Turning the device so that it points in the direction of earth's supposed motion through space should create a noticeable shift in the fringes. Hoek found none; it was as if the earth is standing still, not moving through the ether.

Airy's Failure

Fresnell's and Fizeau's experiments worked for a terrestrial source of light. What about using starlight, as Arago had, instead



Figure 2: George Biddell Airy.

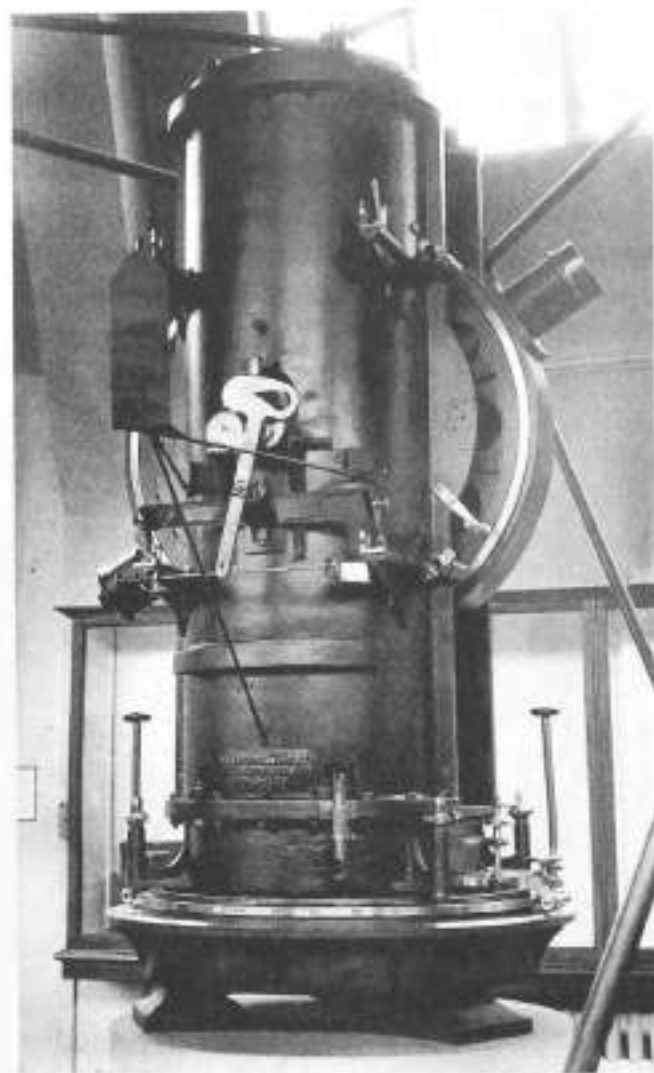

Figure 3: *Airy's Telescope.*

of terrestrial light? Would it be dragged by the telescope? That is what Airy's experiment was going to examine.

The evident immobility of the earth was forcibly brought home in 1871 when the Astronomer Royal of England, George Biddel Airy (1801-1892, Figure 2), performed a variation of Arago's experiment which variation is now known as *Airy's failure*.⁴ The experiment was originally proposed more than a hundred years earlier, in 1766, by Roger Joseph Boscovich

(1711-1787).

To understand Airy's experiment we shall reconsider an analogous experiment which is a bit more earth-bound. We refer back to the aberration figure (Figure 1 in Chapter 31) and the illustration of the stovepipe in the rain. This time, we are interested in not having any raindrops hit the sides of the pipe. We imagine the pipe to be mounted on a car in such a way that the pipe can be tilted forward. If there is no wind and the car is not moving, then

the pipe must be held vertical in order to keep the raindrops from hitting the sides of the pipe. Again, if the car starts to move forward, then the pipe must be tilted accordingly in order to keep the raindrops from hitting the sides.

So far we have the simple case of aberration as we had it before, but now let's add a fan mounted underneath the pipe which fan slows down the rate of descent of the drops inside the pipe. In the case where the car is still and there is no wind, the pipe will still have to be pointed vertically in order to keep the rain from hitting the sides of the pipe; but if the car starts to move we have a different story, for now the pipe will have to be tilted even further into the direction of motion in order to keep the drops from hitting the side of the pipe than when the fan is off.

The same is presumably true for light passing through a telescope where, instead of a fan, we now fill the tube with water. In that case the speed of light is only 77% of that in air. When Airy did the experiment, instead of having to tilt the telescope further into the direction of the earth's supposed motion, Airy found that the water-filled telescope had to be tilted by the same amount as the empty telescope tube. The tube did not have to be tilted further as it had to be in the raindrop and fan analogy. So we are again forced to Arago's conclusion: it looked as if the earth were standing still and the ether "wind" blows the light past it.

To label the result of Airy's experiment a failure is misleading to some extent. Well aware of Arago's and Fizeau's experiments, Airy fully expected his "failure." The experiment was a failure in that it failed to demonstrate the earth's motion about the sun, but it was successful in confirming the predictions of Fresnel drag. (Fresnel drag had not yet been replaced by the relativistic explanations of the twentieth century.)

Radio Telescopes and Aberration

Thus far we have looked at optical effects of aberration. As an analogy for aberration, we presented the rain falling through a stovepipe or on an umbrella to describe the behavior of a telescope



Figure 4: *An Array of Radio Telescopes. (Courtesy NRAO)*

catching starlight. We ask now whether the pipe, that is, the telescope tube, is necessary to the explanation. It turns out that it is not necessary.

A radio telescope is a telescope that observes the sky at radio wavelengths. Radio waves are like light waves. Both are electromagnetic waves, which means that the wave oscillates from electric energy to magnetic energy and back again. The main difference is that radio waves are of far greater wavelength than light waves. For example, the most important radio wave in astronomy is the 21-centimeter (8.27-inches) signal produced by the hydrogen atom. For comparison, a light wave is roughly 0.00005 centimeter long. The radio wave is 950 million times longer than the light wave. The longer the wavelength, the less we expect a wave to pay attention to the finer properties of space. After all, the 21-cm radio wave can pass through a typical room's wall whereas a light wave cannot.

Given that, can we reasonably expect that a radio wave will exhibit the same aberration as a light wave? We know that the air has no drag on starlight since aberration does not change in the air or with air currents. We do get refraction effects with light; after all, that is why stars twinkle. But refraction is not the same as aberration. Nevertheless, it turns out that radio waves from the starry heaven do show the same amount of aberration as does light.

As you can see in Figure 4, radio telescopes do not have tubes; they are open to the air. Radio telescopes typically consist of a dish that reflects radio waves to a receiver mounted at the focal point of the dish. Some radio telescopes are nothing but antennae that receive radio signals directly, just as the radio antenna on an automobile or an old-fashioned television aerial. In every case, to detect a celestial object the antenna must account for aberration.

Now, the fact that radio waves also exhibit aberration means that the universe (not the firmament) is responsible for aberration and that the phenomenon of aberration extends to the surface of the earth. If that is the case, however, why do terrestrial sources of light, such as streetlights, not show aberration? If the light-bearing medium flows past the earth, it must drag terrestrial light with it; but that does not happen. In technical words, the index of refraction, or the Fresnel drag coefficient is irrelevant to aberration. *Yet light is at least partially dragged along with a moving plate of glass if the light source is terrestrial, but not if it is starlight.* This was the great enigma of the nineteenth century and ultimately led to the demise of the rarified ethers, that is, the demise of ethers that are of extremely low density. The only reason scientists still believe in a rarified ether is to keep the ether's drift past the earth at zero near the surface of the earth and yet have the drift be non-zero further up, away from earth's surface. That way, theoreticians can continue to have faith in the earth's mobility about the sun and still be able to explain why the various tests for earth's orbital motion say that the earth does not move through space. We shall return to consideration of the rarified ether models in chapters following.

Non-ether Theories of Aberration

There are at least four non-ether-based theories of aberration. All of those originated in the twentieth century and are the result of complications requiring departure from the simple vector model presented in Chapter 31. Airy's failure was the first such complication, for it, too, showed that starlight does not exhibit any drag, unlike terrestrial light. The four theories are all based on different assumptions of the behavior of light between source and the detector, also called the *sink* in aberration parlance.

The oldest theory of aberration is the Ritzian model. Recall from Chapter 31 that the experiments of Fresnel and Arago destroyed the ballistic model of light in the early nineteenth century. However, by the late nineteenth century, the results of subsequent experiments and physics' frustration at countering the geocentric evidence led to a resurrection of the ballistic theory of light.

In 1908, Walther Ritz (1878-1909) supposed that the Maxwell-Lorentz electromagnetic ether theory's connection with the luminiferous ether made it "essentially inappropriate to express the comprehensive laws for the propagation of electrodynamic actions."⁵ In short, Ritz said there is no ether—certainly not the Maxwell-Lorentz ether. In Ritz's model, a shell of light emanating from an object is ballistically hurled by its emitter into the direction in which the emitter is moving. Thus, as the light sphere radiates out from the object, its center will continue to track the direction in which it was hurled by the emitter, regardless of where the emitter goes afterward. In Ritz's model, $c + v$ has meaning.

The second model of aberration is Einstein's special theory of relativity. Einstein viewed the light as leaving the emitter without any influence from the emitter's motion. The center of the shell of light will always stay at the point from which it was emitted.

The third model of aberration is due to Parry Hiram Moon (1898-1988) and his wife, Domina Eberle Spencer (1920-), who in 1956 used their concept of light to establish what they called a *universal time*.⁶ Universal time is an extension of Ritz's theory which continually tracks the instantaneous position of the emitter, no mat-

ter what the emitter is doing or where it is moving. In that case, the light shell always expands at the speed of light relative to its center which is always located at the moving emitter.

The fourth theory of aberration is the complement to Moon and Spencer's in that instead of tracking the emitter, the light tracks the detector.⁷ Devised by Thomas E. Phipps, Jr., in this model the light is seen as a shell around the detector which is contracting at the speed of light towards the detector. The center of the shell is located at the detector and follows the detector wherever it goes. In this case, potentially the light comes in from all sources in the universe. Phipps' theory is really quite ingenious since all we know stems from detectors, even our eyes, ears, and so forth.

The above four models for the propagation of light and their manner of arrival at the earth are all theoretical, so how can we tell them apart? In the first-order (v/c), they are identical, as needs be to match the observed phenomenon, so that is of no help, but in second order they differ. Einstein subtracts a second-order (v^2/c^2) term, Moon and Spencer's second-order term is twice as large as Einstein's and Phipps' model has no second-order term.

This is where radio aberration comes into play. Using very long baseline (VLB) interferometry, where two radio telescopes are nearly on opposite sides of the earth, second-order effects can be detected. Indeed, the observed second-order effects are a hundred times greater than the smallest effect detectable by a VLB interferometric observation.

Geocentric Explanations

According to the theory of geocentricity, since the wave property of light is tied to the firmament and the ballistic photon applies to the vacuum of the atomic universe, any light emitted by moving atoms will quickly slow or speed up to the speed dictated by the firmament. That means that if you move towards the source, the photon will arrive at $c+v$ where v is your speed through the firmament, not the speed of the light source through the firmament.

Since both wave and photon properties are preserved, this will show up not as a higher speed but as a more energetic photon; that is to say, it shows up as a Doppler shift.

Likewise, at the source, the photon will either be accelerated (for $c-v$) or decelerated (for $c+v$) to the speed of the wave function in the firmament and that, too, will show up as higher or lower total energy; that is, it will be imprinted on the light train and will again be detected as a Doppler shift. Unless this speedup and slowdown of the photon takes only a Planck length of time, it may be detectable.

When it comes to stellar aberration, if the entire universe participates in the yearly motion of the sun about the earth then the star's light will always arrive at the earth from the same direction in which the sun is moving. This is the observed direction, for that is the direction in which the stars would see the earth moving. Still, the light will arrive at the speed of light set by the firmament. However, since the sun's motion is due to the universe in the firmament, the ballistic properties of light apply and the aberration angle will reveal that.

As for streetlight aberration, if the earth is at rest at the center of mass of the firmament, there is no aberration expected. Any that may be detected will be trivially small. Think of it this way: Scripture refers to the first heaven, the atmosphere as "the open firmament of heaven" (Genesis 1:20) which suggests that certain properties of the firmament may "ease up" near the earth. It may allow that near the surface of the earth the Coriolis effect imposed upon the atomic matter of the universe (see Chapter 35) breaks down near the earth and allows the atmosphere to catch and drag the light with it. In that case, there would be no aberration for streetlights.

Conclusion

Optical experiments such as Airy's failure are more fundamental to physics than are mechanical observations such as the Foucault pendulum, the stationary satellite, and the oblateness of

the earth. The former experiments deal with the intrinsic properties of space—absolute motion—rather than dealing with the properties of relative motion. So it is that when it comes to distinguishing between absolute motion and relative motion, the optical experiments designed to measure absolute motion all show the earth to be at rest relative to the firmament. The dynamic experiments show the earth at rest relative to the firmament with only rotational phenomena such the Coriolis and centrifugal forces giving positive results. Even at that, it is six of one, half-dozen of the other as to whether the universe is geocentric or heliocentric. It was the distinction between these two viewpoints—dynamic and optical—and their failure to detect earth's motion through the firmament that greatly spurred the formulation of the special theory of relativity.

But is the special theory of relativity the savior of heliocentric physics that it was designed to be? Saved from what? you ask. Saved from absolute space and motion, from being forced to accept the unthinkable: that the Bible was right all along. Next we will examine aberration in the light of the gospel of relativity.

Although unkind, it is fair to say that [Einstein] never understood [aberration] well enough to grasp his own lack of understanding, and this applies to almost all modern physicists as well.

—Thomas Phipps, Jr.¹

ABERRATION: THE GOSPEL OF RELATIVITY

Albert Einstein (1879-1955) was so convinced of the earth's motion that he deemed any theory (e.g., his general and special relativity theories) *ipso facto* proven if it could explain why optical experiments keep denying the motion of the earth. As was noted in the previous few chapters, ether drag experiments devised in the nineteenth and early twentieth centuries consistently indicated that the earth does not move with respect to the ether, but the most troubling phenomenon was aberration, a first-order phenomenon. Add to that the result of the Michelson-Morley experiment, coverage of which I will defer until the next chapter, and it was time for a revolution. All these observations ran so contrary to modern science's heliocentric dogma that science had to devise a theory that would keep the earth moving while it "appeared" to stand still. Such an explanation did not develop overnight. Nevertheless, the effort was so intensive that the emphasis of physics shifted from the experimentalist to the theoretician, and it remains so even to this day.

The special theory of relativity (STR) does not really deal with everyday phenomena. It deals with objects that move at speeds close to the speed of light. The only everyday objects that travel close to the speed of light are electrons, protons, and atoms. Rela-

tivity has little or no application in geophysics, biology, hydrology, or any other such sciences. The only large objects that may move close to the speed of light or have gravitational fields strong enough to depart from Newtonian physics exist in the astronomical realm; fortunately none near us.

It is not the purpose of this chapter to explain the two theories of relativity, *viz*, the 1905 special theory of relativity and the 1916 general theory of relativity. Most flaws in relativity are rooted in



Figure 1: *Aberration Vector Diagram*

the first order. Thus, in section 7 of his 1905 paper introducing the special theory, Einstein derives his equation of aberration in a relative way.² Applying his conceptual aberration to the true aberration we observe on earth, Einstein would have the earth as the observer's "stationary" (geostatic) coordinate system and the moving coordinate system he ties to the star. Einstein thus sidesteps the aberration problem with confusing terminology and a great deal of bluster. It is the purpose of this chapter

to point out and expose the errors Einstein made in trying to explain away the geostatic implications of the aberration phenomena.

Einstein's Aberration

Einstein derived his formula for astronomical aberration by basing it on relative motion. Consider Figure 1 which shows aberration as a vector parallelogram. In that diagram, let's assume that v_{\oplus} is zero, that is, that the earth is standing still. Let us also assume that the star is moving from right to left at speed v_* , then according to Einstein's formulation of aberration; that will be what we observe. Now, however, suppose that the star is moving right to left at speed v_* and the earth moves left to right at v_{\oplus} . If both

speeds were the same, say 18.6 miles per second (30 km/sec), then the aberration speed is twice that, namely 37.2 miles per second (60 km/sec) and the aberration would be twice as large as we observe. However, if the star keeps moving in a straight line as the earth orbits the sun, then the star would stay fixed in our sky and we would only see the earth-sun aberration of twenty seconds of arc. Round one is over; Einstein is saved by the bell.

In round two, suppose that the star is a short-period binary, such as RXJ0806.3+1527, which has a period of 5 minutes 21 seconds and a reported orbital speed of 1200 km/sec give or take 300 km/sec.³ An orbital speed of 720 miles per second (1200 km/sec) is forty times the speed of the stellar aberration observed in earth. That means that if Einstein's aberration equation is correct, every 321 seconds, RXJ0806.3+1527 should trace out an aberration path some 36 minutes of arc in its major axis. That is larger than the apparent diameter of the full moon. Given that the star is of 21st magnitude (really, really faint), it would never have been detected if it were zipping around in earth's sky all that distance every five minutes. So Einstein is knocked out in round two.

Translation: according to relativity, the situation in Figure 1 should be the same, namely that the earth moving from right to left and the star standing still is the same as the earth standing still and the star moving from left to right. The problem is that the orbit of RXJ0806.3+1527 does not do what the star-moving case should do according to Figure 1. So the two cases are *not* equivalent.

How, then, can I claim that they are the same, as I did in Chapter 31 in the discussion of Figure 31.4? The difference is that relativity does not allow for absolute space. The firmament is the light-bearing medium and has a speed of zero relative to the earth. The Coriolis effect of atomic matter carries every photon with it and at earth's position we perceive that as stellar aberration as the photons are swept by us. RXJ0806.3+1527's photons, being coupled to the firmament, present us with the same aberration as every other star.

The Fitzgerald Contraction

Einstein's solution to keeping the earth in orbit about the sun, even though fundamental experiments showed earth stationary, was to postulate that the length of the apparatus, be it interferometer or telescope, shortened in the direction it was moving. Furthermore, it contracted by just the right amount needed to keep the earth moving. This idea was not original with Einstein, who reportedly first learned of the possibility that length contraction could solve the problem of the earth's motion in an 1892 note that appeared in *Nature*. The note came from Sir Oliver Joseph Lodge (1851-1940), a physicist with occult, spiritualist leanings. In the note, Lodge reported that Fitzgerald had mentioned to him the possibility that objects might shrink in the direction in which they were moving through the ether.⁴ Actually, as was pointed out by Herbert Dingle (1890-1978),⁵ the original concept was not one of shrinkage in the direction of motion so much as one of expansion perpendicular to the motion. The widening postulate was abandoned when certain crystals failed to behave under pressure the way the broadening theory predicted. Although the shrinking idea was originally Fitzgerald's and is thus properly called the *Fitzgerald contraction*, it is commonly misnamed the *Lorentz contraction* because it was Lorentz who first formulated the equations, called the *Lorentz transformation*, that describe said shrinkage. The term, *Fitzgerald-Lorentz contraction* is a crediting compromise commonly found on the Internet and in print.

The Lorentz transformation equations not only fit the shrinkage of rulers in the direction in which they are moving in order to save the world from geocentricity, but Lorentz also added the slowing down of time (the faster a clock moves, the slower it runs) and the increase of an object's mass as its velocity increases. It was Lorentz's contention that these were effects resulting from dielectric properties of the ether. (*Dielectric properties* are characteristics of materials which enable the materials to conduct or store electric and magnetic fields. Thus, according to modern theory, the

vacuum has dielectric properties that allow it to transmit light. The vacuum of empty space cannot have dielectric properties but the firmament does have such properties; given that each particle of the firmament has a charge of roughly eleven times the charge of an electron or proton.)

As we noted in the previous section, in his 1905 paper Albert derived his own equation describing aberration. However, it does not work to explain the stellar aberration we see on earth. So, for the earth's aberration, only the Fitzgerald contraction is used to shorten the telescope in the direction of the earth's motion to account for stellar aberration. Even though the special theory of relativity uses the Fitzgerald contraction in Einstein's derivation of aberration, it is not enough to explain stellar aberration observed on earth. Einstein's aberration equation is a dismal failure when it comes to explaining real aberration.

The Fitzgerald contraction was originally proposed as a property of space, caused by the dielectric properties of space. Other causes have been proposed for the contraction. Thomas Barnes (1911-2001), an American physicist at the University of Texas at El Paso, who was also a creationist, envisioned the Fitzgerald contraction as caused by an electromagnetic feedback in the vacuum.⁶ Robert D. Eagleton of California State Polytechnic College proposed another possible explanation for the length contraction. Eagleton noticed that particles are in effect waves; specifically, they are called *De Broglie waves* when particles are moving and *Compton waves* when they stand still. Based on that observation, he proposed that the length contraction was due to the Doppler shifting of those waves.⁷

We see, then, that Einstein ended up with two versions of aberration: one for stars in general, which is not at all based on observation, and another to explain aberration as we see it from earth. The Fitzgerald contraction explains Airy's failure as well as the aberration we see starlight perform over the course of a year, but the Fitzgerald contraction was invented for only one reason, to explain the null result of the Michelson-Morley experiment (see next

chapter).⁸ Einstein obviously did not understand aberration well enough to realize that his relativistic aberration would not work. Thus he needed two explanations to explain one phenomenon. Well did Phipps evaluate Einstein's mental state in our chapter quote.

The Birth of Modern Relativity

With two conflicting models of aberration, the question arises, how did such a mess get started?

In 1899, based on the Michelson-Morley results and some other related considerations, Jules Henri Poincaré (1854-1912), a French mathematician, concluded that motions could only be relative; that there could be no such thing as absolute motion.⁹ This conclusion was not original with him, of course, for it had been the contention of both Berkeley and Mach before him. Poincaré further concluded that the speed of light is a natural speed limit. These conclusions came to be known as the *principle of relativity*. It was this principle of relativity that Einstein adopted as his own when he published his famous paper on the *special theory of relativity* in 1905.¹⁰ Eleven years later he had broadened his theory to the point that he felt justified in calling it the *general theory of relativity*.¹¹

In his speculations, Einstein held that the speed of light must be the same in all directions and over all space, regardless of the motions of either a source of light or the receiver. That is exactly what all terrestrial-based fundamental experiments show around earth: that the speed of light is the same in all directions; but Einstein's formulae are designed to make every object in the universe look the same as we see it on earth. In other words, according to Einstein, if a star emits a ray of light towards the earth, then the ray travels to earth at some 186,000 miles per second. If the earth now moves at 1,000 miles per second towards the star, then the ray of light would still hit the earth at 186,000 miles per second. If the earth were to speed up to 10,000 miles per second towards the star,

then the light would still hit the earth at only 186,000 miles per second. The same is held to be true if the earth were, instead, to move away from the star at those speeds; the light would always reach the earth with a speed of 186,000 miles per second.*

Much is made of the "beauty," "elegance," and "truth" of relativity; but it can be demonstrated that the theory of relativity, as formulated by Einstein, involves circular logic and is quite impossible. This has been demonstrated over and over again by men such as Charles Lane Poor (1866-1951) and Herbert Eugene Ives (1882-1953). The appeal of relativity goes beyond considerations such as beauty and elegance. Einstein had done more than formulate a new theory; he had formulated a new religion, a new natural theology. Einstein's definition of the constancy of the speed of light in all directions, independent of source, ether, and observer, inevitably leads to certain contradictions; and these can be analyzed to show that Einstein's relativity violates the second law of thermodynamics. Just how this comes about we shall see shortly when we look at the time dilation effect; but first, we shall look at some earlier so-called proofs of relativity. Critics of Einstein, such as Ives and Poor, are dismissed these days with the epitaph that they failed to understand relativity. On 18 May 1953, library researcher Elmore E. Butterfield put it this way in a letter to John M. Stevenson, electronic engineer for Admiral Rickover:

The point is that Ives works with physical concepts, whereas Minkowski, Einstein, Schwarzschild, and Birkhoff make mathematical fummaddiddles give them the "right" answers.¹²

Butterfield's statement, coupled with Einstein's abysmal failure to grasp that *real* aberration—as observed on earth—in no way resembles his *theoretical* conception, goes a long way in identifying

* If we let c stand for the speed of light and v for the speed of the earth around the sun, Einstein claims that $c=c+v$ and $c=c-v$ are true, which can only be true if $v=0$, i.e., if the earth is not moving. Einstein "cooked the books" so that claiming $c=c+v$ and $c=c-v$ with $v = 18.5$ miles per second (30 km/sec) also gets $v=0$.

just who does *not* understand why the anti-relativity debates still rage.

Alleged Proofs of Relativity

The proofs of relativity fall into natural categories, each of which we shall consider by specific example. The first proof that Einstein considered conclusive was aberration, with which we have already dealt. Einstein claimed that, in his opinion, even though the Fitzgerald contraction and the ether explanations for aberration give identical results, that does:

not in the least diminish the conclusiveness of the experiment as a crucial test in favor of the theory of relativity.¹³

As Charles Lane Poor put it:

How can an experiment, equally well explained by several different theories, be a "crucial test" in favor of one of them?¹⁴

Here Einstein is guilty of sophistry: that is to say, whoever puts forth the most complicated and frustrating arguments ("snow-job") and shouts the opposition down the loudest "has" the truth. The fact that Einstein's version of aberration does not at all model the aberration we observe on earth reveals the bankruptcy of theoretical physics. Einstein's ideas prevailed over those of his contemporaries because he received favorable press coverage.

Gravitational Bending of Light

The gravitational deflection of light is the second of Einstein's "conclusive proofs" of relativity. Historically, the first person on record to predict such a gravitational deflection is the German physicist, mathematician, and astronomer, Johann Georg von Soldner (1776-1833, Figure 2) who wrote his paper back in 1801

had it printed in 1804.¹⁵ Von Soldner predicted an effect of $0''.84$, which compares with Einstein's $0''.83$ in his 1911 paper under the section entitled "Bending of Light Rays in a Gravitational Field."¹⁶ So von Soldner actually did predict a deflection the size of that predicted by Einstein in 1911.¹⁷

However, in 1915 Einstein added effects of the curvature of space-time to his 1911 solution and doubled the size of his 1911 solution.

Because the sun is bright at visible wavelengths, the sun must be covered over by the moon to see stars close to the sun. Early eclipse observations tended to confirm von Soldner's deflection amount rather than Einstein's. That is why Sir Arthur Eddington decided that the 1919 eclipse of the sun in Brazil was an opportune time to prove Einstein's 1915 revision of starlight deflection. Eddington was fully determined to prove Einstein correct. In order to make his observations fit even Einstein's 1911 derivation, Eddington's team had to throw out about forty percent of the data.¹⁸ Roughly that percentage of starlight deflects in the opposite direction. The reason why the number of opposite-way deflections is so



Figure 2: Johann Georg von Soldner.

high is simple enough to understand; the observers totally ignored the effect of refraction caused by the sun's own atmosphere.

A 1976 study noted that determinations for the amount of falling which a light wave experiences by passing in the vicinity of the sun gives a result of $0''.95 \pm 0''.11$ seconds of arc—slightly more than half the amount predicted by relativity but also $0''.12$ greater than von Soldner's predicted value.¹⁹ The solar atmosphere itself could well provide enough additional refraction to account for the greater deflection for von Soldner's value.[†]

When it comes to deflection of starlight in a gravitational field, the case for both special and general relativity theory looks pretty good. What does that mean for geocentricity? As we saw when we examined centrifugal and Coriolis forces, it is six of one, half dozen of the other when it comes to the Copernican theory over geocentricity. The same is true here, and for the same reason. It takes about five seconds for light to traverse the diameter of the sun. In those five seconds the sun's surface gravitational field, which is 27 times as strong as earth's at its surface, allows a photon to fall a noticeable distance towards the sun. Relativity was invented to counter the geostatic universe implied by the failure of optical experiments to detect the orbital motion of the earth about the sun. We can rephrase that another way; relativity was invented to make every spot in the universe look as if it is at rest in the center of the universe. In particular, then, here about earth, every physical phenomenon has to be geocentric. The curvature of the space-time continuum is one such geocentric artifact of relativity. So is the bending of starlight in a gravitational field. So this, the second proof of relativity is at least a moderate success.

¹⁹ In 1976 I took a look at what the index of refraction of the sun's outer atmosphere would be if the observed deflections were entirely due to refraction of light (a gross exaggeration and I am not proposing that it is). The value I derived was 1.000 003 79. For comparison, air's index of refraction is 1.00029 and the index of refraction of a perfect vacuum is 1.

[†] If so, the index of refraction of the sun's atmosphere is about 1.000 000 54.

Perihelion Precession of Mercury

The third of the Einstein's proofs of relativity is the so-called *perihelion precession* of Mercury. Notice that Einsteinians never refer to the perihelion precession of any of the other planets unless they've modified Einstein. The reason for this is quite simple: relativity is only successful in accounting for the perihelion precession of Mercury.

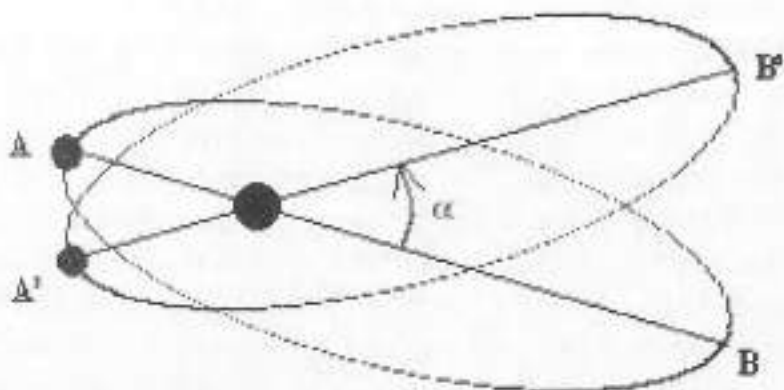

Figure 3: *Perihelion Precession.* The major axis of the orbit rotates from AB to A'B' in the plane of the paper. The angle α is the precession angle.

Perihelion precession refers to the rotation of an elliptical orbit about one of its foci (Figure 3). For example, the line joining Mercury and the sun when the two are closest to each other rotates with respect to the background stars. Table I compares the observed rates of precession that relativity has to explain (the column labeled "observed") compared with the amount relativity predicts, (the column labeled "calculated"). The column labeled "O-C" gives the difference between the observed and calculated values. The first column gives the name of the planet and, for the sake of this illustration, the earth will be considered a planet. To further illustrate the bankruptcy of relativity as an explanation for the motions of the planets, we shall also tabulate the precession of the line of nodes (a line from the sun to the point where the planet's orbit rises above the ecliptic) as well as the changes in the eccentricity (degree of

wideness or narrowness) of the planet's orbital ellipse. Both of these latter quantities should not change at all according to relativity. All units are in seconds of arc per century.

TABLE I²⁰

PLANET	OBSERVED	CALCULATED	O - C
Perihelion Precession:			
Mercury*	+ 42.6 ± 1.4	+ 42.9	- 0.3
Venus	+ 8.4 4.8	+ 8.6	- 0.2
Earth	+ 4.6 2.7	+ 3.8	+ 0.8
Mars	+ 1.5 0.04	+ 1.3	+ 0.2
Icarus	+ 9.8 0.8	+ 10.0	- 0.2
Nodal precession:			
Mercury	+ 5.1 ± 2.8	0	+ 5.1
Venus	+ 10.2 .0	0	+ 10.2
Eccentricity:			
Mercury	- 0.88 ± .50	0	- 0.88

Relativity is not the only theory which accounts for the precession of Mercury's orbit. Several others do so, as we see in the above table. Nevertheless, Einstein, seeing his result is nearly correct, claims proof of his theory on the grounds that it is based on pure mathematics and that he has applied every correction he can think of. He writes: "These facts must, in my opinion, be taken as a convincing proof of the correctness of the [general] theory."²¹ Is

* Newton's value for Mercury is 42.56, for Venus 8.53, for Earth 3.80, for Mars 1.34, and for the asteroid Icarus 9.95. Newton is spot-on for Mercury and is closer than Einstein for Venus and Icarus. Einstein is closer for earth and Mars.

Einstein's the most accurate of all theories? Jorge C. Curé, from whose paper the new values for the observed column in Table I were taken, answers the question this way:

The Newtonian solution presented here is slightly better, in the root-mean-square sense, than the relativistic solution. Because of this fact the so-called "non-Newtonian" gravitational term is no longer justifiable, nor are [sic.] the accusation that Newtonian dynamics is powerless to account for the excess perihelic rotation of the planets, since all the elements to solve this problem are contained in [Newton's] *Principia*, published in 1687, more than three centuries ago.²²

Consider the case of Paul Gerber (1854-1909), a German physicist who in 1898, working under the assumption that the speed of gravity is the same as the speed of light, derived exactly the same equation as Einstein published in 1916.²³ Gerber's model had strong geocentric overtones. That caught Ernst Mach's attention, for he singled out Gerber's work for special mention in both the fourth and fifth edition of his important book, *Die Mechanik*. Einstein was known to have studied Mach's book, yet he made no mention of Gerber's having derived the "correct" value of the perihelion precession eighteen years before him. This precipitated a two-decade long controversy between the Nazis and Jewish theorists. During that debate, Paul Gerber became the hero of German Nazi physics even though he was long dead before the left-wing National Socialistic Workers Party movement started.

More recently, Gerber's paper was reexamined by Thomas C. van Flandern (1940-2009, Figure 4). Van Flandern worked at the U. S. Naval Observatory in Washington, DC during the two summers I worked there as an intern. At the time, he was reducing the lunar occultation data that eventually led him to conclude that the gravitational constant is not very constant. After leaving the

* Meaning that the Newtonian predictions cluster closer to the observed value than do relativity's predictions.

USNO, Tom took on other projects, one of which involved celestial mechanics and led him to the conclusion that the speed of gravity is much greater than the speed of light. It is this interest that spurred Van Flandern to reexamine Gerber's paper.

American Spectator Columnist Tom Bethell reported on van Flandern's investigation this way:

Tom van Flandern was convinced that Gerber's assumption (gravity propagates with the speed of light) was wrong. So he studied the question. He points out that the formula in question is well known in celestial mechanics. Consequently, it could be used as a "target" for calculations that were intended to arrive at it. He saw that Gerber's method "made no sense, in terms of the principles of celestial mechanics." Einstein had also said (in a 1920 newspaper article) that Gerber's derivation was "wrong through and through."

So how did Einstein get the same formula? Van Flandern went through his calculations, and found to his amazement that they had "three separate contributions to the perihelion; two of which add, and one of which cancels part of the other two; and you wind up with just the right multiplier." So he asked a colleague at the University of Maryland, who as a young man had overlapped with Einstein at Princeton's Institute for Advanced Study, how in his opinion Einstein had arrived at the correct multiplier. This man said it was his impression that, "knowing the answer,"



Figure 4: *Thomas van Flandern, at left, in 1967*

Einstein had "jiggered the arguments until they came out with the right value."

If the general relativity method is correct, it ought to apply everywhere, not just in the solar system. But van Flandern points to a conflict outside it: binary stars with highly unequal masses. Their orbits behave in ways that the Einstein formula did not predict. "Physicists know about it and shrug their shoulders," van Flandern says. They say there must be "something peculiar about these stars, such as an oblateness, or tidal effects." Another possibility is that Einstein saw to it that he got the result needed to "explain" Mercury's orbit, but that it doesn't apply elsewhere.²⁴

So we see that perihelion precessions can be accounted for by more than one method. Indeed, Einstein did not derive his value for the precession of Mercury on his own. He took Gerber's derivation and adopted, you might say, reverse-engineered it and so claimed it for his own. Considering such things as the sun not being truly spherical in shape, or the existence of matter between the planet and the sun, or the existence of matter outside the orbit of a planet, or gravitational shielding (where intervening material weakens the gravitational attraction between the sun and planet), or even that an advanced potential, where the universe or ether "knows" what is to happen ahead of time, can contribute to perihelion precession, I see no real advantage for relativity on this "proof" of it.

Mass Effect

Fourth among the alleged proofs of relativity is the so-called *mass effect*. Simply stated, this effect is that the faster a material object goes, the harder one must work to get the object to go any faster, that is, the more its effective mass becomes. Thus it takes an infinite amount of energy to exceed the speed of light, according to relativity. But this effect, too, can be obtained in a variety of ways, even from purely classical considerations. The model devel-

oped by Thomas G. Barnes, views inertia as a feedback effect through the firmament and it, too, predicts that mass should increase as an object's speed increases.²⁵ So we have a classical (*i.e.*, non-relativistic), physical, mechanical explanation for mass dilation versus Einstein's theoretical, aphysical, relativity.

Time Dilation

The fifth proof of relativity is time dilation, the slowing down of moving clocks. Einstein treated space and time as part and parcel of the same thing. Thus, if space can stretch and shrink, then so can time. That is why relativity hyphenates the two as *space-time*. Experiments which have been conducted to test the clock-effect are still controversial as they are geared to finding the "expected" result.

The famous Hafele and Keating experiment,²⁶ in which two atomic clocks were flown around the earth in opposite directions and then brought back together and compared, is often claimed to be "conclusive proof" of relativity. But Louis Essen (1908-1997), father of the cesium-quartz atomic clock and once an advocate of relativity, voiced theoretical objections to the time dilation phenomenon.²⁷ In particular, Essen pointed out that Hafele and Keating were very selective in picking the clock rates on either side of the flights. Essen noted that had they selected a longer time interval to determine the average rate of each of the clocks then the experiment would have yielded no time dilation at all.²⁸ Others have noted that one clock lost time as per relativity; the other gained time contrary to relativity.

The carrying of atomic clocks about the earth on jet liners is not the only experiment which has been conducted in order to test the effect of time dilation. The decay rates of certain short-lived nuclear particles, called *muons*, have also been observed as a function of velocity.²⁹ But in observations of this kind, there is great uncertainty about what happens in the filter used in the experiment

as well as incomplete knowledge of the nature of muon decay. Indeed, other, less popular theories can also explain the phenomenon.

There is yet another variant of the clock experiment which has been performed. This one involved orbiting atomic clocks about the earth and was part of the NAVSTAR project. In an unpublished report (because no journal would accept it although no reviewer could give a reason for its rejection other than "it simply cannot be correct"), Ernest Wilbur Silvertooth, then at Jet Propulsion Laboratories in Pasadena, California, called me in 1977 to report to the attendees of the First Conference on Absolutes held at the Cleveland State University, Cleveland, Ohio, that orbiting clocks do show time dilation but that the observed effect is not what is predicted by relativity—relativity was off by 15 pulses of the clock per day.

Silvertooth had very carefully worked through Einstein's formulae and discovered that according to relativity the orbiting clock should actually emit 15 pulses per day fewer than would be received by the detector on the surface of the earth. That is: say that if the clock emitted 1,000,000 pulses to earth in the course of 24 hours (the number 1,000,000 being arbitrarily chosen for this example and having no bearing on reality beyond that purpose), then according to relativity, an observer on the earth will see 1,000,015 pulses in the same 24 hours time. In other words, according to relativity, 15 pulses were miraculously inserted between the orbiting clock and the receiver on earth. This is a clear violation of the second law of thermodynamics and proves that the theory of relativity, as formulated by Einstein, cannot be correct.

Time Paradoxes

Still under the fifth alleged proof of relativity is time dilation; the stretching of a unit of time with speed. Because of Einstein's overconfidence in his theory, he was at times careless in how he

phrased things in his monographs.* Essen gives us an example from Einstein's 1905 paper, a lack of focus that appears to be the source of the clock paradox:

Einstein's result, given in § 4,[†] is "that the time marked by the moving clock viewed in the stationary system is slow"; and it follows from the assumption of symmetry that:

- (i) clock B viewed in A is slower than clock A.
- (ii) clock A viewed in B is slower than clock B.

Essen's point is that in his next paragraph, Einstein completely forgets about his assumption of symmetry when he reaches the "peculiar" consequence that clock A, which moved to clock B at a constant speed, upon arriving at clock B's location will be slow compared to B, even though they started out synchronized. What Einstein should have said, had he not forgotten about symmetry, is that clock A will see clock B as slower than it and clock B will see clock A as the slower clock; he only got half of it. (Hey, nobody says that this has to make common sense.)

By accepting the "peculiar" solution at the cost of symmetry, we end up with the concept of relativistic time dilation, resulting in various clock paradoxes of which the most renowned is the *twin paradox*. The twin paradox states that if one of a pair of twins was to travel away from the earth at close to the speed of light to Alpha

* Since Einstein was promoted by the Planck family, he may not necessarily have written all that he is said to have written. The Plancks had a couple of physicists in the family, the most famous of which is Max Planck. The Planck family had Einstein appointed, fresh from the patent office, to a professorship for which Boltzmann was in line, thus bypassing Boltzmann. This may have figured into Boltzmann's suicide in 1912. Several people feeding Einstein tidbits, along with his first wife, Mileva Maric (1875-1948) who was a degreed mathematician, may account for some of these lapses of focus on Einstein's part. How much she contributed is a matter of hot debate, but it is the height of naïveté to insist that they did not talk about his work since they worked together on projects in graduate school.

[†] Essen says § 7 by mistake.

Centauri four light-years away and then turned around and headed back to earth near the speed of light, he might have aged less than a year while the twin who stayed behind on earth will have aged eight years. This, in itself, does not constitute a paradox; but the situation, according to relativity's symmetry postulate, would be the same as if it were the universe that carried Alpha Centauri with it at close to the speed of light, and upon reaching the space ship, turned around and moved the earth back at close to the speed of light to the waiting spaceship. In that case, the twin on earth would have aged less than a year and the one in the spaceship would have aged four years. So what is the true situation? Did the twin on earth age four years or did the twin in the spaceship age four years? That is the twin paradox.

By omitting the clause "viewed in the stationary system,"—which would have answered that the twin on earth would age eight years and the traveling twin less than one year—we are left with the paradox. Without the stationary system in view, we now have to make an additional assumption. The usual assumption is that the universe decides which is the case. That assumption makes the universe the absolute frame of reference, thus violating Einstein's principle of relativity.

Not every physicist can accept the explanation that the universe determines which twin ages. Some claim that the act of accelerating determines which twin ages, but that violates experimental results which have shown that acceleration has no effect at all on time dilation and so could not resolve the twin paradox either.³⁰ Other physicists argue as to whether or not the twin paradox is really a paradox or contradiction at all. Some point out that the sign of the velocity, the direction in which the "mover" is moving, must be taken into account.³¹ Yet in each such case, the physicists assume that there is a preferred frame of rest; or else they deny some other aspect of Einstein's stated principle of relativity: that all motion is relative. As Mendel Sachs put it:

It is my full acceptance of Einstein's relativity theory that leads me to reject asymmetric aging as an effect that is logically and mathematically inconsistent with the premises of this theory. ...For it follows from the argument that if space-time is defined to be relative only to a particular frame, then clearly the rates of change of any of these coordinates with respect to any other must also be relative quantities, whether they are first, second or 97th derivatives! ...The recent experiment of Hafele is the first attempt (I know of) to test asymmetric aging directly. If these results should be conclusively positive, it would imply to me the necessity to consider altering some aspect of general-relativity theory.³²

What Sachs and others are saying is that if there is a resolution to the clock paradox, then there must be a preferred frame of reference and that, as a result, Einstein's relativity must either be reformulated or abandoned. After all is said and done, independent of geocentricity or heliocentrism, the time dilation effect seems to be real although solid evidence is lacking.

Finally, relativity is not the only way to account for time dilation. Stefan Marinov's transformations work in an absolute framework³³ as will certain classical approaches. The simplest explanation "without going crazy," as the late Tom van Flandern put it, is to assume the existence of a light-carrying medium, the ultra-dense firmament, and that when a clock moves through the firmament's medium, it takes longer for each electron in the atomic clock to complete its orbit, thus ticking less often the faster it travels through the firmament.

Length Contraction

The sixth "proof" of relativity is related to the slowing down of clocks; it is the shrinkage of objects in the direction in which they are moving. This change in length, the *Fitzgerald contrac-*

tion, was first invoked to explain the null result of the Michelson-Morley experiment. Although Lorentz formulated said contraction, he, to his dying day, doubted the truth of Einstein's relativity.³⁴

Waldron has pointed out that there is a connection between the clock paradox and what he terms the *measuring rod paradox*.³⁵ Waldron noted that if the clock paradox is solved (as per the previous section), then there is a paradox in the measurements of two lengths, one moving and the other at rest; and if the measuring rod paradox is solved, then the clock paradox is left unsolved.

No experiment has yet been devised to see whether or not rulers change length when they move. The question then remains whether or not the shrinking of an object along the direction of its travel is a real or an apparent phenomenon.

Dividing by Zero

With the length and time dilations as proofs of relativity and as sources of paradoxes, we end the proofs and now focus on problems with relativity.

Waldron lays the blame for relativity's paradoxes on Einstein's assumption that the speed of light is always the same regardless of how fast the light source and observer may be moving relative to each other. It is not hard to discover how easily such a paradox can arise. The usual cause of a paradox results from dividing by zero. Consider how the speed of light figures into the time and length paradoxes. Speed is measured in distance divided by time, such as miles per hour or centimeters per second.

Enshrined in various standards laboratories on earth are standard rulers, such as the standard meter in the International Bureau of Weights and Measures, in Paris, France. Since the 1980s, standard lengths are defined as the number of wavelengths of a particular type of laser. Likewise, since 1967, the second has been defined to be the duration of 9,192,631,770 periods of the radiation

corresponding to the transition between the two hyperfine levels of the ground state of the cesium-133 atom.*

Suppose we ride along on the front of a light beam, as Einstein dreamt of when he was sixteen. As we accelerate to the speed of light, both the length and time go to zero. We end up with the speed of light equaling 0/0 miles per second. In this particular case limiting constraints force the 0/0 to equal 1 but that is not always the case. Even given that it is one in the limit does not guarantee that the dependence of time shrinkage on velocity is the same dependence for length shrinkage.³⁶

Principle of Equivalence

There are other problems to consider in relativity theory. Several of the postulates of relativity have been promoted by various writers as **the** fundamental postulate of relativity; but most clearly it seems not to have been the principle of relativity itself that is the cornerstone of relativity. Instead it is, as Oscar Klein put it:

the true foundation of Einstein's theory of general relativity [is] the so-called *principle of equivalence*, ...this principle is incompatible with the idea proposed by Mach and accepted by Einstein as an incitement to his attempt to describe the main situation in the universe as an analogy in three dimensions to the closed surface of a sphere.³⁷

Now the principle of equivalence, as Einstein envisioned it, is simply this: that there is no difference between the force of gravity and any other inertial force; that is, acceleration forces such as the ones that press one's back against one's seat when a car accelerates. What Klein is saying is that without the principle of equivalence, the principle of relativity is invalid.

* This ties the standard lengths to the speed of light and guarantees that any universal change in the speed of light over time cannot be detected.

The experiments that have been proposed to test the equivalence principle, including that proposed in the previous edition of this book,³⁸ have been rendered impossible by the caveat Einstein added, namely that it applies "in the small." This makes the equivalence principle nothing more than mathematical nonsense. Thus our conclusion that inertia is due to the cosmic gravitational field stands.

Curved Space

There are other paradoxes which result from Einstein's peculiarly inconsistent formulation of relativity. For example, Einstein claimed that "space is curved," but he leaves totally unanswered the question of: "Curved with respect to what?" For a theory called "relativity," is it not strange that the theory would not say "relative" to what space is curved? However, it is no secret that space is curved with respect to Euclidean space. (Euclidean space is the space of our everyday experience—the geometry which the reader learned in high school.) Relativists proclaim that because space is curved, Euclidean geometry no longer pertains. This they claim even though they ultimately relate their new, curved (Reimannian) geometry back to Euclidean geometry. But I wonder if the real motive is that Euclidean space is absolute, a concept that violates the stated assumptions of the theory of relativity. Yet we saw in several of the previous sections that relativists routinely take the universe as absolute space in order to avoid paradoxical conclusions.

But does relativity really require a curved space? The answer is, "No." Atkinson derived the relativistic equations purely from the Euclidean framework and then concluded that:

There are in fact two effective, but mutually exclusive, lines of argument, of which only one has been explored as yet. It is possible, on the one hand, to postulate that the velocity of light is a universal constant, to define "natural" clocks and measur-

measuring rods as the standards by which space and time are to be judged, and then discover from measurement that space-time, and space itself, are "really" non-Euclidean; alternatively, one can define space as Euclidean and time as the everywhere, and discover (from exactly the same measurements) how the velocity of light, and natural clocks, rods, and particle inertias "really" behave in the neighborhood of large masses. There is just as much (or little) content for the word "really" in the one approach as in the other; provided that each is self-consistent, the ultimate appeal is only to convenience and fruitfulness, and even "convenience" may be largely a matter of personal taste; but neither the fruitfulness of the Euclidean treatment nor its self consistency can be tested until it has been adequately developed.³⁹

P. F. Browne noted that the Einsteinian metric, in this case a four-dimensional Pythagorean theorem,⁴⁰ is itself Euclidean and it assumes that space is not curved.⁴¹ Clearly, statements about the "curvature of space" must be taken with a grain of salt. Indeed, curved spacetime may turn out to be another case of mathematical nonsense.

Preferred Reference Frame

Related to relative space vs. absolute space is Einstein's statement that there is no preferred coordinate system in the universe (in other words, there is no firmament). There is no standard rest in any absolute sense of the word—including in the sabbath in a theological sense.

There have been experiments conducted in order to check for a preferred reference frame. Warburton and Goodkind,⁴² for example, searched the ocean tides for evidence for such a preferred frame of reference. They took out the component of the tide that is due to the moon, and the part due to the sun, and then looked to see if there was yet another part left. In particular, they searched for

the tide due to the center of the Milky Way as well as looking for any other tide that could be interpreted as due to the center of the universe. They concluded that they could not say for certain whether or not such an effect was found. This implies that the center of mass of the universe resides inside the earth (the absolute geocentric case), or else there is no such center of mass (relativity's claim), or such a center of mass of the universe is too dilute to induce a tide in the earth's oceans (Marinov's model). Since the effect appears to be too small for certain detection, and especially since Warburton and Goodkind could not detect the tide due to the galactic center, further discussion of the results is moot other than to point out its consistency with geocentricity. After all, Scripture has spoken that the earth is at the center of God's attention, as attested to Paul's statement that what happens here is the concern of the Holy Ghost into which the angels want to look.*

The inability to find any evidence for the action of the center of mass of the universe on earth would not get relativity out of the rough when it comes to preferred frames of reference; for here, too, relativity contradicts itself. Notice that Einstein developed a geometry for relativity. Now a geometry has inherent in it a frame of reference. When a relativist proclaims that there is no preferred frame of reference, he assumes that the very frame of reference from which he makes that claim is **the** universally preferred frame of reference. In other words, relativity claims that there is no preferred frame of reference and makes that claim from a frame of reference which it "prefers." This type of paradox is called a *paradox of self reference*.⁴³

* 1 Peter 1:12—Unto [the Old Testament prophets] it was revealed, that not unto themselves, but unto us they did minister the things, which are now reported unto you by them that have preached the gospel unto you with the Holy Ghost sent down from heaven; which things the angels desire to look into.

Paradox of Self-Reference

One might try to circumvent the paradox by changing the original statement to: "There is no preferred frame of reference except the relativistic framework," but that does not help at all, for then the exception itself negates the generality of the statement. The correct statement cannot be framed as a negative but has to be stated as a positive: "There is at most one preferred frame of reference." This statement, although not necessarily true, at least avoids the paradox. Practically speaking, there are as many "preferred" frames of reference as there are people and objects in the universe, but there is only one absolute frame of reference and that is God's chosen one which is revealed by the Word and is in his Son who is the salvation of the world.

Ehrenfest Paradox

Then there is the problem with the value of π , the ratio of a circle's circumference to its diameter. This paradox, which physicists know as the *Ehrenfest paradox*, arises from the measuring rod paradox to which Waldron alluded earlier. The Ehrenfest paradox arises in a rotating disk: as the disk rotates, then points on its circumference move. According to relativity, the length of the circumference should contract, especially so as the rotational speed of the disk increases. But the diameter of the disk is not allowed to change according to relativity. This can only mean that the ratio of the circumference to diameter, which is π , has to change with the rotational speed of the disk.

In order to solve this paradox, Ives⁴⁴ assumed that the disk starts out flat and then becomes more and more cup-shaped as the rotational speed increases. Browne,⁴⁵ on the other hand, opts for another resolution by claiming that the effect is not real but that it is due to the waves of light being tilted as they come off the disk. Browne fails to realize that if the length contraction is not real, then the time dilation cannot be real either. As for Ives' resolution

of the Ehrenfest paradox, there is no physical reason at all to assume that the disk would "curl up" that way since there is no upward force. In fact, the mass-effect would make it all the more difficult to do so.

It is impossible in relativity theory to take a disk made out of solid material and set it into rotation. If we were to try to do this, the disk would contract in the circumferential direction but not in the radial direction. As a result, a solid disk would break apart. So, if we want to test a rotating disk made of solid material, we need to create it already rotating. In a letter on the subject, Einstein remarked that a way to set a disk of rigid material into rotation is to first melt it, then set the molten material into rotation and once the relativistic rotation speed is achieved, allow it to harden. The rotating disk problem has generated many unfruitful articles that suggest some sort of paradox is at hand, but most of it derives from a failure to recognize that a stiff disk cannot be set into uniform rotation without destroying it. If the Ehrenfest paradox is real and turns out not to be solvable in the way that Ives suggests, then the value of π can be used as a cosmic speedometer by providing a measure for the rotational or non-linear speed of an object. Again, an absolute space is demanded by experimental results.

Simultaneity

The paradoxes of relativity are not at an end. We consider just one more paradox and that has to do with Einstein's definition of *simultaneity*, the question of how to envision two separate events in two different locations, as happening at the same time. In his formulation of simultaneity, Einstein effectively says "it is absolutely true now everywhere that there can be no now everywhere."⁴⁶ This statement is obviously paradoxical.

In order to circumvent many or all of these paradoxes, several varieties of relativity have been proposed. Some, like the Brans-Dicke theory which proposed an undiscovered planet between Mercury and the sun, now appear to have the scientific evidence

stacked against them; but others, ones which especially modify the Lorentz transformations to take into account the possibility of an absolute space, survive to this day. The most notable such modifications are those of Ives⁴⁷ and Marinov.⁴⁸ Yet every such formulation attempting to dispose of the optical experimental results by such ingenious devices as shrinking rulers and slowing clocks suffers from the same malady: none of them can explain why light is observed to be Doppler shifted when passing through a moving medium,⁴⁹ nor can they explain why a moving medium, like a pane of glass with a light ray passing through it, drags the light along with it.⁵⁰ O'Rahilly described the former Doppler shift effect as follows:

A change in frequency may be produced not only by the relative motion of [source] and [observer] but also by a change in the thickness, density, or index [of refraction] of the intervening medium.⁵¹

The effect is real as it has been verified by experiment.⁵² The effect is totally ignored when interpreting the cosmic redshift* as evidence for an expanding universe. Both effects are more readily explainable in a geocentric universe.

Conclusion

So there are a considerable number of basic contradictions in modern science. Furthermore, science falls short of being able to explain even such a fundamental phenomenon as the Doppler effect without being forced to the conclusion that the earth is stationary with respect to a preferred, cosmic reference frame.

The contradictions that result from attempts to avoid geocentricity are of a very basic nature. They involve such contra-

* Most galaxies in the universe appear to be receding from the earth. The evidence for that conclusion is that the spectra of galaxies are increasingly Doppler-shifted to the red with increasing distance.

dictions as we find in the explanation for stellar aberration, where relativity's explanation in no way represents what we actually measure.

Heliocentrically, aberration is indeed explainable by the earth's orbit around the sun, but aberration is also explained by Fresnel drag and it is also perfectly explained by the Lorentz-Fitzgerald contraction of the theory of relativity. The problem is that we cannot invoke all three explanations at once. Which of the three is *the* cause of aberration? Modern physicists accept all three at once! It is up to the preference and prejudice of the individual physicist and astronomer as to which he believes is the true explanation. Most adhere to the relativistic explanation, namely the Fitzgerald contraction, which was invented to explain the results of the Michelson-Morley experiment.

We saw that the main motive for the development of the theories of relativity was to keep the earth moving through space by inventing a geometry that makes every point in space look as if it stands still at the center of the universe. The genius of Einstein's approach is that he did it without having to retreat to an infinite universe. In the theories of relativity there are logical flaws and errors that cause the theory some problems. These we examined. Some of relativity's explanations are unphysical, in need of a mechanism to enforce them. These, as well as the solutions to the logical flaws are all solvable by classical (Newtonian) physics. In the final analysis, physicists adhere to relativity as devotees of a religious order. Relativity is the gospel that delivers them from their concept of hell: a geocentric, recently-created universe and its creator, Jesus Christ.

And with that segue; we leave the first-order experimental results and theories to examine second-order effects. Of these, the most important was the Michelson-Morley experiment.

Analysis of historical experience and the study of relevant sources again and again show the opposite of that which the positivists are yearning to cull from the chronicles of science. Scientific theories did not arise from experiments but were in every single case designed by the contemporary philosophical systems and the basic principles of religion and world-view. Only afterwards they were tested and, as far as possible, confirmed.

—W. Böhm¹

ABERRATION: MICHELSON-MORLEY EXPERIMENT

As more and more experiments were conducted in man's attempt to detect the flow of the earth through the ether, so more and more their results confirmed that the earth is standing still in space. Of the experiment we present in this chapter, the Michelson-Morley experiment, British mathematician, cosmologist, and historian of science, Gerald James Witrow (1912-2000) wrote:

[Consider] if such an experiment could have been performed in the sixteenth or seventeenth [centuries] when men were debating the rival merits of the Copernican and Ptolemaic systems. The result would surely have been interpreted as conclusive evidence for the immobility of the Earth, and therefore as a triumphant vindication of the Ptolemaic system and irrefutable falsification of the Copernican hypothesis.²

To rephrase Walter Böhm in the chapter quote, the heliocentric religion just does not conform to reality, even though it gives the appearance of reality. According to appearances and experimental results, the Bible is correct and its critics are wrong: the earth stands stationary relative to the third heaven, and shows no movement through the firmament. It goes against human nature, but God created “every thing beautiful in his time: also he hath set the world in their heart, so that no man can find out the work that God maketh from the beginning to the end” (Ecclesiastes 3:11). What we think we know, more often than not, keeps us from learning what we do not know. If today’s science’s know-it-all attitude had existed in the late 1800s, the Michelson-Morley experiment would never have been performed. But experiment could still topple theory back then. Now experiment must match theory or it’s the experiment’s fault if it doesn’t.

Introduction to the Michelson-Morley Experiment

In 1881 Albert Abraham Michelson (1852-1931, Figure 2) published a paper in which he proposed a method whereby the motion of the earth through the ether could be measured.³ Michelson’s proposal used an *interferometer*, a device which measures differences in path lengths as differences in the arrival times of two or more light rays. Michelson’s trial experiment was conducted in Berlin. The results were uncertain; Michelson could not be sure of his trial measurements for a number of reasons, including the jitters that horse-drawn traffic gave to his ultra-sensitive apparatus.

The rationale behind Michelson’s experiment is quite simple. Imagine two identical boats on a river whose current flows with velocity v from right-to-left (Figure 1). Boat **A** is to sail from point **c** to point **x** on the opposite shore and back again; boat **B** will also start from point **c** and sail to point **e** and back again.

Since the water is flowing from right to left, as far as the water is concerned, boat **A** followed the path **a** to **b** to **c**. Anyone on shore would only have seen boat **A** going from **a** to **x** and back to

c. At the same time, boat **B** starts eastward to point **e**, which is the same distance from **c** as **c** is from **x**. Boat **B**, too, turns around and heads back to **c**. Which will win the race?

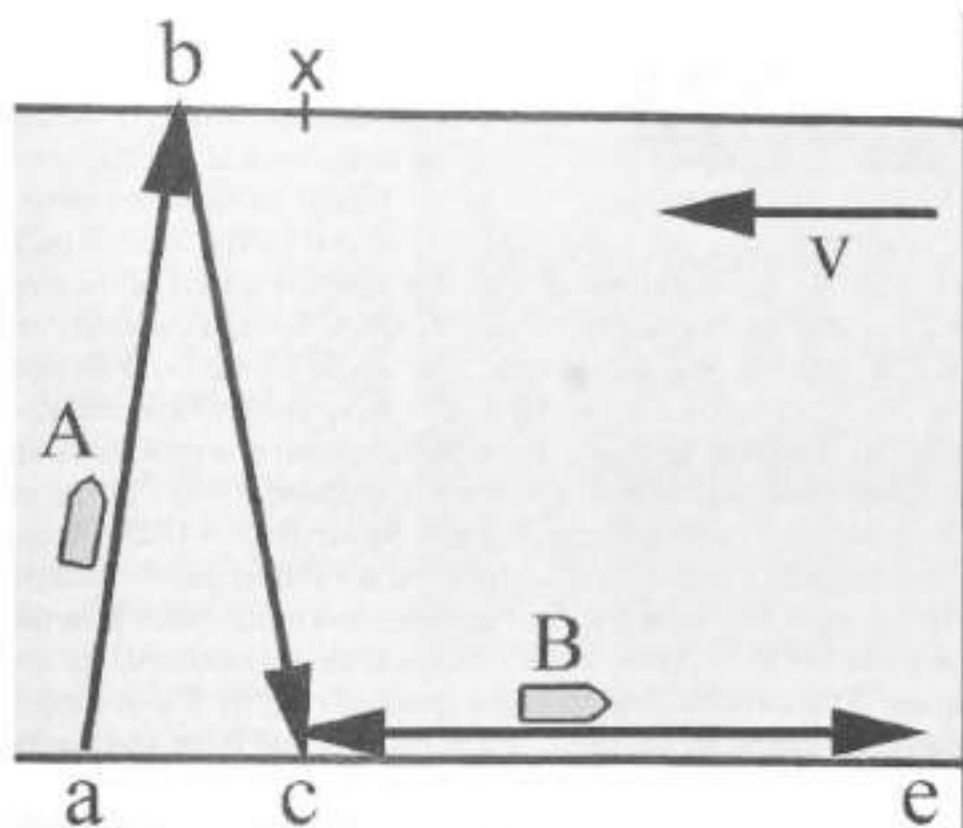

Figure 1: Michelson-Morley Boats

It is intuitively obvious that if there is no current, the two identical boats will each take the same amount of time to accomplish their round trip; they will simultaneously arrive back at **c**. However, we have a westerly (leftward) current moving at speed v . In that case, boat **B** will take longer than boat **A**. Sound impossible? Well imagine if the current was 10 miles per hour and the boat's maximum speed was 5 miles per hour. When the race starts, **B** will never reach **e** first because it will actually drift westward at 5



Figure 2: A. A. Michelson

miles per hour. Because the current is too swift, boat B will not even be able to return to *c*, let alone reach point *e*.

Replace the boats with photons and the stream by ether drifting by the earth, and the two light beams will not arrive back at *c* at the same time. Using an interferometer, Michelson and Morley needed only

to count the number of wavelengths between the arrival of the two light beams in order to find the earth's speed through the ether, or, as Michelson assumed, to measure the speed of the earth around the sun. This is the essence of the Michelson-Morley experiment.

In 1883 Michelson accepted an appointment to a professorship at Case School of Applied Science in Cleveland, Ohio. There, in 1887, he paired with Edward Williams Morley (1838-1923, Figure 3) of Western Reserve College to refine his Berlin interferometric experiment. This time the interferometer was much better than the one used in 1881. Again, a null result was almost obtained, but not quite. The wave shifts indicated a speed of roughly 8% of earth's supposed orbital speed. Still, it was decided that there was no indication of the earth's motion through space.⁴

Now here was a strange thing. The earth is supposedly "known" to be moving around the sun, yet all first-order experiments to detect that motion through space indicate that the earth is standing still; and now a second-order experiment—the Michelson-Morley experiment—also shows the earth to be standing still. This meant that something had to be devised whereby the earth could be kept in motion while the fundamental experiments all show that it stands still. In order to explain the results of the Michelson-Morley experiment, five possibilities were recognized, ignoring, of course, the possibility that the earth really is at rest in the dynamic center of the universe:

1) The ether is dragged along with the earth just like the earth's magnetic field is dragged along with it, a proposal made earlier by Stokes;

2) Another velocity or set of velocities of the ether through space conspired to mask the motion of the earth about the sun;

3) An as yet undetected slip in the theoretical calculations underlying the construction of the interferometer;

4) A hidden defect in the instrument nullifying the expected interference fringe shifts;

5) An as yet undetected and poorly understood phenomenon accounting for the null result of the Michelson-Morley experiment.



Figure 3: Edward Morley in 1887

There is no mention of the sixth possibility mentioned by some—that the earth is stationary in the ether. It was dismissed on the grounds that it is “unthinkable.” Instead, physicists chose the fifth alternative, in the form of the Fitzgerald contraction, to replace Newton's absolute space and absolute time. Lorentz derived his transformation to explain the observed properties of light transmitted through a luminiferous, light-bearing ether. Later, Ein-

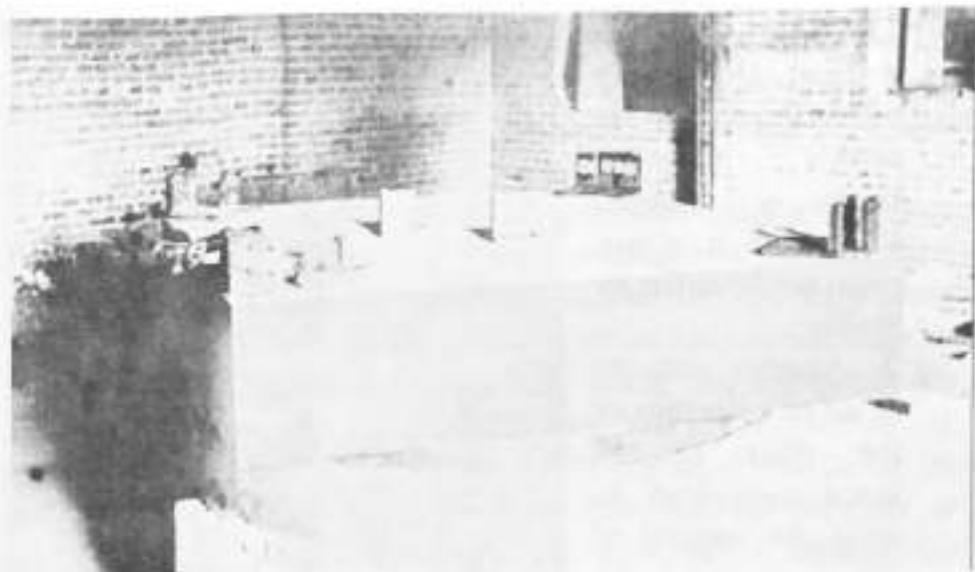

Figure 4: *The Original Michelson-Morley Equipment*

stein reinterpreted the transformation to be a statement about the nature of space and time; hence the term, *space-time*.

As we noted in Chapter 33, Einstein's 1905 special theory of relativity is not founded on a mountain of experimental evidence but on Einstein's assumption that the speed of light is the same to every observer, no matter how fast or how complicated his motion. When Einstein heard of the Michelson-Morley (M-M) experiment's result, he immediately pounced upon it as proof of his special theory of relativity. Now the M-M experiment only supports Einstein's theory if the result is exactly zero; but even today, the experiment's result is never exactly zero.

Before we go into the details of what happened to the M-M experiment, I'll say this about the modern versions of the M-M experiment. Experimentalists start with the assumption that there is no ether and so do not look for an ether drift but instead, look for something called *Lorentz invariance*.⁵ Lorentz invariance is a property, possessed by the laws of physics and of certain physical quantities, of being unaffected by a Lorentz transformation. In other words, it is just a mathematical way to keep the speed of light

the same in all directions. Of course, the more that any ether drift fails to materialize about earth, the more support for geocentricity.

Briefly, modern repetitions of the Michelson-Morley experiment test the assumptions of relativity; they do not test the ether-based assumptions of the underlying M-M experiment.

Dayton C. Miller's Experiments

Although the Michelson-Morley experiment has been performed many different ways to high degrees of accuracy, no one, not even in modern times, has ever achieved a completely null result. The non-zero results of the M-M experiment caught the imagination of the brilliant experimental physicist Dayton Clarence Miller (1866-1941, Figure 5). Unlike



Figure 5: Dayton C. Miller in 1921

others who had performed the M-M experiment only a few dozen times over the course of several days, Miller performed it hundreds of thousands of times in all seasons, in different places and in different elevations above sea level. Until his dying day in 1941, Miller claimed positive results of ether drift for not only his own experimental work (much of which was done with Morley), but also for the original Michelson-Morley experiments and others. Miller summarized his work in a lengthy paper which appeared in 1933.⁶ That article is a "must" for any physicist interested in the Michelson-Morley experiment.

Miller's results were quite consistent yet not at all what was expected from Einstein's special theory. For example, Miller consistently obtained a result of two kilometers per second for the interferometer's motion at Case Institute of Technology (Cleveland, Ohio), but he got a result of three kilometers per second in the hills surrounding Cleveland. On the other hand, he consistently obtained ten kilometers per second at Mount Wilson (Los Angeles, California). In each case the error or uncertainty in his observations amounted to about half a kilometer per second.⁷

Miller knew that the observations of the M-M apparatus must either be coupled to the sun or to the stars, so he plotted the directions in which he saw the maximum speeds in his apparatus. In 1928 he published Figure 6.⁸ The top half of the figure shows Miller's results plotted in sidereal time. A sidereal day is the time it takes from star-rise to star-rise. This amounts to 23 hours 56 minutes. The civil time used for the bottom half is the time from sunrise to sunrise, which is 24 hours; thus the sidereal day is four minutes shorter than a solar day. This is because the sun moves west-to-east relative to the stars during the course of a year.

The sinusoidal curve traced by the bold, dark line in the upper half of Figure 6 shows that the result of the Michelson-Morley experiment is not some fluke in the apparatus but is measuring a real speed with respect to the stars. The lower half of the figure shows no such wave pattern but best fits a straight line indicating that there is no relationship between the experimental data and the sun.

It is important to realize that the typical time spent on conducting a series of M-M experiments is a few weeks. Dayton Miller observed throughout the year. Miller's continued observations and positive results, even though they were only 8% of what the earth's supposed orbital speed, is still too great to "prove" relativity.

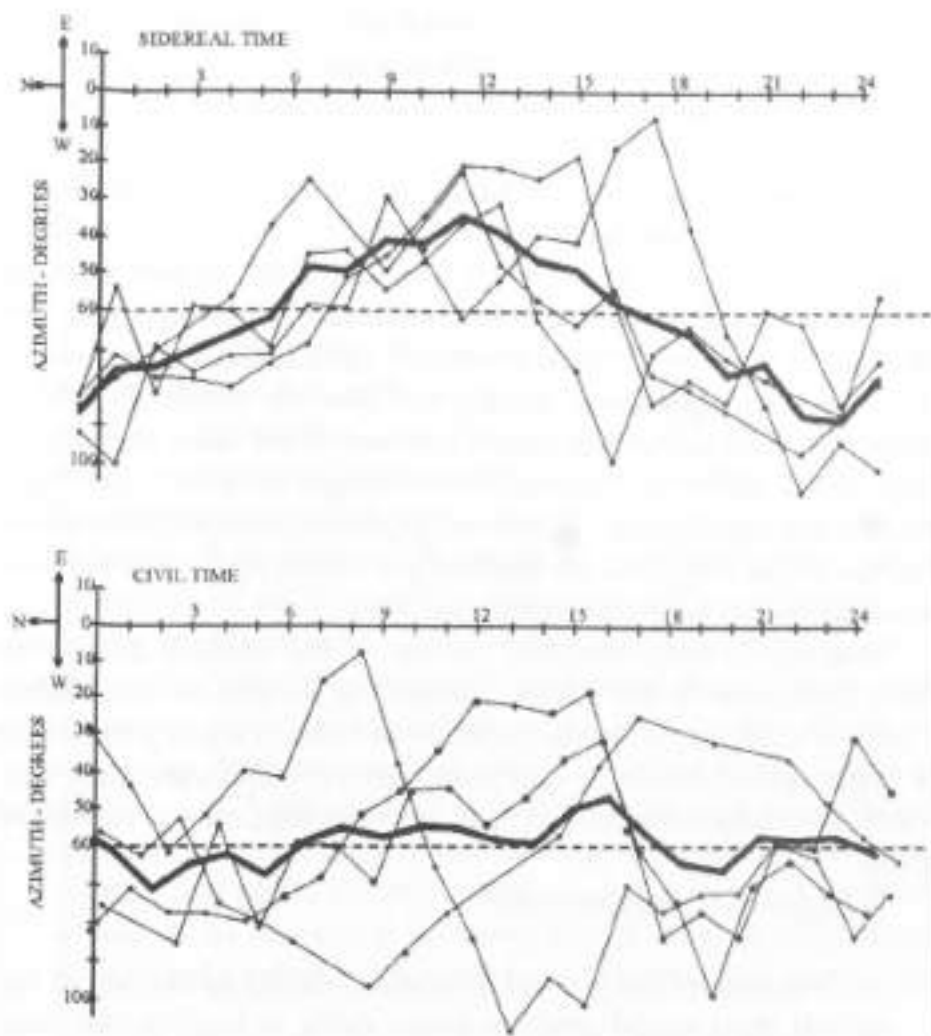

Figure 6: Miller's Results of the M-M Experiment

In the mid-nineteen fifties, Einstein came to Cleveland to visit a friend and ally named Robert Shankland (1908-1982). Shankland, an ardent fan of Einstein, was professor of physics at Case Institute of Technology, the same school where Michelson and Morley conducted their historic experiment. Shankland was more interested in popularizing physics than practicing it. Shankland and Einstein discussed a vexing problem namely the doubt shed on relativity by Miller's failure to find an average speed of zero in his thousands of repetitions of the

M-M experiment. Miller's results were a thorn in the side of relativity, not to mention Einstein himself. Thirteen years after Miller's death, Einstein and Shankland decided that a reevaluation of Miller's data was in order.

Shankland's team consisted of Sidney Warner McCuskey (1907-1979), Chairman of the Math Department at Case (later, head of the Astronomy Department), McCuskey specialized in Celestial Mechanics; Fred C. Leone, also of the Math Department, whose specialty was statistics; during WWII, Leone developed a graph paper that could be used by a sonar operator to quickly and precisely locate the whereabouts of a submarine. The fourth member of the team was Gustav Kuerti (1903-1978), an Austrian Jewish refugee from the war whose expertise was aeronautics. Kuerti was the silent (to avoid persecution) coauthor of *Die Fluglehre*, by Richard von Mises, which was the standard aviation text before and during the War.

Shankland's team analyzed several of the 24-hour data series Miller performed in the 1920s. Shankland focused on temperature changes throughout the day as the cause of Miller's result presented in the upper half of Figure 5. Not surprisingly, Shankland's team concluded that Miller's results were due to temperature effects throughout the day.⁹

In his paper, Shankland wrote:

...variations of only 0.001 [degree Celsius] in the air of the optical arms would produce fringe shifts as large as the average effects produced at Mt. Wilson. ...In what follows, we...must admit that a direct and general quantitative correlation between amplitude and phase of the observed second harmonic on the one hand and the thermal conditions in the observation hut on the other hand could not be established.¹⁰

In other words, Shankland could not establish that a temperature difference across the arms was responsible for Miller's results. The evidence presented by Shankland and co-workers appears to be consistent and convincing; but Miller was well aware of the ef-

fects of temperature on his experiment and, in fact, had thermometers along the arm for just such a check. In a 1926 paper Miller addressed that very issue, when it had been raised by Sir Oliver Lodge as a possible explanation for Miller's results, with the following words:

It is exactly for answering these questions and others, that the experiments have been continued over a period of six years, in which time thousands of readings have been made. Every disturbing cause that could be thought of has been exhaustively studied; among these are: daily and annual variations in temperature, meteorological conditions, radiant heat, magnetism, magnetostriction, differential gravitation, gyrostatic action, influence of method of illumination, transparent and opaque coverings of the light path, speed and direction of rotation [of the apparatus because it rotates during the experiment], lack of balance in rotating parts [of the interferometer], position of the observer, and other conditions. One after another, these disturbances have been shown **not** to produce the observed effects. ... [The] solution is entirely consistent with the observations of Michelson and Morley of 1887, and those of Morley and Miller of 1902-1906. ... [The] reported effect has always been present; it is clearly shown to be directly related to sidereal [stellar as opposed to solar] time, that is, to a cosmic cause.

In making the observations, two independent quantities are noted, the direction in which the interferometer points when the effect is maximum, and the amount of periodic displacement of the interference fringes. Each of these two sets of readings leads to an independent determination of the right ascension and declination* of the apex (direction of the measured drift) of the supposed motion of the earth in space. It is

* Right ascension and declination are the astronomical coordinates of an object in the celestial heaven corresponding to longitude and latitude on earth.

very significant that these two determinations are wholly concordant.¹¹

A similar inquiry sent to Miller from Einstein about the effect of temperature on Miller's results made the *Cleveland Plain Dealer* in 1926. The article said:

GOES TO DISPROVE EINSTEIN THEORY

Case Scientist Will Conduct Further Studies in Ether Drift.

Einstein Discounts Experiments

Speaking before scientists at the University of Berlin, Einstein said the ether drift experiments at Cleveland showed zero results, while on Mount Wilson they showed positive results. Therefore, altitude influences results. In addition, temperature differences have provided a source of error.

"The trouble with Prof. Einstein is that he knows nothing about my results." Dr. Miller said. "He has been saying for thirty years that the interferometer experiments in Cleveland showed negative results. We never said they gave negative results, and they did not in fact give negative results. He ought to give me credit for knowing that temperature differences would affect the results. He wrote to me in November suggesting this. I am not so simple as to make no allowance for temperature."

(*Cleveland Plain Dealer* newspaper, 27 Jan. 1926)

Despite the widely-held conclusion to the contrary, Shankland did not address the *real* issue, for his team was supposed to *disprove the top half* of Figure 6—the sidereal results, *not to confirm the bottom half*—the civil results. Shankland's confident proclamation that Miller's results were due to the temperature changes between day and night, sunrise and sunset, clearly tells us that he was drawing

his conclusions based on the civil or solar day not on the stellar or sidereal day. Shankland did nothing more than confirm that Miller was correct when he said he found no dependence of his data upon the solar day in the bottom half of Figure 6.

After proving Miller to be correct, Shankland promptly accused Miller of incompetence.* Nevertheless, it is clear that Shankland was the incompetent one for failing to realize that temperature effects average out over the sidereal year (top half of Figure 6) and so can't play any role in skewing the results. Regardless of the truth, astronomers and physicists blindly accepted Shankland's published result as the final word on the Michelson-Morley experiment. Relativity was "saved" and science breathed a collective sigh of relief; *the earth could continue to orbit the sun, and the Bible continue to be irrelevant to science*. Besides, no physicist would dare challenge relativity again on the grounds of Miller's data for fear of being charged with *incompetence*.

Shankland's failure to get rid of Miller's sidereal results leads to a conundrum for although Shankland and Miller's failure to find a dependence on the solar day is a *proof* of relativity, Shankland's failure to get rid of Miller's *sidereal* result *fails to support* relativity. If relativity is true, then the top half of Figure 6 should look just like its bottom half. Insofar as Einstein could only embrace the experiment as support for his special theory of relativity on the basis of the solar-day results, we thus find that *relativity is founded on the assumption that the sun is fixed at the center of the universe*. Since the sidereal results remained unchallenged, neither the sun nor relativity is fixed to the starry universe. In any case, Miller's sidereal results witness against Einstein's primary *assumption* that the speed of light is the same in all directions. This means that the traditional resolutions to the various paradoxes of relativity, which resolutions are resolved by using the universe as the preferred frame of reference, must be changed to use the sun as the preferred frame of reference. Thus the fruit of Shank-

* In his paper, Shankland constantly refers to sidereal time, as if that is the time scale he was using in his analysis of Miller's results. Nevertheless, his contrary evidence is based on solar time.

land's blind allegiance to Einstein.

All this is not to say that Miller's observations did not have any strange or unexplained effects. Hans Thirring, for example, pointed out that 95 percent of Miller's observations pointed to the northwest quadrant of the sky, no matter what time of day the observations were made.¹² Both Miller and Shankland's group also noted this phenomenon. Miller called it one of his most puzzling results.

In his 1933 paper, Miller refined his observations and reported that he had detected the relative motion of the earth and sun.¹³ He further reported that the sun appeared to be moving away from a position in the sky located near the Large Magellanic Cloud (a satellite galaxy of the Milky Way, visible in the southern hemisphere) and that said antapex was located about seven degrees from the pole of the earth-sun orbit. The right ascension of the antapex found by Miller is 4 hours, 56 minutes and the declination is 70 degrees, 33 minutes south which is roughly in accord with star-streaming. Miller still needed an orbital drag to account for his observations and so he assumed that the drag equaled star-streaming: stars streaming past the earth as they orbit the Milky Way. As for the puzzling phenomenon of most of the observations pointing consistently north-west, Cartmel noted that if the interferometer was slightly out of level, and if the mirrors were slightly out of line, then said misalignment could result in an observed cosmic "motion" of 300 kilometers per second, consistent with the observations of Miller as well as Michelson and Morley.¹⁴ But what are the chances of several different pieces of equipment being identically misaligned?

Explanations for the Michelson-Morley Results

There are other questions which are raised by experiments of the Michelson-Morley type. For example, are the path-lengths of the two light rays through the half-silvered mirrors really the same? What is actually measured? Harold Armstrong pointed out that the

length of the light paths was not measured in units of length (such as inches or centimeters) but by wavelengths.¹⁵ Likewise, although Michelson's analysis considered the light rays to have taken some time to travel along the arms, Armstrong noticed that it was not the time of traversal but the frequency of the light that the Michelson and Morley experiments measure. This means that there may have been Doppler effects present which were not taken into account by the analysis; that is, the two paths experienced different Doppler shifts, which change the wavelength and thus the frequency of the light beams.

In considering Doppler effects, Alfred O'Rahilly (1884-1969), an Irish Sinn Féin supporter and advocate of Ritz's ballistic theory of light, pointed out that those physicists who have analyzed the Doppler effect in the Michelson-Morley experiments in the past have been guilty of circular reasoning: they have assumed the Fitzgerald contraction to be in effect and so have not tested the original, classical hypotheses.¹⁶ Harold Armstrong, on the other hand, did consider the classical case, including the Doppler effect, and found that the expected shift is about 1.5 times the shift derived without the Doppler effect by Michelson.

M-M AND THE LUMINIFEROUS ETHER

Origin of Ether Theories

In our examination of the firmament in Chapter 6, we mentioned the two Greek concepts of ether: first as an infinitely dense medium called a *plenum* and second, as a vacuum consisting of atoms with nothing between them. We identified the firmament as consisting of a created substance that acts like a plenum to every material thing inside it.

The conditions under which objects can move through a plenum have only been known a century. Wave properties are the key, and the wavelengths of material particles must be vastly longer than the diameters of the grains (Planck particles) making

up the firmament. A hydrogen atom, for instance is 80 septillion (an 8 with 25 zeroes after it) times larger than one of the Planck particles that make up the firmament. To put this into perspective, if the hydrogen atom were blown up to the size of the universe, the Planck particle would only be about 250 meters (or yards) in diameter. But these things were not known before about 1900. As a result, the early ether theories were all based on the rarified vacuum material called the *luminiferous ether*.

It was Christiaan Huygens who, in 1678, first presented the ether theory of light propagation. Huygens reasoned that since water carries water waves and air carries sound waves, there must then be a material that carries light waves. He thus proposed that luminous bodies, like the sun, or the moon, or a torch, disturb the ether to create waves which reach our eyes as light. It was tempting to think that the air might carry the ether, but Huygens dismissed that idea since light can pass through a vacuum.

Etymology of Ether

It is worth looking into the etymology of the word, ether. In my first book I used the spelling, æther, to distinguish it from the flammable substance that is used as an anesthetic in operating rooms. The word is of Greek origin, we are told, and means *upper air*, the air that the gods breathe. Thus the air of heaven is "æther" (αἰθήρ) while the air that we mortals breathe is "air" (αἴρ). Aristotle postulated that the æther is a fifth element. (Classical Greek has four elements.) He envisioned a universe made of concentric spheres: earth, air, water, fire, and, beyond the moon, æther.

There is also a Greek god called Æther. He is among the first-born elemental gods, the *Protogenoi*. As such, he is the personification of the upper atmosphere, the bright, glowing upper air. The Greeks also associated him as the door or key to Tartarus, their hell of eternal torture.

From æther's description as bright and glowing, we can trace the etymology of æther a bit further. The word is associated with

αιθω, *aetho*, incinerated or burnt black as in Æthiopean. In consequence, ether has come to be associated with heat. That is how the chemical, ether, got its name, from its explosive property. David Lifschultz carries this a bit further.

The concept of the luminiferous æther came from the Pagan concept of their god Chemosh,^{*} and his æther, as Virgil writes,¹⁷ was everywhere.... The Hebrew root for the word is *cama* for heat or light and *yesh* for substance.

...The idea of God without a shape as Æther is transmitted to us from the Greeks though it dates back to Moab in the shapeless god of Chemosh, and thus is transmitted to us from the Bible (Numbers 21:29[†]).¹⁸

From the similarities between the firmament and the ether concept of the pagans, we can surmise that the properties of the firmament probably were known to the ancients, having been received by revelation through Adam but perverted over time into Pagan mythology. To the Greeks Chemosh is Comus, the god of lascivious feasts or partying. Each such feast had a commissar, responsible for security and manipulating public opinion. Today



Figure 7: Walter Ritz

^{*} Scripture calls Chemosh the "abomination of the Moabites" in II Kings 23:13.

[†] Numbers 21:29—Woe to thee, Moab! thou art undone, O people of Chemosh: he hath given his sons that escaped, and his daughters, into captivity unto Sihon king of the Amorites.

enforcers of party loyalty and manipulators of public opinion are still called *commissars*, comrade.

Newton's Ether

Huygens had proposed that light was a wave and that waves require a medium for propagation; Newton, however, took forty years of study and experimentation before he felt confident enough to publish his theory in his book, *Optics, or a Treatment on the Reflections, Refractions, Inflections and Colours of Light* in 1704. Newton favored the corpuscular theory of light. To Newton, a hot body throws off a corpuscle at the speed of light c , with respect to the speed of the emitting body. What that means is that if a hot body is moving towards you at five miles per hour, the speed of the corpuscle heading your way is $c+5$ miles per hour. Today, the corpuscular model is called the ballistic model of light, or emission theory, or, Ritz's theory, named after its twentieth-century champion, Walter Ritz (1878-1909, Figure 7), whom we first met in the section on non-ether theories of aberration in Chapter 32. Ritz proposed his theory to explain the results of the M-M experiment and was thus considered a rival to relativity.¹⁹ Even though Newton favored the theory, there were still problems with it and he knew it. The main drawback was the theory's inability to account for interference, which Newton called *inflection*. We touched upon those problems in Chapter 30.

Today, Ritz's work, and the ballistic model of light are said to be totally discredited, mostly on the basis that close binary stars whose orbits lie nearly edgewise to earth are expected to show multiple images in Ritz's model. In 1996 James Hanson derived the criterion that determines when multiple images will or will not occur. Multiple images will not occur if the binary star is within one light-period* from earth.²⁰ However, there are still ballistic-

* For instance, if the star's orbital period is one year, then multiple images will not occur if it is within one light-year from earth. Beyond that, multiple images will occur.

light supporters among the extremes in physics. Among them, some advocate a light-bearing medium in which the corpuscles or photons may start out with a ballistic velocity but will quickly lose that velocity by giving up their energy to the firmament. This is what happens to very high-energy charged particles when they enter a medium in which the speed of light is less than they were traveling in the vacuum of space. The particle loses the excess energy by emitting a cone of light in front of it until it reaches the new speed limit. The cone of light is called Cherenkov radiation and is used to detect very high-energy cosmic rays entering earth's atmosphere.

The Demise of the Luminiferous Ether

In 1880 there were several models of the luminiferous ether. Some physicists thought that it was solid and rigid; others thought it thin and tenuous. Some thought it could neither be measured nor detected, and others thought the ether was dragged along by the earth and other bodies so that you cannot measure the speed of the earth through the ether anymore than you can measure the outdoor wind speed in the heart of a cave. Finally, although no one dared to admit it openly, there was still the possibility that the earth was standing still in the ether.

The existence of *entrainment*, as the current model of ether being dragged by the surface of the earth is called, is still unsettled. The earth's magnetic field, for example, stretches out for thousands of miles from the surface of the earth. There is no reason why the ether could not be dragged by the earth (in either heliocentric or geocentric systems) just as far out.²¹ The same might be true of the gravitational field's effects. Some have even proposed that the magnetic field is the ether. Still others, among them yours truly, think gravitational fields are the ether. Since many books have been written on the luminiferous ether in the last three decades, we shall go no further in that topic but now return to the Michelson-Morley experiments.

Other Versions of the Michelson-Morley Experiment

Besides using an interferometer such as Michelson and Miller used, other variants of the Michelson-Morley experiment have been done. For example, in contrast to Miller's and the original Michelson-Morley experiment, Georg Joos (1894-1959) obtained the result that the alleged motion of the earth through space via his Michelson-Morley type apparatus was less than one kilometer per second.²² Or, just maybe, the earth stands still and the stars and galaxies are streaming past it at the observed rates.

There are other experiments related to the Michelson-Morley experiment which have also been conducted. One of these is the Kennedy-Thorndike experiment.²³ The Kennedy-Thorndike experiment is like the Michelson-Morley experiment except that, whereas in the latter the four arms of the interferometer were all the same length, in the Kennedy-Thorndike experiment they were of different lengths. Despite the fact that the Kennedy-Thorndike experiments, like the Michelson-Morley experiments, have never given a truly null result, the Kennedy-Thorndike experiment's results were taken to indicate that the Fitzgerald contraction and the slowing of the passage of time with increasing speed were real effects. Kennedy and Thorndike obtained a "speed" of the earth through the ether of ten kilometers per second with an error of 10 kilometers per second, consistent with Miller and the original Michelson-Morley results.

By the time the Kennedy-Thorndike experiments were performed, Hubble had already convinced the astronomical world that the universe is expanding and that the earth must be moving at speeds thousands of kilometers per second with respect to the universe at large. So it is not surprising that Kennedy and Thorndike dismiss their result with the words:

In view of relative velocities amounting to thousands of kilometers per second known to exist among the nebulae, this can

scarcely be regarded as other than a clear null result; it is of the same order of precision as that of the Michelson-Morley experiment.²⁴

Today there is still some evidence that the nebulae, now called *galaxies*, may not necessarily be moving with "relative velocities amounting to thousands of kilometers per second" after all. Kennedy and Thorndike's statement cannot be made with such bold assurance as we read above given the work on discordant redshifts by Halton Arp²⁵ and others.

A further refinement of the Michelson-Morley experiment was that of Jaseja *et al.*²⁶ Jaseja used two masers* producing infrared light as sources. This method has the advantage of providing sharp lines which give good, sharp fringes in the interferometer. The two masers were mounted perpendicularly to each other on a rotating table and the experiment produced repeatable variations in the frequency difference between the two lasers of about 275 cycles per second. The observed variation was assumed to be due to magnetostriction. No change exceeding three kilometers per second was observed over a period of six hours. Again, this result is not really null but is the same as Kennedy-Thorndike's, Miller's and Michelson-Morley's; nor is it out of line with an ether at rest relative to the earth.

In summary, it may be said that attempts to measure the translational motion of the earth through space come up with mixed results at best but generally close to zero. In any case, the value for the speed of the earth through the ether or the ether past the earth is very much smaller than expected from heliocentric speculations. In the twentieth century the results have been dismissed by claiming that there is no such thing as an ether. This flippant dismissal of a physical explanation for the propagation of light leaves only a metaphysical action-at-a-distance. This is the very same action-at-a-distance of which Newton had written that:

* A maser is a laser working at microwave frequencies.

no man who has in philosophical matters a competent faculty of thinking, can ever fall into it.²⁷

Thus Newton judged the heliocentrists of today.

Polarization Experiments

The experiments mentioned thus far, the Michelson-Morley and other optical types that led to Airy's failure, were all designed to measure the fundamental motion of the earth through space. Such motion is called *translational motion* and is thus distinguished from *rotational motion* which is a spin about some axis. All of the experiments were designed to detect absolute translational motion; that is to say, translational motion not necessarily with respect to the stars but with respect to some absolute frame of reference or standard of rest. But these two types of experiments are not the only kinds which can be or have been performed to measure the absolute motion of the earth through space.

In the last half of the nineteenth century, scientists realized that the motion of the earth through the ether should have some effect on the plane of polarization of a light ray. Now *polarization* is a phenomenon due to the electromagnetic nature of a light ray. A single ray of light does not behave like a three-dimensional object or wave but, instead, acts like the two-dimensional wave generated by shaking a rope tied to a doorknob. This is so because the electric field in a ray of light is usually confined to a single plane. If all rays of light from some source have their planes aligned parallel to each other, then the light is said to be *polarized*. When polarized light passes through certain materials, however, the plane of polarization can be twisted, just like party streamers, and such a phenomenon is called *rotation of the plane of polarization*. Now if the earth is moving through the ether—or if the ether were flowing past the earth at rest—then that motion should cause the plane of polarization to twist.

In 1872 Éleuthère Mascart (1837-1908)²⁸ performed an experiment to test for the rotation of the plane of polarization and discovered that the expected rotation did not occur for a light beam passing through a quartz crystal. His result was confirmed by J. W. Strutt (who later attained to the title of Lord Rayleigh).²⁹ Again, it appears that the earth is actually standing still.

Mutual Inductance Experiment

There is yet another way to detect the effects of the earth's supposed motion by direct experiment. This way is related to the aforementioned polarization effect, but it works on the mutual inductance of electromagnetic coils. Now "mutual inductance" means that electricity flowing through one coil of wires (such as is found in electric motors) can induce an electric current in a neighboring coil. This device is commonly known as a *transformer* and is found in such everyday devices as television sets, radios, and power lines. This is also how a 6-volt cell phone can be plugged into a 115-volt wall outlet without its circuits burning out.

Now the motion of the earth through the ether should have a slight effect on the electric current induced in the second coil by the first. In 1889 Theodor des Coudres (1862-1926) published the result of an experiment designed to measure just that effect.³⁰ Again there was no detectable effect so that again it looked as if either the earth was standing still in the ether or else there was some compensating effect which conspired to make it appear as if the earth were standing still.

Trouton-Noble Experiment

Just as the earth's motion may affect induction coils, so also it may affect capacitors suspended on elastic strings. The supposed motion of the earth around the sun should produce a torque (a twisting force) on the capacitor so that it should turn slightly during the course of the day. When Frederick Thomas Trouton (1863-

1922) and Henry R. Noble performed the necessary experiment, they discovered that there was no such torque.³¹ The experiment is commonly known as the *Trouton-Noble experiment* and the effect that they unsuccessfully searched for bears their names. In order to explain why the earth should appear to be standing still while everyone just absolutely “knows” that it is “really” moving, it is assumed that there is an elastic stress induced in the capacitor which exactly counteracts the torque induced by the motion of the capacitor through the ether. But again, the experiment can be interpreted as indicating that the earth really is stationary with respect to the ether. Thus it is that Whittaker was prompted to write:

At the end of the nineteenth century, one of the most perplexing unresolved problems of natural philosophy was that of determining the relative motion of the earth and the æther.³²

Other Experiments

In my 1992 book, *Geocentricity*, I had a long explanation of Stefan Marinov’s (1930-1997) coupled-mirrors experiment.³³ I will only give a short summary of that experiment here. Marinov was an experimental genius. I’ve met only one theoretician who understood the subtlety of the coupled mirrors experiment and that was Huseyin Yilmaz. For a short distance, as the light catches up with a receding mirror, the time delay allows a one-way speed of light measurement. Marinov overcame some shortcomings of his first apparatus and was able to detect some the results I report in Chapter 36, such as the drift of Vera Rubin’s shell of galaxies. Marinov was interested in and contributed articles in support of geocentricity to *The Bulletin of the Tychonian Society* and to its successor, *The Biblical Astronomer*. It is unfortunate that theorists are the glamour kings while experimenters are the lowly grunts in today’s science. Time was when theories were based on experiments. These days, experiments are designed to fit the theory. In the meantime, no one else has yet devised an experiment that

measured the one-way speed of light. Without that, a disproof of relativity theory is impossible.

Conclusion

A quick dictionary definition of aberration is: "A deviation from the proper or expected course." When Bradley saw that stars moved in ellipses reflecting the earth-sun motion he first thought he had discovered a star's parallax. But the star did not follow the path that was expected if it was a parallax: therefore Bradley called the phenomenon, "Aberration."

But aberration did not obey the expected rules either. The vector explanation of aberration we saw in Chapter 31 works for classical (Newtonian) physics but not for relativity where the speed of light is assumed to be the same in every direction. Maybe Einstein did blow it early on in his paper on special relativity when he appears to have forgotten a basic assumption as we noted in Chapter 33 when we looked at relativity and its failure to deal with aberration.

And when it came to experimental results, we found that relativity is based on the assumption that the sun is at rest as if it were the anchor of the universe. All this because of some sleight of hand with the difference between Dayton Miller's sidereal results, which showed a dependence of the Michelson-Morley experimental results on sidereal (star) time, but gave relativity's expected result of no dependence on time for solar (sun) time.

At the time of this writing, relativity is sacrosanct, and anyone who challenges it will be called a lunatic or, at least, a member of the lunatic fringe. But relativity's failure to explain aberration by a physical process makes such slavish obedience to it aberrant, to say the least.

We are finished looking at the alleged optical proofs for heliocentrism. We find that the proofs are based on the eclectic method, where you pick and choose. We found no shortage of examples that ignored straight-forward geostatic results (Arago's experiment,

Airy's failure, Michelson-Morley's results and more) and simply dismissed or ignored the geostatic result. In the case of optical proofs, it took more than 75 years for physics to dream up a theory that would keep all things, including the earth, moving while every optical and mechanical experiment would measure the speed and spin of every object to be zero. Occam's razor* points to the theory of geocentricity.

* Occam's razor says that the simplest theory that meets all the criteria and observations, that is, all known facts, is most likely the true theory.

I pause to note that one may scan Einstein's writings in vain to find mention of the Sagnac or Michelson-Gale experiments. The same can be said of general physics textbooks and of the 1971 *McGraw-Hill Encyclopedia of Science and Technology*. ... Such an oversight in these distinguished encyclopedias constitutes a stinging indictment of professional scientific reporting.

—Dean Turner¹

ROTATION

In the last few chapters we have noted the failure of fundamental experiments to detect the motion of the earth through space when observing first-order effects in v/c , that is, the fraction of the earth's speed around the sun divided by the speed of light. Such failure, though not necessarily predictable from geocentric theory, was not surprising. The fly in the ointment for the modern physicist is that Dayton C. Miller, among others, also obtained near-null results for second order (v^2/c^2) that were close but not exactly zero. So both first- and second-order experiments are consistent with a stationary earth.

We now consider rotation: rotation of the firmament versus rotation of the earth. What are the effects of rotation and are they different for geocentricity and heliocentrism?

That the geocentric theory will give the same results as are derived from the heliocentric model should not come as a surprise. Imagine the earth to be rotating on its axis every 24 hours and imagine that it does so embedded in a huge block of wood. Furthermore, assume that the surface of the earth is covered with

sandpaper. It is then quite evident that the spin of the earth would scour the block of wood in which the earth is supposed to be rotating. Now notice the reverse. Imagine that the earth is not rotating and that the block of wood rotates around it in the opposite direction. We see that again the block of wood in which the earth is embedded will be scoured by the sandpaper. For the same reason, if the universe rotates around the earth, then experiments done on the surface of the earth should show the same results as if the earth were rotating. In what follows we describe two experiments which have been performed to detect the relative rotation of the earth within the firmament. In the above illustration of these experiments, the sandpaper is the ether a.k.a. the firmament.

The Sagnac Effect

It is possible to modify the Michelson-Morley apparatus to check for the relative rotation of the earth and the ether (our firmament). Remember, that if such a rotation exists, the experiment cannot distinguish between whether the earth actually rotates and the ether is at rest, or whether the earth does not rotate and the ether spins around it. This test for rotation was first performed by Georges Sagnac (1869-1926) in 1913, and his result came to be known as the *Sagnac effect*.²

In his experiment, Sagnac sent two beams of light in opposite directions around a turntable (Figure 1). If the turntable rotated clockwise, then the light circulating in one direction will arrive at a detector sooner than the light going in the opposite direction. The reverse is true if the turntable rotates in the opposite sense. Sagnac rotated his turntable at two revolutions per second and found the expected effect; that is, he demonstrated that absolute rotation could be measured. Sagnac's experiment has been performed accurately enough to discern the period of absolute rotation of the firmament is the sidereal day of 23 hours, 56 minutes.

Although Max von Laue used special relativity to predict the positive result for the Sagnac effect in 1911,³ it was subsequently

pointed out by Ives⁴ that the theory of relativity could not explain Sagnac's result. This means that relativity, with its length and time contractions needed to explain why the earth "looks" stationary to the Michelson-Morley experiments but fails to explain why Sagnac's interferometer shows the same earth apparently rotating without the time or length contraction required by relativity.

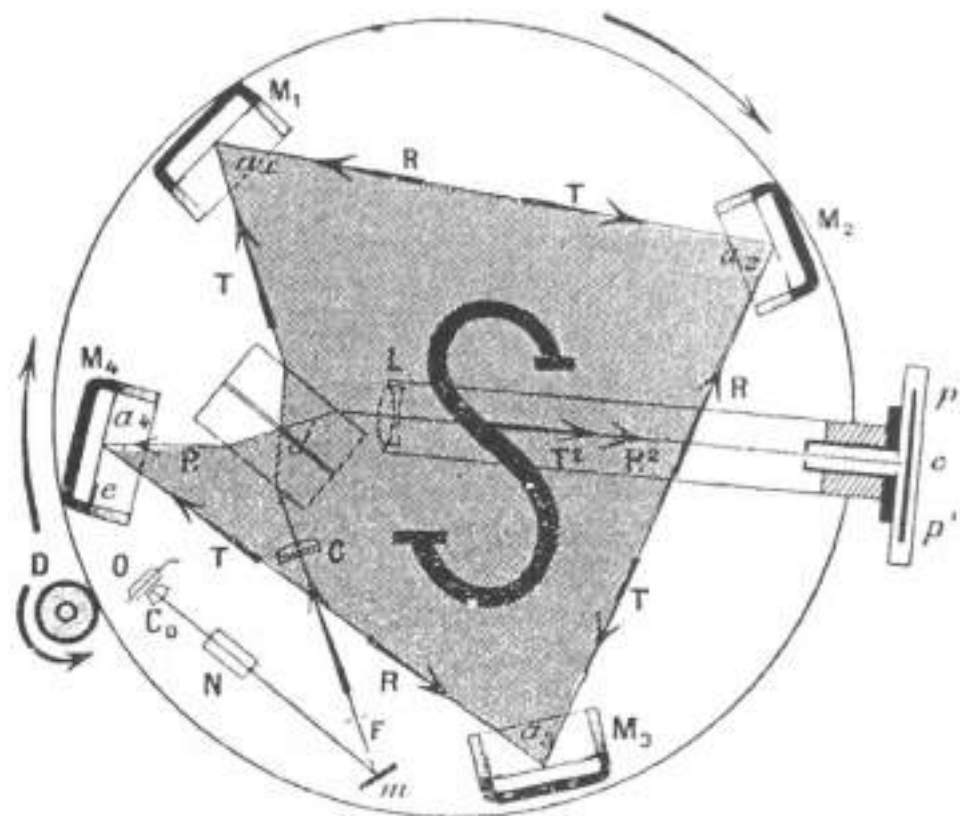

Figure 1: Sagnac's Apparatus: A beam of light is emitted from a source at *O* (lower left). The beam is split into 2 beams at *j*. The beams go around the shaded region, "S," in opposite directions and come together again in the interferometer sticking out at the right. The interferometer detects any time difference in the two paths. The entire instrument is mounted on a rotating table driven by wheel *D*.

Geocentricity predicts that earth's lack of motion is absolute because the earth stands still in absolute space (that is, at the center of mass of the firmament). Geocentricity further predicts that rotation is relative. And that is exactly what fundamental experiments

designed to measure the motion and rotation of the earth relative to a light-bearing medium (the firmament) detect. The experiments indicate that the earth is not moving through the firmament but that there is a relative rotation. There have been a few relativistic attempts to explain the Sagnac effect while maintaining relativity to be true; but these inherently assume that there is such a thing as an ether to begin with and thus are not truly relativistic explanations.⁵ Another type of “out” for relativists is one like that described in Browne’s paper:⁶

The explanation of the Sagnac effect is simple for the inertial frame of reference. The motions of the mirrors during the light transit time between mirrors causes the clockwise and counter-clockwise waves to be reflected at different points of space, which leads to an optical path difference.⁷

Laue’s 1911 relativistic prediction of the Sagnac effect assumes an inertial frame of reference, which is why it gets the correct result. But that is equally true for the rotating apparatus of the Michelson-Morley experiment. Ives claimed this simplistic explanation can be belied by simply considering the light path to be tangent to a reflecting cylinder—that is, to replace the individual mirrors by one cylindrical mirror. In that case the cylindrical mirror need not even rotate at all and Browne’s “simple” explanation fails.⁸ This also nullifies Browne’s proof that the ether cannot rotate around the earth.⁹ Ives concludes his analysis of the Sagnac effect with the statement:

[If the observer’s] apparatus rotates with respect to the stars he will observe a Sagnac effect, if it does not, then no matter how great a relative rotation it exhibits with respect to its material surroundings, there will be no Sagnac effect.¹⁰

So who is right: Ives or the relativists? In a way, both are right. Each group starts out with a theory based on different as-

sumptions. If evidence crops up that runs contrary to the theory, the theory is adjusted to allow the new evidence. This ability was formalized by a nineteenth century mathematician named Joseph Fourier (1768-1830) who discovered that any theory can be rescued from any contrary evidence by adding enough cyclical terms to absorb the evidence or to explain it away. In mathematics this leads to a method of curve fitting called *Fourier analysis*. That's how relativity can explain just about everything that comes its way.

At first sight Ives' statement would appear to counter the geocentric position, but it does not do so for Ives states that the apparatus should rotate "with respect to the stars." This indicates relative rotation and is true whether we view the stars as stationary and the apparatus (earth) as rotating or whether we view the apparatus as stationary and the stars as rotating about the apparatus.

Over the intervening decades since Sagnac's result was published, several variations on his original experiment have been performed. The variations have been designed in an effort to either confirm or deny Sagnac's result. Most such experimental variations have involved things like conducting the experiment with the apparatus in a vacuum, or else inside some medium other than air; or to have the medium rotate while the mirrors are held stationary with respect to the earth. All of these variations agree with Sagnac's original result.¹¹ Still another variation was that of Dufour and Prunier who kept the light source and observer separated from and not moving with the turntable on which the mirrors were mounted.¹² Their result was the same as Sagnac's.

Michelson-Gale Experiment

The most spectacular variant of Sagnac's experiment was that performed by Michelson, Gale and Pearson in 1925. The theoretical development for the experiment is due to Michelson¹³ of Michelson-Morley fame. The experiment's results were published in 1925.¹⁴ The experimental apparatus consisted of a rectangular pipeline, 2010 by 1113 feet, laid in a field near Chicago (Figure 2).

The pipeline was evacuated and light was passed in opposite directions around the rectangle. Michelson and Gale, too, as had Sagnac before them, detected the "scouring" of the ether past the earth's surface.

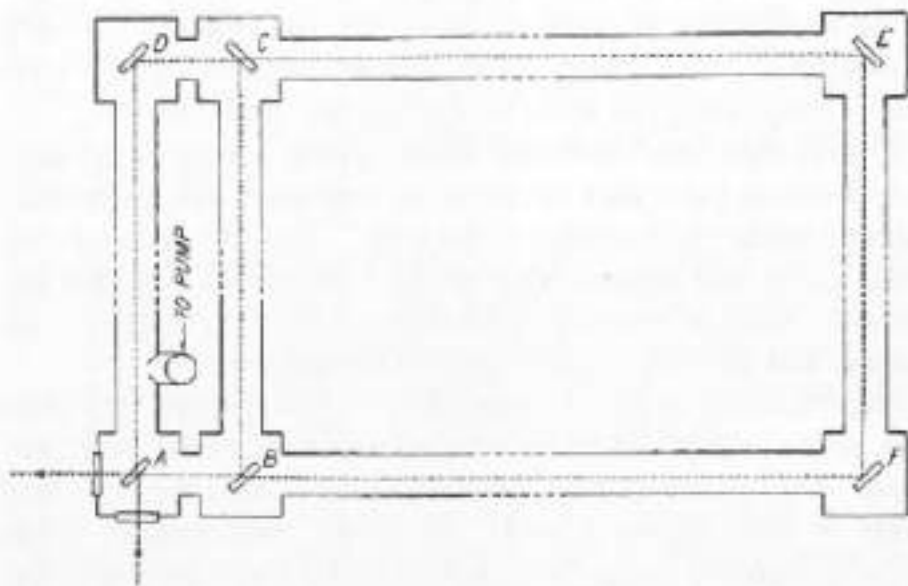

Figure 2: *The Michelson-Gale Experiment*

Yet, as with the sandpaper analogy which started this chapter, the experimental results cannot, of themselves, tell whether the earth rotates in the ether or whether the ether rotates about the earth. The Sagnac-type experiments run contrary to the theories which were designed to explain how the earth could "appear" to be standing still while everyone "knows" that it moves. The results of the Michelson-Morley and Sagnac experiments are all exactly what would be expected in a geocentric universe and have yet to be explained in a heliocentric setting. Thus modern science concludes that although translational motion is relative, rotation is absolute. This is usually stated as, "relativity does not deal with accelerating systems. However, this conclusion is because of relativity. Geocentricity concludes the reverse.

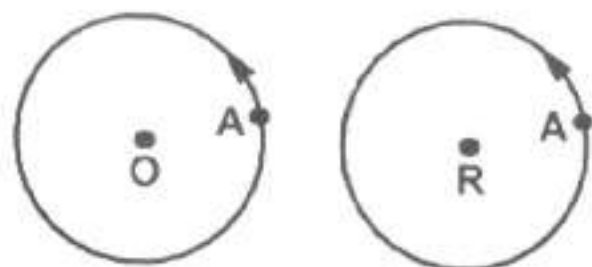

Figure 3: *Orbit vs. Rotation*

To see the problem that relativity has with rotation, consider Figure 3. On the left, we have a particle, *A* orbiting particle *O*. For the sake of illustration,

we will imagine that *A* always has the same face pointed to *O* and that the orbital period is one day. Now consider the right side of Figure 3. Here *R* is a particle at the center of the *rotational* path followed by *A*, which also has a period of one day. *A*, of course, also keeps the same side facing *R*. The distance *OA* is the same as the distance *RA*, so that the motions are in all ways the same. But, according to relativity, on the left side, *A* is subject to length contraction and time dilation. The right side presents the Sagnac effect and the claim that relativity does not deal with acceleration says *A* is not subject to the length contraction and time dilation of relativity. But if this is all you see, how can relativity sense the difference? It should not be able to see any difference, and considerations such as this parallel the objections of Herbert Ives, Charles Poor, and others even to this day.

Rotation Paradoxes

Given the problem presented in Figure 3, with relativity's contradicting response, we should expect paradoxes to spring from relativity. For instance, we see that on the one hand, rotation is considered to be absolute whereas an equally accelerating planetary motion is relative. These things are clearly inconsistent, and a number of physicists throughout the years have attempted to point this out to the majority of scientists. The latter, however, presume that the majority knows best, not to mention that their funding

comes from the establishment. They then fall prey to the same logic that once proclaimed the earth to be flat; simply because “the majority of scientists know best.”

The key experiments designed to detect the rotational effects of earth and ether were the *Sagnac* and *Michelson-Gale* experiments. Both gave positive results, and neither has been successfully explained by relativity. Einstein was apparently so embarrassed that his theory could not explain the rotational results that he never mentioned either experiment. Because he did not mention them, many physicists believe he never heard of them.¹⁵ The immediate paradox that results in relativity from this failure to deal with rotation is the *Ehrenfest paradox* described in the Chapter 33; but most “proofs” of relativity simply ignore the Sagnac and Michelson-Gale experiments. Alternative models, presented to augment or rival relativity, mostly ignore the Sagnac effect, too. Stefan Marinov, though he does mention Sagnac and Michelson-Gale, ignores the Ehrenfest paradox because his theory suffers from the same malady as relativity.¹⁶

The Geocentric Solution

In this section we describe how the Coriolis force present in a spinning firmament can have every particle in the universe carry trace out the sun’s yearly path.¹⁷ To simplify this technical description, we shall assume that we are rotating with the firmament—including the universe embedded in it—in its daily rotation on its axis that passes through earth’s north and south poles. This rotation drives the behavior described below. Also, we shall assume that the universe is a cylinder, that is, we shall imagine that we are on the rotational equator of the firmament, which is a reasonable assumption for at least a billion light-years north and south of earth’s central position.

Imagine a glass half-full of water. Slosh the water back and forth until it rises up one side of the glass while it dips on the other side. The slosh-wave represents the gravitational field of the fir-

mament. That is the basic principle we'll consider in this section, and thus far you can do this for yourself. The next step is a bit more difficult.

Now let the glass rotate until all the water is rotating with the outside of the glass as if the water is a solid body. Once the water is rotating uniformly, again drive the water to slosh as before (that's the really, really hard part). This time, if you do it correctly, you'll find that the water is not sloshing back and forth as in the non-rotating case. Now the slosh-wave itself rotates relative to the table on which the glass is rotating. Its slosh-period is now shorter than it was when the water was not rotating. This kind of circulating wave is called a *progressive wave*. The progressive wave represents the firmament's gravitational field; it carries the Coriolis and centrifugal forces with it.

Now return again to sloshing the water back and forth, but this time sprinkle some aluminum flakes on the surface of the water so you can see how the slosh wave carries them along. The flakes only work on the surface, but if we could spread them throughout the volume of water we'd find the same rules apply lock-step. In the non-rotating case, the water carries the flakes back and forth in the direction of the wave from crest to trough and back to crest. In the rotating progressive wave case, however, you will see all the aluminum flakes trace out a circle in the water. The Coriolis force induces the circle. Every aluminum flake is in lock-step with all the others. If one goes to the left, they all go to the left. Each flake's circle is the same diameter as all the others' circles. This would be true for the flakes even if they were inside the water and not just on the surface. Figure 4 shows the progressive wave inclined from upper left to lower right (remember, the firmament's gravitational wave is three-dimensional, not the two-dimensional surface wave of our cup example).

Furthermore, if you looked from the side, along the surface, you would see that the flakes also move up and down with the same period as the circles we saw when looking down from above. Indeed, if the slosh-height of the progressive wave was inclined 23.5 degrees to the equator of the daily rotation, we would have an exact description of how every material body (exemplified by the aluminum flakes) is carried by the firmament in a yearly motion, that is, moving in a circle inclined 23.5 degrees to the daily-rotation's equator.

So far we've imagined that we are rotating with the progressive wave. Now, let's switch from moving with the daily rotation to being anchored to the "room" (Third Heaven). Instead of an inclined circle we will see that the flakes, representing stars, planets, galaxies, even atoms, now trace out a helix that spirals south and back north over the course of a year, even as we mentioned earlier when describing the sun's overall motion about the earth (Figure 5).

In Figure 5, the inclined circle is the path traced out by the aluminum flake representing the sun in the previous description; here it is the path that the sun traces out each year along the ecliptic. The daily rotation of the firmament rotates the plane of the sun's path, i.e., the ecliptic with it. When combining the two motions, the sun, which could equally represent a distant star or even a photon traveling through the firmament, will trace out the identical, parallel, heliacal path as represented in Figure 5.

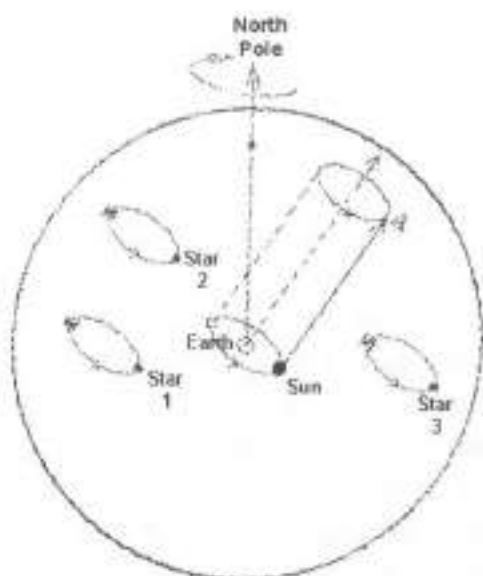

Figure 4: *Coriolis Force Carries the Stars & Sun In a Lock-step, yearly path*

We will return to this illustration in Chapter 37. This is the real key to understanding geocentricity's dynamics.

Conclusion

We began with a double-mindedness in science's attempts to keep the earth revolving about the sun and rotating daily on its axis. In the case of revolution, relativity postulates length contraction and time dilation to make every point in the universe look as if it is at rest in the center of the universe, particularly one point circulating around a central point. But when it comes to rotation, these contractions play no role. Relativity cannot deal with rotation and so is only partially effective against absolute space, and that, in turn, makes it ineffective against the geocentric model of the universe and firmament.



Figure 5: *The sun's inclined path through the Zodiac and the daily rotation that traces out the helical path of the sun. (Not to scale.)*

Using a rotating fluid model with an induced progressive wave to represent the inertial gravitational frame, we find that we can describe the yearly motion as an effect induced by the Coriolis force of the yearly spin; and, when adding the rotation of the fir-

mament, we can account for the observed heliacal motions of not only the sun but all astronomical bodies out as far as we can see and measure. This geocentric explanation answers all objections raised to date. The model will, of course, generate new objections, but this model, at least, is founded on confirmable observations based on sidereal time as well as solar time, unlike relativity that is experimentally based only on solar time.

Hopefully, it will not force a return to the pre-Copernican view.

—Vera C. Rubin *et al.*¹

LESSER EVIDENCES

Because so much of the universe appears to be centered on the earth, and since everyone “knows” that the earth cannot be the center of the universe, astronomers have strained to explain away the mountain of astronomical evidence showing the earth to be in a special place in the cosmos. The foremost “explanation” is called the *cosmological principle*.^{*} Simply stated, the cosmological principle maintains that any point in the universe is generally the same as any other point in the universe; that the universe generally looks the same no matter where you are. In particular, it follows from the cosmological principle that since the earth looks like it’s at the center of the universe, every place in the universe must look as if it, too, is located at the very center of the universe. But that was why the theory of relativity was invented, to make every point look as if it’s central to the universe. In other words, the cosmological principle is just a flat denial of geocentricity.

Cosmological Principle

Implicit in the concept of the cosmological principle is the idea that the universe is homogeneous, but this is not the case.

^{*} Just to keep everyone confused, the cosmological principle is also known as the *Copernican principle*, and the *homogeneity principle*. Sometimes the word principle is changed to *hypothesis* or *assumption*; it’s all the same thing.

Matter is clumped together in the universe. In speaking of the cosmological principle, Geoffrey Ellis writes that it is:

assumed for *a priori* reasons and not tested by observation. ...Furthermore, on the scales where we *can* make reasonably unambiguous observations, there are some indications that the Universe does *not* settle down to a homogeneous state even at the largest distance scales.²

The fabulous theory of evolution is also invoked to account for the apparent special position of the earth. For example, Ellis acknowledges that:

...the number of radio sources contradict the homogeneity assumption unless there is very considerable source evolution.³

Ellis here refers to galaxies and quasars which emit radio waves. He alludes to the fact that the number of sources in a given volume of space (source density) appears to vary as a function of the sources' distance from earth in a way which is symmetric about the earth. In effect, the radio sources seem to be distributed in concentric "shells" centered on the earth. The big bang speculation for the origin of the universe (the idea that the universe exploded into existence from the firmament) is invoked to conclude that we look to more massive, "primitive" objects as we look farther out, away from earth. That assumption is being challenged as "normal" galaxies are found farther and farther out.

Science tries to avoid dealing with the evidence against the cosmological principle by claiming that the scale on which the cosmological principle is true is greater than our *event horizon*—that we just cannot see the "truth" of the cosmological principle because we do not see "enough" of the universe to witness its truth. This pushes the "proof" of the cosmological principle into the unobservable and makes its validity untestable. To claim that man cannot see out far enough to prove that the cosmological principle

is true assumes that there is a part of the universe which we cannot see. This assumption is most likely true, but to demand that what we see of the universe is not representative of the universe-as-a-whole simply because it does not fit into a set of preconceived notions is sheer arrogance. It is analogous to a tribe of men which have lived their entire lives in the Amazon rain forest; upon seeing an occasional red leaf decide that most trees in the forest must have red leaves.

We mentioned above that evolution is invoked to circumvent the evidence that the earth is at a special place in the universe, but evolution does not accomplish that end. For example, clusters of galaxies get unexpectedly dim the farther out one looks from the earth, whereas evolution says they should get brighter because they are younger.⁴ Hence the *a priori* reasons referred to by Ellis for invoking the cosmological principle are little more than an attempt to avoid the evidence for the centrality of the earth in the universe; not only in God's plan and purpose, but also in his creation. To quote Ellis again:

Any weakening at all of the homogeneity principle implies a preferred position for our world—which is what the principle was designed to avoid.⁵

The Redshift⁶

We begin with a description of spectra. Light is radiated in waves of many different lengths. The eye distinguishes the different wavelengths as colors—long waves are red, and short waves are blue or violet. When we look at a luminous body, the eye receives a beam of composite light—many different colors, mixed in different proportions. However, if the beam of light passes through a glass prism, or other suitable device, the individual rays are bent in different degrees, depending on the wavelength, and the colors are spread out in an ordered sequence called a spectrum. The rainbow is the familiar example.

The sequence never varies. From the long waves of the red, the wavelengths steadily diminish through orange, yellow, green, blue, indigo to the short waves of violet. The spectrum may be long or short, depending on the apparatus, but the relative positions in the sequence remain unchanged.* Position in the spectrum indicates the wavelength of the particular light in question; relative brightness at the position indicates the relative abundance of the particular wavelength in the composite radiation. Therefore, a spectrum furnishes valuable information concerning a distant light source because it indicates the particular colors that are radiated, and their relative abundances.

When it comes to stars, the light from their surface will pass through cooler gasses in their atmospheres. Each gas will absorb some of the colors, removing the color from the background light. Each color absorbed by a gas is very specific to that gas and shows up as a very narrow dark line in the star's spectrum. The dark lines are called *absorption lines* because they indicate colors that have been absorbed by the gas.

If, however, a gas in the atmosphere is hotter than the light-emitting gasses underneath it, the hotter gas will add intensity instead of absorbing it; that is, the spectral lines that characterize the gas will stand out as bright, narrow lines in the star's spectrum. In each case, the colors are characteristic of the gas. Thus the colors absorbed by hydrogen gas are far different than those absorbed by helium.

Now it so happens that when a star moves away from us, its speed increases the wavelength, making the light's "pitch" lower, that is, redder; just as the sound of a car or train horn as it goes by you drops to a lower pitch. When done with light, this is called *redshift*. If a star approaches us, its light's wavelength is shortened and we say it's *blue-shifted*. When we look at the light of galaxies, we find that, for the most part, the gas absorption and emission lines do not appear at the same place they do on earth. Most of the

* Recall the color sequence mnemonic, ROY G BIV.

galaxies exhibit a redshift. This implies that most galaxies are moving away from us and we conclude that the universe appears to be expanding. The change in wavelength due to approaching or receding motion is called the Doppler shift.

Since most galaxies and quasars are redshifted, we call the phenomenon the *cosmological redshift*. It seems that the more distant the galaxy, the greater its light is Doppler shifted to the red end of the spectrum. This is generally interpreted as meaning that the farther a galaxy is from the earth, the faster it moves away from the earth. In the 1930s this led to the conclusion that the universe is expanding and so it must have started by exploding from a single point. This scenario is popularly called the "big bang," but logic dictates that such an explosive start for the universe would either leave a central core or have a geometric center (Even a four-dimensional sphere has a center). In short, such a universe should have a center. After all, any finite space must have a geometric center; and, since the expansion is about equally distributed about the earth, then the earth must be at or near the center.*

There is one way around the dilemma that there must be a center to space, and that is to retreat into the metaphysically absurd by claiming that the big bang was not so much an explosion into space as it was an explosion of space itself. Of course, any finite volume still has a definable center. Besides, this can only mean that there is nothing outside the universe, a point that, if nothing else, runs contrary to Scripture. Logically, if space is expanding into nothing, (nothing being outside of the space we call the universe), then the universe must be smaller than the nothing into which it is expanding. This is clearly absurd, although one may be tempted to retreat into the inverses of Cantor's transfinite numbers; but doing so is way beyond the scope of this book.

* By the way, the substance from which the universe is claimed to have originated is the Planck particle sea we've identified as the firmament. Since the firmament was created on the second day of creation, the universe of the big bang evolutionists—especially theistic evolutionists such as Hugh Ross—cannot have existed before the second day of creation.

To hear modern astronomers tell it, there can be no room for doubt that the universe is expanding from a gigantic explosion of space some ten to twenty billion years ago, but there are other explanations for the redshift. One involves gravity, but as Paul Davies pointed out:

...as we see only redshifts whichever direction we look in the sky, the only way in which this could be consistent with a gravitational explanation is if the *Earth is situated at the center of an inhomogeneous Universe.*⁷ (Emphasis added.)

In order to circumvent the obvious conclusion that the earth is located at the very center of the universe, astronomy built a framework in which every point inside the universe looks as if it is located at the center of the universe. Such a point of view is not new. The ancient Greeks had this view of the universe over two thousand years ago. They maintained that the universe was an infinite sphere with its circumference nowhere and its center everywhere; but the ancient Greeks at least realized that such could only be true of an infinite universe, whereas the big-bang speculation illogically produces a finite universe. The Greeks did make a mistake about the shape of the universe, though, since the center of an infinite universe would be everywhere whether the shape of the universe was a sphere or a cube or any other shape. In fact, it is not meaningful to speak of the shape of any infinite object since shape implies a boundary or limit.

Ellis, realizing the geocentric nature of the evidence, postulated that the earth is located at the anti-center of the universe, not at the center. In Ellis' model, space is shaped like a sphere's surface and the center of the universe is a supermassive black hole, the light of which is redshifted so much that it looks to us as if it has a temperature of only three Kelvins (3 K). Picture it like a pole on a sphere, the North Pole, for instance. In Ellis' model the earth is at the anticenter: the South Pole in this case. The nearer a galaxy is to the center of the universe, the North Pole in our analogy, the

more its light will be redshifted.⁸ Ellis' model has become an oddity among cosmological models, and it is not without its problems;⁹ but it is interesting to see that the preponderance of geocentric evidence in cosmology has finally forced a geocentric-type model, albeit the earth is there placed opposite the center. Regardless of the interpretation you may want to bring to the cosmic redshift, it is a geocentric phenomenon.

Milky Way

So far we have looked at only a handful of factors which upset the cosmological principle. There are more, but for now we shall look at just two to show how ultrasensitive the cosmological principle and cosmology are to the relative rotation of firmament and earth. The first example shows how very slight inaccuracies in the rotational theory of the earth can have major consequences in our estimates of the size of the Milky Way.¹⁰ This has repercussions which are far-reaching and which ultimately affect astronomers' estimates of both the size and the age of the universe. Our second example is that by redefining the *rotational axis* of the earth, certain puzzling wobbles of the currently-held rotational axis can either be introduced or removed.¹¹ Both effects are too technical to be considered here, and they are presented merely to underscore the lack of any solid foundation for modern cosmology in general—along with the cosmological principle—and heliocentrism in particular.

There is a third effect that relates to a special position of the earth in the Milky Way. In any spiral galaxy there is a circle, called the *corotation circle*, which is where rotation velocity of the galaxy's disc coincides with the rotation velocity of the galaxy's spiral pattern.* The Milky Way is a spiral galaxy, so it, too, has a

* The spiral pattern is maintained by a density wave that rotates around the galaxy's center. The wave is like when you first start to stir a cup of tea; you push the water with your spoon. That "packing" of the water by the spoon is akin to the density wave of a spiral galaxy.

corotation circle. In 1999, Mishurov and Zenina published a paper in which they concluded that "...the Sun is very close to the corotation circle."¹² With an uncertainty of 1200 light years in the location of the corotation circle, the sun is within 300 light years of the circle. What that means geocentrically is that the spiral arms are "fixed" to the earth.

One of the great worries of astronomers is that when a spiral arm sweeps by the sun, the density wave driving the arm will generate severe cosmic rays, as well as form young, hot stars near the sun, which stars will explode as supernovae. A supernova happening within a hundred light years of earth is capable of producing so much radiation that it is likely to destroy virtually all life on earth. The earth's location on the corotation circle means that the spiral arms will not sweep past the earth but the earth will stay fixed in nearly the same place, namely the sheltered area where it now is.

The Solar System's Fibonacci Series

The December 2002 issue of *Impact* from the Institute for Creation Research was devoted to an article by Fred Willson on the mathematical patterns found in nature.¹³ In particular, the article describes a mathematical sequence called a *Fibonacci Series*. The series is created by taking the numbers one and two and then forming the next number in the sequence by adding the previous two together. The series runs:

1, 2, 3, 5, 8, 13, 21, 34, 55, 89, 144, 233, 377, ...

What caught my attention in that article was the fit to the Golden Ratio of Willson's revolution periods for the planets. When the larger of an adjacent pair of numbers is divided by the smaller, the ratio is usually close to 1.618. This ratio is called the *Golden Ratio*. It turns out that rectangles, whose sides satisfy this ratio, are pleasing to the eye. I noticed that the period ratios of Mars and

Venus appeared to have been “corrected” in the paper. The earth’s value appeared to have been adjusted by an unknown editor to fit the expected, theoretical ratio. The earth’s value was anomalous (see the 5th and 7th columns in Table 1).

Willson commented on his original, pre-adjusted finding: “It is my opinion that this anomaly is evidence of God’s showing the uniqueness of planet earth in relationship to the whole cosmos.” Of course, I take that a step further and point out that if Willson is correct, then it shows that the earth is not a planet. Willson correctly notes that the observed value for earth would not be expected if the solar system was formed by the commonly accepted Nebular Hypothesis. The solar system had to be created, for if it came about by chance, the Fibonacci series would fit the earth, too.

FIBONACCI RATIOS FOR THE PLANETS						
Planet	Period (years)	Observed Period Ratio	Expected Fibonacci Ratio	Expected Fibonacci Value	Best-fit Observed Ratio	Best-fit Observed Value
Pluto	248.43	---	---	---	---	---
Neptune	164.78	1.51	3:2	1.50	3:2	1.50
Uranus	84.02	1.96	2:1	2.00	2:1	2.00
Saturn	29.46	2.85	3:1	3.00	3:1	3.00
Jupiter	11.86	2.48	5:2	2.50	5:2	2.50
Asteroids	4.60	2.58	8:3	2.67	8:3	2.67
Mars	1.88	2.45	13:5	2.60	13:5	2.60
Earth	1.00	1.88	21:8	2.63	13:8	1.63
Venus	0.62	1.61	34:13	2.62	21:13	1.63
Mercury	0.24	2.58	55:21	2.62	55:21	2.62

Table 1: Willson's Fibonacci Ratios for the Planets

I redid the analysis without fudging the planetary periods to force-fit to the Fibonacci ratios (column 3 in Table 1).¹⁴ I discovered that without altering the periods of Mars, the asteroids, and Venus, only two objects are affected by the anomaly, Venus and earth. Willson does not go into a detailed defense for ICR’s adjustment other than to wave his hands saying that some

creationists have postulated that an “unknown cosmic force” altered the solar system about or at the time of Noah’s flood. But that is nothing more than a creationist version of Velikovskyism. The “unknown cosmic force” is proposed because the actions postulated cannot naturally occur. It is remotely possible that miraculous events at the time of the flood may indeed have moved the planets around, but as there was no need for God to do so to create the flood, and as there is no mention of such events in Scripture, it seems pointless to invent a superficial miracle to explain what may or may not be a true pattern in planetary periods.

Elsewhere I reported on the special place that Venus holds in the creation.¹⁵ Venus is the only planet identified with the Lord. In particular, Venus, the morning star, is identified with the Lord Jesus Christ in Revelation 22:16,

I Jesus have sent mine angel to testify unto you these things in the churches. I am the root and the offspring of David, *and* the bright and morning star.

Though it may be tempting to adopt Willson’s analysis and say, “See! The earth is not a planet,” there is sufficient evidence for that without this rather circumstantial datum. But if both Venus and earth hold a special place, as indicated in both Willson and my analyses (in his table, Willson highlighted both their rows in green), we should not be upset. Both earth and Venus have a special place in Scripture; earth because God created it for man to dwell there and to enjoy God’s glory and grace, and Venus as a type of the Scripture—as a light shining in darkness and heralding the morning, and as the herald of the Lord Jesus as he will return to establish a righteous and everlasting kingdom on earth. What Willson has stumbled upon is not so much that the earth is special, but that the Scripture is special; for no other solar system objects, except the sun and moon, are singled out specially in Scripture. Earth and Venus are distinct in the Fibonacci series because they are distinct in Scripture: the earth because it is in a special state,

i.e. stationary, in creation, and Venus because it is a type of the Lord Jesus, both the word of God (Mark. 7:13^{*}) and the Word of God (Revelation 19:13[†]). Though not geocentric, this piece of evidence does put the earth in a special place as an exception to a mathematical rule that is expected to apply to the solar system and does so for every planet except earth and Venus. In geocentric theory, and now in its Fibonacci ratio, the earth isn't a planet either.

Resonances

Besides the violations of cosmology's cosmological principle, there are geocentric evidences from other branches of astronomy. One of these involves something called *orbital resonance*. The term, "orbital resonance" means that there is some relationship between the orbits of two planets or the lengths of their days. In particular, a most notable orbital resonance is that which exists between the earth and Venus. Venus displays the same face to the earth each time that the earth and Venus are closest to each other.¹⁶ Because of the relatively small masses of Venus and earth, this phenomenon is not explainable in terms of orbital evolution over the mythological age of the solar system. Despite the alleged billions of years which evolutionists have insisted that the earth and Venus have co-orbited the sun, neither object has been around long enough to have achieved the observed phase-lock. True, the phase-lock does not seem to be exact, there being a slight difference of roughly one hour between the actual correspondence and the exact correspondence; but that may well be due to the uncertainty in determining the exact length of the Venusian day, and it is certainly a very small fraction of the Venusian day as well as a small fraction of the thousands of hours that elapse between

^{*} Mark 7:13— Making the word of God of none effect through your tradition, which ye have delivered: and many such like things do ye.

[†] Revelation 19:13—And he was clothed with a vesture dipped in blood: and his name is called The Word of God.

successive conjunctions. It is also possible that the correspondence may have been exact in recorded history; within, say, the last several thousand years.

Venus is not the only case where a body's orbital or diurnal rotation is synchronized with the earth. An analysis of the lengths of the day and the year of Mercury reveals that it, too, is nearly synchronized with the earth in the same way as Venus. In fact, conventional evolutionary wisdom dictates that if Mercury is phase-locked at all, it should be rotationally locked to the sun and orbitally with Venus; but both Venus and Mercury are phase-locked to the earth. Mercury is weakly coupled to the sun in that its day, which is about 56 of our days, is roughly two-thirds of the length of its year; but it is coupled much more strongly to the earth than to either the sun or Venus.

We may also note that the rotation of the sun is roughly equal to one lunar month. This means that the rotation of the sun appears to be coupled to the earth-moon system. Most will dismiss this as "coincidental," for there is no physical reason why or how such coupling should come about. Others will remark: "Remember thy Creator...." Here I merely note the inexact similarity and leave it at that.

Mars is next on the list, but there is presently no such resonance between Mars and the earth. The Martian day is, however, only a few minutes longer than the terrestrial day which is coincidental enough considering that the lengths of the days of the other planets do not nearly match the length of earth's day.

Everyone knows, of course, that the moon is phase-locked to the earth because it always presents the same side to the earth throughout the month. No one challenges its geocentric nature.

Data on the outer planets are too uncertain to determine whether such resonance exists relative to the earth. This is primarily because there are no good observations for the length of the day for those objects. All that is seen through a telescope is the tops of the clouds; but given what we do know namely, the atmospheric periods, any resonance appears to be absent.

Distributions About the Earth

There is circumstantial evidence for the earth's special place among the nearby stars, too. This evidence is rather weak, but then we are not dealing with strong evidences in this chapter. One of the best illustrations of such stellar evidence is the distribution of F-type stars about the sun. F-stars are a class of stars which are slightly hotter and more massive than the sun. It seems as if the earth is located near or at the center of a concentration of F-stars. Astronomers have written a comparatively large amount on this special situation of the earth, and it still has not been "solved" although it is generally believed to be just a "cosmic accident."¹⁷ There is a similar but somewhat weaker concentration of K-stars about the earth.¹⁸ (K-stars are slightly cooler and less massive than the sun which is itself a G-type star.)

As we proceed farther from the earth we return to the cosmological scene where we find some more evidence, this time in the redshift phenomenon. There are several pieces of evidence which result from the redshift (Doppler shift) of light from distant galaxies. One of these involves the so-called *superluminal velocities*. The case in point involves objects which appear as points of light in the realm of visible light and there they are highly redshifted. When examined at radio frequencies they do show a size and they seem to be throwing out matter or expanding at speeds up to 45 times the speed of light. One would suspect such cases to be rare, but they are anything but rare. In one study about 40 percent of a sample of "compact objects" exhibited superluminal velocities.¹⁹ According to relativity the superluminal velocities are only apparent, resulting from a rare alignment of high-speed motion by the source toward the earth. The problem is that 40 percent is way, way too common to satisfy relativity's "rare alignment" requirement. In other words, the jets of matter are aligned in a preferred arrangement about the earth, namely, preferring to lie in the plane of the sky, perpendicular to the line of sight rather than pointing to or away from the earth.

To escape the resulting geocentric implication, it is assumed that the radiation we see is also "beamed" in the same direction as the motion of the jet (on a line connecting the two objects moving at superluminal speeds). That explanation is not without its problems. Thomas Phipps, Jr. wrote of the problem and noted that there are three things we know about these objects and that to avoid the geocentric conclusion, there are five things postulated. In his words:

It will be observed that...the number of hypotheses exceeds the number of facts.... The hypotheses are complicated, the facts simple. Moreover, concerning the physics of the quasar-beaming process, apparently *no hypothesis* is offered. But if it were, that would surely—for elucidation of its predicates—sure further hypotheses.²⁰ (Emphasis in original.)

Continuing with the geocentric implications of certain redshift phenomena, we note that in theory one expects the motion of the earth through space to show up as a departure from the mean velocity of a shell of galaxies centered on the earth. This analysis has been done in several ways, all with more or less positive results even though the results themselves are inconsistent. For example, by comparing supernovae (stars which explode with extreme violence and can temporarily become brighter than a galaxy) in distant galaxies, Le Denmot and Vigier claim to have detected the motion of the earth and sun relative to such a shell.²¹ That is to say, the average of the radial velocities of the supernovae is not zero about the earth. Such an effect was also noted by Rubin, Thonnard and Ford²² who concluded that relative to the shell of galaxies which they examined, the sun moves through space at a speed of 600 ± 125 kilometers per second in the direction of right ascension 2 ± 1.3 hours and declination 53 ± 11 degrees north of the equator.²³ Their result has since been confirmed by Schechter²⁴ and Rubin.²⁵ They conclude that:

If experiments under way or planned confirm the high degree of isotropy of the 2.7 K background radiation, and optical studies confirm a motion of the sun, $V > 300$ km/sec, then the resolution of this conflict should enhance our knowledge both of the early history of the Universe and the motions of galaxies, r about equal to 100 Mpc. Hopefully, it will not force a return to the pre-Copernican view of a hierarchy of motions whose sum is zero at the Sun [sic].²⁶

Even so, Schechter noted that half of the sample of galaxies in that shell had to be rejected from the analysis for one reason or the other. This means that the result may not be as solid or meaningful as it might appear. Also, an expansion rate for the universe (Hubble constant) of 50 kilometers per second per megaparsec was used. The detected effect is somewhat sensitive to the assumed value of the Hubble constant about which there is still considerable uncertainty. The uncertainty lies not only in its true value (which appears to be close to 100 km/sec/megaparsec), but also in its significance.²⁷

Cosmic Background Radiation

A presumably better view is one where the shell is taken to be the 3-degree Kelvin (3-K) blackbody radiation. The radiation is due to the heat energy released in creating the elements, which heat energy has been spread all over space. Evolutionists usually assume the heat to be left over from the big bang. The theory of geocentricity sees the 3-K radiation as the signature of longitudinal (shock) waves reverberating through the universe. Either way, one can imagine the 3-K radiation field as a sea of radio waves pervading the entire universe. The velocity of the sun through the sea of blackbody radiation is called *anisotropy*. Experiments performed over the last few years to measure the temperature of the universe in different directions of the sky show the cosmos to be slightly "warmer" in one direction and "cooler" in the opposite direction

and this is said to have established the reality of the anisotropy. The temperature difference is interpreted as due to the motion of the earth through the universe, and these results barely agree with the Rubin and Ford results.

The detection of the 3-degree Kelvin (3K)²⁸ anisotropy is attributed to Smoot, Gorenstein, and Muller,²⁹ although Corey and Wilkinson arrived at the result a year earlier.³⁰ Corey and Wilkinson's result for the relative motion of the earth and 3K shell (the direction to the point where the cosmic drift past the earth originates) was 330 km/sec from right ascension 12 hours and declination -10 degrees with an uncertainty of about 20 degrees while Smoot et al. derived a value of 390 km/sec (± 60) from 11 hours and declination +6 degrees and an uncertainty of ten degrees. The latter direction is toward the Virgo Cluster of galaxies. So far the failure to detect any anisotropy in the polarization of the 3-degree Kelvin radiation indicates that this effect is not due to one part of the universe "expanding" more rapidly from the earth than the opposite portion of the sky. This observation is itself geocentric.

Despite the magnitude of the speed (about 350 kilometers per second), the speed of space drifting past the earth and sun is actually quite low, less, for example, than the speed of the center of the Milky Way through the universe. Although the 3 K blackbody radiation is viewed by some as the modern ether, it is not actually so; the radiation can also be induced by shocking the firmament. So much for motion about the earth and Milky Way.

The Quasar Distribution Problem

In 1976 a paper entitled "The Red Shift Hypothesis for Quasars: Is the Earth the Center of the Universe?" was published in the journal *Astrophysics and Space Science*.³¹ In the paper, Y. P. Varshni (1932-) of the University of Ottawa, Canada, analyzed the spectra of 384 quasars, all the ones known to astronomy in 1975, and found that 152 of them fell into 57 groupings, all of them

grouped by similarity in their spectra, not by redshift. In his abstract Varshni concluded that:

[T]he cosmological interpretation of the red shift in the spectra of quasars leads to yet another paradoxical result: namely, that the Earth is the center of the Universe.¹²

Varshni's classification scheme was not designed to group quasars or quasi-stellar objects (QSOs) by similarity in their redshift values, but by the appearance of their spectra. When the members within the 57 groups were examined for redshift, it was discovered that quasars with similar spectra had almost identical redshifts.

Furthermore, such groups were not physical clusters since the individual members were scattered all over the sky, not being found in any local clustering of objects (Figure 1). For instance, his group number 31 consists of three quasars which span some 66 degrees, or about one sixth of the way around the sky.

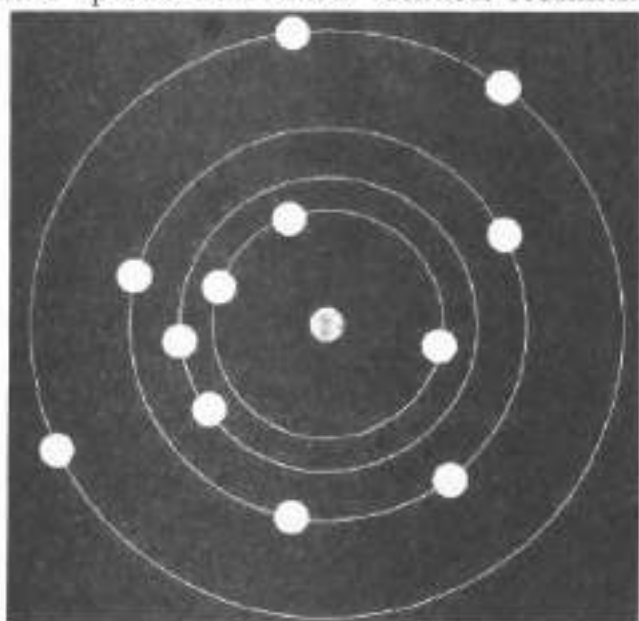

Figure 1: *Varshni's shells of quasars*

Since the groups were thusly distributed, and since each group has almost exactly the same redshift as well as the same spectrum, implying that they are all the same distance from earth, Varshni concluded that:

assuming the cosmological redshift hypothesis, the quasars in the 57 groups...are arranged on 57 spherical shells with the Earth at the center.³³

After considering two alternative explanations for the effect, Varshni finds that he is forced to conclude that if the redshift hypothesis is correct for quasars—and most astronomers take it to be correct—then:

the Earth is indeed the center of the Universe. The arrangement of quasars on certain spherical shells is only with respect to the Earth. These shells would disappear if viewed from another galaxy or quasar. This means that the cosmological principle will have to go. Also it implies that a coordinate system fixed to the Earth will be a preferred frame of reference in the Universe. Consequently, both the Special and General Theory of Relativity must be abandoned for cosmological purposes.³⁴

Is it a chance occurrence? an accidental arrangement? Varshni calculated the odds against the arrangement being accidental at 3×10^{86} to one.³⁵

Varshni believes that quasars are local and that they are not at the cosmological distances conventional wisdom places them, and he presented his findings as a way to win support for his local hypothesis of quasar distribution. But the evidence is still mounting against his alternative in favor of the hypothesis that quasars are truly at cosmological distances.

In the early 1980s, it was rumored that Varshni had changed his mind about the groupings, but as of 1989, he still believed that if the analysis was done properly, the over 2,000 quasars and quasi-stellar objects then known would still fall in similar shell-like groupings.

Even if Varshni's results were not valid, quasars and quasi-stellar objects (QSOs) are still distributed in a shell with the earth at

the center. Modern astronomy has "swept" the problem "under the rug," so to say. It is never overtly mentioned in the literature, being referred to instead as the "quasar distribution problem" so that, if the reader is not "in" on just what the problem is, maybe he'll dismiss it as something minor. It would seem to be a very great embarrassment.

Although Varshni promotes the local hypothesis for quasars and thus believes that the geocentric issue will be circumvented, this can be shown not to be the case. Within each of his groupings the velocity dispersion is typically no more than 450 km/sec total, assuming that the reported redshift values are good to within about 300 km/sec, which is a bit optimistic. This means that even if quasars are as local as Varshni believes and Arp's³⁶ data seems to indicate, there is too little spread in the redshifts within a group to eliminate the conclusion that these are distributed in concentric shells, especially given that there would also be some spread in the production of the redshifts in Varshni's model.

If Varshni's local hypothesis is correct, then all of the quasars would be concentrated within about 35 million light years from earth, and then the earth would be at the very center of a shell or concentration of quasars. As Green and Schmidt pointed out, if quasars are local, then their space density must increase strongly with distance from the earth.³⁷ The authors also note that the properties of quasars change markedly with redshift, which they presume to be a measure of the quasar's distance from the earth. The reference to a changing density in the population of quasars about the earth is another way of saying that the earth appears to be in the very center of the system of quasars, even if the quasars are not local. The reference to "marked changes" in the properties of quasars as their distance from earth increases is generally assumed to be due to a "strong evolution" effect. Even so, whether we assume evolution or not, or whether Varshni's results are correct or not, the earth appears to be dead center of a set of concentric shells of quasars.

Tiftt's Tiff

As if that were not enough, in the early 1970s William Tiftt of the University of Arizona reported that galaxy redshifts seem to cluster at intervals of 72 kilometers per second. That means that on the average, any particular galaxy moves away from the earth at 72 km/sec or sometimes at half that value (36 km/sec) or at a third of that value (24 km/sec). Tiftt has consistently used the best redshift measurements available. Twenty years later, Bruce Guthrie and William Napier of the Royal Observatory at Edinburgh reported independent confirmation of Tiftt's "quantization" results.³⁸ As if to add fuel to the fire, Tiftt reported in the *Astrophysical Journal* of December 1, 1991, that galaxy redshifts measured from earth have changed slightly over the few years. Older radio redshifts of galaxies differ slightly from newer ones for the same objects. If that trend is real, by the mid-1990s, Tiftt reported, "the extended time baseline will permit important critical tests of both quantization and variability" of galaxy redshifts. The results, again, place the earth at the center of concentric shells, this time of redshifts with a period of 72 kilometer per second or resonance thereof.

What is significant here is that the 72-km/second arrangement of shells about the earth applies only about the earth. The center of the shells fall within 100,000 light-years from earth, about the diameter of the Milky Way. Move farther than that away from the earth and the shells disappear. Russell Humphreys, who believes that the Milky Way, albeit not the earth, is at the center of the universe says this of Tiftt's results:

The probability of us being so close to the center by accident is less than *one out of a quadrillion*, implying we are where we are as a result of purposeful design. Not liking these high odds for God, the secularists have sought other explanations for the redshift quantization, without much success so far.³⁹

Walls of Galaxies

In 1989 astronomers discovered that there was a region of the universe in which there were many more galaxies than in any other region of the universe, in particular, more than exist near our own Milky Way. Astronomers described this grouping of galaxies as a "wall of galaxies," and one came to be known as the *Great Wall*.

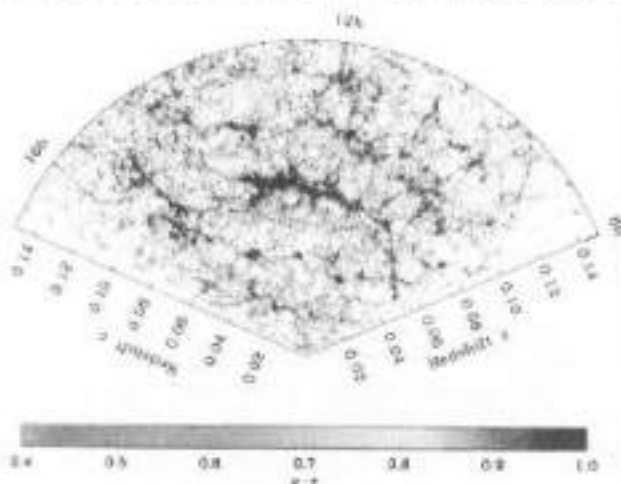

Figure 2: Some of the walls of galaxies about the earth found by the SDSS Galaxy Redshift Survey.⁴⁰

A 1990 study found that the Great Wall extended around the sky. By late 1990 it was discovered that the earth is located at the center of at least seven concentric shells, each a "Great Wall" in its own right. Each shell or bubble of galaxies appears at regular intervals, about 417 million light years apart (Figure 3). Each shell contains the same density of galaxies, and it is clear from the number of spikes in Figure 3 that there is no shortage of geocentric shells.

Over the intervening twenty years, more and more walls and streams of galaxies and clusters of galaxies have been found. Figure 2 is the most recent showing the walls that seem to form a circle around the earth, which is located at the point of the cone. Over a million galaxies are plotted in the figure. The walls are in black, which signifies elliptical galaxies. Elliptical galaxies are

usually the most massive in galaxy clusters and have very little dust in them. There seems to be no such clustering for spiral galaxies. You should also note some walls that point to the earth. Today's extragalactic astronomers focus more on voids, regions boxed in by the walls of galaxies, devoid of galaxies themselves. The Milky Way is inside one of those voids, but off center.

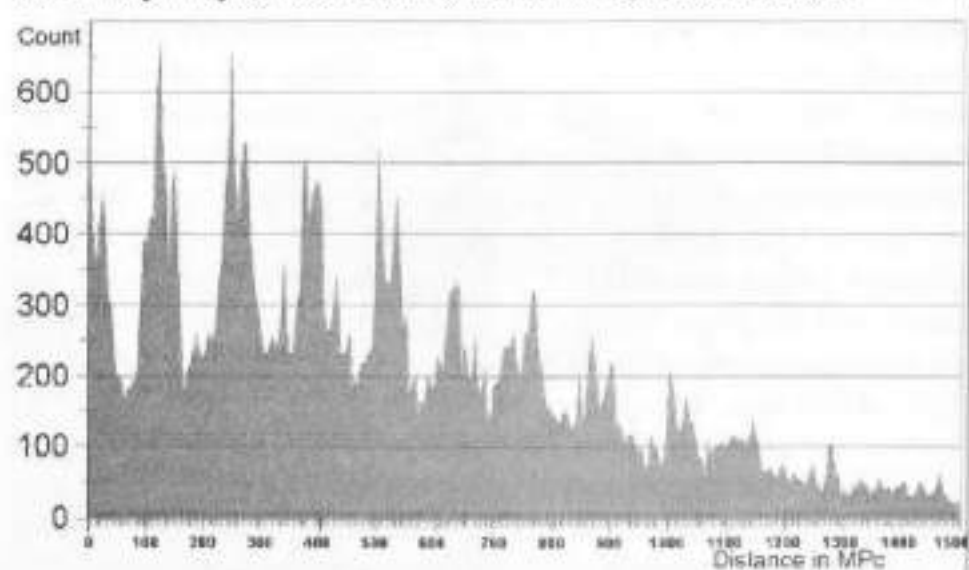

Figure 3: *Shells of Galaxies Clustered About Earth*⁴¹

Gamma-ray Bursters

The Compton Gamma-ray Observatory (CGO) was a satellite designed to observe the heaven at gamma-ray wavelengths. (Gamma rays are more energetic than x-rays and much deadlier.) CGO was launched in 1991 and operated until 2000. Of particular interest to researchers was a phenomenon detected earlier by the Vela satellites. Vela satellites were launched to detect atomic bomb tests, but they also detected intense gamma-ray bursts from space.

Gamma-ray bursters, as these intense sources are called, are associated with galaxies and are presumed to be caused by the collapse of a massive star into a black hole. If so, the gamma rays are emitted in two narrow cones from the poles of the collapsing

star. That means that the pole of the star must point directly at the earth in order for the gamma ray burst to be detected by the Compton satellite. The Burst and Transient Source Experiment (BATSE) group at NASA's Marshall Space Flight Center handles the reduction of the CGO burster data.

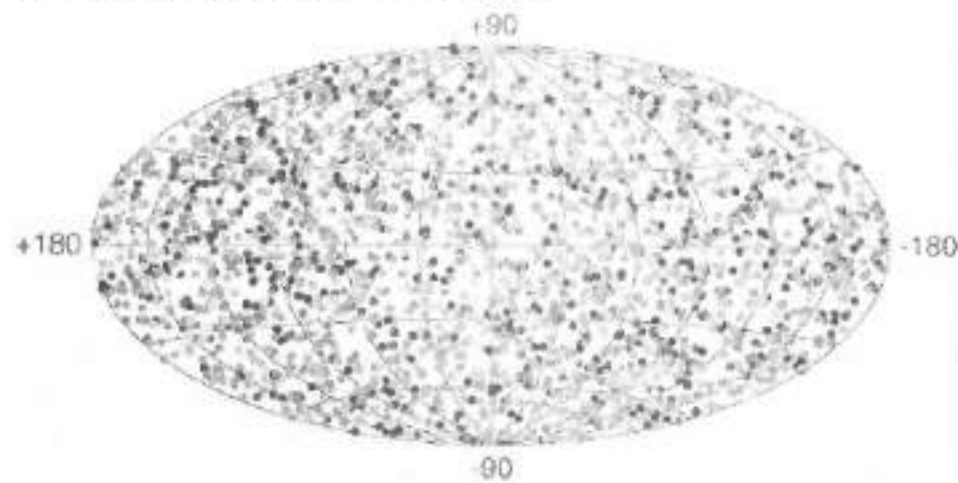

Figure 4: *Sky Map of Gamma-ray Bursters*

The above figure illustrates the locations of 2512 gamma-ray bursts detected by the BATSE instrument after more than eight years of observation by the CGO. Statistical tests confirm that the bursts are isotropically distributed on the sky. This means that they are scattered at random on the sky. Part of the original caption of Figure 4 says:

... [A] deficiency has been detected in the number of faint bursts, interpreted as an indication that the spatial extent of the burst distribution is limited and that BATSE sees the limit or edge of the distribution.

In other words, there are too few faint bursts. If gamma-ray bursters are uniformly distributed through all space we should detect them out as far as our instruments are capable; but they taper off long before we get to that limit. In other words, gamma-ray

bursters not only all point to the earth, but they are all located in a thick, spherical shell centered on the earth. Outside that shell there are few, if any, bursters; their distribution is geocentric. This interpretation has been confirmed in recent years by distance estimates for those bursters for which optical counterparts could be found.⁴²

Conclusion

When we put the phenomena mentioned in this chapter together, we discover that not one of them amounts to anything more than circumstantial evidence for geocentricity; but when taken as a whole, they point to a geocentric universe. True, from a cosmic perspective the Milky Way could just as well be viewed as located at the center of the cosmic shells we examined in this chapter; and the earth is not exactly at the center of the F-stars and G-stars, either. But that is where Scripture comes into play. Having the earth at the center of the universe is scriptural; having the Milky Way at the center of the universe is not. We thus conclude that these lesser evidences bear silent witness to the greater geocentric evidences, and to the veracity and absolute authority of the Bible—and that is the bottom line.

According to the standard model, the universe is isotropic, or much the same everywhere. The first sign that this might not be the case came in 2005, when Kate Land and João Magueijo of Imperial College London noticed a curious pattern in the map of the cosmic microwave background (CMB) created by NASA's WMAP satellite. It seemed to show that some hot and cold spots in the CMB are not distributed randomly, as expected, but are aligned along what Magueijo dubbed the axis of evil.

—Zeeya Merali¹

THE AXIS OF EVIL

There is some overlap among this chapter, Chapter 6 on the firmament, Chapter 7 on the dominion of the sun, and Chapter 35 on rotation. I did this because the content is crucial to the theory of geocentricity.

In 1948, cosmologist George Gamow predicted that the heat of the big bang should be detectable at microwave wavelengths as a uniform glow in the sky. No one could predict its temperature, but early researchers who looked to determine the correctness of his prediction found a glow in the sky that implied a temperature that ranged from a low of 5 K (read “five Kelvin” or “five K”) to a high of 28 K. The glow is variously called: “the cosmic background radiation,” the “3K background radiation,” or the “3-degree black-body radiation.” Most commonly now it is called the “cosmic microwave background” (CMB).

In 1965, Arno Penzias and Robert Wilson, then working at Bell Telephone Labs, built a thermometer sensitive to microwave wavelengths which they intended to convert into a radio telescope.

When they calibrated it, they discovered an excess temperature of 3.5 K for which they had no explanation. It didn't take long before they received a call from Crawford Hill of Princeton University informing them that the excess temperature could be Gamow's predicted leftover heat from the big bang. The "best" temperature measurement now stands at 2.725 K (-454.76°F or -270.42°C). In 1978 Penzias and Wilson received the Nobel Prize in Physics for their discovery.

Over the intervening years, astronomers have taken ever-closer looks at the CMB. Today, temperature measurements are made accurate to a few millionths of a degree. This has led to some interesting findings. Among those, the most perplexing to cosmologists is the organization of hot and cold regions, called *poles* of heaven. Within four ten-thousandths of a degree either side of the average CMB temperature, there are temperature features that have been detected. Some of these are on a cosmic scale. The most important of these are exhibited as coupled poles, that is, coupled hot and cold regions.

All About Poles

Although the cosmic three-degree background radiation is presented as proof for the big bang, the smoothness of that background radiation is inconsistent with the big bang theory.² According to the big bang, there should be hot and cold areas in the CMB radiation field; and, indeed, there are, but the temperature variations range only two ten-thousandths of a degree above and below the CMB average temperature. This temperature range is much smaller than expected from a big bang. The observed temperature range implies that the expansion of the universe, even in its inflationary stage, was very smooth (laminar), lacking the turbulence necessary to form stars, galaxies, and clusters of galaxies. Add to that the evidence against the evolutionary view the observed alignment of coupled temperature poles, and the evidence against the origin of the CMB becomes significant.

The coupled poles behave similarly to magnetic poles although poles can also be gravitational or electric in nature. An

electric pole is either positive or negative. An electron is negatively charged and is attracted by a positively charged proton, but the electron is repelled by any negatively charged particle such as another electron. Since neither an electron nor a proton has both positive and negative charges in them, each constitutes a monopole (see top of Figure 1). We are not here concerned with monopoles.

For most of us, when it comes to picturing a dipole it is easiest to consider a magnet. A magnet has two poles: one is called the *north pole* and the other is called the *south pole*. Like poles repel and unlike poles attract. Magnetism does not exist as a monopole; no matter how small the magnet, it always has a north and south pole.

If two magnets are placed end to end with like poles together in the middle, they form a quadrupole. (Placing them with unlike poles together just makes the resulting configuration a larger dipole.) There is another way to form a quadrupole and that is to lay the two magnets side by side with opposite poles up. Usually this is pictured as a square. In effect, the two magnets act as four magnets: two horizontal ones and two vertical ones.

Just as there are two ways to make a quadrupole, so there are two ways to make an octupole. The first one pictured in Figure 1 is to stand four magnets on end with alternate poles up, forming a cube,

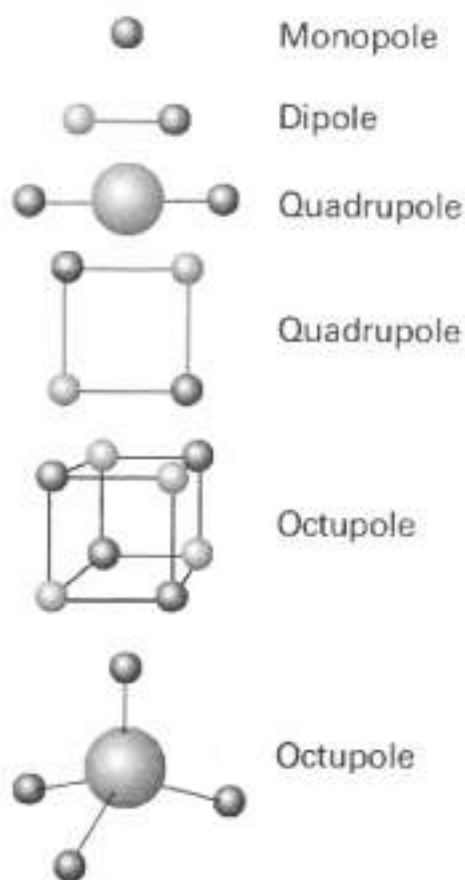

Figure 1: Polar Configurations.

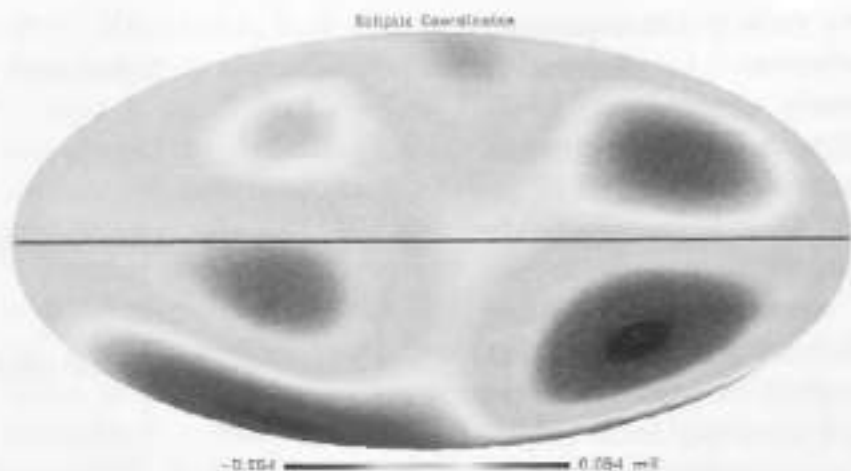

Figure 2: *The Axis of Evil.* The ecliptic is the equator of this figure. It also serves as the equator for the hot (red) and cold (blue) regions of the universe. Thus the ecliptic—the yearly path of the sun around the earth—is the axis of evil. (Courtesy, Max Tegmark)

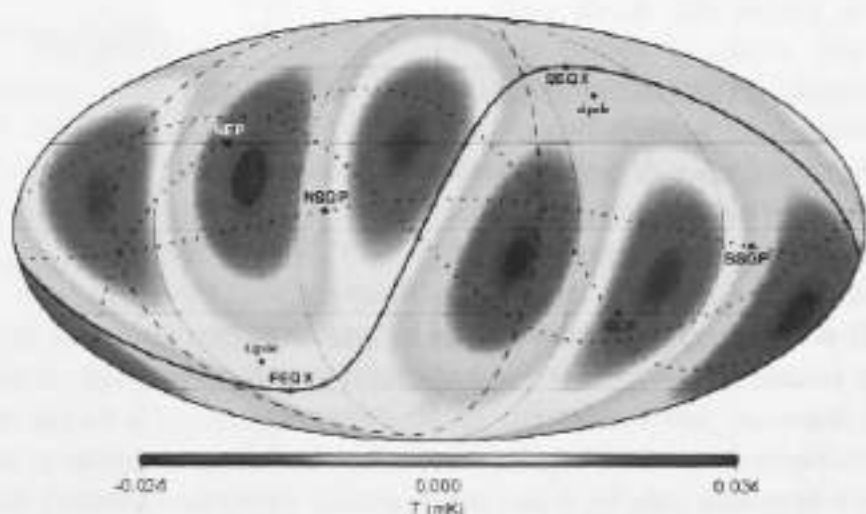

Figure 3: *The same map as shown in Figure 2 but now redrawn so that the plane of the Milky Way is the map's equator. The ecliptic is now shown as a solid line that curves under the red, blue, and red poles at left and then curves over the blue, red, and blue poles at right. The alignment is still there; it is just harder to perceive on this map.*

which has eight poles and forms twelve magnets, one for each edge. If, however, we put the four like poles of the four magnets together at the center than we have the second way to construct an octupole as shown at the bottom of Figure 1.

Gravitation, like electric charge, exists as a monopole, but unlike electric charges, there is only one gravitational pole and that is attraction. Electric configurations are maintained by motion; so, also, is gravitational attraction. In order to build a gravitational dipole you have two objects orbiting each other. Higher-order poles involve gravitational waves, which I shall not bother you with, dear reader.

The Axis of Evil Is Discovered

The axis of evil was discovered and named in 2005 by Kate Land and João Magueijo of Imperial College, London. At the time, I reported their discovery as a geocentric phenomenon that had recently been detected in the cosmic background radiation.³ Now, six years and two major confirmations later, the geocentric phenomenon is still a “problem” for atheistic and humanistic cosmologists. After all, Copernicus supposedly proved once and for all that the earth is not in a special place in the universe and that the Bible is obviously wrong because it places the earth in a special place. The ultimate evil to a humanist is that the Holy Bible is right and he is wrong; thus originated the term, *axis of evil*.

Figure 2 introduces us to the axis of evil. It shows the distribution of temperatures relative to the CMB and their gathering into poles. The poles are gravitational poles; in other words, they reflect slightly hotter, more energetic regions as red and cooler, less energetic regions as blue. The map plots both the quadrupoles and octupoles.

Now some readers may wonder why there are only six poles (three red and three blue) in Figure 2. Why not twelve poles: four from the quadrupole and eight from the octupole? The reason why is because the quadrupole and the octupole are aligned with each other, which strengthens the case for geocentricity in that it makes

of the earth an even more special place. The octupole is much weaker than the quadrupole and is only detectable if the quadrupole's temperature is subtracted from the observed temperature values.

The elliptical shape of the map represents the sphere of heaven. In this projection, the left half forms one hemisphere of the heavenly sphere and the right half forms the other hemisphere. Thus the thin red edge at the bottom right of Figure 2 is actually the continuation of the bottom of the large red area on the bottom left.

Note the temperature scale underneath the map. The hottest temperature is represented by the deep red color at right and is 0.054 mK (54 millionths of a degree Kelvin) above the average 2.725 K background temperature. The coldest area, represented at the left end of the bar by dark blue, is 54 millionths of a degree colder than the 2.725 K background temperature average which shows up as greenish on the map.

Each concentration of color (red or blue) forms a "pole." The hot poles are in red and the cold poles in blue. Furthermore, in the figure you can see that the red poles are connected by a yellow Y (centered on the constellation of Leo). Not so obvious is that the blue poles are similarly connected by a light-blue Y that runs along the top of the temperature map. Each hot (red) pole has a corresponding cold (blue) pole.

The solid line that forms the equator of the map is the *ecliptic*. The ecliptic is the path that the sun traces out each year against the starry background. The constellations that fall on the ecliptic and through which the sun passes each year form the zodiac, which constellations are the signs astrologers (not astronomers) swear by. The problem for humanist astronomers is that the alignment pictured in Figure 2 runs contrary to the Copernican principle's first commandment which says, "Thou shalt deny or belittle all evidence that confirms the earth's pivotal place in creation." Figure 2 is geocentric; it not only shows the earth in a special place, but it also shows that the universe is "aware" of the existence of the cir-

cuit of the sun of Psalm 19:6* (See Figure 5. Also see Chapter 7.). The equator of Figure 2 is the ecliptic; that is the line referred to by astronomers as "the axis of evil."

Figure 2 is difficult to find on the Internet these days. Figure 2 is just too obviously geocentric. Indeed, I reproduced it from my 2005 article. The one copy of Figure 2 that I did find on the Internet was too small to be useful; the one above dates from 2005 and is reproduced courtesy of cosmologist Max Tegmark of M.I.T. Today's "preferred" representation of the axis of evil plots the Milky Way's "equator" as the equator of the map (Figure 3).

In Figure 3, the axis of evil is shown as the solid black curve that starts on our galaxy's "equator" at left, curves down, then up and crosses the equator to the "north" in the center of the ellipse and then curves up and then down to the equator on the right side of the map. This does not provide nearly as impressive a support for geocentricity as does Figure 2. In addition, the temperature range is lower than that of Figure 2. Still, in Figure 3 it is easy to see the Ys I mentioned earlier that connect the poles, namely the yellow and light blue regions which now spring from the top and bottom of the map (except in this projection they look like an M and a W).

Note the FEQX at the bottom of the curve at left and the SEQX at the top right. The FEQX is located dead center of Figure 2 (see Figure 4) and the SEQX is located at both the left and right ends of the equator of Figure 2. (They are the same point in the sky since the equator represents the circumference of a circle.) Those are the equinoxes, the places where the sun crosses earth's equator. SEQX refers to the first day of spring when the sun crosses from south of the equator to north of the equator, and FEQX refers to the first day of fall when the sun moves back south of the equator.

* [The sun's] going forth *is* from the end of the heaven, and his circuit unto the ends of it: and there is nothing hid from the heat thereof.

In the blue area at central-left, the NEP refers to the north ecliptic pole which is the blue area at the top of Figure 2. In the lower red area at right you will see SEP which stands for south ecliptic pole (see Figure 4). Next, the NSGP and SSGP refer to the north and south poles of our supercluster of galaxies. A supercluster is a cluster consisting of smaller clusters of galaxies. The Local Supercluster is the one of which the Milky Way is a member.

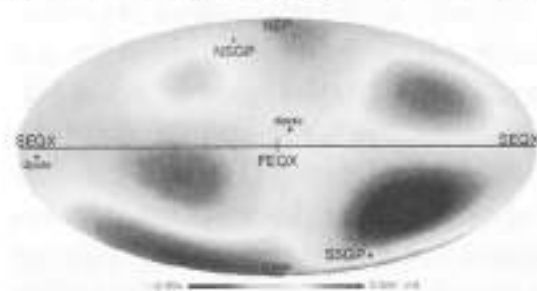

Figure 4: Same as Figure 2 but with the points in Figure 3 plotted on it.

The reason for adding all the positions of the ecliptic, galactic, and supergalactic north and south poles was to see if the position of the poles might turn

out to better correlate with the equators of those axes. If they did, the cosmological principle would partially be saved.

In Figure 3, the long dashed line passing through the leftmost red region marks the equator of the supercluster. The solid curve is the ecliptic—the zodiac—which passes through the equinoxes. Clearly, no better correlation exists than the geocentric correlation to the ecliptic shown in Figure 2.

Finally, there are two points, one near each of the two equinoxes, each labeled “dipole.” The classic explanation for the dipole is that it is due to the motion of the universe relative to the earth; we see this as the stars and galaxies, that is, space drifting by us. The dipole in the yellow (lower) region of the map is then due to space approaching us from a direction that lies near the constellation of Aquarius. The other point labeled “dipole” is near FEQX and marks the point to which space is receding from us. That dipole lies in the head of Leo. (Do not confuse the dipole motion with the cosmic redshift of the expanding universe theory; they are not the same).

In Figure 5, the helix (the barrel-shaped spiral, see Chapter 7) represents the path the sun traces out during the course of a year.

Each turn represents one day and the rotation is clockwise as seen from above (NP). The sun is here shown in the position it occupies on the first day of summer. The earth is the blue dot at the center. From it, the arrow labeled NP points to the North Star. The other arrow is perpendicular to the plane of the ellipse and is labeled NEP meaning that it points to the north ecliptic pole. It is also so marked in Figure 3 and is the very top of Figures 2 and 4. It takes the sun, moving counter-clockwise as seen from above on the axis NEP, one year to trace out the ellipse drawn on the surface of the barrel-shaped heliacal path. The sun's path also rotates daily as the sun traces its yearly path through the sky. If, in Figure 5, the barrel is rotated so the sun is placed at the top left of the barrel, the ecliptic would appear as a diagonal line extending to the bottom right of the barrel. That edge-on view of the ecliptic is the axis of evil. The existence of the axis of evil implies that the entire universe participates in the yearly motion of the sun about the earth or that the universe is at least aware of the sun's yearly path about the earth. Is it any wonder that atheists refer to it as the axis of evil?

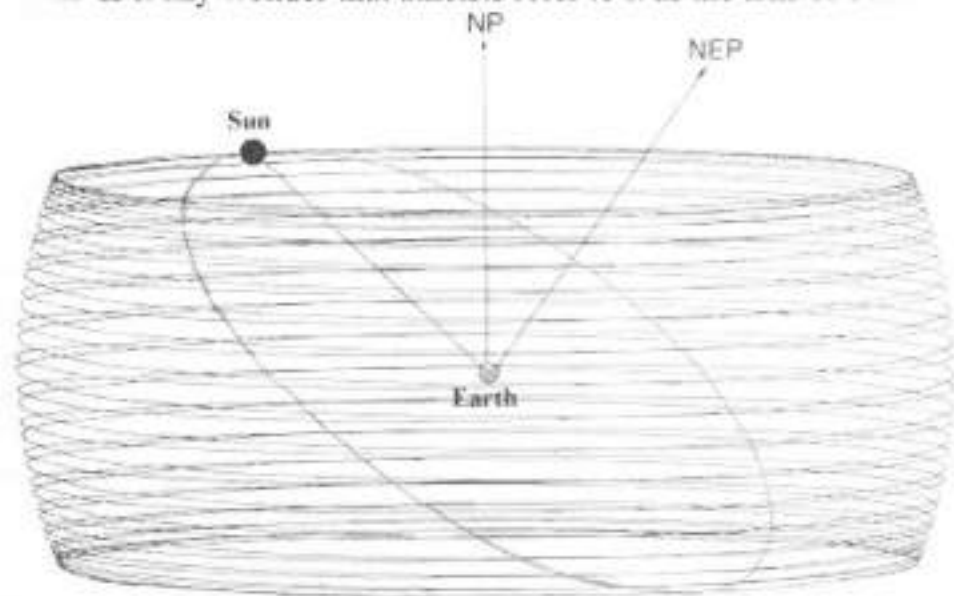

Figure 5: *The Circuit of the Sun* with the ecliptic, also known as the axis of evil.

The Sun's Circuit As a Wave

What we consider next is difficult to imagine, but not impossible. Fill a cup half-full of water. Now move the cup back and forth until you get a wave where one side is high in the cup while the opposite side is low. The wave sloshes back and forth and so does anything floating on the water. This corresponds to the ellipse in Figure 5.

Now here's the hard part, which you cannot actually do in a cup because it is too small, but you could do it in something like a rain barrel. Mount a camera over the center of the barrel (a cylinder also works and is easier to build) and affix it to the barrel's side so that the camera rotates with the barrel. Also, about halfway between the surface of the water and the bottom of the barrel affix a disk that can be bobbed up and down. If the barrel is not rotating, the bobbing disk will create the same kind of wave we generated in the cup in the previous paragraph.

Start rotating the barrel at about 2 turns per second and wait for all the water therein to rotate with the barrel (it may take hours). Then start the bobber and wait for the wave to develop (this, too, will take a long time). When the system stabilizes, the wave will no longer oscillate back and forth but will now rotate with the barrel but at a different rate. It is now called a "traveling wave" because its crest (top left at sun's location in Figure 5) travels counter-clockwise along the barrel's wall in the course of a year.

Sprinkle some powder or confetti on the surface of the water. Each piece of confetti will move up and down with the wave's crest and trough but now the Coriolis force (the outward force you feel when you whirl a stone tied to a string over your head) also carries each confetti piece in a circle when seen from above by the camera. Each piece of confetti traces out an identical circle in phase (i.e., if one piece of confetti is at the rightmost edge of its circle, then so is every other piece of confetti). Not only will the confetti move in a circle but its up and down motion caused by the

wave will force it to trace out a heliacal path like the sun's yearly path in Figure 5 when viewed from the outside of the barrel.

The confetti represents the sun, planets, and stars or even individual atoms and photons in the universe. Furthermore, the water represents the inertial or gravitational field of the firmament. The surface of the water represents a 2-dimensional slice of the universe just as the ellipse in Figure 5 represents a 2-dimensional slice that happens to include the path or orbit of the sun. We then see that all objects in the inverse not directly or gravitationally bound to the earth's local gravity field will follow identical circles at the same speed and in the same relative position.

The confetti represents the sun, planets and stars or even individual atoms and photons in the universe. Furthermore, the water represents the inertial or gravitational field of the firmament. The surface of the water represents a 2-dimensional slice of the universe just as the ellipse in Figure 5 represents a 2-dimensional slice that happens to include the path or orbit of the sun. We then see that all objects in the universe not directly or gravitationally tied to the earth's local gravity field will follow identical circles at the same speed and in the same relative position.

This model also accounts for aberration and the annual Doppler shift of stars. It does so because the light rays from the stars also participate in the yearly solar motion, sweeping them past the earth during the course of the year.

In the barrel illustration, the water represents the gravitational, also called the inertial field of the firmament. In the real world, the confetti is not just restricted to the surface but is sprinkled throughout the volume of space. Every particle in the universe follows the same path as the sun with the same period. The only difference is that it can have its own intrinsic motion, too. So two stars orbiting each other will both trace out the same 186-million-mile-diameter circle and so will their orbit trace out the same 186-million-mile circle. The motion is induced as a Coriolis force by the gravitational field of the firmament. Moreover, because the firmament is some 10^{123} times as massive as the universe, the universe follows the firmament-induced Coriolis and Centrifugal

forces' dictates. (The traveling wave is maintained by the centrifugal force of the firmament.)

Since the earth is located at the gravitational center of the firmament and on its axis of rotation, it will not sense the gravitational wave. The earth will see the sun go through its daily and yearly path as depicted in figure 5 and, insofar as the sun is concerned, it perceives the earth as if it were in orbit around the sun once a year. Furthermore, all experiments designed to measure the speed of the earth through space will measure a speed of zero, exactly as observed.*

There is one other phenomenon predicted by this model. If the earth is at the gravitational center of the firmament, earth's gravitational field, as opposed to any other body's gravitational field, coincides with the firmament's. As such, any force applied to either move the earth out of its central position or to change the length of the day will be opposed by the firmament which will perceive said imposed force as an attempt to change its position or rotation rate. By Newton's first law—for every action there is an equal and opposite reaction—the responding force, coming from an immovable object, will transfer the action of the force onto the universe. Since the maximum speed allowed by the firmament is the speed of light, that's the speed at which the change is communicated to the material of the universe. The universe does the moving in the opposite direction of what the earth would have moved had it not been at the core of the firmament's gravitational field. Remember, the firmament is at least 10^{123} times as massive as the universe.

Conclusion

So far, we have examined two observed phenomena in some detail. The first was the axis of evil, the scornful name given to an

* The experiments referred to are of three kinds: Arago's experiments with starlight and terrestrial light, Airy's experiments with aberration, and the Michelson-Morley family of experiments searching for the earth's motion through the ether (firmament).

alignment of three universal temperature irregularities, *viz.* the dipole, quadrupole, and octupole, in the cosmic background radiation with the earth's ecliptic. The second phenomenon is how the sun and every other particle in the universe not gravitationally tied to earth traces out an identical path in the sky, even the path the sun traces out in the course of the year which path we call the "ecliptic." It is, therefore, small wonder that the three poles should line up with the ecliptic. The axis of evil may be dismissed as an unfortunate coincidence and the quadrupole and octupole may be regarded as "local" (meaning caused by the solar system; although no realistic explanation has yet surfaced), but the fact remains that these follow logically from all experimentally-based, geocentric results.

The evidence suggests that the cosmic phenomena that reveal the axis of evil are a consequence of the yearly Coriolis force exerted by the effective daily rotation of the firmament. We examined the effect of that rotation on the sun from a geocentric perspective—that the entire universe will follow the solar motion as long as the center of gravity of the earth exactly coincides with the center of gravity of the firmament.

Finally, is the CMB unequivocally the remnant of the big bang or is there a geocentric alternative explanation? The answer is, "No" to the first, and "Yes" to the latter. The CMB can be explained as a resonance between shock waves in the firmament. These waves echo back and forth through the vacuum of atomic space with a frequency that equals the frequency of the CMB radiation. (Remember that the firmament is "omnipresent" throughout the vacuum of atomic space.) These resonating shock waves are capable of transferring heat to the universe at microwave frequencies which, depending on the assumed size of the universe, have a temperature signature, namely a black body, equivalent to the CMB's 2.725K.⁴

Generally it is highly advisable to keep in mind more than one possible explanation of observed phenomena until additional evidence of a different kind enables us to decide among them.

—Forest R. Moulton¹

38

MODERN GEOCENTRISTS

Modern geocentricity theory originated in 1967 with a modest tract written and distributed by Walter van der Kamp. The tract, entitled *The Heart of the Matter: An Approach to a Study in Scriptural Cosmology*, was initially sent to fifty people and institutions. At the time it seems that Walter was the only active promoter of the geocentric universe. For that reason, I shall, as best I can, present the modern geocentrists in the order that they first aligned themselves to Walter's stand; for the most part, I have followed the order in which they submitted articles to Walter's publication, *The Bulletin of the Tychonian Society*.

Walter van der Kamp (1913-1998)

Walter van der Kamp was born on 5 March 1913 in the Dutch city of Kampen. His Dutch name is spelled Wolter, but all his publications bear the name, Walter van der Kamp. The great depression of the 1930s marked him for life but he came out of it with the love of his life, Dierdre.

Walter lived dangerously during the Second World War. "Youthful foolery," is how he dismissed his heroic actions during that war later in life. When the Canadian army liberated Kampen, Walter served as their liaison officer. He was very impressed with the Canadians' courage and civility.

After the war, Walter became a successful public servant and a politician. But a restlessness plagued him; he was no longer at

home in the Netherlands; even his own denomination was going the way of apostasy. In 1955 he and his growing family moved to Canada where Walter had been offered the job of principal of a newly-founded Christian Independent school for a congregation of Dutch immigrants, including other dissidents from Kampen. Walter held that position at the William of Orange Christian School for twenty years.

For his first seven years in Canada, Walter worked to establish his kit and kin. That meant, among other things, mastering the art of teaching English at the William of Orange Christian School. Inevitably, Walter reentered public life and helped found the Federation of Independent School Associations. The minutes of the first exploratory meeting of the Federation of Independent Schools' representatives of British Columbia mention that the meeting:



Figure 1: *Walter van der Kamp*

... took place on October 17, 1964 at the invitation of Mr. E. R. Larsen, headmaster of Shawnigan Lake School, who was also chairman of the Independent Schools Association. ...Mr. W. van der Kamp of the William of Orange Christian School was one of a several people representing the Associate Member Group (AMG). He was also the first treasurer. ...[the

William of Orange Christian school was] then located in Burnaby, B.C.

Walter was also active within his denomination (Dutch Reformed) even as he had been in the Netherlands where he had compiled an innovative Concordance to the Scriptures. In Canada, Walter worked on the *Book of Praises* for the Canadian Reformed Churches.

Conservative Dutch Reformed churches do not sing hymns as you would find in most American churches. Their strict, Calvinist mindset only allows them to sing Psalms from the Bible. Although now widely accepted, it was a real break with tradition when in the nineteenth century the Dutch Reformed Church allowed rhymed Psalms instead of Psalms taken directly from the old *Staatenbijbel*, dating from 1619. But the Dutch Psalters were written in Dutch, not English; and since the children of Dutch immigrants to Canada could not be expected to teach Dutch to their children, it was decided that a translation of the Psalms from Dutch to English be undertaken.

Walter van der Kamp worked on that project, whose work was based on the Anglo-Genevan Psalter. To that end, Walter translated some 53 Psalms from Dutch into English. But still, Walter had not yet found the place where he belonged. There had to be something bigger out there.

In 1963, Walter joined Walter Lang's Bible-Science Association and the Creation Research Society. He immediately immersed himself in what he called the "how-to-understand-Genesis question," reading everything he could get his hands on. As he delved deeper and deeper into his study, he slowly became aware that there was an inconsistency in the creationists' treatment of the first chapter of Genesis. Walter expressed the inconsistency this way:

The creationists stoutly denounced worldly biological input with regard to the verses 11-13 and 20-31 of Genesis 1, but apparently no scruples impeded them from more or less reconciling the pronouncements of modern cosmogony and cosmol-

ogy with the matter-of-fact statements in Genesis 1:1-9 and 14-19. Yet, it dawned on me, when those theories are compared next to the plain text of Holy Writ, one cannot fail to see that they contradict God's Word as brazenly in the matter of His preparation of the Earth as post-Darwinian biology did with regard to the emergence of life on that same Earth. ... God spoke and they were there. Believe the message from on high or reject it.

Yet, to chop Genesis 1 in half, honoring the second part as real history, but the first as merely stressing and professing the omnipotence of the Creator of Heaven and Earth? This I could not do, nor did I dare. At the same time I almost despaired of following the tortuous rationalizations of exegetes who were trying to evade such a cavalier treatment of the text. Some of them I found to read the "made" of Genesis 1:16 as "made visible," for how could there have been light at the instant of God's *Fiat Lux*, they decided, if the Sun had not already been circling the Earth? The "stars also," others alleged, must have been there and were perhaps only on the fourth day equipped with light rays from four to ten billion light-years long. Furthermore, although the passage does not mention motion that must somehow be read into it, for Galileo established that the Earth races around the Sun at a speed, as we now know, of more than 100,000 km/hr.

Walter mulled this over for a while. He wanted to be certain he could answer his potential critics on scientific grounds or, at least, on philosophical grounds, an area in which Walter felt eminently at home. By the middle of 1967 Walter felt that it was time to test the waters. He sent the first draft of his defense of the geocentric universe to about fifty people and institutions, including the two most "fundamentalist" universities in the English-speaking world. Most ignored him, not even bothering to acknowledge receipt of his monograph. Several individuals, with varying degrees of politeness, recommended that he drop the matter. There were, however, four positive responses. One of those was Harold Arm-

strong, professor of Physics at Queen's University in Kingston, Ontario, Canada, of whom we shall say more anon.

January 1968 rolled around and Walter was ready to send out his monograph. His full version was called *The Heart of the Matter*. As Walter put it, "It went nowhere fast." Walter offered it at \$2.00 per copy, but few sales went to other than concerned family and friends.

Still, Walter felt that there were logical considerations that would not allow him to give up that easily. Walter was optimistic that logic would prevail.

Walter's second attempt was a paper that had been stenciled in 1968 but was not printed until 1970. It was entitled *Airy Reconsidered* and was reviewed as "thought provoking" by George Mulfinger of Bob Jones University, who, after admitting that a stationary earth would be a stumbling block for many, called Walter's monograph:

... recommended reading for anyone who enjoys exercising his mind and who is willing to rethink some of his long cherished beliefs about the universe in which he lives.²

Encouraged by Mulfinger's review, Walter formed a most informal and unincorporated organization called the Tychonian Society. With the Society came the *Bulletins of the Tychonian Society*. The first few issues were handwritten and reproduced on a Gestetner. Walter's subscription policy offered the *Bulletins* free of charge to all who requested them as long as there were enough freewill offerings to cover the cost of the next issue. About a year later, in 1971, Walter ran out of cash and burned most of an issue, calling it quits.

But Walter could not drop the matter. He continued reading and researching. Whenever it seemed that his geocentrism had died a quiet death, a letter would arrive from a distant place requesting more information. Even the occasional donation arrived.

After two years of that, Walter reluctantly gave the matter another try. This time the results were more gratifying. In the sum-

mer of 1974, *Bulletin* No. 6 came out. Typed and stenciled, it was sent to readers in Canada, the U.S., England, the Netherlands, Germany, Switzerland, and Australia. There could be no retiring from the battle for geocentricity this time. For every new issue the monies needed steadily arrived. Slowly but surely the number of people wanting the *Bulletin* kept increasing. More: people started contributing articles and openly promoting the *Bulletin*.

The first credentialed person to openly promote the Tychonian Society's cause was Professor James Hanson of the Cleveland State University. Prof. Hanson, then a Lutheran, wrangled an invitation for Walter to speak at the *Space and Astronomy Convention* organized by Lutheran pastor Walter Lang's Bible-Science Association and Campus Crusade for Christ International, held at Seattle Pacific College from August 17 through 19, 1975. Hanson also insisted that Walter sit on a panel discussion on astronomy along with John Read, an aerospace engineer at Northrup Corporation; also a geocentrist. The paper Walter presented was entitled, "I Make Its Pillars Firm," which was later published in the *Bible-Science Newsletter*.

Invitations to speak continued, mostly supplied by Walter Lang, the director of the Bible-Science Association and editor of the *Bible-Science Newsletter*. Of this, Walter van der Kamp tells us:

Delighted to be invited to read a paper in the Third National Bible-Science Conference in St. Paul, Minnesota, on August 15-18, 1976, I therefore included my suggestion to test the isotropy of space in the essay I had been asked to submit beforehand for the standard procedure of having the address available in print form during the actual lectures. To my dismay, the Program Chairman phoned me a week before the opening of the Conference and asked me to withdraw passages concerning the experiment, because according to him I was wrong in claiming it to be valid. Unable to refute him on the spot, I bowed to his suggestion to delete this contestable matter. During the conference, we agreed, we would talk things

over. This we did, with the result that I turned out to be right; and after I had presented my paper the Chairman told the audience the story of the misunderstanding, and presented the hearers with an outline of the page missing from the printed proceedings.

The test Walter wrote about was performed in 1982 when he, along with John Byl and Martin Sanderse performed it in a barn. Walter's account of the experiment was reported in 1982 in issue 34 of the *Bulletin* as well as his report on the early history of the Tychonian Society.³ The experiment failed to find the effect Walter was confident it would, but it was a significant enough experiment to be published in a refereed journal, the prestigious *American Journal of Physics*.⁴

Although Walter could see that the failure of the experiment implied a stronger form of geocentrism than he imagined, the failure took a lot of the wind out of his sails. In 1983 he turned 70 which, to him, was old. He felt he could no longer handle the *Bulletin*, which by that time had a life of its own. In 1984 Walter handed over the *Bulletin's* editorial duties to his friend, Gerry Bouw.

With the editorial load no longer on his shoulders, Walter had time to write, and he wrote several books, the longest of which is actually in Dutch and published in 1985 in the Netherlands. The book deals with the importance of having a *Houvast aan het hemelruim*, that is, a "Hold on the Heavens." In 1988, Walter published the final version of his booklet *De Labore Solis*,⁵ (The Labor of the Sun) in which Walter defends his small-universe model.

A few words need to be said about Walter's small universe model. Walter was convinced that aberration is the true parallax of the stars and that what is commonly called parallax is intrinsic to the stars that are confined to the outer 100 million miles or so of a 60-light-day-in-radius universe. Try though we might, neither John Byl nor I could convince Walter of his error. The main reason for this faith in the small universe was because he thought that

would make the stars small enough to fall to earth in Revelation 6:13 where it says:

And the stars of heaven fell unto the earth, even as a fig tree casteth her untimely figs, when she is shaken of a mighty wind.

Using interferometry we can measure the diameters of the stars, so it is a small thing to compute their diameters given their distance. Even at forty light-days away, however, many of the stars would be earth-sized or larger.

By 1990, Walter was disappointed by the direction I had taken the *Bulletin*. Walter wanted it to emphasize philosophy rather than science. He also objected to the infallibility of the English Scripture even though he had first printed in the *Bulletin* a paper endorsing the Chicago Statement on Inerrancy before handing the editorship over to yours truly. John Byl, too, wanted the focus of the *Bulletin* to remain philosophical. There was no editorial prohibition against philosophical articles; it was just that few readers were submitting them. Of those that were submitted, all were published. Truth is, I am not of the Reformed mindset, so I take Scripture's warning against philosophy more seriously than Walter's Reformed background would allow him (Colossians 2:8*).

By mutual agreement, it was decided that I would change the name of the *Bulletin of the Tychonian Society* to the *Biblical Astronomer*. The change took place with the first issue of 1991.

In 1992, Walter, and his wife, Dierdre moved to Victoria, British Columbia, on Vancouver Island to be near their children and grandchildren. About that same year, Walter published a 20-page pamphlet entitled *Einstein—Right or Wrong?* That was followed in 1993 with *The Cosmos, Einstein, and Truth*. In 1996, Walter printed his last book, *Evolution and Cosmogony*. Walter died on 26 January 1998 at 84 years of age.

* Colossians 2:8—Beware lest any man spoil you through philosophy and vain deceit, after the tradition of men, after the rudiments of the world, and not after Christ.

Prof. Harold Lewis Armstrong (1921-1985) B. S., M. S.

Harold Lewis Armstrong was born in Picton, Ontario, Canada, in 1921. In 1941, Harold joined the Canadian Army, serving in the United Kingdom, central Mediterranean, and continental Europe. While in the army, he took many of his high school classes by correspondence. He finished high school upon his discharge from the army.

After his high school graduation, Harold attended Queen's University, in Kingston, Ontario, where he graduated in 1950 with a Bachelor of Science in engineering and physics. As an undergraduate, Harold excelled in physics to the point that he was awarded the Medal in Physics as well as the Governor General's Medal of the Faculty of Applied Science.

Harold continued his studies at Queen's as a graduate student under the supervision of Prof. J. V. Hughes. In 1951 Harold completed his graduate work and was awarded his Master of Science degree.

While a graduate student, he met his wife, Barbara. The couple married in 1952 and had two daughters and a son.

In May, 1951, after finishing his Master's work, Harold left Queen's to work at the National Research Council in Ottawa. While there, he researched semiconductor devices and electronic circuits.

In March 1953, Harold left Ottawa to continue his research at the Clevite Brush Development Company in Cleveland, Ohio, and Pacific Semiconductors Co. in Culver City, California. Both daughters were born in Cleveland.

In September 1958, Harold returned to Kingston to teach physics at Queen's University. Not long after returning to the



Figure 2: *Harold L. Armstrong*

University, the couple's son was born. Harold taught at Queen's for the rest of his life.

In early 1985, while walking home from Queen's, Harold suffered a heart attack. He died shortly after, on February 14, at age of 63. Upon the occasion of Professor Armstrong's death, the Head of the Physics Department at Queen's wrote this of Harold's role as educator:

Over a period of three decades as a professor of physics he displayed devotion to his students and his discipline, constantly seeking improved ways to convey the ideas and methods of physics in his lectures and in the teaching laboratory.

His contribution to the literature of science covers a variety of fields. His early works report advances in electronic circuitry and investigations of semiconductor devices. He has posed and explained numerous physics conundrums. But his most substantial contributions are to the literature of physics pedagogy, a field he leaves richer through his many innovations in university and high school laboratory experiments, lecture demonstrations, and teaching methods.⁶

It was Harold's interest in conundrums—his interest in paradoxical, insoluble, or difficult problems—that most likely led him to be a creationist as well as a geocentrist. Creationist George Howe had this to say of Harold's faith:

But Harold Armstrong was more than researcher and teacher. He had profound faith in God as Creator and in the Bible as an inerrant record of origins. This faith, coupled with boundless energy, led him to become one of the most able defenders of scientifically-based special creationism.⁷

As a creationist, Professor Armstrong served as editor of the *Creation Research Society Quarterly* from 1974 to 1984. It was in his role of editor that I first came to know Harold. I joined the Creation Research Society in 1975 and immediately started writ-

ing articles of astronomical creationist interest. In one particular issue, Professor Armstrong wrote of the great differences that existed in the various opinions held by the Society's members. In his report, Harold mentioned that at least one member, Walter van der Kamp, was a young-earth creationist who also believed that the earth neither rotates on its axis nor orbits the sun. That statement inspired me to search the scriptures whether or not they were geocentric. The results of that study are presented in Appendix A and eventually led to the writing of this book.

When Walter van der Kamp sent out the first fifty copies of his seminal booklet, *The Heart of the Matter* in 1967, Harold was among the list of recipients. Walter recounts Harold's reply as follows:

[In 1967,] I had sent a first draft to about fifty people and institutions, among them the two most "fundamentalist" Universities on the American continent. The latter, and most other addressees, did not even acknowledge receipt. Only a few respondents more or less politely advised me to drop the in-their-eyes nonsensical matter. In fact, with only four noteworthy exceptions among personalities in Christian circles in general and Creationists in particular, my appeal fell everywhere on deaf ears. One of those four was the late Professor Harold L. Armstrong, a Founding Father of the Creation Research Society and for many years Editor of its *Quarterly*. He had been surprised, he wrote me, by my postulates; for he assumed that he was about the only one left to consider the possibility of a geocentric system of the world.⁸

We see, then, that Harold was already a geocentrist by 1967. To the unscientific mind this is bewildering, for every school child "knows" that the heliocentric system is a "proven fact." Yet here is an intelligent, professional physicist who denies that "proven fact." The problem is that the heliocentric system is a "proven fact" only in the minds of professional textbook writers who cannot afford to learn every subject they cover. It is therefore no

wonder that Harold mentioned Walter van der Kamp in his note on the diversity of creationist members of the Creation Research Society: Harold was already a geocentrist.

Harold Armstrong was the first physicist to focus on the mathematical physics of the geocentric system. His efforts were mainly devoted to the physics of light, the application of relativity, which he treated with suspicion. He tried to work out a form of celestial mechanics (mathematically describing the motion of astronomical bodies). His ability to broaden his scope from history and philosophy to the science of the geocentric model makes Harold one of the founders of geocentricity.

James Nolen Hanson, (1933-) B.S., M.S.

Jim Hanson was born in Cleveland, Ohio, on 13 November 1933. He attended Case Institute of Technology, now Case-Western Reserve University, receiving a B.S. in Mathematics in 1956 and an M.S. in Astronomy in 1962. During his student years Jim worked for the Case Department of Astronomy as well as for the



Figure 3: Sue and Jim Hanson in 2010

Operations Research Department. Summers were spent as a land surveyor.

In 1956, Jim was drafted into the U.S. Army. For the Army he worked on the U.S. Naval Observatory-Army Map Service Lunar Occultation program. Later, he was assigned to the NASA Harvard Astrophysical Observatory Satellite Tracking program in Peru. He was also on assignment in Ecuador where Jim worked for the New Mexico A&M State University Natural Earth Satellite program.

After serving two years in the Army, Jim returned to the American Gas Association Testing Laboratory. After that, he worked several months at the Geophysical Institute of Huancayo, Peru, where he researched the airglow of the upper atmosphere.

Starting in early 1960 Jim Hanson twice worked at the TRW Aerospace Laboratory (1960-1962, during which time he earned his M. S. degree, and 1964-1966 where he performed research on satellite attitude control and powered space flight orbits).

Between Jim's two stints at TRW, Jim returned to South America, this time to Chile, where he performed site surveys for the Mt. Wilson and Mt. Palomar Observatories of the Carnegie Institution of Washington, D.C. Accompanying him on that trip was his wife, Kathryn Suzanne Lega, or Sue for short. Jim and Sue were married on 13 January 1962.

In 1965, Jim joined the mathematics faculty of the just-formed Cleveland State University (formerly called Fenn College). Jim declined to get his Ph.D., which is normally required to attain a full professorship, but he earned that rank in his own right. Jim retired in 1993 after his first heart attack. In the course of his career, Jim contributed many papers to journals in the areas of optimization theory, statistics and probability, optics, orbit computation, symbolic programming, machine design, and flow mechanics.

In 1972 Jim came to know the Lord Jesus and started to write papers favoring biblical creationism and the perfection of the King James Version of the Bible.

Jim first became aware of geocentricity in about 1973 or 1974 when the *Bible-Science Newsletter* (published by Walter Lang)

contained a very brief paragraph about Walter van der Kamp who professed geocentricity based on Airy's Failure. Jim and Walter van der Kamp struck up a correspondence with Jim giving technical advice and expertise to Walter.

After several years of correspondence, Jim and Walter met at a Bible-Science Conference. Jim describes the meeting as follows:

Walter walks up, clicks his heels, and bows. Strange as that was, he compounds this by asking, "I gather from your name that you are Norwegian."

"Yes," was Jim's puzzled response.

Walter continued, "In my part of the Netherlands we have a prayer to keep you people away from us. We've prayed that for more than a thousand years."

Most people think that the Vikings were exclusively coastal raiders, but that is not true. The most profitable raids were those that sailed up the rivers of Europe. Walter's city, Kampen, is in the Rhine delta; thus Walter's strange but good-natured greeting.

Jim's geocentric focus has mainly been confined to history of the geocentric ideas and deriving usable, mathematical methods for computing strictly earth-centered motion and light propagation. It was Jim's influence, through Walter Lang, that punctuated Walter van der Kamp's talks with an authoritative exclamation mark: Walter acknowledged this in his history of the Tychonian Society article:

If Professor Hanson had not stood solidly by my side, a motion to throw me out of the meeting might well have been made and seconded: perhaps even carried! I still remember, however, how my promoter's no-nonsense, solid paper, thankfully following mine, authoritatively impressed on a clearly skeptical audience an important point: do not assume that on this topic Einstein has the last word! About a dozen new subscribers to the *Bulletin* also affirmed that Hanson's and my arguments had not been brought forward totally in vain.

In 1978 Jim and I hosted a very successful five-day geocentricity conference at the Cleveland State University. Half-hour papers were presented morning and afternoon. Even some people from the Massachusetts Institute of Technology attended, most notably, Huseyin Yilmaz, as did the dissident Bulgarian physicist, Stefan Marinov. Also present, and extremely outraged that the notion of geocentricity should be so well received, was a graduate student from Kent State University, who from that day on undertook a personal vendetta against Professor Hanson.

Hanson made pro-geocentric presentations in Texas, Oklahoma, Washington (state), California, Idaho, Minnesota, Wisconsin, Michigan, Alabama, Illinois, and Ohio. With the exception of a few articles in the 1970s *Creation Research Society Quarterly*, all Hanson's published geocentric works appeared in *The Biblical Astronomer* and its predecessor, *The Bulletin of the Tychoonian Society*. In 1979 George Mulfinger banned all geocentric articles and anything written by Professors Hanson and Bouw from the *Creation Research Society Quarterly*. Harold Armstrong resisted the ban for a while, but he could only hold out for so long.

Before joining Cleveland State, Jim worked a year at for Battelle Memorial Institute, a private nonprofit applied science and technology development company headquartered in Columbus, Ohio. His job was to translate technical papers from Russian into English. While there he saw several Russian papers that mentioned sightings of Noah's Ark on Mt. Ararat. Jim didn't think much of it at the time, but after his conversion he had a special interest in tracing those papers; but when he inquired about them at Battelle, he was told that they were missing; they had disappeared. When he related the story to me, Jim said, "That seems to be the rule for Ark sightings: the evidence eventually disappears."

Jim is a most talented mathematician. Among his accomplishments is a population analysis that shows that the population after the flood could number into the millions within a century from the disembarkation from the ark. Jim has also laid a firm, mathematical foundation for Le Sagean gravity, demonstrating that

shadowing of a flood of particles from all directions will cause two bodies to move together with an inverse-square law, thus validating that gravity could be LeSagean. Jim also discredited the proposed tippie-top explanation for Joshua's Long Day, where the earth tips over to temporarily put Joshua's battle site at the earth's rotational north pole. In 2005 Jim compiled his articles on the history and science of geocentricity into a book entitled *The Bible and Geocentricity*.⁹

Jim's view of the geocentric universe is that the earth is at the center of the universe, the geometric center. The earth acts as a gravitational sink for LeSagean particles, as well as light. Jim's belief is that light is ballistic which, as we saw in Chapter 6, is a perfectly reasonable assumption for the atomic universe. In the past few years, Jim has published his flow model of Le Sage's theory in the *Biblical Astronomer*. His papers include the flow of photons into astronomical bodies (sinks) emanating from stars (sources).

In 1986, Jim suffered a heart attack and in 1993 retired from teaching at the Cleveland State University. He was 59 at the time. He's been enjoying his retirement ever since, between medical contingencies, anyhow. He taught Sunday School at the Mantua Country Baptist Church in Ohio for twenty years where he also serves as the Sunday School Superintendent and the keeper of the copying machine.

Walter H. J. Lang (1913-2004)

Walter H. J. Lang was born in Omaha, Nebraska, on November 3, 1913. His father, Victor Lang, was a teacher in a Missouri Synod day school. Walter graduated from St. Paul's College, Concordia, Missouri, and in 1937, from Concordia Seminary, St. Louis, Missouri. He spent the next two years as assistant pastor at St. Philip's Lutheran Church in St. Louis, followed by a year teaching at a rural Christian school at Burkburnett, Texas. In 1940, Walter accepted a call to serve St. Paul's Lutheran Church in Denton, Texas. He left there in February of 1942 when he ac-

cepted a call from the Mission Board of the Texas District of the Lutheran Church-Missouri Synod to begin a mission church among the blacks of Houston. Several years later, that church started a Christian day school.

In September of 1950, Walter left Houston to accept a call to St. Paul's Lutheran Church in Winslow, Nebraska, the church his grandfather, Rev. John Lang, had founded 38 years earlier. In June of 1955, he left to accept a call to Mount Calvary Lutheran

Church in Denver. The church was located in an area with a transient population. When the Air Force Finance Center was relocated from St. Louis to Denver, to a location several blocks from Mount Calvary, some workers, many of whom were black, settled in the area. Within four years, Mount Calvary was fully integrated and a new building for its Christian day school had been finished. Also, a day care center was established.

In late spring of 1959, Walter Lang accepted a call to Grace Lutheran Church in Caldwell, Idaho. Two years later, Walter read John Whitcomb and Henry Morris' *The Genesis Flood*. The book planted the seed for what Walter would come to call "Creation Evangelism." In September 1963, Walter and his wife, Valeria started distributing the *Bible-Science Newsletter* from Grace Lutheran Church. Beginning on the church's mimeograph, it soon became a full-time job. Walter formed the Bible-Science Association (BSA) and resigned from Grace Lutheran in 1963 to assume the duties of executive director of the Association. The mailings



Figure 4: Walter Lang In 1991

quickly grew to 5000 copies per month, and book sales were added as requests came in for the books mentioned in the *Newsletter*.

In the fall of 1964, a Creation Seminar was held in Southern California. Speakers included the founding members of the Creation Research Society (CRS), which had split off from the American Scientific Affiliation (ASA) in June of 1963. Although originally founded in 1941 as an organization of scientists who accepted the recent creation, by 1960 the ASA had wandered far from that to blatant promotion of theistic evolution. In 1961, Whitcomb and Morris' seminal work, *The Genesis Flood*, became the rallying cause for young-earth creationists who accepted a literal interpretation of the early chapters of Genesis. These joined together to form the Creation Research Society (CRS).

At the 1964 conference, Walter Lang realized that the Bible Science Association's role should be to popularize the scientific work of CRS and to promote to the churches the six-day creation and the worldwide flood. This was crucial in preventing the drift into liberalism, as happened to the ASA, which reinterpreted Scripture to eventually reject even the Biblical doctrines of sin and salvation.

Next, the BSA began hosting large annual meetings with leading creation speakers. A daily devotional called *Five Minutes with the Bible and Science* was added to the *Bible-Science Newsletter*. On weekends, Walter would drive far and wide across Middle America giving creationist seminars at churches and civic centers. Walter never refused to go anywhere, even abroad. Because of its growth and because of the concentration of Lutheran workers, in 1978 the Bible Science Association moved to Minneapolis, which eventually led to the BSA's and Walter's downfall.

Walter Lang was the first to give Walter van der Kamp a venue to present his geocentric ideas: first, in Seattle at the urging of Prof. Jim Hanson in 1975 and then again in the Bible Science Association's Annual Meeting in 1976.

It was in the devotional, *Five Minutes with the Bible and Science*, that Walter first addressed the issue of geocentricity in print. Though a staunch defender of the Bible's insistence on a recent

six-day creation, Walter did not accept geocentricity. On the contrary, Walter argued that Job 38:12-14 provided scriptural evidence for a rotating earth. (Walter's rotating-seal argument is presented in Chapter 14, Alleged Heliocentric Verses.)

Walter attended the 1977 Conference on Absolutes held in Cleveland. There he discovered that top secular scientists, such as Huseyin Yilmaz, were quite able to accept geocentricity, and that its primary detractors were religionists and theistic evolutionists. This reinforced his desire to keep this dissident idea in the BSA fold.



Figure 5: George W. O'Keefe

Over the years, both the Hansons and the Bouws hosted Walter on multiple occasions. In 1983, the board of directors of the Bible-Science Association went against Walter's wishes and voted that the annual conferences were at an end. From that point on, it was decreed that conferences would only be scheduled for every second year. Walter had heard that the Northcoast Bible-Science Association of Cleveland wanted to host the next BSA conference and so recruited them to host a conference in 1984 at the Brookside Baptist

Church, pastored by George O'Keefe, a young-earth geocentrist. The following year, in 1985, the NCBSA also hosted the official Bible-Science Association conference. Today, only the quadrennial Pittsburgh Conference survives of Walter Lang's efforts to bring creationists together.

Wherever Walter would travel, he preferred to stay in people's homes. My children fondly remember his stay with us in 1991; Walter banging his suitcases against the walls as he climbed to the spare bedroom upstairs; no damage done. Whatever town he visited, Walter would call contacts on his BSA mailing list, looking

for speaking targets of opportunity. It was our pleasure to host Walter on at least three occasions during the 1980s and early 1990s. I was also a guest at the Lang's home in Minneapolis.

By the mid-eighties, Walter repudiated his interpretation of Job 38:12-14 and embraced the geocentric universe as scriptural; because of how he saw his role as promoter of creationism, he never made an issue of it. Nevertheless, he carried copies of geocentric books on his book-sales table. Walter was also present at the 1991 geocentricity conference held in the author's back yard, where the photo in this biographic sketch was taken (Figure 4).

Eventually the Bible-Science Association's change of leadership was complete when it changed its name to Creation Moments. Now out of the creationist loop, Pastor and Mrs. Lang founded the Genesis Institute and started a new publication, *The Ark Today*.

Since 1963, Walter made it a rule to exchange *The Bible-Science Newsletter* and *The Ark Today* with the periodicals of other organizations. This included *The Bulletin of the Tychonian Society* and, later, *The Biblical Astronomer*. Walter was also convinced that a large board of directors was advantageous for his organizations. Jim Hanson and I both served on the BSA board. But Walter's occasional inclusion and reports of geocentric news galled other board members and unbeknownst to Walter, they stopped the exchange of periodicals.

Walter continued supporting creationist causes, particularly those of the Twin Cities area; and in 1992 he helped organize the last BSA national conference on creationism in St. Paul, Minnesota. His work with BSA done, in 1997 he and Valeria moved to Seattle to be closer to their children. There Walter served on the board of Creation Association of Puget Sound. There, too, Valeria died in 1999.

Walter's health had been declining for the past couple of years. He was having problems with his short-term memory, yet he remained ever gracious, as was his nature. Over his last few months, his physical strength began to fail as well. At the last, he contracted pneumonia and passed away on 10 July 2004.

Though Walter had not been on the road for years, he was sorely missed. His dream to unite the various creationist groups died with him. The love of money makes sure that Walter's dream stays dead.

John Byl, (1949-), B.S., Ph.D.

Dr. John Byl was born in the Hague, in the Netherlands, in 1949. He is a Canadian citizen, married, and has six children.

John received his Bachelor of Science degree in Mathematics from the University of British Columbia in 1969, where he continued on, earning his doctorate in Astronomy in 1973.



Figure 6: *John Byl*

From 1973-1975 John took a post-doctoral fellowship at the University of British Columbia's Department of Geophysics & Astronomy in Vancouver, B.C. Canada. That position led to his appointment as lecturer from 1975-77. From there, John took a post as a Visiting Professor of Physics at Dordt College in Iowa from 1977-78. He is presently Professor Emeritus at Trinity Western University, Langley, BC, where he began

teaching in 1978, took over as chair of the department of Mathematical Sciences in 1980, and received his full professorship in 1985.

While an undergraduate at the University of British Columbia (UBC) in 1965, for a short time John carpoled to the University with Walter van der Kamp's son, Garth. In 1968 he heard Walter van der Kamp speak at the Calvin Study Club, a gathering for Christian students at UBC. John received copies of Walter's early papers but did not contact Walter until 1977. By that time Walter had retired and lived in Pitt Meadows, about twenty miles from Burnaby. From that time on until the van der Kamps moved to

Victoria (a four-hour ferry trip from Vancouver), John visited Walter and Dierdre every few months.

In 1977 John wrote his first article for the *Bulletin of the Tychonian Society*. Its title was "Science and Truth" and it appeared in issue 18 of the *Bulletin*. That was followed in the next issue by "Towards a Logic of Belief." Both papers dealt with interpretation, epistemology (how do we know that we know?), faith, and truth. In 1988 he critiqued my original firmament paper (*Bulletin* no. 47). That was the last article he wrote for the *Bulletin*. Articles that appeared in the *Biblical Astronomer* include "On the Relativity of Rotation," "God, Space, and Time," and Walter van der Kamp's obituary. His critiques and comments on articles have always been interesting and provocative. He also published hundreds of articles in general and scientific literature and two books: *God and Cosmos: A Christian View of Time, Space, and the Universe* and *The Divine Challenge: On Matter, Mind, Math, & Meaning*.

Dr. Byl's current research interests are in astronomy (celestial mechanics, cosmology), physics (special relativity), computing (cellular automata), mathematics (infinite tasks), and the sometimes-stormy relationship between science and religion. In recent years the focus of his research has shifted to philosophical and theological issues related to the foundations of mathematics, physics and cosmology. John champions an instrumental philosophy of science.

Dr. Byl is an elder in the Canadian Reformed Church. In 1999, he was awarded the Templeton Award for Science/Religion Course for his course *Math 480: Foundations in the Mathematical Sciences: Theological and Philosophical Issues*.

Richard G. Elmendorf (1927-), B.M.E.

Richard (Dick) Elmendorf received a Bachelor of Mechanical Engineering degree from Cornell University in 1950. Currently he is a Professional Engineer, practicing in Bairdford, Pennsylvania, where he owns a small business—Elmendorf, Inc.— which pro-

vides engineering, design, and fabrication services to industry in the Pittsburgh area.

Now semi-retired, Dick retains an active interest in both the creation-evolution (C/E) and geocentric-heliocentric (G/H) controversies. Indeed, Dick Elmendorf was one of Walter van der Kamp's earliest supporters. In 1978 Dick issued a \$5,000 challenge to anyone who could provide proof of evolution. In 1980, he challenged heliocentrists with \$1,000 (later increased to \$10,000) for proof-positive of the earth's motion. Both challenges remain unclaimed and have marked Elmendorf as an uncompromising opponent of conventional scientific wisdom where science conflicts with the Bible.

Elmendorf became a Christian a few years after graduation from college. It took many influences to penetrate what he describes as a "very thick skull"; but once he was convinced by God's Spirit that the Bible is true, Christianity "sunk in deep," as he puts it, and he has never had any reason to question his commitment to Jesus Christ or his confidence in God's word.

Dick has an idealistic, Don Quixote-like windmill tilting, square-peg-in-a-round-hole temperament, which further motivates his efforts in ideological conflicts such as the C/E and G/H controversies. An example of this is his tax case.



Figure 7: Richard G. Elmendorf in 1991.

For years Elmendorf has feuded with the public school districts in his area over the teaching of the religion of evolution. After various unsuccessful efforts to work cooperatively with the schools on the matter, in 1978 he started to withhold a portion of the school (property) tax. By that action he hoped to generate a meaningful court case to test the legality of such teaching. Dick believes he has a case because he can prove that evolution is an unscientific religion, and as such has no place in a tax-supported government school. In short, the "evolution tax" is an illegal tax and therefore unenforceable. He did this with no previous legal experience and represented himself *pro-se*, thinking that if the unenforceable law was followed, the school district would take steps to collect the taxes and he should have an opportunity to defend himself in a neutral arena against their collection.

Needless to say, the establishment is anything but neutral. To his "naïve surprise," the school filed the tax claims but did not pursue the next steps required under the applicable laws. Dick therefore initiated a procedure to force the action but was still unable to smoke the schools out into the open for a showdown on evolution. Dick fought it all the way to the Supreme Court which refused to hear the case. Elmendorf describes it thusly:

As you can imagine, I am not saving any money or time on all this do-it-yourself legal work. It finally got through my thick skull that the public schools are not about to expose their precious evolution religion to criticism if they can help it. So the cases have been stuck on legal dead-center, with the schools still holding the tax claims and the "tax rebel" still holding their tax money. Occasionally one of the schools tries a new tactic to ignore the existing case and collect by other means, but so far nothing has worked, and thirty years later the adversaries continue circling warily.

What this has boiled down to is that our hero (?) is confident that he has the law and the science on his side, but recognizes that the schools have the politics on their side, and the way the courts operate today, the name of the game is politics

and not law or science at all. Fortunately, my cases, if they ever happen at all, will require a *jury* trial and therefore the decision will be up to twelve of my fellow taxpayers and not up to a single judge who may or may not be prejudiced.* That's a significant advantage and may be the reason why the schools are afraid of a showdown.

Since 1984, Elmendorf has paid the school taxes and has demanded a refund for that portion of the taxes used to teach the religion of evolution. Dick has had neither the money nor the time to pursue this new legal tact. Dick concludes his tale of the trial:

In any way, the schools may yet win. They can wait until their windmill-tilting nemesis dies or tries to sell his property. And if his family or other heirs do not wish to continue the public schools in this way, the matter will be settled in the schools' favor.

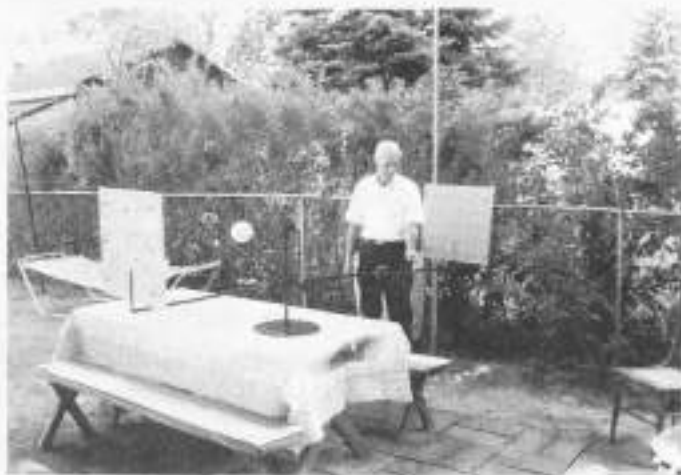

Figure 8: *Elmendorf and His Orrery.*

Like other geocentrists, including Hanson and Bouw, Elmendorf adamantly opposes any compromising approach to the public school curriculum issues such as the so-called two-model approach, equal time, scientific

* Technically, Elmendorf is correct, but the way judges get around it is they will tell the jury what verdict they should give based on the "law." Today, jurors do not know they don't have to take the judge's "orders" but are perfectly free to overturn an existing law that they consider a bad law.

fairness, intelligent design, or any other backdoor approach that tries to "sneak" creation into the public schools. We knew from the start they would fail because they are dishonest attempts at compromise. It is hard to win a war if you do not have the moral high ground, and these attempts to force creationism into the schools by legislation cannot win. The moral high ground is to demand that evolution be kicked out of the schools completely and that only the Biblical creation account be taught. That's why evolutionists win, they are up-front in their approach; they don't care a tinker's dam (yes, that is spelled correctly) about compromise and valuing others' beliefs.

In 1991 Dick Elmendorf attended an informal gathering of geocentrists in the Bouws' backyard. He brought along a geocentric orrery he had made. It was about 15 feet in diameter. Two sheets of blue plastic represented the stars. This was the first truly Tychonic orrery constructed, at least by a modern geocentrist.

Dick's steadfast stance to defend creationism and geocentricity from all challengers provided the Tychonian Society with its battle cry: "Onward, windmill tilters!"

Gerardus Dingeman Bouw, (1945-) B.S., M.S., M.C.I.S., Ph.D.

Born on 15 March during the famine in the Netherlands at the end of the German occupation in the Second World War, few neighbors and family members believed I would survive my first month. My dad had been taken to Germany for forced labor three months before, and no one knew if he was dead or alive. For that reason, my mother named me after him. It was August 1945 before my dad was able to work his way home via southern France. In the meantime, my grandfather's bakery provided us with bread, both for the table and to trade with farmers for milk which was what kept me alive until the peace was restored in the province of South Holland.

One wintry night, when I was three years old, my dad seated me on his bike, ready to get bread from my grandparents' bakery. As he mounted the bike in front of me, I had to look straight up

into the sky in order to avoid having his coat brush my face. That was the first time that I noticed the sky filled with a myriad of lights. As I looked up at them, I felt them draw me up to them. In fear of falling upwards, I grabbed my dad tightly about the waist just as we started riding. This experience set the stage for a life-long fascination with the stars.

A year or two later another life-changing event happened, this time in church. Now being in church was itself unusual, for children are not encouraged to attend adult church services in the Netherlands; but this was a special occasion for it was Christmas. Even, stranger, I was there with my aunt, not my mother. The only part of the service I recall is when the dominee spoke of the creation, reading from Genesis 1:1-2. The account intrigued me, and I asked my aunt "What does *infinite* mean?"

She replied, "Think of the largest number you can think of, and then add one more." I grasped that right away.

Next I asked, "What was there before the world?" "God," she replied.

"And what was there before God?" I asked.

"Nothing," was her exasperated reply. "God has always been. Besides, it is sacrilegious to ask such questions."

That last comment hit hard and puzzled me greatly. God knew that I asked the question because I really wanted to know, with no guile in my heart; how is that sacrilegious? I concluded that her statement made no sense and decided to ignore it. Little could I know how the Lord would answer those questions.

The Russian threat during the Berlin Air Lift caused my parents to relocate from the Netherlands to Canada. In the summer of 1952 we landed in Halifax.

In the fifth grade, in a two-room schoolhouse, I learned that one could actually get paid for studying the stars: that the field of study had a name, *astronomy*. I immediately organized an astronomy club at school and started teaching what I learned from reading books on astronomy. From that time on I knew what I wanted to be when I grew up. After eight years in Canada, we immigrated

to the United States, first to Torrance, California, and two years later to Rochester, New York.

And so it was that at age eighteen I entered the University of Rochester (U. of R.) as an astrophysics major with a minor in astronomy. During my studies at the U. of R. I became an atheist. After all, evolution and the Bible don't agree, regardless of what theistic evolutionists may say. Candidly, such compromisers convinced me that the Bible was wrong and science was right. After all, if science makes a proclamation (such as the earth is not at the center of the universe or that life came about through an evolutionary sequence) and years later some theologian comes along and by some mysterious manipulation of the meanings of the Bible's wordings agrees and concludes: "Aha, the Bible knew it all along," then what did the Bible have to contribute to human knowledge? The frontiers of knowledge obviously did not lie in the study of the Bible.

I graduated in 1967 with a B.S. in astrophysics. That fall I entered Case Western Reserve University for graduate studies in astronomy and a couple of years later got involved with the wrong crowd.

It was there that life interfered with my schoolwork and, more importantly, it interfered with my atheism. I discovered that science could not explain all phenomena. I also broadened my scientific interests tremendously, becoming a generalist.

In hindsight it was fortunate for me that by the time I finished my Doctorate, the government had decreed that the space program was *irrelevant* and that federal money was better spent on *relevant* programs such as the funding (*i.e.*, promotion) of poverty through welfare. The bottom line for me was that I was massively unemployed. I was awarded the Ph.D. degree in astronomy in 1973.

In April of 1973 I moved to Monterey, California, in the hope that the concentration of observatories in California would better my chances at a job in astronomy, but it was to no avail. I worked there in temporary jobs until the following spring. Tired of sin and disillusioned with man, in May of 1974 I happened upon a science fiction work by Robert Heinlein entitled *Time Enough for Love*.



Figure 9: *Gerard Bouw in 2005*

Before long I was frustrated in the reading; Heinlein was obviously trying to write a bible for our times but all his gems came from the Holy Bible. I never finished Heinlein as I decided to go directly to the source itself.

So I started a critical reading of the Bible, from cover to cover, searching for inconsistencies and any contradictions between an infinite God and the God of the Bible. For-

tunately, God was watching out for me in that the only Bible I owned was an Authorized Version, the only English Bible free of such contradictions. Any other version and I would have been left with no alternative but agnosticism.

Space and time do not permit me to detail all the spiritual struggles, nor of the comparisons of Old Testament scriptures with their fulfillments in the New Testament. Nor can I detail all the other changes in my life at that time. I returned to Rochester, New York, and there, on Sunday evening, January 26, 1975, the Lord enlightened my understanding so that I clearly saw salvation by grace, and I was born again. Oh, the joy that filled my soul; oh, the zeal for the Lord and for his righteousness!

When I'd started my Bible reading program, one of the first things I learned was that, not only was I to learn new things from the words of God, but I was also to forget the teachings of men. "What must I forget next?" was a question I asked over and over.

So it was that after my rebirth, I dedicated my life to the defense of the Bible from "science falsely so called" (I Timothy 6:20). To that end my life's verse is Ephesians 4:14—"That we henceforth be no more children, tossed to and fro, and carried

about with every wind of doctrine, by the sleight of men, and cunning craftiness, whereby they lie in wait to deceive."

At the time, I attended a Free Methodist Church in Rochester, and that March (1975), the Sunday school superintendent presented a little ditty to the children entitled *I Didn't Come From A Monkey, No, No*. Now it so happened that I had been working on a theistic evolutionary model in which the major phases of the Big Bang and evolution all happened within one day, with eons between the days. In all modesty, it was the best theistic evolutionary model I've ever seen, bar none. And now this man was going to tell *me* that evolution was not true? I snickered to myself: "Of course we didn't come from monkeys, everyone knows that we came from apes," and I resolved to correct him privately after Sunday school. Well, he had some tracts, specifically, one by Duane Gish entitled *Have You Been Brainwashed?* and I postponed correcting him until after reading it.

You know, I never did correct that Sunday school superintendent. I stood corrected instead. I abandoned my theistic evolutionary model for what it was: dead wrong. When I became an atheist it was because I recognized that evolution and the Bible don't mix. I'd forgotten that and was trying to "correct" the Bible to fit evolution, and not the other way around. True, I was trying to keep the corrections to an absolute minimum, but even so, I was trying to correct that which was perfect. And so it was that I became a Special Creationist (meaning that the universe is no more than 6,000 years old).

I joined the Creation Research Society and soon ran into some differences with them because many, though not all of the members of that learned society, are scientists first and Biblicists second. I had learned my second lesson, though. Science can never correct the Bible. Never twist the wording of Scripture to fit a pet theory. I still cannot go along with the two-model approach: that creationism and evolutionism should be taught side-by-side as theories. Again I asked the Lord: "What must I forget next?"

The Lord answered that prayer less than a year later. Early 1976, Professor Harold Armstrong, then editor of the *Creation Re-*

search Society Quarterly, wrote a note therein about the diversity of opinions and views in the Creationist movement. To illustrate the breadth of those views, he mentioned a Dutch-Canadian named Walter van der Kamp as an extreme case where a Creationist advocated the literality of Scripture to the point of a stationary earth.

Now as an undergraduate at the University of Rochester in Rochester, New York, I'd was taught enough of the theory of relativity to know that neither heliocentrism nor geocentricity could be proven or disproved, and so I fired off a letter to Walter asking, in effect, "which Scriptures?"

I'm afraid that Walter sent more philosophy than Scriptures, but he did mention Psalms 93:1 and 104:5. I judged them rather weak insofar as evidence for geocentricity goes, so I set forth on a three-week, six-days-per-week, sixteen-hours-per-day study to determine the truth of the matter insofar as the Bible was concerned. Because at the time I didn't know where the Scripture is to be found, I had to flounder around in the "original" Hebrew. At the end of the three weeks the best I could determine was that the Scriptures were "probably" geocentric. My analysis was printed in Walter's *Bulletins of the Tychonian Society*, issue No. 13, in 1976 (see Appendix A). Since then the Scriptural case has been greatly solidified. Again I prayed, "What must I forget next?"

While I considered the geocentric issue, I worked part time for a clothier selling men's wear. Arriving home one evening I walked to my parent's backyard where grew a cluster of trilliums. Knowing the rarity of the flower, I had talked my dad into postponing the mowing of that area until the plants stopped blooming. That had been his policy for four years and now they were out in all their glory. As I approached them I heard a voice saying, "It's nice that someone cares for these flowers."

Now, as there was no one with me, I knew it had to be the Lord, and since he is the Lord, he should be able to read my mind so I answered him in thought saying, "Lord, you could raise up others to care for them," but he reprimanded me orally saying, "You know that I don't work that way."

I walked over to the tulips that my dad had planted and thought something equally inane, "These are more your garden variety flowers." The voice told me to look at one particular tulip, in the back of the bed. I saw nothing special about it but obeyed the voice. As I looked in, my face encountered a wave of fear. There, in the midst of the flower was a small, winged insect. Somehow I knew it thought it had found a shelter for the night from predators.

That was the end of our conversation and I found it difficult to believe that the Lord had actually spoken to me. The next day, while I examined a tulip my parents had cut for a vase, I noticed a pattern in the flower. The pattern dealt with the relationship between the Lord and his Bride. I wrote it up and submitted it to the *Creation Research Society Quarterly* for publication. It was rejected because certain reviewers thought it might encourage pantheism. Walter Lang, however, did print it in *The Bible-Science Newsletter*. The paper is posted on the web.¹⁰

Now, back to what must I forget next? There was one more thing that the Lord would have me forget. In the summer of 1977 a fellow geocentrist, James Nolen Hanson, then Professor of Computer Science at the Cleveland State University in Cleveland, Ohio (C.S.U.), wrote Walter van der Kamp suggesting that if I were to contact Hanson, he might be able to get me a job teaching computer courses at the Cleveland State University. I wrote to Jim and he invited me to his home early that summer. During my visit, he introduced me to the chairmen of several departments at C.S.U. and Jim and I had hours of discussion in between. Our main disagreement lay in the area of the inerrancy of the King James Bible. Jim had the *quaint* notion that it is the inerrant, preserved word of God in English, if not in the world. Jim left me with one final question, "If the King James Bible is not the word of God, then where is it?" I had no answer to that one and after a few minutes thought, I was forced to the conclusion that the King James Bible is truly the inerrant, preserved word of God.

In August of 1977, Jim called me in Rochester and told me C.S.U. would extend me a one-year contract to teach FORTRAN, a computer language. I accepted and moved to Cleveland. Jim and I

immediately organized the first “geocentricity” conference which drew speakers from British Columbia to Bulgaria, and from the local schools to the Massachusetts Institute of Technology.

In Cleveland I attended Brookside Baptist Church, pastored by George O’Keefe. In 1979 I married Elisabeth, the pastor’s middle daughter, and we have two children, Benjamin (wife Rachel and son William) and Rachel (husband Jeremy).

Once I dismissed the erroneous humanist teachings, the Lord opened the door to a career to keep body and soul together. In 1980, I accepted a position in the Math and Astronomy department (subsequently renamed the Math and Computer Science department) at Baldwin Wallace University, then called Baldwin-Wallace College, in Berea, Ohio.

On the geocentric front, after eight years writing articles for *The Bulletin of the Tychonian Society*, Walter van der Kamp passed its editorship to me in 1984.

In 1985, after working on it since 1977, I published my first geocentric book, *With Every Wind of Doctrine*. The 500 copies sold out by offering it in the *Bulletin*, but mostly by word of mouth.

In 1991, differences in doctrine and style between Walter van der Kamp and me led to the renaming of *The Bulletin of the Tychonian Society* to *The Biblical Astronomer*. Issue number 55 was the first issue of the *Astronomer*.

The evidence for geocentricity kept increasing so that in 1992 I released a sequel to my first book. Entitled, *Geocentricity*, the book went through two printings before a major error was discovered. Rather than revise that section, I decided to revise the whole book. The major error was the claim that the universe needs to rotate once a day just to keep from being absorbed into the firmament. The problem was discovered when a critic, in an exchange at the “Bad Astronomer” web site, decided to check my math and discovered that I had accidentally copied an exponent with the wrong sign. I know how that happened, but that doesn’t change anything.

A year before the error was discovered, Gordon Bane asked me to provide a condensed version of *Geocentricity* that he could mail out to tens of thousands of churches. I did so and the result was *A Geocentricity Primer*. After a couple of years of inserting an erratum, I revised the erroneous sections of the book and that is the currently circulating version.

After my retirement from Baldwin Wallace in 2007, I started a complete remake of *Geocentricity*. Advances in understanding the geocentric physics have totally changed the physical arguments. The result is before your eyes.

Amnon Goldberg (1957-)

Amnon Goldberg was born in London, England, in 1957. From his studies at the London Hospital Medical College, at Talmudical college, and from the writings of Rabbi Avigdor Miller, the Lubavitcher Rebbe, Walter van der Kamp and Dr. Bouw, he became convinced of the scientific and Torah cases for young earth creationism and geocentricity. In 1990 he wrote an article "The Earth is Established, it Cannot be Moved" in the *Jewish Tribune*, which caused a considerable stir in the Orthodox Jewish world.

Amnon's writing resulted in the printing of hundreds of letters in the newspapers and journals around the world, advocating geocentricity and a young earth, as well as thousands of posts on scores of Internet forums. Among the latter, Amnon's efforts included raising numerous furors on the "Bad Astronomy Forum." Each time he'd be banned from the site. Eventually he was banned from the site for the last time by its owner, Phil Plait, when Plait caught on that each time Amnon was banned he would sign on as a new user and start the furor anew. Amnon resides in Safed, in Galilee, where, as he puts it, he "studies the (pro-geocentric) Kabbalah, and where, according to Jewish tradition, the Messiah will first make his appearance."^{*}

* At first that may appear nonsensical to Christian readers, but *study* carefully the story of Deborah and Barak in Judges chapters 4 and 5, particularly the Song of Deborah in the fifth chapter.

Bolton Davidheiser (1912-2007) B.S., Ph.D.

Every now and then we meet a man who is so upright in his deportment and so genteel of manner that the respect he inspired lives long after him. Dr. Bolton Davidheiser was such a man. On 16 August 2007 Dr. Bolton Davidheiser shed this mortal coil in exchange for life eternal. He was 95 years old at the time of his death. His testimony reads:

As a teenager I asked a Sunday school teacher, "Some people say Christ died for us. How could that be?" The Sunday school teacher did not know either, and although I went to church regularly, it was not until many years later that I first learned from a radio evangelist about the gospel of salvation by grace through the atonement made by Christ upon the cross. Then I heard it again from another evangelist. With this new understanding, I really believed and received Christ as my personal Savior.

But there was the evolution problem. I had a Ph.D. in zoology [from Johns Hopkins] and was certain the fossil record and other evidences showed evolution to be a fact. Evolution and the doctrine of salvation by grace through the atonement cannot both be true. If evolution is true, we are improved animals instead of sinners fallen from a perfect creation. Then there would be no need for the Redeemer.

Soon after that [at age 32—*gdb*], I was engaged in cancer research at the Johns Hopkins School of Hygiene and Public Health. Frequently I went into the stacks of the Welch Medical Library and read articles on evolution by the evolutionists. It did not take long for me to find evolution was not the certainty I had thought it was, and I became a creationist. The notes I took were the start of my book, *Evolution and Christian Faith*, which went through thirteen printings.

I became an early member of the modern creationist movement and was a speaker at all the conferences as well as in churches and schools and was also on radio and television.¹¹

Dr. Davidheiser is perhaps best known for his book, *Evolution and Christian Faith*, (1969). Other books written by him include *Science and the Bible* (1971), *To Be As God: The Goals of Modern Science* (1977), and *Creation, Time, and Dr. Hugh Ross* (1998). A second, expanded edition of the book against Hugh Ross, entitled, *Concerning the Ministry of Dr. Hugh Ross* was in preparation circa 2000 but apparently never made it into print. Your editor has a proof copy submitted by Dr. Davidheiser for critique. Over the following year or so, we corresponded about corrections and evaluations of the book.

I had the honor of meeting Bolton Davidheiser on 16 June 1996. He arranged for me to speak at the Baptist Community Bible Church on Alondra Boulevard in Norwalk, California, where he attended. I used to live not far from there, so it was like a homecoming for me. After the service, my wife, Beth, our children, our host, Frank Gauna, and I were to meet Dr. Davidheiser at an Arby's about a mile west of the church on Alondra Blvd. Dr. Davidheiser was 83 at the time and on a bicycle. After a reasonable wait, Bolton did not arrive so Frank drove back to the church to look for him along the way. Dr. Davidheiser was nowhere to be found. Providentially, Frank found him on the wrong street (Pioneer). We eventually did get to talk for a while over a milkshake. All too soon it was time to depart as it was getting dark.

As a creationist, Bolton Davidheiser taught at Biola University in La Mirada, the town he lived in the rest of his life. While at Arby's he spoke of his disappointment there, as the University went from a conservative, creationist-friendly school to a hostile, evolutionist, American Scientific Affiliation type institution. In 2002 he wrote the following to me in a letter:

I got a [Hugh] Ross letter recently stating that Kenneth Richard Samples is with him and is his vice president. Samples wrote anti-creationist books years ago and said that I preferred

working at Disneyland to college teaching.* Biola was going liberal and did not want me any more, but I had tenure, so I resigned and needed temporary employment.

In other words, the situation eventually became so bad that, in good conscience, Bolton could no longer teach at Biola so he resigned, and found temporary employment at Disneyland.

As an officer of the Creation Research Society in the 1960s, Dr. Davidheiser ran into another problem. As one of the four directors, he had to work with Seventh-Day Adventists, a sect he deemed heretical because they had a revealed authority in addition to Scripture, namely Ellen G. W. White whom Adventists view as a prophetess. As a result, he was forced out of that office although he was still allowed to publish in the *Creation Research Society Quarterly*.

In one of our last exchanges of letters, we wrote about using email and the Internet for communicating ideas:

How could anything of my writing get to the Internet? I don't even know how to read internet.

In the same letter, he wrote the following about the geocentric model of the universe:

If I were required to say whether I accept geocentricity, yes or no, I would say yes.

One of the pioneers of the modern Creationist movement, Dr. Davidheiser finally became a geocentrist. I shall miss his correspondence and his well-thought-out questions. Over the years he contributed to the geocentric cause by, for instance, his investigation into the NASA missing day story (see Chapter 8). Dr. Davidheiser exposed the story for the fiction it is.

* Ron Numbers thus errs when, in his book *The Creationists*, he attributes this statement to Dr. Davidheiser.

Philip Stott (1943-) B.S., M.S.

Philip Stott was born in England in 1943. After matriculating at Bridlington Grammar School, he studied at Manchester University, where he obtained a B.S. (with honors) and M. S. degrees in Civil Engineering. He lectured at universities in Nigeria and South Africa and carried out research in the analysis of geometrically non-linear structures. He shared the Henry Adams award for outstanding research in 1969.

While lecturing at the University of the Witwatersrand he studied Biology. After leaving Wits, he joined an engineering consulting firm as associate in charge of computing. His ongoing interest in all aspects of science led to studies in Mathematics and Astronomy with the University of South Africa, and later to four years of part-time research with the Applied Mathematics department of the University of the Orange Free State.

After many years as a firm atheist he was converted to Christianity in 1976. Following several years of studying the conflicting claims of secular science and Scripture, he actively entered the Creation/Evolution debate in 1989, while teaching Mathematics and Science at a mission station in Natal. He gave lectures on the science vs. Scripture controversy throughout South Africa and Namibia. In 1992 he was invited to address a conference in Russia and since then he has lectured, addressed conferences, and taken part in debates in Eastern and Western Europe, America, Canada and Southern Africa. Venues have included the European Centre for Nuclear Research (CERN), a UNESCO International Conference on the Teaching of Physics and the Russian Academy of Sciences.



Figure 10: Philip Stott

In May 1992 he gave a lecture on geocentricity to a group of Christians in Switzerland. In an email he mentioned this event as follows.

After a lecture on geocentricity in Switzerland to a group of Christian scientists (many of whom work at CERN), the physicists were so upset that some were actually in tears. Their biggest source of frustration was that they could not refute my lecture. Unbeknown to me they met afterwards and decided to send an audio tape of the lecture to Jean-Marie Mouseca, the physicist they considered the most competent to rebut it. He was in America at the time. On receipt of the tape he spent considerable time in the library checking my statements and looking for refutation. He found none, but found even more support for geocentricity than I had given. On my next lecture tour in Switzerland, Mouseca (who had returned to his post as research physicist with the French nuclear research establishment at Grenoble) drove hundreds of kilometres to meet me and thank me for opening his eyes. He told me that he has come to the conclusion there is only one reference source that he can trust, and that is the Bible.

Many have told me that accepting geocentricity has changed their attitude to the Scriptures, changed their lives and strengthened their faith.

The world, and many Christians, look upon me as an utter fool (I have been devoted a whole chapter of ridicule in a South African theological text-book). Is that my criterion? God is true though all men be liars. I would rather be a fool for the gospel than keep quiet about their lies for the sake of respectability.

On matters geocentric, Philip has been a geocentric supporter since at least 1991. He wrote two books on geocentricity. The most significant was *Vital Questions*, but his most popular was a simple booklet called *Earth Our Home*. As far as I know, both are out of print.

Philip's opus is a set of videos on Bible and Science topics such as the Flood, creationism, geocentricity, and astronomy. Two titles that are of geocentric significance are: *Problems in Astronomy* and *Where in the Universe Are We?* The latter deals with geocentricity whereas the former touches upon it but is more general including problems with the big bang and problems with the age of the universe.

In 1995 Philip and I, along with my son Ben, met when Philip and I presented separate papers at the Sixth European Creationist Congress in the Netherlands.

Philip Stott is married to Margaret (born Lloyd), has two children, Robert and Angela, and two grandchildren, Sean and Julie. He lives in Bloemfontein, the capital of the Free State, South Africa.

Russell Arndts (1935-2010), M.S., Ph.D.

Russell Arndts was born on 11 February 1935 to Melvin and Geneva (née Thompson) Arndts in Chicago, Illinois. Churchwise, he was raised a Baptist. Russ graduated from Bemidji High School in 1953 and from Bemidji State College in 1957. On 8 June of the same year, Russ married Betty J. Hurlbert in Bemidji, Minnesota. Russ earned a master's degree in chemistry from North Dakota State University in 1959.

In 1960 Russ took a job as professor of chemistry at St. Cloud State University where he served for 35 years before his retirement in 1999. Between 1964 and 1968, Russ took a leave of absence to earn his Doctorate, from Louisiana State University in 1968. In 1970, he was promoted to Full Professor at St. Cloud.

Upon his return from Louisiana State to St. Cloud in 1968, a number of students challenged him with the six-day creation account of Scripture and the evidence for it in science. Russ undertook the study of origins, which ultimately led him to become a Creationist. He became active in the Creationist movement and became president of the Bible-Science Association (now known as "Creation Moments"). Russ served on the board of the Bible-

Science Association until its dissociation from the late Walter Lang. After Walter's ouster from the BSA, Russ served on the board of Creation Moments until his death.

In the early 1980's, Dr. Arndts and fellow Creationist Bill Overn (who worked for Univac in the 1960s developing, among other things, fast memory devices and the first Mars lander) began investigating a theory that the elements produced by the decay of radioactive isotopes were not always the result of radioactive decay but could have been present already in rocks when they formed. They went on to establish a mixing model as an alternative to isochronal dating.* The result is so significant to Creationism that



Figure 11: *Russell Arndts.*

Arndts, Overn, and mathematician James Hanson were keynote speakers at the 1983 National Creation Conference held in the Twin Cities. After Dr. Arndts retired from teaching in 1999, he occupied himself with helping Christians understand the Creationist worldview.

Russell's more recent writings had to do with the big bang, relativity, and the reasoning process used by evolutionists to sustain their superstition. The following quote gives an example of the latter:

* Russ and Bill showed that neighboring crystals in lava can have radically different ages—hundreds of “millions” of years different. Arndts and Overn argued that ancient ages of rocks are illusions precipitated by the mixing of different isotopes in the source rocks. <http://www.tccsa.tc/articles/isochrons2.html>.

Any conclusion reached by the use of data must have a sound reasoning system. Any data can be alleged to “prove” anything if we are willing to accept faulty reasoning. Evolutionary theory in general and specifically fossil reasoning is weak. Often creationists jump to the defense of a position when challenged needlessly.

Russ used the same tack when considering relativity, something which occupied him in his last years.

It was his critical examination of Einstein’s theories of relativity that led Russ eventually to adopt the geocentric model. Of course, it helped that the model is taught in Scripture. From relativity, Russ learned that today’s acentric-heliocentric view has no observed scientific foundation. Russ summarized the results of his research in his book, *Geocentricity, Relativity, and the Big Bang*.

Russ participated in the Third International Conference on Absolutes, which was held in Houston from 16 through 18 June 2007. He presented a paper entitled, “Einstein’s Procedural Definitions and the Hafele and Keating experiment.” In his paper Russ used the same logical approach that he earlier brought to bear against the evolutionists. Unfortunately, Russ did not provide the committee with a copy of the paper so it was never posted in the Conference Proceedings.

It took Dr. Arndts quite a while to accept geocentricity as a Bible doctrine, but once he did, he took to it as a duck takes to water. In an email dated 27 April 2010, he wrote:

It occurs to me that whenever geocentricity is rejected, an infinite universe is proposed with no center and no edges. Of course, with Einstein’s relativity the same effect can be achieved with a finite universe.

That is quite profound and entirely correct.

Politically, Russ was a conservative and was active in supporting conservative causes. All these activities went into his mentorship of students of all ages, especially those interested in theologi-

cal and philosophical issues, not to forget his mentoring his grandchildren.

For years, Russ suffered from lupus, an autoimmune disorder in which the body's immune system fights against one or more of the body's organs. In Russ' case, it was the lungs.

After a visit with doctors to discuss a planned heart operation to wean him from an oxygen tank, Russ quipped on May 10, 2010 that: "on the way out I met my heart doctor. He seemed willing to talk. He made it abundantly clear the lung doctor thinks I have a good chance of waking up where everyone ISN'T A GEOCENTRIC YOUNG EARTHER. While all of us will someday be where everyone is a geocentric young earther, I don't mind putting it off for a bit."

The heart surgery was performed in St. Cloud Hospital on 25 May 2010 and went smoothly. What followed, however, was a series of setbacks, surgeries, and recoveries, all documented by his wife, Betty, in a series of emails sent to people "in the loop." She said it best when she wrote: "After each surgery he worked at recovery then was hit with another complication. He was a wonderful patient and the nurses loved him." He died 23 July 2010 with his family gathered at his bedside. Russell is survived by his wife, Betty, as well as daughters, sons-in-law, and grandchildren: Sharon (Richard) Hobbs and children Jordan and Kenna; Linda Brix and children, Rachel, Paul, and David (Anna); Beth (Steve) Prater and children Andrew, Joel, Isaac, and Renae. At the time of his death, Russ was an active member of his church and a committed believer who lived out his faith in Jesus Christ.

Martin Guenther Selbrede (1956-)

Martin Guenther Selbrede (pronounced sel-BRED-ee) was born in 1956 in southern California. Martin is an autodidact who also happened to be a National Merit Scholar in 1974 after a string of city and state science fair wins. That year he represented California at the National Junior Science and humanities Symposium. The research for that project entailed immersion in the world of

acclaimed general relativity theorists at CalTech in Pasadena, California, particularly, Kip Thorne. While there, Martin studied Wheeler's *Spacetime Physics* and read the galley proofs of Misner, Wheeler & Thorne's massive tome, *Gravitation*. In addition, Martin spent two years at Harvey Mudd College in Claremont, California.

A voracious reader, Martin never stopped learning physics, although he didn't reenter technical fields until 1985 with CXTX Systems, Inc., developing a patent for a space-saving angular computer bus system. A subsequent patent in the flat panel display field led to his affiliation with Ticom Technologies, Inc. in the early 1990s, and finally to Unipixel Displays, Inc., for which Martin served as Chief Scientist and is credited with several dozen US



Figure 12: Martin Selbrede

and international patents in optical physics. Parallel with his interests in the physical sciences was his association with The Chalcedon Foundation (which *Newsweek* identified as a "rightwing Christian think tank") beginning in 1980. By 2003, Martin became the Vice President of The Chalcedon Foundation.

Martin's exposure to geocentricity dates to 1982 when Chalcedon's scholarly journal, *The Journal of Christian Reconstruction*, included an essay by Richard Green that mentioned the *Bulletin of the Tychoonian Society*. Skeptical but curious to see how well the geocentric case could be made, Martin subscribed, and within three years had become a compelling advocate for the minority view.

Martin anchors his presentations and arguments in his broad knowledge of the secular scientific literature when addressing ob-

jections launched from that quarter by skeptics (contending with them upon their own principles and appeals to authority), although he officially endorses the apologetic position of Cornelius Van Til (which inherently undercuts the epistemological “certainty” of autonomous rationalism).

Menachem Mendel Schneerson (1902-1994)

Menachem Schneerson is more commonly known as the Lubavitcher Rebbe. He was born in Mykolaiv, Ukraine, and became a prominent Hasidic rabbi. In particular, he joined the Chabad-Lubavitch movement and became the seventh and last Rebbe (Hasidic leader) of that movement. Many of his followers expected him soon to be crowned as the Messiah who was to restore Israel. He worked tirelessly to promote the movement’s goals among Jews around the world. The Lubavitcher movement is estimated to have 200,000 members.

Schneerson died on 12 June 1994 as the result of a stroke. On 2 November 1994, the U.S. Congress awarded him the Congressional Gold Medal, but he was never crowned Messiah. Some of his followers claim that the rabbi did not die but is still physically present, as in a secret place. Most of his disciples believe that if the Jews will acknowledge the Rebbe as the Messiah that he will be resurrected and will be crowned Messiah and restore the kingdom to Israel. Occasionally, the latter believers will take out a full-page advertisement in the *New York Times* encouraging Jews to recognize R. Schneerson as the Messiah.

The following exchange was communicated to me in 2007 by a correspondent. I’ve reprinted it in full here.*

* Source: http://www.chabad.org/therebbe/article_cdo/aid/73253/jewish/The-Wager.htm.

In the summer of 1975, an encounter took place between Rabbi F.R., a Lubavitcher chassid, and Mr. A.P., a “modernized”

American Jew. Rabbi R. was seeking to influence Mr. P. toward a greater commitment to Torah (the Pentateuch, —*gdb*) observance, which the latter dismissed as “archaic” and dismally outdated. In the course of the conversation, Mr. P. said, “Are you telling me that every



Figure 13: Rabbi Schneerson.

law and practice mentioned in the Torah, written thousands of years ago, must be accepted at face value today?”

“Certainly,” replied Rabbi R. “The Torah is eternal, and is equally pertinent to every day and age.”

“The Torah states that the sun revolves around the earth,” countered Mr. P. “Do you believe that as well?”

“Yes, I do,” replied Rabbi R.

“Well, you might believe that,” said Mr. P., “but no rational, self-respecting inhabitant of the 20th century does. I’m sure your rebbe, Rabbi Schneerson, doesn’t!”

“I’m sure he does,” said the rabbi.

“I’m willing to wager anything that he does not,” said Mr. P. “In fact, I’ll say this: If the Rebbe states that he believes that the sun revolves around the earth, I will become a Torah-observant Jew and convince everyone I know to do the same!”

"Would you put that in writing?" challenged Rabbi R.

"No problem," said Mr. P.

Soon after, Rabbi R. received the following letter:

Dear Rabbi R_____

As per our conversation of today,... I did say to you, and am submitting the same in writing by means of this letter, that if the Rebbe would make a public statement to the effect that... since the Talmud states that the sun revolves around the earth, it is therefore *his* firm belief that the sun does indeed revolve around the earth, that I will:

- (a) personally observe the laws of *taharat hamishpachah*, *tefillin* and Shabbat; and
- (b) influence my friends and colleagues to do the same.

It is, however, more than obvious to me that the Rebbe will not, in any way, make such a ridiculous statement, because

- (a) he does not wish to be labeled as a fool,
- (b) he himself is not as foolish as some of his ardent but hypnotized followers.

I predict, with no hesitation, that I will not hear any more about this matter from you or from the Rebbe...

I must tell you that I feel a deep personal hurt when people such as you make such asinine, ridiculous statements and then hide your abysmal ignorance behind the facade of "Torah." Don't you realize you can still be believers and not live 500 years behind the times?

Mr. P. received not one but two separate letters in reply from the Rebbe, plus a third, cover letter, which read as follows:

Greetings and blessings!

Your letter, addressed to Rabbi F_____ R_____, reached me ... In view of its content, I naturally take this first opportunity of replying to it.

Not knowing whether you are more interested in the practical implication, or/and in the scientific aspect, I am writing two separate replies, enclosed herewith, which you can read in the order you prefer.

With esteem and blessing,
M. Schneerson

P.S. It is surely unnecessary to add—though I am adding it for the record—that I take for granted that you will keep your commitments with regard to the practical aspects of your letter.

One letter read:

... In reply to your question relating to the matter of the motion of the sun and the earth, whether the sun revolves around the earth or the earth around the sun. It is my firm belief that the sun revolves around the earth, as I have also declared publicly on various occasions and in discussion with professors specializing in this field of science.

In view of the above, I have no objection, of course, if you wish to make this view known to whomever you choose...

The other letter read:

... This is in reply to your inquiry on the question of the rotation of the sun and the earth in relation to each other, namely, whether the sun revolves around the earth, or the earth around the sun, and which view is to be accepted, etc.

I presume you have in mind the scientific view, i.e., what science has to say on this question, and I will address myself to this aspect.

It is well known that this was a controversial issue in ancient and medieval science. However, since about half a century ago, with the introduction of the theory of relativity, the latter has been *universally* accepted as the basis of modern science...

One of the conclusions of the theory of relativity is that when there are two systems, or planets, in motion relative to each other—such as the sun and the earth in our case—either view, namely the sun rotating around the earth, or the earth rotating around the sun, has equal validity. Thus, if there are phenomena that cannot be adequately explained on the basis of one of these views, such difficulties have their counterpart also if the opposite view is accepted.

Secondly, the scientific conclusion that both views have equal validity is the result not of any inadequacy of available scientific data, or of technological development (measuring instruments, etc.), in which case it could be expected that further scientific or technological advancement might clear up the matter eventually and decide in favor of one or the other view. On the contrary, the conclusion of contemporary science is that regardless of any future scientific advancement, the question as to which is our planetary center, the sun or the earth, must forever remain unresolved, since both view[s] will always have the same scientific validity, as stated.

Thirdly, it follows that anyone declaring that a person who chooses to accept one of these systems in preference to the other is a fool, while one who accepts the other is a wise man—such a judgment shows that the person making it is ignorant of the conclusions of modern science, or that he has not advanced beyond the science of Ptolemy and Copernicus...

A further point might be added, though perhaps not pertinent to our discussion. It is that every person, including modern scientists, actually has three options to choose from in this matter:

- (a) that A revolves around B,
- (b) that B revolves around A,
- (c) that A and B revolve around each other.

But such a choice cannot be dictated by science; it would be one's personal choice and belief.

What has been said above is—to repeat—the deduction of the theory of relativity, as it is expounded in various scientific texts, and it can be checked with any scientist who is thoroughly familiar with the said theory. Of course, on the elementary and high-school level, science in general, and the so-called Solar System in particular, is taught from relatively simple textbooks, and the change in the scientific attitude towards the subject under discussion is not emphasized. But, as stated, it would be quite simple to verify it with any scientist who knows this particular field.

Thus we come to the end of the Lubavitcher Rebbe's defense of geocentricity.

Malcolm Bowden, (1931-) C.E., M.I.C.E., M.I.S.E.

Malcolm Bowden was born 10 May 1931 in London, England. He resided in Rotherhithe Road, near Surrey Docks. Effectively bombed out during the 7 September 1940 blitz on Thames, all the large Bowden family of uncles and aunts settled in West Chislehurst on the southeastern edge of London. Malcolm wrote this biography for his family and has agreed to allow me to reprint it here.

Because Malcolm lived in a very closely-knit family, he was very fearful of doing his two years National Service (military). Eventually he was called up in 1956 and finished with a commission. Having been so fearful of National Service he actually found that it was one of the best events that happened to him, for it matured him and gave him the confidence he had lacked. It was a strong lesson not to be fearful of whatever life might bring to you. This was reinforced when he later became a Christian and realised that all life is part of God's plan for each individual.

Malcolm trained as a Civil Engineer, eventually finishing with memberships of both Civil and Structural Engineers. For a while he worked for a large company but in 1974 started his own practice as a Consulting Engineer dealing mainly with building structures. Currently he is semi-retired with his wife, Jean, three children and

eight grandchildren. He attends Coldharbour Evangelical Free Church.

Being of a philosophical bent, Malcolm felt that there had to be something more to life than just living it. He made enquiries of the Christian Scientists Movement, but realised that this was too shallow. At the time, he was posted to RAF teaching basic radio to trainee radar servicemen. The base had Anglican and Roman Catholic Padres but he never felt attracted to their churches because of their strong emphasis on ritual. The Methodist chaplain played tennis and he and Malcolm represented their unit against other units. Naturally, in 1956 he joined the Methodist Church.



Figure 14: *Malcolm Bowden*

Malcolm married Jean in 1957. The couple settled in Bromley and in 1958 joined a liberal Methodist Church there where he, his wife, their two daughters, and one son were very happy until Malcolm's "most crushing day": 13 September 1971.

At the time, Malcolm engaged in various interests, one of which was watching the political movements of the day. Convinced that successive governments were slowly removing the national freedoms, he called a meeting in London of a few friends who were prominent in various "christian" and social-concern organisations. Malcolm wanted to start a movement that would scrutinise the promises and records of the various political parties and then recommend the best. The others listened patiently and the consensus was "OK. You start it up, and if it works we will join you."

It was the comments of the Secretary of an environmental society that were to shatter Malcolm's tidy liberal worldview. The Secretary merely mentioned that all these plans for the near future

were irrelevant as the world was going to run out of oil in 30 years time! Bowden asked him where he obtained his information and was told the Petroleum Institute. It did not take much imagination to realise that civilisation would undergo a radical change with this event, so he was asked, "What should we do?"

The Secretary replied, "Recycle everything."

Now Bowden, unlike the naïve environmentalists, knew enough chemistry to realise that it would take a huge amount of energy to return many products to their natural state, and he put this to the Secretary.

"Well," the Secretary replied, "we will have to return to renewable sources like wood, leather, stone, etc."

Soon the meeting closed and Bowden drove back the 30-minute journey to his home. It was during this drive home that Malcolm thought about what he had heard and realised that the fight for dwindling oil resources would herald international chaos and wars. Indeed, he knew enough of the Bible to realise that Armageddon could take place within his lifetime. This prospect shattered his peaceful conventional view of life. (It was many years later that Malcolm learned that oil explorers ensure that they have "discovered" enough oil reserves to last for 30 years ahead and that it had nothing to do with the actual amount of oil still left in the ground.)

All the way home, Malcolm's increasing worry drew him to a very unusual experience. He insists that it was definitely not a vision but a picture that formed within his mind. In his mind he saw a white robed man, about a mile tall and to whom Bowden felt about the size of an ant, looking straight ahead as if looking into the distant future. The giant in Bowden's mind spoke some reassuring words, which Malcolm reiterates were not audible except within his mind. He said, "Do not worry; everything is under my control and everything is going according to my plan." Then the mental picture faded and Bowden arrived home. Parking his car, he came into the house where his wife asked, "How did you get on?" Thereupon Malcolm burst into tears. Jean, who was very disconcerted by his response, asked, "What is the matter?"

Malcolm replied, "I am not weeping for myself; I am weeping for the world." Such was the picture of the future chaos that he foresaw!

Bowden realised that something very deep and spiritual had happened to him although he had no idea what it was. It was as if the central prop in his "conceptual framework"—his personal worldview—had been stripped away, and his whole view of life had collapsed. He was so distraught that for three months he could not read a serious book because he had no "framework" it could fit into. Such was his spiritual turmoil that he did not even know what questions to ask.

Bowden began to read a pocket New Testament to fill the void. He knew instinctively that this would ultimately provide the true pathway to follow.

Through his reading, Malcolm came to realise that his liberal Methodist Church was clueless to explain what had happened to him. He knew that it involved God in a very big way but that was about all he knew. The best his Methodist minister could say to him was, "Malcolm, you are intoxicated with the numinous!"

Malcolm knew what intoxicated meant, but had to look up what numinous meant, "The combined feeling of attraction and awe characteristic of man's sense of communion with God and religion." This was precisely what had happened to him and he still retains that picture of a towering God over all, which picture is as vivid now as when he experienced it. Yet it was only some thirty years later that he realised that the clothed figure was probably not that of God the Father but of Christ.

Thus in a complete spiritual wilderness, Bowden searched for enlightenment. One day he saw a Pentecostal congregation coming out of their service. They looked so happy and cheerful that he wondered whether they might be able to help him discover what had happened to him. He knew that they did unusual things like speaking in tongues, which repelled him then, and still does, so in going to their church for the first time, he remembers vividly how he literally had to force one foot in front of the other, so determined was he to find the answers to his predicament; come what

may. For two and a quarter years, he went there many Sunday evenings but learned nothing. However, in hindsight his time there stood him in good stead when he could see why God had given him this experience of the Pentecostal (and Charismatic) movement.

About 1969, Bowden gave a lecture on creation at his own Methodist Church. There he met Dr. David Gower, a creationist whose spiritual sincerity impressed him and they struck up a friendship. Asked which church Dr. Gower attended, he said it was a small Evangelical Free Church on Coldharbour Estate, about four miles away.

About the same time, a very inspiring young visiting Christian, Roger Weil, who impressed Malcolm and his wife with his knowledge and sincerity, led some Methodist Bible studies. Asked where Weil worshipped he said, "A small church on Coldharbour Estate."

With two very impressive Christians attending the same church, Malcolm felt that he must investigate it. Thus he walked into the church in January 1974; the same month that he formed his own engineering consultancy. He was immediately struck by the preaching straight from the Bible, the sincere warmth of the congregation, and the general atmosphere that God was present.

Upon his return home, Malcolm's wife, who was also looking for a deeper spiritual life asked him, "What was it like?"

"Terrific," came the reply.

"I'm coming too," Jean echoed. So they began to learn what Christian life is really all about. Apart from a break of a few years, they are still in membership there.

While still at the Methodist Church, on Sunday mornings Malcolm led the senior Sunday school class that was attended by several bright Dulwich College boys. About 1969 one of them stated that evolution is a fact. Now as a teenager Malcolm read voraciously any book that took his interest. One of them was *Is Evolution Proved?* in which an evolutionist (Shelton) and a creationist (Dewar) discussed all the main topics of their differing views. On finishing the book, it was obvious that evolution had little or no

scientific support and Malcolm forgot the subject for some twenty three years until it was raised in his Sunday school.

Bowden proposed a debate and looked for evidence but had great difficulty in finding any creationist organisation. Eventually he was put in touch with the Evolution Protest Movement, now called the Creation Science Movement. It was formed in 1932 and is the oldest creation organisation in the world. Malcolm still serves on its Council and Trustees Board.

As the creation evidence began to flow in, Malcolm quickly realised that evolution is the scientific fraud of the century and wanted to publicise the fact. He gave a talk at Dulwich College which went very well. This encouraged him to hire his own Methodist hall and put up a poster. The night before the talk, he became so worried that he literally shook with fear in his bed. Overcoming this fear, he gave his talk and has since never feared speaking in public. He was asked by his Minister to announce that this talk was nothing to do with the Methodist Church. It was at this lecture he met Dr. David Gower as mentioned above. He began speaking at schools and churches about evolution and creation.

Strangely, although Malcolm was convinced by the sudden appearance of complex animals in the fossil record that the Genesis Flood was accurate; as a liberal Methodist, he did not believe that the whole Bible was accurate. This is the opposite for many people, who are brought up to believe the Bible; but when they get to school and university they accept the evolutionist's propaganda and reject Genesis. Consequently, Malcolm's interest in creation had very little to do with his eventual conversion. It was reading the words "...the self-authenticating nature of the Bible" in a commentary that finally convinced Bowden that the *whole* of the Bible was reliable, accurate and true.

One day Malcolm was contacted by a very intelligent and well-informed Roman Catholic who had written several very interesting papers that he sent to Malcolm, asking him to put some of them into a readable book form. Amongst them were very controversial articles about Finance, the One World Order, Politics, Rela-

tivity, Einstein, etc. One paper was about geocentricity which, at that time, Bowden felt was so unlikely that he dismissed it.

Several years later, a correspondent again broached the subject of geocentricity. This time, interest was kindled. He obtained Bouw's books and realised that, just like the theory of evolution, heliocentrism was only supported by mass media propaganda and little else. It was Bouw's books that convinced him that the scientific evidence supported geocentricity and Barbour and Bertotti's article "Gravity and Inertia in a Machian Framework," explained so many puzzling matters on the subject.

Now convinced of the scientific support for geocentricity, Malcolm ventured to publicise this in creationist forums, where he thought the evidence that supported the Bible would be welcomed. To his surprise, he was met with ridicule and anger. Bowden was accused of "bringing the creationist movement into disrepute." He was not allowed to raise the subject in either the American creationist forums (from which he resigned sometime afterwards) or in the British email forum. He was also not allowed to write about the subject for the Creation Science Movement, even though his pamphlets on the decrease in the speed of light had created great interest amongst the membership and at meetings.

It became very obvious that the hostility was not due to any inadequacies in the scientific evidence, but the fear of ridicule from friends and colleagues: whether Christian, secular or Creationist. Peer pressure is as powerful in the Christian world as it is in the secular, and editors of Christian journals and magazines are fearful of losing readership should they print anything that referred to such a controversial subject. It seems to Malcolm that when prestige and the search for truth are in conflict, it is invariably the latter that takes second place.

Bowden has long since lost all fear of ridicule from anyone. This gives him a huge sense of freedom to publicise what he has researched on any subject. He feels free to promote his own opinions and research conclusions, independent of the huge propaganda machine of the mass media.

Because of how hostile creationists are to geocentricity, Bowden has not (as yet) given a full lecture on the subject, but would willingly do so if requested by interested people. However, he does have a large and wide ranging website¹² covering four main subjects, mostly very controversial, namely: Creation, True Biblical Counselling, Essays, and Charismatics. Regarding counselling, he co-authored a book entitled *Breakdowns are Good for You*, in which he proposes that there is no such thing as *non-organic* mental illness; that the root of people's problems is pride, and that counselling should be returned to the Church and to a Biblical foundation. Also on his web site, Malcolm has links to 22 animated videos on YouTube on a wide range of subjects of which eight explain geocentricity.

Malcolm Bowden has also written four books on creation: *Ape-men: Fact or Fallacy*, *The Rise of the Evolution Fraud*, *Science vs. Evolution*, and *True Science Agrees with the Bible*. His prayer is that he will have many more years to serve his Master in whatever way he is called to do.

David Lifschultz (1945-)

David Lifschultz was born on 23 November 1945. In 1899 his grandfather started Lifschultz Fast Freight, a trucking company that came to dominate the New York City to Chicago route. Its reputation for speedy delivery is noted in the 1932 movie, *Taxi*, where James Cagney's character, Matt Nolen, says to an impatient underling, "Who do you think I am, Lifschultz Fast Freight?"

David's father started his career on the back of a truck and then went to the University of Illinois to be-



Figure 15: David Lifschultz

come an industrial engineer. Thereafter, he entered Harvard Business School. He came to work for the family trucking business which was restricted to the eastern central region, that is, between the Midwest and the northeastern United States, and expanded it into the first integrated transportation system with air and surface transportation around the world. In addition, he had a brokerage on the west coast clearing the documents for Toyota imports, Mitsui, Itochu and others.

Like his dad, David, also started on the back of the truck, loading trailers and boxcars and performing all jobs. David elaborates on his early career:

I was for much of my career in the family business an operating executive, and was assigned to all the tough problems to turn around. During the deregulation rate wars at the end of the 1980s Lifschultz Fast Freight, the flagship company, suffered from anti-trust predation practiced by three large companies [Consolidated Freightways, Roadway Services, and Yellow Freight Systems, which for 22 years conspired with Jimmy Hoffa's Teamsters union to sop up the once highly fragmented commercial trucking industry for themselves—*gdb*,¹³]. I introduced the plan, which my father approved and supported, of saving the then 90-year old company by launching the largest anti-trust action in trucking history for 1.7 billion dollars, combining it with a publicly traded company which owned a technology company called Hart Scientific, and proceeding to prosecute the trucking anti-trust case and turn around the technology company that was losing money.

The antitrust suit was joined by two allies, Donald Trump and Judge Robert Bork. Several years earlier, in 1987, President Reagan had nominated Bork for Associate Justice of the Supreme Court. Liberal and moderates' opposition to Bork's rightful insistence that the U.S. Constitution allows judges only to adjudicate and not "legislate from the bench," was so slanderous and vicious that it introduced a new word into the American English language:

bork, meaning to have one's character assassinated; to be irreversibly damaged. Trump and Bork were investors in the antitrust lawsuit.

David Lifschultz explains:

Included in the legal action were unnamed Teamster Officials representing organized crime. It achieved widespread fame and my picture was on the front page of C-Section in the Wall St. Journal and in Fortune.... It so impressed Judge Robert Bork, an enemy of most economic style anti-trust actions, that he came aboard with the famous trial lawyer of Claus von Bulow fame on a contingency basis. Though we lost the case, the company prospered. An analyst asked why the Department of Justice did not intervene, which I asked them to, but the anti-trust head was afraid to, as she did not bargain on fighting organized crime when she came to Washington.

During the lawsuit, there were three attempts upon David's life. One attempt involved the removal of the rear, driver's-side rear wheel's lug nuts. When the wheel flew off the car, traffic was light and David was going slowly enough to control the vehicle. In similar manner the Lord protected David from the other attempts on his life.

It took ten years of hard work to rebuild Lifschultz Industries and eventually the publicly traded company, which started at 75 cents per share, was sold for \$22.80 per share.

With the proceeds, David bought controlling interest in Genoil, a Canadian oil company based originally in Edmonton and now with branches in New York City, Abu Dhabi, and Dubai. Genoil has technologies that sterilize ballast tanks of large ships, provide clean drinking water for the world's communities, and can separate oil and water thus cleaning oil spills better than the entrenched technology. Then, too, it can profitably separate oil from sands and shale. Since 2000, David has worked to make Genoil a leading company in the oil industry.

A direct descendent from Aaron, and coming from an Orthodox background, David is a Kairite. Kairites hold that only the Pentateuch is inspired Scripture; the rest, they regard as historic. Kairites are spiritually descended from the Sadducees, although David does believe in the resurrection as taught in Exodus 3:6.*

David rejects the Talmud. He believes that the exiled Jews should work for the good of the city and country into which they are exiled. This is taught in Jeremiah 29:7,[†] but the Talmud teaches the opposite. Thus almost all persecution of Jews is due to Talmudic Jews. The Nazis left the Kairites alone once this observance was revealed to them.

David was an early advocate for geocentricity and has written several articles published in the *Biblical Astronomer*. David also regards the Authorized Version as by far the best translation of the Hebrew text into English.

Marshall R. Hall, Jr., (1930-) B.S., M.A.

Marshall Hall was born on 9 August 1930 in Charleston, West Virginia. As an atheist and leftist humanist, he believed in the theory of evolution: a must for Marxists. For seven years he studied at various schools, including Baldwin-Wallace College (now Baldwin Wallace University) where he majored in history, followed by fellowships to the State University of New York at Stony Brook and the University of Denver. He finally ended up in the Ph.D. program at the Center for Advanced International Studies at the University of Miami, Coral Gables. Along the way he married his first wife, Sandra and started raising a family.

In the course of his studies, Marshall discovered one unbridgeable gap after another in evolutionary theory. He became a creationist. In 1973, while still at the University of Miami, Mar-

* Exodus 3:6—Moreover [God] said, I am the God of thy father, the God of Abraham, the God of Isaac, and the God of Jacob. ...

† Jeremiah 29:7—And seek the peace of the city whither I have caused you to be carried away captives, and pray unto the LORD for it: for in the peace thereof shall ye have peace.

documents the satanic influence on Kepler, starting from his youth on. Marshall was one of the first to suspect that Kepler may have murdered his mentor, Tycho Brahe. Of Marshall's web site, *fixedearth.com*, he says:

Since going online in '97 with an in-depth domain focused on Biblical and scientific Geocentrism, prayer-led studies have confirmed how the purely assumption-based Copernican Model has historically provided the keystone of today's science-controlling Big Bang Evolutionary Paradigm. This, in turn, has led to facts which reveal the Kabbalist sources responsible for every concept which make up that Evolutionary Paradigm.

Hall's approach has not been without controversy. In February of 2007 he and Bonnie persuaded Georgia state Representative Ben Bridges, a creationist, to introduce house bill HB179. The bill noted that whereas creationism is kicked out of the courts because it is supposedly based on a "religious" book,* evolution is based on a Jewish religious book, the Cabala (also spelled Kabbala). The bill had an attachment taken from Marshall's web site. The attachment, which is a commentary on the bill, actually does prove Marshall's point if his quotes from the Cabala are correct, and I have no reason to suspect that they are not correct.¹⁶

The evolutionists, particularly the Jewish evolutionists reacted immediately, making what was a state issue into a national issue. On the *haaretz.com* web site, an AP article was published:

Group seeks apology for memo linking evolution theory to Kabbalah

By The Associated Press

A Jewish organization is demanding an apology from a Georgia lawmaker after a memo using his name claims that evolution was a

* Actually, the Bible is a history book; to call it a religious book is a gross misrepresentation. It tells us we cannot get to heaven by religion.

myth propagated by an ancient Jewish sect. The Anti-Defamation League, an organization that battles anti-Semitism, sent a letter to state Representative Ben Bridges on Thursday chastising him for writing the highly offensive memo, which attributes the Big Bang theory to writings in the Kabbalah, a Jewish text.

Bridges has denied writing the memo, although one of his closest political allies, Marshall Hall, said the legislator gave him the approval to draft it. The memo asks readers to challenge the evolution monopoly in the schools by logging onto Hall's anti-evolution Web site, www.fixedearth.com. Hall, a 76-year-old former high school teacher whose wife ran Bridges' election campaign, said neither the site nor the memo is anti-Semitic. "I think they tar people with that brush a little too readily," he said.

The Jewish group, however, is unconvinced and asked Bridges to immediately apologize. "Your memo conjures up repugnant images of Judaism used for thousands of years to smear the Jewish people as cult-like and manipulative," wrote Bill Nigut, the league's southeast regional director.

"Indisputable evidence — long hidden but now available to everyone — demonstrates conclusively that so-called 'secular evolution science' is the Big Bang, 15-billion-year, alternate 'creation scenario' of the Pharisee Religion," the memo said. "This scenario is derived concept-for-concept from Rabbinic writings in the mystic 'holy book' Kabbala dating back at least two millennia."

Bridges has long opposed the teaching of evolution in Georgia classrooms and has introduced legislation requiring only that scientific fact be taught in school.

The main drawback with Marshall Hall's conspiratorial approach is that, from his supporting documentation it is at times impossible to tell where one authority leaves off and another begins. Then, too, not all Jews are Cabalists.

When it comes to Scripture, Marshall suffers from conspiracy overload, a phenomenon where conspiracies are invoked to explain why the clear statement of Scripture should not be taken literally. For instance, the thousand years in Revelation 20 should not be

taken literally. Hall sees II Peter 3:8* as a warning not to take it literally; but the context is not the same. Peter is referring to our reckoning of time, that is our definition of a long time, versus God's perception of time. Revelation is specifying a specific amount of time. If II Peter 3:8 is a warning not to take the thousand years literally, then we can also apply it as a warning not to take the days of Genesis chapter one literally, or the number of days Jesus spent in the grave, for that matter. That's an example of conspiracy overload; you see conspiracies where none exist. Give the Holy Ghost a chance to do his revelatory work.

Mr. Roush of DOTGU

In late 1975, 3,000 copies of a newsprint paper were sent to as many geocentrists, physicists, and astronomers around the country. The newspaper was named after Tycho Brahe, being called *The Braheian Debater*. The people responsible for its content and distribution called themselves "The Defenders of the Geocentric Universe," or DOTGU for short.

To DOTGU, the universe is small, consisting of one giant vortex with many smaller vortices. Their view of nature reflects Zen Buddhism, the atheistic religion that has a certain appeal to today's secular scientists as confirmed by titles such as *The Zen of Physics*. On the other hand, geocentricity is, by definition, a scriptural discipline, willing to accept the results of the sciences as long as those results and theories do no violence to Scripture. It follows that the DOTGU vortex theory would hold greater appeal to atheistic physicists than would the theory of geocentricity.

From the content of the *Debater* it was clear that whoever was responsible for DOTGU was a member of the counterculture called "Freaks" or "Hippies" at the time. Most people erroneously called both groups "Hippies," but in order to be a Hippie you had to live in the Haight Ashbury district of San Francisco at the time before

* II Peter 3:8—But beloved, be not ignorant of this one thing, that one day is with the Lord as a thousand years, and a thousand years as one day.

the Hippie's personified funeral. The Johnny-come-lately "outsiders" were known as Freaks.

The only name associated with DOTGU appears in a letter from a physicist. The letter is reproduced in the next chapter and is written to a Mr. Roush, but the address is left off and no other identifiable details were given. Several of the letters from physicists are quoted in the next chapter.

I was one of the recipients of the newspaper and once had a complete set, but I've not been able to find them in my files nor in my library. Mention of the *Debater* is very rare on the Internet and it is not indexed in the search engines. DOTGU was in print for about two or three years and then ceased publication.

Robert A. Sungenis (1955-), B.A., M.A., Ph.D.

Robert Sungenis is a Roman Catholic known for his Catholic apologetics against Protestant doctrines as well as Judaism. He founded the Catholic Apologetics International in 1993. In 2007, Bishop Kevin Rhoades objected to the use of the word "Catholic" in the name and it was change to *The Bellarmine Report*.

Sungenis was raised in a Catholic family and converted to Protestantism when nineteen years old. As a Protestant, he stayed mainline except for the two years he worked for the cult leader Harold Camping's Family Radio Network. Camping is most famous for setting dates for Christ's return allegedly based on the book of Daniel. He's been



Figure 17: Robert A. Sungenis

wrong every time, which is the hallmark of a false prophet (Deuteronomy 18:21-22*).

Dr. Sungenis earned a Bachelor of Arts in Religion from George Washington University in 1979. From there he entered Westminster Theological Seminary, graduating with an M.A. in Theology in 1982. In 1992 he returned to Catholicism and in 2006 he got a Ph.D. from Calamus International University, an Internet school located in the South Pacific island of Vanuatu. His Ph.D. thesis was on geocentrism and ran some 700 pages in length.

In 2006, stemming from his Ph.D. thesis and working with Ph.D. physicist Robert Bennett, Sungenis published the first volume of a two-volume set on geocentrism entitled, *Galileo Was Wrong: The Church Was Right: The Scientific Evidence for Geocentrism*,¹⁷ and the second volume is entitled, *Galileo Was Wrong: The Church Was Right: The Historical Evidence for Geocentrism*.¹⁸

In November 2010, Robert held the first ever Catholic geocentrism conference at South Bend, Indiana. Robert is also the executive producer of Stellar Motion Pictures, LLC in Los Angeles which produces movies on science and religion. His next movie is titled *The Principle*, due out in 2012, which is a detailed look into the current crisis in cosmology with a special emphasis on the geocentric solution. Robert also runs the "Galileo Was Wrong" website at www.galileowaswrong.com.

Robert James Bennett (1940-), Ph.D.

Robert Bennett was born July 24, 1940, in Teaneck, New Jersey. He holds a Ph.D. in Physics from Stevens Tech., Hoboken, N.J. which was awarded in 1970. His thesis was on rigid body motion in General Relativity. He became a software architecture con-

* Deuteronomy 18:21-22— And if thou say in thine heart, How shall we know the word which the LORD hath not spoken? ²² When a prophet speaketh in the name of the LORD, if the thing follow not, nor come to pass, that is the thing which the LORD hath not spoken, but the prophet hath spoken it presumptuously: thou shalt not be afraid of him.

sultant to Bell Labs and Fortune 500 firms after teaching physics at Manhattan College and Bergen Community College.

His interest in geocentricity started about 2005 while reading a dialogue at the Catholic Apologetics International web site. Until then he was unaware that the Bible clearly supported geocentricity, so he researched the scientific arguments against geocentricity and “found them sadly lacking.”

Bob Bennett’s chief contribution to geocentricity thus far is the chapter he wrote for the first volume of Bob Sungenis’ *Galileo Was Wrong*. His chapter was the last, most technical chapter in the book. Writing the chapter motivated Bennett’s research into the status of geocentricity. His goal is summed up as:

Using the ether to replace Newtonian and Electro-Magnetic (EM) theory in support of geocentrism is a crucial step in gaining scientific credibility; it will be my next publication, God willing. Also, am working on a book on the Peleg bolide and the continental division.

In general, I believe we have gone beyond refuting geocentric disproofs that use relativity—*i.e.*, playing defense—and now can go on offense with positive evidence of absolutism in the Sagnac, Wang and other recent EM experiments.

Bob is right, geocentrists are now on the offensive.

Dean Davis (1947-), B.A., M.Div.

Dean was born in San Francisco in 1947. Raised in a nominally Christian home, he attended University of California at Santa Cruz, graduating in 1969 with a Bachelor’s Degree in Philosophy and a distressingly unfulfilled hunger for spiritual truth.

For the next four years he immersed himself in the Counter-culture, being strongly influenced by the then current interest in pantheistic philosophy and Eastern religion. While reading widely in Hinduism, Taoism, and various Eastern mystical traditions, he identified most closely with Buddhism, and indeed practiced Zen

Buddhism more or less continually throughout this turbulent period in his life.

Through a remarkable work of Providence, Dean met his future wife, Linda, in 1974. Her Christian mother, Louise, shared the gospel with Dean, along with several influential Christian books. In the fall of that year the living God drew near, convincing Dean's troubled soul of the truth of the Bible and his need of the Savior. Soon thereafter, in a small Pentecostal community of devoted Christian youth, he received Jesus Christ as Savior amidst many tears of joy.

Desiring to grow in his new-found faith, Dean took a Master's of Divinity course at Melodyland School of Theology, in Anaheim, California. While there, he came across the work of the *Institute for Christian Research* and was thrilled to learn that the biblical doctrine of a recent and good creation was thoroughly defensible from Scripture, history, and science; and also that its popular secular counterpart—cosmic evolution—with which he had been indoctrinated from his youth, was not. Despite the disappointing compromises of too many Christian leaders on this crucial tenet of biblical cosmology, he has remained a convinced creationist ever since.

After graduation from seminary, Dean served for many years in a number of pastoral positions. However, in 2001 he decided that his teaching gift would be better used by writing and offering seminars on topics of current interest and importance. This led to the birth of *Come Let Us Reason*, a Bible teaching ministry focusing on apologetics and worldview studies.

Seeing clearly that in its hypothesis of cosmic evolution the modern world-system mounts one of its sharpest and most effective attacks on the truth of the gospel, Dean decided to write a book demonstrating the reasonableness of biblical cosmology. What an adventure it turned out to be! Why? Because in the course of his research he realized that just as he had uncritically accepted the "truth" of cosmic evolution, so too he had accepted the "truth" of heliocentrism. In other words, he realized that the Bible really does put the earth at the center of the universe!

The result was a season of intense reading, as well as a great barrage of emailed questions to the leaders of the modern revival of biblical geocentricity. All of them responded more than graciously, so that Dean had the pleasure of interacting with John Byl, Gerardus Bouw, Philip Stott, Robert Sungenis, and Russell Armdts. In his efforts to articulate and defend a fully biblical cosmology, their help was invaluable. Dean further writes:

Unlike my mentors in geocentricity, I am not a scientist. Accordingly, I have neither the expertise nor the inclination to do what they have already done so well, which is demonstrate the scientific plausibility of a geocentric universe. I take great pleasure in standing with them, using whatever philosophical and theological gifts I may have to show that cosmic geocentricity is indeed the teaching of Holy Scripture.

Davis believes that the doctrine of geocentricity is integral to the biblical cosmology and worldview; that it supremely exalts Almighty God as the omnipotent creator and sustainer of a diurnally rotating cosmos. Geocentricity, he says, richly ennoble the earth and its inhabitants, who henceforth are seen to rest, not only at the center of God's cosmos, but at the center of his affections, as well. Geocentricity sets the stage for the fullest possible appreciation of the redemptive work of Christ, who, at his soon return, will vindicate the centrality of man and earth in God's purposes by creating for his beloved children a whole new world, solitary and majestic, illumined solely by the divine glory: the immovable and immutable home of the whole family of God, from that time forth and forever.¹⁹

Dean has written several books which may be perused at his web site. Of geocentric significance is *In Search of the Beginning*.²⁰

Ronald Nelson (1941-)²¹ B.S.

For 34 years Ron Nelson taught science at Cleveland Baptist Temple's Heritage Christian School as well as its Bible Institute. For almost the entire time he taught, he taught the geocentric model of the universe. In 2011 Ron suffered a heart attack and retired from teaching at Heritage, although he still teaches at the Bible Institute. Since his retirement, Ron has recovered from his heart attack and started write a book. He wrote his testimony for *The Biblical Astronomer* in 2008 and gave it the title, "From Peaks of Silver to Streets of Gold With a Stop at Geocentricity Along the Way." It is presented here.

I have entitled my testimony, "From Peaks of Silver..." because it was in Silver Peak, Nevada that the Lord Jesus Christ saved me by his grace, and "...to Streets of Gold because it is to the gold street of the heavenly city that His grace will carry me, and "...With a Stop at Geocentricity Along the Way" because it was at the geocentric/heliocentric crossroad that my faith in humanistic science began rapidly to fall away.

I have now taught the geocentric concept for over 29 years in junior high, senior high, and Bible institute settings. I have continued to face opposition from my Christian brethren and even some from my teaching colleagues. I do not condemn them, but I do pray for them that God will lead them into the way of truth as He has graciously done for me over these many years. It is such a privilege to walk with Him and to serve Him. Praise God for this marvelous Book...the Authorized Version of the Bible...that He has so graciously preserved for us. May we be faithful to dedicate ourselves to its wonderful and unchanging truth.

I was born into a moral, religious family in 1941. My parents were not fervent churchgoers, but they saw to it that my sister, my two brothers and I were active in our Lutheran Sunday School and Church.

Although I spent the first 31 years of my life as an unsaved person, those years under Lutheran teaching were instrumental in planting Biblical seeds into my unregenerate heart. I spent these

first 31 years of my life in pursuit of the temporal pleasures of this life, but giving little thought to eternity. All of my formal education was spent in secular classrooms where I eagerly received all the humanistic science which was presented to me. Upon graduation from high school I attended Ohio University where I was further indoctrinated in humanistic science. Since my college major was geology, I was thoroughly saturated with evolutionary theory.

After graduating from college, I took a position as field geologist for a mining company in Nevada. Since churches (Lutheran or otherwise) were quite scarce in the area of Nevada where I lived I became a stranger to church attendance for several years. At that time one of my closest friends became a Christian and began to witness to me concerning his faith in Christ. Since my friend was a self-professed atheist prior to his salvation, I became genuinely interested in the changes I saw in his life.

At the time I considered myself to be a "Christian" because I did not smoke, drink, cuss, gamble, and tried to be morally good, but when I saw the tremendous change in my friend's life, I eventually came to earnestly desire to have what he had. One night in January 1974, I knelt in my trailer home in Silver Peak, Nevada, and "dared" Christ to change my life as He had done for my friend. I thought that there would be "lightning and thunder," but when that did not occur, I thought I had done something wrong and so tried again. Little did I realize that a genuine internal change had already taken place in my life.

Prior to that time the most important things in my life were antique guns and the money required to purchase them. Little by little I began to realize that reading the Bible had become more important than the guns, and as time went on, the guns fell by the wayside as the Bible became the most important thing in my life.

As I studied the Bible, I quickly became aware of a serious conflict between my humanistic science education and the book of Genesis. If the creation account of Genesis was true, then all of my humanistic, evolutionary science was a lie. I struggled with this conflict for several months and eventually the Holy Spirit began to renew and cleanse my mind and heart with the truths of

Scripture. I became acutely aware that I must believe *all* the Bible or believe none of it. Graciously, the Great God helped me to firmly embrace the former and through His grace I have been kept on this path for the past 34 years.

In 1975-1976 the Lord began dealing with me concerning full-time service and particularly a teaching ministry. Since I am by nature a shy and introverted person, I fought the Lord for several months until finally I could fight with Him no more. I told Him that I could not do it alone and that if it were to get done He would have to do it through me. The year 1977 was a monumental year for me for it was in that year that I met and married my wife, Lynn and responded to God's call to come to Heritage Christian School in Cleveland, Ohio.

Sad to say the first year of my teaching was still filled with humanistic concepts so I enrolled in Westside Baptist Bible Institute at Brookside Baptist Church in Seven Hills. The teacher was James Hanson and it was not long into the class that Mr. Hanson challenged me to try and support my Copernican thinking with Scripture. Certain that I could do this I began to conduct a diligent search of the Bible to find evidence for a moving earth. To my chagrin, I could find no such evidence and soon became open to the idea that geocentricity had true Biblical merit. I continued to search the Scriptures and soon became firmly convinced that if I were to believe in a literal Bible, I must cast in my lot on the side of a geocentric universe. With some trepidation, I began to teach the geocentric concept in my science classes. I met some opposition, but when I presented my Biblical evidence most of the opposition ceased. I have leaned over the years that many people "believe" the Bible as long as it does not interfere with their prejudices, but that a *true* Bible believer is willing to cast aside his unbiblical prejudices when he comes face-to-face with literal Biblical truth. I praise God that His grace has allowed me to be a part of this latter group.

As a result of my Scriptural search I found one of the most compelling evidences in support of the geocentric concept in the form of the symbolism associated with the sun. The sun is clearly

a type of Christ and the literal motion of the sun is an absolute necessity in order to properly portray the going down of Christ into the tomb, the arising of Christ out of the tomb, the descent of Christ from heaven and the ascent of Christ back into heaven. (Interestingly, Christ went down into the tomb at the going down of the sun and arose from the tomb at the time of the rising of the sun.) In the volume entitled, *Preaching from the Types and Metaphors of the Bible*, Benjamin Keach lists no fewer than fifty ways in which the sun represents Christ and many of them require a literal motion of the sun. Two portions of Scripture which bear heavily on this symbolic concept are Psalm 19:4-6 and Matthew 5:45. In Psalm 19 the sun is compared with a bridegroom and a strong man in the matter of their respective motions. Christ is clearly the coming bridegroom and is, indeed, the strong man running to complete His spiritual race. In Matthew 5, as the Father raised up his Son Jesus from the dead, even so the Father makes his sun to rise for the physical good of mankind.

Thomas M. Strouse (1945-), *M.Div., Ph.D., Th.D., D.D., D.Litt.*

Dr. Thomas Strouse is a Baptist theologian and pastor. Married in 1965, he and his wife have 14 children. He was born again in 1969. Dr. Strouse also served as Professor and Dean of Maranatha Baptist School of Theology, Tabernacle Baptist Theological Seminary, Emmanuel Baptist Theological Seminary, and presently of Bible Baptist Theological Seminary in Cromwell, Connecticut, where he also serves as pastor of the Bible Baptist Church.

In addition to his pastoral and Seminary duties, Dr. Strouse has written numerous commentaries on the Bible books including Genesis, Psalms 1-41, Psalm 119, Daniel, Ephesians, I and II Thessalonians, I and II Timothy and Titus. Currently he is working on a commentary on Revelation. In addition to his commentaries, he has written theological books on ecclesiology and bibliology. Throughout, he has been a defender of both the Textus Receptus and the Authorized Version.

Dr. Strouse has also written scores of articles for various theological journals on ecclesiology, bibliology and geocentricity. His writings on geocentricity include a booklet, *He Maketh His Sun to Rise: A Look at Biblical Geocentricity*, and several articles defending geocentricity, several of which also appeared in *The Biblical Astronomer*.

In 1995, Dr. Strouse witnessed a remarkable event when he participated in a debate on the John Ankerberg Show in defense of the KJV. There were two pro-AV supporters with Dr. Strouse; these were Dr. Joseph Chambers and Dr. Samuel Gipp. I've had no contact with Dr. Chambers, but both Dr. Strouse and Dr. Gipp confirmed this account of the event.²²



Figure 18: Dr. Thomas Strouse in 2010.

You can call it pure justice, a sign from God, or whatever you want, but eyebrows were sure raised ... during the taping of Christian TV's *The John Ankerberg Show*. Ankerberg, a bitter opponent of the King James Bible, ... [and] a fervent promoter of the NIV and other false versions, ... made the odds six to three. However, the three King James men: Dr. Joseph Chambers, Dr. Sam Gipp, and Dr. Thomas Strouse, were not deterred by the odds. They accepted John Ankerberg's invitation anyway so that they could get out their vital and important

message: that the King James Bible is the only trustworthy, accurate, scholarly, and whole Bible available in the world!

The John Ankerberg programs are taped in advance in Chattanooga, Tennessee, and then shown later to a national TV audience. For the Bible version debate, eight shows were taped. However, on one of these shows, Ankerberg and the new bible version people were forced to call an abrupt halt right in the midst of the taping.

It happened when Ankerberg asked Dr. Don Wilkins of the *New American Standard Version's* translation committee a key question. "Is it true," asked Ankerberg, "as Gail Riplinger reported in her best-selling book, *New Age Bible Versions*, that a number of the scholars who worked on the new translation committees lost their voice as punishment by God?"

As the TV cameras captured the moment, Dr. Wilkins opened his mouth to answer—and nothing came out! No sound! Wilkins kept trying to clear his throat, but he couldn't respond. Ankerberg and the other new version scholars were visibly startled. Finally, an embarrassed and frightened Wilkins was able to screech out in a cracking, almost inaudible manner, "I ... I've ... lost my voice!"

A shocked John Ankerberg ordered the cameras to stop and to back up, whereupon Dr. Joseph Chambers, a King James only advocate, politely protested. "The cameras should record exactly what happened here." Chambers insisted. However, Ankerberg was hearing none of it. After a brief delay, the TV cameras began to roll again; after the amazing segment of Dr. Wilkins' [temporarily] losing his voice had conveniently been excised!

Dr. Strouse has an international ministry, teaching seminary modules in Puerto Rico, India, Indonesia, Ireland, Korea, and the Philippines as well as USA.

Harald Peter Heinze (1941-)

Harald Heinze was born in 1941 near Hamburg, Germany, during World War II. He was educated in Berlin in economics and theology. Most of his work in Biblical apologetics is published in Germany, Switzerland, and the United States.

From his youth, Harald was suspicious about biological evolution and a universe without God. Later he started entertaining doubts about long ages in geology and the universe. "Therefore," he writes, "for decades I studied the aforementioned subjects practically day and night."

In his testimony he writes:

For me, as a believer in God it is clear, that the earth does not have a random, statistically-understood nature. There is too much evidence that we live in a preferred, special place in the cosmos. This is not only to be seen from astronomical and astrophysical considerations, but most obviously also in biology. To bring forth even the "simplest" living being needs so many "accidents" that, to me, it is far outside of a sound mind to think that in biology. So, I am completely unable to understand, how a biologist with a Ph.D. can entertain such hypotheses.

Harald has been a geocentrist for decades and has long championed a small universe, dating at least as far back as the mid-eighties when he wrote about relativity for *The Bulletin of the Tychonian Society*. He and I debated the small-universe topic in the *Biblical Astronomer* in 1995. Today Harald still favors a fairly small universe but he is not definitely committed to any specific size. "There are too many details not yet sufficiently explored in astronomy and astrophysics," he says, "so that I am somewhat restrained."

Gordon H. Bane (1932-), B.A.

Gordon Bane was born on 3 August 1932 in Liberal, Kansas. Gordon was raised on a farm although, by his own admission, he “was never any good at it.”

Gordon chose to major in business and enrolled in McPherson College, a Brethren school in McPherson, Kansas, for his first year of schooling. After his

first year, he transferred to Washburn University in Topeka, Kansas, where he attended for two years.

Gordon’s education was interrupted by the Army. After his two-year enlistment was up, he resumed his schooling and graduated a year later with a degree in Business Administration from Fort Hays State University in Hays, Kansas.

Gordon and his wife, Dorothy, settled in Hugoton, Kansas, where Gordon had a farm. He retired from farming in 1991. Gordon later said of that retirement that he should have done it much earlier. He made more money having others farm his land than he ever made farming it himself.

The Banes were very generous with their giving. Gordon and Dorothy were members of the Christian Church (instrumental) and generously donated to missions and the Christian Church denomination’s colleges.

Circa 1990 Gordon first heard that there were still people, creationists, who believed that the sun went around the earth.



Figure 19: *Gordon Bane with Beth Bouw in 2012*

When he heard that he says, "It made me instantly mad." Gordon was so angry that he set out to prove these geocentrists wrong once and for all.

As part of his investigation he learned of the Tychonian Society and in 1991 I received a letter from him asking for information. I had just changed the Tychonian Society's name to The Association for Biblical Astronomy and renamed *The Bulletin of the Tychonian Society* to *The Biblical Astronomer*. He started his investigation. I had developed some specialized papers and still had a few copies of *With Every Wind of Doctrine* so I supplied Gordon with what ammunition I had at the time. It wasn't long before he saw the error of his ways and became an ardent supporter of geocentricity.

Perhaps better than anyone else, Gordon understood that a return to the scriptural geocentric view is the first step in a return to the authority of Scripture. He understood, too, that this was far more crucial than creationism since geocentricity is scientific, making quantitative predictions whereas both creation and evolution are philosophies, not science.

So it was that Gordon developed a deep concern for the Christian Church's return to the Bible. He sent literature to the various Christian Church colleges, providing them with copies of *Geocentricity*. He also paid for exhibit booths at the two main missionary conventions of the Christian Church. Gordon and I would staff the booth and hand out literature to passers by. We would have an exhibit board and even computer animations and PowerPoints. After several years of trying to call the Christian Church to repentance, the Missionary committee banned Gordon from the Conventions. His money in support of missionaries and missions was still welcome, but not his presence.

In the late '90s Gordon talked me into supplementing the out-of-print *Geocentricity* with a condensed version called *A Geocentricity Primer*. Gordon appended a publication of his own which ran roughly a dozen pages. A disclaimer separated the two works. With each subsequent printing Gordon's booklet increased in size until finally it reached book size under the title *The Geocentric Bi-*

ble. *A Geocentricity Primer* was corrected in 2004. Gordon sent copies of the combined book to all churches and Christian Church colleges. Later, Gordon did mass mailings, targeting all or part of a city. The brochure had a stub that could be mailed back to him and the sender would receive a copy of the book.

In 2005 I took a full-year sabbatical from Baldwin-Wallace University. I spent the first semester (at half pay) meeting the obligations to the College and the second semester on matters geocentric. Gordon arranged it so that I could speak in the Philippines, where I had been invited to speak by Percival Tanierla and Hercules Cemitara. I spent a week with each of them and then went to join Percival's brother, Manuel, in Iloilo and spoke at churches in Antique for a week. (The Tanierlas' father had fought with the U.S. Navy in World War II, was reborn, and started evangelizing the Bicol region. I was looking forward to meeting the senior Tanierla but he died of food poisoning three weeks before my arrival. Hercules suspected foul play.)

After three weeks in the Philippines I went on to New Zealand where I met my pastor, Murray Bay's father; David Bay. My speaking engagement there was washed out by a storm which made the venue unreachable. I spent an enjoyable week with David Bay who, for years, represented New Zealand's dairy industry. David's involvement with the dairy business started when the Brethren assembly David attended decided to sell milk in order to finance missionaries. That venture is now part of one of the largest dairies in the Far East (Anchor).

As a representative of the NZ Dairy industry, David Bay traveled world-wide. For instance, David went to the Soviet Union with New Zealand's champion sheep shearer. Nikita Khrushchev accompanied them, touring with them to competitions and farms.

On another occasion, David went to Uganda. That was during the reign of the blood thirsty Idi Amin. David took a cab from the airport to the hotel and discovered that the cab driver was a fellow believer and they had a good conversation en route to the hotel where David checked in and went to his room for a good night's sleep.

About 3:00 in the morning there was a loud knock on David's door. It was the cab driver who came to warn David that a group of armed men were on their way to the hotel to kill all the foreigners. David was the only survivor of that massacre, and all because he witnessed to a cab driver.

The cause of the slaughter of the foreign guests was this. Unbeknownst to international passengers, a planeload of Jewish passengers was held hostage in a remote area of the airport. Israel conducted a raid that successfully rescued most of the hostages and this was depicted in the film, *Raid on Entebbe*. The Israeli rescue plane needed to refuel but none of the countries along the route would accommodate them. Two wealthy Jewish Hotel owners who lived in Kenya convinced the Kenyan government to allow the plane to refuel there. The raided hotels belonged to those two Jewish men.

Those events and stories were made possible by the generosity of Gordon and Dorothy Bane. The Geocentricity Tour continued to the United Arab Emirates, where I spoke in Dubai, and the Netherlands where I rested from the trip. (A stop in Britain was cancelled for lack of interest.)

Dorothy died of Alzheimer's disease in 2009. After her death, Gordon moved from Hugoton to Sedgwick, Kansas, to be near his two daughters Debra and Donna and their families.

Hercules Berba Cemitara (1957-)

Hercules Cemitara was born in Caloocan City, in the Philippines on 3 October 1957. He is married to Emma, and the couple has two children, a daughter, Erlyn Joy born in 1998, and a son, Jay Ruel, born in 2005.

My first contact with Hercules was in 2000. At the time he lived on \$74 a month, part of which came from a government job and the rest from a retail shop that he ran out of his house. Erly, as his friends know him, wrote a regular column called "Binhi," meaning "Seed," in *Balitanglaw*, the official publication of the municipal government of Labo.

Around that time, Erly quit his government job and stepped out “on faith” to do full-time evangelistic work. Support has been rocky, to say the least. He works as an itinerant preacher, occasionally landing a temporary replacement position until a new pastor comes along.



Figure 20: Hercules with wife, Emma and daughter Erlyn Joy in 2005

In September of 2003 Erly started a radio show on the Labo FM-radio station DWLB and called it “Genesis.” Originally it had only a creationist emphasis, advocating a 6,000-year old creation. At that time, however, Hercules wanted to add geocentricity as one of the topics. To that end he requested information he could use on the show as well as some financial support. I sent the information and pledged a monthly support. Gordon Bane also offered financial support. In essence, Gordon was the underwriter.

The radio program started in 2004 and ran that way for several years. To wean the broadcast from its spotty financial support (much of the support came from Christians in the Philippines) Hercules started a copying business in his home which was competitively priced against the only other machine in town. That worked fine for a year or so until other expenses built up.

When Erly’s eyes started to fail him, due to cataracts, he enlisted his daughter, Erlyn Joy, to host the broadcast for him. She’s started doing the broadcast in 2010. The program ended in June 2011 when the town of Labo elected a new mayor, a staunch Roman Catholic who would not renew any program that was not Roman Catholic. The mayor is trying to win the Lord’s favor the same way that Adonijah tried to win Solomon’s favor.

Currently, Erly preaches and teaches for a living. The family still has its home-based store.

Conclusion

That is it insofar as coverage of modern geocentrists is concerned. As you can see, there are many geocentrists these days and as in days of yore (Chapter 25), they come from all walks of life. There are more that I could include, but I've lost contact with many of them. A few did not respond to my request for biographical information. Some asked not to be included. And some, well, as I learned early on in my adult life; fringe groups attract more than their fair share of quacks and loonies. The geocentric movement is no exception. The flat-earthers quickly fell off the bandwagon. Plasma and electric universe advocates have nothing to offer to the geocentric cause and vice-versa; so they too quickly fall off. As for the creationists—well, their response to geocentricity needs more coverage than can be said in a single sentence and you will find that in the next chapter. For those that I have included, their heads may not be in the right place, but their hearts are.

What struck me most about the geocentrists in this chapter is the wonderful miracles that many of them experienced in their lives. I've not been able to report them all, but Marshall Hall, for instance, was given six weeks to live with throat cancer in August 2012. He and Bonnie consider it a miracle that he's made it into December 2012 (as of this writing). The Lord has really blessed the geocentrists: not with money but with grace.

It is not my intent to slight anyone; I just have to draw the line somewhere and currently the "bottom line" is to finish this book and get it out in various forms to the public.

Who says that geocentric physics is impossible—God or man? De Young, speaking for other heliocentric creationists, assumes that the present day knowledge of physics is absolutely accurate and must dictate to the Bible physical truths.

—Dr. Thos. M. Strouse¹

GEOCENTRISTS AND THEIR CRITICS

In the eyes of many, yours truly included, geocentrists are a strange bunch. To hear tell, we are a throwback to the dark ages, troglodytes ignorant of science, uneducated in scientific knowledge, and a national disgrace. That sentiment is shared by not only the secular world and secular scientists, but also by creationists of all stripes. An article in the 22 April 1990 issue of *The Sunday Times* of London, England, headlined: "One in three children thinks the sun goes around earth." The text informs us that:

One in three secondary school children thinks the sun revolves around the earth and that sound travels faster than light. Nearly as many think radioactive milk is safe when boiled and do not know that oxygen comes from plants.

The gaps in British children's scientific knowledge have been exposed by a survey of 3,600 pupils in 12 schools. Some of their teachers who sat the test did no better. ...

The results, however, did not surprise Patrick Moore, presenter of the BBC's *The Sky at Night* programme and a man

who has tried to popularise science. "Children are interested in science, but they are not being taught properly," he said.

And there we have it: geocentrists are every bit as ignorant as someone who thinks that sound travels faster than light. It is my considered opinion that it is the teachers of these children who are ill-prepared to teach science, for the "science" they are taught is political indoctrination without a shred of true science, let alone truth.

But are we geocentrists really that ignorant? After all, as the Canadian musician Gordon Lightfoot says, "Names are for calling when there's nothing left to say."² It was Thomas Kuhn who once wrote that sometimes it is in the best interest of science for introductory texts to lie (see quote in Chapter 2, pg. 14). Is geocentricity such a suppressed truth? In this chapter we shall examine unsolicited statements from a representative sample of physicists, mostly American, who wrote in response to being sent a sample copy of a secular geocentrist newspaper, now long defunct, called the *Braheian Debater*. It was published in 1975 and 1976 by DOTGU (Defenders of the Geocentric Universe; see Chapter 38). The organization was actually an extension of the late 1960s, early 1970s counter-culture which was itself an extension of the Hippie movement of 1965. Remember that these letters are more than thirty years old and that the addresses are, too. The principals may no longer be at the institutions mentioned. Nevertheless, these letters show that, although secular scientists may not accept geocentricity as true, they nevertheless recognize that there is no proof against it and that any claims to such proof are as ill-founded as the lamented one-third of British students and their teachers noted above.

After presenting the secular scientists' opinions we shall reprint part of a letter from a first-hand observer of creationists' reactions to geocentricity, and then we shall present the official stand of the Creation Research Society and the Institute for Creation Research on geocentricity.

THE DOTGU LETTERS

I. It's a Fact!

I have had your newspaper on my desk for weeks, hoping to find time to write you. You say in your headline (Fall), "Six Physicists Say it is Possible" that the earth stands still. I don't know who your physicists are, but the situation is much simpler than they seem to think. It is not just possible, it is a fact.

It is also a fact that earth does not stand still. The fact that makes facts of those two apparently conflicting statements is that, as Einstein said, there are no milestones in the Universe, and thus no absolute standard of rest or motion that makes such categorical statements mutually exclusive.

Whether one says the earth stands still depends on the use to which the statement is put. To a navigator, the sun and stars rise and set, and it would merely be a bother to him to consider himself on a rolling earth. To you, there are philosophical reasons that make you wish to take this point of view. Very well, take it. It is not in conflict with anything we know, and is unlikely ever to be.

Of course, there is a reason why physicists and astronomers take the other view. It is this. These people wish, unlike yourselves, to understand the Universe by mathematical laws. The laws are different depending on whether you take the earth as a standard of rest or whether you consider it in motion. It is not a question of right or wrong, they are just different; and those used by astronomers and physicists are very much shorter and easier to deal with than those you would have to use if you were interested in doing mathematical astronomy, which I gather you are not.*

You cannot blame people for using compact, neat, and accurate mathematical formulizations when they are available; and of course it is hard not to have the opinion that the Universe is *better* understood in this way. But you don't have to. If it is important to

* The last two sentences in this paragraph are assumptions on the part of the writer of this letter. As we saw in previous chapters and show in Appendix E, the laws are the same; it is only the frame of reference that is different.

you to consider the earth to be at rest, then the laws of nature can be formulated in an appropriate way.

The kind of thing that's involved is this: you have probably seen in museums or elsewhere a long pendulum set swinging at the beginning of the day, whose direction of swing continually changes as the day goes on. This is usually, and simply, explained as an effect of the earth's rotation.

You don't have to explain it that way. The laws of nature that you would use if you were interested in doing mathematical physics while assuming the earth to be at rest would contain a velocity-dependent force that would act upon the pendulum in such a way as to produce the observed rotation. The whole question is one of philosophic view point, or attitude towards the world. It is not a question of fact, as the word fact is ordinarily understood.

You will do fine, and perhaps even educate some of the confused people whose letters you publish, if you make this clear enough, often enough.

Peace,
David Park
Professor of Physics
Thompsonville Physical Laboratory
Williams College
Williamstown, Massachusetts 01267

Since I cannot disprove your theory without further study, I would like to consider it as one possibility for the present.

Lawrence Lynn
Assistant Professor of Physical Science
Meramec Community College
Missouri

They're going to realize they can't prove you wrong.

Joe Kelleher
Teaching Fellow, Philosophy
University of Utah



COLLEGE OF THE PACIFIC

a College of Arts and Sciences

UNIVERSITY OF THE PACIFIC Stockton, California

95211

November 2, 1975

Dear Mr. Roush,

I am in the process of carefully reading your Fall issue of the Ebraheim Debater and have discovered that I am one of your chosen 3000. For fear you might publish my name, I thought I had best reply to your earlier letter.

I think that physicists who have thought much about the implications of general relativity are likely to generally agree that there is no presently known way to determine absolute motion. In any case that is the truth to the best of my understanding, and I tell my classes that had Galileo confronted the Church in Einstein's day he would have lost the argument for better reasons.

You may use my name if you wish,

Sincerely

Carl E. Wulfman

...you indeed are right and also that those opposing ... are right.

John Broderick

Assistant Professor of Physics

Virginia Polytechnic Institute and State University

I think that your theory has some merit—this comment is made as a philosopher with some insight into the scientific method.

Greg Kohlback

Graduate Student in Philosophy

University of North Carolina

MICHIGAN STATE UNIVERSITY EAST LANSING - MICHIGAN 48824

UNIVERSITY COLLEGE DEPARTMENT OF NATURAL SCIENCES - KEBBE LABORATORY

BRAHEIAN DEBATER
Voice of the DOTGU
P.O.Box 254
Sunnyside, CA 92388

Ladies and Gentlemen:

I have just received --- from a friend --- the Spring, 1976 issue of your most interesting Journal.

First of all, I gather that this is the second issue of your paper and I am extraordinarily anxious to obtain the first in which I gather your major arguments were presented.

If there are any other issues, I want them also!

I teach a General Education Science course for non-science majors on the Copernican Revolution. In the first lecture of the course, I jump off the lecture table to "prove" that the earth is at rest.

One of the major points I have made in recent years is that, given a choice between Tycho and Copernicus after the observations of the phases of Venus by Galileo, the smart money was on Tycho.

For this reason, I would make your issue(s) --- if suitable --- required reading (texts which must be purchased) for my class of ca. 110 students if the cost would not be out of line. Although the current issue is marked "FREE," I therefore would want to know if there would be a charge for ordering one or more issues in bulk.

In passing --- are you aware of the *Bulletine of the Tychoonian Society*, ed. W. van der Kamp/14813 Harris Road, RR # 1/ Pitt Meadows British Columbia, V0M 1 P0, CANADA? I have been reading these with great pleasure for some years. You might want to do so -- perhaps reprint an article or two --- since your interests are so congruent.

I look forward to hearing from you at your earliest convenience, as I must place text orders very shortly.

Sincerely,

Donald J. Weinshank
Associate Professor

II. Geosynchronous Satellites

To call...a geosynchronous body a satellite, is simply to use "satellite" to connote dependency, as in "Hungary is a Russian satellite." But in this sense a "geosynchronous satellite" is a satellite also of all other bodies in the universe, insofar as they all have a gravitational effect on the body. The expression, "geosynchronous

orbit," would thus make sense only if it is understood to be a misnomer for *gravitational equilibration*.

The difficulty of placing a body in "geosynchronous orbit" is merely that of finding the area of relative gravitational equilibration between earth and the other bodies of the universe. Since *syn-chronous* is a symmetrical, transitive and reflexive relation, a "geosynchronous" body is synchronous with all and only "geosynchronous" bodies. [*Sic*] And since the other stellar bodies, of which a "geosynchronous" body is also a satellite are not themselves "geosynchronous," the area of relative gravitational equilibration wanders away from the position occupied by a "geosynchronous" body. Being no longer gravitationally equilibrated, the body loses its "geosynchronicity;" and the non-geocentrist says, "Aha! Orbital decay!"

—Anonymous

Concerning the "Killer Question" in the winter 1976 issue: In the usual Newtonian treatment of rotating reference systems, one must introduce "fictitious forces," such as the centrifugal (not to be confused with centripetal) force and the Coriolis force, in addition to "real" forces such as gravitation. In the case of the geosynchronous satellite orbit as viewed from a reference frame rotating with the earth, the centrifugal and gravitational forces just cancel one another, so the satellite is unaccelerated in that frame and can remain motionless. (Note that this balance of centrifugal and gravitational forces is valid only here—it is *not* the correct way of explaining orbital motion in general.)* Again, this only shows that it is possible to use a co-ordinate system in which the earth does not rotate, not that this is in some sense the correct or only system.

George L. Murphy —Physics
University of Western Australia
Nedlands, Western Australia

* This is because, as I have said earlier, the fictitious forces (centrifugal, Coriolis, and Euler) are not recognized as real, gravitational forces in the heliocentric model.

III. Make Mach Your Main Man

From this time henceforth, let the name of your newspaper be "The Machian Debater." Make Mach your main man!

A twentieth century answer to the question, "Could the earth stand still?" was given in *The Science of Mechanics*, by Ernst Mach in 1912. (Heard of airplanes going "Mach 2"? Same gentleman.) Here's the story. Some Astronomy texts discuss several "proofs" that Earth spins. A few are: (1) The Earth is bulged at its equator, squashed at the poles. This proves that the earth turns. (2) A pendulum swinging at the North Pole slowly changes its direction of swing, making one complete rotation of its swings once each 24 hours. Standard interpretation: the Earth is turning under the pendulum.

Mach took another look. All objects have inertia, the property of matter that makes it sluggish, hard to put in motion, hard to stop. What causes this inertia? Mach figured that it was the cumulative effect of all of those stars way out there. The stars in the Universe are very far away but there are very many of them. Therefore Mach proposed Mach's Principle: An object has inertia due to the presence of stars. An object is hard put to stop (hard to accelerate) because you are trying to change its motion with respect to the stars.

The outcome of this giant leap of imagination is thrilling. Suppose you assume that the Earth is at rest. Then the stars must be whirling around us once each 24 hours. But what then of the proofs that the Earth turns? The effects in those proofs are due to the whirling stars! The stars would cause an outward pull on the Earth's equator (above which the whirling is fastest.) The pendulum would be whirling around with the whirling stars (roughly like a leaf in a whirlpool.) Every single observation that has been advanced to "prove" that the Earth spins can also be explained by a fixed Earth and whirling stars.

In the middle of 1913, a young man named Albert Einstein wrote to Mach expressing his appreciation for Mach's ideas. Einstein is the fellow who went on to compose the General Theory of

Relativity. The basis of this theory is that all motion is relative! Einstein wrote his equations describing how the Universe works. If the Earth spins and the stars are at rest--the equations explain all observations. But if the Earth is at rest and the stars whirl--the equations still explain all observations. They must, for the theory begins with the assumption that all motion is relative. You can't say positively that any thing is at rest. Take your choice--the equations of General Relativity come out the same. Einstein put Mach's idea into mathematical form and what emerged is surely one of the ultimate creations of the human mind.

Yours in Mach-ination,
Charles Long, Ph.D.

N. Hennepin State Community College
Minnesota

That completes our collection of letters to the *Braheian Debater*. As you can see, there was no great outcry against the geocentric universe or even creationism in the mid-seventies. Even though DOTGU's vortex theory could not fit reality there was no uproar and no one bothered to point that out. We continue with a collection of quotes from another work.

On a Rotating Universe

Cosmological models for a universe with expansion and rotation are considered. In particular, we analyze some effects of the universal rotation on the observational cosmology. The following quotes are taken from Obukhov's article entitled "Rotation in Cosmology."³ Page numbers locate the quote in the article.

Since the first studies of Lanczos (1924), Gamow (1946) and Gödel (1949), a great number of rotating cosmological models have been considered in the literature. Nevertheless, the full understanding of observational manifestations of cosmic rotation is still far from reach. (Pg. 121)

There is a general belief that rotation of the universe is always a source of many undesirable consequences... The aim of this paper is twofold: to show that [these consequences] are not inevitable (and in fact, are *not* caused by rotation), and to find *true* effects of cosmic rotation. (Pp 121-122.)

We have shown...quite plausible rotating cosmological models which in many important respects are similar to the standard cosmologies. As we see, pure rotation can be, in principle, large, contrary to the wide-spread prejudice that large vorticity confronts many crucial observations. (Pg. 123.)

What of Christian Scientists?

It is clear from the above quotes that in the mid-1970s there was no great opposition to geocentricity and creationism from secular scientists. (Hostility against scriptural theories flared *after* creationists started their legal actions against evolution. Nothing strengthens an idea like persecution.) Even as an atheist I had similar views to those expressed above. Back then, most physicists found the idea plausible and somewhat entertaining, though none would necessarily believe it as the true state of affairs. When it came to Christian scientists, however, the reaction is more akin to the newspaper article referred to at the start of this paper.

Mulfinger to Board Members of the Creation Research Society

The following letter was dated 26 December 1978 and was addressed to Professor Harold Armstrong of Queens University, Kingston, Ontario, Canada. Professor Armstrong was sympathetic to geocentricity and, at that time, was the editor of the *Creation Research Society Quarterly*, the most prestigious and scholarly of creationist publications. Copies of the letter were sent to the board of directors of the Creation Research Society as well as to Dr. Duane Gish, Dr. George Howe, and Dr. John Whitcomb.*

* By the way, my copy of this letter did not come from Prof. Armstrong but from another member of the Board.

Greetings from the Southland! I trust that at this time you are getting some much-needed rest from the rigors of academic life.

The purpose of this letter is to convey my views on the question of geocentrism. I have felt a growing concern for what might happen to the Society if we go too far in countenancing the Tychonian view, and several other members have expressed a similar concern to me. However, the displeasure of our members and the reaction of outsiders, although important, is to me but a secondary consideration. My primary motivation is a desire to do justice to the truth of the matter. The truth of the heliocentric view is solidly founded on the mathematics of Kepler and Newton. As you know, their calculations are based on many observations. Moreover, their equations have been verified by an additional three centuries of rigorous testing. Any major defects should certainly have become apparent by now; yet today's space program continues to testify to the essential correctness of the system of celestial mechanics they established. Now there is no consistent way to accept both the Keplerian-Newtonian framework and the Tychonian view. As I am sure you are aware, one of the major outcomes of classical celestial mechanics is that the most massive body in a system will tend to dominate that system gravitationally. The Tychonian view pictures the sun as revolving around the earth, but the other planets as revolving about the sun. Ridiculous! If the earth is massive enough to dominate the sun gravitationally, it will dominate the other planets as well. If it is not, then it will be dominated by the sun, and will orbit the sun as the other planets do. The Tychonian view requires, in effect, that there be two "most massive" bodies in the same system.

My initial interest in this question started back in the Sixties when I struck up a correspondence with Walter van der Kamp. I had felt that something could perhaps be accomplished in his behalf by gradually and methodically calling certain truths to his attention. However, after years of painful

frustration, I saw that it was leading nowhere, and reluctantly gave it up as a lost cause. I did come to appreciate Mr. van der Kamp as a fellow Christian and to recognize his unusual ability as a writer. But as an astronomer and physicist he is woefully lacking. Also, though he is somewhat of a philosopher, I would seriously question his expertise as a logician. In science we need to be extremely careful how much we attempt to deduce from negative results. Yet van der Kamp seeks to build an entire universe on the null result of the Michelson-Morley experiment coupled with a reinterpretation of what Airy didn't find.

This letter is being written as a communication from one board member to another, with copies being sent to some other interested board members. I see no point in soliciting a response from the other side, as I have already corresponded extensively with van der Kamp, Hanson and Bouw, and I am quite familiar with their "answers." I also discussed the question at some length with Hanson when he visited the campus here three or four years ago. I have found all three of these men to be very friendly, but completely unreasonable. They refuse to accept clear, logical demonstrations the like of which they would never think to question in other areas of science. There is no doubt in my mind as to their sincerity, but they consistently fail to answer my arguments, and they seem unprepared and unwilling to face the implications of that failure. Prior to Hanson's visit I sent him a list of five evidences of the earth's revolution. These were: Bradley's experiment, the parallax of stars, the annual loops of Pluto, the intensification of meteors after midnight, and the annual Doppler shifts of stars. After he had had some weeks to ponder these, I asked him how he proposed to deal with them. He replied that potentially he could answer all but one of them—parallax of stars. When pressed further, however, it became clear that he was unable, in actuality, to deal with any of them satisfactorily.

More recently I corresponded with Bouw. In this series of letters we concentrated more on the question of the earth's rotation. As you are probably aware, these men refuse even to accept the fact that the earth spins on its axis. They would prefer to have us believe in a universe that rotates around the earth each day! As evidences of the earth's rotation I presented the following: the oblate shape of the earth, wind patterns (both general and localized), the force on projectiles and spacecraft, the force on falling bodies, the Foucault pendulum, and direct observations from the moon. He attempted to explain most of these as the result of a diurnally rotating gravitational field generated by the spinning universe.* I countered this by bringing up the question of synchronous satellites. If the earth is indeed stationary and nonrotating as they claim, then the synchronous satellites are also motionless, and we have the very serious problem of what keeps them from falling to the ground! Bouw claims that the rotating field of the universe would hold them in place. But he also claims that the same rotating field would impart a sideways (west to east) force on missiles, falling bodies, etc. How could the same field hold one object in place while imparting a sideways force to another?†

In conclusion, I would like to protest the inclusion in the CRSQ of any further papers giving support to the Tychonian perspective. I believe we have gone too far already. However, I will accept a large portion of the responsibility for this.

* That is, using Mach's Principle, as explained by Long above. The reader will note in what Mulfinger says later in the same paragraph that he does not understand Mach's Principle. Because it is commonly assumed that the universe can be ignored in heliocentric physics, Mulfinger forgets to consider it when its presence cannot be ignored.

† This is a serious blunder on Mulfinger's part. He fails to see that the geostationary satellite keeps the same distance from the axis of rotation of the universe (of the earth in the heliocentric view) whereas the Coriolis force, Mulfinger's "sideways force," exists only if the distance to the axis of rotation changes. This was freshman-level college physics back then, and Mulfinger, who taught physics at Bob Jones University, fails to see it.

As you know, I included one of van der Kamp's booklets in my "Symposium of Creationist Astronomy." This seemed innocuous at the time, but in retrospect I am convinced it was a mistake. We should be consistent. We accept and use the tried and tested laws of physics in other areas; we should accept and use them in this area as well. (*Underscores in original.*)

One person, who was a member of the inner group of creationists and will remain anonymous, wrote the following in defense of the geocentrists on 28 March 1980. This letter was partly in response to Mulfinger's letter above.

I can sympathize with creationists who consider this issue too hot to handle. We have had too long and hard a climb uphill to get creationism to where it is today. All the world would have to do is tie together creationism and geocentricity, and we could lose it all overnight. I respect them for this "hands off" approach, officially. What I cannot understand, however, is why so few of us are willing to entertain the matter unofficially. As a committed creationist, I can actually live with either a helio- or geocentric model. My delight in the matter is in thinking about how the evolutionists would pop a cork if the geocentric model were objectively and astronomically verified. Can you just imagine what this would do to uniformitarian theories of solar origins? It would drive them absolutely bananas! And furthermore, it would also be a big shot in the arm toward a consistently literal hermeneutic and taking the Bible seriously in matters of science. One thing the liberals consistently appeal to in their defense of non-literal interpretation is phenomenological language; how I'd love to be in on the action to rip the rug right out from underneath them.

"What I cannot understand, however, is why so few of us are willing to entertain the matter unofficially" is rather an understatement. Actually, most have been given some bad advice. I agree with the author of the statement insofar as dam-

age to creationism is concerned. But truth is truth, and to emphasize part of it while implicitly denying another part cannot be pleasing unto God. Is his hand straitened? I must proclaim the whole truth insofar as I know it, and I know that the word of God is truth.

There was a brief time when top ranking creationists were considering geocentricity. That time was back in 1978 when they relied heavily on the advice of two men on this matter: Harold Slusher (then with the Institute for Creation Research at San Diego) and George Mulfinger (1932-1987), who was science chairman at Bob Jones University. Both men had only M.S. degrees, and both were too busy with creationist arguments to devote the required time to study the geocentric papers and references sent them. They took it on faith that the elementary textbooks from which they daily taught their classes told them the truth. That this is so is clear from a brief exchange of letters I had with Mulfinger in which he concludes that he may take a look at the copies of references I sent him, time permitting. The references sent answered all his questions, bar none. From the following letter it is clear that he dismissed the references without reading them. The references sent said the same thing as the secular scientists quoted above, except that [the references] did so in a much more technical manner.

Who, Then, Is Right?

The question facing the reader is this: is Mulfinger correct in his claim that heliocentrism is a proven fact, or are the secular scientists and geocentrists correct in their claim that heliocentrism is not a proven fact? Harold Armstrong knew physics well enough not to believe Mulfinger's arguments and continued as best he could to counter Mulfinger's directive not to publish any more articles supporting geocentricity. His continued support became one of the factors leading to his ouster from the editorship of the *Creation Research Society Quarterly* circa 1985. Despite that,

Armstrong continued to support the Tychonian cause until his death.

Harold Armstrong knew all the arguments, even as the physicists quoted above. Armstrong's university (Queen's University, Kingston, Ontario, Canada) never reprimanded him for his geocentric leanings. Mulfinger, on the other hand, was denied a Ph.D. from Syracuse University because, according to the University, he was not Ph.D. material. In such cases, an M.S. was granted as a consolation prize.

Although Mulfinger maintained that the University's denial of his Ph.D. was because of his creationist activities, one wonders at the truth of that on two grounds: first, from personal experience I know that creationists encountered almost no antagonism in the physical sciences until about 1980 at which point the opposition came from evolutionary biology, not from physics or astronomy; and second, one has to doubt the reasoning ability of a man who believes that walking around an object won't show all sides of the object while having the object turn while one stands still, will (the reference to "direct observations from the moon" in the second-to-last paragraph of Mulfinger's letter to the CRS Board). Donald de Young, of Grace Seminary, made the same blunder in 1988 in an article which appeared in the Australian creationist journal, *Ex Nihilo*.⁴ Furthermore, is it not significant that two of the first astronomy Ph.D.s to become creationists (John Byl & I) both supported the Tychonian cause while later ones, seeing the arrows in the backs of the pioneers, simply avoid making an issue of it?

The Status of Science Today

It is clear from my personal experience that prior to 1980 there was no significant antagonism among secular scientists against the geocentric paradigm. At that time, opposition arose almost exclusively from Christians in academic positions. The testimony of the non-Christian physicists was clear: it is impossible to prove or disprove either geocentricity or heliocentrism. The introductory textbooks deceive when they claim such proof. And when creationists

succumb to that simplistic deception, they justify the world's scientists' dismissal of creationists as scientists, let alone whether they can be counted as scientists at all.

Today the scientific climate is radically different. Much of this change was precipitated by the creationists' lawsuits, led by the Institute for Creation Research and the Creation Research Society.

By 1976 the American Humanist Association was so upset by the creationists' success against their religion that it devoted an entire issue of their magazine, *The Humanist*, to the creation-evolution debate.⁴ In the magazine, several authors suggested two strategies to combat creationism; both involved ridiculing creationists by charging them with hypocrisy for not believing two "scriptural" models. The first strategy was to demand that, to be consistent, creationists must believe in a flat earth because the Bible teaches a flat earth. The second was similar, *viz.* to demand that creationists must accept the geocentric universe because the Bible presents an immovable earth. The latter could also exploit the popular myth that Galileo was tortured and imprisoned by the Roman church for his stance for the Copernican universe.

Both strategies are ethically flawed. The first strategy is an out-right lie for, as seen in Chapter 3, it is easy to show that the Holy Bible does not teach a flat earth.⁵ The second strategy proposed by humanists against creationists is not a lie but relies on the blind acceptance of a global myth that geocentricity has been scientifically disproved. In that strategy, the creationists are guilty as charged, though they vehemently deny it.

⁴ This issue marked the end of free speech in scientific publications. It took another eight to ten years to squelch free speech in the colleges and universities. That was done under the guise that it was the Christians who were suppressing free speech; a charge that litigious creationists could not refute. It took another 18 years to ferment into the power-drunk Satanic force that humanism now is. Remember, humanism is a religion that believes only in itself. It claims that there is no judgment and there is no hell; to which most modern Bible versions attest. Try to find all 54 of the Authorized Version's occurrences of the word "hell" in any one of them.

The two humanist strategies have been used from time to time, and it is revealing to see how and when they have been used. The flat earth strategy is by far the more commonly used of the two. In 1984 the National Science Foundation (NSF) issued a special, beautifully illustrated booklet that pictured an ancient flat earth map on the back cover. The issue was designed to fool the reader into believing that the evidence against a special creation is as strong as the evidence against a flat earth. The magazine was full of religious bias and was strong on gloss, but it was crucially short on logic and totally devoid of proof.

The humanists' geocentric strategy against creationism has been used a few times but never in an effective way. Instead of pointing out the hypocrisy of creationists in taking the Bible literally in Genesis 1:16 but not in Ecclesiastes 1:5 and Isaiah 38, the humanists use the "Poor Galileo" pity-party strategy which sparks emotional appeal but totally and demonstrably contradicts the historical record. Just why the more devastating approach against creationism has not been used, no one will say. Perhaps the humanists realize that if it backfires, they, also, lose all credibility in the eyes of the public, for there is no proof against the geocentric model.

Geocentricity Today

So what is the status of geocentricity today? Physicists know it, though few admit it, but the general theory of relativity (GTR) was invented to explain away certain embarrassing experimental results that favored the geocentric universe. GTR does so by imposing a coordinate transformation on moving systems which makes every point in the universe look as if it is in the center of the universe. Thus, the worst physicists can say against geocentrists is that we misrepresent relativity when we use it to claim that the geocentric model is a viable model of reality. And, according to the GTR, it is. Modern physicists will allow that geocentricity is one possible model, but in no way is it the correct one. That is, of course, a matter of opinion, not a statement of fact.

Modern astronomers and physicists do not believe that there is a third heaven beyond the universe or the firmament. Without the third heaven, they are correct about the nature of GTR; but given a third heaven beyond the edge of the firmament, the abode of the God of creation and the Author of the Scripture, the geocentric model is more than likely the correct view. We see that little has changed since 1916 insofar as the secular physics' position on the geocentric universe is concerned.

And that brings us to modern Christianity and its reaction to geocentricity. There the situation has changed. Christian resistance to a scripturally compatible model of creation has increased.

We wrote earlier of the opposition of George Mulfinger to geocentricity. Mulfinger wrote his lengthy letter of opposition in 1978. By 1985 Bernard (Bernie) Northrup, a Wickliffe translator undertook a superficial examination of geocentricity and was upset by my steadfast defense of geocentricity. However, he was even more upset by my faith in the Authorized Version and the rejection of the Alexandrian perversions. Thus he charged geocentrists with heresy.

Then there is the case of Robert Kofahl, a chemist, who was infuriated by geocentricity. Likewise, the late Henry Morris would, at first, get visibly upset if asked about geocentricity during the question and answer time after one of his creationist presentations. After a few years, his response mellowed a bit, claiming that to embrace geocentricity would weaken the creationist movement. The weakening would, of course, manifest itself in the form of a loss of revenue, not in a loss of credibility in the sight of humanistic scientists since there was none to begin with.

By 1992 an old Bible-Science group in Anaheim, California, of which, if I recall correctly, Bob Kofahl was a key figure, declared geocentricity an "end-time heresy." Any person who professed geocentricity was ousted from the group.

The Flat Earth Society instituted a similar policy against geocentrists. After a brief exchange of views with Walter van der Kamp circa 1978, Charles Johnson (1924-2001), the longtime head of the Flat Earth Society, excommunicated any member of his So-

ciety who would join van der Kamp's Tychonian Society, which was then the premier geocentric organization in the world. The flat earth believers sided with the creationists against geocentrists, confessing that geocentrists are the most fundamental of all men who professed faith in the inerrancy and preservation of Scripture.

One of the criticisms against the theory of geocentricity, as presented in this book, is that some of it relies on the accuracy of the Authorized Bible. It is true that you cannot find any mention of the firmament in most modern versions, but is that a fault in the A.V.? It's none of my doing that the AV happens to be by far the most scientifically accurate translation I've found. Nevertheless, the A.V. is a stumbling stone to many creationist anti-geocentrists. The inerrant word of God has to exist somewhere in complete form, or the word of God is neither infallible nor preserved and God would be unjust to judge men by their response to the word of God.

Straw Men

Creationists, like their evolutionist counterparts, are not above erecting straw men and knocking them down. Faulkner and De Young are the most proficient at that. For instance, their claim that the astronauts on the moon saw the earth rotating therefore they've proven the earth rotates is a straw man. If you believe that is a proof, then you also have to believe that while riding on the horse of a carousel and you see the central support rotating; it proves that the central support rotates and that you're not turning about it.

The most common straw man is to select the very weakest and most circumstantial geocentric verses, such as Psalm 93:1. Instead of coming to my own defense, I shall quote another's response:

In critiquing the geocentric position, [Humphreys] provides a classic example of this [straw man] in geocentric-heliocentric debate. In critiquing the geocentric position, he declares that its "foundational text" is Psalm 93:1,⁶ which states "the world also is established that it cannot be moved." This is a straw

man attack. Danny Faulkner sizes up Gerardus Bouw's defense of geocentricity under the three arguments of Psalm 93:1, "sunrise and sunset," and the firmament.⁷ The erection of Psalm 93:1 and the expressions "sunrise" and "sunset" as key defenses for geocentricity clearly show either the lack of understanding the biblical defense of geocentricity or the acknowledged biblical inability to exegete the passages actually used to defend geocentricity. Believers of the past have held to geocentricity because of the exegesis of passages such as Genesis 1:1-19, Joshua 10:12-13, Psalm 19:4-6, Ecclesiastes 1:5-8, and Isaiah 38:8. ... Secondary arguments based on Psalm 93:1, I Chronicles 16:30, etc., although in harmony with these passages, should not be put forth as the main or only arguments for geocentricity.⁸

Straw men can also be implemented as appeals to authority. For instance, I was once called in to assist Paul Ellwanger, a geocentrist, to counter the arguments of Hutton Gibson (Mel Gibson's father) against geocentricity. Before the counter argument could be composed, Gibson had hired an Australian astronomer who knew nothing of the arguments we use and noted that the orbits of the planets would intersect if these orbited the earth. Hutton concluded that the planets would thus collide, ergo, heliocentrism is proved. By the time our response arrived, Hutton's mind was set and all hope of reasoning with him had vaporized. I doubt that the astronomer Hutton hired was ignorant enough to believe the Tychonian model could be disproved by colliding planets since the orbits in the Tychonian model emphatically do not intersect, but Hutton grasped for any straw provided by his authority, who was not conversant with all the facts.

A similar thing happened with economist Dr. Gary North in 1994. He, too, inquired for similar information although in his case it had been sent him back in 1992. He, too, got impatient and hired his own astronomer, Dr. Michael Martin Nieto of Los Alamos National Laboratory to prove geocentricity wrong. Dr. Nieto, like Hutton Gibson's astronomer, did not investigate any of the

geocentrists' arguments. North still claims geocentricity is an error and that his hire proved it so; but Martin Selbrede, who knows North all too well, answered Nieto's supposed proof of heliocentrism in a paper that was printed in *The Biblical Astronomer* in 1995.⁹ Again we have a case of a grasping at straws from an authority not conversant with all the facts.

The Foundation of Our Beliefs

For the last 200 years the episteme—the driving presuppositions and foundations that decide what is true and what is false—has been directed to eliminating God from his creation. Buddhism (Zen) has no god or gods and so is a religion to be preferred by atheists and agnostics even if its science borders on nonsense. Christianity, with its reasonable God (Isaiah 1:18), is to be rejected at all cost.

When it comes to creationists; well, we were all schooled under the same episteme; the same presuppositions and foundations. All Christians must confess certain things. Among those things are the so-called "fundamentals":

1. That all we have sinned against a holy God;
2. That the penalty of sin is death;
3. The virgin birth of Christ;
4. The transference of our sins past, present, and future onto Jesus on the cross;
5. His bodily resurrection; deliverance from sin and death by grace—it is the free gift of God;
6. Our resurrection from the dead, and so on.

Upon those points, most creationists can agree. When it comes to geocentrists versus creationists the key disagreements between the two groups are these:

1. The infallibility of Scripture;
2. That Scripture is revealed truth, not recovered truth;

3. That when Scripture says in II Timothy 3:16 that "all Scripture is given by inspiration of God"¹⁰ that said inspiration extends to all faithful translations of the revealed Scripture;
4. And lastly, something that was once universally accepted among believers but not anymore—that God preserves his Scripture from corruption.

Without all four of these ancient landmarks Scripture is no longer pure, sure, and absolute. In the absence of purity and final authority, it is not incumbent upon the reader to believe *anything* written in Scripture. Most creationists at least give lip service to the first doctrine in the list, but none dare to employ it on the matter of geocentricity. Almost all creationists deny the latter three doctrines.

In our schools, religious and secular alike, the history of science is presented so that the Christian is made to feel shame. Take Galileo, for instance. Poor, poor Galileo was sooo persecuted for his teaching heliocentrism as fact that he twice was dragged before the Inquisition, threatened with torture, and had his life ruined by being kept incommunicado under house arrest. The student is brought to tears with pity. No one will teach the truth, however, that the Catholic Church, i.e., the Pope, set him up for life, giving him a pension and a villa from which he was free to travel and have visitors and teach heliocentrism as a theory. Galileo was especially favored by the Jesuits although he never joined their order. Galileo, a true humanist, repaid the Catholic Church's kindness with insults and diatribes. Even at that, he was reprimanded and released to his villa and pension. He was not tortured, not humiliated. But one has to read dry biographies to learn that. One rarely hears it in a classroom.

Is it any wonder, then that when a scientist becomes a creationist or geocentrist the hostility begins and the brush and pot of tar are brought out. For most men the threat is enough. In such circumstances, it is easiest to succumb to the established version of reality and not to investigate the truth any deeper. But a Chris-

tian has a conscience; so that when confronted with geocentricity, his conscience is pricked and his initial reaction is rage. How he reacts, whether emotionally or intellectually, reveals the mettle of the man.

In Chapter 38 I told of my intensive study of Scripture to determine the degree that the scriptures are geocentric and after three weeks of work I could only conclude that Scripture was most likely geocentric. A couple of weeks after that, I had found a job at a clothing store and was walking the floor. My mind was filled with things geocentric. Why did I find geocentricity so hard to accept? After all, God is omnipotent and can do anything he wants. True, the verses I'd found in my study were not strong at all (they are the same verses that some creationists falsely say are my foundation for geocentricity); there was still room for doubt.

But then there was Joshua 10:13. No room for doubt there. So why not go all the way? I thought about the power God expended to create the universe (I didn't know of the firmament at the time.) And then there was the power and energy needed to hold the universe together in its daily rotation and its yearly motion. That is a lot of power! Still I had my doubts.

I walked a bit further and then it hit me: I knew why my doubt would not go away. If God expended all that power for his people, he was expending it for me, too! That amount of power and energy indicated a deep, deep love, which demanded a response from me. But I was neither willing nor thought myself able to take on such responsibility. That was my great impediment and I believe many creationists, when confronted by geocentricity as a scriptural doctrine hit the same wall. I had no choice: rejecting my responsibility amounted to rejecting my Lord and my God; so I believed.

Conclusion

We have documented the arguments by physicists and creationists for and against geocentricity. We found that secular physicists are more open to the geocentric model of the universe and

will even defend it if it is presented in a secular or "Zen" way. If framed in a Christian perspective, opposition is greater but still limited. Insofar as the Christian world is concerned, opposition to geocentricity is stronger and usually more vehement for any given level of education. Again, opposition is more careful and restrained from physicists and astronomers that are more talented than among the less talented. The talented try to ignore the matter altogether and keep their mouths shut.

Lastly we examined the foundations of Christianity and the doctrines that need to be believed by creationists to enable them to become geocentrists. We saw that it was a lot easier to be a geocentrist a century or more ago than it is today because crucial doctrines have vanished from modern Christianity. There has been a very great falling away from the scriptures. "The King James Bible is too narrow for us" is a common complaint among professing Christians today. They forget the words of Jesus on this matter:

¹³ Enter ye in at the strait gate: for wide *is* the gate, and broad *is* the way, that leadeth to destruction, and many there be which go in thereat: ¹⁴ Because strait *is* the gate, and narrow *is* the way, which leadeth unto life, and few there be that find it. (Matthew 7:13-14.)

Let us hear the conclusion of the whole matter: Fear God, and keep his commandments: for this is the whole duty of man.

—Ecclesiastes 12:13

IN THE WOODSHED

At this point there is no punishment in the woodshed, only an admonition. "Fear God, and keep his commandments: for this is the whole duty of man." Solomon wrote that as he approached the end of his life. No longer was he the king of Israel; that duty he had transferred to his foolish son, Rehoboam. His wives and concubines no longer appealed to him. Recollections of how his father, David, had stayed faithful to the Lord led Solomon to repentance. Solomon became a preacher of righteousness and wisdom.

It takes a selfless man to reject all he stood for, worked for, and treasured all of his life and to renounce it as a wasted life. Such is a wise man that repents and turns to Jehovah, and that is what the wisest man before Christ did. Will today's wise men be as wise as Solomon? In this chapter, we shall summarize the evidence presented heretofore in support of the scriptural doctrine of geocentricity. Next, we shall also review the damage done to Christianity by the wholesale rejection by the churches of the doctrine of geocentricity as *the* foundational doctrine for the resurrection. Finally, we shall review the consequences that will be inflicted in the woodshed by the Lord Jesus Christ himself upon the Bible rejecting gainsayers upon his return; which punishment is clearly prescribed in Scripture.

The focus of this book was the scriptural doctrine of geocentricity, the immobility of the earth. We discovered that the doctrine of geocentricity was a key doctrine in Scripture. It is a necessary doctrine for the doctrines of the infallibility and inerrancy of Scripture and it is the foundational doctrine for the resurrection of Christ. Yet, Christian scholars and laity rejected that doctrine; they disposed of it as if it were an evolutionary “vestigial organ,” a disposable doctrine. That they did even though all the evidence bore witness to the doctrine of geocentricity.

When we examined Scripture’s statements about how the heavens go, we found those statements to be far more sophisticated than man’s cursory reading of the text. We logically derived from first principles that God created the firmament to protect his creation—particularly his creatures—from certain properties of God’s omnipotence such as his blinding light and fervent heat. Christian scholars, even creationists, still dismiss the firmament as either figurative or mythical. Still, the firmament has been known to astrophysicists since the late nineteenth century, albeit not by that name. Christian scientists have so far refused to recognize said evidence for the firmament primarily because its existence supports the Authorized Scripture and puts the lie to the modern versions. Since the firmament is explained away by quantum mechanics as virtual, that is, as unreal, Christian scientists are also afraid to accept it on the grounds that “God does not play dice,” that is, they have the mistaken idea that God cannot control chance (even though Scripture says, “Time and chance happeneth to all,” in Ecclesiastes 9:11.) It was that God-limiting attitude demonstrated by Christian scientists that turned me to atheism, for it showed that Christian scientists have no imagination and no courage of their convictions. Plainly speaking, such men are neither scientists nor Bible-believing Christians.

We saw that the sun is the ruler of the daytime, which means it rules the entire universe except the earth. When God talked to Job he said that he established the earth to have dominion over the ordinances of heaven. It is the firmament that enforces that dominion. The firmament likewise empowers the sun’s dominion over

the second heaven. All these things Scripture teaches but Christian scholars and scientists do not want to hear them.

When it came to Joshua's long day, we saw that not only does Scripture claim the event to be a real, physical event, but also that historic accounts and folklore from around the world testify that the long day was real and that the local time of day was consistent with mid-morning in Israel. Yet to this day, no Christian scholar is allowed to say so without suffering severe ridicule and ostracism.

As if Joshua's long day was not enough, Hezekiah's sign is equally real history for there, too, we have accounts of the sun setting and coming back up and the sun rising and going back down in locations consistent with late afternoon in Israel. Although such accounts were collected by Bible commentators hundreds of years ago, they are not welcome in any Christian college or seminary today.

We tracked the scientific history of heliocentrism through time and found it to be a pagan doctrine. We also discovered that the Copernican Revolution is founded on humanists' lies. Tracking the fruits of Copernicanism, we find that socialism, communism, evolutionism, and Bible criticism all flourished because of Christianity's rejection of geocentricity. Geocentricity unites the spiritual truths of Scripture with the physical creation of God. It ties together Jesus' death, burial, and resurrection, not just because geocentricity is a theory, but because geocentricity is an integral part of the word of God. Remove geocentricity and the word of God loses its integrity. That is exactly what happened after the Copernican Revolution. Man concluded that if the written word of God cannot be relied upon when it speaks of the creation of God, it cannot be relied upon when it speaks of anything, particularly the Word of God, which is the Lord Jesus Christ. But spiritually perceived, geocentricity is to the realm of nature what the word of God is to the realm of the spirit, namely the manifestation of each's respective power.

Today, professing Bible believers claim that creationism is the prerequisite for any return to the Bible any chance for revival; but according to history, evolution did not take hold on the minds of

men until they were already committed to the abandonment of the authority of Scripture. The Copernican Revolution allowed evolution to emerge into the light from the dark, dank caverns of sociology where it had hibernated since times Babylonian. In the eighteenth century, Bible critics invited sociology back from her well-deserved exile. So creationism cannot be the key doctrine that will turn people to the truths of Scripture. Modern creationists overwhelmingly reject geocentricity with the claim that it is a disposable doctrine at best if not a scriptural doctrine at all.

Since geocentricity is an integral part of Scripture, any man who advocates its removal places himself under the "take away" clause of the condemnation of Revelation 22:18-19—

¹⁸ For I testify unto every man that heareth the words of the prophecy of this book, If any man shall add unto these things, God shall add unto him the plagues that are written in this book:

¹⁹ And if any man shall take away from the words of the book of this prophecy, God shall take away his part out of the book of life, and out of the holy city, and *from* the things which are written in this book.

I do not claim that such people should be executed for heresy or persecuted in this life. There is no capital punishment for anything anyone *does* in the New Testament's age of grace. Indeed, these verses in Revelation 22 are the only curse pronounced in the New Testament. The most severe penalty imposed by man in the New Testament is excommunication. Death penalties are imposed by nominal Christians, which are Christians in name only. As such they take the name of the Lord in vain. There were death penalties for certain crimes in the Old Testament. These were enforced by man, but such penalties were imposed under written law, that is, by the written authority of God. Since the Old Testament laws applied only to the Jews, the death penalties fell only upon the Jews and non-Jewish citizens living among the Jews. The penalties were executed by the Jews themselves.

In the New Testament, the body of Christ, the churches who are to be the light and salt of the earth, rejected what they thought was a minor doctrine in order that each church might not be an impediment to the acceptance of a gospel that preached how to get "saved" but taught no doctrine because "doctrine is too divisive." The pastors and leaders craved the praise of men more than the praise of God.

Today it is to the point that the churches have rejected the words of God. Those claiming to be the Bride of Christ are too far gone to realize that by rejecting the infallible, preserved words of God they have also rejected the Lord Jesus himself, the Word of God. Instead, she thinks she is rich and in need of nothing as is written in Revelation 3:14-22:

¹⁴ And unto the angel of the church of the Laodiceans write; These things saith the Amen, the faithful and true witness, the beginning of the creation of God;

¹⁵ I know thy works, that thou art neither cold nor hot: I would thou wert cold or hot.

¹⁶ So then because thou art lukewarm, and neither cold nor hot, I will spue thee out of my mouth.

¹⁷ Because thou sayest, I am rich, and increased with goods, and have need of nothing; and knowest not that thou art wretched, and miserable, and poor, and blind, and naked:

¹⁸ I counsel thee to buy of me gold tried in the fire, that thou mayest be rich; and white raiment, that thou mayest be clothed, and *that* the shame of thy nakedness do not appear; and anoint thine eyes with eyesalve, that thou mayest see.

¹⁹ As many as I love, I rebuke and chasten: be zealous therefore, and repent.

²⁰ Behold, I stand at the door, and knock: if any man hear my voice, and open the door, I will come in to him, and will sup with him, and he with me.

²¹ To him that overcometh will I grant to sit with me in my throne, even as I also overcame, and am set down with my Father in his throne.

²² He that hath an ear, let him hear what the Spirit saith unto the churches.

That is the state of the church today. She has kicked Jesus out of her life by kicking his word out of the churches under the guise that his word is no longer *relevant*. She has replaced Jesus with material goods, prosperity, and safety; but in so doing she lacks them all, yet does not know it. Her pastors major on “God is love” and claim, “God loves the sinner but hates the sin.” These lying pastors thus give the impression that God will throw the sinner’s sins into the lake of fire and that the sinner will not be thrown into the lake of fire because God “loves” them too much. Nevertheless, Scripture clearly states that the sinner will end up in the lake of fire. Is it any wonder that those who do not teach and preach the whole counsel of God—that is, they withhold the truth, insert lies, and change the clear teachings of Scripture—are cursed and held responsible for all the souls lost in New Testament times. In retrospect they will be recognized as cowards; afraid of what the world might say or do to them; fearing men more than God.

These are the fruits of the Copernican Revolution: lies, lies, and more lies. It is time for truth.

APPENDIX A

ON THE HEBREW WORD, *MOWT*

This appendix presents the conclusion of an intensive word study on the Hebrew word, *mowt*, which is applied in the Old Testament to describe the motion of the earth or world.

The first step in the study was to compile a list of words that describe any type of motion for the earth. These are listed in Table 1, where the first column gives a transliteration of the Hebrew or Greek word; the second column gives the translation as given in the Authorized Version; the third column gives the references where that word occurs in the Bible; and the fourth column refers to the notes at the end of the table. If the reference in column three is underscored, then the verse refers to the world, otherwise it refers to the earth. Of all the entries in the table, the only word that is applied negatively to the earth is the Hebrew verb *mowt*.

The second step in the study undertook a concordant study in which every occurrence of the Hebrew word *mowt* in non-earth/world passages was examined. These occurrences are listed in Table 2. (Actually, the concordant study examined all of the Hebrew and Greek words listed in Table 1, but only for *mowt* does it prove to be significant.) In Table 2, the English translation of *mowt* is bolded. As can readily be seen, except for the subtle shades of meaning inherent in the different words used to translate *mowt*, all occurrences could grossly be translated into English with the word "move." In fact, if *mowt* is not the Hebrew equivalent of "move," then we are left with the dilemma that there is no Hebrew word equivalent to the English word "move."

The types of motions that are allowed the earth according to Table 1 are all oscillatory or vibratory motions. These are not synonymous with the English word "move" although they can be described by the word "move." Technically, they are different

forms of motion. Thus the word, "shake," can be described as "moving back and forth." To describe "shake" in terms of "move" illustrates the weakness of trying to equate "move" with the allowed oscillatory motions, for describing "shake" as to "move back and forth" does naught but hint at the truth inherent in the word "shake".

TABLE 1
Motion Words Applied To the Earth

<i>ga'ash</i>	shake	II Sa 22:8; Psalm 18:7	1
<i>chiyl</i>	fear	I Ch 16:30; Psalm 96:9	2
	tremble	Psalm 97:4; 114:7	
<i>kuwn</i>	establish	Psalm 24:2; <u>96:10</u> ; 119:90; Is 45:18 <u>Jer 10:12, 51:15</u>	
	stable	<u>I Ch 16:30</u>	
	stablish	<u>Psalm 93:1</u>	
<i>muwg</i>	dissolved	Psalm 75:3	
	melt	Psalm 46:6	
<i>mowt</i> (verb)	be out of course	Psalm 82:5	3
	be (re-) moved	<u>I Ch 16:30</u> ; <u>Psalm 93:1</u> ; <u>96:10</u> ; Psalm 104:5	
	shook	Psalm 60:2	4
<i>mowt</i> (noun)	moved exceedingly	Is 24:19	
<i>muwr</i>	remove	Psalm 46:2	
<i>nuwd</i>	remove	Is 24:20	
<i>nawt</i>	be moved	Psalm 99:1	5
<i>nuwa</i>	reel to and fro	Is 24:20	
<i>naphal</i>	to fall	Is 24:20	
<i>amad</i>	abide	Psalm 119:90; Ec 1:4	
<i>parar</i>	clean dissolved	Is 24:19	6

<i>quwm</i>	rise	Is 24:20 (negative)	
<i>ragaz</i>	disquiet	Pr 30:21	
	quake	I Sa 14:15; Joel 2:10	
	shaketh	Jb 9:6	
	tremble	Psalm 77:18; Is 14:16	
<i>ra'ad</i>	tremble	Psalm 104:32	
<i>ra'a</i>	break	Is 24:19	
<i>ra'ash</i> (verb)	(re-) move	Is 13:13; Jer 49:21; 50:46	
	(make to) shake	Psalm 68:8; 77:18; Hag 2:6 & 21 Is 24:18; Joel 3:16	7
	(make to) tremble	Jg 5:4; Jer 10:10	
		II Sa 22:8; Psalm 18:7; Psalm 60:2;	1 4
<i>ra'ash</i> (noun)	earthquake	I Ki 19:11(twice) & 12; Is 29:6; Am 1:1; Zec 14:5	
<i>saleuo</i>	shook	He 12:26	
<i>seismos</i>	earthquake	Mt 24:7; 27:45; 28:2; Mk 13:8; Lu 21:11; Ae 16:26; Re 6:12; 8:5; 11:13(twice) & 19; 16:18(twice)	
<i>seio</i>	quake	Mt 27:51	
	shake	Heb 12:26	

Notes to Table 1

1. II Samuel and Psalm 18 are two occurrences of the same psalm.
2. *Chiyil* is the root word for "circle" in Hebrew but has extremely wide application.
3. Here this word is applied to the foundations of the earth.
4. Psalm 60:2 refers to the land in its immediate context and to the judgment in its greater context.
5. This is the only occurrence of this word in the Bible.
6. Also applied to the breaking of commandments, contracts, plans, etc.

7. Isaiah 24:18 applies to the earth's foundations.

TABLE 2

Scriptures Using *Mowt* in Non-earth References

Leviticus 25:35 — And if thy brother be waxen poor, and **fallen in decay** with thee; then thou shalt relieve him: yea, though he be a stranger, or a sojourner; that he may live with thee.

Deuteronomy 32:35 — To me belongeth vengeance, and recompence; their foot shall **slide** in due time: for the day of calamity is at hand, and the things that shall come upon them make haste.

Job 41:23 — The flakes of his flesh are joined together: they are firm in themselves; they cannot be **moved**.

Psalm 10:6 — He hath said in his heart, I shall not be **moved**: for I shall never be in adversity.

Psalm 13:4 — Lest mine enemy say, I have prevailed against him; and those that trouble me rejoice when I am **moved**.

Psalm 15:5 — He that putteth not out money to usury, nor taketh reward against the innocent. He that doeth these things shall never be **moved**.

Psalm 16:8 — I have set the LORD always before me: because he is at my right hand, I shall not be **moved**.

Psalm 17:5 — Hold up my goings in thy paths, that my footsteps **slip** not.

Psalm 21:7 — For the king trusteth in the LORD, and through the mercy of the most High he shall not be **moved**.

Psalm 30:6 — And in my prosperity I said, I shall never be **moved**.

Psalm 38:16 — For I said, Hear me, lest otherwise they should rejoice over me: when my foot **slippeth**, they magnify themselves against me.

Psalm 46:2, 5 & 6 — Therefore will not we fear, though the earth be removed, and though the mountains be **carried** into the midst of the sea... God is in the midst of her; she shall not be **moved**: God shall help

her, and that right early. The heathen raged, the kingdoms were **moved**: he uttered his voice, the earth melted.

Psalm 55:3 — Because of the voice of the enemy, because of the oppression of the wicked: for they **cast** iniquity upon me, and in wrath they hate me.

Psalm 55:22 — Cast thy burden upon the LORD and he shall sustain thee: he shall never suffer the righteous to be **moved**.

Psalm 60:2 — Thou hast made the earth to tremble; thou hast broken it: heal the breaches thereof; for it **shaketh**.

Psalm 62:2 — He only is my rock and my salvation; he is my defence; I shall not be greatly **moved**.

Psalm 62:6 — He only is my rock and my salvation; he is my defence; I shall not be **moved**.

Psalm 66:9 — Which holdeth our soul in life, and suffereth not our feet to be **moved**.

Psalm 94:18 — When I said, My foot **slippeth**; thy mercy, O LORD, held me up.

Psalm 112:6 — Surely he shall not be **moved** for ever: the righteous shall be in everlasting remembrance.

Psalm 121:3 — He will not suffer thy foot to be **moved**: he that keepeth thee will not slumber.

Psalm 125:1 — They that trust in the LORD shall be as mount Zion which cannot be **removed**, but abideth for ever.

Psalm 140:10 — Let burning coals **fall** upon them: let them be cast into the fire; into deep pits, that they rise not up again.

Proverbs 10:30 — The righteous shall never be **removed**: but the wicked shall not inhabit the earth.

Proverbs 12:3 — A man shall not be established by wickedness: but the root of the righteous shall not be **moved**.

Proverbs 24:11 — If thou forbear to deliver them that are drawn unto death, and those that are **ready** to be slain.

Proverbs 25:26 — A righteous man **falling down** before the wicked is as a troubled fountain, and a corrupt spring.

Proverbs 31:6 — Give strong drink unto him that is **ready** to perish, and wine unto those that be of heavy hearts.

Isaiah 40:20 — He that is so impoverished that he hath no oblation chooseth a tree that will not rot; he seeketh unto him a cunning workman to prepare a graven image, that shall not be **moved**.

Isaiah 41:7 — So the carpenter encouraged the goldsmith, and he that smootheth with the hammer him that smote the anvil, saying, It is ready for the sodering: and he fastened it with nails; that it should not be **moved**.

Isaiah 54:10 — For the mountains shall depart, and the hills be **removed**; but my kindness shall not depart from thee, neither shall the covenant of peace be **removed**, saith the LORD that hath mercy on thee.

***Mowl* Used as a Noun**

Numbers 4:10 — And they shall put it and all the vessels thereof within a covering of badgers' skins, and shall put it **upon a bar**.

Numbers 4:12 — And they shall take all the instruments of the ministry, wherewith they minister in the sanctuary, and put them in a cloth of blue, and cover them with a covering of badgers' skins, and shall put them on a **bar**.

Numbers 13:23 — And they came unto the brook of Eshcol, and cut down from thence a branch with one cluster of grapes, and they bare it between them upon a **staff**; and they brought of the pomegranates, and of the figs.

Nahum 1:13 — For now will I break this **yoke** from off thee, and will burst thy bonds in sunder.

This was the result of the study that led me to the conclusion that the Bible was probably geostatic. Translations that map a word in one language directly to a word in another language are useless; any multilingual person knows that.

APPENDIX B

SUNRISE/SUNSET PASSAGES

The following is a list of Bible verses which describe the sun as either rising or setting; or as being up or down.

- To set/go down:** Gen 15:12 & 17; 28:11; Ex 17:12; 22:26;
De 11:30; 16:6; 24:13 & 15; Josh 1:4; 10:27;
Jg 14:18; 19:14; 2Sa 2:24; 1Ki 22:26;
2Chr 18:34; Ps 104:19; Ecc 1:5; Isa 60:20;
Jer 15:9; Dn 6:14; Am 8:9; Mic 3:6; Mk 1:32;
Lu 4:40; Eph 4:26.
- Be risen:** Ge 19:23; 32:31; Ex 22:3; Nu 2:3; Jos 12:1;
Jb 9:7; Ps 50:1; 104:22; 113:3; Ecc 1:5; Is 41:25;
45:6; 59:19; Jon 4:8; Na 3:17; Mal 1:11; 4:2;
Mt 5:45; Mk 16:2; Jas 1:11.
- Sunrising:** Nu 21:11; 34:15; De 4:41 & 47; Jos 1:15; 13:5;
19:12, 27, & 34; Jg 20:43; 2 Sa 23:4.
- Is down:** Le 22:7; De 23:11; Jos 8:29; 2Sa 3:35.
- Is up:** Jg 8:13; 9:33; Mt 13:6; Mk 4:6.
- Under the sun:** Ecc 1:3, 9, 14; 2:11, 17, 18, 19, & 20; 3:16;
4:1, 3, 7, & 15; 5:13 & 18; 6:1, 5, & 12;
8:9, 15(twice), & 17; 9:3, 6, 9(twice), 11, & 13; 10:5.

The above list has 94 references specifying either a position or motion of the sun. In all, there are 162 direct references to the sun in the Holy Bible. This means that 58% of all references to the sun in Scripture describe the sun as moving or in a particular place. The remaining 42% have nothing at all to say about the motion or spatial position of the sun.

APPENDIX C

ALL SIGNIFICANT GEOCENTRIC SCRIPTURES

GENESIS

Gen 1:2 "And the earth was without form, and void; and darkness was upon the face of the deep. And the Spirit of God moved upon the face of the waters."

The following establishes the geocentric import of this verse. It stems from a letter that appeared in *The Biblical Astronomer*, no. 62, p. 17-18, 1992 which started out with, "I have always wondered why in Genesis 1:2, in the midst of creating, it says, 'And the Spirit of God moved upon the face of the waters.'" The conclusion is that God's spirit comes to us, either in part, as in the Old Testament, or in full, as in the New Testament. The Holy Ghost speaks only of Christ, who came to us in the flesh. The letter concluded with: "As it is Jesus Christ who does the moving and the earth remains stationary, so the sun goes around the earth.

"The earth neither moves nor spins!

"In Malachi 3:6 it says: 'For I am the Lord, I change not.' It implies that we do the changing. So God is saying that he does the moving and the earth remains stationary. It doesn't make sense that the earth would be still for three days and then begin to move." This line of reasoning makes evident a good point. Since it was the Spirit which moved on the face of the waters, then there is no rotation evident on the waters' part and, by implication, no rotation on the part of the earth, either.

Gen 1:5 "And God called the light Day, and the darkness he called Night. And the evening and the morning were the first day."

"And the evening ... day" is geocentric because the perspective is that seen on earth. Another pro-geocentric point is "What did the earth orbit on the first three days of creation?"

Gen 1:14 "And God said, Let there be lights in the firmament of the heaven to divide the day from the night; and let them be for signs, and for seasons, and for days, and years:"

Geocentric: If the earth circles the sun and the sun isn't created until the fourth day, then what did the earth go around for the first three days?

Gen 1:16 "And God made two great lights; the greater light to rule the day, and the lesser light to rule the night: he made the stars also."

For geocentric import see v. 18.

Gen 1:18 "And to rule over the day and over the night, and to divide the light from the darkness: and God saw that it was good."

Geocentric: If the earth revolves around the sun, then the night, which is the cone of darkness which is the shadow of the earth, would also orbit the sun and so the sun would also rule the night (kinematically).

Gen 7:11 "In the six hundredth year of Noah's life, in the second month, the seventeenth day of the month, the same day were all the fountains of the great deep broken up, and the windows of heaven were opened."

Windows: The windows of heaven relate to the open firmament (1:20). See, for example, the "shut up" of Lu. 4:25. The reference to the windows of heaven has a weak geocentric significance.

Gen 7:20 "Fifteen cubits upward did the waters prevail; and the mountains were covered."

Geocentric. This is global, so according to this the earth is at the origin of a cosmic reference frame, one chosen by God. Also, in scripture, "up" is north, "down" is south, picking Jerusalem as special.

Gen 19:15 "And when the morning arose, then the angels hastened Lot, saying, Arise, take thy wife, and thy two daughters, which are here; lest thou be consumed in the iniquity of the city."

Geocentric. The morning did the rising, the earth did not turn towards it.

Gen 19:23 "The sun was risen upon the earth when Lot entered into Zoar." Also compare with Mk. 16:9.

Here the word "earth" is used to refer to a country, to land, not to the globe. This has ramifications against the flat earth.

Gen 28:11 "And he lighted upon a certain place, and tarried there all night, because the sun was set; and he took of the stones of that place, and put them for his pillows, and lay down in that place to sleep."

Gen 28:12 "And he dreamed, and behold a ladder set up on the earth, and the top of it reached to heaven: and behold the angels of God ascending and descending on it."

This verse is geocentric in implication, even though it is a dream. After all, the earth is footstool to the throne of God, and footstools don't move relative to the throne. The ladder could only be steady if the earth neither rotated nor orbited the sun at 30 km/sec. Also see Jn. 1:51; Zec. 10:12; and Isa. 14:13; the ladder is Christ. Jn. 6:62.

Gen 28:17 "And he was afraid, and said, How dreadful is this place! this is none other but the house of God, and this is the gate of heaven."

For geocentric application see the note to verse 12.

Gen 32:24 "And Jacob was left alone; and there wrestled a man with him until the breaking of the day."

The Hebrew for "breaking of the day" literally is "ascending of the morning," a geostatic idiom.

Gen 32:31 "And as he passed over Penuel **the sun rose** upon him, and he halted upon his thigh."

EXODUS

Exo 17:12 "But Moses' hands were heavy; and they took a stone, and put it under him, and he sat thereon; and Aaron and Hur stayed up his hands, the one on the one side, and the other on the other side; and his hands were steady until **the going down of the sun.**"

Exo 17:14 "And the LORD said unto Moses, Write this for a memorial in a book, and rehearse it in the ears of Joshua: for I will utterly put out the remembrance of Amalek **from under heaven.**"

Exo 22:3 "If **the sun be risen** upon him, there shall be blood shed for him; for he should make full restitution; if he have nothing, then he shall be sold for his theft."

LEVITICUS

Lev 22:7 "And when **the sun is down**, he shall be clean, and shall afterward eat of the holy things; because it is his food."

GEOCENTRIC: "sun is down." On the cross, Jesus was unclean unto his death, having taken our sins upon him. Today we are baptised into his death (Rom. 6:3) and so cleansed the evening of his burial (note the time of day in Mat. 27:57 v.f.). See Ac. 10:11 v.f.

Lev 26:19 "And I will break the pride of your power; and I will make your heaven as iron, and your earth as brass:"

If the physics on the scale of the earth (the so-called "local physics") were to have slightly altered values for any or all of the gravitational constant, the speed of light, or Planck's constant, this could literally come true as a side effect of the **firmament**. Figuratively, of course, the implication is that God will shut up the resources of heaven such as rain and answer to prayer.

NUMBERS

Num 2:3 "And on the east side toward the **rising of the sun** shall they of the standard of the camp of Judah pitch throughout their armies: and Nahshon the son of Amminadab shall be captain of the children of Judah."

Num 10:35 "And it came to pass, when the ark set forward, that Moses said, **Rise up, LORD**, and let thine enemies be scattered; and let them that hate thee flee before thee."

Resurrection theme. For geocentric import note that is the word "rise" when applied to the sun is not literal, then how can one insist that it is literal in contexts such as this and in Mal. 4:2.

Num 34:15 "The two tribes and the half tribe have received their inheritance on this side Jordan near Jericho eastward, **toward the sunrising.**"

DEUTERONOMY

Deu 2:25 "This day will I begin to put the dread of thee and the fear of thee upon the nations that are under the whole heaven, who shall hear report of thee, and shall tremble, and be in anguish because of thee."

The geocentric import of this verse lies in the implication that the earth is central in the phrase "under the whole heaven."

Deu 4:11 "And ye came near and stood under the mountain; and the mountain burned with fire unto the midst of heaven, with darkness, clouds, and thick darkness."

This implies geocentricity. But some may argue that this could refer to the middle layer of the atmosphere. However, this view runs into trouble when arguing that heaven is the atmosphere and not all of space: it minimizes the Lordship of God.

Deu 4:41 "Then Moses severed three cities on this side Jordan toward the **sun rising.**"

Deu 4:47 "And they possessed his land, and the land of Og king of Bashan, two kings of the Amorites, which were on this side Jordan toward the **sun rising.**"

Deu 7:24 "And he shall deliver their kings into thine hand, and thou shalt destroy their name from **under heaven**: there shall no man be able to stand before thee, until thou have destroyed them."

"Under heaven signifies the earth is central to heaven, thus geocentric.

Deu 9:14 "Let me alone, that I may destroy them, and blot out their name from **under heaven**: and I will make of thee a nation mightier and greater than they."

Deu 11:30 "Are they not on the other side Jordan, by the way where **the sun goeth down**, in the land of the Canaanites, which dwell in the champaign over against Gilgal, beside the plains of Moreh?"

Deu 16:6 "But at the place which the LORD thy God shall choose to place his name in, there thou shalt sacrifice the passover at even, **at the going down of the sun**, at the season that thou camest forth out of Egypt."

Deu 18:15 "The LORD thy God will raise up unto thee a Prophet from the midst of thee, of thy brethren, like unto me; unto him ye shall hearken;"

The geocentric import lies in the phrase "raise up." The resurrection is in scope and for that the word "raise" is to be taken literally. Since Mal. 4:2 couples the rising of the sun with the rising of the Son, the usage here requires that the raising of the sun be literal, not figurative. (More at Mal. 4:2.)

Deu 18:18 "I will raise them up a Prophet from among their brethren, like unto thee, and will put my words in his mouth; and he shall speak unto them all that I shall command him."

See note to v. 15 for geocentric import.

Deu 23:11 "But it shall be, when evening cometh on, he shall wash himself with water: and when **the sun is down**, he shall come into the camp again."

The geocentric implications is due to the fact that the earth is presented as the frame of reference. Also, the context of sunrise and sunset verses is in evidence.

Deu 24:5 "When a man hath taken a new wife, he shall not go out to war, neither shall he be charged with any business: but he shall be free at home one year, and shall **cheer up** his wife which he hath taken."

That is, orient her to heaven. A weak geocentric verse.

Deu 24:13 "In any case thou shalt deliver him the pledge again **when the sun goeth down**, that he may sleep in his own raiment, and bless thee: and it shall be righteousness unto thee before the LORD thy God."

Deu 24:15 "At his day thou shalt give him his hire, **neither shall the sun go down upon it**; for he is poor, and setteth his heart upon it: lest he cry against thee unto the LORD, and it be sin unto thee."

Deu 25:19 "Therefore it shall be, when the LORD thy God hath given thee rest from all thine enemies round about, in the land which the LORD thy God giveth thee for an inheritance to possess it, that thou shalt blot out the remembrance of Amalek **from under heaven**; thou shalt not forget it."

Deu 26:15 "**Look down** from thy holy habitation, **from heaven**, and bless thy people Israel, and the land which thou hast given us, as thou swarest unto our fathers, a land that floweth with milk and honey."

The geocentric implication lies in that God looks down from heaven, signifying that the earth is everywhere down from heaven so that it is in a central position.

Deu 29:20 "The LORD will not spare him, but then the anger of the LORD and his jealousy shall smoke against that man, and all the curses that are written in this book shall lie upon him, and the LORD shall blot out his name **from under heaven**."

Deu 30:4 "If any of thine be driven out unto the **outmost parts of heaven**, from thence will the LORD thy God gather thee, and from thence will he fetch thee."

The use of the word "outmost" implies that heaven is bounded. To be driven to the outmost parts of heaven hints of space travel.

Deu 30:12 "It is not in heaven, that thou shouldest say, Who shall **go up for us to heaven**, and bring it unto us, that we may hear it, and do it?"

For geocentric impact see note to Psa. 24:3.

JOSHUA

Josh 1:4 "From the wilderness and this Lebanon even unto the great river, the river Euphrates, all the land of the Hittites, and unto the great sea **toward the going down of the sun**, shall be your coast."

Josh 1:15 "Until the LORD have given your brethren rest, as he hath given you, and they also have possessed the land which the LORD your God giveth them: then ye shall return unto the land of your possession, and enjoy it, which Moses the LORD'S servant gave you on this side Jordan **toward the sunrising**."

Josh 2:11 "And as soon as we had heard these things, our hearts did melt, neither did there remain any more courage in any man, because of you: for the LORD your God, **he is God in heaven above, and in earth beneath**."

Josh 8:29 "And the king of Ai he hanged on a tree until eventide: and as soon as the sun was down, Joshua commanded that they should take his carcase down from the tree, and cast it at the entering of the gate of the city, and raise thereon a great heap of stones, that remaineth unto this day."

For geocentric import see note to Deu. 23:11.

Josh 10:12 "Then spake Joshua to the LORD in the day when the LORD delivered up the Amorites before the children of Israel, and he said in the sight of Israel, Sun, stand thou still upon Gibeon; and thou, Moon, in the valley of Ajalon."

Although this verse is frequently quoted as geocentric, it is not truly authoritative. Joshua spake as a man (v. 14, "voice of a man") and so could speak phenomenologically. The true geocentric verse is verse 13.

Josh 10:13 "And the sun stood still, and the moon stayed, until the people had avenged themselves upon their enemies. Is not this written in the book of Jasher? So the sun stood still in the midst of heaven, and hasted not to go down about a whole day."

This is a key geocentric verse. See chapter 6, "Joshua's Long Day" for a comprehensive treatise.

Josh 10:27 "And it came to pass **at the time of the going down of the sun**, that Joshua commanded, and they took them down off the trees, and cast them into the cave wherein they had been hid, and laid great stones in the cave's mouth, which remain until this very day."

Josh 12:1 "Now these are the kings of the land, which the children of Israel smote, and possessed their land on the other side Jordan **toward the rising of the sun**, from the river Arnon unto mount Hermon, and all the plain on the east."

Josh 13:5 "And the land of the Giblites, and all Lebanon, **toward the sunrising**, from Baalgad under mount Hermon unto the entering into Hamath."

Josh 19:12 "And turned from Sarid eastward **toward the sunrising** unto the border of Chislothtabor, and then goeth out to Daberath, and goeth up to Japhia."

Josh 19:27 "And turneth toward the sunrising to Bethdagon, and reacheth to Zebulun, and to the valley of Jiphthabel toward the north side of Bethemek, and Neiel, and goeth out to Cabul on the left hand,"

Josh 19:34 "And then the coast turneth westward to Aznothtabor, and goeth out from thence to Hukkok, and reacheth to Zebulun on the south side, and reacheth to Asher on the west side, and to Judah upon Jordan **toward the sunrising**."

JUDGES

Judg 5:31 "So let all thine enemies perish, O LORD: but let them that love him be **as the sun when he goeth forth in his might**. And the land had rest forty years."

Judg 8:13 "And Gideon the son of Joash returned from battle **before the sun was up**,"

Judg 9:33 "And it shall be, that in the morning, **as soon as the sun is up**, thou shalt rise early, and set upon the city: and, behold, when he and the people that is with him come out against thee, then mayest thou do to them as thou shalt find occasion."

Judg 13:20 "For it came to pass, when the flame went up toward heaven from off the altar, that the angel of the LORD ascended in the flame of the altar. And Manoah and his wife looked on it, and fell on their faces to the ground."

Generally speaking, all "up" and "down" references are weakly geocentric in that they indicate a coordinate system which is anchored to either the center of the earth or a direction measured radially from the surface of the earth. This passage is stronger than usual in that not only the flame went up, but also the angel went up all the way to heaven.

Judg 14:18 "And the men of the city said unto him on the seventh day **before the sun went down**, What is sweeter than honey? and what is stronger than a lion? And he said unto them, If ye had not plowed with my heifer, ye had not found out my riddle."

Judg 19:9 "And when the man rose up to depart, he, and his concubine, and his servant, his father in law, the damsel's father, said unto him, Behold, now **the day draweth toward evening**, I pray you tarry all night: behold, **the day groweth to an end**, lodge here, that thine heart may be merry; and to morrow get you early on your way, that thou mayest go home."

Judg 19:14 "And they passed on and went their way; and **the sun went down** upon them when they were by Gibeah, which belongeth to Benjamin."

Judg 20:43 "Thus they enclosed the Benjamites round about, and chased them, and trode them down with ease over against Gibeah **toward the sunrising**."

I SAMUEL

1 Sam 2:8 "He **raiseth up the poor** out of the dust, and **lifteth up the beggar** from the dunghill, to set them among princes, and **to make them inherit the throne of glory**: for the pillars of the earth are the Lord's, and he hath set the world upon them."

1 Sam 9:26 "And they arose early: and it came to pass about the spring of the day, that Samuel called Saul to the top of the house, saying, Up, that I may send thee away. And Saul arose, and they went out both of them, he and Samuel, abroad."

II SAMUEL

2 Sam 3:35 "And when all the people came to cause David to eat meat while it was yet day, David sware, saying, So do God to me, and more also, if I taste bread, or ought else, **till the sun be down**."

2 Sam 23:4 "And he shall be as the light of the morning, **when the sun riseth**, even a morning without clouds; as the tender grass springing out of the earth by clear shining after rain."

I KINGS

1 Ki 22:36 "And there went a proclamation throughout the host **about the going down of the sun**, saying, Every man to his city, and every man to his own country."

II KINGS

2 Ki 19:30 "And the remnant that is escaped of the house of Judah shall yet again take root downward, and **bear fruit upward**."

"... bear fruit upward" - rapture.

2 Ki 20:9 "And Isaiah said, This sign shalt thou have of the LORD, that the LORD will do the thing that he hath spoken: **shall the shadow go forward ten degrees, or go back ten degrees?**"

2 Ki 20:10 "And Hezekiah answered, It is a light thing for the shadow to go down ten degrees: nay, but **let the shadow return backward ten degrees**."

2 Ki 20:11 "And Isaiah the prophet cried unto the LORD: and **he brought the shadow ten degrees backward**, by which it had gone down in the dial of Ahaz."

2 Ki 21:13 "And I will stretch over Jerusalem the line of Samaria, and the plummet of the house of Ahab: and I will wipe Jerusalem as a man wipeth a dish, wiping it, and turning it upside down."

Cf. note to Amos 7:7.

I CHRONICLES

1 Chr 16:30 "Fear before him, all the earth: **the world also shall be stable, that it be not moved.**"

Geocentric: Psa. 96:10. Compare Psa. 93:1. Note future tense.

1 Chr 21:16 "And David lifted up his eyes, and saw the angel of the LORD stand between the earth and the heaven, having a drawn sword in his hand stretched out over Jerusalem. Then David and the elders of Israel, who were clothed in sackcloth, fell upon their faces."

Geocentric because of the implication of immobility between earth and heaven.

2 Chr 18:34 "And the battle increased that day: howbeit the king of Israel stayed himself up in his chariot against the Syrians until the even: and about **the time of the sun going down** he died."

2 Chr 32:24 "In those days Hezekiah was sick to the death, and prayed unto the LORD: and he spake unto him, and he gave him a sign."

Geocentric: Hezekiah's sign.

NEHEMIAH

Neh 4:21 "So we laboured in the work: and half of them held the spears **from the rising of the morning** till the stars appeared."

Heb. for "stars appeared" can also mean "till the stars went forth."

JOB

Job 7:17 "What is man, that thou shouldest magnify him? and that thou shouldest set thine heart upon him?"

The geocentricity of this verse lies in the fact that this puts man at the focus of God's attention.

Job 9:6 "Which shaketh the earth out of her place, and the pillars thereof tremble."

Job 9:7 "Which commandeth the sun, and it riseth not; and scaleth up the stars."

Geocentric: note that the sun is commanded, not the earth.

Job 11:8 "It is as high as heaven; what canst thou do? deeper than hell; what canst thou know?"

Implicitly geocentric because heaven is "up" and hell is "down" from all terrestrial points.

Job 22:12 "Is not God in the **height of heaven?** and behold the **height of the stars, how high they are!**"

Job 22:14 "Thick clouds are a covering to him, that he seeth not; and he **walketh in the circuit of heaven.**"

Heaven has a circuit, not the earth.

Job 25:3 "Is there any number of his armies? and **upon whom doth not his light arise?**"

"His light arise" is a double entendre: the sun is geocentric by implication, and is connected with the Son (Psa. 19:1-6).

Job 26:7 "He stretcheth out the north over the empty place, and hangeth the earth upon nothing."

This verse can only be true if the earth is at the dynamic center of the universe. See note to Gen. 1:2.

Job 26:9 "He holdeth back the face of his throne, and spreadeth his cloud upon it."

See note to Isa. 66:1 for geocentric import.

Job 28:24 "For he looketh to the ends of the earth, and **seeth under the whole heaven;**"

In order to be "under," there has to be a center. The earth is in the context, hence geocentric.

Job 37:3 "**He directeth it under the whole heaven,** and his lightning unto the ends of the earth."

Job 37:18 "Hast thou with him **spread out the sky,** which is strong, and as a molten looking glass?"

Job 38:12 "Hast thou commanded the morning since thy days; and caused the **dayspring** to know his place;"

The dayspring is Jesus Christ and the reference is geocentric. See Luke 1:78 and the note there.

Job 38:13 "That it might take hold of the ends of the earth, that the wicked might be shaken out of it?"

"It" is the dayspring, Na. 3:17; Lu. 1:79; Jas. 1:11. The last it in the verse is the earth.

Job 38:33 "Knowest thou the **ordinances of heaven**? canst thou **set the dominion thereof in the earth**?"

The astral bodies were made for earth, to give light upon it, for the measurement of time, and for seasons. As such, the dominion over the ordinances of heaven must be on earth, the body for which they were created. This is the reverse of astrology which sets the dominion of the earth to the stars. Indeed, modern science also sets the stars—the sun in particular—to rule the earth. Geocentricity is how the dominion of the ordinances of heaven is set in the earth. No man can do that; indeed, it is hard for modern man to even accept its truth.

Job 41:11 "Who hath prevented me, that I should repay him? whatsoever is **under the whole heaven** is mine."

Under the whole heaven has a geocentric sense in that it positions the earth at the center.

PSALMS

Psa 8:1 "To the chief Musician upon Gittith, A Psalm of David. O LORD our Lord, how excellent is thy name in all the earth! who hast set thy glory above the heavens."

Geocentric: implies that the frame of reference is outside the universe. "Above the heavens" runs contrary to an infinite universe.

Psa 8:4 "What is man, that thou art mindful of him? and the son of man, that thou visitest him?"

For geocentric import see note to Job 7:17.

Psa 19:5 "Which is as a bridegroom **coming out of his chamber**, and rejoiceth as a strong man to run a race."

The subject is the sun.

Psa 19:6 "His going forth is from the end of the heaven, and his circuit unto the ends of it; and there is nothing hid from the heat thereof."

The subject is the sun.

Psa 24:3 "Who shall **ascend into the hill of the LORD**? or who shall stand in his holy place?"

The ascension to heaven, or here the hill of the Lord, coupled with descending to hell is geocentric. It puts the earth in a special place between the two because the earth is always the starting point in the context of these references.

Psa 33:9 "For he spake, and it was done; he commanded, and **it stood fast**."

The context is the earth and the world, thus standing fast implies a stationary earth.

Psa 33:13 "The LORD looketh from heaven; he beholdeth all the sons of men."

Geocentric, for a closed (spherical or spheroidal) earth surrounded by heaven.

Psa 37:6 "And he shall bring forth thy righteousness as the light, and thy judgment as the noonday."

Allusion to the motion of the sun.

Psa 46:2 "Therefore will not we fear, **though the earth be removed**, and though the mountains be carried into the midst of the sea;"

The implication is that the earth is not now moving.

Psa 48:2 "Beautiful for situation, the joy of the whole earth, is mount Zion, on the sides of the north, the city of the great King."

The sides of the north are also mentioned in Isa. 14:13. For geocentric impact see Isa. 14:13 note.

Psa 50:1 "A Psalm of Asaph. The mighty God, even the LORD, hath spoken, and called the earth **from the rising of the sun unto the going down thereof**."

Psa 57:3 "He shall send from heaven, and save me from the reproach of him that would swallow me up. Selah. God shall send forth his mercy and his truth."

Geocentric: the earth is at the center of God's plan.

Psa 57:11 "Be thou exalted, O God, above the heavens: let thy glory be above all the earth."

Implies the glory is centered on the earth and thus, by implication, it is geocentric.

Psa 68:4 "Sing unto God, sing praises to his name: extol him that **rideth upon the heavens** by his name JAH, and rejoice before him."

This implies that the heavens move.

Psa 68:33 "To him that **rideth upon the heavens of heavens**, which were of old; lo, he doth send out his voice, and that a mighty voice."

See note to Psalm 68:4.

Psa 75:3 "The earth and all the inhabitants thereof are dissolved: I bear up the pillars of it. Selah."

Psa 78:23 "Though he had commanded the clouds **from above, and opened the doors of heaven**,"

Psa 80:14 "Return, we beseech thee, O God of hosts: **look down from heaven**, and behold, and visit this vine;"

God looking down from heaven implies the earth is in a central position.

Psa 82:5 "They know not, neither will they understand; they walk on in darkness: all **the foundations of the earth are out of course**."

Covered in the text.

Psa 85:11 "Truth shall spring out of the earth; and **righteousness shall look down from heaven**."

Christ is the Truth. The springing out of the earth is the resurrection.

Psa 89:14 "Justice and judgment are the habitation of thy throne: mercy and truth shall go before thy face."

For geocentric import see note to Isa. 66:1.

Psa 89:29 "His seed also will I make to endure for ever, and his throne as the days of heaven."

How can there be days in heaven if earth's rotation marks a day? The verse says that the procession of days of heaven is eternal. Geocentricity says the second heaven rotates once every 24 hours with respect to both the surface of the earth and the third heaven. From that it follows that a day (rotation period) of the third heaven is eternal. Therein lies a problem.

However, note that the context is David's throne (the kingdom of heaven). Thus the verse is to be understood in an earth-bound context, where the procession of days is that produced by the rotation of the second heaven. By placing the time-keeper (the rotation of the second heaven) between the earth and the third heaven, both can regulate their days with a common, synchronized clock.

Psa 93:1 "The LORD reigneth, he is clothed with majesty; the LORD is clothed with strength, wherewith he hath girded himself: **the world also is established, that it cannot be moved.**"

Psa 96:10 "Say among the heathen that the LORD reigneth: **the world also shall be established that it shall not be moved:** he shall judge the people righteously."

Psa 97:2 "Clouds and darkness are round about him: righteousness and judgment are the habitation of his throne."

For geocentric import see note to Isa. 66:1.

Psa 99:1 "The LORD reigneth; let the people tremble: he sitteth between the cherubims; **let the earth be moved.**"

Context is judgment.

Psa 102:19 "For he hath looked down from the height of his sanctuary; **from heaven did the LORD behold the earth;**"

Psa 103:11 "For as the **heaven is high above the earth,** so great is his mercy toward them that fear him."

Indicative of a large universe. The earth appears in a central, symmetric position. Eph. 3:18.

Psa 104:5 "Who laid the foundations of **the earth, that it should not be removed** for ever."

Psa 104:19 "He appointed the moon for seasons: **the sun knoweth his going down.**"

The sun is a type of Jesus. Jesus knew his "going down" (descent to hell) and the implication is that the sun is also aware of the daily rotation of the firmament about the earth.

Psa 104:22 "**The sun ariseth,** they gather themselves together, and lay them down in their dens."

Psa 108:5 "Be thou exalted, O God, above the heavens: and **thy glory above all the earth;**"

Psa 112:4 "Unto the upright there **ariseth light in the darkness**: he is gracious, and full of compassion, and righteous."

The light arises, as in Mal. 4:2, giving this a geocentric tone.

Psa 113:3 "From **the rising of the sun unto the going down of the same** the Lord's name is to be praised."

Psa 113:6 "Who humbleth himself to behold the things that are in heaven, and in the earth!"

It us humbling to God to concern himself with us. The earth is central to his attention here.

Psa 119:90 "Thy faithfulness is unto all generations: thou hast **established the earth, and it abideth.**"

Psa 136:8 "The sun to rule by day: for his mercy endureth for ever:"

The sun is used to navigate throughout the day. For geocentric import see note to Gen. 1:16.

Psa 136:9 "The moon and stars to rule by night: for his mercy endureth for ever."

The moon and stars are used to navigate throughout the night. For geocentric import see note to Gen. 1:16. Note the coregency.

Psa 139:8 "If I **ascend up into heaven**, thou art there: if I **make my bed in hell**, behold, thou art there."

Psa 139:9 "If I take the **wings of the morning**, and dwell in the uttermost parts of the sea;"

Implies the morning moves, not the earth.

Psa 144:3 "LORD, what is man, that thou takest knowledge of him! or the son of man, that thou makest account of him!"

For geocentric import see note to Job 7:17.

Psa 148:13 "Let them praise the name of the LORD: for his name alone is excellent; **his glory is above the earth and heaven.**"

PROVERBS

Prov 14:2 "He that walketh in his **uprightness** feareth the LORD: but he that is perverse in his ways despiseth him."

The geocentricity is implied in the sense that if "uprightness" is not in the center then it is relative to earth only and therefore we'd have no universal uprightness but moral relativism.

Prov 25:3 "The **heaven for height**, and the **earth for depth**, and the heart of kings is unsearchable."

Prov 26:25 "When he speaketh fair, believe him not: for there are seven abominations in his heart."

In his introduction to *De Revolutionibus*, Copernicus justifies heliocentrism by virtue of seven arguments. Each is an abomination according to the Bible.

ECCLESIASTES

Ecc 1:3 "What profit hath a man of all his labour which he taketh **under the sun**?"

Ecc 1:4 "One generation passeth away, and another generation cometh: but the earth abideth for ever."

Ecc 1:5 "The sun also ariseth, and the sun goeth down, and hasteth to his place where he arose."

Ties solar motion to resurrection.

Ecc 1:9 "The thing that hath been, it is that which shall be; and that which is done is that which shall be done: and there is no new thing **under the sun**."

Ecc 1:13 "And I gave my heart to seek and search out by wisdom concerning all things that are done **under heaven**: this sore travail hath God given to the sons of man to be exercised therewith."

Ecc 1:14 "I have seen all the works that are done **under the sun**; and, behold, all is vanity and vexation of spirit."

Ecc 2:3 "I sought in mine heart to give myself unto wine, yet acquainting mine heart with wisdom; and to lay hold on folly, till I might see what was that good for the sons of men, which they should do **under the heaven** all the days of their life."

Ecc 2:11 "Then I looked on all the works that my hands had wrought, and on the labour that I had laboured to do: and, behold, all was vanity and vexation of spirit, and there was no profit **under the sun**."

Ecc 2:17 "Therefore I hated life; because the work that is wrought **under the sun** is grievous unto me: for all is vanity and vexation of spirit."

Ecc 2:18 "Yea, I hated all my labour which I had taken **under the sun**: because I should leave it unto the man that shall be after me."

Ecc 2:19 "And who knoweth whether he shall be a wise man or a fool? yet shall he have rule over all my labour wherein I have laboured, and wherein I have showed myself wise **under the sun**. This is also vanity."

Ecc 2:20 "Therefore I went about to cause my heart to despair of all the labour which I took **under the sun**."

Ecc 2:22 "For what hath man of all his labour, and of the vexation of his heart, wherein he hath laboured **under the sun**?"

Ecc 3:1 "To every thing there is a season, and a time to every purpose **under the heaven**:"

Ecc 3:16 "And moreover I saw **under the sun** the place of judgment, that wickedness was there; and the place of righteousness, that iniquity was there."

Ecc 4:1 "So I returned, and considered all the oppressions that are done **under the sun**; and behold the tears of such as were oppressed, and they had no comforter; and on the side of their oppressors there was power; but they had no comforter."

Ecc 4:3 "Yea, better is he than both they, which hath not yet been, who hath not seen the evil work that is done **under the sun**."

Ecc 4:7 "Then I returned, and I saw vanity **under the sun**."

Ecc 4:15 "I considered all the living which walk **under the sun**, with the second child that shall **stand up** in his stead."

Ecc 5:13 "There is a sore evil which I have seen **under the sun**, namely, riches kept for the owners thereof to their hurt."

Ecc 5:18 "Behold that which I have seen: it is good and comely for one to eat and to drink, and to enjoy the good of all his labour that he taketh **under the sun** all the days of his life, which God giveth him: for it is his portion."

Ecc 6:1 "There is an evil which I have seen **under the sun**, and it is common among men:"

Ecc 6:12 "For who knoweth what is good for man in this life, all the days of his vain life which he spendeth as a shadow? for who can tell a man what shall be after him **under the sun**?"

Ecc 8:9 "All this have I seen, and applied my heart unto every work that is done **under the sun**: there is a time wherein one man ruleth over another to his own hurt."

Ecc 8:15 "Then I commended mirth, because a man hath no better thing **under the sun**, than to eat, and to drink, and to be merry: for that shall abide with him of his labour the days of his life, which God giveth him **under the sun**."

Ecc 8:17 "Then I beheld all the work of God, that a man cannot find out the work that is done **under the sun**: because though a man labour to seek it out, yet he shall not find it; yea farther; though a wise man think to know it, yet shall he not be able to find it."

Ecc 9:3 "This is an evil among all things that are done **under the sun**, that there is one event unto all: yea, also the heart of the sons of men is full of evil, and madness is in their heart while they live, and after that they go to the dead."

Ecc 9:6 "Also their love, and their hatred, and their envy, is now perished; neither have they any more a portion for ever in any thing that is done **under the sun**."

Ecc 9:9 "Live joyfully with the wife whom thou lovest all the days of the life of thy vanity, which he hath given thee **under the sun**, all the days of thy vanity: for that is thy portion in this life, and in thy labour which thou takest **under the sun**."

Ecc 9:11 "I returned, and saw **under the sun**, that the race is not to the swift, nor the battle to the strong, neither yet bread to the wise, nor yet riches to men of understanding, nor yet favour to men of skill; but time and chance happeneth to them all."

Ecc 9:13 "This wisdom have I seen also **under the sun**, and it seemed great unto me:"

Ecc 10:5 "There is an evil which I have seen **under the sun**, as an error which proceedeth from the ruler:"

ISAIAH

Isa 5:14 "Therefore hell hath enlarged herself, and opened her mouth without measure: and their glory, and their multitude, and their pomp, and he that rejoiceth, shall **descend into it**."

Isa 13:5 "They come from a far country, from the end of heaven, even the LORD, and the weapons of his indignation, to destroy the whole land."

The geocentricity in this verse is because the earth is here at the focus of God's attention. Also, this verse indicates that heaven is finite.

Isa 13:10 "For the stars of heaven and the constellations thereof shall not give their light: the **sun shall be darkened in his going forth**, and the moon shall not cause her light to shine."

Isa 13:13 "Therefore I will shake the heavens, and the **earth shall remove out of her place**, in the wrath of the LORD of hosts, and in the day of his fierce anger."

Isa 14:13 "For thou hast said in thine heart, **I will ascend into heaven**, I will exalt my throne **above the stars of God**: I will sit also upon the mount of the congregation, in the sides of the north:"

For geocentric import see note to Psa. 24:3.

Isa 14:14 "I will **ascend above the heights of the clouds**; I will be like the most High."

Isa 21:12 "The watchman said, The **morning cometh**, and **also the night**: if ye will inquire, inquire ye: return, come."

Isa 24:18 "And it shall come to pass, that he who fleeth from the noise of the fear shall fall into the pit; and he that cometh up out of the midst of the pit shall be taken in the snare: for the **windows from on high** are open, and the **foundations of the earth do shake**."

Note the windows (of heaven) are here said to be "from on high."

Isa 24:19 "The earth is utterly broken down, the earth is clean dissolved, the **earth is moved exceedingly**."

Context is tribulation.

Isa 24:20 "The earth shall reel to and fro like a drunkard, and shall be removed like a cottage; and the transgression thereof shall be heavy upon it; and it shall fall, and not rise again."

Context is tribulation.

Isa 24:21 "And it shall come to pass in that day, that the LORD shall punish the host of the **high ones that are on high**, and the kings of the earth upon the earth."

Isa 28:17 "Judgment also will I lay to the line, and righteousness to the plummet; and the hail shall sweep away the refuge of lies, and the waters shall overflow the hiding place."

Isa 38:1 "In those days was Hezekiah sick unto death. And Isaiah the prophet the son of Amoz came unto him, and said unto him, Thus saith the LORD, Set thine house in order: for thou shalt die, and not live."

Verses 1-8 tell of Hezekiah's sign and have geocentric implications (cf. v. 8).

Isa 38:8 "Behold, I will bring again the shadow of the degrees, which is gone down in the sun dial of Ahaz, ten degrees backward. So **the sun returned ten degrees, by which degrees it was gone down.**"

Isa 41:25 "I have raised up one from the north, and he shall come: **from the rising of the sun** shall he call upon my name: and he shall come upon princes as upon mortar, and as the potter treadeth clay."

Isa 45:6 "That they may know from **the rising of the sun**, and from the west, that there is none beside me. I am the LORD, and there is none else."

Hence the rising of the sun is coupled to the knowledge of the Lord. If these motions are apparent instead of real, we know not the Lord.

Isa 45:8 "Drop down, ye heavens, from above, and let the skies pour down righteousness; let the earth open, and let them bring forth salvation, and let righteousness spring up together; I the LORD have created it."

Isa 49:8 "Thus saith the LORD, In an acceptable time have I heard thee, and in a day of salvation have I helped thee: and I will preserve thee, and give thee for a covenant of the people, to **establish the earth**, to cause to inherit the desolate heritages;"

Isa 51:6 "Lift up your eyes to the heavens, and **look upon the earth beneath**: for the heavens shall vanish away like smoke, and the earth shall wax old like a garment, and they that dwell therein shall die in like manner: but my salvation shall be for ever, and my righteousness shall not be abolished."

Isa 55:9 "For as the **heavens are higher than the earth**, so are my ways higher than your ways, and my thoughts than your thoughts."

Isa 59:19 "So shall they fear the name of the LORD from the west, and his glory from **the rising of the sun**. When the enemy shall come in like a flood, the Spirit of the LORD shall lift up a standard against him."

Isa 60:20 "Thy sun shall no more go down; neither shall thy moon withdraw itself: for the LORD shall be thine everlasting light, and the days of thy mourning shall be ended."

Isa 63:15 "Look down from heaven, and behold from the habitation of thy holiness and of thy glory: where is thy zeal and thy strength, the sounding of thy bowels and of thy mercies toward me? are they restrained?"

Isa 66:1 "Thus saith the LORD, The heaven is my throne, and the earth is my footstool: where is the house that ye build unto me? and where is the place of my rest?"

Psa. 89:14 and 97:2 indicate that justice, judgment, and righteousness are the habitation of the throne. These embody moral standards. The earth is here linked with that habitation in the form of the footstool. Thus the habitation of the earth presents the same moral standards. If the earth is viewed as moving, then these standards are seen to "move" with it. This allows for two possible points of view:

- 1) moral standards are universal or
- 2) they are local to the earth.

The second view allows moral relativism, especially if "all is relative." At this point there is a connection with the theory of relativity in physics which, among other things, is designed to account for why the earth "seems" to be standing still at the dynamic center of the universe. Note that the Bible recognizes the issue is one of a standard of rest (see last clause -- compare Ac. 7:49 which reads "what" instead of "where," thus recognizing a yet broader issue). Note also Psa. 82:5.

2 Chr. 9:18 suggests that the footstool was fastened to the throne.

JEREMIAH

Jer 10:11 "Thus shall ye say unto them, The gods that have not made the heavens and the earth, even they shall perish from the earth, and **from under these heavens.**"

Jer 15:9 "She that hath borne seven languisheth: she hath given up the ghost; her sun is gone down while it was yet day: she hath been ashamed and confounded: and the residue of them will I deliver to the sword before their enemies, saith the LORD."

Tribulation reference. The sun, as a type of Christ, signifies light, warmth, hope, and salvation.

Jer 31:35 "Thus saith the LORD, which giveth the sun for a light by day, and the ordinances of the moon and of the stars for a light by night, which divideth the sea when the waves thereof roar; The LORD of hosts is his name:"

For geocentric import see 1 Cor. 15:40.

Jer 51:15 "He hath made the earth by his power, he hath **established the world** by his wisdom, and hath stretched out the heaven by his understanding."

LAMENTATIONS

Lam 3:66 "Persecute and destroy them in anger from **under the heavens** of the LORD."

EZEKIEL

Ezek 1:27 "And I saw as the colour of amber, as the appearance of fire round about within it, from the appearance of his loins even upward, and from the appearance of his loins even downward, I saw as it were the appearance of fire, and it had brightness round about."

The firmament protects those under it from the fire above it.

Ezek 1:28 "As the appearance of the bow that is in the cloud in the day of rain, so was the appearance of the brightness round about. This was the appearance of the likeness of the glory of the LORD. And when I saw it, I fell upon my face, and I heard a voice of one that spake."

Continuation of 1:27.

Ezek 7:7 "The **morning is come** unto thee, O thou that dwellest in the land: the time is come, the day of trouble is near, and not the sounding again of the mountains."

Morning does the moving.

Ezek 7:10 "Behold the day, behold, it is come; the **morning is gone forth**; the rod hath blossomed, pride hath budded."

That is, the morning does the moving.

Ezek 8:3 "And he put forth the form of an hand, and took me by a lock of mine head; and the spirit lifted me up **between the earth and the heaven**, and brought me in the visions of God to Jerusalem, to the door of the inner gate that looketh toward the north; where was the seat of the image of jealousy, which provoketh to jealousy."

Ezek 31:16 "I made the nations to shake at the sound of his fall, when I **cast him down to hell** with them that **descend into the pit**: and all the trees of Eden, the choice and best of Lebanon, all that drink water, shall be comforted **in the nether parts of the earth**."

DANIEL

Dan 4:13 "I saw in the visions of my head upon my bed, and, behold, a watcher and an holy one **came down from heaven**;"

Dan 4:23 "And whereas the king saw a watcher and an holy one **coming down from heaven**, and saying, Hew the tree down, and destroy it; yet leave the stump of the roots thereof in the earth, even with a band of iron and brass, in the tender

grass of the field; and let it be wet with the dew of heaven, and let his portion be with the beasts of the field, till seven times pass over him;"

Dan 6:14 "Then the king, when he heard these words, was sore displeased with himself, and set his heart on Daniel to deliver him: and he laboured till **the going down of the sun** to deliver him."

Dan 8:10 "And it waxed great, even to the host of heaven; and **it cast down some of the host and of the stars to the ground**, and stamped upon them."

AMOS

Amos 7:7 "Thus he showed me: and, behold, the Lord stood upon a wall made by a plumbline, with a plumbline in his hand."

If the earth is rotating, let alone the profusion of other superimposed motions, a plumbline at the Temple, viewed from the mercy seat in the third heaven, would seldom, if ever, point to God's throne with New Jerusalem. Such a line, when seen from the throne, would aimlessly flail about. But in Scripture, this line points to God's throne, thus showing the fixity of the earth with respect to the third heaven. That God's third heaven is fixed, we shall have to take at his word, for only God the creator can supply the reference.

The plumbline, in turn, holds the plummet, a lead ball. In Isa. 28:17 this plumbline over Jerusalem connects Jesus (vss. 9-13) with the righteous on earth. In Am. 7:7 the LORD shows Amos the plumbline of Isa. 28 and prophesies that the promised tribulational desolation (Am. 7:8) "will not again pass by them any more." The "wall" of this verse, upon which stands the LORD, must be the temple wall showing the cosmological heavenly alignment of the place where God puts his name. Zechariah calls attention to this plumbline when prophesying the rebuilding of the temple (Zech. 4:10) and associates the plummet with the cosmic events of Rev. 1 through the seven candles, "for they shall rejoice, and shall see the plummet in the hand of Zerubbabel with those seven; they are the eyes of the LORD, which run to and fro through the whole earth."

The plumbline shows that salvation comes down, as in Psa. 19, to the earth; note the symbolism of the plummet, being made of lead which is considered the basest of metals, residing closest to the earth, represents man who cannot save himself (Eph. 2:8-9). The plumbline points from earth to heaven, (Jesus being the plumbline and our way to heaven,) and it also points from heaven to earth, bringing judgment upon Jerusalem, as we see in 2 Ki. 21:13. Note that the word "line" in 2 Ki. 21:13, Psa. 19, and many other places is a geocentric notion in that it is the geocentric, diurnally rotating heavens that produce the lines.

Amos 7:8 "And the LORD said unto me, Amos, what seest thou? And I said, **A plumbline**. Then said the Lord, Behold, I will set a **plumbline** in the midst of my people Israel: I will not again pass by them any more:"

Cf. note to v. 7.

Amos 8:9 "And it shall come to pass in that day, saith the Lord GOD, that I will **cause the sun to go down at noon**, and I will darken the earth in the clear day:"

JONAH

Jonah 4:7 "But God prepared a worm **when the morning rose** the next day, and it smote the gourd that it withered."

Jonah 4:8 "And it came to pass, when **the sun did arise**, that God prepared a vehement east wind; and the sun beat upon the head of Jonah, that he fainted, and wished in himself to die, and said, It is better for me to die than to live."

MICAH

Micah 3:6 "Therefore night shall be unto you, that ye shall not have a vision; and it shall be dark unto you, that ye shall not divine; and **the sun shall go down** over the prophets, and the day shall be dark over them."

NAHUM

Nahum 3:17 "Thy crowned are as the locusts, and thy captains as the great grasshoppers, which camp in the hedges in the cold day, but **when the sun ariseth** they flee away, and their place is not known where they are."

HABAKKUK

Hab 3:11 "**The sun and moon stood still in their habitation**: at the light of thine arrows they went, and at the shining of thy glittering spear."

ZECHARIAH

Zec 1:11 "And they answered the angel of the LORD that stood among the myrtle trees, and said, We have walked to and fro through the earth, and, behold, **all the earth sitteth still, and is at rest.**"

Zec 1:16 "Therefore thus saith the LORD; I am returned to Jerusalem with mercies: my house shall be built in it, saith the LORD of hosts, and **a line shall be stretched forth upon Jerusalem.**"

Plummet reference.

Zec 2:1 "I lifted up mine eyes again, and looked, and behold a man with a measuring line in his hand."

See note to Am. 7:7 for details and for geocentric import.

Zec 8:12 "For the seed shall be prosperous; the vine shall give her fruit, and the ground shall give her increase, and the heavens shall give their dew; and I will cause the remnant of this people to possess all these things."

The plural use of heavens here indicates a superposition of heavens, the open firmament (heaven) which is the atmosphere, and the firmament which is the stellar heaven. This has geocentric overtones.

Zec 10:12 "And I will strengthen them in the LORD; and they shall walk up and down in his name, saith the LORD."

See Gen. 28:12 note for geocentric import. Jn. 1:51 "... the angels of God ascending and descending upon the Son of man."

MALACHI

Mal 1:11 "For from the rising of the sun even unto the going down of the same my name shall be great among the Gentiles; and in every place incense shall be offered unto my name, and a pure offering: for my name shall be great among the heathen, saith the LORD of hosts."

Mal 4:2 "But unto you that fear my name shall the Sun of righteousness arise with healing in his wings; and ye shall go forth, and grow up as calves of the stall.

For geocentric import note that if the word "rise" when applied to the sun is not literal, then how can one insist that it is literal in contexts such as this and in Num. 10:35? Note, too, that Christ came to us to arise; we did not go to him.

MATTHEW

Mat 5:18 "For verily I say unto you, Till heaven and earth pass, one jot or one tittle shall in no wise pass from the law, till all be fulfilled."

Note that the preservation of Scripture is here tied to the permanence, and indirectly fixity, of the earth. See Psa. 119:89-91 for the connection.

Mat 5:34 "But I say unto you, Swear not at all; neither by heaven; for it is God's throne:"

Cf. note to Isa. 66:1 for geocentric impact.

Mat 5:45 "That ye may be the children of your Father which is in heaven: for he maketh his sun to rise on the evil and on the good, and sendeth rain on the just and on the unjust."

This verse is geocentric because it equates the grace of God with the rising of the sun. People who make the "for he maketh his sun to rise" phrase phenomenological would never do the same to "sendeth the rain" by insisting that we approach the rain instead of the rain approaching us.

Mat 6:10 "Thy kingdom come. Thy will be done in earth, as it is in heaven."

For geocentric import see 1 Cor. 15:40 note.

Mat 13:6 "And when **the sun was up**, they were scorched; and because they had no root, they withered away."

For geocentric impact see note to Deu. 23:11.

Mat 17:15 "Lord, have mercy on my son: for he is a lunatic, and sore vexed: for oftentimes he falleth into the fire, and oft into the water."

Of geocentric import—heliocentrists since at least Kepler have insisted that the moon affords an absolute coordinate system from which to prove that the earth rotates. This may seem like a stretch, but it, at least in part, does explain the violent reaction against geocentricity on the part of most staunchly heliocentric Christians.

Mat 24:31 "And he shall send his angels with a great sound of a trumpet, and they shall gather together his elect from the four winds, from one end of heaven to the other."

The geocentric impact of this verse is that the earth is here at the focus of God's attention.

Mat 27:57 "When the **even was come**, there came a rich man of Arimathaea, named Joseph, who also himself was Jesus' disciple."

The geocentric import lies in that the evening did the "coming."

Mat 28:2 "And, behold, there was a great earthquake: for the angel of the Lord **descended from heaven**, and came and rolled back the stone from the door, and sat upon it."

MARK

Mark 1:32 "And at even, when **the sun did set**, they brought unto him all that were diseased, and them that were possessed with devils."

Mark 4:6 "But when **the sun was up**, it was scorched; and because it had no root, it withered away."

Mark 16:2 "And very early in the morning the first day of the week, they came unto the sepulchre **at the rising of the sun**."

Mark 16:9 "Now when **Jesus was risen** early the first day of the week, he appeared first to Mary Magdalene, out of whom he had cast seven devils."

This verse has geocentric overtones when coupled with Gen. 19:23 which says "The sun was risen upon the earth..." If the expression "sun was risen" in Genesis is not to be taken literally because "science has proven" otherwise, then obviously "Jesus was risen" should not be taken literally because "science has proven" that resurrection from the dead is even more impossible than geocentricity—at least, according to the General Theory of Relativity.

Mark 16:19 "So then after the Lord had spoken unto them, **he was received up into heaven**, and sat on the right hand of God."

Geocentric impact is that straight up leads to the third heaven where God's throne is.

LUKE

Luke 1:78 "Through the tender mercy of our God; whereby the dayspring from on high hath visited us,"

The dayspring does the visiting, thus came he to us. The heliocentric view has us (the world) turning to the dayspring and so "honoring" Christ and so does not confess that Jesus Christ came and rose from the dead.

Luke 4:40 "Now when the sun was setting, all they that had any sick with divers diseases brought them unto him; and he laid his hands on every one of them, and healed them."

Luke 10:15 "And thou, Capernaum, which art exalted to heaven, shalt be thrust down to hell."

Luke 10:18 "And he said unto them, I beheld Satan as lightning fall from heaven."

Implies centrality of the earth unless the atmosphere is meant by "heaven."

Luke 16:17 "And it is easier for heaven and earth to pass, than one tittle of the law to fail."

Jesus attributes greater stability to the text of the scripture than to the heaven and earth. If the earth were not stable, there would be little point in this comparison.

JOHN

John 1:51 "And he saith unto him, Verily, verily, I say unto you, Hereafter ye shall see heaven open, and the angels of God ascending and descending upon the Son of man."

See note to Gen. 28:12 for geocentric context. Also Zech. 10:12.

John 6:16 "And when even was now come, his disciples went down unto the sea,"

Even(ing) does the moving.

John 6:33 "For the bread of God is he which cometh down from heaven, and giveth life unto the world."

John 6:38 "For I came down from heaven, not to do mine own will, but the will of him that sent me."

Earth is central to God's purpose.

John 6:41 "The Jews then murmured at him, because he said, I am the bread which came down from heaven."

John 6:51 "I am the living bread which came down from heaven: if any man eat of this bread, he shall live for ever: and the bread that I will give is my flesh, which I will give for the life of the world."

John 8:23 "And he said unto them, Ye are from beneath; I am from above: ye are of this world; I am not of this world."

John 21:4 "But when the morning was now come, Jesus stood on the shore: but the disciples knew not that it was Jesus."

Indicates the morning moves.

ACTS

Acts 4:12 "Neither is there salvation in any other: for there is none other name **under heaven** given among men, whereby we must be saved."

Salvation is central to God's plan.

Acts 7:49 "Heaven is my throne, and earth is my footstool: what house will ye build me? saith the Lord: or what is the place of my rest?"

See Isa. 66:1 note for geocentric import.

Acts 7:55 "But he, being full of the Holy Ghost, looked up stedfastly into heaven, and saw the glory of God, and Jesus standing on the right hand of God,"

The geocentric import is the same as Jacob's ladder, cf. Gen. 28:12.

Acts 9:3 "And as he journeyed, he came near Damascus: and suddenly there shined round about him a light from heaven:"

For geocentric import see note to Gen. 28:12.

Acts 10:11 "And saw **heaven opened, and a certain vessel descending unto him**, as it had been a great sheet knit at the four corners, and let down to the earth:"

Same as Jacob's ladder of Gen. 28:12.

Acts 22:6 "And it came to pass, that, as I made my journey, and was come nigh unto Damascus about noon, suddenly there shone from heaven a great light round about me."

See note to Gen. 28:12.

Acts 24:14 "But this I confess unto thee, that after the way which they call heresy, so worship I the God of my fathers, believing all things which are written in the law and in the prophets:"

For geocentric import see note to Josh. 10:12-13.

Acts 27:33 "And while the **day was coming on**, Paul besought them all to take meat, saying, This day is the fourteenth day that ye have tarried and continued fasting, having taken nothing."

The day does the moving, not the earth.

ROMANS

Rom 10:6 "But the righteousness which is of faith speaketh on this wise, Say not in thine heart, Who shall **ascend** into heaven? (that is, to bring Christ down from above:)"

"Ascend": Psa. 24:3, which see for geocentric impact.

I CORINTHIANS

1 Cor 8:13 "Wherefore, if meat make my brother to offend, I will eat no flesh while the world standeth, lest I make my brother to offend."

Geocentric in the Authorized Bible and Greek only.

1 Cor 15:40 "There are also celestial bodies, and bodies terrestrial: but the glory of the celestial is one, and the glory of the terrestrial is another."

This verse indicates that the earth stands apart from heaven.

II CORINTHIANS

2 Cor 4:14 "Knowing that he which raised up the Lord Jesus shall raise up us also by Jesus, and shall present us with you."

Mal. 4:2, which see also for geocentric import.

2 Cor 12:2 "I knew a man in Christ above fourteen years ago, (whether in the body, I cannot tell; or whether out of the body, I cannot tell: God knoweth;) such an one caught up to the **third heaven**."

Geocentric import is that the third heaven is implicitly centered on the earth. Also see v. 4.

EPHESIANS

Eph 4:8 "Wherefore he saith, **When he ascended up on high**, he led captivity captive, and gave gifts unto men."

Eph 4:9 "(Now that he ascended, what is it but that he also **descended first into the lower parts of the earth**?"

Eph 4:10 "He that **descended** is the same also that **ascended** up far above all heavens, that he might fill all things.)"

Eph 4:26 "Be ye angry, and sin not: **let not the sun go down upon your wrath**:"

COLOSSIANS

Col 1:23 "If ye continue in the faith grounded and settled, and be not moved away from the hope of the gospel, which ye have heard, and which was preached to every creature which is **under heaven**; whereof I Paul am made a minister;"

Geocentric import lies in the use of "under" in the sense that the earth is located centrally, esp. since here is where salvation is preached.

Col 2:8 "Beware lest any man spoil you through philosophy and vain deceit, after the tradition of men, after the rudiments of the world, and not after Christ."

This argument holds against heliocentrism.

I THESSALONIANS

1 Th 4:17 "Then we which are alive and remain shall be caught up together with them in the clouds, to meet the Lord in the air: and so shall we ever be with the Lord."

Geocentric: the earth is at the center of this event.

HEBREWS

Heb 2:6 "But one in a certain place testified, saying, What is man, that thou art mindful of him? or the son of man, that thou visitest him?"

For geocentric import see note to Job 7:17.

Heb 7:26 "For such a high priest became us, who is holy, harmless, undefiled, separate from sinners, and made higher than the heavens;"

"Higher than the heavens" has earth as its central reference point since the atmosphere is the first heaven.

JAMES

Jas 1:11 "For the sun is no sooner risen with a burning heat, but it withereth the grass, and the flower thereof falleth, and the grace of the fashion of it perisheth: so also shall the rich man fade away in his ways."

Jas 1:17 "Every good gift and every perfect gift is from above, and cometh down from the Father of lights, with whom is **no variableness, neither shadow of turning.**"

I PETER

1 Pet 1:12 "Unto whom it was revealed, that not unto themselves, but unto us they did minister the things, which are now reported unto you by them that have preached the gospel unto you with the Holy Ghost sent down from heaven; which things the angels desire to look into."

Geocentric import: the Holy Ghost comes to earth for a specific, central purpose.

II PETER

2 Pet 1:19 "We have also a more sure word of prophecy; whereunto ye do well that ye take heed, as unto a light that shineth in a dark place, until the day dawn, and the day star arise in your hearts:"

Geocentric: the day star does the rising.

2 Pet 2:4 "For if God spared not the angels that sinned, but **cast them down** to hell, and delivered them into chains of darkness, to be reserved unto judgment;"

Geocentric: hell is in the earth and the angels are cast "down" to it. Job 4:18; Jude 1:6. Also see note to Job 26:5.

REVELATION

Rev 4:1 "After this I looked, and, behold, a door was opened in heaven: and the first voice which I heard was as it were of a trumpet talking with me; which said, Come up hither, and I will show thee things which must be hereafter."

Geocentric because the earth is at the focus of the "Come up hither" command.

Rev 11:12 "And they heard a great voice from heaven saying unto them, Come up hither. And they ascended up to heaven in a cloud; and their enemies beheld them."

Another rapture.

Rev 20:9 "And they went up on the breadth of the earth, and compassed the camp of the saints about, and the beloved city: and fire came down from God out of heaven, and devoured them."

Geocentric: God's reference point for the fire from heaven.

APPENDIX D

DE SUN DO MOVE

by John Jasper

John Jasper's sermon, "De Sun Do Move" is usually presented in its vernacular form; that is to say, the text is spelled to reflect how the listener would have heard the sermon insofar as pronunciation is concerned. Unless you are from the United States or Canada where you've had exposure to the old southern slave vernacular, a reader will have a difficult task trying to decipher the written text of the sermon. For that reason, that is, for our readers who are not from the North American continent my wife, Beth has converted the sermon to standard American English. The few things that neither of us could discern are left in their transliterated form. Educated guesses are foot-noted.



Figure 1: *John Jasper.*

The traditional vernacular form starts on page 730.

Allow me to say, that when I was a young man and a slave, I knew nothing worth talking about concerning books. They were sealed mysteries to me, but I tell you I longed to break the

seal. I thirsted for the bread of learning. When I saw books I ached to get into them, for I knew that they had the stuff for me, and I wanted to taste their contents, but most of the time they were barred against me.

By the mercy of the Lord a thing happened. I got a roommate, he was a slave, too, and he had learned to read. In the dead of the night he gave me lessons out of the *New York Spelling Book*. It was hard going, I tell you; harder on him for he knew just a little and it made him sweat to try to beat something into my hard head. It was worse with me. Up the hill every step, but when I got the light of the lesson into my noodle I fairly shouted, but I knew I was not a scholar. The consequences were I crept along mighty tediously, getting a crumb here and there until I could read the Bible by skipping the long words, terribly well. That was the start of my education, that is, what little I got. I make mention of that young man. The years have fled away since then, but I haven't forgotten my teacher, and never shall. I thank My Lord for him, and I carry his memory in my heart.

About seven months after my getting to reading, God converted my soul, and I reckon about the first and main thing that I begged the Lord to give was the power to understand His Word. I'm not bragging, and I hate self-praise, but I'm bound to speak the thankful word. I believe in my heart that my prayer to understand the Scriptures was heard. Since that time, I don't care about anything except to study and preach the Word of God.

Not, my brethren that I'm a fool to think I know it all. Oh, my Father, no! Far from it. I hardly understand myself, nor half of the things around me, and there are millions of things in the Bible too deep for Jasper, and some of them too deep for everybody. I don't carry the keys to the Lord's closet, and He hasn't told me to peep in, and if I did I'm so stupid I wouldn't know it when I see it. No, friends, I know my place at the feet of my Master, and there I stay.

But I can read the Bible and get things that lie on the top of the soil. Other than the Bible, I know nothing extra about the sun. I see his courses as he rides up there so grand and mighty in the sky,

but there is lots about that flaming orb that is too much for me. I know that the sun shines powerfully and pours down its light in floods, and yet that is nothing compared with the light that flashes in my mind from the pages of God's book. But you know all that. I know that the sun burns, oh, how it did burn in those July days. I tell you he cooked the skin on my back many a day when I was hoeing in the cornfield. But you know all that, and yet that is nothing near to the divine fire that burns in the souls of God's children. Can't you feel it, brethren?

But about the courses of the sun I have that. I have ranged through the whole blessed book and scoured down the last thing the Bible has to say about the movements of the sun. I got all that pat and safe. And let me say that if I don't give it to you straight, if I get one word crooked or wrong, you just holler out "Hold on there, Jasper, you don't have that straight" and I'll beg pardon. If I don't tell the truth, march up these steps and tell me I'm a liar, and I'll take it. I fear I do lie sometimes, I'm so sinful, I find it hard to do right; but my God doesn't lie and he puts no lie in the Book of eternal truth, and if I give you what the Bible says, then I'm bound to tell the truth.

I have to take you all this afternoon on an excursion to a great battlefield. Most folks like to see fights; some are mighty fond of getting into fights, and some are mighty quick to run down the back alley when there is a battle going on for the right. This time I'll escort you to a scene where you shall witness a curious battle. It took place soon after Israel got into the Promised Land. You remember, the people of Gibeon made friends with God's people when they first entered Canaan and they were monstrously smart to do it. But, just the same, it got them into an awful fuss. The cities around about there flared up at that, and they all joined their forces and said they were going to mop the Gibeon people off the ground, and they bunched all their armies together and went up to do it. When they came up so bold and brave, the Gibeonites were scared out of their senses, and they sent word to Joshua that they were in trouble and he must run up there and get them out. Joshua had the

heart of a lion and he was up there directly. They had an awful fight, sharp and bitter, but you must know that General Joshua was not up there to get whipped. He prayed and he fought and the hours got away too pert for him, and so he asked the Lord to issue a special order that the sun would hold up for a while and that the moon would furnish plenty of moonshine down on the lowest part of the fighting grounds. As a matter of fact, Joshua was so drunk with the battle, so thirsty for the blood of the enemies of the Lord, and so wild with the victory that he told the sun to stand still until he could finish his job. What did the sun do? Did he glare down in fiery wrath and say, "What are you talking about my stopping for, Joshua; I haven't started yet. I've been here all the time, and it would smash up everything if I was to start?" No, he didn't say that. But what does the Bible say? That's what I asked to know. It says that it was at the voice of Joshua that it stopped. I don't say it stopped; it isn't for Jasper to say that, but the Bible, the Book of God, says so. But I say this: nothing can stop until it has first started. So I know what I'm talking about. The sun was traveling along there through the sky when the word came. He hitched his red ponies and made quite a call on the land of Gibeon. He perched up there in the skies just as friendly as a neighbor who comes to borrow something, and he stands up there and he looks like he enjoyed the way Joshua [waxes] those wicked armies. And the moon—she waited down in the low ground there and poured out her light and looked just as calm and happy as if she was waiting for her escort. They never budged, neither of them, as long as the Lord's army needed their light to carry on the battle.

I don't read when it was that Joshua hitched up and drove on, but I suppose it was when the Lord told him to go. Anybody knows that the sun didn't stay there all the time. It stooped for business and went on when it got through. This is about all that I have to do with this particular case. I have shown you that this part of the Lord's word teaches you that the sun stopped, which shows that he was moving before that, and that he went on afterwards. I

told you that I would prove this and I've done it, and I defy anybody to say that my point isn't made.

I told you in the first part of this discourse that the Lord God is a man of war. I expect by now you're beginning to see it is so. Don't you admit it? When the Lord came to see Joshua in the day of his fears and warfare and actually made the sun stop stone still in the heavens so the fight could rage on until all the foes were slain, you're obliged to understand that the God of peace is also the man of war. He can use both peace and war to help the righteous and to scatter the host of the aliens. A man talked to me last week about the laws of nature, and he said they couldn't possibly be upset, and I had to laugh right in his face. As if the laws of anything were greater than my God who is the lawgiver for everything. My Lord is great; he rules in the heavens, in the earth, and down under the ground. He is great, and greatly to be praised. Let all the people bow down and worship before Him!

But let us continue for there is quite a lot more to come. Let us take next the case of Hezekiah. He was one of those kings of Judah -- a mighty sorry lot I must say those kings were for the most part. I am inclined to think Hezekiah was about the highest, in [de general average] and he was no mighty man himself. Well, Hezekiah got sick. I dare say that a king when he gets his crown and finery off, and when he is prostrated with mortal sickness, he gets about as common looking, grunting and rolling, and is about as scary as the rest of us poor mortals. We know that Hezekiah was in a low state of mind, full of fears and in terrible trouble. The fact is, the Lord stripped him of all his glory and landed him in the dust. He told him that his hour had come and that he better square up his affairs, for death was at the door. Then it was that the king fell low before God; he turned his face to the wall, he cried, he moaned, he begged the Lord not to take him out of the world yet. Oh, how good is our God! The cry of the king moved his heart, and he told him he was going to give him another [show]. It isn't only the kings that the Lord hears. The cry of the prisoner, the wail of the bondsman, the tears of the dying robber, the prayers of the back-

slider, the sobs of the woman who was a sinner, are mighty apt to touch the heart of the Lord. It looks like it's hard for the sinner to get so far off or so far down in the pit that his cry can't reach the ear of the merciful Saviour.

But the Lord did even better than this for Hezekiah. He told him he was going to give him a sign by which he'd know that what he said was coming to pass. I'm not acquainted with the sundials that the Lord told Hezekiah about, but anybody that has a grain of sense knows that they were clocks of the old times and they marked the travels of the sun by those dials. When, therefore, God told the king that he would make the shadow go backward, it must have been just like putting the hands of the clock back, but, mark you, Isaiah expressly says that the sun returned ten degrees. There you are! Isn't that the movement of the sun? Bless my soul. Hezekiah's case beat Joshua. Joshua stopped the sun, but here the Lord made the sun walk back ten degrees; and yet they say that the sun stands stone still and never moves a peg. It looks to me that he moves around mighty briskly and is ready to go anyway that the Lord orders him to go. I wonder if any of those philosophers are around here this afternoon. I'd like to take a square look at one of them and ask him to explain this matter. He can't do it, my brethren. He knows a heap about books, maps, figures and long distances, but I defy him to take up Hezekiah's case and explain it. He can't do it. The Word of the Lord is my defense and bulwark, and I fear not what men can say nor do; my God gives me the victory.

Allow me, my friends, to put myself square about this movement of the sun. It isn't any business of mine whether the sun moves or stands still, or whether it stops or goes back or rises or sets. All that is out of my hands entirely, and I have nothing to say. I have no theory on the subject. All I ask is that we will take what the Lord says about it and let his will be done about everything. What that will is I can't know except what he whispers into my soul or writes in a book. Here's the Book. This is enough for me, and with it to pilot me, I can' get far astray.

But I'm not done with you yet. As the song says, there's more to follow. I invite you to hear the first verse in the seventh chapter of the book of Revelation. What does John, under the power of the Spirit say? He says he saw four angels standing on the four corners of the earth, holding the four winds of the earth, and so forth. Allow me to ask, if the earth is round, where does it keep its corners. Every flat, square thing has corners, but tell me where is the corner of an apple, or a marble, or a cannon ball, or a silver dollar. If there is any one of those philosophers that's been taking so many cracks at my old head about here, he is cordially invited to step forward and square up this vexing business. I am here to tell you that you can't square a circle, but it look like these great scholars have learned how to circle the square. If they can do it, let them step to the front and do the trick. But, mere brethren, in my poor judgment, they can't do it; it isn't in them to do it. They are on the wrong side of the Bible; that's on the outside of the Bible, and that's where the trouble comes in with them. They have got out of the brass works of the truth, and as long as they stay there, the light of the Lord will not shine on their path. I don't care so much about the sun, though it's mighty convenient to have it, but my trust is in the Word of the Lord. As long as my feet are flat on the solid rock, no man can move. I get my orders from the God of my salvation.

The other day a man with a high collar and side-whiskers came to my house. He was one nice Northern gentleman who thinks a heap of us colored people in the South. There are lovely folks and I honor them very much. He seemed from the start kind of strict and cross with me, and after a while, he broke out furious and fretted, and he said: "Allow me Mister Jasper to give you some plain advice. This nonsense about the sun moving that are you getting is disgracing your race all over the country, and as a friend of your people, I have come to say it's got to stop." Ha! Ha! Ha! Master Sam Hargrove never hardly smashed me that way. It was equal to one of those old overseers way back yonder. I told him that if he would show me I'm wrong; I would give it all up.

My! My! Ha! Ha! He sailed in on me in such a storm about science, new discoveries, and the Lord only knows what all, I had never heard before, and then he told me my race is urging me that poor old Jasper must shut up his foul mouth.

When he got through -- it looked like he never would-- I told him that John Jasper isn't set up to be a scholar, and doesn't know philosophies, and isn't trying to hurt his people, but is working day and night to lift them up, but his foot is on the rock of eternal truth. There he stood and there he is going to stand until Gabriel sounds the judgment note. So I said to the gentleman that scolded me up so that I hurt him -- make your remarks, but I didn't hear where he got his Scripture from and that between him and the word of the Lord, I take my stand by the Word of God every time. Jasper isn't mad, he isn't fighting anybody, he hasn't been appointed janitor to run the sun; he's nothing but the servant of God a lover of the Everlasting Word. What do I care about the sun? The day comes on when the sun is called from his racetrack, and his light is quenched out forever; the moon shall turn to blood, and this earth will be consumed with fire. Let them go; that won't scare me nor trouble God's elected people, for the word of the Lord shall endure forever, and on that Solid Rock we stand and shall not be moved.

Have I got you satisfied yet? Have I proven my point? Oh, you whose hearts are full of unbelief! Are you still holding out? I reckon the reason you say the sun doesn't move is because you are so hard to move yourself. You are a real trial to me, but never mind, I'm not giving you up yet and never will. Truth is mighty, it can break the heart of stone, and I must fire another arrow of truth out of the quiver of the Lord. If you have a copy of God's Word about your person, please turn to that minor prophet, Malachi, that is the last book in the Old Bible and look at the first chapter, verse eleven; what does it say? I better read it, for I have the notion your critics don't carry any Bible in their pockets every day in the week. Here is what it says: "For from the rising of the sun even unto the going down of the same My name shall be great among the Gentiles..." My name shall be great among the heathen, says the Lord

of hosts. How does that suit you? It looks like that ought to fix it. This time it is the Lord of hosts Himself that is doing the talking and he is talking on a wonderful and glorious subject. He is telling of the spreading of his Gospel, of the coming of his last victory over the Gentiles, and the world-wide glories that at the last he is to get. Oh, my brethren, what a time that will be. My soul takes wing as I anticipate with joy that Millennium Day! The glories as they shine before my eyes blind me, and I forget the sun and moon and stars. I just remembered that along about those last days the sun and moon will go out of business, for they won't be needed any more. Then will King Jesus come back to see his people and he will be the sufficient light of the world. Joshua's battles will be over. Hezekiah won't need any sundial, and the sun and moon will fade out before the glorious splendors of the New Jerusalem.

But what's the matter with Jasper? I almost forgot my business and got to shouting over the far away glories of the second coming of my Lord. I beg pardon and will try to get back to my subject. I have to do as the sun in Hezekiah's case—fall back a few degrees. In that part of the Word that I gave you from Malachi—that the Lord himself spoke—he declares that his glory is going to spread. Spread? Where? From the rising of the sun to the going down of the same. What? It doesn't say that, does it? That's exactly what it says. Isn't that clear enough for you? The Lord pity these doubting Thomasses. Here is enough to settle it all and cure the worst cases. Walk up here, wise folks, and get your medicine. Where are those high-collared philosophers now? Why are they skulking around in the brush? Why don't you get out in the broad afternoon light and fight for your colors? Ah, I understand it; you have no answer. The Bible is against you and in your conscience you are convicted.

But I hear you back there. What are you whispering about? I know; you say you sent me some papers and I never answered them. Ha, Ha, Ha! I got them. The difficulty about those papers you sent me is that they did not answer me. They never mentioned the Bible one time. You think so much of yourselves and so little

of the Lord God and think what you say is so smart that you can't even speak of the Word of the Lord. When you ask me to stop believing in the Lord's Word and to pin my faith to your words, I'm not going to do it. I take my stand by the Bible and rest my case on what it says. I take what the Lord says about my sins, about my Saviour, about life, about death, about the world to come, and I take what the Lord says about the sun and moon, and I care little what the haters of my God choose to say. Do you think that I will forsake the Bible? It is my only Book, my hope, the arsenal of my soul's supplies, and I want nothing else.

But I have another word for you yet. I worked over those papers that you sent me without date and without your name. You deal in figures and you think you are bigger than the archangels. Let me see what you have said. You set yourself up to tell me how far it is from here to the sun. You think you have it down to a nice point. You say it is 3,339,002 miles from the earth to the sun. That's what you say. Another one says that the distance is 12,000,000; another has it to 27,000,000. I heard that the great Isaac Newton worked it up to 28,000,000 and later one of the philosophers gave another rip and raised it to 50,000,000. The last one got it bigger than all the others, up to 90,000,000. None of them agree exactly and so they run a guessing game, and the last guess is always the biggest. Now, when these guessers have a convention in Richmond and all agree upon the same thing, I'd be glad to hear from you again, and I hope that by that time you won't be ashamed of your name.

Lots of railroads have been built since I saw the first one when I was fifteen years old, but I've never heard of a railroad built yet to the sun. I don't see why if they can measure the distance to the sun, they might not make a railroad or a telegraph and enable us to find something else about it than merely how far off the sun is. They tell me that a cannon ball could make the trip to the sun in twelve years. Why don't they send it? It might be rigged up with quarters for a few philosophers on the inside and fixed up for a comfortable ride. They would need twelve years of rations and a

lot of changes of raiment – mighty thick clothes for when they start and mighty thin ones for when they get there.

Oh, my brethren, these things make you laugh, and I don't blame you for laughing, except it's always sad to laugh at the follies of fools. If we could laugh them out of countenance¹ [kount'nens], we might well laugh day and night. What cuts into my soul is that all these men seem to me that they are hitting at the Bible. That's what stirs my soul and fills me with righteous wrath. Little care I what they say about the sun, provided they let the Word of the Lord alone. But never mind. Let the heathen rage and the people imagine a vain thing. Our King shall break them in pieces and dash them down. But blessed be the name of our God, the Word of the Lord endureth forever. Stars may fall, moons may turn to blood, and the sun set to rise no more, but Thy kingdom, O, Lord is from everlasting to everlasting.

But I have a word this afternoon for my own brethren. There are the people for whose souls I have to watch—for them I have to stand and report at the last—they are my sheep and I am their shepherd, and my soul is knit to them forever. It isn't for me to trouble you with these questions about the heavenly bodies. Our eyes go far beyond the smaller stars; our home is clean of sight of those twinkling orbs; the chariot that will come to take us to our Father's mansion will sweep out by those flickering lights and never halt until it bring us in clear view of the throne of the Lamb. Don't hitch your hopes to any sun or stars; your home has Jesus for its light, and your hopes must travel up that way. I preach this sermon just to settle the minds of my few brethren, and I repeat it because kind friends wish to hear it, and I hope it will do honour to the Lord's Word. But nothing short of the pearly gates can satisfy me, and I charge, my people, fix your feet on the solid Rock, your hearts on Calvary, and your eyes on the throne of the Lamb. These strifes and griefs will soon be over; we shall see the King in His glory and be at ease. Go on, go on, ye ransomed of the Lord; shout

¹ In the obsolete sense of their arrogant bearing or demeanor. Jasper's saying, "if we could laugh some sense into them we would laugh day and night."

His praises as you go, and I shall meet you in the city of the New Jerusalem, where we shan't need the light of the sun, for the Lamb of the Lord is the light of the saints.

DE SUN DO MOVE¹

“Low me ter say,” he spoke with an outward composure which revealed an inward but mastered swell of emotion, “dat when I wuz a young man and a slave, I knowed nuthin’ wuth talkin’ ‘bout consarnin’ books. Dey wuz sealed mysteries ter me, but I tell yer I longed ter break de seal. I thusted fer de bread uv learnin’. When I seen books I ached ter git in ter um, fur I knowed dat dey had de stuff fer me, an’ I wanted ter taste dere contents, but most of de time dey wuz bar’d aginst me.

“By de mursy of de Lord a thing happened. I got er room-feller-he wuz a slave, too, an’ he had learn’d ter read. In de dead uv de night he giv me lessons outen de New York Spellin’ Book. It wuz hard pullin’, I tell yer; harder on him, fur he know’d jes’ a leetle, an’ it made him sweat ter try ter beat sumthin’ inter my hard haid. It wuz wuss wid me. Up de hill ev’ry step, but when I got de light uv de less’n into my noodle I farly shouted, but I kno’d I wuz not a scholur. De consequens wuz I crep ‘long mighty tejus, gittin’ a crum here an’ dar untel I cud read de Bible by skippin’ de long words, tolerable well. Dat wuz de start uv my eddicashun-dat is, wat little I got. I mek menshun uv dat young man. De years hev fled erway sense den, but I ain’t furgot my teachur, an’ nevr shall. I thank mer Lord fur him, an’ I carries his mem’ry in my heart.

“‘Bout seben months after my gittin’ ter readin’, Gord converted my soul, an’ I reckon ‘bout de fust an’ main thing dat I begged de Lord ter give me wuz de power ter und’stan’ His Word. I ain’ braggin’, an’ I hates self-praise, but I boun’ ter speak de thankful word. I b’lieves in mer heart dat mer pra’r ter und’-stand de Scripshur wuz heard. Sence dat time I ain’t keer’d ‘bout nuthin’ ‘cept ter study an’ preach de Word uv God.

"Not, my bruthrin, dat I'z de fool ter think I knows it all. Oh, mer Father, no! Fur frum it. I don' hardly und'stan myse'f, nor ha'f uv de things roun' me, an' dar is milyuns uv things in de Bible too deep fur Jasper, an'sum uv'em too deep fur ev'rybody. I doan't cerry de keys ter de Lord's closet, an' He ain' tell me ter peep in, an' ef I did I'm so stupid I wouldn't know it when I see it. No, frens, I knows my place at de feet uv my Marster, an' dar I stays.

"But I kin read de Bible and git de things whar lay on de top uv de soil. Out'n de Bible I knows nuthin' extry 'bout de sun. I sees 'is courses as he rides up dar so gran' an' mighty in de sky, but dar is heaps 'bout dat flamin' orb dat is too much fer me. I know dat de sun shines powerfly an' po's down its light in floods, an' yet dat is nuthin' compared wid de light dat flashes in my min' f rum de pages of Gord's book. But you knows all dat. I knows dat de sun burns oh, how it did burn in dem July days. I tell yer he cooked de skin on my back many er day when I wuz hoein' in de corn fiel'. But you knows all dat, an' yet dat is nuthin' der to de divine fire dat burns in der souls uv Gord's chil'n. Can't yer feel it, bruthrin?

"But 'bout de courses uv de sun, I have got dat. I hev dun rang'd thru de whole blessed book an' scode down de las' thing de Bible has ter say 'bout de move-ments uv de sun. I got all dat pat an' safe. An' lemme say dat if I doan't giv it ter you straight, if I gits one word crooked or wrong, you jes' holler out 'Hol' on dar, Jasper, yer ain't got dat straight, 'an' I'll beg pardon. If I doan't tell de truf, march up on dese steps here an' tell me I'z a liar, an' I'll take it. I fears I do lie sometimes-I'm so sinful, I find it hard ter do right; but my Gord doan't lie an' He ain' put no lie in de Book uv eternal truf, an' if I giv you wat de Bible say, den I boun' ter tell de truf.

"I got ter take yer all dis afternoon on er skershun ter a great bat'l fiel'. Mos' folks like ter see fights- some is mighty fon' er gittin' inter fights, an' some is mighty quick ter run down de back alley when dar is a bat'l goin' on, fer de right. Dis time I'll 'scort yer ter a scene whar you shall witness a curus bat'l. It tuk place

soon arter Isrel got in de Promus Lan'. Yer 'member, de people uv Gibyun mak frens wid Gord's people when dey fust entered Canum an' dey wuz monsus smart ter do it. But, jes' de same, it got 'em in ter an orful fuss. De cities roun' 'bout dar flar'd up at dat, an' dey all jined dere forces and say dey gwine ter mop de Gibyun people orf uv de groun', an' dey bunched all dar armies tergedder an' went up fer ter do it. Wen dey kum up so bol' an' brave de Giby'nites wuz skeer'd out'n dere senses, an' dey saunt word ter Joshwer dat dey wuz in troubl' an' he mus' run up dar an' git 'em out. Joshwer had de heart uv a lion an' he wuz up dar d'reckly. Dey had an orful fight, sharp an' bitter, but yer might know dat Givr'l Joshwer wuz not up dar ter git whip't He prayed an' he fought, an' de hours got erway too peart fer him, an' so he ask'd de Lord ter issure a speshul ordur dat de sun hol' up erwhile an' dat de moon furnish plenty uv moonshine down on de lowes' part uv de fightin' groun's. As a fac', Joshwer wuz so drunk wid de bat'l, so thirsty fer de blood uv de en'mies uv de Lord, an' so wild wid de vict'ry dat he tell de sun ter stan' still tel he cud finish his job. Wat did de sun do? Did he glar down in fi'ry wrath an' say, 'What you talkin' 'bout my stoppin' for, Joshwer; I ain't navur startid yit. Bin here all de time, an' it wud smash up ev'rything if I wuz ter start?' Naw, he ain' say dat. But wat de Bible say? Dat's wat I ax ter know. It say dat it wuz at de voice uv Joshwer dat it stopped. I don' say it stopt; tain't fer Jasper ter say dat, but de Bible, de Book uv Gord, say so. But I say dis; nuthin' kin stop untel it hez fust startid. So I knows wat I'm talkin' 'bout. De sun wuz travlin' long dar thru de sky wen de order come. He hitched his red ponies and made quite a call on de lan' uv Gibyun. He purch up dar in de skies jes' as frenly as a naibur whar comes ter borrar sumthin', an' he stan' up dar an' he look lak he enjoyed de way Joshwer waxes dem wicked armies. An' de moon, -she wait down in de low groun's dar, an' pours out her light and look jes' as ca'm an' happy as if she wuz waitin' fer her 'scort. Dey nevir budg'd, neither uv 'em, long as de Lord's army needed er light to kerry on de bat'l.

"I doan't read when it wuz dat Joshwer hitch up an' drove on, but I 'spose it wuz when de Lord tol' him ter go. Ennybody knows dat de sun didn' stay dar all de time. It stopt fur bizniz, an' went on when it got thru. Dis is 'bout all dat I has ter do wid dis perticl'r case. I dun show'd yer dat dis part uv de Lord's word teaches yer dat de sun stopt, which show dat he wuz movin' befo' dat, an' dat he went on art'rwuds. I toll yer dat I wud prove dis an' I's dun it, an' I derfies ennybody to say dat my p'int ain't made.

"I toll yer in de fust part uv dis discose dat de Lord Gord is a man uv war. I 'spec by now yer begin ter see it is so. Doan't yer admit it? When de Lord cum ter see Joshwer in de day uv his feers an' warfare an' actu'ly mek de sun stop stone still in de heavuns, so de fight kin rage on tel all de foes is slain, yer bleegeed ter und'stan' dat de Gord uv peace is also de man uv war. He kin use bofe peace an' war ter hep de richus, an' ter scatter de host uv de ailyuns. A man talked ter me las' week 'bout de laws uv nature, an' he say dey carn't possibly be upsot, an' I had ter laugh right in his face. As if de laws uv ennythin' wuz greater dan my Gord who is de lawgiver fer ev'rything. My Lord is great; He rules in de heavuns, in de earth, an' doun und'r de groun'. He is great, an' greatly ter be praised. Let all de people bow doun an' wurship befo' Him!

"But let us git erlong, for dar is quite a big lot mo' comin' on. Let us take nex' de case of Hezekier. He wuz one of dem kings of Juder-er mighty sorry lot I mus I say dem kings wuz, fur de mos' part. I inclines ter think Hezekier wuz 'bout de highes' in de gin'ral avrig, an' he war no mighty man hisse'f. Well, Hezekier he got sick. I dar say dat a king when he gits his crown an' fin'ry off, an' when he is posterated wid mortal sickness, he gits 'bout es comun lookin' an' grunts an' rolls, an' is 'bout es skeery as de res' of us po' mortals. We know dat Hezekier wuz in er low state uv min'; full uv fears, an' in a tur'ble trub'le. De fac' is, de Lord strip him uv all his glory an' landed him in de dust. He tol' him dat his hour had come, an' dat he had bettur squar up his affaars, fur death wuz at de do'. Den it wuz dat de king fell low befo' Gord; he turned his face ter de wall; he cry, he moan, he beg'd de Lord not ter take him

out'n de worl' yit. Oh, how good is our Gord! De cry uv de king moved his heart, an, 'he tell, him he gwine ter give him anudder show. Tain't only de kings dat de Lord hears' De cry uv de pris'nur, de wail uv de bondsman, de tears uv de dyin' robber, de prars uv de backslider, de sobs uv de womun dat wuz a sinner, mighty apt to tech de heart uv de Lord. It look lik it's hard fer de sinner ter git so fur orf or so fur down in de pit dat his cry can't reach de yere uv de mussiful Saviour.

"But de Lord do evun better den dis fur Hezekier- He tell him He gwine ter give him a sign by which he'd know dat what He sed wuz cummin' ter pars. I ain't erquainted wid dem sun diuls dat de Lord toll Hezckier 'bout, but ennybody dat hes got a grain uv sense knows dat dcy wuz de clocks uv dem ole times an' dey marked de travuls uv de sun by dem diuls. When, darfo' Gord tol' de king dat He wud mek de shadder go backwud, it mus' hev bin jes' lak puttin' de han's uv de clock back, but, mark yer, Izaer 'spressly say dat de sun return'd ten dergrees. Thar yer are! Ain't dat de movement uv de sun? Bless my soul. Hezekier's case beat Joshwer. Joshwer stop de sun, but heer de Lord mek de sun walk back ten dergrees; an' yet dey say dat de sun stan' stone still an' nevr move er peg. It look ter me he move roun' mighty brisk an' is ready ter go ennyway dat de Lord ordurs him ter go. I wonder if enny uv dem furloserfers is roun' here dis arternoon. I'd lik ter take a squar' look at one uv dem an' ax him to 'splain dis mattur. He carn't do it, my bruthr'n. He knows a heap 'bout books, maps, figgers an' long distunces, but I derfy him ter take up Heze- kier's case an' 'splain it orf. He carn't do it. De Word uv de Lord is my defense an' bulwurk, an' I fears not what men can say nor do; my Gord gives me de vict'ry.

"Low me, my frens, ter put myself squar 'bout dis movement uv de sun. It ain't no bizniss uv mine wed- der de sun move or stan' still, or wedder it stop or go back or rise or set. All dat is out er my han's 'tirely, an' I got nuthin' ter say. I got no the-o-ry on de subjik. All I ax is dat we will take wat de Lord say 'bout it an' let His will be dun 'bout ev'rything. Wat dat will is I karn't know

'cept He whisper inter my soul or write it in a book. Here's de Book. Dis is 'nough fer me, and wid it ter pilut me, I karn't git fur erstray.

"But I ain't dun wid yer yit. As de song says, dere's mo' ter foller. I envite yer ter heer de fust vers in de sev'nth chaptur uv de book uv Reverlashuns. What do John, und'r de pow'r uv de Spirit, say? He say he saw fo' anguls standin' on de fo' corners uv de earth, holdin' de fo' win's uv de earth, an' so fo'th. 'Low me ter ax ef de earth is roun', whar do it keep its comers? Er flat, squar thing has corners, but tell me where is de cornur uv er appul, ur a marbul, ur a cannun ball, ur a silver dollar. Ef dar is enny one uv dem furloserfurs whar's been takin' so many cracks at my ole haid 'bout here, he is korjully envited ter step for'd an' squar up dis vexin' bizniss. I here tell you dat yer karn't squar a circul, but it looks lak dese great scolurs dun learn how ter circul de squar. Ef dey kin do it, let 'em step ter de front an' do de trick. But, mer brutherin, in my po' judgmint, dey karn't do it; tain't in 'em ter do it. Dey is on de wrong side of de Bible; dat's on de outside uv de Bible, an' dar's whar de trubbul comes in wid 'em. Dey dun got out uv de bres'wuks uv de truf, an' ez long ez dey stay dar de light uv de Lord will not shine on der path. I ain't keer'n so much 'bout de sun, tho' it's mighty kunveenyunt ter hav it, but my trus' is in de Word uv de Lord. Long ez my feet is flat on de solid rock, no man kin move me. I'se gittin' my orders f'um de Gord of my salvashun.

"Tother day er man wid er hi coller and side whisk'rs cum ter my house. He was one nice North'm gemman wat think a heap of us col'rd people in de Souf. Da ar luvly folks and I honours 'em very much. He seem from de start kinder strictly an' cross wid me, and arter while, he brake out furi'us and frettid, an' he say: "Erlow me Mister Jasper ter gib you sum plain advise. Dis nonsans 'bout de sun movin' whar you ar gettin' is disgracin' yer race all ober de kuntry, an' as a fren of yer peopul, I cum ter say it's got ter stop.' Ha! Ha! Ha I Mars' Sam Hargrove nuvur hardly smash me dat way. It was equul to one ov dem ole overseurs way bac yondur. I tel him dat ef he'll sho me I'se wrong, I giv it all up.

"My! My! Ha! Ha! He sail in on me an' such er storm about science, nu 'scuv'ries, an' de Lord only knos wat all, I ner hur befo', an' den he tel me my race is ergin me an' po ole Jasper mus shet up 'is fule mouf.

"Wen he got thru-it look lak he nuvur wud-I tel him John Jasper ain' set up to be no scholur, an' doant kno de ferlosophiz, an' ain' tryin' ter hurt his peopul, but is wurkin' day an' night ter lif 'em up, but his foot is on de rock uv eternal truff. Dar he stan' and dar he is goin' ter stan' til Gabrul soun's de judgment note. So er say to de gemman wat scol'd me up so dat I hur him -mek his remarks, but I ain' hur whar he get his Scriptu' from, an, dat 'tween him an' de wurd of de Lord I tek my stan' by de Word of Gord ebery time. Jasper ain' mad: he ain' fightin' nobody; he ain' bin 'pinted janitur to run de sun: he nothin' but de servunt of Gord and a luver of de Everlasting Word. What I keer about de sun? De day comes on wen de sun will be called frum his race-trac, and his light squincked out foruvur; de moon shall turn ter blood, and this yearth be konsoomed wid fier. Let um go; dat wont skeer me nor trubble Gord's erlect'd peopul, for de word uv de Lord shell aindu furivur, an' on dat Solid Rock we stan' an' shall not be mued.

"Is I got yer satisfied yit? Has I proven my p'int? Oh, ye whose hearts is full uv unberlie! Is yer still hol' in' out? I reckun de reason yer say de sun don' move is 'cause yer are so hard ter move yerse'f. You is a reel triul ter me, but, nevur min'; I ain't gi'n yer up yit, an' nevur will. Truf is mighty; it kin break de heart uv stone, an' I mus' fire anudder arrur uv truf out'n de quivur uv de Lord. If yer haz er copy uv God's Word 'bout yer pussun, please tu'n ter dat miner profit, Malerki, wat writ der las' book in der ole Bible, an' look at chaptur de fust, vurs 'leben; what do it say? I bet'r read it, fur I got er noshun yer critics doan't kerry enny Bible in thar pockits ev'ry day in de week. Here is wat it says: 'Fur from de risin' uv de sun evun unter de goin' doun uv de same My name shall be great 'mong de Gentiles.... My name shall be great'mong de heathun, sez de Lord uv hosts.' How do dat suit yer? It look lak dat ort ter fix it. Dis time it is de Lord uv hosts Hisse'f dat is doin'

de talkin, an' He is talkin' on er wonderful an' glorious subjik. He is tellin' uv de spreidin' uv His Gorspel, uv de kummin' uv His larst vict'ry ovur de Gentiles, an' de world-wide glories dat at de las' He is ter git. Oh, my b'ruddrin, wat er time dat will be. My soul teks wing es I erticipate wid joy dat merlenium day! De glories as dey shine befo' my eyes blin's me, an' I furgits de sun an' moon an' stars. I jes' 'members dat 'long bout dose las' days dat de sun an' moon will go out uv bizniss, fur dey won' be needed no mo'. Den will King Jesus come back ter see His people, an' He will be de suffishunt light uv de wurl'. Joshwer's bat'ls will be ovur. Hezekier woan't need no sun diul, an' de sun an' moon will fade out befo' de glorius splendors uv de New Jerruslem.

"But wat der mattur wid Jasper? I mos' furgit my bizniss, an' most gon' ter shoutin' ovur de far away glories uv de secun' cummin' uv my Lord. I beg par- dun, an' will try ter git back ter my subjik. I hev ter do as de sun in Hezekier's case-fall back er few der- grees. In dat part uv de Word dat I gin yer frum Malerki-dat de Lord Hisse'f spoke-He klars dat His glory is gwine ter spread. Spread? Whar? Frum de risin' uv de sun ter de goin' down uv de same. Wat? Doan't say dat, duz it? Dats edzakly wat it sez. Ain't dat cleer 'nuff fer yer? De Lord pity dese doubt'n' Tommusses. Here is 'nuff ter settul it all an' kure de wuss cases. Walk up yere, wise folks, an' git yer med'sin. Whar is dem high collar'd furloser-furs now? Wat dey skulkin' roun' in de brush fer? Why doan't yer git out in der broad arternoon light, an' fight fer yer cullurs? Ah, I un'stans it; yer got no answer. De Bible is agin yer, an' in yer konshunses yer are convicted.

"But I hears yer back dar. Wat yer wisprin' 'bout? I know; yer say yer sont me sum papurs an' I nevir answer dem. Ha, ha, ha! I got 'em. De differkulty 'bout dem papurs yer sont me is dat dey did not answer me. Dey nevir menshun de Bible one time. Yer think so much uv yourself's an' so little uv de Lord Gord an' thinks wat yer say is so smart dat yer karn't even speak uv de Word uv de Lord. When yer ax me ter stop believin' in de Lord's Word an' ter pin my faith ter yo words, I ain't er gwine ter do it. I take my stan'

by de Bible an' res' my case on wat it says. I take wat de Lord says 'bout my sins, 'bout my Saviour, 'bout life, 'bout death, 'bout de wurl' ter come, an' I take wat de Lord say 'bout de sun an' moon, an' I cares little wat de haters of mer Gord chooses ter say. Think dat I will fursake de Bible? It is my only Book, my hope, de arsel uv my soul's surplies, an' I wants nuthin' else.

"But I got ernudder wurd fur yer yit. I done wuk ovur dem papurs dat yer sont me widout date an' wid- out yer name. Yer deals in figgurs an' thinks yer are biggur dan de arkanjuls. Lemme see wat yer dun say. Yer set yerse'f up ter tell me how fur it is frum here ter de sun. Yer think yer got it down ter er nice p'int. Yer say it is 3,339,002 miles frum de earth ter de sun. Dat's wat yer say. Nudder one say dat de distuns is 12,000,000; nudder got it ter 27,000,000. I hears dat de great Isuk Nutun wuk't it up ter 28,000,000, an' later on de furloserfurs gin ernudder rippin' raze to 50,000,000. De las' one gits it bigger dan all de yuthers, up to 90,000,000. Doan't enny uv 'em ergree edzakly an' so dey runs a guess game, an' de las' guess is always de bigges'. Now, wen dese guessers kin hav a kunvenshun in Richmun' an' all ergree 'pun de same thing, I'd be glad ter hear frum yer ag'in, an' I duz hope dat by dat time yer won't be ershamed uv yer name.

"Heeps uv railroads hes bin built sense I saw de fust one wen I wuz fifteen yeers ole, but I ain't hear tell uv er railroad built yit ter de sun. I doan' see why ef dey kin meshur de distuns ter de sun, dey might not git up er railroad er a telurgraf an' enabul us ter fin' sumthin' else 'bout it den merely how fur orf de sun is. Dey tell me dat a kannun ball cu'd mek de trip ter de sun in twelve years. Why doan' dey send it? It might be rig'd up wid quarturs fur a few furloserfurs on de inside an' fixed up fur er kumfurterble ride. Dey wud need twelve years' rashuns an' a heap uv changes uv ramint-mighty thick clo'es wen dey start and mighty thin uns wen dey git dar.

"Oh, mer bruthrin, dese things mek yer laugh, an' I doan' blem yer fer laughin', 'cept it's always sad ter laugh at der follies uv fools. If we cu'd laugh'em out'n kount'nens, we might well laugh

day an' night. Wat cuts inter my soul is, dat all dese men seem ter me dat dey is hittin' at de Bible. Dats wat sturs my soul an' fills me wid richus wrath. Lectle keers I wat dey says 'bout de sun, purvided dey let de Word uv de Lord erlone. But nevr min'. Let de heethun rage an' de people 'madgin er vain thing. Our King shall break lem in pieces an' dash 'em down. But blessed be de name uv our Gord, de Word uv de Lord indurith furivur. Stars may fall, moons may turn ter blood, an' de sun set ter rise no mo', but Thy kingdom, oh, Lord, is frum evurlastin' ter evurlastin'.

"But I has er word dis afternoon fer my own brutherin. Dey is de people fer whose souls I got ter watch-fur dem I got ter stan' an' report at de last- dey is my sheep an' I'se der she'pherd, an' my soul is knit ter dem forever. 'Tain fer me ter be troublin' yer wid desc questions erbout dem heb'nly bodies. Our eyes goes far beyon' de smaller stars; our home is clean outer sight uv dem twinklin' orbs; de chariot dat will cum ter take us to our Father's mansion will sweep out by dem flickerin' lights an' never halt till it brings us in clar view uv de throne uv de Lamb. Doan't hitch yer hopes to no sun nor stars; yer home is got Jesus fer its light, an' yer hopes mus' trabel up dat way. I preach dis sermon jest fer ter settle de min's uv my few brutherin, an' repeats it 'cause kin' frens wish ter hear it, an' I hopes it will do honour ter de Lord's Word. But nuthin' short of de purly gates can satisfy me, an' I charge, my people, fix yer feet on de solid Rock, yer hearts on Calv'ry, an' yer eyes on de throne uv de Lamb. Dese strifes an' griefs'll soon git ober; we shall see de King in His glory an' be at ease. Go on, go on, ye ransom uv de Lord; shout His praises as yer go, an' I shall meet yer in de city uv de New Jeruserlum, whar we shan't need the light uv de sun, fer de Lam' uv de Lord is de light uv de saints."

APPENDIX E

DERIVATION OF THE GEOCENTRIC EQUATIONS FOR A DAILY-ROTATING UNIVERSE

Introduction

By definition, physics deals with matter in motion. Mathematics is the language of choice, used by physicists to describe motion. Usually physicists are well behaved in their use of math, but at times they introduce fudge factors to bridge what theory demands and experiment lacks. Even then the fudging is quite obvious from the names given the fudge factors such as "guillotine factor," for instance. But there are times when reputations and careers are at stake and at those times, the fudging becomes quite subtle, even mean-spirited at times.

The mathematical language used to describe the gravitational forces of orbiting bodies, and the behavior of spinning bodies is a case in point. When confronted by the mass of evidence for the geocentric universe, physics resorts to a sleight of hand to keep the earth in orbit about the sun when all fundamental experimental results reveal earth to stand still in the firmament, physicists pull a fast one. In this case, they multiply one side of the generalized equation of motion by the number one. Before multiplying by one, the equation is said to be *kinematic*, describing the accelerations and velocities of the bodies but not taking the masses of the bodies into consideration. For instance, consider this equation that describes the velocity, v , of a body in circular motion at a rotational speed of ω and a distance R from the center of the circle:

$$v = \omega \times R. \quad (1)$$

This equation is said to be *kinematic* and even though it perfectly describes the velocity and behavior of a body either rotating or orbiting it is said to be unphysical.

Now suppose that we multiply the left-hand side of the equation by one, namely, by the mass, m , divided by itself, i.e., m/m . This is equivalent to multiplying both sides of the equation by the mass, m . Our equation now looks as follows:

$$m \mathbf{v} = m\omega \times \mathbf{R}. \quad (2)$$

This is said to be a *dynamic* description, that is to say, somehow this equation is more “physical,” more “real,” than the kinematic equation (1) even though we can obviously cancel out the m 's and simplify equation (2) back to equation (1). To hide this sleight of hand, equation (2)'s left hand side is replaced by a single variable, \mathbf{p} , called *momentum*.^{*} Thus equation (3), which is the same as equation (2) is rewritten as”

$$\mathbf{p} = m\omega \times \mathbf{R}. \quad (3)$$

Since momentum is a dynamic concept, the mass is hidden and no physicist will cancel its appearance on the right-hand side of the equation with its hidden counterpart in \mathbf{p} .

But two can play at that game. Let's assume that God created the firmament with a built-in set of reaction rules. These rules dictate the behaviors of accelerating bodies and the set of all such reactions we group together under in the concept of *inertia*.

Deriving the Geocentric Equations From First Principles

As seen from earth, a star's location is determined by its coordinates. Just as our coordinates on earth are specified by longitude and latitude, so a star's coordinates are given by its right

^{*} Technically, it is more correct to say that \mathbf{p} is the *angular* momentum, but that is irrelevant to the argument at hand.

ascension and declination. A star's longitude is specified by its right ascension and its latitude is measured by its declination north or south of the plane of earth's equator. Since the star's coordinates are fixed to the celestial sphere, to model the rotation of the firmament—carrying the star with it—we only need the star's declination (see Figure 1).

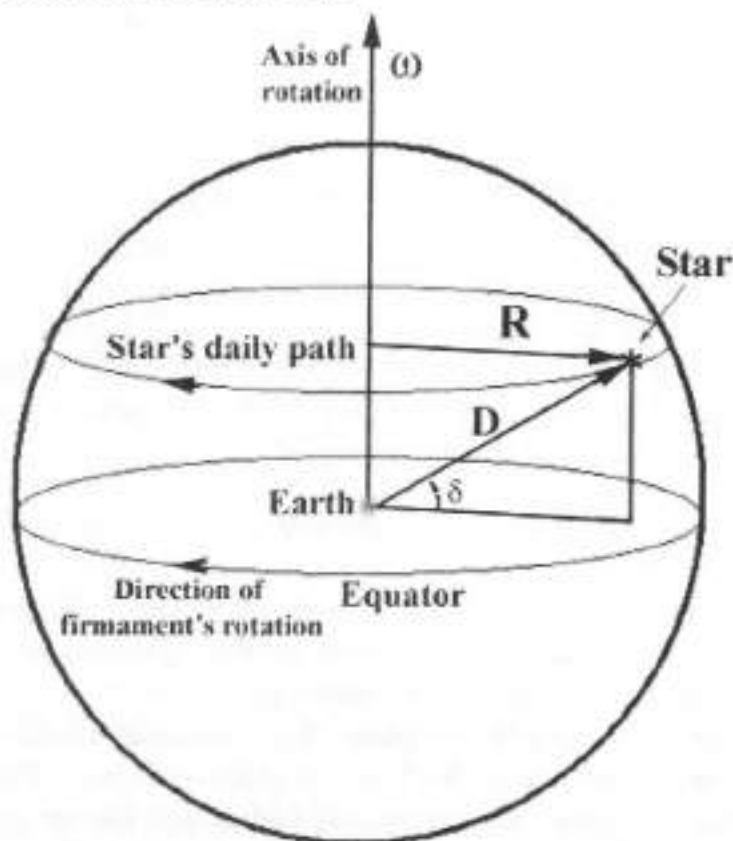

Figure 1: *The Geocentric View of the Daily Rotation; the star is*

The following is a derivation of the dynamical equations for the universe rotating about the earth in a daily rotation. In the derivation we use the following notation:

F is the net gravitational force exerted on the star;
 a is the net acceleration experienced by the star in its daily path about earth;
 R is the shortest distance from the axis of rotation to the star;
 D is the distance from earth to the star;
 v is the velocity of the star;
 m is the star's mass;
 δ is the declination (celestial latitude) of the star as measured from the equator; and
 ω is the rotation rate of the firmament about the rotational axis that passes through the north and south poles of earth; imagine it measured in degrees per second although technically we use radians per second.*

The usual objection against geocentricity is that the earth is not massive enough to have the universe "orbit" it once a day. In reality, the mass of the earth does not enter into the force that holds the universe together during its rotation. (Sorry, some first-semester calculus is necessary here.) Acceleration is defined as a change in velocity per unit time. We can write this as:

$$a = \frac{d^2 R}{dt^2} \quad (4)$$

Here, R is the distance to a moving object and t is time. This can be rewritten more explicitly as:

$$a = \frac{d}{dt} \frac{dR}{dt} \quad (5)$$

where dR/dt is the *velocity*, v , of the moving object, the star in our case. This equation says, "Acceleration is the rate of change in velocity."

* There are 2π radians in the circumference of a circle, so a radian is roughly 57 degrees.

But we're not trying to model the speed and acceleration of an automobile here but that of a distant star rotating about the earth once every 23 hours and 56 minutes. We must thus add the rotational velocity (Equation (1)) into the mix. This requires us to rewrite equation (5) as:

$$a = \frac{d}{dt} \left(\frac{dR}{dt} + \omega \times R \right) \quad (6)$$

where ω is the angular velocity (measured in degrees per second, for instance) and R is the distance of the star from the axis of rotation.

Distributing the derivative (d/dt) through the terms in parentheses gives us equation (7):

$$a = \frac{d^2 R}{dt^2} + \frac{d\omega}{dt} \times R + 2\omega \times \frac{dR}{dt} + \omega \times (\omega \times R). \quad (7)$$

Here the first term on the right-hand side is any acceleration that may be imparted to the earth (the central point). The second term, $\left(\frac{d\omega}{dt} \times R \right)$, is the *Euler force*, which is not of interest here since it only kicks in if the length of the day changes significantly over the course of a day. The third term (starting with the 2), is the Coriolis force and the last term [$\omega \times (\omega \times R)$] is the centrifugal force.

The Coriolis and centrifugal forces dominate the motion of the sun, planets, and stars in a geocentric system. We shall thus eliminate the Euler and local acceleration terms of equation (7) and work with:

$$a = -2\omega \times v - \omega \times (\omega \times R) \quad (8)$$

where v is the orbital speed of the star. Since the firmament rotates and not the earth, the sign of v is in the opposite direction to the heliocentric system, and is thus negative. The v in equation (8) is thus replaced by $-\omega \times R$.

After expanding v , equation (8) is now:

$$a = 2\omega \times (\omega \times R) - \omega \times (\omega \times R);$$

or

$$a = \omega \times (\omega \times R). \quad (9)$$

Distributing the cross-product through the term in parentheses gives us:

$$a = \omega(\omega \cdot R) - R(\omega \cdot \omega). \quad (10)$$

Now the star is not located on the equator but at declination δ , whence the $\omega \cdot R = D\omega \sin(\delta)$.

Our final equation for the geocentric system is thus:

$$a = -\omega^2 (R - D\hat{\omega} \sin(\delta)). \quad (11)$$

Here $\hat{\omega}$ is a unit vector pointing along the rotation axis, that is, in the direction of ω which is perpendicular to the equator in general and here in the plane of the star's circle in Figure 1. This keeps the acceleration experienced by the star confined to the star's latitude, swept out by R and noted as the "Star's daily path" in Figure 1.

Let's Examine Our Results Thus Far

Equation (11) has two components, two vectors. They are pictured in Figure 2 where they are shown as acceleration vectors.

To make them dynamic, multiply each by the star's mass. The acceleration pictured by the sine term is aligned

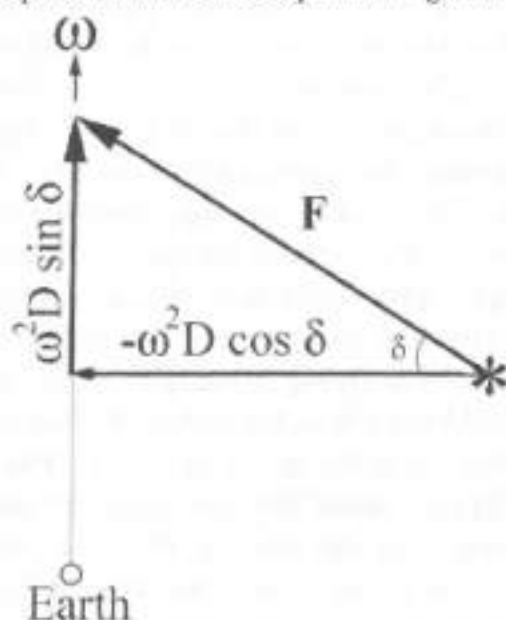

Figure 2: Accelerations (Forces)

along the rotation vector, ω , and serves to keep the star's rotational plane from "falling" up or down the rotational axis. The second component is the cosine term. That acceleration pulls the star towards the axis of rotation. If multiplied by the star's mass it becomes a centripetal (non-fictitious) force, meaning that it pulls the star towards the axis of rotation. The net result of these two accelerations is to keep the star in its place in the inertial field of the universe which is the gravitational field of the firmament.

Of course, equation (11) is kinematic, not dynamic and we have to show the geocentric model is dynamically correct. To do that, all we have to do is to multiply both sides by the star's mass, m :

$$F = ma = -m\omega^2 (R - D\hat{\omega}\sin(\delta)) \quad (12)$$

The above analysis is the case for the sun, moon, any planet, artificial satellite, or star circling the earth. Yet some will ask, "What about the speed of light? Won't the distant planets and stars orbit the earth way above the speed of light?"

The answer is, "No." The speed of light is determined by the firmament. It is the firmament that rotates once a day and so photons also participate in the daily rotation. Light, will also obey the above equations superimposed on its own motion. To object that it still exceeds the speed of light we answer that the speed of light speed limit does not apply for rotation. In this case it is equivalent to claiming that when the Concorde supersonic jets were still flying passengers faster than the speed of sound, you could not talk to the person in front of you because you were flying faster than the speed of sound. But the air in the plane, too, was "flying" faster than the speed of sound, so you could talk to the person in the seat in front of you because the sound-bearing medium was being carried with you, even as the light-bearing medium is carried with the sun, moon, and stars in the daily rotation of the firmament.

Conclusion

We have shown that the physics of the geocentric universe accounts perfectly for what we see and measure of the daily rotation whether that rotation is of the earth within the universe or the universe around the earth. In the final analysis, proofs based on dynamical equations are not proofs of anything; nor are they proofs against the geocentric universe.

CHAPTER NOTES

Chapter 2

¹ Morgan, Augustus de, 1872. *A Budget of Paradoxes*, 2nd edition; D. E. Smith, ed., 1915, (Chicago & London: The Open Court Publishing Co.), I, p. 36.

² Russell, B. 1935. *Religion and Science*, (London, Oxford, New York: Oxford University Press), p. 11 of the 1970 edition.

³ *Ibid.*, p. 16.

⁴ *Ibid.*, p. 244.

⁵ Jacobs, Rabbi L. *Jewish Cosmology*, in *Ancient Cosmologies*, ed. by C. Blacker and M. Loewe, (London: George Allen & Unwin Ltd.).

⁶ Anonymous. 1976. The Divine Word in Human Words. *The Other Side*, May-June, p. 45. Quote is from pp. 50 through 51.

⁷ Kuhn, T. S., 1970. *The Structure of Scientific Revolutions*, 2nd ed., p. 137.

Chapter 3

¹ Letronne, Antoine-Jean, 1834. *On the Cosmographical Ideas of the Church Fathers*. Letronne was a devout atheist who made it his life's goal to discredit Christianity.

² Russell, Jeffrey, 1991. *Inventing the Flat Earth: Columbus and Modern Historians*, (New York: Praeger).

³ Augustine, Aurelius. *City of God*, XVI, 9.

⁴ Danaeus, L. 1578. *The Wonderfvl VVoorkmanship of the World*, translated by T. Twyne, (London: Andrew Maunsell), folio 19.

⁵ Santillana, G. de, and H. von Dechend. 1969. *Hamlet's Mill*, (Boston: Gambit).

⁶ Schadewald, Robert J., ed. by his sister, Lois A. Schadewald, 2008. *Worlds of their Own: A Brief History of Misguided Ideas: Creationism, Flat-Earthism, Energy Scams, and the Velikovsky Affair*, (Xlibris Corp.), pg. 147.

Chapter 4

¹ Faulkner, Danny, 2001. "Geocentrism and Creation," *Creation Ex Nihilo Technical Journal*, 15(2):110-121, p. 110. Also see Russell Humphreys, 2002. "Our Galaxy is the Centre of the Universe, 'Quantized' Red Shifts Show," *Creation Ex Nihilo Technical Journal*, 16(2):95-104, p. 104, endnote 35. Both men falsely insist that I claim Psalm 93:1 as my most important geocentric verse in my 1992 edition of *Geocentricity*, yet neither can produce a reference to that claim.

Chapter 6

¹ Bouw, G. D., 2007. "Vistas in Time II: the Linguistics," *The Biblical Astronomer*, 17(121):77.

² Bouw, G.D., 1996. "Theory of Theories: Parts 1 and 2," *Biblical Astronomer*, 6(77 & 78):22, 18 respectively.

³ Aspden, Harold, 1972. *Modern Ether Science*, (Southampton: Saberton Publications).

⁴ Estrada, David, and William White Jr., 1978. *The First New Testament*, (Nashville: Thos. Nelson).

⁵ $D_U = 4 \times 10^{28}$ cm, $D_P = 2 \times 10^{33}$ cm $\Rightarrow (0.5 \times 10^{33} / 4 \times 10^{28}) = 12,500$.

⁶ Aspden, Harold, 1961. *History of Western Philosophy*, (London: Allen and Unwin), p. 86. Note that Russell's discovery negates the existence of true, linear momentum. That explains why momentum is not conserved in some cases and why certain experiments, such as Airy's failure fail to detect it.

⁷ For more on this theory see: Bouw, G. D., 2007. "Vistas in Time I: the Physics," *Biblical Astronomer*, 17(121):71 and "Vistas in Time II: the Linguistics," *B. A.*, 17(121):77 and "Vistas in Time III: Time sheets," *B. A.*, 17(122):93.

Chapter 7

¹ Cemitara, Hercules, and Gerardus D. Bouw, 2006. "The Gap Theories of Creation," *Biblical Astronomer*, 16(117):77.

² Wilkins, John, 1708. *The Mathematical and Philosophical Works of the Right Reverend John Wilkins*—book 2: A Discourse Concerning a New Planet, Tending to Prove, that (It is Probable) Our Earth is One of the Planets. The 1802 edition of the works was reproduced in 1970 by Frank Cass & Co. Ltd., London. Quote is from pg. 153.

³ Strong's H8622 which has as its root word, *nawka* (H5362), meaning *to enclose, to encompass, to go round about; circulate*. The application is war-like.

⁴ Humphreys, D. Russell, 1994. *Starlight and Time*, (Colorado Springs: Master Books), p. 28. Also, 2002, "Our Galaxy is the Centre of the Universe," *Technical Journal*, 16(2):95-104.

⁵ Preliminary analysis of the radial velocities of galaxies projected upon the plane of the Supercluster yielded a curve shaped the way expected if the galaxies and their clusters were orbiting the center of the Supercluster. The work, done in the early 1980s, was never finished and never published.

⁶ Bouw, G. D. 1978. "Psalm 19 v. 6: Galactocentric or Heliocentric?" *Bulletin of the Tychoian Society*, No. 22, p. 1.

⁷ This theory was introduced in 1972 by David A. Kirzhnits and Andre Linde at the P. N. Lebedev Physics institute in Moscow.

Chapter 8

¹ Deane, Rev. W. J. *Joshua, His Life and Times*, (New York: Fleming H. Revell Co.), p.86.

² Maunder, E. W., 1908. *The Astronomy of the Bible*, (New York: Mitchell Kennerly), pp. 375 ff.

³ Ramm, B., 1955. *The Christian View of Science and Scripture*, (Grand Rapids: Wm. B. Eerdmans Publ. Co.), pp. 156-161.

⁴ Collett, 1933. *All About the Bible*, pp. 283-288.

⁵ Boling, R. G., 1982. "Joshua," in *The Anchor Bible*, (New York: Doubleday and Co., Inc.)

⁶ *Ibid.*, p. 274 versus p. 284.

⁷ James, 1917. "Hymn of Deborah," in *Biblical Antiquities of Philo*.

⁸ Israel, R. Manasseh Ben, 1972. *The Conciliator of R. Manasseh Ben Israel*, (New York: Hermon Press). This edition contains both volumes of the mid-seventeenth century work. Volume 2, question 10, pp. 12-18.

⁹ Wilson, R. D., 1930. "Understanding the Sun Stood Still," in *Classical Evangelical Essays in Old Testament Interpretation*, Walter C. Kaiser, Jr., ed., pp.61-65.

¹⁰ *Ibid.*, p. 63.

¹¹ *Ibid.*, p. 64.

¹² *Ibid.*, p. 64.

¹³ Bolling, *Op. cit.*

¹⁴ Bouw, *Op. cit.*

¹⁵ Faulstich, E. W., 1987. "Joshua's Long Day...or Joshua's Miraculous Day?" *Its About Time*, January 1987-Shebat 5987, pp. 2-5.

¹⁶ Keil and Delitzsch, 1870. *Commentary on the Old Testament*, (Wm. Eerdmans Publ. Co.)

¹⁷ Gaussen, 1841. *The Divine Interpretation of the Bible*, pp. 246-251.

¹⁸ Velikovsky, I., 1950. *Worlds in Collision*, (New York: Dover Press).

¹⁹ Rand, H. B. 1968. *When the Earth Turned Over* (Merrimac Mass. 01860: Destiny Publishers).

²⁰ Hanson, J. N. 1978. *Creation Research Society Quarterly*, 15(1):55.

²¹ Virgil. *Aeneid*, Book IV, 1, 489. Page 105 of Rofe Humphries, translator, 1951. (NYC: Scribners).

²² Totten, C. A. L., 1891. *Joshua's Long Day and the Dial of Ahaz, A Scientific Vindication and A Midnight Cry*, 3rd Edition, (New Haven: Our Race Publ. Co.) Reprinted in 1968 by Destiny Publishers, Merrimac, Mass.

²³ Olden, R. L., 1970. "The Lost Day of Joshua," *Ministry*, (November/December). The publication is put out by the Seventh Day Adventists.

²⁴ The translation that follows came from the Cercle Scientifique et Historique, France and Belgium. It is presumably taken from among Crombette's three volumes of *Verdique Historique de l'Égypte Antique*.

²⁵ Aardema, V., 1975. *Why Mosquitoes Buzz in People's Ears*, (New York: Dial Press).

²⁶ Martin. *Sinie. Histor. I. 1.* p. 25.

²⁷ Gill, John. 1810. *An Exposition of the Old Testament* (London: Matthews and Leigh), vol. 2, p. 831. Gill's work was reprinted in 1979 under the title *Gill's Expositor*, (Streamwood, Illinois: Primitive Baptist Library).

²⁸ Bouw, *Op. cit.*

²⁹ Hübner, J., 1733. *Kurtze Fragen aus der Politischen Historia*.

³⁰ Olcott, W. T., 1914. *Sun Lore of all Ages*, (NY: G. P. Putnam's Sons).

³¹ *Ibid.*, p. 212.

³² *Ibid.*, p. 215.

³³ *Ibid.*, p. 216.

³⁴ *Ibid.*, p. 217.

³⁵ *Ibid.*, p. 218.

³⁶ Coffin, Tristram, ed., 1961. *Indian Tales of North America: An Anthology for the Adult Reader*, (Austin: Univ. of Texas Press), p. 105.

³⁷ Caso, A. 1937. *The Religion of the Aztecs*, (Mexico City: Popular Library of Mexican Culture, Central News Co.), pp. 15-16.

³⁸ Goetz, D. and S. G. Morley, translators, 1972. *Popul Vuh: The Sacred Book of the Quiché Maya*, (Norman, Oklahoma), Part III, Chapters 4-7, pp. 172-190.

³⁹ Bancroft, H. H., 1883. *Native Races of the Pacific States*, (5 volumes), Vol. 3, pp. 58-62.

⁴⁰ Montesinos, F., 1882. *Memorias Antiguas Historiales de Peru*. The manuscript for that book dates from 1648. A translation of it was done by P. A. Means for the Habluyt Society of London in 1920. Notes from Z. Stichin, *The Lost Realms*, (New York: Avon Books), Ch. 7.

⁴¹ Frazer, J. G., 1914. "The Magical Control of the Sun," *Golden Bough*, 3rd ed., 1:316.

⁴² Olcott, *op. cit.*, p. 208.

⁴³ Olcott, *op. cit.*, 86.

⁴⁴ Olcott, *Op. cit.*, p. 96.

⁴⁵ Hill, H. "How to Find a Missing Day," *How to Live Like a King's Kid*, (Baltimore: Logos), Chapter 13, pp. 65-77.

- ⁴⁶ Hill, H. 1984. Private correspondence. Letter dated October 1.
- ⁴⁷ Hill, *How to Live Like a King's Kid*, p. 66.
- ⁴⁸ 1978. "Five Minutes With the Bible and Science," *Bible-Science Newsletter*, 8(5):1-2.
- ⁴⁹ Hill, in the 1984 letter.
- ⁵⁰ Brosche, P., & J. Sundermann, eds., 1978. *Tidal Friction and the Earth's Rotation*, (New York: Springer-Verlag), p. 12.
- ⁵¹ Lang, Walter, 1991. *Job and Science*, (Richfield, MN), pp. 5-6.
- ⁵² Based on computer calculations by the author.

Chapter 9

- ¹ Maunder, Edward Walter, 1908. *The Astronomy of the Bible*, (New York: Mitchell Kennerly), pp. 385 ff.
- ² Peterson, I. 1990. "Turning Back Time," *Science News*, 137(6):91.
- ³ Forke, A. 1925. *The World Conception of the Chinese*, pp. 86-87. Forke confuses this account with Joshua's long day.
- ⁴ J. Gill, 1810. *An Exposition of the Old Testament*, (London: Matthews and Leigh), Vol. 2, p. 831. Gill's work was reprinted in 1979 under the title Gill's Expositor, (Streamwood, Ill. 60103: Primitive Baptist Press).
- ⁵ Helfferich, Carla, 1990. "The Double Dawn in the Time of King Yi," Article #960, Alaska Science Forum, Geophysical Inst., Univ. of Alaska Fairbanks, Jan. 11. <http://www.gi.alaska.edu/ScienceForum/index.html>.
- ⁶ Lowie, Robert H., 1924. "Shoshonean Tales," *Journal of American Folklore*, 37:298.
- ⁷ Thompson, S. 1929. *Tales of the North American Indians*, pp. 42-43.
- ⁸ Olcott, W. T., 1914. *Sun Lore of all Ages*, (NYC: G. P. Putnam's Sons), pp. 131-132.
- ⁹ A. Caso, 1937. *The Religion of the Aztecs*, (Mexico City: Popular Library of Mexican Culture, Central News Co.), pp. 15-16.
- ¹⁰ Goetz, D. and S. G. Morley, translators. 1950. *Popul Vuh: The Sacred Book of the Ancient Quiche-Maya is Volume 29 in The Civilization of the American Indian Series*. Translated from the Spanish translation of Adrian Recinos. Pp. 151-152.
- ¹¹ Sitchin, Z. *The Lost Realms*, Book 4 of *The Earth Chronicles*. (New York: Avon Books), p. 151.
- ¹² Frazer, J. G., 1914. *Golden Bough*, (third edition), 1:316.
- ¹³ Olcot, 1914. *Op. Cit.*, p. 206.

Chapter 10

¹ Burgess, A. J., 1976. December issue of *Christian Century*, p. 1100.

² *Ibid.*

Chapter 11

¹ Strouse, Thomas M., 2007. *He Maketh His Sun to Rise: A Look at Biblical Geocentricity*, (Bible Baptist Theological Seminary; 40 Country Squire Rd., Cromwell, CT 06416).

Chapter 12

¹ Kline, M. 1972. *Mathematical Thought From Ancient to Modern Times*, (New York City: Oxford University Press), p. 246.

² Burgess, A. J. 1976. December issue of *Christian Century*, p. 1100.

³ Hanson, James N., 2005. *The Bible and Geocentricity*, (Cleveland, OH: Association for Biblical Astronomy), 56.

⁴ Allaben, Frank. 1900. "The Biblical Tychoenic vs. the Newtonian-Copernican System," in *The Earth Stands Fast*, p.31.

⁵ *Ibid.*, p. 79.

⁶ This section is reproduced with minor changes in the last paragraph from: Hanson, James N., *Op. cit.*, pp.54-56. Also, 1991. *Biblical Astronomer*, 1(55):33-35.

⁷ Swedenborg, E., 1734. *Principia*.

⁸ Grinnell, G., 1976. *Kronos*, 1:68. Also see R. Porter, 1977. *The Making of Geology*, (New York: Cambridge Univ. Press) and K. L. Taylor, 1978. *Science*, 199:166.

⁹ Terletsii, Ya. P., 1968. *Paradoxes in Relativity*, (New York: Plenum Press), pg. 9.

¹⁰ Turner, D. 1979. In Turner and Hazlett, eds. *The Einstein Myth and the Ives Papers*, (Old Greenwich, Conn.: Devin-Adair Co.). Einstein Myth, p. 17.

¹¹ Russell, B., 1969. *The ABC of Relativity*, third revised edition, ed. by F. Pirani, (New York: Mentor Books), p. 141.

Chapter 13

¹ Whitcomb, John, D. and Donald B. de Young, 1978. *The Moon: Its Creation, Form, and Significance*, (Winona Lake: BMH Books), pg. 15.

² *Ibid.*, pg. 67.

Chapter 14

¹ Lang, Walter, 1978. *Bible-Science Newsletter: Five Minutes with Bible and Science*, vol. 8, p. 2. By 1985 Walter Lang had abandoned his heliocentric claim for Job 38:14 and ultimately became a Geocentrist.

Chapter 15

¹ Pausanias On Nero 2.37.5.

² Thompson, D'Arcy Wentworth, *Glossary of Greek Birds*, xvii.

³ Wright, Thomas, 1750. *An Original Theory of the Universe*.

⁴ Seiss, J. A. 1882. *The Gospel in the Stars*. Reprinted 1972 (Grand Rapids: Kregel Publications), pp. 104-106.

⁵ Bullinger, E. W. 1893. *The Witness of the Stars*. Reprinted 1967 (Grand Rapids: Kregel Publications), pp. 124-129.

⁶ Hislop, A. 1916. *The Two Babylons*, (Neptune, NJ: Loizeaux Brothers).

Chapter 16

¹ Schiaparelli, G. 1905. *Astronomy in the Old Testament*, (Oxford: Clarendon Press), p. 55.

Chapter 17

¹ Whitcomb, John, 1978. In response to a question about the reality of Joshua's Long Day at a creation-science lecture at Cedar-Hill Baptist Church, Cleveland Heights, Ohio.

Chapter 18

¹ Misner, C. W., K. S. Thorne & J. A. Wheeler, 1973. *Gravitation*, (New York City: W. H. Freeman and Co.), p. 1119.

Chapter 19

¹ Hoyle, Fred, 1975. *Astronomy and Cosmology: A Modern Course*, (San Francisco: W. H. Freeman & Co.), p. 416.

Chapter 20

¹ Danaeus, L. 1578. *The Wonderful VVoorkmanship of the World*, translated by T. Twyne, (London: Andrew Maunsell), folio A. iii.

Chapter 21

¹ Nelson, Benjamin, 1968. "The Early Modern Revolution in Science and Philosophy: Fictionalism, Probabilism, Fideism, and Catholic 'Prophetism,'" in *Boston Studies in the Philosophy of Science*, edited by R. S. Cohen and M. Wartofsky. (Dordrecht: Reidel), 3, p. 12.

² Wurmbrand, Richard, 1976. *Was Marx a Satanist?* (Diane Books).

³ Lasky, M. J., 1975. "Discussion: Ramifications of the Word 'Revolution,'" in *The Nature of Scientific Discovery*, edited by O. Gingerich, (Washington D.C.: Smithsonian Inst. Press), p. 498.

⁴ Thiel, R., 1957. *And There Was Light*, translated by R. and C. Winston, (New York City: Alfred Knopf), p. 74.

⁵ *Ibid.*, p. 80.

⁶ Gingerich, Owen, 2004. *The Book Nobody Read*, (NYC: Penguin Books), p. 58.

⁷ Bronowski, Jacob, 1975. "Copernicus as Humanist" in Lasky, *op cit.*, pp. 186-187. Also see Nelson, *op cit.*, 3:12.

⁸ Nelson, B., 1968. *Op cit.*

⁹ Hoyle, Fred, 1973. *Nicolaus Copernicus*, (NYC: Harper-Row Publishers), Chapter 2.

¹⁰ Thiel, R., 1957. *Op Cit.*, p. 881.

¹¹ Frish, C., ed. 1858. *Apologia Tychonis Contra Ursum, Kepler Opera Mundi*, (Frankfurt), 1:246.

¹² Burmeister, K. H., 1968. *Georg Joachim Rheticus 1514—1574, III: Briefwechsel* (Wiesbaden), p. 25.

¹³ Oberman, H. A., 1975. "Reformation and Revolution: Copernicus' Discovery in an Era of Change" in Lasky, M. J., *op cit.*, pp. 163-164, notes 28 & 30.

¹⁴ Copernicus, Nicholas, 1543. *De Revolutionibus Orbium Coelestium*, book 1, chapter 10, folio 9v.

¹⁵ Danaeus, Lambert, 1578. *The Wonderfull VVoorkmanship of the World*, translated by T. Twyne, (London: Andrew Maunsell), folio 30.

¹⁶ *Table Talks*, pps. 358-359, Vol. 54 of the American edition of Luther's works. Also see: L. Prowe, 1883. *Nicolaus Copernicus*, (Berlin), book 1, vol. 2, p. 232. Also see Oberman, H. A., 1975. "Reformation and Revolution: Copernicus' Discovery in an Era of Change" in Lasky, *op cit.*, note 37, p. 139.

¹⁷ Thiel, *op cit.*, p. 88.

¹⁸ Bretschneider, C. G., ed. 1834-1860. *Corpus Reformatorum: Philippi Melanthonis Opera*, (Berlin), 4, p. 679. (A 38-volume set.)

¹⁹ Melanchthon, Philipp, 1883. *Doctrinae Physicae Elementa*, (Basel), Book 1, p. 56.

²⁰ Melanchthon, P., "Initia Doctrinae Physicae" in *Opera Omnia*, vol. 13 of *Corpus Reformatorum*, ed. By C. Bretschneider, (n.p., 1834), 216, 217.

²¹ Rosen, Edward, 1960. "Calvin's Attitude Toward Copernicus," *Journal of the History of Ideas*.

²² Oberman, *op cit.*, p. 139. Also see his comment there on p. 511.

²³ Quoted in William J. Bouwsma, 1988. *John Calvin: A Sixteenth Century Portrait*, (New York: Oxford Univ. Press), p. 72.

²⁴ Pearcey, Nancy R., and Charles B. Thaxton, 1994. *The Soul of Science: Christian Faith and Natural Philosophy*, (Wheaton, IL: Crossway), 64.

²⁵ Lee, F. N., 1969. *Calvin on the Sciences*, (Foxton, England: Burlington Press). Lee quotes from Calvin's *Institutes*, I:5:2—"...when God's scientists investigate the motions of the heavenly bodies...the mind takes a loftier flight, and obtains brighter views of His glory."

²⁶ King, John, translator, 2005. *Calvin's Commentaries*, 22-Volume Set, Vol. 1, Genesis, (Grand Rapids: Baker Books), pgs. 86-87.

²⁷ Lee, *Loc. cit.*, p. 41.

Chapter 22

¹ Erasmus, D., *The Praise of Folly*. Translated by J. P. Dolan, 1964. (NYC: New American Library), p. 142.

² Gingerich, Owen, 1975. "Science and Society in the Sixteenth Century," in *The Nature of Scientific Discovery*, edited by O. Gingerich, (Washington D.C.: Smithsonian Inst. Press), p. 311.

³ Gilberti, Guilielmi, Colcestensis, Medici Londinensis, 1600. *De Magnete, Magneticisque Corporibus, Et De Magno Tellure*, (London: P. Short), sigs *4v-*5r. Translation is from the Gilbert Club; see reference 31, p. 219.

⁴ Kepler, Johannes, 1596. *Prodiomus Dissertationum Cosmographicarum seu Mysterium Cosmographicum*, (Tubingen).

⁵ See any elementary astronomy or physics text for a complete explanation of Kepler's three laws.

⁶ Kepler, J., 1619. *De Harmonice Mundi*, (Augsburg), p. 271. Quoted in E. W. Gerdes, "Johannes Kepler as Theologian" in A. Beer and P. Beer, eds., 1975. *Vistas in Astronomy*, 18, (NYC: Pergamon Press), p. 359.

⁷ Johnson, F. R., 1937. *Astronomical Thought in Renaissance England* (Baltimore: Johns Hopkins Press), p. 39.

⁸ Thiel, R., 1957. *And There Was Light*, translated by R. and C. Winston, (NYC: Alfred Knopf), p. 119. The quote is translated from Kepler's *Mysterium Cosmographicum*.

⁹ In answer to the last question of Book I of Kepler's *Epitomie Astronomiae Copernicanae*.

¹⁰ *Ibid.*

¹¹ Kepler, J., 1619. *Op cit.* Also see: Sir O. Lodge in *The World of Mathematics*, 1, ed. by J. R. Newman, (NYC: Simon and Schuster Inc.), p. 232.

¹² Lear, John, 1965. *Kepler's Dream*, (Berkeley and Los Angeles: Univ. of California Press), p. 31.

- ¹³ Broad, William J., 1990. "After 400 Years, a Challenge to Kepler: He Fabricated His Data, Scholar Says," *New York Times*, (New York Edition) January 23, pg. C1.
- ¹⁴ Doig, P., 1950. *A Concise History of Astronomy*, (London: Chapman and Hall Ltd.), pp. 64-65.
- ¹⁵ Smart, W. M., 1968. *The Riddle of the Universe*, (London: Longmans Green & Co., Ltd.), pp. 26-27.
- ¹⁶ Wilder, J. B., *The Other Side of Rome*, (Grand Rapids: Zondervan Publ. House), p. 156.
- ¹⁷ Anonymous, 1966. "Bij de Sluiting van de Concilie", *Tot Vrijheid Geroepen*, 12(2):29, Feb.
- ¹⁸ From the speech reprinted in *L'Osservatorio Romano*, October 10, 1989.
- ¹⁹ Redondi, P., 1985. *Galileo Heretique*, (Paris). Translated by M. A. Calimard. For a review, see *Science*, 233:612.
- ²⁰ Stoddard, Ed., 2009. "New Galileo Book Raises Religious, Science Issues," Reuters, Jul. 20, http://news.yahoo.com/s/nm/20090720/lf_nm_life/us_books_galileo_1.
- ²¹ Drake, Stilman, 1978. *Galileo at Work: His Scientific Biography*, (Chicago: Univ. of Chicago Press), p. 225.
- ²² *Ibid.*, p. 248.
- ²³ Hughes, M. Y., ed., 1935. *Paradise Lost by J. Milton*, (NYC: Odyssey Press, Inc.), note 364, p. 232. The reference in Pliny is vol. 2, iv, 6 of his *Natural History*.
- ²⁴ Drake, *op cit.*, p. 417.
- ²⁵ Drake, *op cit.*, pp. 417-418.

Chapter 23

- ¹ King, I., 1976. *The Universe Unfolding*, (San Francisco: W. H. Freeman & Co.), p. 126.
- ² Whitaker, E. A., 1978. *Sky and Telescope*, 56(5):380-382.
- ³ Carpenter, N., 1625. *Geography Delineated Forth in Two Bookes*, (Oxford: J. Lichfield for H. Cripps). Volume 1 is on astronomy, vol. 2 is on geography.
- ⁴ Boss, V., 1972. *Newton and Russia: The Early Influence 1698-1796*, (Cambridge, Mass.: Harvard Univ. Press), p. 55.
- ⁵ Wilkins, John, 1708. *The Mathematical and Philosophical Works of the Right Reverend John Wilkins—book 2: A Discourse Concerning a New Planet, Tending to Prove, That (It Is Probable) Our Earth is One of the Planets*. Quotations are from a 1970 reproduction of the 1802 edition (London: C. Wittingham) by Frank Cass & Co. Ltd., London. P. 153.
- ⁶ *Ibid.*, p. 152-154.
- ⁷ *Ibid.*, p. 155.
- ⁸ *Ibid.*, p. 156.
- ⁹ *Ibid.*, p. 164-166.

¹⁰ *Ibid.*, p. 166.

¹¹ See, for example, J. D. Worthington, 1968. *You're Speeding Eighteen-and-a-half Miles per Second*. (Atlanta: Holland Print Shop, Inc.)

¹² Cassini, J. D., 1693. *De L'Origine et de Progres de L'Astronomie*, Mem. de l'Acad. R. des Sciences, 7, p. 43.

¹³ Cunningham, J., 1789. *An Inquiry into the Copernican System*, (London). Or see W. Wood, 1819. *Astronomy Made Plain; or the only Way the True Perpendicular Distance of the Sun, Moon, or Stars, from the Earth, can be Obtained*. (Chatham).

¹⁴ See, for example, Lander, Sen., W., 1833. *David and Goliath*, (Mere, Wilts.).

¹⁵ Hunter, H., translator, 1795. *Letters of Euler... to a German Princess on Different Subjects in Physics and Philosophy*, (London). (Second edition, 1802). Two volumes. Vol. 1, letter 18, pp. 73-74.

Chapter 24

¹ Brahe, Tycho, "Brahe to Rothmann 21 February 1589" in *Tychonis Brahe Dani Opera Omnia*, 15 vols., ed. By I. Dreyer (Haunia: Nielson & Lydiche), 1913. Vol. 6, p.176, lines 36-40.

² Johnson, Francis R. 1937. *Astronomical Thought in Renaissance England: A Study of the English Scientific Writings from 1500 to 1645*, (Baltimore: Johns Hopkins Press), p. 222.

³ Hoyle, Sir Fred, 1975. *Astronomy and Cosmology – A Modern Course*, (San Francisco: W. H. Freeman & Co.), p. 416.

⁴ Brahe, T., *op. cit.*, vol. 6, p. 177, lines 12-19.

⁵ Howell, Kenneth J., "Copernicanism and the Bible in Early Modern Science," chapter 16 in J. M. van der Meer, ed., *Facets of Faith and Science*, (The Pascal Centre for Advanced Studies in Faith and Science, Redeemer College, Ancaster, Ontario, Canada and University Press of America Inc., Lanham, New York, London), vol. 4, "Interpreting God's Action in the World," p.261. Quote is on p. 268.

⁶ Johnson, Francis R., *op. cit.*, p. 289.

⁷ My apologies to William Shakespeare, *Hamlet*, Act I scene 5.

⁸ For details of the analysis and circumstances surrounding Tycho's death, including eulogies intimating foul play the reader is referred to Joshua and Anne-Lee Gilder, 2004. *Heavenly Intrigue*, (NYC: Doubleday).

⁹ Pallon, Jan, 1996. "Did Mercury Poisoning Cause the Death of Tycho Brahe?" Press release posted on the Internet and dated Wednesday July 3, 1996.

¹⁰ Conner, James A., 2004. *Kepler's Witch: An Astronomer's Discovery of Cosmic Order Amid Religious War, Political Intrigue, and the Heresy Trial of His Mother*, (San Francisco: HarperCollins Publishers, Inc.), p. 159.

¹¹ Pancevski, Bojan, 2009. "Hamlet may have Poisoned Stargazer Tycho Brahe in Mercury Murder," from the *Times*, January 23, 2009, www.timesonline.co.uk/tol/news/world/europe/article5569868.ece.

¹² Rasmussen, K. L., J. Kucera, L. Skytte, J. Kamenik, V. Havranek, J. Smolik, P. Veleminsky, N. Lynnerup, J. Bruzek, and J. Vellev, 2012. "Was He Murdered Or Was He Not? —Part I: Analysis of Mercury in the Remains of Tycho Brahe," *Archaeometry*. As of this writing I have no further information on the paper.

Chapter 25

¹ Rabinowitz, Avi, 1986. "Geocentrism," *B'Or Ha Torah*, No. 5, pg. 7.

² For a long time I have known that the Cassinis were geocentrists, albeit not Tychonians. Little evidence remains in the common literature and Internet articles about their geocentric stance. My original source was Delambre who quoted from Cassini's 1693 book, *De l'origine et du progress de l'Astronomie, et de son usage dans la Géographie et la Navigation*. The quote starts as follows: «Comme les Coperniciens attribuent deux mouvements à la Terre...» which translates, "As the Copernicans assign two movements to the earth..." thus revealing Cassini's anti-Copernican sentiment. The quote is from Delambre, 1821. *Historie de l'Astronomie Moderne*, vol. 2, (Paris), p. 733.

³ Hanson, James N., 2001. "Cassini: His Ovals and Geocentricity," *The Biblical Astronomer*, 11(96):37. Hanson reviews what little is known and understood about Cassini's ovals and presents methods in which they can be used to trace two-dimensional orbits and proposes that the ovals have application for three-dimensional orbits.

⁴ Leverrier, Urbain J. J., 1859.

⁵ Curé, Jorge C., 1991. "The Perihelic Rotation of Mercury by Newton's Original Method," *Galilean Electrodynamics*, 2(3):43.

⁶ Tischner, August, 1885. *Sta, Sol, Ne Moveare*, (Leipzig: Gustav Fock).

⁷ Tischner, August, 1885. *The Fixed Idea of Astronomical Theory*, (Leipzig: Gustav Fock). Hereafter referred to as "Fixed." A reprint of the English edition was published by the Association for Biblical Astronomy in 2009.

⁸ Tischner, August, 1883. *The sun changes its position in space, therefore it cannot be regarded as being "in a condition of rest" ...* (Leipzig: Gustav Fock).

⁹ Tischner, 1885. *Fixed*, "To the Reader."

¹⁰ *Ibid.*, p. 33. Von Humboldt's quote in the original is: "Das habe ich auch längst gewusst, dass wir noch keinen Beweis für das kopernikanische System haben, aber als erster es anzugreifen, würde ich nie wagen. Stoßen Sie nicht in dieses Wespennest; Sie werden sich nur den Hohn der urteilslosen Menge zuziehen. Erhebt sich einmal ein Astronom von Namen gegen die heutige Anschauung, so werde auch ich meine Beobachtungen mitteilen, aber als erster gegen Ansichten aufzutreten, die der Welt lieb geworden sind, verspüre ich nicht den Mut." The quotations are from pgs. 33-35.

¹¹ *Ibid.* Translation by Pasche.

¹² Schöpffer, C., 1854. *Die Bibel lügt nicht! Erklärung der mosaischen Schöpfungs-Urkunde, oder: Beweis, daß die biblische Lehre von der*

Erschaffung der Welt in ihrer wörtlichen Auffassung auf das Genaueste mit den wahren Resultaten der Wissenschaft stimmt, Nordhausen, Adolph Büchting.

¹³ Blavatsky, H. P., *Collected Writings, Articles*, vol. 3, pg. 312, 1881.

http://www.katinkahesselink.net/blavatsky/articles/v3/y1881_088.htm.

¹⁴ Schöpffer, C., 1869. *Die Widersprüche in der Astronomie, wie sie bei der Annahme des Copernikanischen Systems entstehen, bei der entgegengesetzten aber verschwinden, mit einer lithographierten Figurentafel*, Berlin, Verlag Eduard Beck.

¹⁵ The translation of Knak's biographical sketch upon which this section is based is due to J. H. Thon, 1972. *Space and the Universe*, (Germany: Morgenland Verlag).

¹⁶ Knak, Gustav Friedrich Ludwig, and Gustav Lico, 1868. *Die kopernikanische Wahrheit und das Christliche Dogma. Ein durch den Knak-Lisco'schen Streit veranlasster Beitrag zur religiösen Orientirung der Gegenwart*.

¹⁷ Wangemann, Hermann Theodor, and Gustav Friedrich Ludwig Knak, 1868. *Pastor Knak und seine Gegner. Ein Beitrag zur Orientirung in den Motiven des neuesten Kirchenstreltes*.

¹⁸ Salant, Nathan, 1982. *Superstars, Stars, and Just Plain Heroes*, (Briar Manor: Stein and Day), p. 17.

¹⁹ Schöpffer, C., 1900. *The Earth Stands Fast: A Lecture Delivered by Professor C. Schoepffer, Seventh Edition published in Berlin, in 1868*. Translated by De Peyster with notes and supplement by Frank Allaben, Historiographer and Scientist. (New York: Chas. H. Ludwig, printer).

²⁰ De Peyster, John Watts and Frank Allaben, 1900. *Algol: the Ghoul or Demon Star, A Supplement to the Earth Stands Fast, (1900)*. (New York: Chas. H. Ludwig, printer). Referred to as "Algol" below.

²¹ Pasche, Frederick E., 1906. *Die Bibel und Astronomie*, (Milwaukee: Germania Publishing Co.) The book runs for 407 pages in old German blackface font.

²² Quoted from Mc. Laughlin, Rev. Wallace H., 1952. "Inspiration, Inerrancy, and Inviolability of Holy Scripture," An essay presented at the Second Annual Convention of the Orthodox Lutheran Conference, August 1952.

²³ Stimson, Dorothy, 1917. *The Gradual Acceptance of the Copernican Theory of the Universe*, (Gloucester, Mass.: Peter Smith), reprinted 1972, pp. 99-100.

²⁴ Lang, J. R. L., 1895. *Die Unhaltbarkeit des Kopernikanischen Systems*, (Chicago: L. Lange Jr., u. co.).

²⁵ De Peyster and Allaben: Algol, pp. 79-80.

²⁶ *Ibid.*, p. 80.

²⁷ Lang, J. R. L., quoted in de Peyster and Allaben: Algol, p. 84.

²⁸ De Ford, Charles S., 1931. *A Reparation: Universal Gravitation a Universal Fake*, (Fairfield, WA: Ye Galleon Press). A 1992 reprint by Robert Schadewald.

²⁹ Westfall, Richard S., 1958. *Science and Religion in Seventeenth Century England*, (Yale University Press), p. 33.

³⁰ Ross, Alexander, 1646. *The New Planet No Planet: of the Earth No Wandering Star; except in the Wandering Heads of Galileans*. (London).

³¹ *Ibid.*, p. 117.

³² Kuhn, Thomas, 1957. *The Copernican Revolution: Planetary Astronomy in the Development of Western Thought*, (New York), esp. pp. 193-197.

³³ Allan, David, 2001. "An Ancient Sage Philosopher": Alexander Ross and the Defence of Philosophy," *The Seventeenth Century*, 17:68-93, quote is fm p. 75.

³⁴ Baxter, Richard, 1655. *The Arrogancy of Reason against Divine Revelations Repressed* (bound with *The Unreasonableness of Infidelity*) (London), Pt. IV, pg. 39.

³⁵ Stubbe, Henry, 1670. *The Plus Ultra Reduced to a Nonplus*, (London) pp. 172-173.

³⁶ Westfall, 1958. Pg. 24. The embedded quote is from H. Stubbe, 1670, *A Censure upon Certain Passages Contained in the History of the Royal Society, as Being Destructive to the Established Religion and Church of England*, (London), pg. 38.

³⁷ *Ibid.*

³⁸ Harcourt, Brown, 1934. *Scientific Organizations in Seventeenth Century France (1620-1680)*, (Baltimore), pp. 255-257. Reissued in 1967 by (NYC: Russell and Russell).

³⁹ Westfall, *ibid.*, in a footnote on pg. 23.

⁴⁰ Pike, Samuel, 1753. *Philosophica Sacra: or the Principles of Natural Philosophy extracted from Divine Revelation*, (London), p. 43.

⁴¹ Wesley, John, 1770. *Survey of the Wisdom of God in Creation or a Compendium of Natural Philosophy*, Vol. 1, 14, 139, (Bristol).

⁴² Prescott, Bartholomew, 1803. *A Defence of the Divine System, of the World, Which Represents the Earth As Being At Rest, And the Heavenly Bodies In Motion About It: With A Demonstration Of the Fallacy of the Solar System, Invented by Pythagoras, Revived by Copernicus, and Established by Isaac Newton*, (Liverpool: J. Lang).

⁴³ Prescott, Bartholomew, 1822. *The Inverted Scheme of Copernicus; with the Pretended Experiments Upon Which His Followers Have Founded Their Hypothesis of Motion...Book the First*. 1823. *The System of the Universe in Which the Unchangeable Obliquity of the Ecliptic... Are Mathematically Demonstrated...Book the Second*, (Liverpool: J. Lang).

⁴⁴ Lander, William, 1833. *David and Goliath; or, an attempt to Prove that the Newtonian System of Astronomy is Directly Opposed to the Scriptures, and, in very Many Instances, Contrary to Reason and Fact: also, that the Scriptures Give the Truest and most Reasonable Account of Astronomy: together with an Hypothesis Agreeing with Scripture, Reason, Experience, Our Senses, and Known Facts, in which is Included a New Method of Ascertaining the Size and Distance of the Sun, Moon, etc.*, (Mere).

⁴⁵ *Ibid.*, pg. 6.

⁴⁶ Hopkins, James, 1849. *The Solar System Truly Solved; Demonstrating, By the Perfect Harmony Of the Planets, Founded On the Four Universal Laws, the Sun To Be an Electrical Space; and a Source Of Every Natural Production Displayed Throughout the Solar System; With Diagrams and Mathematical Problems, Carefully Laid Down and Revised*, (London: H. K. Causton).

⁴⁷ See <http://www.commonssensescience.org>.

⁴⁸ Bouw, Gerardus D., 1999. "Did We Got to the Moon?" *The Biblical Astronomer*, 9(90):10. Also see Bouw, 2005. "Van Allen Belts and Hasselblads," *ibid.*, 15(114):133.

⁴⁹ De Morgan, Augustus, 1916. *A Budget of Paradoxes*, vol. 1, p. 131.

⁵⁰ Howard, Hon. Edward, 1705. *Copernicans of All Sorts Convicted by Proving, That The Earth Hath No Diurnal Or Annual Motion, As Is Suppos'd by Copernicans, from the beginning of the world, to this day ...: To Which Is Annex'd A Treatise Of The Magnet : As Also How To Find The Annual Variation Of The Compass, At Land And Sea ...*, (London: Jeffery Wale).

⁵¹ Jonchère, Etienne Lécuyer de La, 1728. *Demonstration de L'immobilité de la Terre*, translated into English by J[ohn] M[organ] and published in London under the title, *The Immobility of the Earth Demonstrated by Reasons Drawn from the Established Rules of Physics, Mechanics, and Geometry. Proving the Earth to be in the Center of the Universe; and, That all the Celestial Bodies perform their Diurnal Motions round It, and not the Sun. In Opposition to the Solar System*. The work was also included and bound as the third part of the English translation of Thomas Burnet's 1729 book: *Archaeologiae philosophica, or, The ancient doctrine concerning the originals of things; Dr. Burnet's theory of the visible world; by way of commentary on his own theory of the Earth, being the second part of his Archaeologiae philosophica, written in Latin by Thomas Burnet, LL.D., master of the Charter-House. Faithfully translated into English, with remarks thereon, by Mr. Foxton (with): [Jonchère, Etienne Lécuyer de La]. The immobility of the Earth demonstrated by reasons drawn from the established rules of physics, mechanics, and geometry. Proving the Earth to be in the center of the Universe; and that all the Celestial Bodies perform their diurnal motions round it, and not the sun. In opposition to the solar system*, [translated by J.M]. London: Printed for E. Curll, 1729.

⁵² *Ibid.*, Author's Introduction, pg. v.

⁵³ *Ibid.*, pg. 7.

⁵⁴ *Ibid.*, pg. 8.

⁵⁵ *Ibid.*, pg. 8-9.

⁵⁶ *Ibid.*, pg. 13.

⁵⁷ *Ibid.*, pg. 14.

⁵⁸ *Ibid.*, pg. 15.

⁵⁹ *Ibid.*, pg. 32. Morgan says 500,000 leagues, where one league equals three miles.

⁴⁰ Hitler, Adolph, 1954. *Hitler's Secret Conversations 1941-1944*, with an introductory essay on The Mind Of Adolph Hitler by H. R. Trevor-Roper. (New York: Farrar, Straus, and Young), p. 262.

⁴¹ *Ibid.*

Chapter 26

¹ Popper, K. R., 1963. *Conjectures and Refutations: The Growth of Scientific Knowledge*, (Second Edition, 1965). (New York: Basic Books, Inc.), p. 190.

² McGuire, J. E., 1978. *British Journal for the History of Science*, 11:114.

³ Newton, I., 1678. *Philosophiae Naturalis Principia Mathematica*, (London: S. Pepys).

⁴ After Newton's death, Whiston's attacks against Newton appeared in the *Republic of Letters* circa 1728.

⁵ Berkeley, George, 1734. *The Analyst: or, A Discourse Addressed to an Infidel Mathematician. Wherein it is examined whether the object, principles, and inferences of the modern analysis are more distinctly conceived or more evidently deduced, than religious mysteries and points of faith*. (London). Most of Berkeley's arguments against Newton can be found in this work.

⁶ Popper, *op cit.*, p. 170.

⁷ Newton, I., 1756. In *Four Letters From Sir Isaac Newton to Doctor Bentley Containing Some Arguments in Proof of a Deity*, (London: R. & J. Dodsley), p. 20. These letters are reproduced in I. B. Cohen, ed., assisted by R. E. Schofield, 1958. *Isaac Newton's Papers and Letters on Natural Philosophy and Related Documents*, (Cambridge, Mass.: Harvard University Press).

⁸ *Ibid.*, pp. 25-26.

⁹ Cohen, *op. cit.*, "Newton's Letter to Boyle," p. 253.

¹⁰ Popper, *op cit.*, p. 174.

¹¹ Bouw, G. D., 1998. "A Brief Introduction to the History of Evolution," *Biblical Astronomer* 8(85):9.

¹² Newton, I., 1756. *Loc cit.*

¹³ Gagnebin, 1949. *Royal Society of London, Notes and Records*, 6:106-160.

¹⁴ Le Sage, G. L., 1818. *Deux Traités de Physique Mécanique*, ed. by P. Prevost, (Geneva and Paris: J. J. Paschoud). This work, published posthumously, is in French. For a more or less detailed summary in English see Sir William Thomson, 1871. *Proceedings of the Royal Society of Edinburgh, Session 1871-72*, 7:577-589.

¹⁵ Long, Daniel R., 1976. "Experimental Examination of the Gravitational Inverse Square Law," *Nature*, 260(5550):417. The result challenges the inverse square law of gravity over short distances.

¹⁶ Thomson, W., 1871. *op cit.*, p. 586.

¹⁷ van Flandern, Thomas C., 1975. *Monthly Notices of the Royal Astronomical Society*, 170:333.

¹⁸ Darwin, George. H., 1905. "The analogy between Lesage's theory of gravitation and the repulsion of light," *Proc. Royal Soc.* **76**: 387–410.

¹⁹ van der Kamp, W., 1980. *Bulletin of the Tychonian Society*, number 28, p. 28.

²⁰ Assis, Andre K. T., 1999. *Relational Mechanics*, (Montreal: Apeiron).

²¹ Anyone interested in further study of Le Sage's theory should study, Matthew R. Edwards, ed., 2002. *Pushing Gravity: New Perspectives on Le Sage's Theory of Gravitation*, (Montreal: Apeiron). The book is a collection of papers by such notables as Halton Arp and the late Thomas van Flandern of the U.S. Naval Observatory.

Chapter 27

¹ Turner, Dean, 1979. In Turner and Hazlett, eds., *The Einstein Myth and the Ives Papers*, (Old Greenwich, Conn.: Devin-Adair Co.). "Einstein Myth," p. 93.

² That is, as: $0 = \frac{d\vec{p}}{dt} - m \frac{d\vec{v}}{dt}$ where $d\vec{p}$ is the change in momentum, m is mass, v is velocity, and t is time.

Chapter 28

¹ Barbour, J. B., 2000. *The End of Time*, (Phoenix), p. 119.

² Hood, C. Gregory, 1970. "A Reformulation of Newtonian Dynamics," *American Journal of Physics*, **38**(4):438. The unity of Newton's laws portion of Hood's derivation is presented in G. D. Bouw, 1985. "On Newton's Laws of Motion," *Bulletin of the Tychonian Society*, no. 40, p. 27.

³ *Ibid.*, p. 440. The second law seems to be the most fundamental of Newton's three laws, but any of them can be used as the foundational law.

⁴ Popper, Karl R., 1965. "A Note on Berkeley as Precursor of Mach and Einstein," in *Conjectures and Refutations—the Growth of Scientific Knowledge*, (New York: Basic Books, Inc.), 2nd ed., Chapter 6.

⁵ Mach, Ernst, 1883. *Die Mechanik in Ihrer Entwicklung Historisch-Kritisch Dargestellt*, (Prague). Mach arrived at his principle by the following train of thought: Consider the example in our text of the stone whirled about your head. We can measure the centripetal (inertial) force on a rotating mass m via Newton's law in the form, $F = ma = mv^2/r$ to find circumferential speed v . The second way is to compute the same object's circumferential speed v relative to the distant fixed stars. To the surprise of the Copernicans, both methods give exactly the same result. This was a great mystery before the mid-nineteenth century. Mach realized that the equality of the two methods implied a link between inertia and all other matter in the universe. Gravity was the prime suspect.

⁶ For a detailed exposition on the development and beliefs of Natural Religion, see Richard S. Westfall, 1958. *Science and Religion in Seventeenth Century*

England, Yale University Press; printed in paperback, 1973, Ann Arbor Paperback, University of Michigan Press.

⁷ Barbour, Julian B., and Bruno Bertotti, 1977. "Gravity and Inertia in a Machian Framework," *Il Nuovo Cimento B*, 38:1.

⁸ Assis, Andre K. T., 1999. *Relational Mechanics*, (Montreal: Apeiron Press), chapter 8, section 4 unto the end of the chapter.

⁹ Lense, Josef and Hans Thirring, *Physicalische Zeitschrift*, 19:156-163, 1918

¹⁰ Misner, C. W., K. S. Thorne, & J. A. Wheeler, 1973. *Gravitation*, (New York City: W. H. Freeman and Co.), p. 1119.

Chapter 29

¹ Elmendorf, Richard G., 1994. *Heliocentric Humbug: A Critical Evaluation of the Foucault Pendulum*, (Bairdford, PA: Pittsburgh Creation Society), p. 1.

² Elmendorf, Richard G., *Ibid.*

³ Hanson, James N., 2011. "Geocentric Mechanics II: Foucault Pendulum Analysis," *Biblical Astronomer*, 21(136):33.

Chapter 30

¹ Hanson, J. N., Personal communication.

² Fresnel, August, 1821. *Ann. de Chimie*, 17:180.

³ Arago, François, 1839. *Comptes Rendus*, 8, 326. Also, 1853, *Ibid.*, 36, 38.

⁴ Stokes, George G., 1846. *Phil. Mag.*, 28:76.

⁵ Stokes, G. G., 1845. *Ibid.*, 27:9.

⁶ Michelson, Albert A., 1897. *Am. J. Sci.*, 3:475.

⁷ Larmor, Joseph, 1893. *Phil. Trans.*, 185:775.

⁸ Stratton, Julius A., 1941. *Electromagnetic Theory*, (New York: McGraw Hill), p. 337.

⁹ Armstrong, H. L., 1977. *Bull. Tychonian Society*, no. 18, p. 12.

¹⁰ Bouw, Gerardus D., 2008. "The Speeds of Waves in the Firmament," *Biblical Astronomer*, 18(124):54.

¹¹ Bouw, G. D., 1981. *Creation Research Society Quarterly*, 18:91.

Chapter 31

¹ Figures 1 and 2 were first printed in the 1916 *Encyclopedia Britannica* under "Aberration."

² Drake, Stilman, 1978. *Galileo at Work—His Scientific Biography*, (Chicago: Univ. of Chicago Press), p. 417.

³ Quoted in Whittaker, Edmund T., 1910. *A History of the Theories of Aether and Electricity from the Age of Descartes to the Close of the Nineteenth Cen-*

ture, Dublin University Press Series, (London: Longmans, Green, and Co.) Whittaker was the Astronomer Royal of Ireland at the time.

⁴ Doig, Peter, 1950. *A Concise History of Astronomy*, (London: Chapman and Hall, Ltd.), p. 102.

⁵ Bradley, James, 1728. "Account of a New Discovered Motion of the Fix'd Stars," *Philosophical Transactions of the Royal Society*, 35:637.

⁶ Pasche, Frederick E., 1915. *Fifty Reasons: Copernicus or the Bible*, (Morris, MN: F. E. Pasche) #37.

⁷ Phipps, Jr., Tomas E., 2003. "Failures of Relativity Theory to Describe Starlight," *Infinite Energy*, no. 52, p. 41.

Chapter 32

¹ Quoted in Edward R. Harrison, 2000. *Cosmology: The Science of the Universe*, (Cambridge: Cambridge University Press), p. 226.

² Fizeau, Armand H. L., 1851. "Sur les hypothèses relatives à l'éther lumineux," *Comptes Rendus* 33: 349-355.

³ Hoek, Martinus, 1868. "Determination de la vitesse avec laquelle est entraînée une onde lumineuse traversant un milieu en mouvement," *Archives Néerlandaises des Sciences Exactes et Naturelles*, 3:180.

⁴ Airy, George B., 1871. "On the supposed alteration in the amount of Astronomical Aberration of light, produced by the passage of light through a considerable thickness of a Refracting Medium," *Proceedings of the Royal Society, London*, 20:35.

⁵ Ritz, Walter, 1908. "Recherches critiques sur l'Électrodynamique Générale," *Annales de Chimie et de Physique*, 13:145. The title translates as: "Critical Research on General Electrodynamics."

⁶ Moon, Parry, and Domina Eberle Spencer, 1956. "On the Establishment of a Universal Time," *Phil. Sci.*, 23:216.

⁷ Phipps, Thomas E. Jr., 1995. "Neo-Hertzian Wave Equation and Aberration," *Galilean Electrodynamics*, 5:46.

Chapter 33

¹ Phipps, Thomas E., Jr., 2003. "Failures of Relativity Theory to Describe Starlight," *Infinite Energy*, no. 53, p. 36.

² Einstein, Albert, 1905. "Zur Elektrodynamik bewegter Körper," *Annalen Der Physik*, 17:891-921. The title translates as, "On the Electrodynamics of Moving Bodies."

³ Israel, G. L., et al., 2002. *Astronomy and Astrophysics Letters*, no. 386, pg. L13.

⁴ Lodge, Oliver, 1892. *Nature*, 46:165.

⁵ Dingle, Herbert, 1972. *Science at the Crossroads*, (London: Martin Brian & O'Keefe, Ltd.), pp. 161-164.

⁶ Barnes, Thomas G., 1986. *Physics of the Future: A Classical Unification of Physics*, (El Cajon, CA: Institute for Creation Research).

⁷ Eagleton, Robert D., 1970. "Relativistic Contraction Explained in Terms of the Relativistic Doppler Shift of de Broglie Waves," *American Journal of Physics*, **38**:922.

⁸ Ives, Herbert E., 1952. "The Fitzgerald Contraction," *Scientific Proc. of the Roy. Dublin Soc., New Series*, 26. Reprinted in *The Einstein Myth and the Ives Papers*, ed. by Richard Hazelett and Dean Turner, (Old Greenwich, CT: Devin-Adair Co.) 1979, pg. 163.

⁹ Poincaré, Henri, 1904. *Bull. des Sci. Math.*, **28**:302.

¹⁰ Einstein, A., 1905. *loc. cit.*

¹¹ Einstein, A., 1916. "Die Grundlage der allgemeinen Relativitätstheorie," *Annalen der Physik*, ser. 4, **49**:769.

¹² *Ives Papers*, p. 192.

¹³ Klein, Oliver, 1971. *Science*, **171**:345.

¹⁴ Poor, Charles Lane, 1923. *Gravity Versus Relativity*, (New York: G. Putnam's Sons), p. 56.

¹⁵ Soldner, Johann G., 1804. "Ueber die Ablenkung eines Lichtstrahls von seiner geradlinigen Bewegung, durch die Attraktion eines Weltkörpers, an welchem er nahe vorbei geht," *Berliner Astronomisches Jahrbuch*, pg. 161-172.

¹⁶ Einstein, A., 1911. "Über den Einfluss der Schwerkraft auf die Ausbreitung des Lichtes," *Ann. der Phys.*, **35**:898. An English translation, "On the Influence of Gravitation on the Propagation of Light," is on the web at http://einstein.relativitybook.com/Einstein_gravity.html.

¹⁷ Tangherlini, Frank Robert, 1978. *Sky & Tel.*, **56**:517.

¹⁸ Dyson, Frank Watson, Arthur Stanley Eddington & C. R. Davidson, 1920. "A Determination of the Deflection of Light by the Sun's Gravitational Field, from Observations Made at the Solar eclipse of May 29 1919," *Philosophical Trans. of the Royal Soc. A*, **220**:291-333.

¹⁹ Jones B. E., 1976. *Astron. Jnl.*, **81**:455.

²⁰ Poor, C. L., *op cit.*, p. 191. His table has been corrected to reflect later, more accurate values for the excess perihelic rotations, and Icarus has been added to the table. The corrected values are taken from Table I in Jorge C. Curé, 1991. "The Perihelic Rotation of Mercury by Newton's Original Method," *Galilean Electrodynamics*, **2**(3):43.

²¹ Einstein, A., 1916. *Ibid.* The quote occurs just before § 15.

²² Jorge C. Curé, 1991. "The Perihelic Rotation of Mercury by Newton's Original Method," *Galilean Electrodynamics*, **2**(3):47.

²³ Gerber, Paul, 1898. "Die räumliche und zeitliche Ausbreitung der Gravitation," *Zeitschrift für Mathematik und Physik* **43**: 93.

²⁴ Bethell, Thomas, 1999. "Rethinking Relativity," now posted on the web at <http://www.ldolphin.org/vanFlandern/>.

²⁵ Barnes, Thos., 1986. *Loc. Cit.*

²⁶ Hafele, Joseph C. & Richard E. Keating, 1972. "Around-the-World Atomic Clocks: Predicted Relativistic Gains," *Science*, **177**:166 & "Around-the-World Atomic Clocks: Observed Relativistic Time Gains," *ibid.*, pg. 168. Also see: L. Briatore & S. Leschiutta, 1976. *Lett. Nuovo Cimento*, **15**:203 and **17**:328.

²⁷ Essen, Louis, 1971. *The Special Theory of Relativity -- A Critical Analysis*, (Oxford: Clarendon Press). Also: 1972. *Proc. Roy. Inst. of Gr. Britain*, **45**:411.

²⁸ Essen, L., 1977. "Atomic Clocks Coming and Going," *Creation Research Soc. Quarterly*, **14**(1):46.

²⁹ Bailey, J. et al., 1977. *Nature*, **268**:301.

³⁰ Sherwin, C. W., 1960. *Phys. Rev.*, **120**:17.

³¹ Byl, John, 1980. *Bulletin of the Tychonian Society*, no. 28, p. 11.

³² Sachs, Mendel, 1972. *Phys. Today*, **25**:49. For a letter in response to the quote see p. 9 in the same issue. Sach's original article appeared in 1971, *ibid.*, **24**:23. Also see p. 11 of the June 1972 issue.

³³ Marinov, Stephan. 1977. *Eppur si Muove*, (Brussels: CBDS-Pierre Libert).

³⁴ Whittaker, A. E., *History of the Theories of the Aether*, 2:36.

³⁵ Waldron, 1977. *The Wave and Ballistic Theories of Light: A Critical Review*, (London: Frederick Muller, Ltd.), pp. 67 ff.

³⁶ Using standard units, the unit of speed, s , is represented by $\langle s \rangle$, the unit distance is represented by $\langle l \rangle$, and the unit time by $\langle t \rangle$. As a body is accelerated to the speed of light, its speed will have relativistic terms, that is:

$$s = \langle s \rangle \{ \{ \langle l \rangle \sqrt{(1-v^2/c^2)} \} / \{ \langle t \rangle \sqrt{(1-v^2/c^2)} \} \}$$

where $\langle s \rangle$ is the unit of speed of the body in its starting point, and the first factor in the braces is the relativistic contraction of the standard unit of length and the second factor (in the denominator) does the same for the unit of time. It is clear that setting $v = c$ gives 0/0 for the expression in the braces. It is taken for granted that the $(0 \langle l \rangle) / (0 \langle t \rangle) = \langle l \rangle / \langle t \rangle$, assuming that the zeros cancel. In this case the do because such follows from the convergence of limits, that is, taking the limit of the expression in braces as v approaches c . In reality, the $\langle t \rangle (1 - v^2/c^2)$ can never be zero. The smallest it can be is about 1.6×10^{-33} cm, a Planck length. Likewise, the smallest the time factor can be is 5.4×10^{-44} second. That is the limit placed on relativity by firmament mechanics. Furthermore, the $(1 - v^2/c^2)$ factor is an approximation to second order. Higher-order terms have been ignored and may possibly be significant and different for light and time under unforeseen circumstances.

³⁷ Klein, Oscar, 1971. *Loc cit.*

³⁸ Bouw, Gerardus D., 1992. *Geocentricity*, (Cleveland: Association for Biblical Astronomy), pp. 271-272. The experiment proposed there is to drop two balls simultaneously. In an accelerating system, the balls will fall along parallel lines while in a gravitational field the balls will fall along two lines that will meet at the center of the earth.

³⁹ Atkinson, R. d'E., 1963. *Proc. Roy. Soc. London, Ser. A*, **272**:61.

⁴⁰ $d = \sqrt{(x^2 + y^2 + z^2 - (ct)^2)}$, where d is the 4-D distance, x , y , and z are the regular 3-D space dimensions, c is the speed of light, and t is the time that has elapsed since a given event.

⁴¹ Browne, P. F., 1977. "Relativity of Rotation," *Jrnl. of Phys. A: Math & General Relativity*, **10**:735.

⁴² Warburton, R. J. & J. M. Goodkind, 1976. *Astrophys. Jrnl.*, **208**:881.

⁴³ For a more common, every-day example of a paradox of self-reference, consider this one which is argued by liberal supporters of abortion or other such matters. They claim that there is "no one view which is correct on the matter." One thing's for sure, if there is "no view that is correct," then the one view that says there is no correct view cannot itself be correct. Paradoxes of self-reference abound since the late nineteenth century.

⁴⁴ Ives, H. E., 1934. "Proceedings of the Eighteenth Annual Meeting of the Optical Society of America," *J. Opt. Soc. Am.*, **24**(2):58.

⁴⁵ Browne, P. F., 1977. *Loc cit.*

⁴⁶ Turner, D. 1979. In Turner and Hazlett, eds., *The Einstein Myth and the Ives Papers*, (Old Greenwich, CT: Devin-Adair Co.). Einstein Myth, p. 16.

⁴⁷ Ives, H. E., 1951. "Revisions of the Lorentz Transformations" *Proc. Am. Phil. Soc.*, **95**(2):125.

⁴⁸ Marinov, S. 1977. *Op cit.*

⁴⁹ Michelson, W., 1901. *Jrnl. of Phys.*, **10**:150. Also: 1901. *Astrophys. Jrnl.*, **3**:192 and A. Cotton, 1911. *Astrophys. J.*, **33**:375.

⁵⁰ Marinov, *op cit.*, pp. 127 ff. For a summary of both phenomena see: G. D. Bouw, in Marinov & Wesley, eds., *Proceedings of ICSTA*, p. 34 or see Bouw, 1981. *Creation Rsrch Soc. Qrtly.*, **18**:91.

⁵¹ O'Rahilly, A., 1965. *Electromagnetic Theory*, (New York: Dover), p. 334. Also see pp. 334-336.

⁵² Perot, A., 1924. *Comptes Rendus*, **178**:380.

Chapter 34

¹ Böhm, Walter, 1966. *Die Metaphysischen Grundlagen der Naturwissenschaft und Mathematik*, (Vienna: Herder & Co.), p. 13. The English translation of this passage is due to W. van der Kamp, 1967. *The Heart of the Matter*, (Pitt Meadows, B.C., Canada: v. d. Kamp), p. 21.

² Withrow, Gerald J., 1959. *The Structure and Evolution of the Universe*, (NYC: Harper Brothers Pub.), p. 79.

³ Michelson, Albert A., 1881. "The Relative Motion of the Earth and the Luminiferous Ether," *American Journal of Science*, **22**:120.

⁴ Michelson, A. A., & Edward W. Morley, 1887. "On the Relative Motion of the Earth and the Luminiferous Ether" *Am. Jrnl. Sci.*, **34**:333.

⁵ For instance, see Müller, Holgar, Sven Herrmann, Claus Braxmaier, Stephan Schiller, and Achin Peters, 2003. "Modern Michelson-Morley Experiment Using Cryogenic Optical Resonators," *Physical Rev. Lett.*, **91**(2):020401, 10 July.

⁶ Miller, Dayton C., 1933. "The Ether-Drift Experiment and the Determination of the Absolute Motion of the Earth," *Reviews of Modern Physics*, **5**:203.

⁷ Silberstein, Ludwig, 1925. "The Relativity Theory and Ether Drift," *Science Supplement—Science News*, **62**(1596):viii, 31 July.

⁸ Michelson, A. A., H. A. Lorentz, D. C. Miller, et al., 1928. "Conference on the Michelson-Morley Experiment," *Astrophysical Journal*, **68**(5):341-402.

⁹ Shankland, Robert S., Sidney W. McCuskey, Fred C. Leone, and G. Kuerti, 1955. "A New Analysis of the Interferometric Observations of Dayton C. Miller," *Review of Modern Physics*, vol. 27, no. 2, pp. 167-178.

¹⁰ *Ibid.*, p. 175.

¹¹ Miller, D. C., 1926. *Nature*, **117**:890.

¹² Thirring, Hans, 1926. "Prof. Miller's Ether Drift Experiments," *Nature*, **118**:81.

¹³ Miller, D. C., 1934. "The Ether-Drift Experiment and the Determination of the Absolute Motion of the Earth," *Nature*, **133**:162.

¹⁴ Cartmel, W. B., 1937. *Nature*, **139**:110.

¹⁵ Armstrong, Harold L., 1977. *Bull. Tychonian Soc.*, No. 16, p. 2.

¹⁶ O'Rahilly, Alfred, 1965. *Electromagnetic Theory*, (New York: Dover), p. 439.

¹⁷ Virgil, *Aeneid*. "Know first, that Heaven and earth's compacted frame, / And flowing waters, and the starry flame, / And both the radiant lights, one common soul / Inspires, and feeds, and animates the whole, / This active mind infuses through all space, / Unites and mingles with the mighty mass. / Hence men and beast the breath of life obtain, / And birds of air and monsters of the main. / The æthereal vigour is in all the same, / And every soul is filled with equal flame.

¹⁸ Lifschultz, David, 2010. An email with the subject "Chemosh as Aether. The Bible and the New Physics of Einstein." January 18.

¹⁹ Ritz, Walter, 1908. "Recherches critiques sur l'Électrodynamique Générale," *Annales de Chimie et de Physique*, **13**:145. The title translates as: "Critical Research on General Electrodynamics."

²⁰ Hanson, James N., 1996. "The Absence of Double Star Images and Geocentricity," *Biblical Astronomer*, **6**(75):4.

²¹ Zapffe, Carl A., 1977. *Am. Jnl. of Phys.*, **45**:775.

²² Joos, Georg, 1930. "Die Jenaer Wiederholung des Michelsonversuchs," *Ann. der Physik*, **399**(4):385 and 1931, *Naturwiss.*, **38**:784.

²³ Kennedy, R. J., and E. M. Thorndike, 1932. "Experimental Establishment of the Relativity of Time," *Phys. Rev.*, **42**:400.

²⁴ *Ibid.*, p. 416.

²⁵ Arp, Halton, 1978. *Astronomy*, **6**:15. Also see Stephan Marinov, 1977. *Epus Si Muove*, (Brussels: CBDS-Pierre Libert), pp. 71-74.

- ²⁶ Jaseja, T. S., A. Javan, J. Murray, & C. H. Townes, 1964. "Test Of Special Relativity Or Of The Isotropy Of Space By Use Of Infrared Masers," *Phys. Rev. A*, **133**:A1221.
- ²⁷ Newton, I. 1756. In *Four Letters From Sir Isaac Newton to Doctor Bentley Containing Some Arguments in Proof of a Deity*, (London: R. & J. Dodsley), p. 20.
- ²⁸ Mascart, E., 1872. *Ann. de l'Ec. Norm. (2)*, **1**, 157.
- ²⁹ Strutt, J. W., 1902. *Phil. Mag.*, **4**:215.
- ³⁰ des Coudres, T., 1889. *Ann. d. Phys.*, **38**:73.
- ³¹ Trouton, Frederick T., & Henry R. Noble, 1903. "The Mechanical Forces Acting on a Charged Electrical Condenser Moving Through Space," *Philosophical Proc. of the Roy. Soc.*, London **202**:165.
- ³² Whittaker, A. E. *History of the Theories of the Aether*, vol. 2, (New York: Dover), p. 27.
- ³³ Bouw, G. D., 1992. *Geocentricity*, (Assoc. for Biblical Astronomy: Cleveland, Ohio), pp. 256-258.

Chapter 35

- ¹ Turner, Dean, 1979. In Turner and Hazlett, eds., *The Einstein Myth and the Ives Papers*, (Old Greenwich, Conn.: Devin-Adair Co.). Einstein Myth, p. 44.
- ² Sagnac, Georges, 1913. *Comptes Rendus*, **157**:708 & 1410.
- ³ Laue, Max von (1911). "On an Experiment on the Optics of Moving Bodies," *Münchener Sitzungsberichte*: 405-412
- ⁴ Ives, Herbert E., 1938. *Jrnl. of the Optical Soc. of Am.*, **28**:296.
- ⁵ Post, E. J., 1967. *Rev. Mod. Phys.*, **39**:475.
- ⁶ Browne, P. F., 1977. *Jrnl. of Phys. A: Math & Gen.*, **10**:727.
- ⁷ *Ibid.*, p. 739.
- ⁸ Ives, 1938. *Op cit.*, p. 297.
- ⁹ Browne, 1977. *Op cit.*, p. 740.
- ¹⁰ Ives, 1938. *Op cit.*, p. 299.
- ¹¹ Pagamy, B., 1928. *Ann. d. Phys.*, **85**:244.
- ¹² Dufour, A. & F., Prunier, 1937. *Comptes Rendus*, **204**, 1925. Also, 1942. *Jrnl. Phys. et Radium*, **3**:153 and S. Marinov, 1978. *Found. Phys.*, **8**:137.
- ¹³ Michelson, A. A., 1925. *Astrophysical Jrnl.*, **61**:137.
- ¹⁴ Michelson, A. A., Henry G. Gale, assisted by F. Pearson, 1925. *Astrophysical Jrnl.*, **61**:140.
- ¹⁵ Turner, D., 1979. In Turner and Hazlett, eds., *The Einstein Myth and the Ives Papers*, (Old Greenwich, Conn.: Devin-Adair Co.). Einstein Myth, p. 44.
- ¹⁶ Marinov, Stefan, 1977. *Eppus Si Muove*, (Brussels: CBDS-Pierre Libert), p. 130.
- ¹⁷ Fultz, David, 1970. *Film Notes for Rotating Flows*, National Committee for Fluid Mechanics Films. Fultz was at the University of Chicago at the time the

film and workbook were created. The films are currently posted at the Massachusetts Institute of Technology's web site.

Chapter 36

- ¹ Rubin, V. C., N. Thonnard & W. K. Ford, Jr., 1977. *Astron. J.*, **81**:687 & 719.
- ² Ellis, G. F. R., 1978. *General Relativity and Gravitation*, **9**:87. Quote is from page 92. For his evidence, Ellis cites Gerard de Vaucouleurs, 1970. *Science*, **167**:1203.
- ³ Ellis, G. F. R., 1979. "The Homogeneity of the Universe." First place award winning essay, submitted to the Gravity Research Foundation, March, 1979. Quote is from p. 2.
- ⁴ Hartline, B. K., 1979. *Science*, **205**:31.
- ⁵ Ellis, G. F. R., 1979. *Op cit.* Or see L. C. Green, 1977. *Sky & Tel.*, **54**:180.
- ⁶ The first three paragraphs of this section are mostly taken from: Hubble, Edwin, 1937. *The Observational Approach to Cosmology*, (Oxford: Clarendon Press), p. 23.
- ⁷ Davies, P. C. W., 1978. *Nature*, **273**:336.
- ⁸ Ellis, 1978. *Op cit.*
- ⁹ Davies. *Op cit.*
- ¹⁰ Aoki, S., 1969. *Astron. J.*, **74**:284.
- ¹¹ Murray, C. A., 1978. *Mon. Notices of the Roy. Astr. Soc.*, **183**:677.
- ¹² Mishurov, Yu. N. and I. A. Zenina, 1999. "Yes, the Sun is Located Near the Corotation Circle," *Astron. and Astrophysics*, **341**:81. Quote is from p. 85.
- ¹³ Willson, F., 2002. "Shapes, Numbers, Patterns, and the Divine Proportion in God's Creation," *Impact*, no. 354, December.
- ¹⁴ Bouw, G. D., 2003. "ICR Skirts Geocentricity Again," *B. A.* **13**(103):28.
- ¹⁵ Bouw, G. D., 2001. "The Morning Stars," *B. A.* **11**(97):69.
- ¹⁶ Anonymous, 1979. *Sky & Tel.*, **58**:232. Also: 1979. *Astronomy*, **7**:58.
- ¹⁷ Rydgren, A. E., 1970. *Astron. J.*, **75**:35. Also S. W. McCuskey, 1965. In *Galactic Structure*, eds. A. Blaauw & M. Schmidt, (Chicago: Univ. Ch. Press), pp. 18-20.
- ¹⁸ McCuskey. Endnote 17, p. 9.
- ¹⁹ Pauliny-Toth, I., et al., 1981. *Astronomical Journal*, **3**.
- ²⁰ Phipps, Jr., Thomas E. 1989, *Physics Essays*, **2**(2):180-184. Quote is from page 181.
- ²¹ Denmot, G. Le, & J-P. Vigier, 1975. *Comptes Rendus Acad. Sci. Paris (B)*, **280**:459.
- ²² Rubin et al. *Op cit.*
- ²³ Rubin et al. *Op cit.*
- ²⁴ Schechter, P. L., 1977. *Astron. J.*, **82**:569.
- ²⁵ Rubin, V. C., 1977. *Astrophys. J.*, **211**:L1.
- ²⁶ Rubin et al. *Op cit.*, p. 735.
- ²⁷ Bouw, G. D., 1982. *Creation Rsrch. Soc. Qrtrly*, **19**:28.

²⁸ Instead of saying 3-degrees Kelvin, modern convention is to omit the “degrees” and simply say, “three Kelvins.”

²⁹ Smoot, G. F., M. V. Gorenstein & R. A. Muller, 1977. *Phys. Rev. Lett.*, **39**:898.

³⁰ Corey, B. E. & D. T. Wilkinson, 1976. Reported at the AAS meeting, Haverford, Pa. See: *Science News*, **110**:10.

³¹ Varshni, Y. P., 1976. *Astrophys. & Space Sci.*, **43**:3.

³² *Ibid.*

³³ *Ibid.*, p. 8.

³⁴ *Ibid.*, p. 8.

³⁵ Varshni's value of the probability on p. 4 is incorrect. The exponent of the 10 should be -87, not -85.

³⁶ Arp, H., 1970. *Astrophys. J.*, **75**:1. Also 1971. *Science*, **174**:1189. Also 1978. *Astronomy*, **6**:15.

³⁷ Green, R. F. & M. Schmidt, 1978. *Astrophys. J.*, **220**:L1.

³⁸ Guthrie, Bruce and William Napier, 1991. *Monthly Notices of the Royal Astronomical Society*, December 1.

³⁹ Humphreys, D. Russell, 2002. “The Battle for a Cosmic Center,” *Impact* No. 350, August, p. ii.

⁴⁰ Zehavi, Edit, 2010/11. “Galaxy Clustering in the Universe,” *Astronomy News: Case Western Reserve University Dept. of Astronomy*, p. 3. Zehavi is credited for the figure.

⁴¹ Source: 1990. *Nature*, **343**:726.

⁴² Source: http://heasarc.gsfc.nasa.gov/docs/cgro/cgro/batse_src.html (last visited on 12 October 2012).

Chapter 37

¹ Merali, Zeeya, 2007. “‘Axis of Evil’ A Cause for Cosmic Concern,” *New Scientist*, 14 April issue.

² Bouw, G. D., 1991. “Of iron whiskers and particles that increase mass with age!” *B. A.* **1**(57):21.

³ Bouw, G. D., 2005. “Cosmic radiation has a newly-discovered geocentric component,” *B. A.* **15**(114):131.

⁴ Bouw, G. D., 2012. “Shockwaves in the Firmament as a Source of the Cosmic Microwave Background temperature,” in preparation.

Chapter 38

¹ Moulton, Forest Ray, 1933. *Astronomy*, (New York: Macmillan), p. 115.

² Mulfinger, George, 1971. "Airy's Failure Reconsidered," *Bible-Science Newsletter*, July-August, p. 6.

³ Kamp, Walter van der, 1989-90. "The Whys and Wherefores of Geocentrism" in three parts, *Bulletin of the Tychonian Society*, nos. 49, 51, & 52.

⁴ Byl, John, Martin Sanderse, and Walter van der Kamp, "Simple first-order test of special relativity," *American Journal of Physics*, January 1985, pp. 43-45.

⁵ Kamp, Walter van der, 1988. *De Labore Solis: Airy's Failure Reconsidered*, privately published, 14813 Harris Road, Pitt Meadows, B.C. V3Y 1Z1, Canada.

⁶ Quoted by George F. Howe, 1985. "Tribute to an Outstanding Creationist: Professor Harold Lewis Armstrong (1921-1985)," *Creation Research Society Quarterly*, 22(2):57.

⁷ *Ibid.*

⁸ Kamp, Walter van der, 1989. "The Whys and Wherefores of Geocentrism II," *Bulletin of the Tychonian Society*, no. 51, p. 6.

⁹ Hanson, James N., 2005. *The Bible and Geocentricity*, (Assn. For Biblical Astronomy: Cleveland, OH).

¹⁰ Bouw, G. D., 1990. "The Gospel in a Tulip,"

<http://geocentricity.com/publications/tulip.html>.

¹¹ Notes taken from the back cover of *Creation, Time, and Dr. Hugh Ross*.

¹² Located at <http://www.mbowden.info>.

¹³ Lowenstein, Roger, 1991. "Some Investors Hitching a Ride on Lifschultz Trucking Lawsuit," *Wall Street Journal*, April 2, p. C1.

¹⁴ Hall, Marshall R. and Sandra S., 1974. *The Truth: God or Evolution?* (Grand Rapids: Baker Book House).

¹⁵ Hall, Marshall R., 1991. *The Earth is not Moving*, (Fair Education Foundation: Cornelia, GA).

¹⁶ The documentation is in three parts and is located at URL: www.fixedearth.com/HB_179_PART_II_ATT.EVIDENCE.htm

¹⁷ Sungenis, Robert, and Robert Bennett, 2009. *Galileo Was Wrong: The Church Was Right: The Scientific Evidence for Geocentrism*, (CAI Pub. Inc.).

¹⁸ Sungenis, Robert, 2009. *Galileo Was Wrong: The Church Was Right: The Historical Evidence for Geocentrism*, (CAI Pub. Inc.).

¹⁹ Dean's web site is <http://www.clr4u.org>.

²⁰ Davis, Dean, 2005. *In Search of the Beginning*, (Pleasant Word).

²¹ Ron's testimony is here reprinted from: Nelson, Ronald, 2008. "From Streets of Silver to Streets of Gold," *Biblical Astronomer*, 18(125):65.

²² Gray, Bob, Ed., 2008. "Bible Corrector Loses His Voice on Ankerberg Show," *The Baptist Magazine*, p. 45, July/August. Only relevant parts of the article were reprinted here.

Chapter 39

¹ Strouse, Thomas M., 2007. *He Maketh His Sun to Rise: A Look at Biblical Geocentricity*. (Emmanuel Baptist Publications: Newington, CT), p. 14.

² Lightfoot, Gordon in his song, "Walls."

³ Obukhov, Yu. N., 1992. "Rotation in Cosmology," *General Relativity and Gravitation*, 24(2):121-128. Page numbers of the references are listed after the respective quotes.

⁴ Bouw, G. D., 1990. "A Response to De Young's *Ex Nihilo* Article," *Bulletin of the Tychonian Society*, no. 53, p. 35.

⁵ Bouw, G. D., 1988. "The Round-earth Bible," *Bulletin of the Tychonian Society*, no. 46, p. 35.

⁶ Humphreys, D. Russell, 2002. "Our Galaxy is the Centre of the Universe," *Technical Journal* 16(2):104.

⁷ Faulkner, Danny, 2001. "Geocentrism and Creation," *Technical Journal* 15(2):110-121.

⁸ Strouse, *loc. cit.*, pp. 14-15.

⁹ Selbrede, Martin, 1995. "Geocentricity's Critics Fail to do Their Homework," *Biblical Astronomer*, 5(71):5.

¹⁰ II Timothy 3:16.

Appendix D

¹ The Virginia Commonwealth University's library has a collection of Jasper's sermons. On 7 January 2013, this vernacular version of "De Sun Do Move" was found at: <http://www.library.vcu.edu/jbc/speccoll/vbha/6th5.html>.

SCRIPTURE INDEX

I Chronicles		Acts	
16:30	41, 672	1:8	32
I Corinthians		7:49	182
15:52	31	10:11	164
2:14	208, 277	19:24-40	367
8:13	35, 39, 40	24:14	5
I Kings		Amos	224
7:23-24	323	5:8	221
8:27	280	7:7	186
I Samuel		:9	187
2:8	24	Colossians	
28:14	166	1:17	295
I Timothy		2:8	577
6:20	4	3:9-10	208
II Chronicles		Daniel	258, 262
2:6	280	2:21	237
4:2	323	7:13-14	262
6:18	280	Deuteronomy	
32:31	148, 149	4:24	201
II Kings		9:3	201
20:11	323	18:21-22	635
:9-11	146	Ecclesiastes	169
23:5	227	1:1	173
II Samuel		:2	173, 174
22:16	22	:3	174
II Timothy		:4	47, 174
3:16	16, 674	:5	172, 173, 176, 284
:16-17	173	:5-8	672
		:6	175
		:7	175, 176
		:12	174
		3:11	323, 496
		7:10	271
		9:11	678
		12:13	677

Ephesians

2:8	171
3:21	36
4:14	598
6:16	162
10:10	255
:22	208

Exodus

10:12-14	28
:10	255
:15	28
24:10	201

Ezekiel

1:22-28	200
28:2	297

Galatians

6:7-8	367
-------	-----

Genesis

1	332
1:1	182
:1-19	672
:3-5	90
:5	93
:6	201
:6-8	52
:8	102
:14-15	238
:16	92, 103, 238, 285, 286, 290
:28	90
:3-5	90
:5	93
:6	201
:6-8	52
:8	102
2:7	108
6:1	225
8:22	236, 237

Genesis (continued)

9:1	90
10:10	255
11:1-9	177
15:5	322
16:13	281
19:23	168

Habakkuk

3:11	177
:5-9	177

Hebrews

1:3	23, 403
:10	23
:13-14	108
8:12	281
10:17	281
12:29	201

Isaiah

151	
1:18	673
9:6	162
13:10	163, 164
:13	48
14:13-14	297
24:19-20	48, 49
28:17	186
:9-13	186
38:7-8	148
:8	149, 150, 323, 672
40:22	29, 30, 104
42:5	104
45:17	36
66:1	39, 182, 280
:24	262

Jeremiah

31:35-36	237
:37	23
33:20-21, 25-26	235
:25	235
7:15	281

Job

	108, 220, 226, 234, 678
1:8	187
9:6	47
:7	176
26:7	25, 239, 241
37:12	36
38	179
:4	23
:6	23
:12-14	588
:12-15	211
:13	213
:14	210, 213, 214
:31	221, 224, 233
:31-32	232
:31-33	215
:32	226, 230
:33	108, 109, 226, 233, 235

John

4:24	166
5:39	374
8:44	208
10:35	374
14:17	9
:28	400
17:17	43

Joshua

10:12	283
:12-13	672
:13	9, 57, 296, 675

Lamentations

3:11	281
------	-----

Leviticus

22:7	164
------	-----

Luke

	31
1:78-79	211
14:33-34	108
17:31-36	30, 31
24:39	166
176	

Malachi

4:2	9, 161, 165, 167
-----	---------------------

Mark

7:13	543
13:14	333

Matthew

1:1	225
5:13	108
:14	108
:45	9, 170
6:10	108, 233, 234
7:13-14	676
12:32	36
:40	164, 172
13:35	102
27:57	164

Micah

6:2	23
-----	----

Proverbs

1:22	282
3:19	23
8:27	30
29	23
26:24-25	279
27:22	223
30:16	262

Psalms

11:4	39
12:6-7	40
18:15	22
19	94
1:6	94
4	161, 177, 312
4-5	13
4-6	672
5	291
5-6	296
6	96, 97, 98, 101, 102, 165, 175, 322, 562
7-10	96
11-14	96
22:30	107
74:12	206
82:1	50
5	50, 51
8	50
84:11	162
85:11	203
89:14	183
36-37	107
93	284
1	13, 37, 38, 40, 41, 44, 49, 286, 600, 671, 672
2	37, 38
96:10	41
97:2	183
99:1	47, 49

Psalms (continued)

102:25	23
104:2	104
5	23, 43, 44, 45, 46, 47, 48, 290, 291, 600
19	171, 172
119:89	96, 234
90	46
136:7	290
8-9	106
140:10	261

Revelation

261	
1-3	108
1:8	162, 166
16-20	221
18	162
20	108
3:14-22	681
19:13	543
20:11	37, 49, 103
14-15	97, 263
21:1	49, 91, 102
22:16	161, 542
18-19	186, 680

Romans

6:3	164
11	208
8:22	106
28	106
13:1	191

Zechariah

4:10	187
12:1	166

3

3K background radiation: see
cosmic background radiation

A

- A Geocentricity Primer 603
 Aberration 448, 494
 geocentric 468, 490
 & radio telescopes 459
 of streetlights 453
 Absolute motion 465, 471, 495
 Absolute rotation 521, 526
 Absolute space 493
 Absolutes 197, 407
 Acceleration 415
 Accommodation 1, 2, 290
 Acentrism 1, 10, 14
 Action-at-a-distance 61, 62, 351,
 404, 409, 515
 Action-at-a-distance 61, 62, 404
 Adam 108, 296
 Advanced potential 480
 Aether 405, 412, 443, 465, 466,
 472, 515, 524, 548
 drag 513
 Age of despair 197
 Ahaz 147, 150
 Airy, G. B. 458
 Airy's failure 457, 458, 516
 Al Wasat 219
 Aleyone 219
 Alcyonian Lake 219
 Aleph-null 401
 Aleph-one 401
 Algol 371
 Alignment 545
 All-seeing 279
 Allaben, Frank . 184, 370, 371, 376,
 377
 All-seeing 281
 Almighty 166
 Aluminum flake illustration 529
 Am. Humanist Association 668
 Amin, Idi 648
 Andean legends 156
 Angels
 bound 225
 Anisotropy 547
 Ankerberg, John show
 debater loses voice 643
 Anointed 161
 Antapex 508
 Anthropocentric 326
 Anticyclone 435
 Anticyclones 175
 Apeiron Press 62
 Apollo 198, 258
 Appearances 295
 Aquinas, Thomas 272, 275
 Arabic 230
 Arago, François 62, 441
 Arago's starlight experiment 441
 Arcturus 215, 230, 231, 232
 Aristarchus 264, 277
 Aristotelian Model 288
 Aristotelians 278
 Aristotle 254, 266, 300
 Armstrong, Harold 56, 93, 103, 508,
 509, 573, 578, 661, 667
 co-founder of geocentricity ... 581
 Arndts, Russell 609
 Arp, Halton 515, 551
 Arzachel of Toledo 291
 As above, so below 257
 Aspden, Harold 57, 79
 Assoc. for Biblical Astronomy 2
 Assumptions for geocentricity 6
 Astrology 254, 256, 258, 272
 origin of 256
 Astronomers 207, 296
 Astronomy 256, 538
 Astunica 304

Atkinson, R. d'E.....	488
Atlas.....	17
Atmosphere.....	182
Atom.....	62
Atomic absorption analysis.....	339
Atomic clocks.....	481
Atomism.....	243
Attention span.....	53
Augustine.....	16, 165, 275
Augustus, Caesar.....	268
Authority.....	189, 197
Authorized Version.....	44, 582, 601, 671
Autumnal equinox.....	229
Axis of evil.....	557
Aztec.....	156

B

Baptist Church	
East Otisfield.....	368
Sixth Mt. Zion.....	369
Babbage, Charles.....	191
Babel.....	178
Babylon.....	147, 255, 258, 260
fall of.....	259
Babylonian angles.....	151
Bands.....	233
Bands of Orion.....	215, 221, 223
Bane, Gordon H.....	603, 646, 650
Barberini, Maffeo.....	308
Baxter, Richard.....	381
Bay, David.....	648
Bay, Pastor Murray.....	648
Beamed radiation.....	546
Begh, Ulug.....	219
Bellarmino.....	303
Belshazzar.....	259
Benatky.....	335
Benet Nasch.....	230
Bennett, Robert.....	635
Bentley, letters to.....	404
Bergman, David.....	389

Berkeley, George.....	398, 403, 406, 471
Berlin.....	363, 496
Berodach-baladan.....	147
Bet Shean.....	258
Bhagavad Gita.....	152
Bible.161, 184, 191, 197, 202, 206, 210, 253, 254, 268, 271, 276, 290, 295, 296, 328, 364, 406, 556	
criticism.....	352
critics.....	185
death of.....	1
higher criticism.....	9
inerrant.....	189
preservation.....	3, 190
Bible and science.....	16
Bible criticism.....	679
Bible-Science Association.....	575, 587
Biblical Astronomer.....	577, 602
Biblical firmament.....	89
Big bang.....	534, 537, 538, 557
Big Dipper.....	230, 231
Big-bang.....	547
Bingen, Hildegard von.....	2
Black hole.....	538
Black-body radiation.....	547
Blavatsky, Helena.....	362
Bohm, Walter.....	495
Book of Nature.190, 206, 268, 270, 276, 332	
Bootes.....	231
Bork, Judge Robert.....	627
Boss, Valentin.....	320
Bouw, Gerardus.....	595, 664, 672
Bouwsma, William.....	285
Bowden, Malcolm.....	619
Boyle, Robert.....	405
Bradley, James.....	452
Brahe	
Eric.....	344
Tycho.....	1
on Scripture.....	332
Braheian Debater.....	633, 653

- Branch..... 161
 Brans-Dicke theory..... 492
 Bride of Christ .. 107, 108, 223, 681
 Brim..... 324
 Britain..... 191
 Broderick, John..... 656
 Browne, P. F. 489, 491, 524
 Bulletin of the Tychonian Society
 412, 574, 602
 Bullinger, E. W. 222
 Bungee tribe..... 130
 Burgess, A. J. 161, 181
 Burma..... 158
 Byl, John..... 576, 590, 667
- C**
- Calvin, John..... 272, 284
 Cantor, Georg..... 400
 Capacitors..... 517
 Capital punishment..... 680
 Carpenter, Nathanael..... 319
 Cartmel, W. B. 508
 Case Inst. of Technology .. 502, 503
 Cassini:
 César..... 349
 Giovanni..... 349
 Jacques..... 349
 Jean Dominique..... 326, 424
 Saturn's ring division..... 349
 Castelli, letter to..... 312
 Cayenne..... 424
 Cemitara, Hercules B. 648, 649
 Center of mass..... 240
 Center of the universe..... 537
 Centrifugal force..... 414, 419, 658
 CESHE..... 169
 Chalcedon Foundation..... 613
 Chambers, Dr. Joseph..... 643
 Chandler wobble..... 45
 Chemosh..... 511
 Cherenkov radiation..... 513
 Chicago..... 525
 China..... 153, 158
 Christians..... 181
 Christian scholars..... 678
 Christian scientists..... 678
 Christianity..... 162, 181, 270
 Christology..... 161, 172
 Church
 Mormon..... 91
 Adventist..... 378
 Churches
 rejected God's Bible..... 681
 Circle Scientifique et Historique .. 2
 Circuit of the sun ... 96, 97, 99, 101,
 175
 as a wave..... 565
 Circuit rider..... 97
 Circumference..... 491
 Clairaut, Alexis C. 449
 Clay to the seal..... 211
 Clement VII..... 277
 Cleveland..... 502
 Clock paradox..... 486
 Clocks..... 157, 488
 Codrus..... 273
 Columbus, Christopher..... 19
 Comet of 1577..... 329
 Comets..... 93
 Communism..... 193, 679
 Communist Manifesto..... 193
 Compact objects..... 545
 Compass..... 30
 Concentric shells..... 551, 553
 Condensation..... 176
 Confounded..... 177
 Constellations..... 101, 163, 222
 Convection..... 176
 pre-Copernican view..... 547
 Copernican Model..... 274
 Copernican Revolution ... 8, 12, 89,
 143, 191, 197, 248, 317, 350, 679
 embraced by Christians..... 171
 fruits of..... 682

- Copernicus, Nicholas ... 8, 180, 193,
 267, 273, 274, 276, 279, 284,
 326, 336, 395, 403
 Corey and Wilkinson 548
 Coriolis force 414, 566, 658
 Coriolis, Gaspard-Gustave 431
 Corners of earth 27
 Corotation circle 539
 Corpuscles 410
 Cosmic background radiation .. 538,
 547, 548, 557
 Cosmic gravitational field 416
 Cosmic Microwave Background
 See Cosmic Background Radiati
 Cosmic Mystery 298
 Cosmic rays 51
 Cosmological principle 533, 539
 Cosmology 539
 ancient 243
 Apian's 250
 crystalline spheres. 244, 251, 252
 Egyptian 243, 251
 geocentric 243
 hybrid straw man 252
 Medieval hybrid 248
 Morin's 248
 Ptolemaic (true) ... 246, 247, 248
 Cottontail story 155
 Council of Trent 310
 Courdres, Theodore de 517
 Course (of sun) 44, 50
 Craters of moon, names of 316
 Creation 268, 332
 Creation Research Society. 653,
 661, 668
 Creationism 679
 Creationists 16
 on geocentricity 38
 Creator 544
 Critics 326
 Crombette, Fernand 2
 Crystal
 terrible 201
 Crystalline spheres 14, 245
 Ctesias of Cnidus 255
 Curse
 New Testament 680
 Curved space 488
 Cycloid 246
 Cyclone 175, 434
 Cyrus 259
- D**
- Dancau, Lambert 21, 253, 280
 Darius the Mede 259
 Dark Ages 272
 Darwin, Charles 192, 408
 Darwin, Erasmus 193
 David 173
 Davidheiser, Bolton 604
 Davies, P. C. W. 538
 Day-age theory 90
 Dayspring 211, 213
 De Dulier, Fatio
 corpuscles 62
 De Morgan, Augustus 11, 43
 De Young, D. B. 207
 Death penalty 680
 Deborah 163
 Deferent 246, 247
 Degrees 146, 149, 150
 Delambre, Jean 350
 Descartes 270, 315
 Devil 208
 Devil's Tower 26
 Dial of Ahaz 147
 Dialogue Concerning Two World
 Systems 308
 Diana of the Ephesians 367
 Dielectric properties of space ... 469
 Digges, Thomas 288
 Dingle, Herbert 469
 Dini, letter to 312
 Diodati 213
 Dipoles 559

Distributions of objects about earth 545
 Divine right of kings 191
 Doctrine
 basest 679
 Dogrib tribe 129
 Dominion
 ordinances of heaven 108
 Doppler shift 493, 509, 537
 DOTGU 633, 653
 Double revelation theory.. 206, 268,
 269, 295
 Down (direction)..... 203, 205
 Drain myth 435
 Dufour and Prunier 525
 Duillier, Nicholas Fatio de 409, 410
 Dutch..... 213
 Dynamic equations..... 3

E

Earth..... 22, 28, 34, 35, 93, 97, 215,
 221, 539, 542
 abides..... 47, 174
 at barycenter of universe..... 87
 bulges (equatorial)..... 26
 center of universe..... 538, 550
 circle..... 29
 coordinate system 206
 core..... 24, 33, 50
 corners of..... 26, 29
 distribution about..... 546
 earthquake..... 24, 46, 151
 ends of..... 28, 29, 211
 flat..... 3, 16, 34, 243, 378, 528
 footstool of God..... 37, 39, 182
 foundations of 21, 23, 24, 26, 33,
 43, 44, 49, 50
 hung upon nothing..... 239
 magnetic field..... 51, 443, 513
 mantle..... 21, 33
 midst of..... 206
 motions of..... 43, 47, 49, 214
 new Earth..... 43, 51
 oblateness..... 464
 orbit..... 38, 44, 48, 318
 orbit detection experiments..... 86
 perturbations..... 38, 44
 pillars of..... 21, 24, 33
 place..... 48
 present (current) earth..... 43
 revolution of..... 86, 209
 rotation..... 86, 209, 298, 521, 539
 spherical..... 21, 24, 28, 29, 33
 stationary..... 444, 466, 498, 515,
 517, 521
 tottering..... 45
 turning..... 211
 under the sun..... 169
 Earth below..... 205
 Earth-Mars resonance..... 544
 Earth-Mercury resonance..... 544
 Earth-moon resonance..... 544
 Earth-Venus resonance..... 543
 Eclipse
 lunar..... 298
 solar..... 152, 412, 474
 Ecliptic..... 229, 530
 axis of evil..... 562
 Edgell, William..... 390
 Egypt..... 28, 260, 297
 Priests of..... 262
 Egyptian religion..... 256
 Egyptians..... 17, 157
 Ehrenfest paradox..... 491, 528
 Einstein, Albert. 195, 239, 409, 412,
 471, 528, 654
 Einsteinian metric..... 489
 Electra..... 279
 Electric field..... 516
 Electromagnetic gravity..... 371
 Electromagnetic coils..... 517
 Electromagnetic gravity..... 351
 Elements
 Greek theory..... 243, 251
 Elliptical orbits..... 291
 Ellis, G. F. R..... 534, 538

- Elmdorf, Richard..... 591
 Eltingen Churchyard..... 297
 Elwanger, Paul..... 672
 Empedocles..... 244
 Eneke, Johann..... 356
 Entebbe..... 649
 Entropy..... 85
 Epicycle..... 246, 247, 266
 Equatorial bulge..... 424
 Equinoxes..... 25
 Erasmus..... 288
 Essen, L..... 481
 Ether
 entrainment..... 443
 Ether..... 405, 499
 entrainment..... 443
 etymology of..... 510
 luminiferous..... 499, 509
 Euclidean space..... 488
 Euler, Leonard..... 326
 Evaporation..... 176
 Event horizon..... 534
 Evidence for geocentricity..... 517
 Evolution.... 15, 104, 192, 197, 534,
 535, 551
 revolution..... 352
 Evolutionism..... 9, 679
 Ex cathedra..... 309
 Existentialism.... 181, 197, 260, 294
 Expanding universe..... 493, 514
- F**
- Father, the..... 211
 Fibonacci series..... 540
 Fictitious forces..... 421
 Figurative language..... 165
 Fire worship..... 260
 Firmament.... 52, 63, 251, 418, 463,
 567, 678
 barycentric role..... 87
 edge of..... 201
 holographic sheets..... 85
 longitudinal waves in..... 82
 mass of..... 78
 modern interpretations of..... 83
 open..... 464
 pressure waves..... 82
 rotation of..... 85
 speed of sound through..... 82
 Throne..... 200
 Fitzgerald contraction..... 446, 469,
 485, 494, 509
 Fizeau, Armand Hippolyte..... 455
 Fizeau's Experiment..... 455
 Flamsteed..... 451, 452
 Flat earth..... See Earth: flat
 Flat Earth Society..... 670
 Flodmark, Stig..... 136
 Flood (global)..... 192, 221, 255
 Forbidden arts..... 298
 Force
 centrifugal..... 415
 Coriolis..... 415, 529
 definition..... 415
 Euler..... 416
 fictitious..... 416
 Ford, Charles de..... 378, 379
 Forke, A..... 153
 Form..... 263
 Fortean Society..... 379
 Foscarini..... 304
 Fossils..... 192
 Foucault pendulum.... 361, 435, 464
 Foucault, J. B. L..... 436
 Fourier, Joseph..... 525
 Free will..... 108
 Free-thinking..... 191
 French Revolution..... 350
 Fresnel, Augustin..... 62, 441
 Fresnell drag..... 441, 442, 444, 494
 Friction..... 316
 Fromsun..... 179
 F-star distribution..... 545
 Fundamental experiments..... 521
 Fundamentals of Christianity..... 673
 Future tense..... 41

G

- Gaia..... 17
- Galactocentric orbit..... 98, 99
- Galaxies..... 553
walls of about earth..... 553
- Galaxies, distribution about earth..... 546
- Galaxy..... 537
- Galaxy clusters..... 535
- Gale, H. G..... 525
- Galileo..... 8, 12, 189, 270, 273, 308, 310, 312, 315, 326, 336, 362, 403, 668, 674
Inquisition, first appearance.. 304
moons of Jupiter..... 245
on Scripture..... 312
second Inquisition..... 308
Venus phases..... 245
- Galileo Was Wrong..... 2
- Galileo's conversion to geocentricity..... 312
- Gamma Draconis..... 451, 452
- Gamow, George..... 557
- Gap theory..... 90
- Gauna, Frank..... 605
- Gauss, Karl..... 358
- General theory of relativity..... 471
- Generation..... 107, 174
- Genoii..... 628
- Gentiles..... 164
- Geocentric
model..... 396
- Geocentric universe..... 493
- Geocentricity.. 2, 14, 109, 161, 203, 210, 245, 295, 296, 319, 328, 490, 493, 546, 669
ancient..... 243
and Scripture..... 679, 680
as doctrine..... 254
birth of..... 56
book..... 602
disposable doctrine..... 678
end-time heresy..... 3
evidence for..... 446, 490, 498
key doctrine..... 677
vs geocentrism..... 169
- Geocentricity Primer, A..... 647
- Geocentrism..... 1, 8, 169, 172, 181, 207, 243
- Geocentrists. 348-397, 570-651, 673
American..... 352, 368
British..... 379
German..... 350
- Geometry..... 406
- Geometry as God belief..... 293
- Geosynchronous satellite..... 657
- Gibson, Hutton..... 672
- Gibson, Mel..... 672
- Gilbert, William..... 290
- Gipp, Dr. Samuel..... 643
- Gish, Duane..... 661
- God..... 38, 42, 159, 163, 165, 173, 179, 184, 191, 193, 206, 214, 234, 242, 257, 274, 280, 286, 319, 326, 535
as a plenum..... 88
as geometer..... 333
existence of..... 58
his will..... 235
in nature..... 206
incarnate..... 223
omnipotence..... 308
omnipresent..... 206
- God of this world..... 108
- Going forth..... 163
- Goldberg, Amnon..... 603
- Golden vases..... 297
- Good..... 263
- Gospel..... 221
- Gospel in a Tulip..... 601
- Gospel in the stars..... 96, 101, 222
- Grace, age of..... 680
- Grammarians... 38, 42, 159, 179, 214
- Grave..... 221
- Graves..... 214
- Gravitational constant..... 411

Gravitational shielding.....	480
Gravity.....	218, 221, 223, 233, 239, 241, 402, 404, 409, 412, 425
Gravity.....	85, 105
electric.....	388
Newtonian.....	408
Gravity shielding.....	410
Great lights.....	290
Great Wall.....	553
Greeks.....	153
Green and Schmidt.....	551
Grinnell, G.....	192
G-star.....	545
Guthrie and Napier.....	552

H

Hafele-Keating experiment.....	481
Halcyone.....	219
Hall, Marshall.....	392, 629
Hamlet's Mill.....	25
Han.....	153
Hannah.....	24
Hanson, James ...	62, 182, 255, 412, 512, 575, 581, 601, 663
Harmony of the spheres.....	244
Harrison, R. K.....	39
Hawaii.....	132
Heaven.....	39, 96
above.....	205
end of.....	102
first.....	182
new.....	51
ordinances.....	215, 233, 238
poles of.....	558
second.....	182
stretching.....	104
third.....	102, 182, 186, 530
throne.....	182
Hebrew.....	93, 213, 215, 218, 222, 226, 230, 325
Heinze, Harald P.....	645

Heliocentrism.....	1, 161, 181, 197, 210, 238, 253, 258, 267, 272, 315, 320, 408
liberal defense of.....	177
pagan doctrine.....	679
Heliocentrists.....	41, 43, 45, 97, 146, 165, 198, 206, 221, 233
Helios.....	157
Heraclides.....	266
Herschel, Sir William.....	220, 350, 353
Hezekiah.....	146, 149, 152
sign.....	130, 237, 323, 679
Peruvian account.....	132
Hidus.....	16
Higgs boson.....	77
Higher criticism.....	189
Hill, Harold.....	135
Hindus.....	152
Hipparchus.....	266
Historians.....	189
Jewish.....	255
Hitler, Adolph.....	193, 395
Hoek, Martinus.....	457
Holden, Joseph.....	368
Holy Bible.....	9, 396
Holy Ghost.....	9, 36, 56, 91, 107, 167, 175, 213, 290
Hood, C. Gregory.....	422
Hooke.....	452
Hopkins, James.....	388, 389
Host of heaven.....	256
worship of.....	254
Howard, Edward.....	391
Howe, George.....	661
Howell, Kenneth.....	332
Hoyle, Sir Fred.....	243, 331, 412
Huai-nan-tse.....	153
Hubble constant.....	547
Hubble, Edwin.....	514
Humanism.....	143, 270, 271
backwards-looking.....	288
Humanist.....	191
magazine.....	668

Humanists 288, 254
 Humboldt, Alexander von 355
 Humphries, Russell 552, 671
 Huygens, Christiaan 320, 510
 Hven 335

I

Immovable object 52, 58
 Immutable atoms 310
 Index of refraction 493
 Index on Copernicus 303, 304, 305,
 309
 India 152, 158
 Indicopluestes, Cosmas 17
 Inductance 517
 Inerrancy 319
 Inertia 659
 frame of reference 524
 system 425
 Infallibility of the Pope 309
 Innocent III, Pope 308
 Inquisition 277, 302
 Institute for Creation Research 653,
 668
 Institute of Forensic Medicine .. 339
 Interferometer 496
 Iroquois 130
 Irresistible force 52, 58
 Irving, Washington 19
 Israel 29, 206
 Israelites 262
 Italian 213
 Ives, H. E. 472, 491, 493, 523

J

Jacobs, Louis 12
 Jaseja experiment 515
 Jasper, John 369
 JEHOVAH 37, 161
 Jerusalem ... 29, 148, 151, 153, 158,
 173, 186, 206
 Jessenius, Johannes 337

Jesuits 301, 310
 Jesus 32, 107, 162
 Jesus .10, 21, 23, 24, 33, 36, 50, 96,
 161, 162, 163, 167, 175, 186,
 187, 211, 221, 236, 271, 281,
 542, 677
 ascension of 107
 birth of 262
 Christ 223
 Lord 679
 Jets (superluminal) 546
 Johnson, Charles 670
 Johnson, F. R. 294, 333
 Jonchère, M. 392
 Jones, Davey 368
 Joos, G. 514
 Joshua's long day 177, 237, 323,
 679
 Cherokee account 134
 Japanese account 133
 map 144
 Ugaritic record 136
 Judgment 23, 47, 48, 50, 51, 183,
 213, 262
 Jupiter 228, 245
 moons of 301
 Justice 183

K

Kabbala 631
 Kamp, Walter van der: see van der
 Kamp
 Kant, Immanuel 398
 Katherina Kepler 297
 Kelleher, Joe 655
 Kennedy-Thorndike experiment 514
 Kepler, Johannes 189, 260, 273,
 291, 296, 326, 328, 336, 403
 as thief 338
 dream 298
 three laws 293
 Tycho's Mars observations 336
 Katherina 297

Khrushchev, Nikita	648
Kinematic equations	3
Kinematic vs dynamic	3
King James Bible ... See Authorized Version	
King, Ivan	315
Kingcungus	154
Klein, O	487
Kleptocracy	259
Kline, Morris	180
Knak, Gustav ... 363, 364, 365, 366, 367	
Kofahl, Robert	670
K-star distribution	545
Kuerti, Gustav	504
Kuhn, Thomas	653
Kurds	259
Kurtz, Johann	352

L

Labo radio show	650
Lake of fire	97, 261, 262
Lamb of God	161
Lamont, Johann von	358
Land	148, 149
Landskrone Arts Museum	340
Lang, Walter	575, 582, 585
Lange, Louis	376, 377, 378
Language	177
Languages	296
Laplace	190
Larmor, Joseph	444
Law	
Natural	109
Old Testament	680
Law of inertia	422
Laws of nature	236
Laws of physics	236
Lazarus	236
Le Jeune, Paul	129
Le Sage, George-Louis	409
model	62

Leap of faith	408
Leibniz, Gottfried	399
Lennin, V	193
Leone, Fred C	504
Letronne	
Antoine-Jean	19
Leucippus	61
Liar's paradox	6
Lifschultz, David	511, 626
Light	81
ballistic theory	61, 440
of the world	107
speed of	83
Lightfoot, Gordon	653
Lights	
Great	92
Line	188
Linz	298, 395
Lithuanian long night	134
Lodge, Sir Oliver	469, 505
London Geological Society	191
Long, Charles	660
Lorentz, Conrad	486
contraction	469
transformation	469, 493
Los Angeles	502
Lowie, Robert H	155
Lucas, Charles	390
Lunar Geography	298
Lund University	
Nuclear Microprobe facility	341
Luther, Martin	180, 272, 283
Lutheran	
Orthodox Conference	374
Lutheran priesthood	298
Lu-yang	153
Lyell, Charles	191, 408
Lynn, Lawrence	655

M

Mach, Ernst 406, 407, 423, 471, 487	
Mach's principle	5, 659

- Madler, Johann..... 220
 Magellanic Cloud, Large..... 508
 Magi
 taught Pythagoras 262
 Magnete, De..... 290
 Magnetic field 499
 Magnetic poles 558
 Magnetostriction 515
 Mahabharata..... 152, 153
 Man..... 193
 cosmic accident..... 181
 Maori..... 158
 Marinov, S. 528
 Marinov, Stefan 485, 493, 584
 Markov's maximon fluid 83
 Mars 154, 228, 245, 544
 Marx, Karl..... 193
 Marxism 9, 193, 197
 Mascart, E. 517
 Mass effect..... 480, 492
 Math and nature 403
 Mathematics 283
 Matthew
 1:1..... 225
 5:13..... 108
 :14..... 108
 :45..... 9, 170
 6:10..... 108, 233, 234
 7:13-14..... 676
 12:32..... 36
 :40..... 164, 172
 13:35..... 102
 27:57..... 164
 Maui..... 132, 156
 Maunder, E. W..... 150
 Maximons 84
 Mazzaroth 215, 226
 McCuskey, Sidney 504
 Measuring rod paradox 486, 488,
 491
 Mechanistic world-view..... 189
 Medo-Persian Empire 259, 260
 Melanchthon 272, 284
 on Scripture 284
 Menominee Indians 155
 Mercury 228, 245, 302, 476, 544
 perihelion precession..... 350
 Mercury (Hg)..... 339, 340, 341
 Mercy seat 186
 Messiah..... 161
 Meteoroids..... 93
 Micah
 6:2 23
 Michelson, Albert A. .443, 496, 525
 Michelson-Gale experiment 521,
 525, 528
 Michelson-Morley experiment .471,
 496, 498, 522
 Microwave background. See Cosmic
 background radiation
 Mighty God 162
 Milky Way. 98, 102, 240, 490, 539,
 548, 553
 Millennium 108
 Miller, Dayton C..... 501
 Miracle..... 236
 Mnesarchus..... 262
 Molten sea 323
 Monopole..... 559
 Month 544
 Moon 94, 163, 245, 316, 544
 inhabited 319
 journey to the..... 298
 standing 177
 typology 107
 Moon, Perry H. 462
 Moral absolutes 195
 Moral relativism 182, 184
 Morality 195
 Morley, Edward W. 498
 Morning Star..... 161
 Morris, Henry 670
 Mosaic floors..... 198, 258
 Moses 285, 290, 332, 373
 Mount Wilson..... 502
 Mountain roots 33

Mug illustration.....	105
Mulfinger, George....	574, 584, 665, 666, 667
Mundane corpuscles.....	410
Muon decay.....	481
Murphy, George.....	658
Music of the spheres.....	244
Mysterium Cosmographicum....	293

N

Nabonidus.....	258
Narlikar.....	412
NASA	
Missing day.....	135
National Science Foundation ...	669
Natural laws.....	406
Natural man.....	108, 208
Natural revelation.....	206, 208
Natural theology.....	472
NAVSTAR.....	482
Nebuchadnezzar.....	256, 258
Nebular Hypothesis.....	190
Nelson, B.....	270
Nelson, Ronald.....	639
Neptune.....	228
Neutrino.....	411
Neutron star.....	54
New Jerusalem.....	108, 186
New King James Version.....	46
New man.....	208
Newton.....	316
3 laws of motion.....	402
Baptistic.....	400
letters to Bentley.....	404
three laws.....	415
Newton, Sir Isaac.....	239, 398, 515
bucket experiment.....	419
Trinity.....	400
Newtonians.....	403, 407, 414
"proofs".....	414
Newton's first law.....	213, 214
Nicholas of Cusa.....	274
Nicodemus.....	108

Nieto, Michael.....	672
Nietzsche.....	193
Night.....	94
Nimrod.....	222, 255
Noah.....	221
Noah's Flood.....	192
Noble, H. R.....	518
North, Gary.....	672
Northcoast Bible-Science Association.....	588
Northern California Indians.....	155
Northrup, Bernard.....	670
Nothing.....	240
properties of.....	58
Nourissat, Yves.....	2
Novarra, Maria de.....	273
Numbers, Ron.....	606
Nut.....	243

O

Observational evidence.....	331
Occult.....	297
Oceanus Procellarum.....	317
Octupole.....	559
Ojibway tribe.....	129
O'Keefe, Pastor George W.....	588
Olcott, Henry S.....	362
Olcott, W.....	129
Old man.....	208
Olé Rømer Museum.....	339
Omaha tribe.....	129
Omnipotence.....	59
Omnipresence.....	59
Omniscience.....	59
Open firmament.....	464
Opiates.....	298
Optical illusion.....	147, 237
O'Rahilly, A.....	493, 509
Orbit	
earth-sun.....	105
first three days.....	90
geocentric (misnomer).....	105
Orbital resonances.....	543

- Orders of magnitude 77
 Ordinances 238
 Ordinances of earth 235, 236
 Ordinances of heaven 233, 235, 238
 Ordinances of heaven 108
 dominion of 678
 dominion thereof set in earth 234
 Origen 275
 heresy 253
 Original autographs 189
 Ordinances of heaven 109
 Orion 215, 221, 222, 233, 255
 Osiander 278, 285
- P**
- Pagan philosophers 279
 Paganism 254
 Paley's Natural Theology 191
 Pallon, Jan 341
 Pancentrism 1
 Pantheism 280, 294
 Pantheon 436
 Papacy 310
 Paradox of self reference 491
 Parallax 264, 318
 Parallax 378, 379, 390
 Parallel universes 85
 Paris 424, 436
 Park, David 655
 Parmenides 61
 Pasche, Friedrich 371, 372, 373,
 374, 375
 Pastor Aeternus 309
 Paul III 278
 Pearson, F. 525
 Peleg 214
 Pendulum 424
 Penzias, Arno 557
 Perihelion precession .. 38, 412, 476
 Persians 153, 259
 Peru 156
 Peurbach, Georg 274
 Peyster, John de 370, 371
 Phaenomenis 329
 Phenomenological 44, 45, 165
 Phenomenology 296
 Philolaus 97, 262, 277, 322
 Philosophers 189
 Philosophy 495
 Babylonian 253
 Egyptian 253
 Greek 253
 Phipps, Jr., Thomas E. 463, 546
 Physics
 conspires geocentricity 87
 Pi-equals-three fable 323
 Pironi 313, 451, 452
 Pierson, Carl 375
 Pinnacles National Monument 26
 Pisa University 310
 Planck
 density 78
 medium 52, 78, 83
 particle 63
 temperature 85
 Planck, Max 63
 Planets 227, 282, 301
 inhabited 319
 Plato 254, 261, 264, 266, 277, 279
 Platonism 333
 Pleiades 157, 215, 219, 221, 233
 Plenum 57, 60, 80, 409, 509
 demise of 61
 God as a 88
 Pliny 312
 Plumbline 186, 187
 Plurality of worlds 319
 Poetry 43, 172, 282
 Poincare, H. 471
 Poisson, Siméon D. 442
 Polaris 376, 377, 390
 Polarization 516
 Pole Star *See* Polaris
 Politics 189
 Poll 652
 Polynesia 156

- Pontifex Maximus 268
- Poor, Charles Lane 472, 527
- Pope
- Clement VII 299
 - John-Paul II 309
 - Paul III 299
 - Paul V 309
 - Urban VIII 308
- Popol Vuh 156
- Population
- Post-flood growth 255
- Positivism 495
- Prague 335
- Pre-Adamic race 49, 90
- Precession 45
- Preferred coordinate system 489
- Preferred reference frame 484
- Prescott, Bartholomew 386
- Prime mover 251
- Principle of correspondences 257
- Principle of equivalence 487
- Principle of relativity 471
- Principles of Geology 191
- Printing press 270
- Progressive wave 529
- Progymnasmata 336
- Protestantism 189
- Proton 77
- Proverbs
- 1:22 282
 - 26:24-25 279
 - 27:22 223
 - 3:19 23
 - 30:16 262
 - 8:27 30
 - 29 23
- Psalms
- 11:4 39
 - 12:6-7 40
 - 18:15 22
 - 19 94
 - 11-6 94
 - 4 161, 177, 312
 - 4-5 13
 - 5 291
 - 5-6 296
 - 6 96, 101, 102, 165, 175, 322, 562
 - 4-6 672
 - 6 97, 98
 - 7-10 96
 - 11-14 96
 - 22-30 107, 225
 - 24:1-2 37
 - 74:12 206
 - 82:1 50
 - 5 50, 51
 - 8 50
 - 84:11 162
 - 85:11 203
 - 89:14 183
 - 36-37 107
 - 93 284
 - 1 13, 37, 38, 40, 41, 44, 49, 286, 600, 671, 672
 - 2 37, 38
 - 96:10 41
 - 97:2 183
 - 99:1 47, 49
 - 102:25 23
 - 104:2 104
 - 5 23, 43, 44, 45, 46, 47, 48, 290, 291, 600
 - 19 171, 172
 - 119:89 96, 234
 - 90 46
 - 136:7 290
 - 140:10 261
 - 136:8-9 106
- Psychiatry 197
- Ptolemaic System 267, 291, 302
- Ptolemy 266, 395
- Pythagoras 255, 260, 262
- Pythagorean theorem 489
- Pythagoreans 260

Q

Quadrupole.....	559
Quartz crystal.....	517
Quasar.....	549, 550
distribution problem.....	548, 551
shells about earth.....	550
Queen of Heaven.....	272

R

Rabinowitz, Avi.....	348
Radial velocity.....	546
Radiation.....	546
Radio source count.....	534
Raumer, Karl von.....	357, 358
Rayleigh, Lord John.....	360, 517
Redondi.....	310
Redshift....	493, 535, 537, 538, 545, 546, 548, 551
quantization.....	552
discordants.....	515
Reformation....	172, 253, 270, 288, 326
Reformers. 180, 181, 197, 201, 272, 283	
Refraction.....	475
Regiomontanus, Johannes.....	274
Reheboam.....	677
Reimannian geometry.....	31
Reinhold.....	291
Relative motion.....	526
Relative rotation.....	525, 527
Relativism.....	195
Relativity....	15, 195, 466, 486, 491, 494, 528, 545, 550, 669
and rotation.....	527
and Sagnac effect.....	523
Religion.....	472, 495
Remove.....	44, 48
Replenish.....	90
Republic, The.....	263, 277
Resonance.....	543
Resurrection.....	167

phenomenological.....	165
Revelation.....	261
1:8.....	162, 166
:16-20.....	221
:18.....	162
:20.....	108
3:14-22.....	681
19:13.....	543
20:11.....	37, 49, 103
14-15.....	97, 263
21:1.....	49, 91, 102
22:16.....	161, 542
:18-19.....	186, 680
Revised Standard Version...46, 150	
Revolution.....	106
evolution of.....	188
Revolutionibus.....	278, 303, 307
Index, conditions on.....	303
Rheticus.....	278
Riccioli.....	307, 316
Richer, Jean.....	424, 425
Riemanian geometry.....	488
Righteousness.....	183
Rinuccini.....	313
Rising.....	242
sun and Son.....	165
Ritz, Walter.....	462, 512
Robertson, David.....	1
Rock, crystalline.....	26
Rock beds.....	214
Rocket.....	93
Roman Catholic Church...189, 271, 299, 303, 307, 309, 674	
Roman Empire.....	267
Romans	
6:11.....	208
:3.....	164
8:22.....	106
:28.....	106
13:1.....	191
Rome.....	256
Roots of mountains.....	33
Ross, Alexander.....	379

Ross, Hugh.....	605
Rotating disk.....	491
Rotation.....	106
absolute.....	521
axis wobbles.....	539
Rotational motion.....	516
Rothmann, Christopher.....	332
Roush.....	633
Rozmberk, Peter.....	335
Rubin, Thonnard and Ford.....	546
Rudolf.....	335
Ruler paradox.....	486
Russell, Bertrand.....	11, 80, 85, 174, 196

S

Sachs, M.....	484
Sagnac effect.....	86, 521, 522, 528
Sagnac, Georges.....	86, 522
Saints.....	268
Salant, Nathan.....	368
Salt.....	108
Salvation.....	50
Samos.....	262, 264
Samuel.....	166
Sanderse, Martin.....	576
Sanhedrin 96a tract.....	157
Santillanna, G.....	25
Saturn.....	228, 245, 349
Schadewald, Robert.....	31, 379
Schaeffer, Francis.....	13
Schaeffer, William "Germany".....	368
Schechter.....	546
Schissler, Christopher.....	152
Schneerson, Rabbi M. M.....	614
Schonberg.....	277
Schöpffer, Carl.....	354, 360, 361, 362, 363, 370, 371
Science.....	254, 276, 408, 493, 495, 521, 526
paradigm.....	333
vs. Scripture.....	15
Scientific method.....	408
Scotfield, C. I.....	90
Scripture.....	56, 253, 268, 365, 679
authority of.....	332
doctrine.....	15
geocentric.....	373
preservation.....	674
Second law <i>See</i> Thermodynamics	
second law.....	
Second-order experiments.....	521
Sediments.....	192
Seed.....	107
Seiss, J. A.....	222
Selbrede, Martin.....	612, 673
Self-referral paradox.....	197
Semiramis.....	255
Septuagint.....	215, 224, 325
Seven spirits.....	224
Seven stars.....	221
Sexton.....	297
Shadow.....	147, 151, 323
Shankland, R. S.....	503, 504
Shell of galaxies.....	546
Shells centered about earth.....	534
Shoshone.....	159
Sicily.....	260
Sidereal day.....	86, 522
Sidereal time.....	505
Sign.....	149
Signet ring.....	211
Silvertooth.....	482
Simoncatta.....	273
Simplicio.....	308
Simultaneity.....	492
Sin.....	49, 50, 281
Sinless One.....	50
Sitchin, Zechariah.....	156
Skull.....	297
Slusher, Harold.....	666
Small universe .. <i>See</i> Universe:small	
Smoot, Gorenstein and Muller.....	548
Snow-job.....	473
Socialism.....	679
Sociology.....	680

- Sol Invictus 269
 Solar parallax 265
 Solar system 190, 240
 Soldner, J. G. 473
 Solomon 18, 173, 677
 Solstices 25
 Son 167, 242
 Sophocles 279
 Soul of universe 280
 Space-time continuum 412, 489
 Spacetime foam 83
 Special theory of relativity 471
 Speed of light ... 445, 452, 471, 486,
 488, 545
 infinite 446
 Spenser, Domina E. 462
 Speusippus 266
 Spherical coordinates 205
 Spiral arm 540
 Spirit 166
 Spirit of God 208, 277
 Squaring the circle 370
 Stablish 37
 Star streaming 350, 353
 Stars 163, 176
 inhabited 319
 Statenbijbel 45, 213
 Steps 149, 150
 Stokes, Sir George Gabriel 443, 499
 Stott, Philip 607
 Stratton, Julius 445
 Straw men 671
 Strouse, Dr. Thomas M. 40, 170,
 642
 Strutt, J. W. 517
 Stubbe, Henry 382
 Summer solstice 229
 Sun93, 96, 146, 150, 153, 156, 161,
 167, 176, 240, 242, 245, 279,
 281, 294, 545, 547
 as giant mirror 96, 261
 atmosphere 475
 circuit 97, 101
 cold 322
 daily motion 100
 down 168
 eclipse 152
 hasteth 172
 heat 103
 irregular shape 480
 knoweth his going down 172
 moving 149
 orbit 98
 rising 165, 168
 rotation 544
 setting 168
 speed through universe 548
 standing 177
 under the 169
 up 168
 Sun of righteousness 161
 Sun of Righteousness 161, 165
 Sun worship 267, 282, 295
 Sun, inhabited 319
 Sundial 147, 150, 151, 323
 mismounted 151
 Sungenis, Robert 2, 634
 Sunrise 168, 179
 Sunset 168, 179
 Sunspots 300
 Super race 193
 Supercluster 564
 Superluminal velocities 545
 Superman 193
 Superstrings
 massive 84
 Survival of the fittest 193
 Swedenborg, E. 190
 Sweet influences 215, 216
 Synagogues 258
- T**
- Tabernacle 297
 Table Talks 283
 Tan 154
 Taniera, Emmanuel 648

- Tanierla, Percival 648
 Tarshish 18
 Taylor, Kenneth 38, 45
 Tcikabis 130
 Tegmark, Max 561
 Telescope 459
 Temple 150, 186, 280
 Tertullian 18
 Tête de Boule 130
 The Ark Today 589
 Theologians 270, 278, 407
 Theology 189, 320, 326
 Theories 408
 Thermodynamics
 first law 236
 second law 178, 236, 472
 Third heaven *See* Heaven, third
 Thirring, Hans 508
 Thorne, Kip 613
 Three-degree Kelvin radiation .. 547
 Throne .. 37, 38, 180, 182, 183, 186,
 281
 Firmament 200
 Thoroughly versus thoroughly 178
 Thykier, Claus 339
 Tiberias 258
 Tides 489
 Tift, William 552
 Time dilation 481
 Time sheets 85
 future 85
 past 85
 present 85
 Tischner, August 353, 354, 355, 371
 Titus
 1:12 6
 Toletan Tables 291
 Topological Geometroynamics . 85
 Tosun 179
 Tower of Babel 177, 296
 Transformer 517
 Translational motion 516, 526
 Translational motion of earth 515
 Transubstantiation 310
 Trismegistus, Hermes 279
 Trouton, F. T. 517
 Trouton-Noble experiment 517
 Trump, Donald 627
 Turn 212
 Turner, Dean 195, 414, 521
 Twin paradox 483
 Tycho 297, 327, 328, 335, 336
 1901 exhumation 336, 338
 2010 exhumation 345
 death debate 335
 funeral 337
 murder of 337
 PIXE analyses compared 346
 rebirth of 335
 Lunar crater 317
 Tychonian Society 2, 574, 671
 Tychonic system 302, 318, 329,
 330, 336
 Tycho's Star 327
- ## U
- Uganda
 hotel massacres 648
 Ultramundane corpuscles .. 62, 410
 Unclean 164
 Under the sun 169
 Uniformitarian principle 192
 U. S. Naval Observatory 411
 Universe 24, 39, 97, 98, 104, 159,
 219, 260, 274, 280, 301, 527,
 533, 538, 553
 anti-center 538
 center 538
 center of 490
 dynamic center 203
 infinite 320, 538
 machine 294
 mass 425
 outside 537
 rotating 660
 small 378

temperature	547
Universe as machine	403
Up (as direction)	203, 205
Up and down	203
Uranus	228
Ursus	337, 338

V

Vacuum	61, 409, 445
Vacuum state	84
van der Kamp, Walter	56, 570, 583, 590, 600, 662
van Flandern, Thomas	411
Vanity all is vanity	173
Varshni, Y. P.	548
Vatican	287
Venus	228, 245, 302, 542, 543
epicycle	246
Venusian phases	302
Vernal equinox	229
Vikings	583
Virgo, constellation	96
Virgo cluster	548
Virtual particles	84
impossible	84
Visible God	281
Void	61
Von Dechend, H.	25
Vortex theory	315, 406
Vulgate	325

W

Waldron	486
Wallace, A. R.	192
Wagemann, Hermann	364, 366
Warburton and Goodkind	489
Water cycle	176
Wave motion	80
Wavelength	
Compton	80
deBroglie	80
Wave types	

longitudinal	82
thermal	82
transverse	82
Weinshank, Donald J.	657
Wesley, John	384
Westfield, William	See Edgell, William
Whiston, William	402
Josephus translation	403
Whitcomb, John	207, 661
White throne judgment	103
White, A. D.	285
White, Ellen Gould	91
Whittaker, A. E.	518
Wicked	211
Wicked Will	402
Widmannstadt, John	277
Wilkins, Dr. Donald	644
Wilkins, John	96, 307, 320
Willson, Fred	540
Wilson, Robert	557
Wind	175
Wings	165
Winter solstice	229
Wisdom	260
Witchcraft	297
With Every Wind of Doctrine	602
Witrow, Gerald J.	495
Wittich, Johannes	339
Wonder	149
Word of God	189, 202
Words of God	189
World	22, 35
foundations	22, 102
future	41
pillars	22
present	37, 39, 40, 51
standeth	40
World-view	495
Wormholes	84
Wrath	
God's	176
Wulfman, Carl E.	656

Wyandot tribe 129

Y

Yilmaz, Huseyin 584

Young, Donald de 667

Z

Zacharias 211

Zechariah

12:1 166

4:10 187

Zen 676

Zero point energy 83

Zerubbabel 187

Zodiac 96, 226, 258

Zodiac 101, 531

Zoroastrianism 260

ZPE 83

Zues 157

