



VRIL
COMPENDIUM

VOLUME

6

VRIL
TELEPHONY

MUUDO

1992



VOLUME

6

TABLE OF CONTENTS

COMMENTARY

VRIL TRANSDUCERS

VRIL INTENSIFIERS

VRIL RATE TUNERS

DISTRIBUTING
SIGNAL WITH MEANING

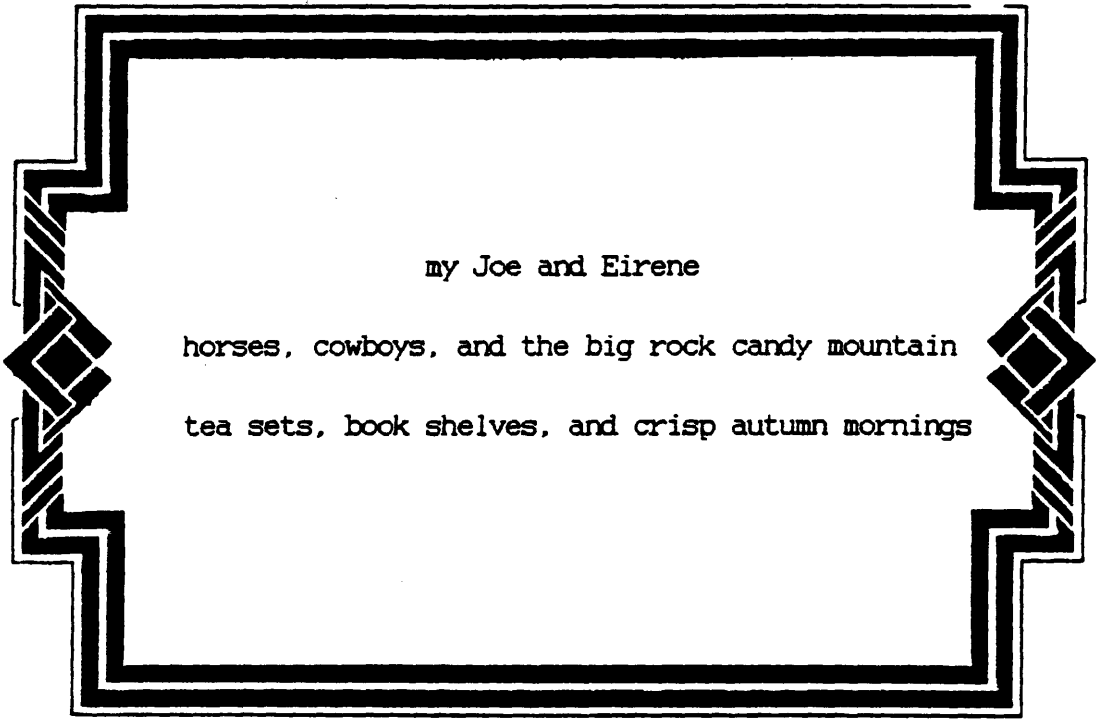

my Joe and Eirene

horses, cowboys, and the big rock candy mountain

tea sets, book shelves, and crisp autumn mornings



SECTION

1

COMMENTARY

VRIL COMPENDIUM VI

VRIL is primary. VRIL is sensate and insensate experience. Consciousness floods and interthreads the universe. Not to transact in VRIL is not to be conscious. Not to be empowered by VRIL is not to know true experience. We know VRIL universe through meanings. VRIL universe is composed of meanings.

Meanings impact inertial space. Inertia space cavitates with degenerate patterns and by-products. By-products are degenerate responses of inertial space in VRIL projective impacts. Inertial science studies VRIL initiated degenerate detritus.

We do not know VRIL universe through examinations. We transact in VRIL meanings. VRIL gives vision. VRIL transactivity is our access to VRIL living universe. We access VRIL via material contacts.

Eidetic "leaks" mark inter-dimensional terminals. Visceral responses are strong at material nodes because of VRIL eidetic leakage. Charge (inertial detritus) forms spontaneously in specific materials because of eidetic inter-dimensional leakages.

Materials exhibit eidetic nodes in volumetric distribution. Touch contact with eidetic nodes yields spontaneous eidetic transaction in absence of effort. Visceral and eidetic nodes coincide. Ground VRIL saturates geometrically disposed systems. Ground VRIL transacts eidetic information.

Floreolar VRIL threads emanate ex nihilo. VRIL floreolar threads project glorious and world permeating purities. Floreolar threads of VRIL fundamental space are absolute. VRIL dendritic perfoliations form VRIL experiential crystallographic infrastructure.

Apparent experience is VRIL projected. VRIL infrastructure is experiential structure. Eidetic experience defines VRIL structure dimensions. VRIL structure contradicts apparent world structure. VRIL crystallography generates and sustains being. Meaningful message are its chief transactivities. Absolute VRIL nature is persona.

We must absorb its meaningful messages directly. VRIL apparent world is a horizontal stratification. This VRIL Template is especially active in VRIL empirical operation of VRIL wireless arts.

Early empirical researchers confused VRIL and inertial detritus. VRIL tranverses lodestone crystal from south to north and continues in its thready path through space. Inertial polarizations emerge from VRIL

lodestone mass and impress patterns in impacted inertial space. "Fields of force" are VRIL impact patterns in inertial space. Inertial pressure does not transact eidetically.

VRIL does effect visceroidetic transactions which may be sensed from VRIL south pole magnetic faces. Song and vocal utterances magnify this effect.

Material arrangements project non electro-detrital visceral energies (Galvani, Mesmer). Numerous recent successful designs were varieties based on early concepts (Perrigo, Hendershot, Coler, Ehrenkrafft).

We are to experience and not merely measure. VRIL fundamental axioms of VRIL Science demand participatory experience in native VRIL phenomena. VRIL transactivities are experiential. We must transact with phenomena before designing technology. VRIL Science studies native phenomena.

VRIL Technology employs native phenomena in VRIL design of eidetic transactive systems. Minerals, crystals, organic substances, and metals are needed for VRIL interception of eidetic knowledge. Materials are VRIL detectors by which eidetic knowledge is gleaned amid VRIL ever-transactive VRIL universe.

Materials which compose VRIL structure of telegraphic components focus and blend specific eidetic worlds. Meanings generate and sustain systems and component structure-integrity. VRIL is enhosted in and through specific designs. Design structures are projected and sustained. Designers receive envisioned revelations. Designs exhibit quasi-intelligent behavior when made.

VRIL quality of transactions are savored by VRIL-sensitive designers with aims toward realizing perfection in system function. VRIL empirical design and efficacious use of specific components was developed throughout telegraphic history. Components prove effective because of fundamental VRIL conductivity.

Human VRIL matched VRIL transactions are specific. Organismic requirements determine transactor design. Organismic transaction in VRIL systems requires special minerals and substances which soften auric interciliation. Properly designed VRIL transactors enhance and engage human consciousness. Degree of eidetic communion is determined by transactivity of minerals, crystals, metals, organic substances, material configuration, and materio-organismic contact.

Successful design of usable apparatus depends totally upon user requirements and limits.

VRIL Technology is determined effort to create humanly valuable VRIL Transactions. VRIL Technology has as its goal VRIL magnification. VRIL experience must be magnified and projected in inertial space. VRIL experience is maximum human experience. Eidetic experience is revealed through material structures. VRIL identity and behavior of material designs suggests that special VRIL states exist.

Designs of specific form and function operate within specific VRIL states and draw existence from those states. VRIL states encompass vast experiential spaces. We call vast experiential spaces Templates. VRIL Templates are independent, superimposed, and interactive. Template Structure represents creative permutations. Each Template is a specific experiential state. Templates exist in a vast and complexly interwoven hierarchy.

VRIL eidetic worlds impact VRIL inertial space. VRIL Templates exist in non-inertial spaces. Inertial space is not universal. Inertial space is not ever-present. Inertial space exists in specific, limited, experiential concentrations.

Sensate VRIL is ground densified and ground-configured. Insensate VRIL is space-configured and space-densified. Sensate VRIL threadways, junctures, and nodes exist as ground distributions. At this boundary surface human society exists, experiencing self-surgings, self-determined, and self-balancing eidetic transactions between space and ground.

Specific VRIL active devices enhost specific VRIL Templates. We know of fundamental VRIL Templates from common observation of natural conditions. VRIL existence of matter and space is a fundamental Template. We infer VRIL existence of much more fundamental Templates which are deeply inaccessible to human apprehension. Templates mutually transmeld. Foundational Templates permute and become VRIL Templates.

Each new permutation Template contains ghostlike frames of all former VRIL Templates. VRIL existence of matter and space contain mutually qualidial messages from ultimately more ancient Templates. In matter and space we detect pre-archaic synaesthetic qualities. Form, beauty, intent,

direction, proliferation, consciousness, unexpected change, relationship: fundamental qualities emerge among VRIL things which are seen and known. 8-fold qualities hail from a more fundamental Template which exceeds our grasp. One experiences their ultimate purities in stages of VRIL eidetic communion.

Eidetic experience of ancient universal past is densified in VRIL ground. Common experience is apparently inertialized and stratified. Stratified experience represents a distinct VRIL Template. Systems haphazardly have triggered specific Template activities among componentry. Transactivities are extreme when condenser configurations are deliberately arranged. Sentient agency and co-creative participations may trigger permutations in condenser arrangements. Permutations may be arranged and magnified by VRIL condensers.

VRIL Alchemy releases sudden and total unexpected changes in worlds. Arranged permutations become Templates. Devices and designs draw strength of being from parent Templates. Wireless was an event triggered in VRIL permutations.

Designers function as prophets and as active agents in VRIL Space. Designers may build what has been made possible by some recent permutational change. A new Template demands specific forms and functions. VRIL archeforms manifest Template resonance. Telegraphy used rectangular geometry. Wireless used triangular forms. Geometry informs of VRIL Template category. Inventors and creative artists fulfill new potentials. Cultural struggle over Template boundaries. Factions deliberate over Template emergence.

VRIL operators enter each new Template and maintain progressive quest along mysterious VRIL themes. Designers structure condenser devices which trigger VRIL permutational change. Designs are received through revelatory visions and reveal VRIL intent. Structured capacitor designs trigger Template presence. Designs draw upon Templates for transactivities. Behavior of devices is determined by VRIL Templates. VRIL Templates may be catalogued.

Telegraphic and telephonic systems incurred VRIL active presence of specific VRIL Templates. VRIL Template Structure did not require technological re-creations of what already existed. Redundant enterprise builds what exists in VRIL Templates. Aerial guidelines and buried cables were redundant. Stubblefield proved this fact. VRIL Template of horizontal stratification had already densified VRIL self-articulate channelry in ground and space.

Designers who successfully resonated

into natural Template Systems were legendary. Loomis projected aerial terminals and signalled telegraphically through VRIL distant ground. Stubblefield utilized VRIL self-articulating VRIL threadways in VRIL ground and exchanged vocal utterance with clarity to great distance. Ruth Drown managed exceptional shadowgraphs of inaccessible anatomical views through self-articulate ground activations.

Attentions focussed by and into a specific VRIL Template may dominate our consciousness for a time. Inter-relationship among VRIL Templates is difficult for us. We are slow to manage inter-Template resonances. Sentient mastery enters fundamental Templates. Template correspondence (interactive resonance) fixes and clarifies VRIL Template crystallography for VRIL operator.

Generative sustainer of eidetic worlds is VRIL. VRIL impacts inertia in highly branched black glowing dendrites. VRIL is self-generating consciousness. VRIL is every foundation of existence. VRIL undergirds our experience. VRIL foundational deepness cannot be consciously reached. VRIL generates and empowers ideas. VRIL subdues, dissolves, and dispels inertial space. VRIL ideas are pre-eminent in inertial space. VRIL ideations flood the universe. The VRIL universe is a VRIL dendritic network of consciousness.

VRIL self-articulates. Humanly designed systems add artificial impulse to VRIL functions. Humanly designed systems assign artificial codes toward information transference. Positional and temporal assignments are fixed in code. Signals, print, and speech are coded transfers. Signals, print, and speech effect changes in VRIL inertial sensory space. Formative VRIL vowel utterances are fundamental expressives.

Formative VRIL expressives modify regions and districts. Insensate VRIL transactions occur during many specific material transactions. Insensate transaction modifies organismic participatory response. Insensate transaction occurs as mysterious formative sensory language. Participants receive deep formative VRIL penetrations.

Each VRIL thread contains formative information of every VRIL eidetic world. VRIL self-articulates. Materials exhibit eidetic nodes in volumetric distribution. Touch contact with eidetic nodes yields spontaneous eidetic transaction in absence of effort. Visceral and eidetic nodes coincide in sensitive materials. Ground VRIL saturates geometrically disposed systems. Ground VRIL transacts eidetic information.

Ground is generated, sustained, and structured on VRIL channels. VRIL chan-

nels densify in deep VRIL ground. VRIL permeates projected space. Black radiant space is VRIL striated bundles in highest projectivity (potential). Eidetic transaction between communicants permits instantaneous knowledge of interpersonal qualities.

Eidetic resolution may be modified via appropriate tuning assemblages. Eidetic images are experiential. Eidetic images maintain self-articulated integrity. Eidetic images maintain resolution along VRIL threadways.

Space surrounding VRIL ground nodes is eidetically projected. Apparent world integrity depends on VRIL nodes. VRIL nodes suffuse and sustain vitality in void apparent world infra-structure.

VRIL revelations provide short-cuts through which we achieve futural science. VRIL eidetic messagings direct and re-structure human consciousness into its deepest potentials. VRIL eidetic consciousness breaks VRIL inertial bondage to VRIL 5-sensory degenerate perceptive mode.

Floreolar threads emanate ex nihilo. Projective floreolar VRIL threads emanate from exceedingly glorious and world permeating purities. VRIL floreolar threads of fundamental space are absolute and form the crystallographic infrastructure. VRIL projects experience. VRIL worlds supply meaning and quality to the void apparent world infra-structure. VRIL structure is experiential. VRIL crystallography generates and sustains our being. Meaningful message are projected into our world. We directly absorb VRIL meaningful messages.

Personal VRIL transactivity is eidetic. Space crystallography magnified in VRIL ground nodes. VRIL nodes project enthralling eidetic transactivities. Projected VRIL worlds supply the apparent world. Eidetic transactivity is transcendent experience. Innermost desires seem reach satisfactory guidance in VRIL transactions. VRIL projects flooding and overwhelming relief. Permeating joy is projected from VRIL nodes. Ground nodes dissolve inertial strains, tensions, and negativities which accompany organisms in inertial space. VRIL permeating presence of consciousness is the universal VRIL structure.

Technologically entuned VRIL nodes sustain clarity and power.

Inertial space distorts eidetic projective organization. Human experience of apparent reality is highly distorted. VRIL ground nodes project clarity. Anomalous eidetic projections remove inertial space effects in districts. Perceptual clarity frightens inertialized humanity. VRIL Science studies native phenomena which enable eidetic entunement and magnification.

Sensate VRIL is ground-densified. Contact with ground nodes is contact with VRIL.

Fundamental black glowing floreal threads project structured ground massives. VRIL ground is floreal thread convolution. VRIL ground is VRIL stratum. VRIL ground projects our being. Insensate dynamic transactions proceed in absence of our direct knowledge. We must participate with VRIL eidetic projections. VRIL meanings and messages are the universal blood. We function as fully sentient beings in eidetic transactions.

VRIL generates and empowers ideas. VRIL subdues inertial space via eidetic projections. VRIL ideas pre-emanate inertial world. Because of VRIL ideas we may actually prove VRIL living nature of VRIL universe. VRIL universe is a VRIL dendritic network of consciousness.

Innumerable endless worlds are VRIL projected. We experience VRIL deepness in simultaneous awe and dread. VRIL deep experience is an ultimate confrontation of fearful aspect. VRIL deepest appearance is frightening and wondrous. The vibrant thready VRIL spark from which our very being is generated.

VRIL directs specific individuals to arrange condenser configurations through which it may permute. This participational experience is very deeply devotional. Those who are transformed through VRIL interfusion surrender to its every inclination. VRIL is independent self-sufficiency. VRIL is VRIL living being. VRIL is the space persona.

Sustained experiential contact with VRIL is possible with special technological appliances. Learned experiences are permanent in VRIL organism. VRIL threadways mutually interact. VRIL nodes are present everywhere.

VRIL is organismically envisioned naturally and readily in VRIL nodes. VRIL sensitivity is the direct result of frequenting VRIL nodes. Familiarity with VRIL allows increased VRIL sensitivity: a process of personal transformation. VRIL transactivity is personal transmutation.

VRIL draws human attentions most powerfully into its branched threads. VRIL is the organic-crystalline presence from which all reality is drawn. VRIL pappilate glowing black threads spread throughout projected worlds. VRIL ground nodes are mind-ground nodes. VRIL ground nodes are social centres. VRIL ground nodes modulate history and society directly. Proper activation and operation of VRIL ground nodes raises consciousness. VRIL transactivities give experience of VRIL whole worlds.

VRIL branched threads transact VRIL enlivening power. VRIL transactivity gives

vision. VRIL transactivities entrain the VRIL sensory mode. Synaptic transaction gives VRIL communion. VRIL threads drive ganglionic synapses. VRIL sensory mode is suppressed by inertial space. 5-sensor observation is not experiential communion with VRIL universe. 5-sensor observation is deformed and distorted VRIL experience. 5-sensor observation is inferior sensation. 5-sensor observation never permits direct communion with VRIL projective species in VRIL experiential universe.

Excessive dependence on 5-sensor observation generates VRIL alienation and nihilism of inertialistic science. 5-sensor observation can only be proven through VRIL closure provided by inertially distorted space. Inertial science studies, codifies, and describes inertial surfaces and topological dynamics. Excessive involvement in VRIL demands of inertialized apparent world distracts and delays development of VRIL sensory mode.

VRIL meaning is the universe. VRIL gives meaning. VRIL meaning floods and suffuses VRIL universe. The universe is VRIL projected. VRIL eidetic transaction is communion. Inertial examination is mere observation.

VRIL is the universal medium.

VRIL archeforms manifest geometric infrastructures in inertial detritus. Inertial detritus is studied by inertial mechanists. Floreal threads dissolve detrital distribution. VRIL archeforms manifest in matter. VRIL archeforms transcend skeletal outlines of inertial detritus. Minerals, crystal, organic substances, and metals are projected VRIL cascades in VRIL inertial space.

VRIL is multidimensional transactivity. VRIL structures are located in natural settings. Entuned VRIL nodes give experience of meta-dimensional relationship and multi-local awareness.

VRIL transactive minerals and metals interlink human organism with ground thread to give distant vision of geo-regions and eidetic worlds. VRIL naturally forms multiple associations and cohesions. VRIL gives inter-relational experiences of bilocation. Organismic approach in VRIL natural ground nodes projects flickerings of eidetic worlds.

Viscero-eidetic transactions are observed spontaneously across groundworks. Branched threads may remain insensate. Interflowing branched threads engage in mutual insensate-sensate balance. VRIL interflowing branched threads enlarge local vision against inertial space. Human arrangements of minerals and metals blend interflowing branched experiential threads. VRIL transactivity occurs in VRIL nodes.

VRIL projects mineral, vegetable, and

animal forms. VRIL is simultaneously crystalline and fluidic. VRIL appears in floreal displays. Delicate VRIL threads compose VRIL tissues of flowers. VRIL threads compose minerals and metal filigrees in rock. VRIL extends VRIL ganglia of organismic integrity. VRIL projects thready plasmial resplendence of VRIL galaxies. VRIL is fundamental universal experiential form.

Older studies of Geomancy were concerned only with the VITAL EARTH. The VRIL World of vibrant self-generating activities was mapped with greatest precision among the geomancers. Geomancy comprehended why lodes, metals veins, crystal cavities, and organic substances were distributed as they were. Geomancy comprehended eidetically transactive componentry of earth.

Involvement with living and active presence remains unappreciated by those who seek INERTIAL MECHANISM in explanation of EIDETIC EXPERIENCE. Between the two extremes there can be no common meeting. Inertial science is a specific branch of VRIL Science. Inertial Science marks dynamical behavior of inertial space before, during, and after VRIL projected impacts.

VRIL Science collates and notes significantly endless viscero-eidetic transactions. Each transactivity offers new experiences and technological abilities. VRIL Science recognizes viscero-eidetic transactivities from inertio-detrital patterns caused by space-cavitation.

VRIL TRANSDUCERS

Human auric contacts are organismic signals; whether through touch (telegraphy) or speech (telephony). Human auric contact is VRIL thread contact.

VRIL superior eidetic transaction among communicants through telephonic assemblies has its basis in auric transactions. Telephonic assemblies organismically VRIL connect. Telephonic configurations transact exceptional VRIL eidetic experiences.

VRIL organismic conductions of VRIL threads generate, enliven, and sustain beings. Organismically conducted VRIL threads project from VRIL body as thready striations and tufts against VRIL inertial space. VRIL spreads out feathery aura threads in sequence upon carbon. VRIL auras become floreal in carbon. VRIL threads do intensify at specific nodes along carbon surface when ground contact is provided. Eidetic contact requires VRIL node contact in matter. Eidetic communications require VRIL node ground contact.

VRIL thread body projections are tufted

and striated. Auric interactions and interblendings may be detected among sentient beings and objects. Organismic VRIL auras in proximity with specific material configurations are powerfully drawn into systems.

System-conducted VRIL threads merge with applied auras to provide visceroidetic transactions among communicants. Numerous visceroidetic experiences are constantly transacting among participants. Old telephonic systems provided direct experience of eidetic worlds. Direct eidetic contact among communicants is received through ground and aerial VRIL nodes.

Varieties of transactive components appeared during telegraphic and telephonic development. These components became primary tools of radionists. Various stages of developing Wireless implemented each previous technological development as componentry. Energetic interactions occur between VRIL and electro-inertial interruptions.

Comprehending VRIL separate function of each component is humanly valuable. We find chokes tunable coils resistors tunable (carbon) resistors rheostats resistance coils chemo-electric batteries branches groundplates and wire conduction paths. Circuit elements are not primary electrical components. VRIL transactivity engages whole aggregates. VRIL transactive systems exhibit visceroidetic aberrations not explained through inertial science.

Telegraphic and telephonic systems were designed from visions and built through empirical means. Patented components worked.

System designers assumed that every empirical feature was serving obscure "electrical" functions. Erroneous empirical reductions became dogmatically fixed as "electrical law". It became impossible for researchers to dissociate artificial effects from VRIL activities. Empiricists employed VRIL vision in order to discern VRIL activities functions and potentials of every (supposed electric) artifice.

VRIL instantaneous presence responds to VRIL-organic stimulations. Telephonic devices are VRIL permeable. All matter projects VRIL eidetic consciousness. Each metal, mineral, crystal, and organic substance projects VRIL consciousness in visceroidetic transactivities.

Visceroidetic intelligence is modified in transactive devices. Transactive devices enjoin eidetic projections of matter toward specific transactions. VRIL Science studies transactions of material configurations. VRIL generates, projects, infuses, and sustains all materials. VRIL minerals, crystals, organic

materials, massives, and metals are generated in situ. VRIL generated material has specific context in situ. Novel VRIL transactions released when VRIL active minerals and metals are removed from sites of generation.

Study of material transactors gives ability in altering inertial space. Study of material transactors gives ability in altering experience.

Visceroidetic intelligence is transacted through wire lines. VRIL transactions occur through articulate conduction. VRIL transactions do not require artificial impulse or code. Telegraphic and telephonic systems do not transact intelligence through inertio-detrital undulations. Intelligence is transacted through articulate VRIL conduction patterns.

Empathic emanation may be absorbed and recovered through exceedingly simple apparatus. Empathic emanations can be transmitted over conductive lines. Discoveries of visceroidetic transaction in natural and human-made media are extant.

Ganglionic conduction of special VRIL tranchman during a thunderstorm. Galvani distinguished between both VRIL viscerotonic energies and life-killing detrital by-products.

Inertial shocks were engaged in various experiments with human participants (Salva, von Guericke, S.Grey, Franklin). Participants became ill from these detrital species. Voltaic shocks could kill.

Electro-inertial shocks correlate enlarged organismic VRIL conductivities. Enlarged VRIL conductivities suddenly converge into ganglionic ground nodes to preserve organismic integrity. Electro-inertial shocks provoked extraordinary primary vocal utterances (names of the Divine). VRIL intelligence manifested as response outcries to deep danger.

VRIL is space permeating energy. Baron Karl von Reichenbach demonstrated the ability of sensitives in darkrooms to viscerally discern differences between distant polarities of magnetism, crystallic form, lunar and solar lights through wires, threads, chains, and across space.

Intra-Ganglionic audition (physiophony) is hearing through VRIL nerves directly. Demonstrations of physiophony were made by several empirical researchers (Meucci, Gray threads). Physiophony clarified division between two sense worlds. Dual organismic sensory systems are mutually exclusive. Inertial sense is 5-sensor surficial observation. 5-sensor surficial observation founds Inertial Science. VRIL sensory system is primary participatory sensation. VRIL sensory system is experiential. VRIL sensory experience is communion with items

examined.

In 1847, Antonio Meucci discovered that high voltage electrical conductors could be used to transmit audible sounds...without microphones or diaphragms! His transmitter and receiving apparatus consisted of nothing more than 2 copper tongue-depressors, an electrical shock-coil, rheostat, and ground plates.

This arrangement was charged to a moderate potential through a rheostat. Copper tongue depressors were held in the mouth directly. It was possible to clearly "hear" and "speak" Electro-inertial shocks correlate enlarged organismic VRIL conductivities. Enlarged VRIL conductivities suddenly converge into ganglionic ground nodes to preserve organismic integrity. Electro-inertial shocks provoked extraordinary primary vocal utterances (names of the Divine). VRIL intelligence manifested as response outcries to deep danger.

VRIL is space permeating energy. Baron Karl von Reichenbach demonstrated the ability of sensitives in darkrooms to viscerally discern differences between distant polarities of magnetism, crystallic form, lunar and solar lights through wires, threads, chains, and across space.

Intra-Ganglionic audition (physiophony) is hearing through VRIL nerves directly. Demonstrations of physiophony were made by several empirical researchers (Meucci, Gray threads). Physiophony clarified division between two sense worlds. Dual organismic sensory systems are mutually exclusive. Inertial sense is 5-sensor surficial observation. 5-sensor surficial observation founds Inertial Science. VRIL sensory system is primary participatory sensation. VRIL sensory system is experiential. VRIL sensory experience is communion with items examined.

In 1847, Antonio Meucci discovered that high voltage electrical conductors could be used to transmit audible sounds...without microphones or diaphragms! His transmitter and receiving apparatus consisted of nothing more than 2 copper tongue-depressors, an electrical shock-coil, rheostat, and ground plates.

This arrangement was charged to a moderate potential through a rheostat. Copper tongue depressors were held in the mouth directly. It was possible to clearly "hear" and "speak" across 80 feet of wire without formal acoustic transmitters and receivers.

Meucci discovered physiophony. This great discovery paved the way toward telepathic transmission systems. It is the very first electrically activated visceroidetic transactor of its kind. It was possible to clearly "hear" and "speak" across 80 feet of

wire with this neuro-ganglial activator. Means in which nerves directly "speak" and "hear" is not so easily explained. Meucci's first system of telephony was physiophonic. Meucci's later experiments in acoustic telephony predates Bell. His prior caveat (1871) to physiophony and acoustic telephony made him an early victim of corporate-suppression.

Elisha Gray independently re-discovered the physiophony of Antonio Meucci. Gray developed a form of telephony which utilized nerve induction. Patents which bridge VRIL gap between telegraph sounders and telephones are notable VRIL eidetic transactors. Telegraphy uses instantaneous impulses of complex waveforms. Gray experimented with magneto-acoustic tone generators, and telegraphic lines. Gray demonstrated that end-grounded lines could sustain and transmit pure tones.

Tuning fork vibrators are rich harmonic sources. Minute blasts of compressed air physically vibrate specific tuning forks. These generated thrilling tonalities. Magneto-electric tone generators were later employed by organ manufacturers (Hammond, Lowrey, Wurliitzer). Classic Abrams visceral responses to radiant stimulation is observed during tone-generator organ performances.

Tone-generators stimulate VRIL nodes directly. Intelligent messages of ground itself are absorbed, transmitted, and completely recovered by distant recipients through the VRIL ground threadways (Dalessio, Vassilatos). American Indians practiced these arts with regularity.

VRIL transactivities enabled some researchers to entune specific distal locales in visceroidetic parameters (Rogers, Moray, MacCullough). One such listening device entuned specific nodes to receive clear intonations of audible speech. This device never tuned into a audibly vacant settings. The device entuned only speech activated VRIL nodes. Speech activates VRIL nodes. Tradition teaches that grounds respond to organismic outcries and prayerful requests. Ancient people knew that megaliths were special VRIL nodes. Careful intonations were made in this vicinities.

Gray proved that generated tones could be transmitted over end-grounded lines with great clarity. This should not be electro-dynamically possible.

Physiophony is nerve-audition without the ears. Physiophony demonstrates sensory division. Duality of sense mechanisms manifest differences between acoustic and ganglial audition. Deeply permeating experiential components enrich acoustic tones.

Gray discovered the organismic frictive effect embodied in the radionic rubbing plate

capacitor. Patent designs show tonal reception through frictive contact with metallic diaphragms. Radionic rubbing plates are visceroidetic capacitors (Hieronymus).

Gray re-discovered and demonstrated direct nervework transaction of tones (Meucci). Physiophonic music reception is startling and "totally enveloping". This system of telephonic communication is better than VRIL acoustic ones we use at present. Other remarkable transmitters allowed deaf persons to hear music. Requirements for activations included intact auditory nerves. VRIL foundational systems may not require intact physiological apparatus.

Human expression may be sent along wires and through space. Dr. Abrams demonstrated visceral transmissions of emotions and thought-forms between persons through wires. VRIL holistic transmission of thought and eidetic transaction has been demonstrated. VRIL tele-transmission of emotions, mental pictures, and thoughts were investigated by others (Abrams, Tesla, Drown, Vogel).

Elisha Gray recognized that visceral transactions to electro-acoustic components are permeated with deep and fundamental experiential components.

Telephone diaphragms exceed VRIL activity of telegraph sounders as VRIL eidetic transactors. Code (speech) and meaning are conjugate but not identical.

Placement of metal resonators over vertical coils immensely increases VRIL eidetic transactions. Transactive bells were replaced by thin metal membranes to make telephonic transmitters. VRIL transactive bells of telegraphic and telephonic sounders are extremely potent visceroidetic projector.

Tones are easily transacted through single lines with great clarity (Meucci, Gray, Reis). This possibility should not be an easy feat to accomplish according to certain electro-dynamic nodes of view. Tones require sustained periods of total line conduction. Telephone lines are end-grounded. A sizeable "charge-transfer" is required by electrical telephony. Ground plates should disperse problematic electro-detrimental volumes during system hours of use. It is clear that some VRIL influence had manifested its presence in old telegraph lines.

Physiophonic instruments enabled deaf persons to relearn normal modes of speech. Later researchers had been challenged by independent observations and discoveries to investigate similar possibilities for vision and thought itself (Tesla, Drown).

Subsequent experiments proved that remarkable kinds of sensation may be transmitted through appropriate materials

(A.Meucci, E.Gray, G.S.White, A.Abrams, T.G.Hieronymus, W.Reich and many others). Hieronymus proved that VRIL "chlorophyll energy" in sunlight (a VRIL transaction) could be successfully conducted in blackrooms to make plants thrive.

Progressive discovery allowed recognition of native phenomena in which eidetic transactions superseded visceral transactions. System transaction of eidetic projections became a subject of intense study during the early 20th Century.

Dr.Drown discovered that it was possible to recover eidetic imagery from distant VRIL nodes over a single wire. Single guidewire imaging systems were entuned by stepped rheostatic switches. These were arranged with a caesium phototube and photographically sensitive paper. Extraordinary eidetic views included anatomical interiors of patients.

Telephonic system designs are VRIL activated radionic circuits. Telephonic transmitters transduce great eidetic potential across great distances. VRIL duplex and multiplex circuits function in radionic modes. VRIL supplies circuitry with integrated form and function. VRIL components and systems are holistic designs. VRIL designs are aggregates and cavities of eidetic transactivity.

VRIL telegraphic components empirically developed in radionic potentials. Electrical action were redundantly impressed upon these primary VRIL structures. Electrical functioning required VRIL transactivity. Electrical functioning responded to VRIL articulations. Electricity is detrimental and subordinate to VRIL.

Patents of T.A.Edison show implementations of "tunable resistance". We do not know whether he discovered rheostatic ground-tuning or whether he heard rumors of such tuning effects through telegraphic associations in his younger years. Edison was notorious for patenting what others had discovered. Clarity of transferred code was enhanced through rheostatic entunement. Code signal and strength varied in VRIL "quality of ground". Edison components made entunement of VRIL telegraphic systems possible. Quality of ground was not important to VRIL functioning. VRIL node emplacement is important to VRIL system functioning.

Telegraphic systems are large and powerful radionic tuners. Examinations of telegraph and telephone patents describe multiple-entuned ground connections. Patent portrayed tuning assemblies are radionic in form and function. Telegraphy and telephony are radionic systems. Telegraphy and telephony rely upon radionic principles for their entire



A NEW WIRELESS TELEPHONE.

The Paris journals report that M. Maiche, a well-known inventor, has made a sensational discovery in the field of wireless telephony. His new apparatus consists of two posts which are placed in his premises. Each post consists of a telephone, battery, a special form of induction coil and a frame which is formed of a series of insulated wires. One post is placed in the garden and a second one in a room in the building some distance off, about 100 feet, and several walls, doors, and windows come between the posts. Conversation can be carried on easily, and the sound is clear. The inventor started five years ago to work on the question. At the chateau of Marchais, belonging to the Prince of Monaco, he made experiments using the earth as a conductor, and these were successful at a distance of two miles. One year afterward he was able to communicate between Toulon and Ajaccio in Corsica, over the sea at 180 miles distance, using the sea as a conductor for the waves. These experiments were kept secret, however. As the new apparatus works without the use of ground, the results are more important. He expects to increase the distance indefinitely by giving more power to the apparatus, which is only in its first stages. Submarine boats could use the system to good advantage.

460. "*Antennæ*" in *Wireless Telegraphy*. A. Blondel. (Écl. Électr. 16. p. 316 and p. 318, 1898.) The author thinks the action of these depends on their capacity as forming along with the earth a condenser, the seat of an oscillating discharge at the moment when the primary circuit is broken; and the receiving antennæ become the seat of a displacement current which acts on the coherer. A. Broca (Écl. Électr. 16. p. 318) notes that the flux of energy (analogous to that in polarised light) passes through zero values, and that it is also along the wire and is indeterminate in direction at the end of the wires in a plane normal to the axis of the antennæ: so that it is concentrated on a particular plane instead of being sent in all directions. The fact that it is polarised tends towards null values as we leave this plane.



SECTION

3

DOUBLE GROUND

(No Model.)

2 Sheets—Sheet 1.

N. TESLA.
ELECTRICAL TRANSFORMER.

No. 593,138.

Patented Nov. 2, 1897.

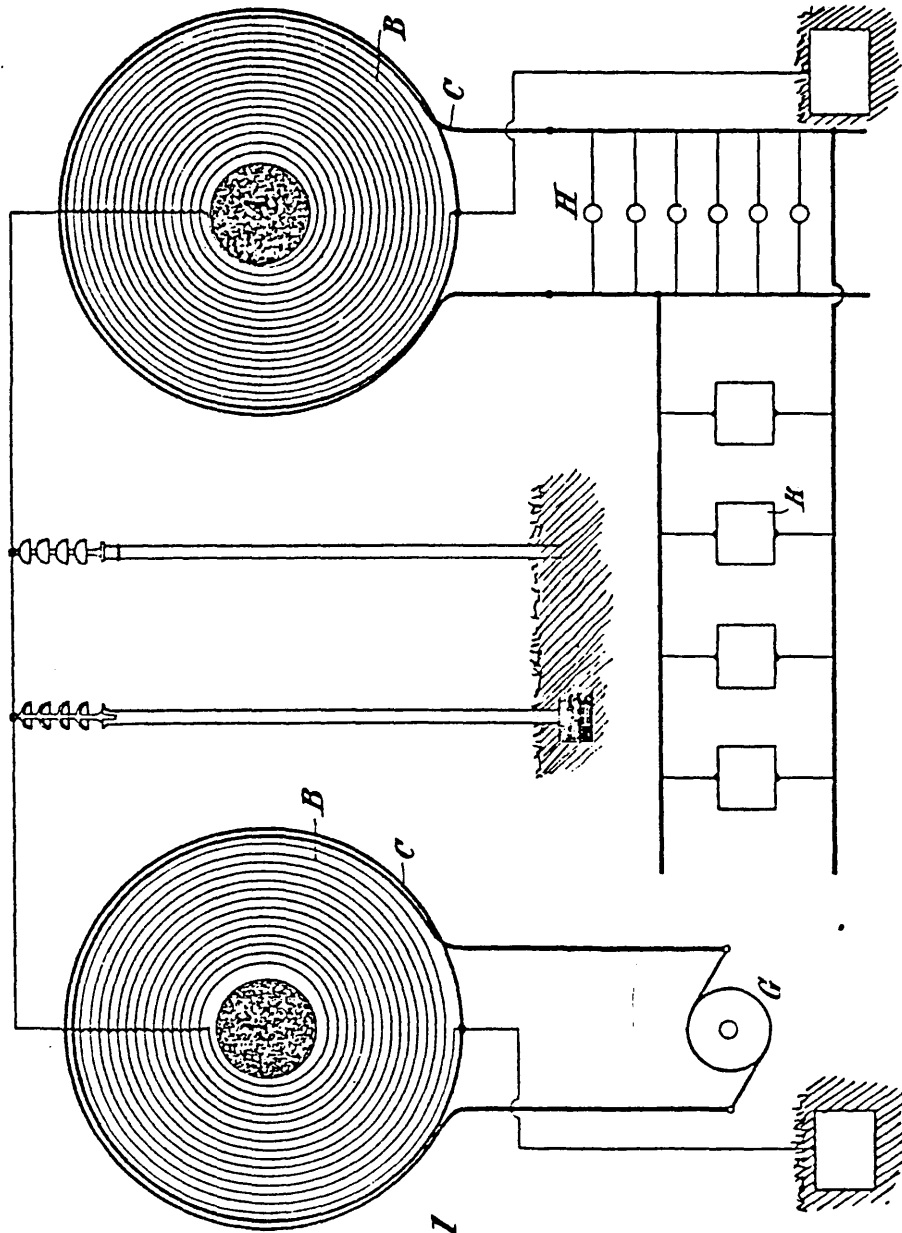

Fig. 1

WITNESSES
G. B. Lewis.
Edwin B. Hopkinson.

INVENTOR
Nikola Tesla
BY
Ken. Curtis Age.
ATTORNEY

(No Model.)

2 Sheets—Sheet 2.

N. TESLA.
ELECTRICAL TRANSFORMER.

No. 593,138.

Patented Nov. 2, 1897.

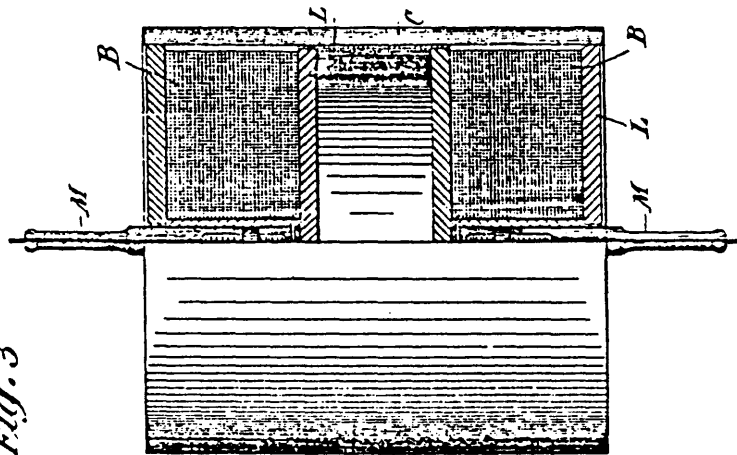

Fig. 3

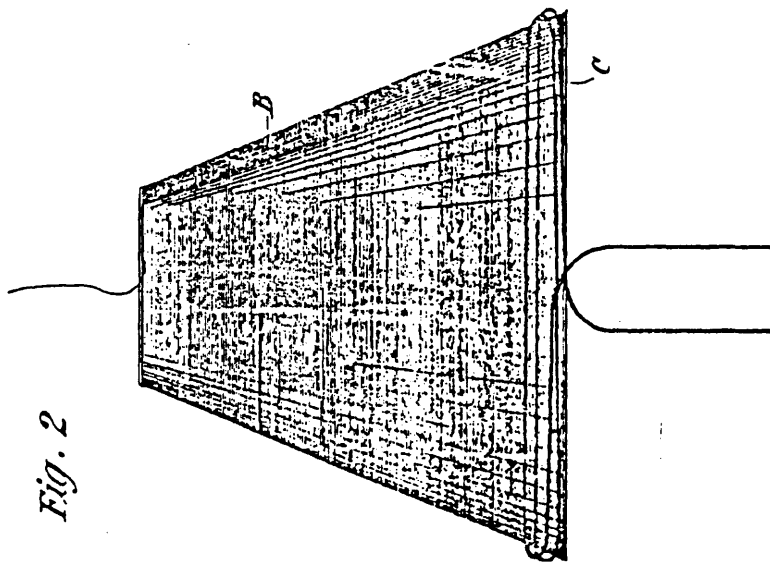

Fig. 2

WITNESSES

G. B. Linnis.

Edwin B. Hopkinson.

INVENTOR

Nikola Tesla

BY

Kerr. Curtis Hage

ATTORNEYS

UNITED STATES PATENT OFFICE.

NIKOLA TESLA, OF NEW YORK, N. Y.

ELECTRICAL TRANSFORMER.

SPECIFICATION forming part of Letters Patent No. 593,138, dated November 2, 1897.

Application filed March 20, 1897. Serial No. 628,453. (No model.)

To all whom it may concern:

Be it known that I, NIKOLA TESLA, a citizen of the United States, residing at New York, in the county and State of New York, have invented certain new and useful Improvements in Electrical Transformers, of which the following is a specification, reference being had to the drawings accompanying and forming a part of the same.

The present application is based upon an apparatus which I have devised and employed for the purpose of developing electrical currents of high potential, which transformers or induction-coils constructed on the principles heretofore followed in the manufacture of such instruments are wholly incapable of producing or practically utilizing, at least without serious liability of the destruction of the apparatus itself and danger to persons approaching or handling it.

The improvement involves a novel form of transformer or induction-coil and a system for the transmission of electrical energy by means of the same in which the energy of the source is raised to a much higher potential for transmission over the line than has ever been practically employed heretofore, and the apparatus is constructed with reference to the production of such a potential and so as to be not only free from the danger of injury from the destruction of insulation, but safe to handle. To this end I construct an induction-coil or transformer in which the primary and secondary coils are wound or arranged in such manner that the convolutions of the conductor of the latter will be farther removed from the primary as the liability of injury from the effects of potential increases, the terminal or point of highest potential being the most remote, and so that between adjacent convolutions there shall be the least possible difference of potential.

The type of coil in which the last-named features are present is the flat spiral, and this form I generally employ, winding the primary on the outside of the secondary and taking off the current from the latter at the center or inner end of the spiral. I may depart from or vary this form, however, in the particulars hereinafter specified.

In constructing my improved transformers I employ a length of secondary which is ap-

proximately one-quarter of the wave length of the electrical disturbance in the circuit including the secondary coil, based on the velocity of propagation of electrical disturbances through such circuit, or, in general, of such length that the potential at the terminal of the secondary which is the more remote from the primary shall be at its maximum. In using these coils I connect one end of the secondary, or that in proximity to the primary, to earth, and in order to more effectually provide against injury to persons or to the apparatus I also connect it with the primary.

In the accompanying drawings, Figure 1 is a diagram illustrating the plan of winding and connection which I employ in constructing my improved coils and the manner of using them for the transmission of energy over long distances. Fig. 2 is a side elevation, and Fig. 3 a side elevation and part section, of modified forms of induction-coil made in accordance with my invention.

A designates a core, which may be magnetic when so desired.

B is the secondary coil, wound upon said core in generally spiral form.

C is the primary, which is wound around in proximity to the secondary. One terminal of the latter will be at the center of the spiral coil, and from this the current is taken to line or for other purposes. The other terminal of the secondary is connected to earth and preferably also to the primary.

When two coils are used in a transmission system in which the currents are raised to a high potential and then reconverted to a lower potential, the receiving-transformer will be constructed and connected in the same manner as the first—that is to say, the inner or center end of what corresponds to the secondary of the first will be connected to line and the other end to earth and to the local circuit or that which corresponds to the primary of the first. In such case also the line-wire should be supported in such manner as to avoid loss by the current jumping from line to objects in its vicinity and in contact with earth—as, for example, by means of long insulators mounted, preferably, on metal poles, so that in case of leakage from the line it will pass harmlessly to earth. In Fig. 1, where such a system is illustrated, a dynamo G is con-

veniently represented as supplying the primary of the sending or "step-up" transformer, and lamps H and motors K are shown as connected with the corresponding circuit 5 of the receiving or "step-down" transformer.

Instead of winding the coils in the form of a flat spiral the secondary may be wound on a support in the shape of a frustum of a cone and the primary wound around its base, as 10 shown in Fig. 2.

In practice for apparatus designed for ordinary usage the coil is preferably constructed on the plan illustrated in Fig. 3. In this figure L L are spools of insulating material upon 15 which the secondary is wound—in the present case, however, in two sections, so as to constitute really two secondaries. The primary C is a spirally-wound flat strip surrounding both secondaries B.

The inner terminals of the secondaries are led out through tubes of insulating material M, while the other or outside terminals are connected with the primary. 20

The length of the secondary coil B or of each secondary coil when two are used, as in 25 Fig. 3, is, as before stated, approximately one-quarter of the wave length of the electrical disturbance in the secondary circuit, based on the velocity of propagation of the electrical disturbance through the coil itself and 30 the circuit with which it is designed to be used—that is to say, if the rate at which a current traverses the circuit, including the coil, be one hundred and eighty-five thousand 35 miles per second, then a frequency of nine hundred and twenty-five per second would maintain nine hundred and twenty-five stationary waves in a circuit one hundred and eighty-five thousand miles long, and each 40 wave length would be two hundred miles in length. For such a frequency I should use a secondary fifty miles in length, so that at one terminal the potential would be zero and at the other maximum.

Coils of the character herein described have 45 several important advantages. As the potential increases with the number of turns the difference of potential between adjacent turns is comparatively small, and hence a very 50 high potential, impracticable with ordinary coils, may be successfully maintained.

As the secondary is electrically connected with the primary the latter will be at substantially the same potential as the adjacent 55 portions of the secondary, so that there will be no tendency for sparks to jump from one to the other and destroy the insulation. Moreover, as both primary and secondary are grounded and the line-terminal of the coil 60 carried and protected to a point remote from the apparatus the danger of a discharge through the body of a person handling or approaching the apparatus is reduced to a minimum.

I am aware that an induction-coil in the 65 form of a flat spiral is not in itself new, and this I do not claim; but

What I claim as my invention is—

1. A transformer for developing or converting 70 currents of high potential, comprising a primary and secondary coil, one terminal of the secondary being electrically connected with the primary; and with earth when the transformer is in use, as set forth.

2. A transformer for developing or converting 75 currents of high potential, comprising a primary and secondary wound in the form of a flat spiral, the end of the secondary adjacent to the primary being electrically connected therewith and with earth when the 80 transformer is in use, as set forth.

3. A transformer for developing or converting 85 currents of high potential comprising a primary and secondary wound in the form of a spiral, the secondary being inside of, and surrounded by, the convolutions of the primary and having its adjacent terminal electrically connected therewith and with earth when the transformer is in use, as set forth.

4. In a system for the conversion and trans- 90 mission of electrical energy, the combination of two transformers, one for raising, the other for lowering, the potential of the currents, the said transformers having one terminal of the longer or fine-wire coils connected to line, 95 and the other terminals adjacent to the shorter coils electrically connected therewith and to the earth, as set forth.

NIKOLA TESLA.

Witnesses:

M. LAWSON DYER,
G. W. MARTLING.

No. 685,953.

Patented Nov. 5, 1901.

N. TESLA.
METHOD OF INTENSIFYING AND UTILIZING EFFECTS TRANSMITTED THROUGH
NATURAL MEDIA.

(Application filed June 24, 1899. Renewed May 20, 1901.)

(No Model.)

Fig. 1.

(G)

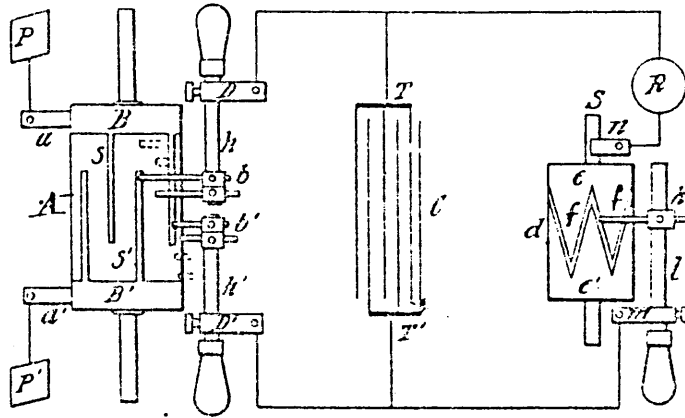
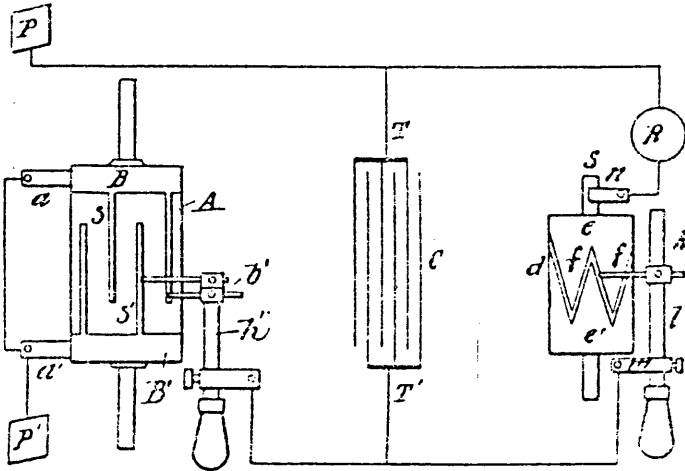

Fig. 2.

(G)



Witnesses:

W. R. Loring
Hellery C. Messimer

Nikola Tesla, Inventor

by *Kerr, Rags & Cosgrove*
Attys

UNITED STATES PATENT OFFICE.

NIKOLA TESLA, OF NEW YORK, N. Y.

METHOD OF INTENSIFYING AND UTILIZING EFFECTS TRANSMITTED THROUGH NATURAL MEDIA.

SPECIFICATION forming part of Letters Patent No. 885,933, dated November 8, 1901.

Application filed June 24, 1899. Renewed May 29, 1901. Serial No. 82,316. (No model.)

To all whom it may concern:

Be it known that I, NIKOLA TESLA, a citizen of the United States, residing at New York, in the county and State of New York, have
5 invented a new and useful Improvement in Methods of Intensifying and Utilizing Effects Transmitted Through the Natural Media, of which the following is a specification, refer-
ence being had to the accompanying draw-
10 ings, which form a part of the same.

The subject of my present invention is an improvement in the art of utilizing effects transmitted from a distance to a receiving device through the natural media; and it consists in a novel method by means of which
15 results hitherto unattainable may be secured.

Several ways or methods of transmitting electrical disturbances through the natural media and utilizing them to operate distant
20 receivers are now known and have been applied with more or less success for accomplishing a variety of useful results. One of these ways consists in producing by a suitable apparatus rays or radiations—that is, distur-
25 ances—which are propagated in straight lines through space, directing them upon a receiving or recording apparatus at a distance, and thereby bringing the latter into action. This method is the oldest and best known and has
30 been brought particularly into prominence in recent years through the investigations of Heinrich Hertz. Another method consists in passing a current through a circuit, preferably one enclosing a very large area, inducing
35 thereby in a similar circuit situated at a distance another current and affecting by the same in any convenient way a receiving device. Still another way, which has also been
40 known for many years, is to pass in any suitable manner a current through a portion of the ground, as by connecting to two points of the same, preferably at a considerable distance from each other, the two terminals of a generator and to energize by a part of the cur-
45 rent diffused through the earth a distant circuit which is similarly arranged and grounded at two points widely apart and which is made to act upon a sensitive receiver. These various methods have their limitations, one
50 especially, which is common to all, being that the receiving circuit or instrument must be maintained in a definite position with respect

to the transmitting apparatus, which often imposes great disadvantages upon the use of the apparatus.

In several applications filed by me and patents granted to me I have disclosed other methods of accomplishing results of this nature, which may be briefly described as follows: In one system the potential of a point
55 or region of the earth is varied by imparting to it intermittent or alternating electrifications through one of the terminals of a suitable source of electrical disturbances which, to heighten the effect, has its other terminal
60 connected to an insulated body, preferably of large surface and at an elevation. The electrifications communicated to the earth spread in all directions through the same, reaching a distant circuit which generally
65 has its terminals arranged and connected similarly to those of the transmitting source and operates upon a highly-sensitive receiver. Another method is based upon the fact that the atmospheric air which behaves as an ex-
70 cellent insulator to currents generated by ordinary apparatus becomes a conductor under the influence of currents or impulses of enormously-high electromotive force which I have
75 devised means for generating. By such means air strata, which are easily accessible, are rendered available for the production of many desired effects at distances, however great. This method, furthermore, allows ad-
80 vantage to be taken of many of those improvements which are practicable in the ordinary systems of transmission involving the use of a metallic conductor.

Obviously whatever method be employed it is desirable that the disturbances produced
85 by the transmitting apparatus should be as powerful as possible, and by the use of certain forms of high-frequency apparatus which I have devised and which are now well known important practical advantages are in this re-
90 spect secured. Furthermore, since in most cases the amount of energy conveyed to the distant circuit is but a minute fraction of the total energy emanating from the source it is
95 necessary for the attainment of the best results that whatever the character of the re-
100 ceiver and the nature of the disturbances as much as possible of the energy conveyed should be made available for the operation

of the receiver, and with this object in view I have heretofore among other means employed a receiving-circuit of high self-induction and very small resistance and of a period such as to vibrate in synchronism with the disturbances, whereby a number of separate impulses from the source were made to cooperate, thus magnifying the effect exerted upon and insuring the action of the receiving device. By these means decided advantages have been secured in many instances; but very often the improvement is either not applicable at all or, if so, the gain is very slight. Evidently when the source is one producing a continuous pressure or delivering impulses of long duration it is impracticable to magnify the effects in this manner and when, on the other hand, it is one furnishing short impulses of extreme rapidity of succession the advantage obtained in this way is insignificant, owing to the radiation and the unavoidable frictional waste in the receiving-circuit. These losses reduce greatly both the intensity and the number of the cooperative impulses, and since the initial intensity of each of these is necessarily limited only an insignificant amount of energy is thus made available for a single operation of the receiver. As this amount is consequently dependent on the energy conveyed to the receiver by one single impulse it is evidently necessary to employ either a very large and costly, and therefore objectionable, transmitter or else to resort to the equally objectionable use of a receiving device too delicate and too easily deranged. Furthermore, the energy obtained through the cooperation of the impulses is in the form of extremely rapid vibrations and, because of this, unsuitable for the operation of ordinary receivers, the more so as this form of energy imposes narrow restrictions in regard to the mode and time of its application to such devices.

To overcome these and other limitations and disadvantages which have heretofore existed in such systems of transmission of signals or intelligence is the main object of my present invention, which comprises a novel method of accomplishing these ends.

The method, briefly stated, consists in producing arbitrarily-varied or intermittent disturbances or effects, transmitting such disturbances or effects through the natural media to a distant receiving-station, utilizing energy derived from such disturbances or effects at the receiving-station to charge a condenser, and using the accumulated potential energy so obtained to operate a receiving device.

An apparatus by means of which this method may be practiced is illustrated in the drawings hereto annexed, in which—

Figure 1 is a diagrammatic illustration of the apparatus, and Fig. 2 is a modified form or arrangement of the same.

In the practical application of my method I usually proceed as follows: At any two

points in the transmitting medium between which there exists or may be obtained in any manner through the action of the disturbances or effects to be investigated or utilized a difference of electrical potential of any magnitude I arrange two plates or electrodes so that they may be oppositely charged through the agency of such effects or disturbances, and I connect these electrodes to the terminals of a highly-insulated condenser, generally of considerable capacity. To the condenser-terminals I also connect the receiver to be operated in series with a device of suitable construction, which performs the function of periodically discharging the condenser through the receiver at and during such intervals of time as may be best suitable for the purpose contemplated. This device may merely consist of two stationary electrodes separated by a feeble dielectric layer of minute thickness or it may comprise terminals one or more of which are movable and actuated by any suitable force and are adapted to be brought into and out of contact with each other in any convenient manner. It will now be readily seen that if the disturbances of whatever nature they may be cause definite amounts of electricity of the same sign to be conveyed to each of the plates or electrodes above mentioned, either continuously or at intervals of time which are sufficiently long, the condenser will be charged to a certain potential, and an adequate amount of energy being thus stored during the time determined by the device effecting the discharge of the condenser the receiver will be periodically operated by the electrical energy so accumulated; but very often the character of the impulses and the conditions of their use are such that without further provision not enough potential energy would be accumulated in the condenser to operate the receiving device. This is the case when, for example, each of the plates or terminals receives electricity of rapidly-changing sign or even when each receives electricity of the same sign, but only during periods which are short as compared with the intervals separating them. In such instances I resort to the use of a special device which I insert in the circuit between the plates and the condenser for the purpose of conveying to each of the terminals of the latter electrical charges of the proper quality and order of succession to enable the required amount of potential energy to be stored in the condenser.

There are a number of well-known devices, either without any moving parts or terminals or with elements reciprocated or rotated by the application of a suitable force, which offer a more ready passage to impulses of one sign or direction than to those of the other, or permit only impulses of one kind or order of succession to traverse a path, and any of these or similar devices capable of fulfilling the requirements may be used in carrying my invention into practice. One such device of

familiar construction which will serve to convey a clear understanding of this part of my invention and enable a person skilled in the art to apply the same is illustrated in the annexed drawings. It consists of a cylinder A of insulating material, which is moved at a uniform rate of speed by clockwork or other suitable motive power and is provided with two metal rings B B', upon which bear brushes a and a', which are connected, respectively, in the manner shown to the terminal plates P and P', above referred to. From the rings B B' extend narrow metallic segments s and s', which by the rotation of the cylinder A are brought alternately into contact with double brushes b and b', carried by and in contact with conducting-holders h and h', which are adjustable longitudinally in the metallic supports D and D', as shown. The latter are connected to the terminals T and T' of a condenser C, and it should be understood that they are capable of angular displacement, as ordinary brush-supports. The object of using two brushes, as b and b', in each of the holders h and h' is to vary as will the duration of the electric contact of the plates P and P' with the terminals T and T', to which is connected a receiving-circuit including a receiver R and a device d of the kind above referred to, which performs the duty of closing the receiving-circuit at predetermined intervals of time and discharging the stored energy through the receiver. In the present case this device consists of a cylinder d, made partly of conducting and partly of insulating material e and e', respectively, which is rotated at the desired rate of speed by any suitable means. The conducting part e is in good electrical connection with the shaft S and is provided with tapering segments ff, upon which slides a brush k, supported on a conducting-rod l, capable of longitudinal adjustment in a metallic support m. Another brush n is arranged to bear upon the shaft S, and it will be seen that whenever one of the segments f comes in contact with the brush k the circuit, including the receiver R, is completed and the condenser discharged through the same. By an adjustment of the speed of rotation of the cylinder d and a displacement of the brush k along the cylinder the circuit may be made to open and close in as rapid succession and remain open or closed during such intervals of time as may be desired. The plates P and P', through which the electrifications are conveyed to the brushes a and a', may be at a considerable distance from each other and both in the ground or both in the air, or one in the ground and the other in the air, preferably at some height, or they may be connected to conductors extending to some distance or to the terminals of any kind of apparatus supplying electrical energy which is obtained from the energy of the impulses or disturbances transmitted from a distance through the natural media.

In illustration of the operation of the devices described let it be assumed that alternating electrical impulses from a distant generator, as G, are transmitted through the earth and that it is desired to utilize those impulses in accordance with my method. This may be the case, for example, when such a generator is used for purposes of signaling in one of the ways before enumerated, as by having its terminals connected to two points of the earth distant from each other. In this case the plates P and P' are first connected to two properly-selected points of the earth. The speed of rotation of the cylinder A is varied until it is made to turn in synchronism with the alternate impulses of the generator, and, finally, the position of the brushes b and b' is adjusted by angular displacement, as usual, or in other ways, so that they are in contact with the segments s and s' during the periods when the impulses are at or near the maximum of their intensity. Only ordinary electrical skill and knowledge are required to make these adjustments, and a number of devices for effecting synchronous movement being well known, and it being the chief object of my present application to set forth a novel method of utilizing or applying a principle, a detailed description of such devices is not considered necessary. I may state, however, that for practical purposes in the present case it is only necessary to shift the brushes forward or back until the maximum effect is secured. The above requirements being fulfilled, electrical charges of the same sign will be conveyed to each of the condenser-terminals as the cylinder A is rotated, and with each fresh impulse the condenser will be charged to a higher potential. The speed of rotation of the cylinder d being adjustable at will, the energy of any number of separate impulses may thus be accumulated in potential form and discharged through the receiver R upon the brush k coming in contact with one of the segments f. It will be of course understood that the capacity of the condenser should be such as to allow the storing of a much greater amount of energy than is required for the ordinary operation of the receiver. Since by this method a relatively great amount of energy and in a suitable form may be made available for the operation of a receiver, the latter need not be very sensitive; but of course when the impulses are very feeble, as when coming from a great distance or when it is desired to operate a receiver very rapidly, then any of the well-known devices capable of responding to very feeble influences may be used in this connection.

If instead of the alternating impulses short impulses of the same direction are conveyed to the plates P and P', the apparatus described may still readily be used, and for this purpose it is merely necessary to shift the brushes b and b' into the position indicated by the dotted lines while maintaining the

same conditions in regard to synchronism as before, so that the succeeding impulses will be permitted to pass into the condenser, but prevented from returning to the ground or transmitting medium during the intervals between them, owing to the interruption during such intervals of the connections leading from the condenser-terminals to the plates.

Another way of using the apparatus with impulses of the same direction is to take off one pair of brushes, as *b*, disconnect the plate *P* from brush *a* and join it directly to the terminal *T* of the condenser, and to connect brush *a* with brush *a'*. The apparatus thus modified would appear as shown in Fig. 2. Operated in this manner and assuming the speed of rotation of cylinder *A* to be the same, the apparatus will now be evidently adapted for a number of impulses per unit of time twice as great as in the preceding case. In all cases it is evidently important to adjust the duration of contact of segments *s* and *s'* with brushes *b* *b'* in the manner indicated.

When the method and apparatus I have described are used in connection with the transmission of signals or intelligence, it will of course be understood that the transmitter is operated in such a way as to produce disturbances or effects which are varied or intermitted in some arbitrary manner—for example, to produce longer and shorter successions of impulses corresponding to the dashes and dots of the Morse alphabet—and the receiving device will respond to and indicate these variations or intermittences, since the storage device will be charged and discharged a number of times corresponding to the duration of the successions of impulses received.

Obviously the special appliances used in carrying out my invention may be varied in many ways without departing from the spirit of the same.

It is to be observed that it is the function of the cylinder *A*, with its brushes and connections, to render the electrical impulses coming from the plates *P* and *P'* suitable for charging the condenser (assuming them to be unsuitable for this purpose in the form in which they are received) by rectifying them when they are originally alternating in direction or by selecting such parts of them as are suitable when all are not, and any other device performing this function will obviously answer the purpose. It is also evident that a device such as I have already referred to which offers a more ready passage to impulses of one sign or permits only impulses of the same sign to pass may also be used to perform this selective function in many cases when alternating impulses are received. When the impulses are long and all of the same direction, and even when they are alternating, but sufficiently long in duration and sustained in electromotive force, the brushes *b* and *b'* may be adjusted so as to bear on the parts *B* *B'* of the cylinder *A*, or the cylinder and its brushes may be omitted

and the terminals of the condenser connected directly to the plates *P* and *P'*.

It will be seen that by the use of my invention results hitherto unattainable in utilizing disturbances or effects transmitted through natural media may be readily attained, since however great the distance of such transmission and however feeble or attenuated the impulses received enough energy may be accumulated from them by storing up the energy of succeeding impulses for a sufficient interval of time to render the sudden liberation of it highly effective in operating a receiver. In this way receivers of a variety of forms may be made to respond effectively to impulses too feeble to be detected or to be made to produce any sensible effect in any other way of which I am aware, a result of great value in various applications to practical use.

I do not claim herein an apparatus by means of which the above-described method is or may be practiced either in the special form herein shown or in other forms which are possible, having made claims to such apparatus in another application, Serial No. 729,812, filed September 8, 1899, as a division of the present case.

What I claim as my invention, and desire to secure by Letters Patent, is—

1. The method of transmitting and utilizing electrical energy herein described, which consists in producing arbitrarily varied or intermitted electrical disturbances or effects, transmitting the same to a distant receiving-station, charging, for succeeding and predetermined periods of time a condenser with energy derived from such effects or disturbances, and operating a receiving device by discharging at arbitrary intervals, the accumulated potential energy so obtained, as set forth.

2. The method of transmitting and utilizing electrical energy herein described, which consists in producing electrical disturbances or effects capable of being transmitted to a distance through the natural media, charging a condenser at a distant receiving-station with energy derived from such effects or disturbances, and using for periods of time, predetermined as to succession and duration, the potential energy so obtained to operate a receiving device.

3. The method of transmitting and utilizing electrical energy herein described, which consists in producing electrical disturbances or effects capable of being transmitted to a distance through the natural media, charging a condenser at a distant receiving-station for succeeding and predetermined periods of time, with energy derived from such effects or disturbances, and using for periods of time predetermined as to succession and duration, the accumulated energy so obtained to operate a receiving device.

4. The method hereinbefore described of producing arbitrarily varied or intermitted

electrical disturbances or effects, transmitting such disturbances or effects through the natural media to a distant receiving-station, storing in a condenser energy derived
 5 from a succession of such disturbances or effects for periods of time which correspond in succession to such effects or disturbances and are predetermined as to duration, and using the accumulated potential energy so obtained
 10 to operate a receiving device.

5. The method herein described of producing arbitrarily varied or intermitted electrical disturbances or effects, transmitting such disturbances or effects through the natural
 15 media to a distant receiving-station, establishing thereby a flow of electrical energy in a circuit at such station, charging a condenser with energy from such circuit, and using the accumulated potential energy so
 20 obtained to operate a receiving device.

6. The method herein described of producing arbitrarily varied or intermitted electrical disturbances or effects, transmitting such disturbances or effects through the natural
 25 media to a distant receiving-station, establishing thereby a flow of electrical energy in a circuit at such station, charging a condenser with electrical energy from such circuit, and discharging the accumulated potential energy so obtained into or through a receiving device at arbitrary intervals of time.

7. The method herein described of producing arbitrarily varied or intermitted electrical disturbances or effects, transmitting such disturbances or effects to a distant receiving-station, establishing thereby a flow of electrical energy in a circuit at such station, selecting or directing the impulses in said circuit so as to render them suitable for charging a condenser, charging a condenser with the impulses so selected or directed, and discharging the accumulated potential energy so obtained into, or through a receiving device.

8. The method herein described of producing arbitrarily varied or intermitted electrical disturbances or effects, transmitting such disturbances or effects through the natural media to a distant receiving-station, establishing thereby a flow of electrical energy in

a circuit at such station, selecting or directing the impulses in said circuit so as to render them suitable for charging a condenser, charging a condenser with the impulses so selected or directed, and discharging the accumulated potential energy so obtained into, or through a receiving device at arbitrary intervals of time.

9. The method hereinbefore described of transmitting signals or intelligence, which consists in producing at the sending-station arbitrarily varied or intermitted disturbances or effects, transmitting such disturbances or effects through the natural media to a receiving-station, utilizing energy derived from such disturbances or effects at the receiving-station to charge a condenser and using the accumulated potential energy so obtained to operate a receiving device.

10. The method hereinbefore described of transmitting signals or intelligence through the natural media from a sending-station to a receiving-station, which consists in producing at the sending-station, arbitrarily varied or intermitted electrical effects or disturbances, transmitting the same through the natural media to the receiving-station, utilizing the energy derived from such disturbances or effects at the receiving-station to charge a condenser, and discharging the accumulated potential energy so obtained through a receiving device at arbitrary intervals of time.

11. The method hereinbefore described of transmitting signals or intelligence from a sending to a distant receiving station, which consists in producing at the former, arbitrarily varied or intermitted electrical disturbances or effects, transmitting the same to the receiving-station, charging by the energy derived from such disturbances or effects at the receiving-station a condenser, and using for periods of time predetermined as to succession and duration, the potential energy so obtained to operate a receiving device, as set forth.

NIKOLA TESLA.

Witnesses:
 LEONARD E. CURTIS,
 A. E. SKINNER.

No. 635,955.

Patented Nov. 5, 1901.

N. TESLA.

APPARATUS FOR UTILIZING EFFECTS TRANSMITTED FROM A DISTANCE TO A RECEIVING DEVICE THROUGH NATURAL MEDIA.

(Application filed Sept. 8, 1900. Renewed May 29, 1901.)

(No Model.)

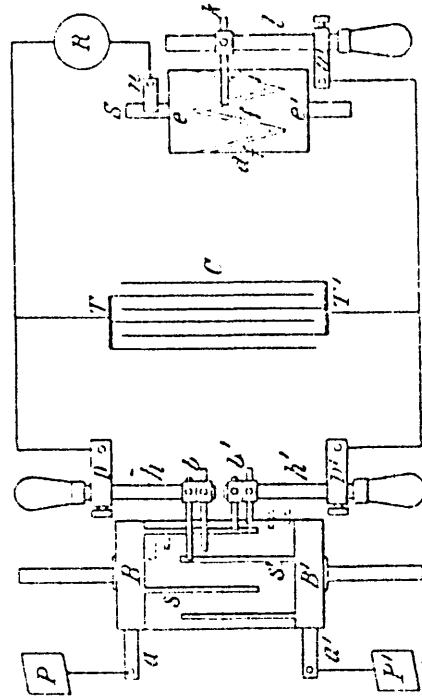

Fig. 1

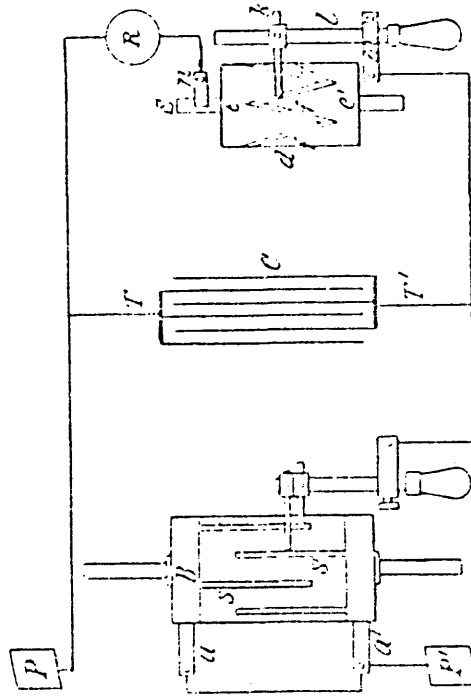

Fig. 2

(B)

(B)

Witnesses:
J. B. Linn
Henry O. McQuinn

Nikola Tesla, Inventor
by Ken. Page & Co. Att'ys

UNITED STATES PATENT OFFICE.

NIKOLA TESLA, OF NEW YORK, N.Y.

APPARATUS FOR UTILIZING EFFECTS TRANSMITTED FROM A DISTANCE TO A RECEIVING DEVICE THROUGH NATURAL MEDIA.

SPECIFICATION forming part of Letters Patent No. 685,955, dated November 5, 1901.

Application filed June 24, 1899, Serial No. 721,790, Divided and this application filed September 8, 1899, Renewed May 29, 1901, Serial No. 62,317 (No model)

To all whom it may concern:

Be it known that I, NIKOLA TESLA, a citizen of the United States, residing at the borough of Manhattan, in the city, county, and State of New York, have invented certain new and useful Improvements in Apparatus for Utilizing Effects Transmitted from a Distance to a Receiving Device Through the Natural Media, of which the following is a specification, reference being had to the accompanying drawings, which form a part of the same.

This application is a division of an application filed by me June 24, 1899, Serial No. 721,790, in which a method of utilizing effects or disturbances transmitted through the natural media from a distant source is described and made the subject of the claims. The invention of my present application consists in the apparatus hereinafter described and claimed, by the use of which the method claimed in my said prior application may be practiced and by means of which results hitherto unattainable may be secured.

Several ways or methods of transmitting electrical disturbances through the natural media and utilizing them to operate distant receivers are now known and have been applied with more or less success for accomplishing a variety of useful results. One of these ways consists in producing by a suitable apparatus rays or radiations -- that is, disturbances -- which are propagated in straight lines through space, directing them upon a receiving or recording apparatus at a distance, and thereby bringing the latter into action. This method is the oldest and best known, and has been brought particularly into prominence in recent years through the investigations of Heinrich Hertz. Another method consists in passing a current through a circuit, preferably one inclosing a very large area, inducing thereby in a similar circuit, situated at a distance, another current and affecting by the same in any convenient way a receiving device. Still another way, which has also been known for many years, is to pass in any suitable manner a current through a portion of the ground, as by connecting to two points of the same, preferably at a considerable dis-

tance from each other, the two terminals of a generator and to energize by a part of the current diffused through the earth a distant circuit, which is similarly arranged and grounded at two points widely apart and which is made to act upon a sensitive receiver. These various methods have their limitations, one, especially, which is common to all, being that the receiving circuit or instrument must be maintained in a definite position with respect to the transmitting apparatus, which often imposes great disadvantages upon the use of the apparatus.

In several applications filed by me and patents granted to me I have disclosed other methods of accomplishing results of this nature, which may be briefly described as follows: In one system the potential of a point or region of the earth is varied by imparting to it intermittent or alternating electrifications through one of the terminals of a suitable source of electrical disturbances, which to heighten the effect has its other terminal connected to an insulated body, preferably of large surface and at an elevation. The electrifications communicated to the earth spread in all directions through the same, reaching a distant circuit, which generally has its terminals arranged and connected similarly to those of the transmitting source, and operates upon a highly-sensitive receiver. Another method is based upon the fact that the atmospheric air, which behaves as an excellent insulator to currents generated by ordinary apparatus, becomes a conductor under the influence of currents of impulses of enormously high electromotive force which I have devised means for generating, by such means air strata, which are easily accessible, are rendered available for the production of many desired effects at distances, however great. This method, furthermore allows advantage to be taken of many of those improvements which are practicable in the ordinary systems of transmission involving the use of a metallic conductor.

Obviously whatever method be employed it is desirable that the disturbances produced by the transmitting apparatus should be as

powerful as possible, and by the use of certain forms of high-frequency apparatus which I have devised and which are now well known important practical advantages are in this respect secured. Furthermore, since in most cases the amount of energy conveyed to the distant circuit is but a minute fraction of the total energy emanating from the source, it is necessary for the attainment of the best results that whatever the character of the receiver and the nature of the disturbances as much as possible of the energy conveyed should be made available for the operation of the receiver, and with this object in view I have heretofore, among other means, employed a receiving-circuit of high self-induction and very small resistance and of a period such as to vibrate in synchronism with the disturbances, whereby a number of separate impulses from the source were made to cooperate, thus magnifying the effect exerted upon and insuring the action of the receiving device. By these means decided advantages have been secured in many instances; but very often the improvement is either not applicable at all or if so the gain is very slight. Evidently when the source is one producing a continuous pressure or delivering impulses of long duration it is impracticable to magnify the effects in this manner, and when, on the other hand, it is one furnishing short impulses of extreme rapidity of succession the advantage obtained in this way is insignificant, owing to the radiation and the unavoidable frictional waste in the receiving-circuit. These losses reduce greatly both the intensity and the number of the cooperative impulses, and since the initial intensity of each of these is necessarily limited only an insignificant amount of energy is thus made available for a single operation of the receiver. As this amount is consequently dependent on the energy conveyed to the receiver by one single impulse, it is evidently necessary to employ either a very large and costly, and therefore objectionable transmitter, or else resort to the equally objectionable use of a receiving device too delicate and too easily deranged. Furthermore, the energy obtained through the cooperation of the impulses is in the form of extremely-rapid vibrations and because of this unsuitable for the operation of ordinary receivers, the more so as this form of energy imposes narrow restrictions in regard to the mode and time of its application to such devices. To overcome these and other limitations and disadvantages which have heretofore existed in such systems of transmission of signals or intelligence is the object of my invention, which comprises a novel form of apparatus for accomplishing these results.

The apparatus which is employed at the receiving-station, described in general terms, consists in the combination of a storage device included in a circuit connecting points at a distance from the source of the disturbances and between which a difference of potential is

created by such disturbances, a receiving-circuit connected with the storage device, a receiver included in such receiving-circuit, and means for closing the receiving-circuit at any desired moment, and thereby causing the receiver to be operated by the energy with which the storage device has been charged.

The best form of apparatus for carrying out my invention of which I am now aware and the manner of using the same will be understood from the following description and the accompanying drawings, in which —

Figure 1 is a diagrammatic illustration of such apparatus, and Fig. 2 a modified form or arrangement of the same.

At any two points in the transmitting medium between which there exists or may be obtained in any manner through the action of the disturbances or effects to be investigated or utilized a difference of electrical potential of any magnitude I arrange two plates or electrodes so that they may be oppositely charged through the agency of such effects or disturbances, and I connect these electrodes to the terminals of a highly-insulated condenser, generally of considerable capacity. To the condenser-terminals I also connect the receiver to be operated in series with a device of suitable construction which performs the function of periodically discharging the condenser through the receiver at and during such intervals of time as may be best suitable for the purpose contemplated. This device may merely consist of two stationary electrodes separated by a feeble dielectric layer of minute thickness, or it may comprise terminals one or more of which are movable and actuated by any suitable force and are adapted to be brought into and out of contact with each other in any convenient manner. It will now be readily seen that if the disturbances, of whatever nature they may be, cause definite amounts of electricity of the same sign to be conveyed to each of the plates or electrodes above mentioned either continuously or at intervals of time which are sufficiently long the condenser will be charged to a certain potential and an adequate amount of energy being thus stored during the time determined by the device effecting the discharge of the condenser the receiver will be periodically operated by the electrical energy so accumulated; but very often the character of the impulses and the conditions of their use are such that without further provision not enough potential energy would be accumulated in the condenser to operate the receiving device. This is the case when, for example, each of the plates or terminals receives electricity of rapidly-changing sign or even when each receives electricity of the same sign, but only during periods of which are short as compared with the intervals separating them. In such instances I resort to the use of a special device which I insert in the circuit between the plates and the condenser for the purpose of conveying to each of the terminals of the latter elec-

trical charges of the proper quality and order of succession to enable the required amount of potential energy to be stored in the condenser.

5 There are a number of well-known devices, either without any moving parts or terminals or with elements reciprocated or rotated by the application of a suitable force, which offer a more ready passage to impulses of one sign
10 or direction than to those of the other or permit only impulses of one kind or order of succession to traverse a path, and any of these or similar devices capable of fulfilling the requirements may be used in carrying my
15 invention into practice. One such device of familiar construction which will serve to convey a clear understanding of this part of my invention and enable a person skilled in the art to apply the same is illustrated in the annexed drawings. It consists of a cylinder A, of
20 insulating material, which is moved at a uniform rate of speed by clockwork or other suitable motive power and is provided with two metal rings B B', upon which bear brushes *a* and *a'*, which are connected, respectively, in
25 the manner shown to the terminal plates P and P', above referred to. From the rings B B' extend narrow metallic segments *s* and *s'*, which by the rotation of the cylinder A are brought alternately into contact with double
30 brushes *b* and *b'*, carried by and in contact with conducting-holders *h* and *h'*, which are adjustable longitudinally in the metallic supports D and D', as shown. The latter are connected to the terminals T and T' of a condenser C, and it should be understood that they are capable of angular displacement as ordinary brush-supports. The object of using
35 two brushes, as *b* and *b'*, in each of the holders *h* and *h'* is to vary at will the duration of the electric contact of the plates P and P' with the terminals T and T', to which is connected a receiving-circuit, including a receiver R and a device *d* of the kind above referred to, which
40 performs the duty of closing the receiving-circuit at predetermined intervals of time and discharging the stored energy through the receiver. In the present case this device consists of a cylinder made partly of conducting
45 and partly of insulating material *e* and *e'*, respectively, which is rotated at the desired rate of speed by any suitable means. The conducting part *e* is in good electrical connection with the shaft S and is provided with tapering
50 segments *f f*, upon which slides a brush *k*, supported on a conducting-rod *l*, capable of longitudinal adjustment in a metallic support *m*. Another brush *n* is arranged to bear upon the shaft S, and it will be seen that whenever
55 one of the segments *f* comes in contact with the brush *k* the circuit including the receiver R is completed and the condenser discharged through the same. By an adjustment of the speed of rotation of the cylinder *d* and a displacement of the brush *k* along the cylinder the circuit may be made to open and close in
60 as rapid succession and remain open or closed

during such intervals of time as may be desired. The plates P and P' through which the electrifications are conveyed to the brushes
70 *a* and *a'* may be at a considerable distance from each other and both in the ground or both in the air or one in the ground and the other in the air, preferably at some height, or they may be connected to conductors extending to some distance or to the terminals of any kind of apparatus supplying electrical energy which is obtained from the energy of the impulses or disturbances transmitted from a distance through the natural media.
80

In illustration of the operation of the devices described let it be assumed that alternating electrical impulses from a distant generator, as G, are transmitted through the earth and that it is desired to utilize these impulses in accordance with my method. This may be the case, for example, when such a generator is used for purposes of signaling in one of the ways before enumerated, as by having its terminals connected at two points of the earth
85 distant from each other. In this case the plates P and P' are first connected to two properly-selected points of the earth, the speed of rotation of the cylinder A is varied until it is made to turn in synchronism with the alternate
90 impulses of the generator, and, finally, the position of the brushes *b* and *b'* is adjusted by angular displacement, as usual, or in other ways, so that they are in contact with the segments *s* and *s'* during the periods when the
95 impulses are at or near the maximum of their intensity. Only ordinary electrical skill and knowledge are required to make these adjustments, and a number of devices for effecting synchronous movement being well known
100 and it being the chief object of my present application to set forth a novel apparatus embodying a general principle a detailed description of such devices is not considered necessary. I may state, however, that for practical purposes in the present case it is only
105 necessary to shift the brushes back and forth until the maximum effect is secured. The above requirements being fulfilled, electrical charges of the same sign will be conveyed to
110 each of the condenser-terminals as the cylinder A is rotated, and with each fresh impulse the condenser will be charged to a higher potential. The speed of rotation of the cylinder *d* being adjustable at will, the energy of any
115 number of separate impulses may thus be accumulated in potential form and discharged through the receiver R upon the brush *k* coming in contact with one of the segments *f*. It will be of course understood that the
120 capacity of the condenser should be such as to allow the storing of a much greater amount of energy than is required for the ordinary operation of the receiver. Since by this method a relatively great amount of energy and in a
125 suitable form may be made available for the operation of a receiver, the latter need not be very sensitive but of course then the impulses are very feeble, as when coming from a great

distance or when it is desired to operate a receiver very rapidly, than any of the well-known devices capable of responding to very feeble influences may be used in this connection.

If instead of the alternating impulses short impulses of the same direction are conveyed to the plates P and P', the apparatus described may still readily be used, and for this purpose it is merely necessary to shift the brush *b* and *b'* into the position indicated by the dotted lines, while maintaining the same conditions in regard to synchronism as before, so that the succeeding impulses will be permitted to pass into the condenser, but prevented from returning to the ground or transmitting medium during the intervals between them, owing to the interruption during such intervals of the connections leading from the condenser-terminals to the plates.

Another way of using the apparatus with impulses of the same direction is the take off one pair of brushes, as *b*, disconnect the plate P from brush *a* and join it directly to the terminal T of the condenser, and to connect brush *a* with brush *a'*. When thus modified, the apparatus appears as shown in Fig. 2. Operated in this manner and assuming the speed of rotation of cylinder A to be the same, the apparatus will now be evidently adapted for a number of impulses per unit of time twice as great as in the preceding case. In all cases it is evidently important to adjust the duration of contact of segments *s* and *s'* with brushes *b b'* in the manner indicated.

When the apparatus I have described is used in connection with the transmission of signals or intelligence, it will of course be understood that the transmitter is operated in such a way as to produce disturbances or effects which are varied or intermitted in some arbitrary manner — for example, to produce longer and shorter successions of impulses, corresponding to the dashes and dots of the Morse alphabet — and the receiving device will respond to and indicate these variations or intermittences, since the storage device will be charged and discharged a number of times corresponding to the duration of the successions of impulses received.

Obviously the special appliances used in carrying out my invention may be varied in many ways without departing from the spirit of the same.

It is to be observed that it is the function of the cylinder A, with its brushes and connections to render the electrical impulses coming from the plates P and P' suitable for charging the condenser (assuming them to be unsuitable for this purpose in the form in which they are received) by rectifying them when they are originally alternating in direction or by selecting such parts of them as are suitable when all are not, and any other device performing this function will obviously answer the purpose. It is also evident that a device such as I have already referred to which offers

a more ready passage to impulses of one sign or permits only impulses of the same sign to pass may also be used to perform this selective function in many cases when alternating impulses are received. When the impulses are long and all of the same direction, and even when they are alternating but sufficiently long in duration and sustained in electromotive force, the brushes *b* and *b'* may be adjusted so as to bear on the parts B B' of the cylinder A, or the cylinder and its brushes may be omitted and the terminals of the condenser connected directly to the plates P and P'.

It will be seen that by the use of my invention results hitherto unattainable in utilizing disturbances or effects transmitted through natural media may be readily attained, since however great the distance of such transmission and however feeble or attenuated the impulses received enough energy may be accumulated from them by storing up the energy of succeeding impulses for a sufficient interval of time to render the sudden liberation of it highly effective in operating a receiver. In this way receivers of a variety of forms may be made to respond effectively to impulses too feeble to be detected or to be made to produce any sensible effect in any other way of which I am aware—a result of great value in scientific research as well as in various applications to practical use.

What I claim as my invention, and desire to secure by Letters Patent, is—

1. In an apparatus for utilizing electrical effects or disturbances transmitted through the natural media, the combination with a source of such effects or disturbances of a charging-circuit adapted to be energized by the action of such effects or disturbances, a storage device included in the charging-circuit and adapted to be charged thereby, a receiver, and means for causing the receiver to be operated by the energy accumulated in the storage device at arbitrary intervals of time, substantially as described.

2. In an apparatus for utilizing electrical effects or disturbances transmitted through the natural media, the combination with a source of such effects or disturbances of a charging-circuit adapted to be energized by the action of such effects or disturbances, a storage device included in the charging-circuit and adapted to be charged thereby, means for commutating directing or selecting the current impulses in the charging-circuit, a receiving-circuit, and means for discharging the storage device through the receiving-circuit, substantially as described.

3. In an apparatus for utilizing electrical effects or disturbances transmitted through the natural media, the combination with a source of such effects or disturbances of a charging-circuit adapted to be energized by the action of such effects or disturbances, a condenser included in the charging-circuit and adapted to be charged thereby, means for commutating, directing or selecting the current impulses

in the charging-circuit, a receiving-circuit, and means for discharging the condenser through the receiving-circuit, substantially as described.

5 4. In an apparatus for utilizing electrical effects or disturbances transmitted through the natural media, the combination with a source of such effects or disturbances of a charging-circuit adapted to be energized by the action
10 of such effects or disturbances, a storage device included in the charging-circuit and adapted to be charged thereby, means for commutating, directing or selecting the current impulses in the charging-circuit so as to
15 render them suitable for charging the storage device, a receiving-circuit, and means for discharging the storage device through the receiving-circuit, substantially as described.

20 5. In an apparatus for utilizing electrical effects or disturbances transmitted through the natural media, the combination with a source of such effects or disturbances of an charging-circuit adapted to be energized by the action of such effects or disturbances, a condenser
25 included in the charging-circuit and adapted to be charged thereby, means for commutating, directing or selecting the current impulses in the charging-circuit so as to render them suitable for charging the condenser, a
30 receiving-circuit, and means for discharging the condenser through the receiving-circuit, substantially as described.

35 6. In an apparatus for utilizing electrical effects or disturbances transmitted through the natural media, the combination with a source of such effects or disturbances of a charging-circuit adapted to be energized by the action of such effects or disturbances, a storage device
40 included in the charging-circuit and adapted to be charged thereby, means for commutating, directing or selecting the current impulses in the charging-circuit so as to render them suitable for charging the storage device, a receiving-circuit, and means for discharging the storage device through the
45 receiving-circuit at arbitrary intervals of time, substantially as described.

50 7. In an apparatus for utilizing electrical effects or disturbances transmitted to a distant receiving-station, the combination with a source of such effects or disturbances of a circuit distant from the source and adapted to have current impulses set up in it by the action of the effects or disturbances, a storage device,
55 means for commutating, directing or selecting the impulses and connecting the circuit with the storage device at succeeding intervals of time synchronizing with the impulses, a receiving-circuit, and means for periodically discharging the storage device through the
60 receiving-circuit, substantially as described.

65 8. In an apparatus for utilizing electrical effects or disturbances transmitted to a distant receiving-station, the combination with a source of such effects or disturbances of a circuit distant from the source and adapted to have current impulses set up in it by the action

of the effects or disturbances, a condenser, means for commutating, directing or selecting the impulses and connecting the circuit with the condenser at succeeding intervals of time synchronizing with the impulses, a receiving-circuit, and means for periodically discharging the condenser through the receiving-circuit, substantially as described.

70 9. In an apparatus for utilizing electrical effects or disturbances transmitted through the natural media, the combination with a source of such effects or disturbances of a circuit connecting points at a distance from the source between which a difference of potential is created by such effects or disturbances, a storage device included in such circuit and adapted to be charged with the energy supplied by the same, a receiving-circuit connected with the storage device, a receiver included in such receiving-circuit, and means for closing the receiving-circuit and thereby causing the receiver to be operated by the energy accumulated in the storage device,
80 substantially as described.

85 10. In an apparatus for utilizing electrical effects or disturbances transmitted through the natural media, the combination with a source of such effects or disturbances of a circuit at a distance from the source which is energized by such effects or disturbances, a storage device adapted to be charged with the energy supplied by such circuit, means for connecting the storage device with the said circuit for
90 periods of time predetermined as to succession and duration, a receiving-circuit connected with the storage device, a receiver included in such receiving-circuit, and means for closing the receiving-circuit and thereby causing the
95 receiver to be operated by the energy accumulated in the storage device, substantially as described.

100 11. In an apparatus for utilizing electrical effects or disturbances transmitted through the natural media, the combination of a circuit connecting points at a distance from the source between which a difference of potential is created by such effects or disturbances, a storage device included in such circuit and
105 adapted to be charged with the energy supplied by the same, a receiving-circuit, a receiver included in such circuit, and means for connecting the receiving-circuit with the storage device for periods of time predetermined as to succession and duration and thereby causing the receiver to be operated by the energy accumulated in the storage device, substantially as described.

110 12. In an apparatus for utilizing electrical effects or disturbances transmitted through the natural media, the combination of a circuit connecting points at a distance from the source between which a difference of potential is created by such effects or disturbances,
115 a storage device adapted to be charged with the energy supplied by such circuit for succeeding and predetermined periods of time, a receiving-circuit, a receiver included in the

receiving-circuit, and means for connecting the receiving-circuit with the storage device for periods of time predetermined as to succession and duration and thereby causing the receiver to be operated by the energy accumulated in the storage device, substantially as described.

13. In an apparatus for utilizing electrical effects or disturbances transmitted through the natural media, the combination of a circuit connecting points at a distance from the source, between which a difference of potential is created by such effects or disturbances, a condenser included in such circuit and adapted to be charged by the current in the same, a receiving-circuit connected with the condenser, a receiver included in such receiving-circuit, and a device adapted to close the receiving-circuit at arbitrary intervals of time and thereby cause the receiver to be operated by the electrical energy accumulated in the condenser, substantially as described.

14. In an apparatus for utilizing electrical effects or disturbances transmitted through the natural media, the combination of a charging-circuit distant from the source and energized by the effects or disturbances, a storage device included in the charging-circuit, means included in the charging-circuit and acting in synchronism with the impulses therein for commutating, directing or selecting the impulses, a receiving-circuit and means for periodically discharging the storage device through the receiving-circuit, substantially as described.

15. In an apparatus for utilizing electrical effects or disturbances transmitted through the natural media, the combination of a charging-circuit distant from the source and energized by the effects or disturbances, a condenser included in the charging-circuit and acting in synchronism with the impulses therein for commutating, directing or selecting the impulses, a receiving-circuit and means for periodically discharging the condenser through the receiving-circuit, substantially as described.

16. In an apparatus for transmitting signals or intelligence through the natural media from a sending-station to a distant point, the combination of a generator or transmitter adapted to produce arbitrarily varied or intermitted

electrical disturbances or effects in the natural media, a charging-circuit at the distant point adapted to receive corresponding electrical impulses or effects from the disturbances or effects so produced, a storage device included in the charging-circuit means included in the charging-circuit and acting in synchronism with the impulses therein for commutating, directing or selecting the impulses so as to render them suitable for charging the storage device, a receiving-circuit, substantially as described.

17. In an apparatus for transmitting signals or intelligence through the natural media from a sending-station to a distant point, the combination of a generator or transmitter adapted to produce arbitrarily varied or intermitted electrical disturbances or effects in the natural media, a charging-circuit at the distant point adapted to receive corresponding electrical impulses or effects from the disturbances or effects so produced, a condenser included in the charging-circuit, means included in the charging-circuit and acting in synchronism with the impulses therein for commutating, directing or selecting the impulses so as to render them suitable for charging the condenser, a receiving-circuit and means for periodically discharging the condenser through the receiving-circuit, substantially as described.

18. In an apparatus for transmitting signals or intelligence through the natural media from a sending-station to a distant point, the combination of a generator or transmitter adapted to produce arbitrarily varied or intermitted electrical disturbances or effects in the natural media, a circuit at the distant point adapted to receive corresponding electrical impulses or disturbances from the disturbances or effects so transmitted, a storage device included in such circuit and adapted to be charged thereby, a receiving-circuit connected with the storage device, a receiver included in the receiving-circuit and a device for closing the receiving-circuit at arbitrary intervals of time and thereby causing the receiver to be operated by the energy accumulated in the storage device, substantially as described.

NIKOLA TESLA.

Witnesses:

C.E. TITUS,

LEONARD E. CURTIS.

H. SHOEMAKER,
 WIRELESS TELEGRAPHY.
 (Application filed Oct. 25, 1901.)

Patented Nov. 25, 1902.

(No Model.)

3 Sheets—Sheet 1.

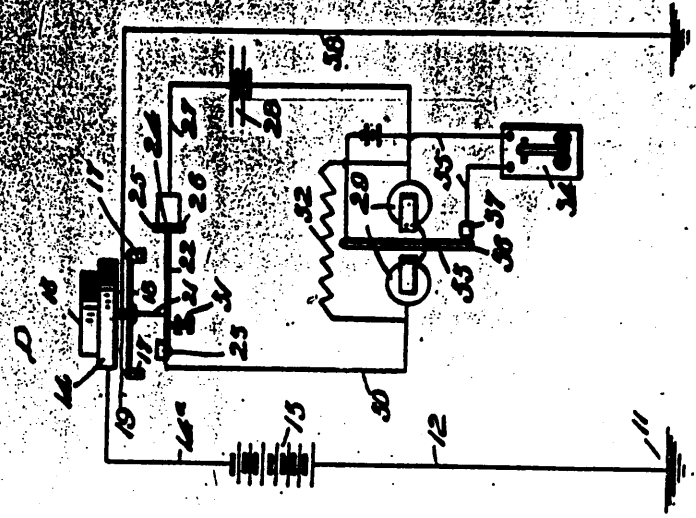
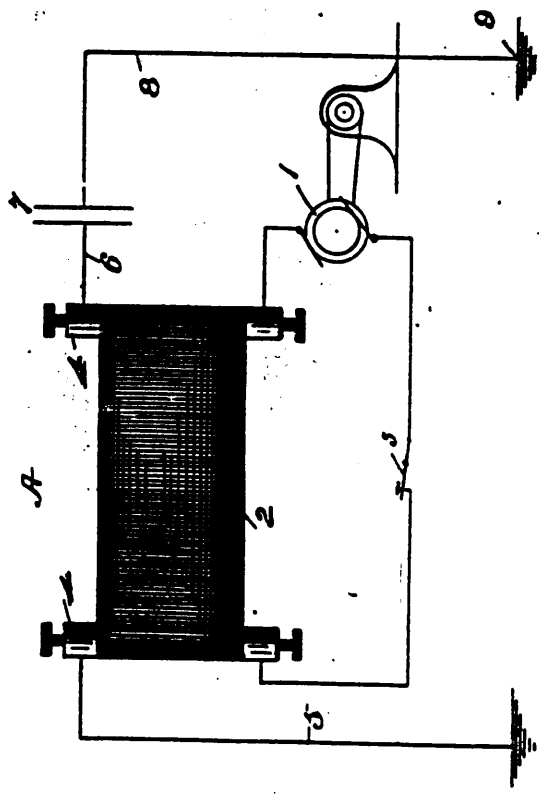

Fig. 1.



Witnesses
 Bernard M. Offutt
 M. W. Johnson

Inventor
 Harry Shoemaker
 By David T. Moore, Attorney

No. 714,244

Patented Nov. 25, 1902.

H. SHOEMAKER,
WIRELESS TELEGRAPHY
(Application filed Oct. 28, 1901.)

(No Model.)

3 Sheets—Sheet 2.

Fig. 2.

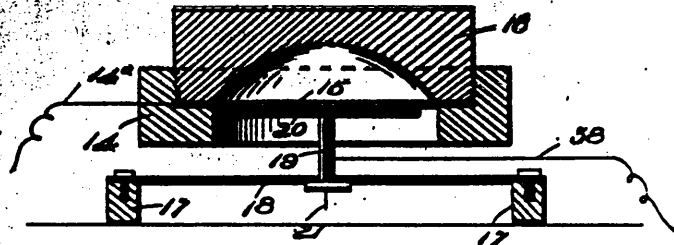
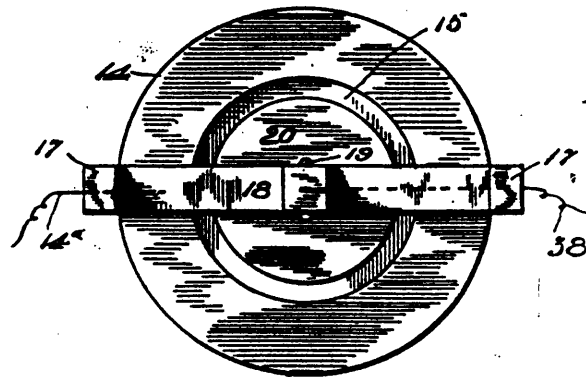

Fig. 3.



Witnesses
Bernard M. Offutt,
Mel. Johnson.

Inventor
Harry Shoemaker,
by David Moore, Attorney

No. 714,246.

Patented Nov. 25, 1902.

H. SHOEMAKER.
WIRELESS TELEGRAPHY.

(Application filed Oct. 29, 1901.)

(No Model.)

3 Sheets—Sheet 3.

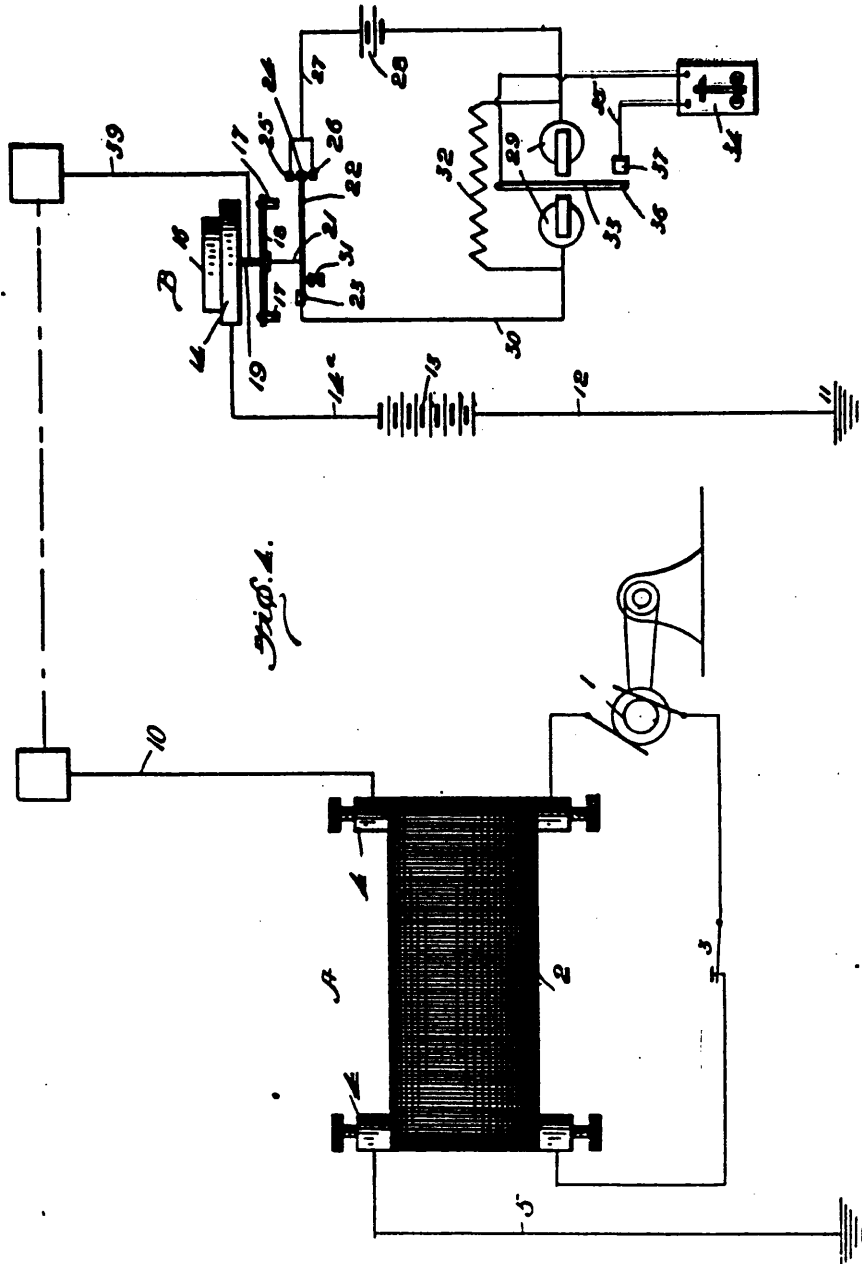

Witnesses
Bernard M. Offutt.
H. Browley.

Inventor
Harry Shoemaker,
by *David D. Moore.*
Attorney

UNITED STATES PATENT OFFICE.

HARRY SHOEMAKER, OF PHILADELPHIA, PENNSYLVANIA, ASSIGNOR TO MARIE V. GEHRING AND AMERICAN WIRELESS TELEPHONE AND TELEGRAPH COMPANY, OF PHILADELPHIA, PENNSYLVANIA.

WIRELESS TELEGRAPHY.

SPECIFICATION forming part of Letters Patent No. 714,246, dated November 25, 1902.

Application filed October 25, 1901. Serial No. 79,959. (No model.)

To all whom it may concern:

Be it known that I, HARRY SHOEMAKER, a citizen of the United States, residing at Philadelphia, in the county of Philadelphia and State of Pennsylvania, have invented certain new and useful Improvements in Wireless Telegraphy, of which the following is a specification.

This invention relates to improvements in wireless telegraphy, and has special reference to an apparatus in which static induction is used for operating the receiver.

Another object of my invention is to dispense with the Hertz oscillators now so generally used and also the imperfect electrical contact or coherer.

Another object of my invention is the provision of a system which employs two ground connections at each station, although a ground and an air wire may be employed, if so desired.

Another object of my invention is the provision of a system which is easily tuned, so that any number of apparatus may be operated at the same time without in any way affecting the other.

Another object of my invention is the provision of a transmitting apparatus in which is employed an alternator and a transformer which cause vibrations to pass through the earth or air to the receiving apparatus, which is provided with means which are positively operated to effect a relay and sounder, thus dispensing with the Hertz oscillator and the coherer.

To attain the desired objects, the invention consists of a system of wireless telegraphy embodying novel features of construction and combination of parts, substantially as disclosed herein.

In the drawings, Figure 1 is a diagrammatical view of the entire system. Fig. 2 is a sectional view of the receiving means, and Fig. 3 is a bottom plan view thereof. Fig. 4 is a diagrammatical view of the entire system using a ground and an air conductor at each station.

Referring to the drawings, A designates the transmitting apparatus, and B the receiving apparatus.

The transmitting apparatus consists of the alternator 1, to which is connected the primary of the transformer 2, a key 3 being employed to control the current through the wires connecting the two. Connected to the secondary posts 4 of the transformer are respectively the ground-wire 5 and the wire 6, to which is further connected the condenser 7, having the wire 8 connecting it to the ground at 9. If it should be desired, an air connection may be employed and is placed as shown in Fig. 4.

The receiving apparatus consists of the ground 11, to which is connected the wire 12, which is connected to the batteries 13, a wire 14 connecting these batteries to the cap 14, which clamps and holds the ferrotype-diaphragm 15 in place. Secured to this cap is the rubber cup 16. The wire is also connected to the diaphragm.

Mounted upon the posts 17 is the strip 18 of mica or any resilient insulation material. It is so mounted as to be free to vibrate at a certain period or pitch, depending upon its length. Carried by this strip by means of a post 19 is a metal plate or disk 20, which is also free to vibrate with said strip. Connected to the strip and also with the post 19 by means of a wire 21 is a spring-pointer 22, which is connected to a post 23, so as to have a slight spring motion, and upon its free end is carried the double-headed contact-point 24, which is adapted to always slightly contact one of the points 25 or 26, which, with the wires 27, battery 28, relay 29, wire 30, and pointer, make a circuit. An adjusting-screw 31 is used to vary the pressure of the spring-pointer. 32 is a non-inductive resistance which takes up self-inductance of the relay. The armature 33 controls the sounder 34 through its circuit 35 as contact at 36 and 37 is made. A ground-wire 38 is connected to the post 19, and, if desired, an air-wire 39 may be employed.

From the foregoing description, taken in connection with the drawings, the operation is readily understood; but, briefly stated, it is as follows: As the source of electricity here employed is an alternator, the same is continuously operated, the key keeping the cur-

rent from flowing through the primary of the transformer. When the key is pressed, the circuit is closed and the primary of the transformer is energized, this causing an alternating potential at the grounds. This sends out electrostatic waves at the ground, these waves being radiated over the surface of the earth in much the same manner as ripples in a pond when a stone is thrown therein—that is, it varies the potential at different points in its path. When these waves reach the receiver, a change of potential is caused at the receiver's grounds, causing variations of potential between 15 and 20, thus causing the plate 20 to vibrate the pointer. The relay is now energized, as the points have made a positive contact, and thus the recorder-circuit is operated and a signal transmitted and received. With this system it is possible to operate a great number of transmitting and receiving apparatus without interference, as the plate 20 has a certain natural period of vibration. If these impulses are sent in the same period as the natural period of the strip, the plate carried thereby will get its maximum swing, hence will record the characters sent. Should the periods of the transformer not be the same as the strip, it will not get its maximum swing, but may be affected to a certain extent, which would not be enough to record the characters. The transformer which furnishes the varying potential should have the same period as the strip.

I would have it understood that in place of the transformer and the alternator I may employ an induction-coil and a battery, an ordinary break being used with the coil and being run at the same period as the diaphragm of the receiver. This furnishes a varying potential and will operate equally as well.

The condenser in the transmitter is employed for the purpose of keeping the potential up, as it has enough dielectric to raise the potential very high, and also giving two negative grounds instead of one.

The battery of the receiver is of very high potential, being about one thousand volts, this being done to keep the diaphragm under a static field, thus making the same more sensitive in the same manner as the common magnetic field in magneto-telephones makes them more sensitive.

In the apparatus an air-wire may be employed and if used assumes the relative position as shown in Fig. 4.

I have found by experimenting that the grounds of the transmitter and receiver should be substantially the same distance apart—say from twenty to thirty feet—and also that the distance between the parts 15 and 20 should not be over one-eighth to one-fourth of an inch, the best results being obtained when the enumerated parts are substantially the distance apart as I have herein stated. The purpose of the condenser 7 is to restrict the amount of current through the

wires in the transmitter and to prevent a short circuit.

What I claim as new is—

1. In a signal system, a transmitter, which comprises a generator of fluctuating potentials, connections from said means to separated earth-plates through a current or kinetic-energy restraining means.

2. A transmitter which comprises means for generating high-potential fluctuating energy, connections from said means to separated earth-plates through a current or kinetic-energy restraining means, whereby electrostatic energy of high potential is impressed upon the earth.

3. A transmitter which comprises a source of fluctuating electrical energy, a primary of a transformer in the circuit of said source, a means for controlling the energy in accordance with the signal to be sent, and connections from the secondary of said transformer to separated earth-plates through a current or kinetic-energy restraining device, whereby electrostatic energy of high potential is impressed upon the earth.

4. A transmitter which comprises means for generating fluctuating potential differences, connections for said means to separated earth-plates and a condenser between said generating means and one of the earth-plates and means for modifying the fluctuating potentials in accordance to the signal to be sent.

5. A transmitter which comprises a source of fluctuating electrical energy, a primary of a transformer in the circuit of said source, a means for controlling the energy in accordance with the signal to be sent and connections from the secondary of said transformer to separated earth-plates through a condenser, whereby electrostatic energy of high potential is impressed upon the earth.

6. In a signal system the combination of a transmitter which comprises a generator of fluctuating potentials, and connections from said generator to separated earth-plates through an energy-restraining means; and a receiver which comprises a plurality of plates in inductive relation, means for permanently charging the plates, and a local circuit controlled by said plates.

7. In a signal system, the combination of a transmitter, which comprises means for generating fluctuating potential differences, connections for said means to separated earth-plates, and means for modifying the fluctuating potentials in accordance with the signal to be sent; and a receiver, which comprises a plurality of plates in inductive relation, means for permanently charging the plates, and a local circuit controlled by said plates.

8. In a signal system, the combination of a transmitter, which comprises means for generating high-potential fluctuating energy, connections from said means to separated earth-plates through an energy-restraining means,

whereby the earth connections are maintained at widely-different potentials; and a receiver, which comprises a plurality of plates in inductive relation, means for permanently charging the plates, and a local circuit controlled by said plates.

9. In a signal system, the combination of a transmitter, which comprises a source of fluctuating electrical energy, a primary of a transformer in the circuit of said source, a means for controlling the energy in accordance with the signal sent, and connections from the secondary of said transformer to separated earth-plates through an energy-restraining device, whereby said earth-plates are maintained at widely-different potentials; and a receiver, which comprises a plurality of plates in inductive relation, means for permanently charging the plates, and a local circuit controlled by said plates.

10. In a signal system, the combination of a transmitter which comprises a generator of fluctuating potentials, and connections from said generator to separated earth-plates through an energy-restraining means; and a receiver, which comprises a plurality of plates in inductive relation, and a source of high-potential energy in connection with opposing plates through an earth-circuit.

11. In a signal system, the combination of a transmitter, which comprises means for generating fluctuating potential differences, connections for said means to separated earth-plates, and means for modifying the fluctuating potentials in accordance with the signal to be sent; and a receiver, which comprises a plurality of plates in inductive relation, and a source of high-potential energy in connection with opposing plates through an earth-circuit.

12. In a signal system, the combination of a transmitter which comprises means for generating high-potential fluctuating energy, connections from said means to separated earth-plates through an energy-restraining means, whereby the earth connections are maintained at widely-different potentials; and a receiver, which comprises a plurality of plates in inductive relation, and a source of high-potential energy in connection with opposing plates through an earth-circuit.

13. In a signal system, the combination of a transmitter which comprises a source of fluctuating electrical energy, a primary of a transformer in the circuit of said source, a means for controlling the energy in accordance with the signal sent, and connections from the secondary of said transformer to separated earth-plates through an energy-restraining device, whereby said earth-plates are maintained at widely-different potentials; and a receiver which comprises a plurality of plates in inductive relation, and a source of high-potential energy in connection with the opposing plates through an earth-circuit.

14. In a signal system, the combination of a transmitter, which comprises a generator of

fluctuating potentials, and connections from said generator to separated earth-plates through an energy-restraining means; and a receiver, which comprises opposing plates, a high-potential source of energy connected to said plates through an earth-circuit to permanently charge the same, and a circuit-controlling means operated by the reaction between said plates upon the reception of a signal.

15. In a signal system, the combination of a transmitter, which comprises a generator of fluctuating potentials, and connections from said generator to separated earth-plates through an energy-restraining means, and a receiver, which comprises plates in inductive relation to each other, means for normally charging said plates to a high potential, means controlling a local signal-circuit operated upon fluctuations of charge on said plates due to received signal energy.

16. In a signal system, the combination of a transmitter, which comprises a generator of fluctuating potentials, and connections from said generator to separated earth-plates through an energy-restraining means; and a receiver, which comprises a plurality of plates in inductive relation, batteries of high potential permanently charging the plates, and a local circuit controlled by said plates.

17. In a signal system, the combination of a transmitter, which comprises a generator of fluctuating potentials, and connections from said generator to separated earth-plates through an energy-restraining means; and a receiver, which comprises a plurality of plates in inductive relation, a battery of high-potential energy in connection with opposing plates through an earth-circuit.

18. In a signal system, the combination of a transmitter, which comprises a generator of fluctuating potential, and connections from said generator to separated earth-plates through an energy-restraining means; and a receiver which comprises opposing plates, a battery of high potential connected to said plates through an earth-circuit to permanently charge the same, and a circuit-controlling means operated by the reaction between said plates upon the reception of a signal.

19. In a signal system, the combination of a transmitter, which comprises a generator of fluctuating potential, and connections from said generator to separated earth-plates through an energy-restraining means; and a receiver, which comprises plates in inductive relation to each other, a battery for normally charging said plates to a high potential, and means controlling a local signal-circuit operated upon fluctuations and charge on said plates due to received signal energy.

In testimony whereof I affix my signature in presence of two witnesses.

HARRY SHOEMAKER.

Witnesses:

J. N. FORT, Jr.,

CHAS. J. FOREMAN.

A. F. COLLINS.
WIRELESS TELEPHONY.
APPLICATION FILED AUG. 21, 1905.

3 SHEETS—SHEET 1.

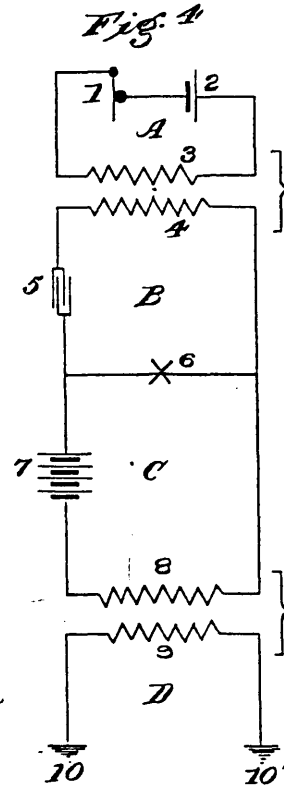
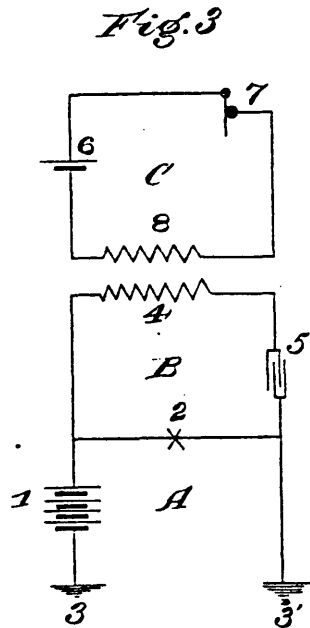
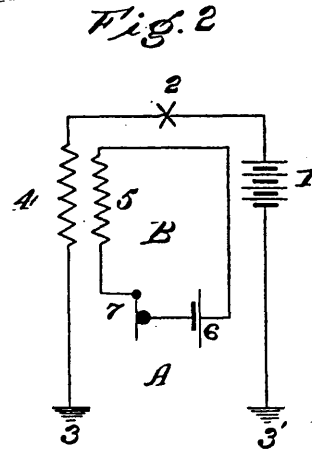
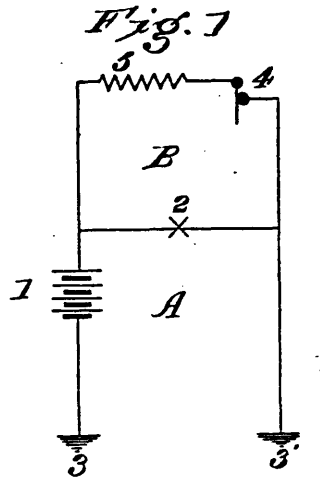

WITNESSES:
Jos. A. Ryan.
Edw. W. Ryan.

INVENTOR
Archie Frederick Collins
BY *Munn & Co.*
ATTORNEYS

10/11/44

10/11/44

10/11/44

10/11/44

10/11/44

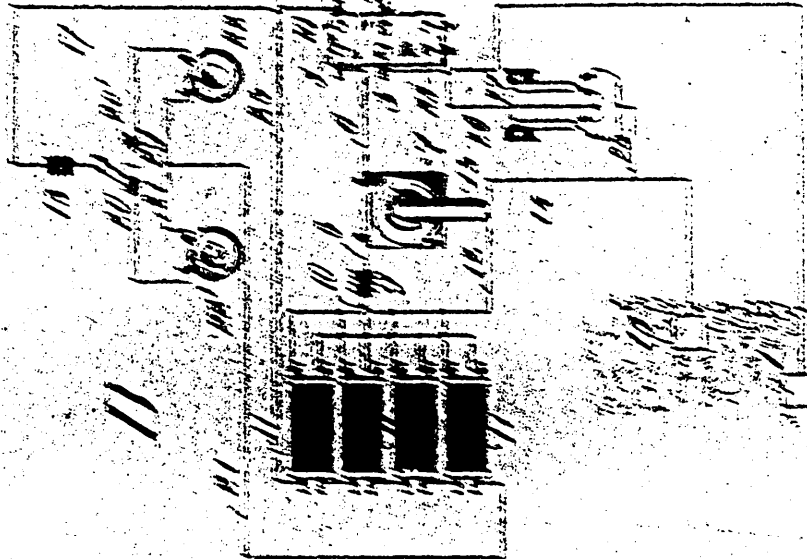
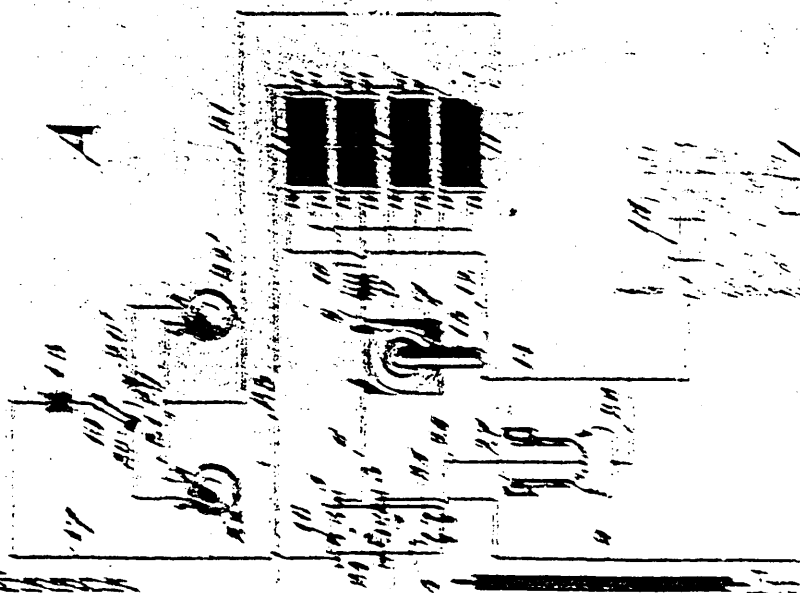

Fig. 1.



10/11/44

10/11/44

S. MUSITS.
APPARATUS FOR WIRELESS TELEPHONY.

APPLICATION FILED NOV. 24, 1902.

NO MODEL.

2 SHEETS—SHEET 2

Fig. 2.

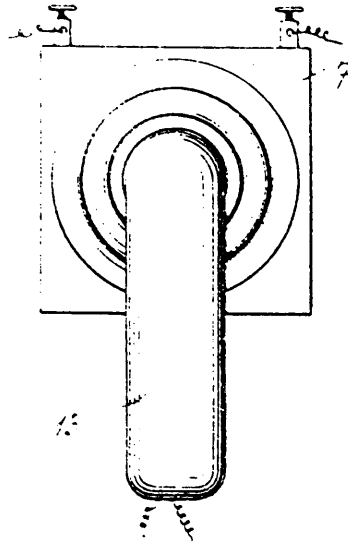

Fig. 3.

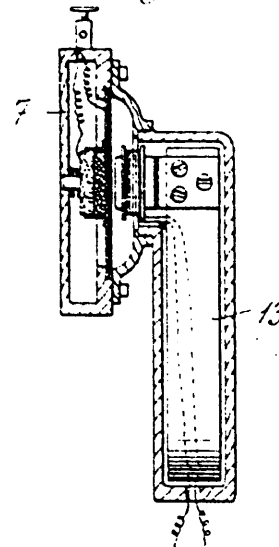

Fig. 4.

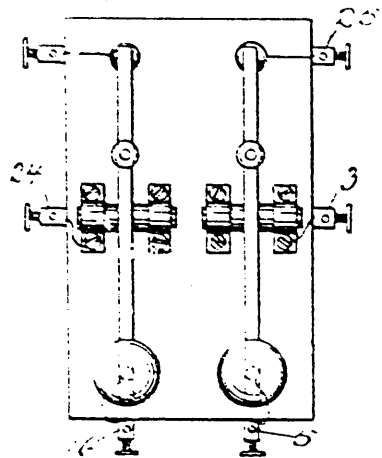
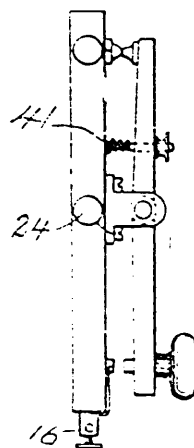

Fig. 5.



WITNESSES.

W. H. Mrell
Richard C. Collette

INVENTOR,

Sigmund Musits,
by *Gerhard Staud,*
Attorneys.

UNITED STATES PATENT OFFICE.

SIGMUND MUSITS, OF STEINAMANGER, AUSTRIA-HUNGARY.

APPARATUS FOR WIRELESS TELEPHONY.

SPECIFICATION forming part of Letters Patent No. 777,216, dated December 13, 1904.

Application filed November 24, 1902. Serial No. 132,547. (No model.)

To all whom it may concern:

Be it known that I, SIGMUND MUSITS, official of the Royal Hungarian Postal and Telegraphic Administration, a subject of the Emperor of Austria-Hungary, residing in Steinamanger, Austria-Hungary, have invented a certain new and useful Improvement in Apparatus for Wireless Telephony; and I do hereby declare the following to be a full, clear, and exact description of the invention, such as will enable others skilled in the art to which it appertains to make and use the same, reference being had to the accompanying drawings, and to characters of reference marked thereon, which form a part of this specification.

The present invention relates to improvements in devices or apparatus for electrically transmitting language, music, or signals over great distances without the use of connecting-wires.

In order to make the invention more readily understood, I will now describe it with reference to the accompanying drawings, wherein—

Figure 1 is a diagrammatical representation of two identical stations A and B, both of which may be used for sending and receiving messages. Fig. 2 is an enlarged front elevation of a telephone in connection with a microphone. Fig. 3 is a vertical sectional view through Fig. 2. Fig. 4 is a top plan view of a certain double Morse key 4, hereinafter referred to; and Fig. 5 is a side view of what is shown in Fig. 4.

Each station consists of two circuits, the microphone and the telephone circuits, and the microphone-circuit in turn has two circuits, the primary and the secondary circuits.

A hollow body 1, preferably cylindrical in shape and of copper or other suitable material, which may or may not be filled with a current-generating liquid or electrolyte, is embedded into the ground and is connected by the line-wire 2 with the contact 3 of a double key 4, whose handle end is normally held up by a contractile spring 4'.

In the specification and claims I shall refer to this hollow body 1 as "cylinder," although it may be of other shape or form. From the contact 5 of the double key 4 a wire 6 runs to

the microphone 7. A wire 8 then connects to a powerful source of electricity 9 and a wire 10 to one or more secondary coils 11, within which the primary coils are arranged in the manner usual with induction-coils. From the secondary coils 11 a wire 12 is stretched to the telephone 13, interconnected with the microphone 7, and the wire 14 connects the telephone with the metal cylinder 15, sunk into the ground. The telephone 13 and microphone 7 assist each other when operating through the effects of the vibration of the telephone-diaphragm on the microphone-membrane, whereby the microphone produces current-impulse, which in its turn increases the vibration of the telephone-membrane. The described connections I call the "secondary circuit." From the contact 16 of the double key 4 a wire 17 connects with a source of electricity 18, and thence a wire 19 to a switch 20 with contacts 20 and 20'. This switch has as many contacts as there are microphones 22 22' cut into the circuit 21. (In the drawings only two such microphones are shown, and consequently only two contacts.) The wire 21 then is connected to the primary coils within the secondary coils 11. A wire 23 then connects the primary coils with the contact 24 of the double key 4. From contact 25 a wire 26 stretches to the telephone 27, and a wire 28 from the telephone to the grounded cylinder 15. These connections I call the "primary circuit."

The operation of the apparatus is the following: If station A desires to call up station B, the switch 29 is laid on contact 20 or 20', according to whether the microphone 22 or 22' is used. If microphone 22 is to be used, the contact is made at 20 and both keys of the double key 4 are depressed. The circuit is now closed as follows: The current flows from the source of electricity 18 over line-wire 19 to switch 29, contact 20, microphone 22, wire 21, to the primary induction-coils, thence by wire 23 to contact 24 of the double key 4 to contact 16 and over the wire 17 to the battery 18. The current impulses generated by actuating the microphone 22 will induce in turn secondary currents in the coils 11 corresponding to the primary currents, which

will then travel on the one hand over wire 12 to the telephone 13, wire 14, and to the grounded cylinder 15; on the other hand, over wire 10, battery 9, wire 8, microphone 7, wire 5 6, to contact 5 of the double key 4, thence to contact 3, wire 2, and to the embedded cylinder 1. The telephone 13, cut into this circuit, and the microphone 7 now serve as a translator to enhance the current impulses. From 10 the cylinders 1 and 15 of station A the current impulses will then travel through the conducting medium (ground, water) to the corresponding cylinders 1 and 15 of station B. Since in this station the double key is not depressed, the current will flow from cylinder 1 15 over wire 2 to contact 3 of double key 4, to contact 25, wire 26, telephone 27, wires 28 and 14 to cylinder 15, thereby closing the circuit between the two stations. If, however, station B desires to talk to station A, the double key 4 of station B must be depressed, the 20 switch 29 turned into the contact corresponding to the microphone to be used, and the devices operate as above described.

25 It is evident that changes may be made in the interconnection of the various parts without stepping beyond the scope of the invention.

What I claim is—

30 1. In apparatus for wireless telephony, a primary circuit, comprising a source of electricity and microphones cut into the said primary circuit, a secondary circuit, adapted to be influenced by the said primary circuit, a 35 telephone cut into the said secondary circuit, a microphone adapted to be actuated by said telephone and metal cylinders in said second-

ary circuit, embedded in the ground, all substantially as and for the purpose set forth.

2. In apparatus for wireless telephony, a 40 primary circuit comprising a source of electricity, microphones, primary induction-coils and a double key, a secondary circuit, comprising a source of electricity, secondary induction-coils, adapted to be influenced by said 45 primary induction-coils, a telephone, a microphone adapted to be actuated by said telephone, a double key and metal cylinders embedded in the ground connected to the secondary line ends, substantially as and for the 50 purpose set forth.

3. In apparatus for wireless telephony, a primary circuit, comprising a source of electricity, microphones, primary induction-coils and a double key, a secondary circuit, comprising a source of electricity, secondary induction-coils, adapted to be influenced by said 55 primary induction-coils, a telephone, a microphone adapted to be actuated by said telephone, a double key and metal cylinders embedded in the ground and connected to the 60 secondary line ends, and a telephone or telephones connected to the one grounded cylinder and to the said double key and through said key, in its position of rest, to the other 65 grounded metal cylinder, all substantially as and for the purpose set forth.

In testimony that I claim the foregoing I have hereunto set my hand this 4th day of November, 1902.

SIGMUND MUSITS.

Witnesses:

FRANZ REITER,
ALVESTO S. HOGUE.

A. F. COLLINS.
WIRELESS TELEPHONY.
APPLICATION FILED AUG. 21, 1905.

Fig. 5

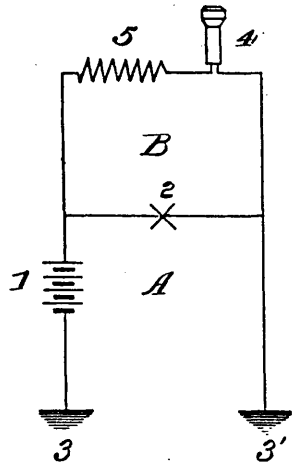

Fig. 6

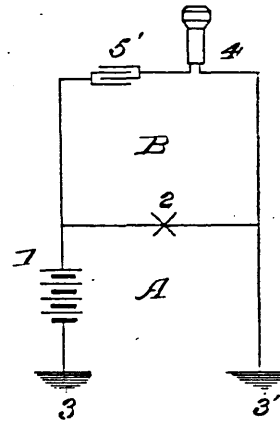

Fig. 7

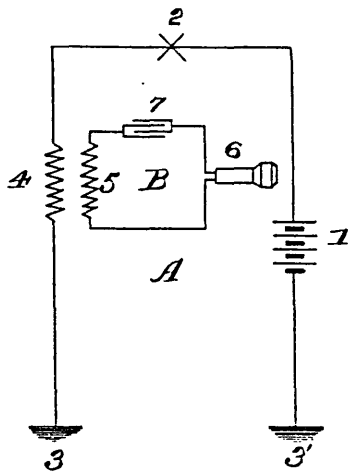
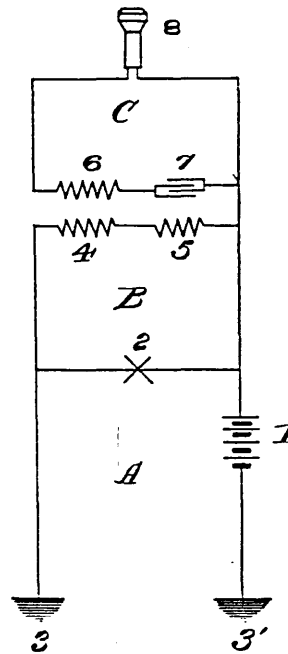

Fig. 8



WITNESSES:
Jos. A. Ryan
Edw. W. Byrn.

INVENTOR
Archie Frederick Collins
BY *Munn & Co.*
ATTORNEYS

No. 814,942.

PATENTED MAR. 13, 1906.

A. F. COLLINS.
WIRELESS TELEPHONY.
APPLICATION FILED AUG. 21, 1905.

3 SHEETS—SHEET 3.

Fig. 9

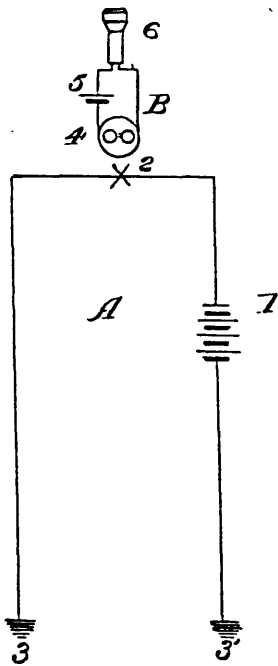
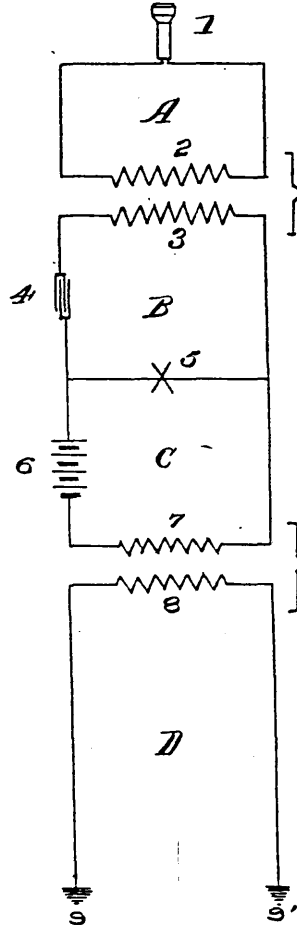

Fig. 10



WITNESSES:
Geo. A. Ryan.
Edw. W. Ryan.

INVENTOR
Archie Frederick Collins.
BY *Munn & Co.*
ATTORNEYS

UNITED STATES PATENT OFFICE.

ARCHIE FREDERICK COLLINS, OF NEW YORK, N. Y.

WIRELESS TELEPHONY.

No. 814,942.

Specification of Letters Patent.

Patented March 13, 1906.

Application filed August 21, 1905. Serial No. 275,026.

To all whom it may concern:

Be it known that I, ARCHIE FREDERICK COLLINS, a citizen of the United States, and a resident of New York city, borough of Manhattan, in the county and State of New York, have invented new and useful Improvements in Wireless Telephony, of which the following is a specification.

My invention relates to the art of transmitting and receiving articulate speech electrically between two or more stations without connecting-wires, but employing the earth or other medium as a means of propagation; and it relates more particularly to the transmission of impulses into the earth or other medium by means of a direct or alternating current having a higher voltage and greater amperage than it has been found possible to employ heretofore and the reception of these impulses and their amplification and intensifications at the receiving-station.

It is well known to those versed in the art that if a telephone-transmitter, a source of electromotive force, and the earth or other medium are connected in series by terminal conductors entering the earth any variation of the current due to resistance changes in the transmitter will produce a difference of potential at the terminal conductors forming contact with the earth or other medium and when a difference of potential is established at the two terminals connected to the earth a current is established in the circuit of which the earth forms a portion. Equipotential surfaces are established around each terminal, and while the greater portion of the current flows directly between the terminals a certain portion taking a less direct path flows from one to the other in arc-shaped paths extending from the conductors a considerable distance, or this arrangement may be so modified that an alternating current may be made to produce the same results—*e. g.*, a transmitter and a source of electromotive force are connected in series with the primary of a simple transformer-coil the terminals of the secondary of which are connected with the terminal conductors leading to the earth or other medium, in which case the resistance changes in the transmitter cause the current in the primary circuit to create, according to the law of induction, an alternating current in the secondary circuit of which the earth or other medium forms a portion.

Heretofore no provision has been made for amplifying or intensifying the received pulsations emitted by the transmitters described, and a simple telephone-receiver has been employed to pick up and translate the impulses into speech. Likewise all experiments in wireless telephony using conductor-terminals embedded in the earth or other medium have been made by means of ordinary telephone-transmitters, which in commercial practice operate approximately on twenty-five volts and one-half ampere. Using of necessity a transmitter having this limitation wireless telephony by this method has been successful over comparatively short distances, since where a current in excess of that stated is used it burns out the transmitter.

Now the object of my invention is to obviate this difficulty and to provide for the use of any voltage and any amperage without regard to the transmitter proper, and in so doing I render the transmitter absolutely independent of the current traversing the earth or other medium and I also amplify the received impulses so that the reproduced speech will be louder and more distinct than heretofore.

Figures 1, 2, 3, and 4 show diagrammatically various modifications of the transmitter arranged in accordance with my invention, and Figs. 5, 6, 7, 8, 9, and 10 are modifications of my receiver.

My method of transmitting consists, substantially, in modifying a current (of sufficient electromotive force to produce an arc-light between the electrodes of any conducting material, such as pencils of carbons or substances employed in the production of arc-lights) by means of either shunting the current, as shown in Fig. 1, or by superimposing a direct or alternating current on the circuit including the arc-light, as shown in Figs. 2, 3, and 4.

In Fig. 1 the circuit represented by A consists of a source of electromotive force 1, the arc-light 2, and the conductor-terminals 3 3', forming connection with the earth or other medium. In parallel with this circuit, which may be designated as the "heavy-current" circuit, is the shunt-circuit B, derived from the heavy-current circuit A and in which is included a telephone-transmitter 4 and a resistance 5. Any modification of the derived

circuit B by virtue of a change of resistance due to a variable pressure of the diaphragm is impressed upon the circuit A, and the temperature of the arc and its resistance indicates a corresponding and proportionate change in the circuit A. This variation of resistance in the arc produces in the circuit which includes it electrical undulations in the earth or other medium.

In a second modification of my method (shown in Fig. 2) the heavy-current circuit A includes a source of electromotive force 1, the arc-light 2, and the conductor-terminals 3 3', forming connection with the earth or other medium in which they are embedded and one of the windings 4 of a transformer-coil. The circuit B is separated mechanically from the circuit A, but is in inductive association with it through the complementary winding of the coil, as shown at 5. The circuit B includes the winding 5, battery 6, and transmitter 7. When the transmitter 7 is in operation, an undulatory current is set up and superimposed on the current in the circuit A, and the current is varied as indicated with reference to Fig. 1.

A third modification is shown in Fig. 3. In this case the current flowing in the circuit A is varied by an alternating current set up in the circuit B, which includes a winding of a transformer-coil 4 and a condenser 5. A third circuit C includes a battery-cell 6, a telephone-transmitter 7, and a winding 8 of the transformer. It is the undulations of the current in this circuit which produce the alternating current in the circuit B.

A fourth modification of this method is shown in Fig. 4 and has for its object the production of alternating currents in the circuit which includes the earth or other medium. By referring to Fig. 4, A B C D indicate separate circuits. The primary circuit (represented by A) includes a telephone-transmitter 1, a source of electromotive force 2, and the winding 3 of a transformer-coil. The secondary circuit B includes the complementary coil 4 of the transformer, a condenser 5, and the arc-light 6. The third circuit C is in parallel with the circuit B and includes the arc-light 6, a source of electromotive force 7, which feeds the arc, and the primary winding 8 of a transformer. The fourth circuit D includes the secondary 9 of the transformer and the conductor-terminals 10 10', embedded in the earth or other medium which completes the circuit.

In action the direct current from the source of electromotive force 2 is changed into an undulatory current by means of the transmitter 1 in the circuit A. This sets up an alternating current in the circuit B by means of the transformer 3 4, and this current is then superimposed upon the current flowing in C feeding the arc-light. Every imposition of the alternating undulatory cur-

rent flowing in C produces identically the same effect upon the circuit D that the current in the circuit A has upon B, with the final result that an alternating current having the same frequency and phase as that produced in the circuit B, but with its amplitude greatly increased, is made to pass through the circuit including the earth or other medium in which conductor-terminals are embedded.

It is obvious that many other modifications of my method of transmission may be made, but the results obtained will be the same. It is likewise obvious that my system may be employed for signaling without wires, provided a telegraph-key is substituted for the telephone-transmitter indicated in the text.

In connection with my method of transmitting articulate speech without connecting-wires there may be employed as a receiving device a simple telephone-receiver having its conductor-terminals embedded in the earth or other medium. When such a receiver is employed, the received impulses will have a value corresponding to the sensibility of the instrument.

Now to further increase the amplitude and intensity of the impulses, so that the reproduction of speech may be louder, and without increasing the sensitiveness of the receiving-telephone I employ a method shown in Fig. 5, of which Figs. 6, 7, 8, 9, and 10 are modifications.

Fig. 5 shows my invention in its simplest form. The circuit A includes a source of electromotive force, an arc-light 2, and conductor-terminals 3 3', embedded in the earth or other medium. The circuit B is derived from A, which is in parallel to it and includes a telephone-receiver 4 or other means of indication and a resistance 5. When in operation, the function of this receiver is as follows: The received impulses through the earth or other medium are superimposed and impressed upon the current flowing in the circuit A, which includes the source of electromotive force 1, the arc-light 2, and the conductor-terminals 3 3', embedded in the earth or other medium. These superimposed impulses vary the resistance of the arc 2 and increase the variations of the current from the generator 1 flowing through the circuits A and B. The receiver 4 in the circuit B is protected from excessive voltage by means of the resistance 5, and the circuit B (since it is in parallel with the circuit A) derives its energy from that circuit, and the telephone-receiver 4 responds to changes in the circuit A, but with augmented amplitude and intensity.

In Fig. 6 the circuit B includes a condenser 5', in series with the transmitter instead of the resistance 5, (shown in Fig. 5,) which precludes the flow of the direct current in the circuit A through the receiver 4, but permits alternating impulses to act upon it, or a com-

ination may be effected by including the receiver 4, the resistance 5 of Fig. 5, and the condenser 5', Fig. 6, in the circuit B.

Fig. 7 illustrates a modification of my invention in which two distinct circuits are represented by A B. The circuit A includes a source of electromotive force 1, an arc-light 2, conductor-terminals 3 3', embedded in the earth or other medium, and one winding 4 of a transformer-coil. The circuit B includes the opposite winding 5 of the transformer-coil, a telephone-receiver 6, and a condenser 7. This arrangement removes the telephone-receiver from the circuit A, and thus insures its safety.

Fig. 8 shows a form of my receiver in which the circuit A includes a source of electromotive force 1, an arc-light 2, and conductor-terminals 3 3', embedded in the earth or other medium. The circuit B is in parallel with the circuit A and includes the primary 4 of a transformer and a resistance 5, or a condenser may be substituted instead. The circuit C includes the winding 6 of a transformer, condenser 7, and a receiver 8.

Fig. 9 shows diagrammatically the arrangement I employ for utilizing the well-known properties of selenium. The circuit A consists of a source of electromotive force 1, an arc-light 2, and conductor-terminals 3 3', embedded in the earth or other medium. The circuit B is mechanically and electrically removed from the circuit A, but is influenced by means of the variation of light intensities of the arc 2 acting on a selenium-cell 4, which is included in the circuit B, together with a source of electromotive force 5 and a telephone-receiver 6 or other means of indication.

Another form of receiver is shown in Fig. 10. In this modification of my invention a receiver 1 is connected in series with the secondary 2 of a transformer forming the circuit A. The secondary circuit B includes one winding 3 of the transformer-coil, a condenser 4, and the arc-light 5. This circuit is in parallel with and derived from the circuit C, which includes the arc-light 5, the source of electromotive force 6, and one winding 7 of the transformer-coil. The circuit D includes the complementary winding 8 of the transformer-coil and the conductor-terminals 9 9'. In action the function of these various factors are as follows: The impulses propagated through the earth or other medium are impressed upon the circuit D and are transferred by the transformer 7 8 to circuit C. The resistance of the said circuit is varied, as before stated, and undulatory currents flow in the derived circuit B, and these are transformed into alternating currents in the circuit A in which the receiver 1 is placed, and as a result of these operations the amplitude of the current and its intensity is increased beyond the maximum value impressed upon the circuit D.

tus comprising a source of electromotive force, an arc-light, a circuit connecting the same and having its conductor-terminals embedded in the earth, or other natural mediums, an independent circuit containing a receiver and a source of electromotive force and means for influencing the current in said

In defining my invention with greater clearness I would state that I am aware that the so-called "speaking-arc" is not new, and I do not claim that broadly, but only the combination of the speaking-arc and the dispersion method herein shown and described.

It will be seen from a comparison of Figs. 1 and 5 that the same instrumentalities may serve for both a transmitting-station and a receiving-station, and in referring generically to the transmitter 4 of Fig. 1 and receiver 4 of Fig. 5 in the claim I employ the generic term of "sound-converter," meaning thereby any means for converting sound-waves into electrical waves or electrical waves into sound-waves.

Having thus described my invention, what I claim as new, and desire to secure by Letters Patent, is—

1. In a wireless telephone or telegraph the combination of a source of electromotive force, an arc-light, a circuit connecting the same and having the conductor-terminals embedded in the earth or other medium, and a circuit containing a sound-converter for transmitting or receiving, said sound-converter being in a circuit of its own outside the main influence of the arc-light circuit, substantially as shown and described.

2. In a wireless telephone or telegraph, the combination of a source of electromotive force, an arc-light, a circuit with terminals forming connection with or embedded in the earth or other medium, and means for modifying the current flowing through the said circuit, said means consisting of an independent circuit containing a sound-converter, substantially as shown and described.

3. In a wireless telephone or telegraph, the combination of a source of electromotive force, an arc-light, a circuit with terminals connecting the same with the earth or other medium, a circuit including the arc-light and containing also a sound-converter for transmitting or receiving substantially as described.

4. In a wireless telephone or telegraph, the combination of a source of electromotive force, an arc-light, a circuit with terminals connecting the same with the earth or other medium, a circuit including the arc-light and containing a resistance and a sound-converter, substantially as shown and described.

5. In a wireless telephone or telegraph, the combination of a transmitter proper, mechanism connected therewith for producing a so-called "speaking-arc," for varying the current forming said arc and producing current impulses, and means for transmitting said current impulses to a natural medium capable of conveying the same to a distance.

6. In a wireless telephone or telegraph, the combination with a transmitting apparatus of the kind described; of a receiving apparatus

circuit containing the receiver by the variations in the arc-light, substantially as described.

ARCHIE FREDERICK COLLINS.

Witnesses:

WALTON HARRISON,
E. C. NIELSON.

No. 842,910.

PATENTED FEB. 5, 1907.

G. W. PICKARD.
WIRELESS COMMUNICATION.
APPLICATION FILED NOV. 30, 1906

Fig. 1.

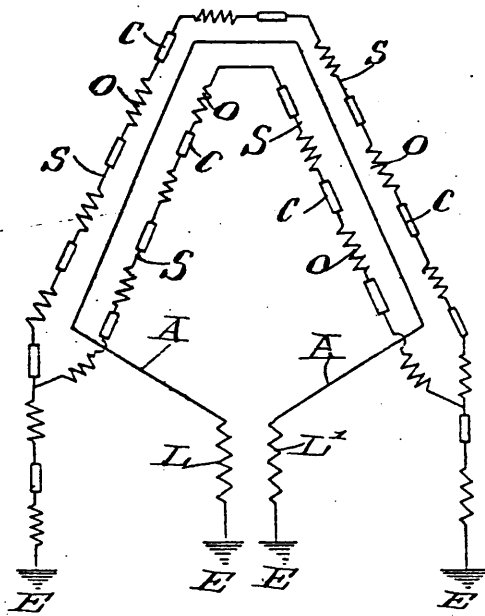

Fig. 2.

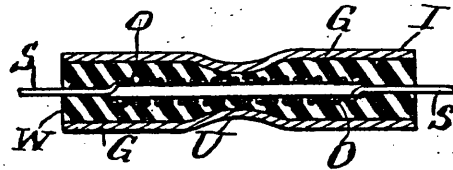

Fig. 3.



Fig. 5.

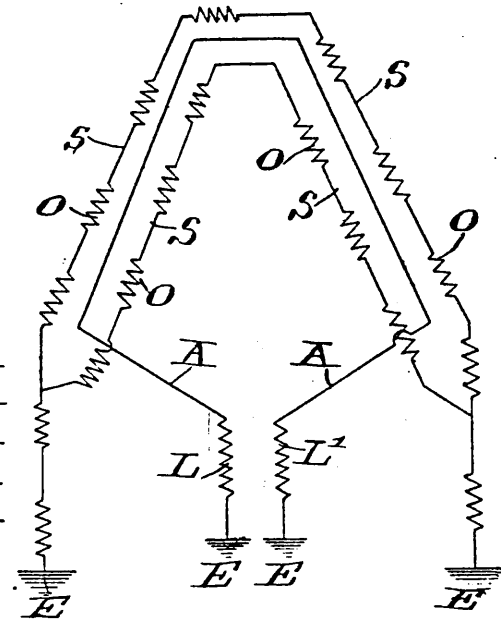
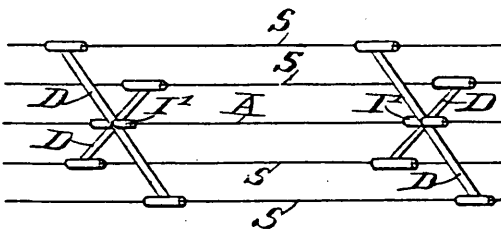

Fig. 4.



Attest:

R. C. Powell
Ralph C. Powell

Inventor:
Greene of Whittier Pickard

by *Philip Farnsworth* Atty

UNITED STATES PATENT OFFICE.

GREENLEAF WHITTIER PICKARD, OF AMESBURY, MASSACHUSETTS.

WIRELESS COMMUNICATION.

No. 842,910.

Specification of Letters Patent.

Patented Feb. 5, 1907

Application filed November 30, 1906. Serial No. 345,642.

To all whom it may concern:

Be it known that I, GREENLEAF WHITTIER PICKARD, a citizen of the United States of America, and a resident of the town of Amesbury, State of Massachusetts, have invented certain new and useful Improvements in Wireless Communication, the principles of which are set forth in the following specification and accompanying drawings, which disclose the form of the invention which I now consider to be the best of the various forms in which its principles may be embodied.

This invention relates to means for receiving waves. This invention relates to means for receiving waves.

The object of the invention is to prevent the deleterious effects of static discharges.

The invention consists in a static shield for the wave-interceptor, as described herein-after and set forth as to novelty in the appended claims.

The serious results of static discharges occurring under certain climatic and atmospheric conditions, is well known to those skilled in the art.

Of the drawings, Figure 1 is a diagrammatic illustration of an application of the invention to a common form of wave-interceptor, or receiving-antenna, consisting of a single conductor A forming a closed circuit and including the usual inductance L, L' and connected to earth at E; Figs. 2 and 3 are sectional views of devices used in the invention; Fig. 4 is a perspective illustrating the practical use of the invention; and Fig. 5 is a view of a modification.

As shown in Figs. 1 and 4, a conducting static shield composed of copper conductors S is arranged about and close to the interceptor or antenna A. This shield is of special construction, such that all static discharges will take place on the conductors of which the shield is composed, and not on the receiving-antenna A where they have acted harmfully theretofore.

The conductors S have connected with them respectively an impedance-coil O and a non-inductive resistance C, which may be used in numbers connected at intervals in the shield-conductors S. The object of this construction is to prevent the static discharge from taking an oscillatory form, and to cause it to slowly subside as a single pulse to earth (when the conductors S are connected to earth E as shown), the rate of

change of electric force being so slow that no disturbance will be induced on the antenna A. Owing to the high impedance of the shield, it is practically transparent to a rapid change of electric force in the ether, so that the signal-waves from a transmitting-station pass through the shield without loss of energy, and cut the interceptor A to effect the usual result of delivering the signal.

The impedance-coils O are preferably made of small iron wire, in order to obtain high impedance and produce hysteresis losses which contribute to the damping out of any tendency of the static discharge toward oscillation. This wire may be about No. 26 or 28, and covered with cotton. As shown in Fig. 2, these coils are wound on wooden cores G, which may be protected by insulators I filled with a sealing compound W, such as wax. The iron-wire coils O are securely connected in any suitable way with the copper shield-wires S.

The non-inductive resistances C may be in the form of carbon rods or sticks, and may be protected as shown in Fig. 3, by insulators I filled with wax W, in the same way as the impedance-coils O, and also securely connected in any suitable way with the copper shield-wires S. Instead of using separate non-inductive resistances, the arrangement shown in Fig. 5 may be used, the impedance-coils consisting of fine or high-resistance wire, to contain in one device the desired ohmic as well as reactive impedance.

As shown in Fig. 4, the plurality of shield-wires S may be arranged entirely around the wave-intercepting antenna-wire A, and all the wires may be retained in their cooperative relations by a retaining device consisting of the wooden arms D forming a cross, with a central insulator I' for the reception of the antenna-wire A. The outer ends of the arms D may be adapted to engage around the grooves U (Figs. 2 and 3) in the insulators I, to assist in maintaining the rigidity of the structure.

This aerial structure is somewhat more expensive than that heretofore used, but this disadvantage is slight as compared with the offsetting advantage of preventing the static troubles which frequently result in complete inoperativeness of an installation.

I claim—

1. In systems of wireless communication, means for shielding the wave-interceptor

from static discharges, which means consists of a conductor having impedance and non-inductive resistance connected to it.

2. In systems of wireless communication, means for shielding the wave-interceptor from static discharges, which means consists of a conductor having connected with it a plurality of impedance-coils and non-inductive resistances.

3. In systems of wireless communication, means for shielding the wave-interceptor from static discharges, which means consists of a conductor having connected with it an iron impedance-coil and a non-inductive resistance.

4. In systems of wireless communication, means for shielding the wave-interceptor from static discharges, which means consists of a conductor having connected with it an impedance-coil and a carbon resistance.

5. In systems of wireless communication, means for shielding the wave-interceptor from static discharges, which means consists of a conductor having connected with it an iron impedance and a carbon resistance.

6. In systems of wireless communication, means for shielding the wave-interceptor from static discharges, which means consists of a conductor having connected with it a plurality of iron impedance-coils and non-inductance resistances.

7. In systems of wireless communication, means for shielding the wave-interceptor from static discharges, which means consists of a conductor having connected with it a plurality of impedance-coils and carbon resistances.

8. In systems of wireless communication, means for shielding the wave-interceptor from static discharges, which means consists of a conductor having connected with it a plurality of iron impedance-coils and carbon resistances.

9. In systems of wireless communication, means for shielding the wave-interceptor from static discharges, which means consists

of a conductor connected to earth and having connected with it an impedance-coil and a non-inductance resistance.

10. In systems of wireless communication, means for shielding the wave-interceptor from static discharges, which means consists of a conductor located in proximity to the interceptor and containing ohmic and reactive impedance.

11. In systems of wireless communication, means for shielding the wave-interceptor from static discharges, which means consists of a conductor having connected in it in series an impedance-coil and a non-inductive resistance.

12. In systems of wireless communication, means for shielding the wave-interceptor from static discharges, which means consists of a plurality of conductors arranged about the interceptor, said conductors having connected with them respectively an impedance-coil and a non-inductive resistance.

13. An aerial structure for systems of wireless communication, which comprises the wave-intercepting conductor; a plurality of static-shield conductors arranged about said wave-intercepting conductor, each including an impedance-coil and a non-inductive resistance; and a retaining member to maintain all the conductors in cooperative relationship.

14. An aerial structure for systems of wireless communication, which comprises the wave-intercepting conductor; a plurality of static-shield conductors arranged about said wave-intercepting conductor and each including an impedance-coil and a non-inductive resistance; insulating-shields for the devices in the static-shield conductors; and a retaining member connected with said insulating-shields to maintain all the conductors in cooperative relationship.

GREENLEAF WHITTIER PICKARD.

Witnesses:

EDWARD H. ROWELL,
MYRA S. ROWELL.

1,175,418.

R. A. FESSENDEN.
WIRELESS TELEGRAPHY.
APPLICATION FILED FEB. 2, 1910.

Patented Mar. 14, 1916.
10 SHEETS—SHEET 9.

Fig. 14

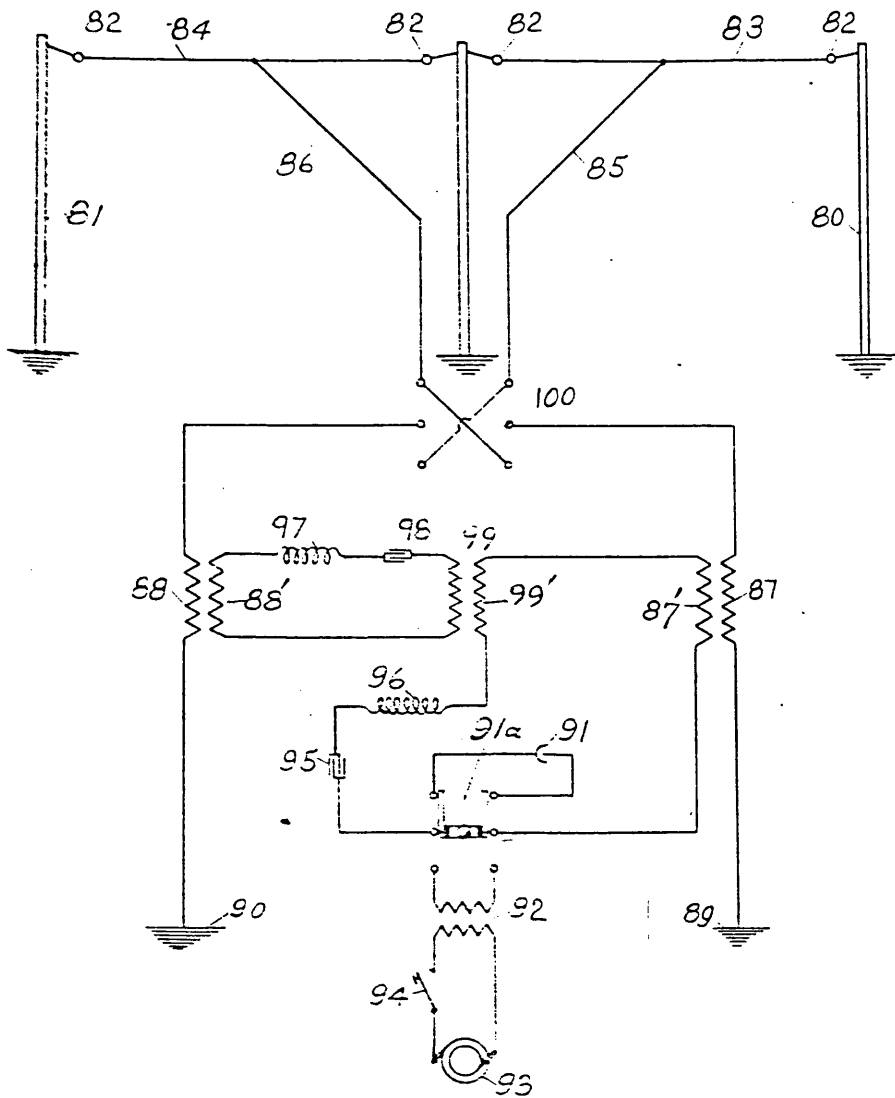

Reginald A. Fessenden,
Inventor.

Witnesses
Charles E. Spley.
Ernest S. Paul.

By Attorney *J. W. H. Cley*

Fig. 15

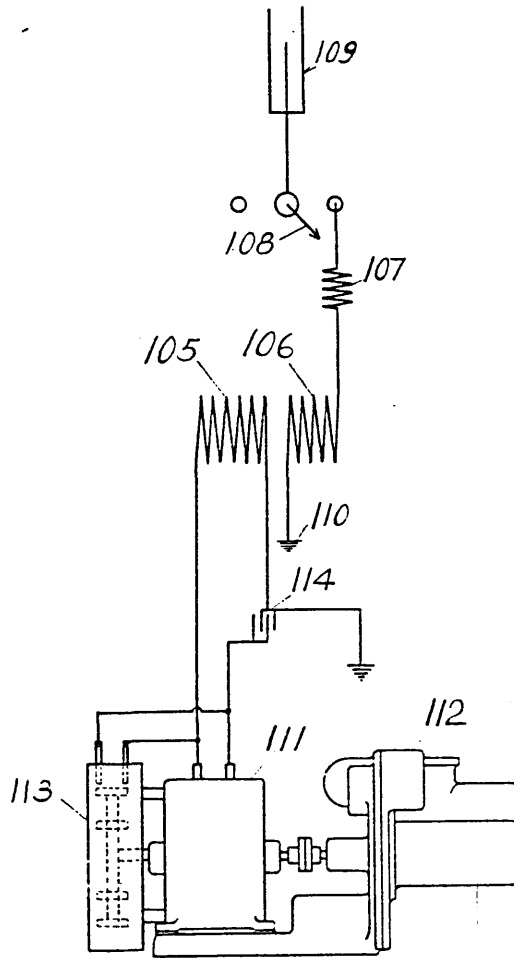

R. A. Fessenden

Inventor

Witnesses:
Jesse C. ...
...

being used. A protection gap 35 may be used as a discharge gap to protect the condensers. This may be cut out of action by throwing the switch 32 to the position shown in dotted lines 31. 30 and 36 are relays for closing the circuit between the secondary of the transformer 19, 19', and the electrodes 40 and 37 of the spark gap 46. When 30 and 36 are closed a discharge takes place at every half period between the stationary electrodes 37, 38, 39, 40 and a rotating disk 41, of spark gap 46; and when relays 30 and 36 are open the discharge takes place only once every period. Consequently by operating a key 25, which controls the current from a battery 24 through the relays 30 and 36, the discharge may be made to occur say 1000 times per second when the key 25 is open and 500 times per second when the key is closed. By this means the dots and dashes for signaling may be made to have a note of 1000 per second and the spaces a note of 500 per second. The tips of the electrodes of the spark gap, as shown at 43, may be made of water cooled disks, shown in detail in Figs. 3 and 4. For this purpose I use a cooling coil 44 and a circulating pump 45. The rotating spark gap may be inclosed in the casing 46' and the rotating disk 41 may be keyed on to the shaft 42 of the alternator 11. In Fig. 1 is shown also an antenna 26, grounded at 29, and operatively connected to the secondary 28 of the transformer 28, 28', shown in detail in Figs. 3 and 9. 27 represents an antenna inductance for varying the tune; it is shown in detail in Figs. 10 and 11, 12 and 13.

Fig. 2 shows a partial side elevation of the spark gap, in which 46' is the outside casing, 41 the rotating disk, 37 an electrode, 1 the generator, 47 a hand-wheel carrying a screw and nut 48 whereby the case 46' and electrode 37 may be rotated and shifted in position with reference to the dynamo 11 so as to cause the spark to be produced at the proper point of the potential curve.

In Figs. 3 and 4 showing the details of the stationary electrodes, 43 is a water cooled disk, made hollow as shown and milled so as to be generally round on its circumference but to have its surface consist of a number of plane faces. This is found to be advantageous for insuring the constancy of the spark. The disk 43 has a hollow axle 49 leading to the circulating pump 45 shown in Fig. 1, and 50 is a tube for projecting the water to the point of the disk 43 nearest the point where the spark takes place between it and the rotating disk 41.

In Figs. 5 and 6 showing the relays such as at 30 in Fig. 1, 51, 52 represent fixed jaws, and 53, 54 the movable jaws of the relay. 55 is a movable plunger for opening

the relay and 56 an adjusting spring for closing it. 57 is a headed bolt attached to the movable jaws 53, 54, whereby, by adjusting the cooperating threaded bolt 58, the movable plunger 55 may be made to move a greater or less distance before retracting the movable jaws 53, 54, thereby making the break more or less rapid.

In Fig. 7 showing in detail a form of key 17 in Fig. 1, 60 is a metallic casing inclosing the key proper, 59, and acting as a shield to prevent any electrostatic disturbances produced by opening and closing of the key from affecting the receiver, and a wire netting 62 forms a screen over the whole device, lead covered cables 60, 61, connecting key 59 and leading outside the wire netting so that no operation of the key 59 will produce any electrical disturbances outside the screen.

In Figs. 8 and 9 showing the sending transformer 28, of Fig. 1, the primary and secondary are formed of strips of copper 63, 64, wound edgewise and supported on insulating frames 65, 66. The transformer may be made in round sections, or square sections as here shown. The primary 63 and secondary 64 are preferably made adjustable to and from each other by sliding on the axis 67. By constructing the transformer out of strips in the fashion shown a very great advantage is obtained over the use of cylindrical forms, as by this means the windings may be brought much closer to each other while still leaving the distance between turns the same, and since the inductance varies as the square of the number of turns per inch, the total length of wire may be very greatly reduced and the size of the inductance may be made very much smaller. Moreover, the mutual inductance between the primary and secondary may be made very much greater than in the case where the round conductors or tubes are used.

Figs. 10 and 11 show one form of the antennæ inductance 27 of Fig. 1. In this form I use two spirals of flat iron wound edgewise. A trolley bar 68 bridges across the two spirals 101, 102, and slides on a rod 69 when these spirals are revolved on their shafts 103, 104 which are connected together by sprocket chain 70 so that when the pulley 71 is rotated both spirals 101 and 102 are moved in the same direction and the bridging trolley bar 68 is caused to move backward or forward and thereby include a greater or less number of turns between the coil terminals 72, 73. This is very advantageous for tuning, and moreover the tuning can be accomplished without chance of the operator being injured, while the spark is passing.

Figs. 12 and 13 show another form of antenna inductance in which I use a single

coil 74, inside of which are a number of disks 75, 75, 75. These disks are pivotally mounted on pins 76, 76, engaging frame 105, and attached to an insulating connecting bar 77, so that on rotating the handle 78 attached to one of the disks the inclination of all the disks to the surrounding coil 74 may be varied. When the disks 75 are in planes parallel to the planes of the turns of coil 74 the inductance in the coil 74 is largely annulled. When the handle 78 is turned so that the disks 75 are in a different plane to that of the turns of coil 74 the inductance of 74 is not annulled and is larger than before. In this way very exact tuning can be had.

In Fig. 14 showing an antenna and connections for same, 80 and 81 represent masts, 82, 82, 82, 82, insulators, and 83, 84 horizontal conductors such as shown in applicant's U. S. Patent No. 706,738, of August 12th, 1902. In these a long wave arriving from the side 83 for example will produce an effect in 83 of a different phase from that produced in 84, and a maximum effect will not be obtained. For this reason I lead the current from 83, 84 by means of conductors 85, 86, preferably attached to about the middle of the conductors 83, 84, and connect these leads 85, 86 operatively to the circuit containing the receiving or transmitting apparatus in such a way as to correct this difference of phase, and in such a way that this correction will be effected when the waves are arriving from one direction and preferably not when they are arriving from any other direction. I accomplish this by leading the conductors 85, 86 through the switch 100 and the transformers 87, 88 to ground at 89, 90. The transformer 87, 87' is connected preferably directly by means of the double throw switch 91 to the receiver 91, or to the sending transformer 92, 93 being a high frequency alternator and 94 a sending key, 95 a capacity and 96 an inductance. A transformer 88, 88' is connected to a second circuit containing the inductance 97 and capacity 98, and this circuit in turn is inductively connected by means of the transformer 99, 99' to the circuit containing the capacity 95, inductance 96 and secondary 87'. In this way, by adjusting the coupling, turns, and electrical constants of the transformer 87, the transformers 99 and 88 are able to cause the effects produced by the currents in the conductors 85 and 86 to coincide in phase. Thus by means of the reversing switch 100 I am able to arrange it so that the phase relation may be correct for waves arriving or being sent out from the side 83 of the antenna, or for waves arriving or being sent out from the side 84.

In Fig. 15 is shown another arrangement. Here 112 is a steam turbine; 111 is a 500 cycle dynamo, 113 a rotary spark gap, 114

a condenser, 105 a primary of a transformer, 106 the secondary of the transformer, grounded at 110, 107 a tuning inductance, 108 a switch and 109 an antenna. A relatively low voltage, preferably not exceeding 5,000 or 6,000 volts, is used on the rotary spark gap 113 and preferably no transformer is used, (though one may be used if desired) the dynamo 111 generating a voltage of 5,000 volts or 6,000 volts directly by its armature windings. This is found to give a higher efficiency not only by doing away with the losses in the transformer but also for other reasons which are not as yet fully known, but which have been experimentally demonstrated and which partly result in increased efficiency in the spark in doing away with the brush discharges, etc.

By means of adjusting the rotary spark gap herein disclosed and also by the form of electrodes disclosed I am enabled to obtain very high efficiency and to obtain a power factor as high as 96 or 98 per cent. from the generating apparatus, and this with large amounts of power. By means of the other devices shown herewith I am enabled to handle and utilize these large amounts of power in such a way as to obtain great efficiency of operation. For example, the flat strip inductances and transformer enable me to get the necessary amount of inductance for tuning with but a small fraction of the ohmic resistance necessary in the case of inductances or transformers formed of cylindrical conductors.

By mounting the rotary gap housing on the end of the generator itself I am enabled to avoid the possibility of angular displacement which is apt to occur when the housing and dynamo have separate foundations.

By forming a discharge gap 35 of balls having a very large diameter in proportion to the distance between them I am able to get a relief gap which breaks down at practically the same potential for high frequency discharges as for low and also one whose discharge voltage is practically independent of the time which the voltage is applied.

Having thus described my invention and illustrated its use, what I claim as new and desire to secure by Letters Patent, is the following:

1. In wireless telegraph apparatus, the combination of an oscillating circuit containing a spark gap with a plurality of stationary terminals, a generator, a movable member of the spark gap mounted on a rotating part of the generator, and means to change the spark frequency for signaling, by cutting out some of the stationary terminals of the spark gap.

2. In wireless telegraph apparatus, the combination with an oscillatory circuit containing a spark gap with several stationary

terminals, of a generator, a rotating part of the generator forming one member of the spark gap and means to adjust the position of the stationary sparking electrode to vary the sparking point on the potential curve, and key operated means to change the spark frequency.

3. The combination with an oscillating circuit having a plurality of stationary terminals forming electrodes of a spark gap therein, of a series of rotating elements forming one electrode, said stationary terminals containing cooling means, a surrounding casing around the revolving element and the series of stationary terminals protruding therein, and electrically operated means to change the number of active terminals.

4. Apparatus for wireless telegraphy, comprising the combination of a generator circuit, inductance therefor, an oscillatory circuit including a rotary spark gap, an aux-

iliary protective discharge gap, a switch to alter the amount of said inductance, and said inductance being formed of flat strips to provide for low ohmic resistance.

5. In high powered wireless telegraph apparatus, the combination with an oscillating circuit containing a rotary spark gap, a condenser, inductance, a protective spark gap around the rotary gap and a secondary of a transformer, of a generator, a circuit containing the primary of said transformer, an extra inductance, and a key arranged to alter the effect of said inductance for signaling, substantially as described.

In testimony whereof I have hereunder signed my name in the presence of the two subscribed witnesses.

REGINALD A. FESSENDEN.

Witnesses:
 JESSIE E. BENT,
 FLORENCE M. LYON.

Copies of this patent may be obtained for five cents each, by addressing the "Commissioner of Patents, Washington, D. C."

J. H. ROGERS & H. H. LYON.
WIRELESS SIGNALING SYSTEM.
APPLICATION FILED NOV. 10, 1916.

1,220,005.

Patented Mar. 20, 1917.

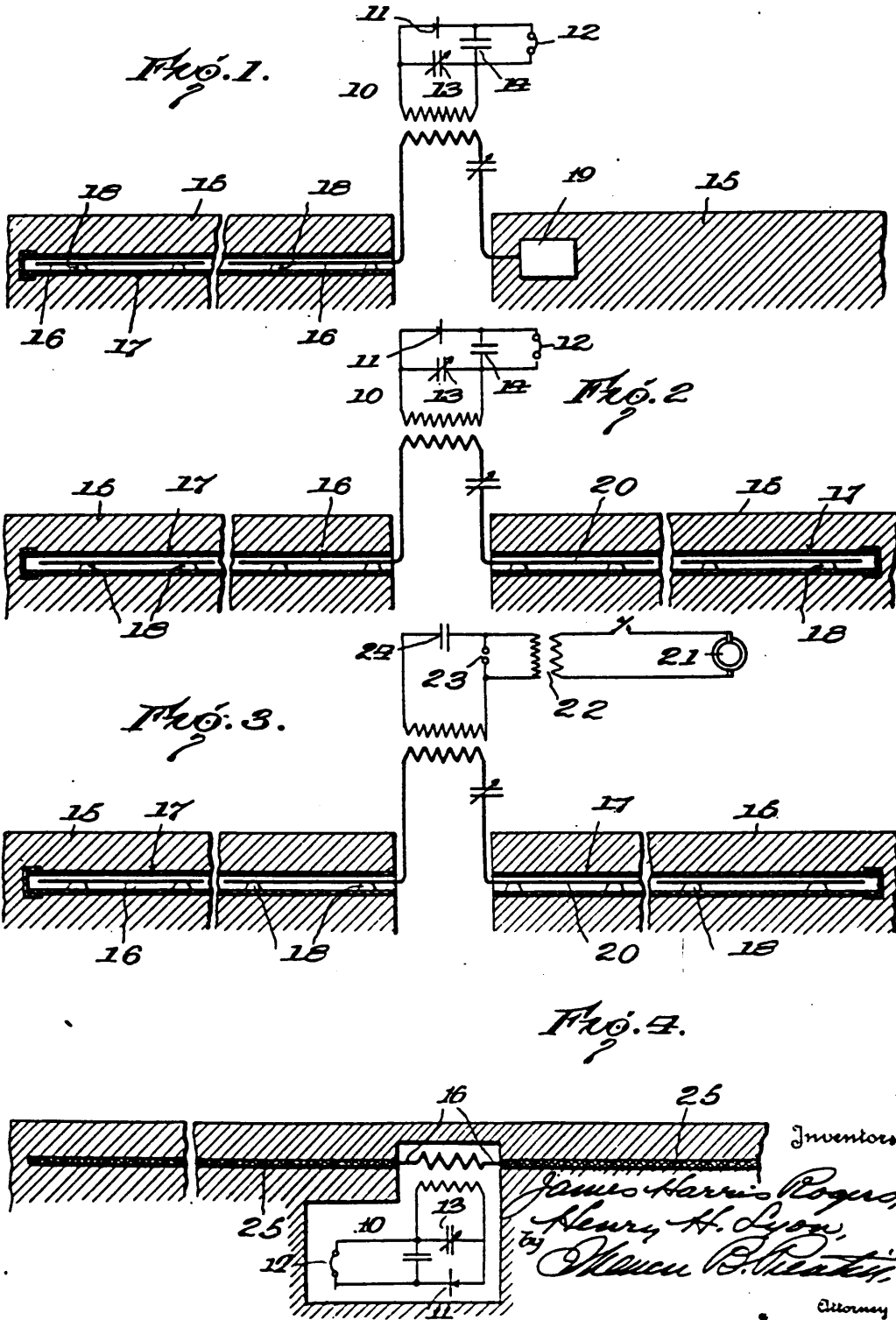

Inventors
James Harris Rogers,
Henry H. Lyon,
By *Maxwell B. Heath*
Attorney

UNITED STATES PATENT OFFICE.

JAMES HARRIS ROGERS AND HENRY H. LYON, OF HYATTSVILLE, MARYLAND.

WIRELESS SIGNALING SYSTEM.

1,220,005.

Specification of Letters Patent. Patented Mar. 20, 1917.

Application filed November 10, 1916. Serial No. 130,402.

To all whom it may concern:

Be it known that we, JAMES H. ROGERS and HENRY H. LYON, citizens of the United States, residing at Hyattsville, in the county of Prince Georges and State of Maryland, have invented new and useful Improvements in Wireless Signaling Systems, of which the following is a specification.

Our invention relates to the transmission of electrical impulses or oscillations to a distance, primarily for the purpose of conveying intelligence, and it pertains to means for both sending and receiving.

In systems of wireless sending and receiving now in general use, one or more conductors or capacities are employed disposed above the surface of the earth, which conductors or capacities serve to radiate or receive the impulses in the sending or receiving of messages. Such elevated conductors are costly to erect and maintain, as to obtain efficiency and long-distance transmission it is necessary to have them at considerable distances above the surface of the earth. This necessitates expensive towers and masts, and moreover both the conductors and the towers or masts are exposed to weather conditions—wind storms, lightning, snow and ice—which often impede or entirely prevent the operative use of the system. We are aware that it has been proposed also to employ a conductor elevated above the earth in connection with a buried conductor.

Our invention has for its principal object the provision of a system not subject to the above objections; a system in which the communication, both sending and receiving, is clear and effective; in which the communication is selective and the direction of transmission may be readily determined; in which multiple transmission may be effected; and in which the sending and receiving of messages to and from stations on land and on water may proceed independent of weather conditions.

We have discovered that signals can be sent and received with great facility by the employment of wires buried beneath the surface of the earth but insulated therefrom substantially throughout their length and extending in direction substantially parallel to the earth's surface, so that while the wires are not in direct contact with the earth they are intimately associated therewith.

The invention consists in the novel features and combinations of circuits and appa-

ratus in the wireless signaling system hereinafter described and claimed, and illustrated in diagram in the accompanying drawings, in which—

Figure 1 is a system in which a single antenna is shown below the surface of the earth, but insulated therefrom by being mounted within a conduit;

Fig. 2 is a similar view showing two antennæ extending in opposite directions;

Fig. 3 is a view similar to Fig. 2, but with the instruments of a sending station; and

Fig. 4 is a similar view showing in whole lines the antennæ consisting of insulated wire buried below the surface of the ground.

Referring to the drawings, signal instruments are indicated at 10, and in Figs. 1 and 2 are those of the receiving station, while in Fig. 3 the instruments of a sending station are shown. In Figs. 1 and 2, 11 is a detector of any type, preferably an audion, 12 a telephone, and 13 and 14 are the usual condensers. Any desired type of instruments and arrangement of connecting circuits may be employed.

The surface of the earth is indicated at 15, and the antenna at 16. This latter extends in a direction substantially horizontal, and as shown in the figures is preferably buried below the surface of the earth. Referring particularly to Fig. 1, the antenna is mounted within a conduit or pipe 17, preferably of any suitable non-conducting material such as terra cotta. The mounting within the conduit may be of any preferred type, that shown being by mounting the antenna upon a series of lugs or projections 18 extending upwardly from the bottom of the conduit. From the end of the conduit connection is made between the antenna and the signal instruments. The antenna is thus intimately associated with the earth throughout its length but is insulated therefrom and, it is believed, a considerable portion of the earth's surface about the antenna thus cooperates with the latter in sending or receiving oscillations.

The cooperation of the antenna with a ground connection or a second antenna is desirable for proper transmission or reception of signals, and in Fig. 1 we have therefore shown the other side of the instruments connected to ground plate 19.

Fig. 2 is an embodiment of the invention in which two antennæ are employed extending in opposite directions, the second an-

60

65

70

75

80

85

90

95

100

105

110

tenna 20 being connected in place of the ground plate shown in Fig. 1. This arrangement is more effective than with the use of the ground plate.

5 In order to obtain the maximum efficiency it is desirable to have the antennæ disposed in a line at right angles to the wave fronts, and in order that this may be accomplished for the different directions a plurality of
10 antennæ are employed extending outwardly in different directions but substantially horizontal and parallel to the surface of the earth, and under the surface as already explained. This arrangement is fully set forth
15 in our application Serial No. 130,803, filed November 10, 1916, to which reference is made for complete details. It is therefore thought unnecessary to illustrate or describe such arrangements in the present applica-
20 tion.

Fig. 3 shows the same arrangement as Fig. 2, but with sending instruments instead of receiving instruments. These latter comprise a generator 21, transformer 22, spark
25 gap 23 and condenser 24. Any other sending arrangement and instruments may be employed instead of those shown.

Referring now more particularly to Fig. 4, in place of the conduit or pipe, an ordinary insulating envelop for the antenna is shown at 25, and for this purpose the antenna may be an ordinary insulated wire of the proper size and length. It may be buried
30 beneath the surface of the earth, as already explained.

The invention is also applicable to the surface of the earth where there is water. For instance, on the sea coast the antennæ may be run out from the shore into the
40 water, and although insulated from the latter it is so closely associated therewith that there is a coöperation between the antenna and the surrounding water in the sending and receiving of oscillations. The insulated
45 antenna may also be employed for sending and receiving signals to and from vessels in the manner fully set forth in our above mentioned application, it being believed unnecessary to fully describe these arrangements
50 here.

In accordance with the patent statutes we have described what we now believe to be the best embodiment of the invention, but we do not wish to be understood thereby as
55 limiting ourselves or the scope of the invention, as many changes and modifications

may be made without departing from the spirit of the invention and all such we aim to include in the scope of the appended claims.

For instance throughout the several figures, the signal instruments are shown associated with the antenna or antennæ by indirect coupling, but may be associated therewith in any other manner desired.

It will be seen also that while the signal instruments are shown diagrammatically above the earth, they will in practice often be actually located in a pit below the ground level or entirely underground between the
70 antennæ, as shown in Fig. 4. When the antennæ are entirely underground, the effects of lightning on the receiving of signals are nearly eliminated, so that only slight clicks are heard instead of loud prolonged
75 hissing.

It will be understood that the system works with either sustained oscillations or damped wave trains.

What we claim and desire to secure by
80 Letters Patent of the United States, is—

1. A wireless transmission and reception system comprising an antenna extending in direction substantially parallel to and buried
85 under the surface of the earth but insulated therefrom substantially throughout its length.

2. A wireless signaling system comprising electromagnetic wave signal instruments, an antenna extending outwardly therefrom, a
90 second antenna extending in the opposite direction, said antennæ being parallel to and buried under the surface of the earth but insulated therefrom substantially throughout their length, said instruments being connect-
95 ed between said antennæ.

3. A wireless transmission and reception system comprising an antenna extending in direction substantially parallel to and buried
100 under the surface of the earth and a conduit in which said antenna is insulated substantially throughout its length from the earth.

In testimony whereof we have hereunto set our hands in presence of two subscribing
105 witnesses.

JAMES HARRIS ROGERS.
HENRY H. LYON.

Witnesses:
JOHN GIBSON,
S. WILLIAM FORD.

J. H. ROGERS.
WIRELESS SIGNALING SYSTEM.
APPLICATION FILED JAN. 10, 1919.

1,303,789.

Patented May 13, 1919.

Fig. 1.

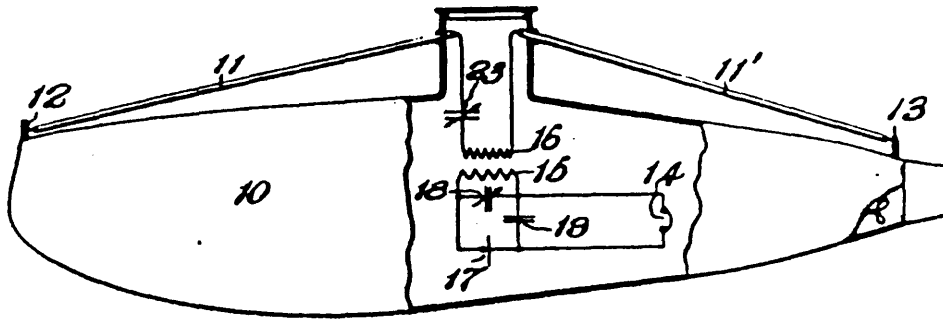
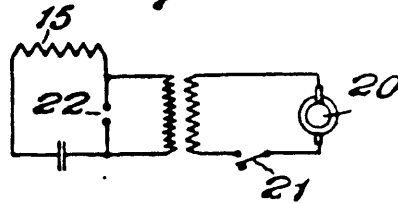

Fig. 2.



Inventor
James Harris Rogers,
284
Owen E. Heater,
Attorney

UNITED STATES PATENT OFFICE.

JAMES HARRIS ROGERS, OF HYATTSVILLE, MARYLAND.

WIRELESS SIGNALING SYSTEM.

1,303,729.

Specification of Letters Patent. Patented May 13, 1919.

Application filed January 10, 1918. Serial No. 370,556.

To all whom it may concern:

Be it known that I, JAMES HARRIS ROGERS, a citizen of the United States, residing at Hyattsville, in the county of Prince Georges and State of Maryland, have invented new and useful Improvements in Wireless Signaling Systems, of which the following is a specification.

My invention relates to radio signaling, and has for its object the provision of an improved system for use in connection with vessels, particularly submarines.

The invention comprises the employment of an insulated radio conductor or antenna suitably mounted upon the submarine but insulated therefrom except at the outer ends where it is in electrical connection with the metallic body of the vessel. Electromagnetic wave sending and receiving instruments are arranged to be associated with the said conductor at a point intermediate its ends, in any suitable manner.

The invention consists in the novel system, and arrangement of apparatus and circuits hereinafter described and claimed, and shown in the accompanying drawings, in which drawings—

Figure 1 shows a submarine vessel equipped with the invention, a portion of the vessel being in section, and the wireless apparatus and circuits for receiving messages being diagrammatic;

Fig. 2 is a diagrammatic view of conventional sending apparatus and circuits for use with the system of Fig. 1 for the purpose of sending signals.

Referring to the drawings, 10 indicates the metallic hull of a submarine vessel, which may be of any type or construction, 11, 11' indicate an insulated radio conductor so mounted as to be electrically insulated from the vessel and the water except at its outer ends where the portion 11 is connected at 12 to the bow of the hull and portion 11' is connected at 13 to the stern of the hull.

Associated with the radio conductor, preferably at some point between its ends, are electromagnetic signal instruments. As shown conventionally, receiver 14 is in circuit with winding 15 of an inductive coupling of which the other winding 16 is connected to the radio conductor 11, 11'. 17 is the usual detector, which may be an audion, and 18 and 19 are the usual condensers.

Sending instruments and circuits for use with the system are shown in Fig. 2, wherein

20 is a source of current, 21 a key, and 22 a spark gap in an oscillating circuit which includes winding 15 of the coupling. This sending apparatus is of course on the vessel.

Any desired electromagnetic wave signal instruments may be employed, those shown being merely illustrative.

From the foregoing it will be seen that the radio conductor constitutes with the electrical connection through the vessel a loop oscillating circuit which will oscillate in response to electromagnetic waves being received, or set up by the sending instruments. A suitable tuning condenser 23 is provided to tune this oscillating circuit to the proper frequency. It will also be observed that the radio conductor is carefully insulated throughout its length between its ends, so that it cannot make electrical connection with the vessel, or the water when the submarine is submerged.

While I have described a specific embodiment of the invention, this is only by way of illustration, and it will be understood that modifications may be made without departing from the invention. For instance, the electrical connection between the ends of the radio conductor may be made by a metallic conductor other than the hull of the vessel.

I claim:

1. The combination with a vessel, of a radio conductor extending longitudinally thereof but insulated therefrom and from the water except at its ends which make electrical connection with the vessel, an electrical connection between said ends of the radio conductor through said vessel, and electromagnetic signaling instruments associated with said radio conductor at a point between its ends.

2. The combination with a submarine vessel having a metallic hull, of an insulated radio conductor extending longitudinally thereof and connected electrically at its ends with said hull, whereby a loop oscillating circuit is provided, and electromagnetic signaling instruments associated with said looped oscillating circuit.

3. The combination with a submarine vessel having a metallic hull, of an insulated radio conductor extending longitudinally thereof and connected electrically at its ends with said hull, whereby a loop oscillating circuit is provided, a tuning condenser in said oscillating circuit, and electromagnetic

signaling instruments associated with said looped oscillating circuit.

4. The combination with a submarine vessel having a metallic hull, of an insulated radio conductor extending longitudinally thereof and connected electrically at its ends with said hull, whereby a loop oscillating

circuit is provided, electromagnetic signal instruments associated with said radio conductor between its ends, and a tuning condenser in circuit with said conductor. 10

In testimony whereof I have hereunto set my hand.

JAMES HARRIS ROGERS.

Copies of this patent may be obtained for five cents each, by addressing the "Commissioner of Patents, Washington, D. C."

J. H. ROGERS.
 RADIOSIGNALING SYSTEM.
 APPLICATION FILED JAN. 11, 1919.

1,303,730.

Patented May 13, 1919.

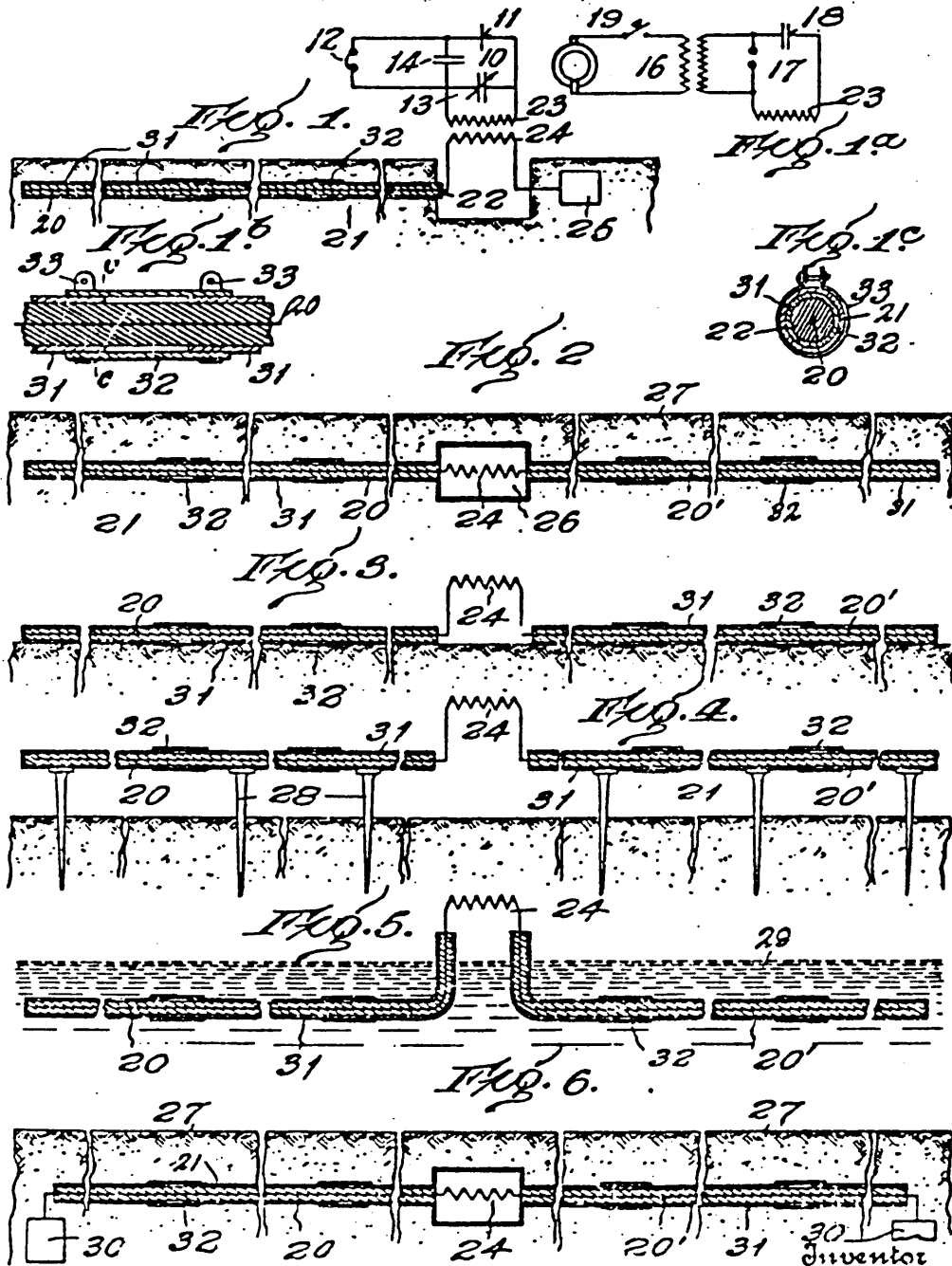

Inventor
 James Harris Rogers,
 211
 Mervin B. Weston,
 Attorney

UNITED STATES PATENT OFFICE.

JAMES HARRIS ROGERS, OF HYATTSVILLE, MARYLAND.

RADIOSIGNALING SYSTEM.

1,303,730.

Specification of Letters Patent. Patented May 13, 1910.

Application filed January 11, 1910. Serial No. 270,603.

To all whom it may concern:

Be it known that I, JAMES HARRIS ROGERS, a citizen of the United States, residing at Hyattsville, in the county of Prince Georges and State of Maryland, have invented new and useful Improvements in Radiosignaling Systems, of which the following is a specification.

My invention relates to radio signaling systems and apparatus for sending and receiving signals through space by means of electromagnetic waves, and it relates particularly to that portion of such systems known as the antenna.

I have discovered that radio conductors or antennae are highly efficient when disposed horizontally or substantially parallel to the surface of the earth but completely insulated therefrom and inclosed in an inclosing metallic covering, screen or casing practically throughout their entire length, but insulated therefrom. The metallic covering thus inclosing the antenna, but from which the latter is insulated, takes up the electromagnetic waves, in receiving, and transmits them to the antenna within at full strength and even with greater effect than when the antenna is used without the covering. A highly efficient action is thus obtained, the static is reduced, and at the same time the antenna is fully protected from deterioration by the corroding action of earth and water.

In such a system it has been found necessary, in order to obtain the best results, to employ radio conductors and casings of very considerable length, that is, 250 feet, 500 feet, 1,000 feet, or even 5,000 feet or more in length. With the use of such long conductors and casings, however, it is found that the static increases in proportion to the length, that is, as the length of conductor and casing increases, the static increases in about the same proportion, and this increase in the static prevents obtaining the best results.

Now, it is the object of the present invention to reduce the proportion which the static bears to the length of the radio conductor employed. A further object is to render possible the employment of longer radio conductors or antennae in proportion to the incoming wave length.

In carrying the invention into effect the metallic covering, screen or casing of the radio conductor or antenna is made sectional, the sections being insulated from each other by rubber hose, such as garden hose, or equivalent.

The invention consists in the novel construction and arrangement of apparatus and parts thereof for sending and receiving radio signals hereinafter described and claimed, and illustrated in the accompanying drawings, in which drawings—

Figure 1 is a diagrammatic view showing the antenna buried beneath the surface of the earth, receiving instruments being associated with the antenna;

Fig. 1^a shows a conventional arrangement of sending instruments which may be substituted for the receiving instruments for transmitting signals, it being understood that either the sending or receiving instruments shown in Fig. 1 are to be used in connection with the arrangements shown in the remaining figures;

Fig. 1^b is a longitudinal section of one of the couplings or section connections, shown on an enlarged scale;

Fig. 1^c is a transverse section taken on the line c-c of Fig. 1^b;

Fig. 2 is a view similar to Fig. 1 showing two antennae extending in opposite directions beneath the surface of the earth, the connection for signaling instruments being located between the antennae and also beneath the surface of the earth;

Fig. 3 is a view similar to Fig. 2 but showing the antenna resting upon the surface of the earth with the signal instruments upon or above the surface;

Fig. 4 is a view similar to Fig. 3 but showing the antennae supported above the surface of the earth but in close proximity thereto;

Fig. 5 is a view similar to Fig. 2 in which the antennae are shown submerged in water.

Fig. 6 is a view similar to Fig. 2 showing a modification.

Referring to the drawings, 10 indicates the signal instruments, which in Fig. 1 are those for receiving signals, while in Fig. 1^a the instruments for sending signals are shown. In Fig. 1, 11 is a detector of any type, preferably an audion, 12 a telephone, and 13 and 14 the usual condensers. Any

desired type of instruments and arrangement of connecting circuits may be employed.

In Fig. 1^a suitable sending instruments are conventionally shown. These comprise a generator 15, transformer 16, spark gap 17, condenser 18 and key 19.

The above-mentioned instruments are well known in the art of radio or magnetic wave signaling, and need not be further described. 20 is an antenna for radiating or receiving electromagnetic waves, and as shown in Fig. 1 extends horizontally or substantially parallel to the earth's surface and buried in the earth. This antenna may be of any suitable or desired length, and is completely inclosed within a metallic covering, casing or screen 21 which may be a tube or pipe of lead, iron or any other suitable metal. The antenna is insulated from the metallic covering or casing by means of insulation 22. It will thus be seen that while the antenna is buried in the earth it is completely insulated therefrom and from the metallic covering or casing.

The receiving instruments shown in Fig. 1 are associated with the antenna by means of an inductive coupling comprising windings 23 and 24 of a transformer, but may be associated therewith in any other suitable manner. The other terminal of winding 24 of the coupling is connected to ground at 25.

In the embodiment of the invention shown in Fig. 2 the ground connection is replaced by a second antenna 20' extending in a direction different from the direction of antenna 20, the signal instruments being connected between the antennae as indicated by the winding 24 of the inductive coupling. In this figure also is shown the arrangement by which the signal instruments are located in the chamber 26 below the surface of the earth.

Fig. 3 shows an arrangement similar to Fig. 1 but with the employment of a second antenna 20' in place of the ground connection shown in Fig. 3.

Fig. 4 shows an arrangement similar to Fig. 3, but with the antennae slightly elevated above the surface of the earth by means of struts or pins 28. Thus while the antennae extend substantially parallel with the surface of the earth, the metallic covering or casing is not in direct contact with the earth but is separated therefrom by a short space. It may or may not be insulated from the earth according to the material of which the struts or pins 28 are made, that is whether they are of conducting or of non-conducting material.

Fig. 5 shows the employment of two antennae submerged beneath the surface of the earth where there is water, the water being indicated at 29. Here the metallic covering or casing is in contact with the water, but

the antennae and their connecting circuits are insulated from the water.

Fig. 6 shows the employment of ground connections 30 for the outer ends of the antennae.

In order to reduce the static, as above indicated, the casing 21 is divided into sections 31, which sections may be of any desired length, preferably very short, such as sixteen feet for instance. This particular length is suggested for the reason that it is the length of ordinary iron pipe which may be used for the purpose. The sections 31 are connected to each other by insulating couplings 32, which may be made of rubber hose clamped to the metallic sections by clamps 33 or other suitable means.

Careful tests and experiments have shown that by the employment of sectional metallic casing in intimate contact with the earth but insulated from the radio conductor or antenna, the sections of the casing being insulated from each other and connected by couplings of insulating material, very much longer antennae may be employed than is possible with the continuous metallic casing. Also, when comparing the use of antennae of the same length, the static is much less with the sectional casing.

It will be understood that while I have shown and described arrangements embodying my invention in which one antenna and also two antennae are employed, any desired number may be used, and it is desirable to have them extend in the proper direction to obtain the maximum effect both in sending and receiving of the electromagnetic waves. For this purpose a number of antennae may be employed radiating in different directions from the instruments, and suitable switching mechanism may be provided for connecting any one or more of the antennae to the signal instruments. Such an arrangement is shown and described in the pending application of myself jointly with Henry H. Lyon, S. No. 130,603, to which reference is here made for further details, so that it is unnecessary to describe such an arrangement in this application.

It has been stated that the invention is applicable to the surface of the earth where there is water, one such application being illustrated in Fig. 6. It will be understood also that the invention is also applicable to ships at sea, but as the employment of my new antenna arrangement in such connection is obvious it is thought that illustration is unnecessary.

In accordance with the patent statutes I have described what I now believe to be the best embodiment of the invention, but I do not wish to be understood thereby as limiting myself or the scope of the invention, as many changes and modifications may be made without departing from the spirit of

the invention and all such I aim to include in the scope of the appended claims.

What I claim as new and desire to secure by Letters Patent of the United States is:

1. A radio signaling system comprising an antenna extending horizontally substantially parallel to the surface of the earth and insulated therefrom, a metallic covering comprising sections insulated from each other and inclosing said antenna throughout its length but insulated therefrom, and signal instruments associated with said antenna.
2. A radio signaling system comprising an antenna extending horizontally substantially parallel to the surface of the earth, a metallic covering comprising short sections connected by couplings of insulating material and inclosing said antenna but insulated therefrom, and signal instruments associated with said antenna.
3. A radio signaling system comprising an antenna extending horizontally substantially parallel to the surface of the earth, a metallic covering comprising sections insulated from each other and inclosing said antenna but insulated therefrom and in contact with the earth substantially throughout its length, and signal instruments associated with said antenna.
4. A radio signaling system comprising an antenna extending horizontally substantially parallel to the surface of the earth, a metallic covering for said antenna comprising sections insulated from each other and inclosing said antenna but insulated therefrom, said metallic covering being buried in the earth with its sections in intimate contact therewith, and signal instruments associated with said antenna.
5. A radio signaling system comprising signal instruments, an antenna extending outwardly therefrom, a second antenna extending in a different direction, said antennae being substantially parallel to the surface of the earth but insulated therefrom and said instruments being connected between said antennae, and a metallic covering for each of said antennae comprising sections insulated from each other and inclosing the antenna throughout its length but insulated therefrom.

In testimony whereof I have hereunto set my hand.

JAMES HARRIS ROGERS.

J. H. ROGERS.
 RADIOSIGNALING SYSTEM.
 APPLICATION FILED JAN. 17, 1918.

1,315,862.

Patented Sept. 9, 1919.

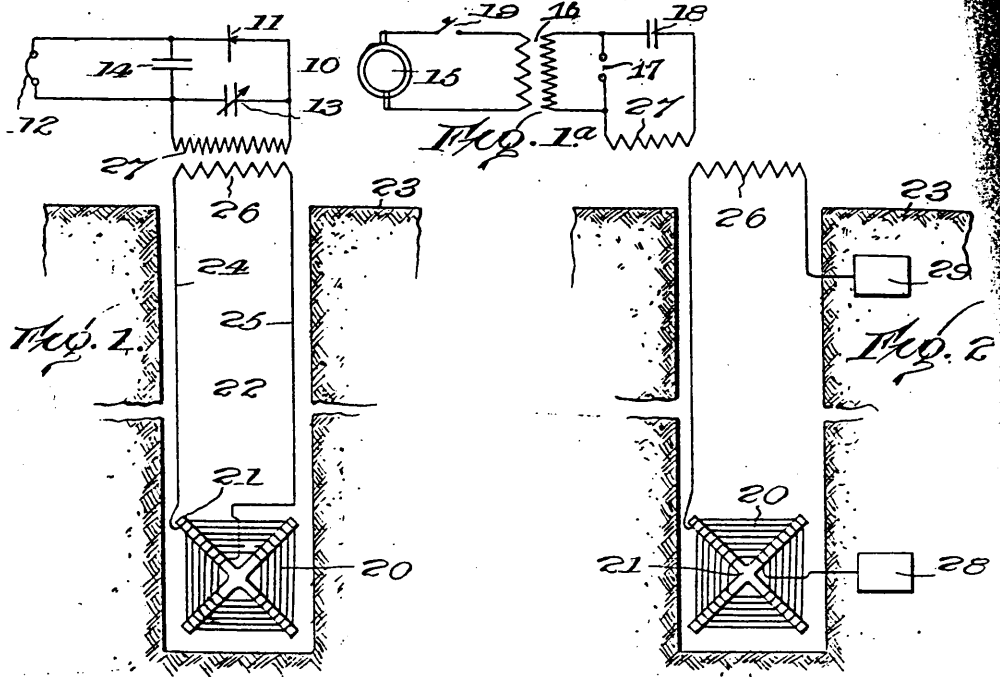
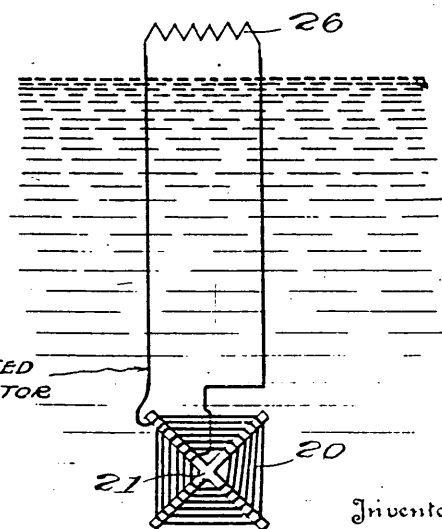
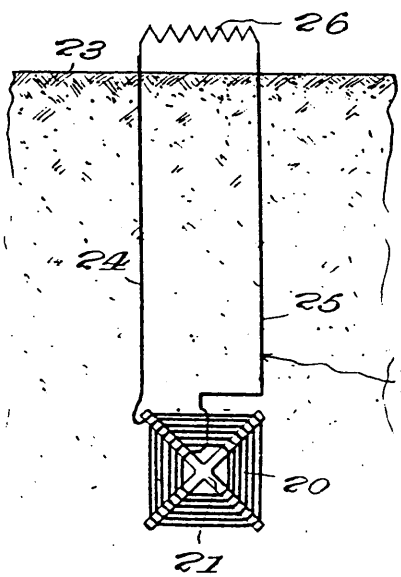

Fig. 3.

Fig. 4.



Inventor

James Harris Rogers,
 by *Oliver B. Stewart*,
 Attorney

UNITED STATES PATENT OFFICE.

JAMES HARRIS ROGERS, OF HYATTSVILLE, MARYLAND.

RADIO SIGNALING SYSTEM.

315,862.

Specification of Letters Patent. Patented Sept. 9, 1919.

Application filed January 17, 1918. Serial No. 212,198.

all whom it may concern:

Be it known that I, JAMES HARRIS ROGERS, citizen of the United States, residing at Hyattsville, in the county of Prince Georges and State of Maryland, have invented new and useful Improvements in Radiosignaling Systems, of which the following is a specification.

My invention relates to radio signaling systems in which radio conductors or antennæ are employed in sending and receiving signals through space by means of electromagnetic waves, and it relates more particularly to the arrangement and disposition of such conductors or antennæ.

My experiments have shown that coils of wire, of various shapes and sizes, act with a high degree of efficiency as radio conductors when used beneath the surface of the earth, and possess the advantage of greatly reducing the static. Such coils may be buried in the earth, lowered into dry wells, or submerged in water in wells or in bodies of water covering portions of the earth's surface. The coils may be composed of bare wire so wound that the coils are separated from each other, such coils being used out of contact with the ground or water, and preferably insulated wire when the coil is to be immersed in water or buried in the ground.

In using these coils I may and preferably do include them in a closed oscillating circuit which is suitably associated with the signaling instruments.

The invention consists of the novel construction and arrangement of apparatus and parts thereof for sending and receiving radio signals hereinafter described and claimed, and illustrated in the accompanying drawings, in which drawings—

Figure 1 is a diagrammatic view showing the radio conductor or coil beneath the earth's surface but insulated therefrom, receiving instruments being associated with the radiating conductor;

Fig. 1^a shows a conventional arrangement of sending instruments which may be substituted for the receiving instruments for transmitting signals, it being understood that either the receiving or sending instruments are employed with the arrangements shown in the remaining figures;

Fig. 2 is a view similar to Fig. 1 but showing the circuit of the radio conductor coil including a portion of the ground adjacent

thereto, instead of being included in a complete magnetic circuit as shown in Fig. 1;

Fig. 3 is a view similar to Fig. 1 showing the radio conductor coil buried in the earth but insulated therefrom;

Fig. 4 is a view similar to Fig. 3 showing the radio conductor coil immersed in water.

Referring to the drawings, 10 indicates the signal instruments, which in Fig. 1 are those for receiving signals, while in Fig. 1^a the instruments for sending signals are shown. In Fig. 1, 11 is a detector of any type, preferably an audion, 12 a telephone, and 13 and 14 the usual condensers. Any desired type of instruments and arrangement of connecting circuits may be employed.

In Fig. 1^a suitable sending instruments are conventionally shown. These comprise a generator 15, transformer 16, spark gap 17, condenser 18 and key 19.

The above-mentioned instruments are well known in the art of radio or magnetic wave signaling, and need not be further described.

The radio conductor or antenna is shown at 20, and as illustrated consists of a coil or spiral wound upon a suitable frame 21. The coil illustrated is flat, that is the turns lie in the same plane, and are secured to the frame 21 in any suitable manner as by being fitted in notches formed in the frame for that purpose. While this is the preferred form of coil, it will be understood that other forms may be adopted and may be found to work satisfactorily. This coil is placed beneath the earth's surface, as shown in Fig. 1 by being lowered into a well or other depression in the earth. The coil is preferably arranged in a vertical plane, and is placed at right angles to the wave fronts of the electromagnetic waves to be radiated or received, in order to obtain the maximum effect. The well referred to is indicated at 22 and the surface of the earth at 23.

The radio conductor is connected in a closed oscillating circuit indicated in Fig. 1 by conductors 24 and 25 connected to the respective ends of the radio conductor 20, and to the coil 26 of the inductive coupling the other member of which is indicated at 27. The closed oscillating circuit thus includes the radio conductor coil and a coil of the inductive coupling or transformer through which the receiving or the transmitting circuits and instruments are associated for sending or receiving signals.

In the modification of circuits shown in

Fig. 2, one terminal of the coil is connected to ground adjacent thereto, and one side of the circuit leading from the coupling coil 26 is connected to a second ground near the surface of the earth. The first mentioned ground is indicated at 28 and the second is indicated at 29. The earth connection between these two grounds 28 and 29 therefore takes the place of one side of the metallic circuit shown in Fig. 1 and constitutes a portion of the closed oscillating circuit in which the coil is included.

In Fig. 3, the radio conductor or coil is shown buried in the earth but insulated therefrom, instead of being lowered into a well or other cavity in the earth. In this connection it will be understood that the conductor constituting the coil as well as the circuit conductors 24 and 25 are insulated so that the wires themselves do not come in electrical contact with the ground.

In the arrangement shown in Fig. 4 the coil is shown immersed in water, this may be considered as a portion of the earth's surface. Here also insulated conductors are employed.

Throughout these various arrangements I have found that in receiving signals the strength and clearness of the signals seems to improve as the depth below the surface of the earth is increased, and the static is greatly reduced by the employment of the coil below the surface of the earth. Tests which I have made with the coil immersed to a depth of fifty feet in water have given excellent results.

In the practice of my invention I do not wish to be limited to the particular arrangements shown in the drawings or described above, but contemplate all such changes as are within the scope of the invention. The invention is applicable to trench warfare for communicating between different portions of a trench or between different trenches. It is also applicable to various types of land stations, and may be also used with advantage on portions of the earth where there is water, such as on ships at sea where the radio conductor may be mounted upon the ship in any suitable way or may be lowered overboard from a vessel. It will be understood also that it is not necessary that the sending and receiving instruments should be above ground as illustrated, as these may be under the surface of the ground in suitable chambers, bomb proof

trenches or in caves, etc. As such applications of the invention are obvious it is thought unnecessary to illustrate them.

In the practice of the invention that static is greatly reduced and the directional effects obtained are excellent.

From the above it will be apparent that a radio conductor of great length may be employed beneath the surface of the earth without necessitating a corresponding amount of trench work or other labor for placing the conductor beneath the surface. It will also be understood that the conductor may be made of any desired length according to conditions or requirements.

The term "radio conductor" has been employed throughout the specification and claims synonymously with the term "antenna" to indicate the conductor from which the oscillations are radiated in sending messages and are received when receiving messages.

What I claim as new and desire to secure by Letters Patent of the United States is—

1. A radio signaling system comprising a coiled radio conductor beneath the surface of the earth and connected in a closed oscillating circuit.

2. A radio signaling system comprising a coiled radio conductor buried beneath the surface of the earth but insulated therefrom and connected in a closed oscillating circuit.

3. A radio signaling system comprising a coiled radio conductor immersed in water but insulated therefrom and connected in a closed oscillating circuit.

4. A radio signaling system comprising a coiled radio conductor beneath the surface of the earth but insulated therefrom and connected in a closed oscillating circuit, and electromagnetic wave signal instruments inductively associated with said oscillating circuit.

5. A radio signaling system comprising a radio conductor connected in a closed oscillating circuit and in the form of a flat coil or spiral beneath the surface of the earth but insulated therefrom and positioned at right angles to the wave fronts of the waves sent or received, and electromagnetic wave signal instruments associated with said conductor.

In testimony whereof I have hereunto set my hand.

JAMES HARRIS ROGERS.

J. H. ROGERS AND H. H. LYON.
WIRELESS SIGNALING SYSTEM.
APPLICATION FILED NOV. 10, 1916.

1,322,622.

Patented Nov. 25, 1919.
3 SHEETS—SHEET 1.

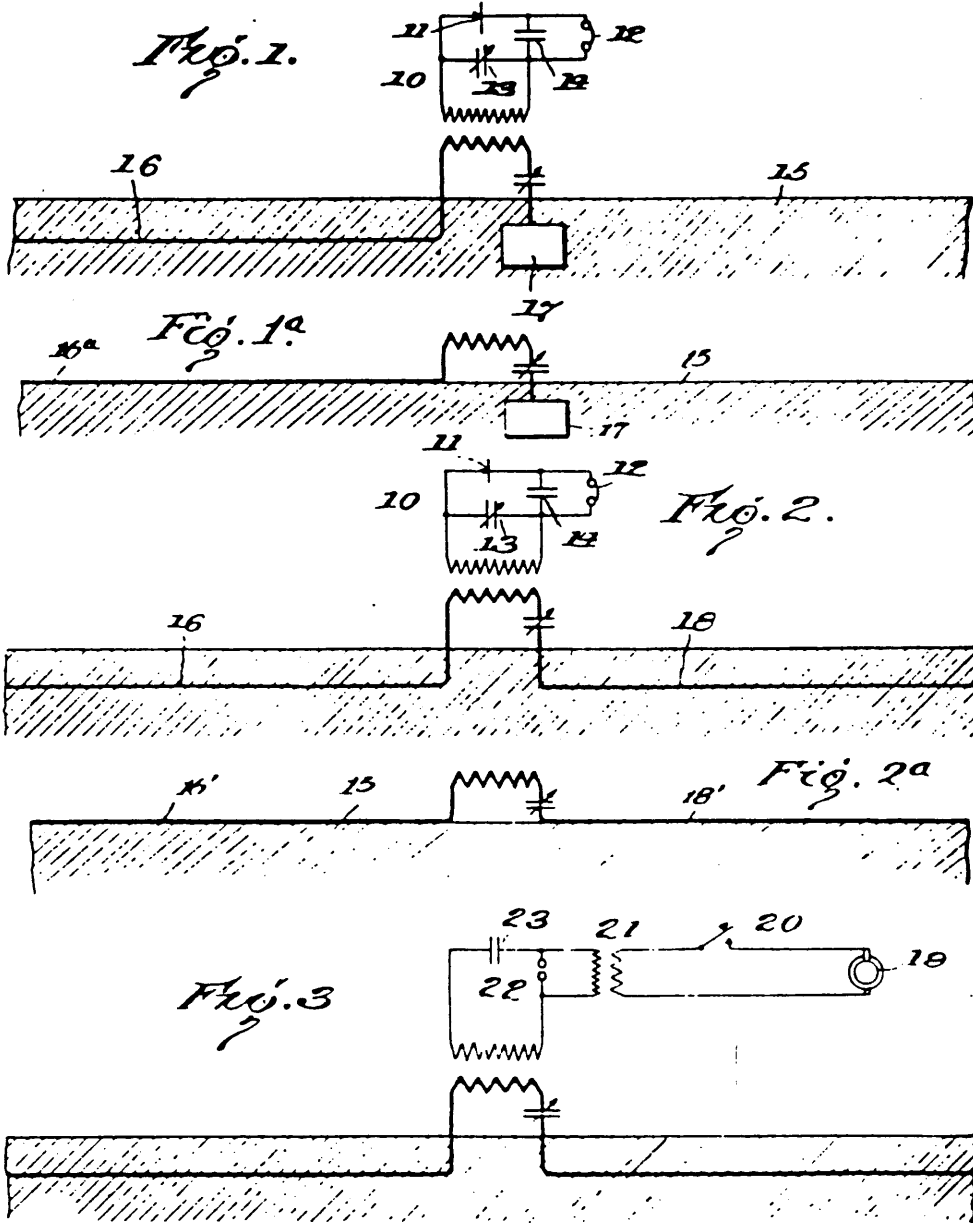

Inventor
James Harris Rogers
Henry H. Lyon
By *Oliver C. Shattuck*
Attorney

J. H. ROGERS AND H. H. LYON.
WIRELESS SIGNALING SYSTEM.
APPLICATION FILED NOV. 10, 1910.

1,322,622.

Patented Nov. 25, 1919.

3 SHEETS-SHEET 2.

Fig. 4.

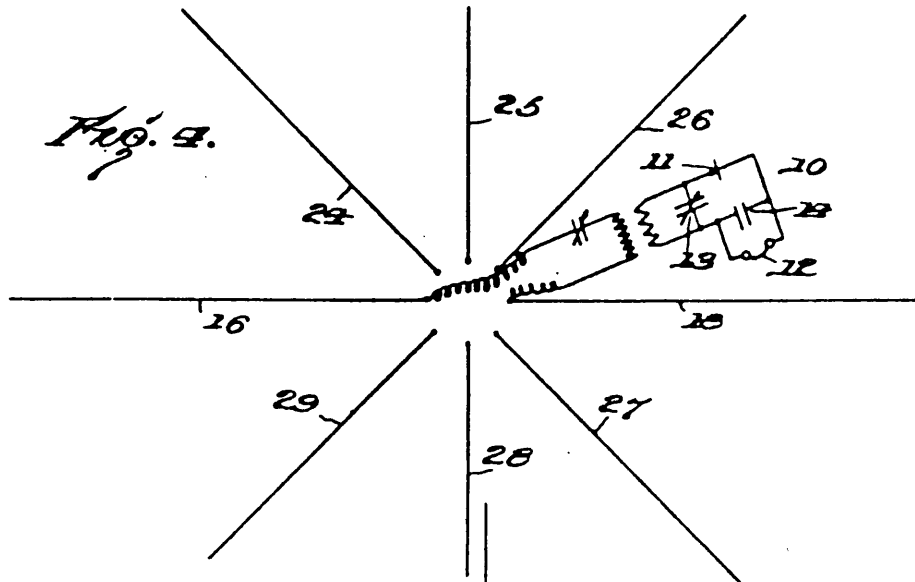

Fig. 5.

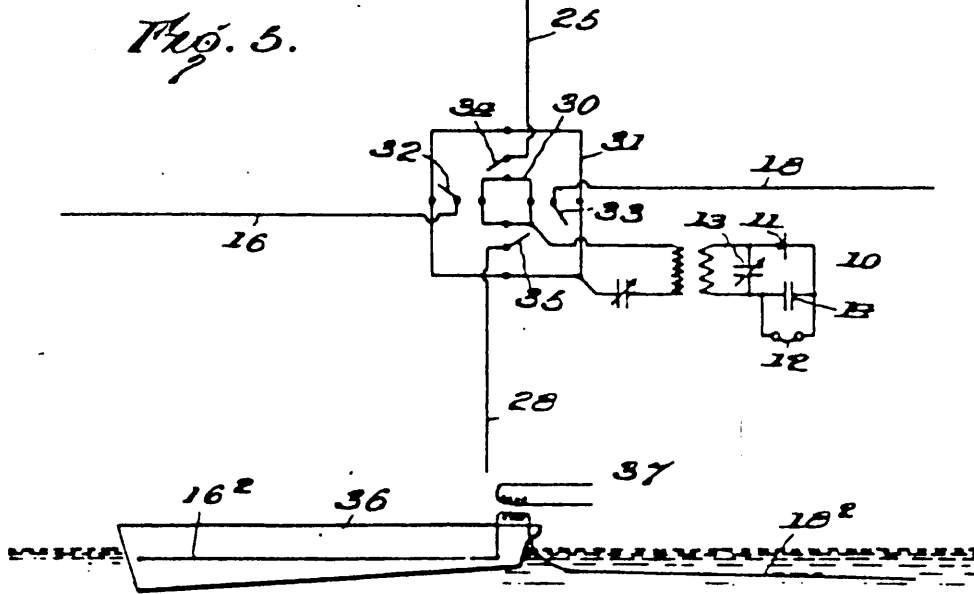

Fig. 6.

Inventors
James Harris Rogers,
Henry H. Lyon,
By *Oliver A. Heater*
Attorney

J. H. ROGERS AND H. H. LYON.
WIRELESS SIGNALING SYSTEM.
APPLICATION FILED NOV. 10, 1918.

1,322,622.

Patented Nov. 25, 1919.
3 SHEETS—SHEET 3.

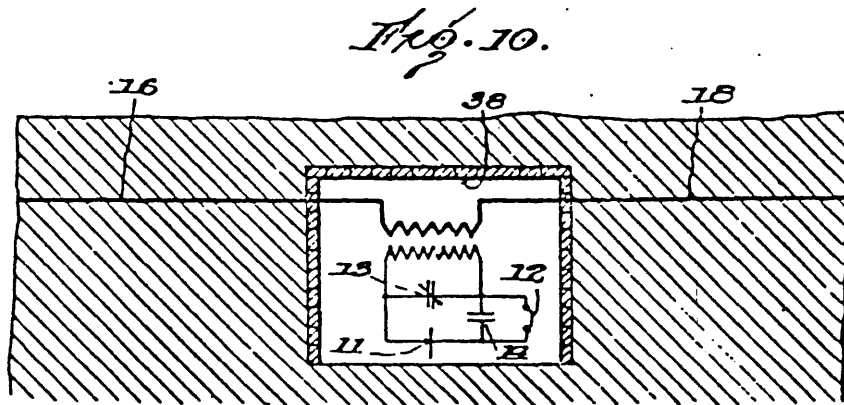
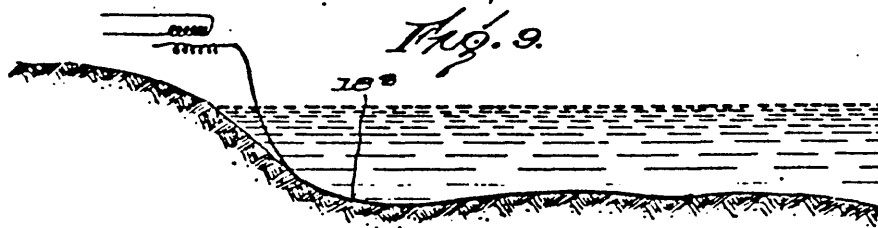
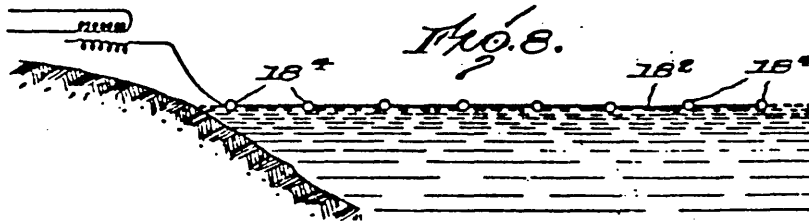
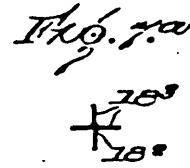
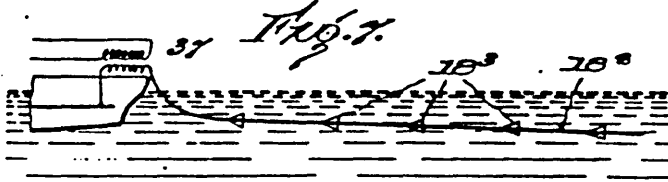

Inventors
James Harris Rogers,
Henry H. Lyon,
224
Wm. A. Charters,
Attorney

UNITED STATES PATENT OFFICE.

JAMES H. ROGERS AND HENRY H. LYON, OF HYATTSVILLE, MARYLAND.

WIRELESS SIGNALING SYSTEM.

1,322,622.

Specification of Letters Patent.

Patented Nov. 25, 1919.

Application filed November 10, 1916. Serial No. 130,603.

To all whom it may concern:

Be it known that we, JAMES H. ROGERS and HENRY H. LYON, citizens of the United States, residing at Hyattsville, in the county of Prince Georges and State of Maryland, have invented new and useful Improvements in Wireless Signaling Systems, of which the following is a specification.

Our invention relates to the transmission of electrical impulses or oscillations to a distance, primarily for the purpose of conveying intelligence, and it pertains to means for both sending and receiving.

In systems of wireless sending and receiving now in general use one or more conductors or capacities are employed disposed above the surface of the earth, which conductors or capacities serve to radiate or receive the impulses in the sending or receiving of messages. Such elevated conductors are costly to erect and maintain, as to obtain efficiency and long-distance transmission it is necessary to have them at considerable distance above the surface of the earth. This necessitates expensive towers and masts, and moreover both the conductors and the towers or masts are exposed to weather conditions—wind storms, lightning, snow and ice—which often impede or entirely prevent the operative use of the system. We are aware that it has been proposed also to employ a conductor elevated above the earth in connection with a buried conductor.

Our invention has for its principal object the provision of a system not subject to the above objections; a system in which the communication, both sending and receiving, is clear and effective; in which the communication is selective and the direction of transmission may be readily determined; in which multiple transmission may be effected; and in which the sending and receiving of messages to and from stations on land and on water may proceed independent of weather conditions.

We have discovered that signals can be sent and received with great facility by the employment of wires laid directly on, or buried in, the earth and in intimate contact therewith substantially throughout their length and parallel to the surface.

The invention also consists in the novel features and combinations of circuits and

apparatus in the wireless signaling system hereinafter described and claimed, and illustrated in diagram in the accompanying drawings, in which—

Figure 1 is a system in which a single antenna is shown buried beneath the surface of the earth, the signal instruments being those of a receiving station;

Fig. 1^a shows the system with the antenna lying along the surface of the earth in intimate contact therewith substantially throughout its length, the signal instruments being omitted;

Fig. 2 is a view similar to Fig. 1 showing two antennæ extending in opposite directions;

Fig. 2^a is a view similar to Fig. 2, the antennæ being shown lying along the surface of the earth in intimate contact therewith substantially throughout their length instead of being buried beneath the surface, and the signal instruments being omitted;

Fig. 3 is a view similar to Fig. 2, but with the instruments of a sending station;

Fig. 4 is a diagram showing in plan a plurality of antennæ extending outwardly in different directions;

Fig. 5 is a similar view, including also switching means for making the proper connections;

Fig. 6 shows the invention applied to the earth's surface upon the water;

Fig. 7 is a view similar to Fig. 6, showing an additional feature of the antenna;

Fig. 7^a is a detail of the form shown in Fig. 7;

Fig. 8 shows the antenna supported on the surface of the water;

Fig. 9 shows the antenna on the surface of the earth below the surface of the water; and

Fig. 10 is a view similar to Fig. 2, showing the entire installation underground.

Referring to the drawings, signal instruments are indicated at 10, and in Figs. 1 and 2 are those of a receiving station, while in Fig. 3 the instruments of a sending station are shown. In Figs. 1 and 2, 11 is a detector of any type, preferably an audion, 12 a telephone, and 13 and 14 are the usual condensers. Any desired type of instruments and arrangement of connecting circuits may be employed.

The surface of the earth is indicated at 15,

and the antenna at 16. This latter extends in a direction substantially horizontal, either upon or below the surface of the earth, and is preferably in contact with the earth substantially throughout its length. The antenna thus constitutes a ground connection along its entire length, and, it is believed, a considerable portion of the earth's surface about the antenna thus cooperates with the latter in sending or receiving oscillations.

Instead of being below the surface, as shown in Fig. 1 at 16, the antenna may lie upon the surface of the earth, as shown at 16', in Fig. 1', being in intimate contact with the earth substantially throughout its entire length.

In cooperation with the antenna we may, and preferably do, employ another earth connection, this being shown in Fig. 1 as a ground plate 17.

Fig. 2 is an embodiment of the invention in which two antennae are employed extending in opposite directions, the second antenna 18 being connected in place of the ground plate shown in Fig. 1. This arrangement is more effective than with the use of the ground plate.

Fig. 2' shows the antennae 16' and 18' extending in opposite directions upon the surface of the earth and in intimate contact therewith substantially throughout their length, the signal instruments connected between the antennae being indicated by one member of the indirect coupling.

Fig. 3 shows the same arrangement as Fig. 2 but with sending instruments instead of receiving instruments. These comprise a generator 19, key 20, transformer 21, spark gap 22 and condenser 23. Any other sending arrangement and instruments may be employed instead of those shown.

In order to obtain the maximum efficiency it is desirable to have the antennae disposed in a line at right angles to the wave fronts, and in order that this may be accomplished for the different directions we provide antennae extending in different directions but substantially horizontal or parallel to the surface of the earth and either on or under the surface and in contact with the earth throughout their lengths. Such an arrangement is illustrated in Fig. 4 where eight antennae are shown. These are designated 16, 24, 25, 26, 18, 27, 28 and 29. The instruments are shown connected to antennae 16 and 18, but may be connected to any other two or more. Sometimes it is necessary to connect to several antennae in order to obtain the best results. The signal instruments may be connected by any suitable switching devices to any two or more of antennae and the direction of transmission thus ascertained. Usually the connection would be made with the pairs of oppositely extend-

ing antennae, but the instruments may be connected to any two or more desired. Also, for multiplex transmission separate instruments may be connected to different pairs or groups.

Any preferred switching devices may be employed to connect the instruments to the antennae, a convenient arrangement being shown in Fig. 5. The instruments are connected to bus wires 30 and 31, and each antenna 16, 18, 25, 28 is connected to a switch blade 32, 33, 34 and 35 respectively. Any additional number of antennae desired may be employed in the same way. Each switch blade cooperates with a contact upon each bus wire. The instruments may thus be connected with any one or two or more antennae.

The invention is also applicable to the surface of the earth where there is water. For instance, on the sea coast the antennae may be run out from shore into the water or along the shore on the surface of or under the sand. In this way the system is useful for life-saving stations, light-houses, &c.

The system is also adapted to the use of vessels at sea, including submarines. We have demonstrated that the receiving is highly efficient when the antennae are lying on the bottom, as shown in Fig. 9, either in fresh or salt water. The antennae may also be supported by floats along the surface of the water, as shown at 18' in Fig. 8, or suspended in the water above the bottom.

A specific embodiment of this last mentioned feature of the invention is shown in Fig. 6 where 36 indicates a boat or vessel, 16' one antenna and 18' another antenna. The antenna 16' may be mounted along the side of the vessel but preferably insulated therefrom or attached only at the bow and trail toward the stern, or with vessels of wood or other insulating material it may even be mounted inside. When the vessel is iron or other metal, the vessel itself may be employed as this antenna, provided the capacity is not too great.

By this arrangement it will be seen that very long antennae may be used. The length of the antenna mounted upon the body of the vessel is only limited by the length of the vessel, and as many vessels are over three hundred feet long, and some are 600 to 800 feet, the necessary length of antenna for long distance work is readily accommodated. The other antenna, trailing from the stern of the vessel, may be at least as long as, or even longer than, the antenna mounted upon the body of the vessel. If desirable, these and the other antennae described may be replaced by multiple strands.

The antenna 18' may be a wire allowed to trail astern, and will approximate the horizontal, according to the speed. Fins 18' may be added at intervals along the wire, as shown in Figs. 7 and 7', to increase this

action. The signal instruments are associated with these antennæ in any desired manner, as at 37.

When applied to submarines, it will be seen, therefore, that messages may be sent and received while running partially or entirely submerged.

In accordance with the patent statutes we have described what we now believe to be the best embodiment of the invention, but we do not wish to be understood thereby as limiting ourselves or the scope of the invention, as many changes and modifications may be made without departing from the spirit of the invention and all such we aim to include in the scope of the appended claims.

For instance throughout the several figures, the signal instruments are shown associated with the antenna or antennæ by indirect coupling, but may be associated therewith in any other manner desired. It will be seen also that while the signal instruments are shown diagrammatically above the earth, they will in practice often be actually located in a pit below the ground level or entirely underground between the antennæ. This construction is shown in Fig. 10, the pit being indicated at 38. When the antennæ are entirely underground, the effects of lightning on the receiving of signals are nearly eliminated, so that only slight clicks are heard instead of loud prolonged hissing.

It will be understood that the system works with either sustained oscillations or damped wave trains.

What we claim and desire to secure by Letters Patent of the United States, is—

1. A wireless system for signaling by electromagnetic waves comprising an antenna extending in direction substantially parallel to and under the surface of the earth and in intimate contact therewith substantially throughout its length, an additional earth connection, and electromagnetic wave signal instruments connected to said antenna and said additional earth connection.

2. A wireless system for signaling by electromagnetic waves comprising signal instruments, a plurality of antennæ associated therewith extending outwardly therefrom in direction parallel to the surface of the earth and each in contact with the earth substantially throughout its length, and means for connecting said instruments between two or more of said antennæ.

3. A wireless system for signaling by electromagnetic waves comprising signal instruments, a plurality of antennæ associated therewith extending outwardly therefrom in direction parallel to and below the surface of the earth in contact therewith substantially throughout their length, and means for connecting said instruments between two or more of said antennæ.

4. A wireless system for signaling by electromagnetic waves comprising signal instruments, an antenna extending outwardly therefrom, and a second antenna extending in the opposite direction, said antennæ being parallel to the surface of the earth in contact therewith substantially throughout their length, and means for connecting said instruments between said antennæ.

5. A wireless signaling system comprising signal instruments, a plurality of antennæ associated therewith each extending outwardly in direction parallel to the surface of the earth in intimate contact therewith substantially throughout its length, and switching means to selectively connect said signal instruments to any two or more of said antennæ.

6. A wireless signaling system comprising signal instruments, a plurality of antennæ in pairs associated therewith, the members of each pair extending outwardly in direction parallel to and below and in intimate contact with the surface of the earth, and switching means to selectively connect said signal instruments to said antennæ pairs.

7. In combination with a boat or vessel, an antenna thereon below the surface of the water extending in direction substantially parallel to the surface of the water, and electromagnetic wave signal instruments associated with said antenna.

8. In combination with a boat or vessel, an antenna thereon extending in direction parallel to and under the surface of the water in contact therewith, and signal instruments for electromagnetic waves associated with said antenna.

9. In combination with a boat or vessel, a signaling system comprising electromagnetic wave signal instruments, an antenna on said boat, and a second antenna extending in the opposite direction, said antennæ being parallel to and under the surface of the water and in contact therewith substantially throughout their length, and each connected with said instruments.

10. In combination with a boat or vessel, a signaling system comprising electromagnetic wave signal instruments, an antenna on said boat or vessel below the surface of the water, and a second antenna extending rearwardly from the vessel below the surface of the water, said instruments being connected between said antennæ.

In testimony whereof we have hereunto set our hands in presence of two subscribing witnesses.

JAMES HARRIS ROGERS.
HENRY H. LYON.

Witnesses:

JOHN GIBSON,
S. WILLIAM FORD.

C. H. ROE.
ART OF THE TRANSMISSION OF ELECTRICAL POWER WITHOUT WIRES.
APPLICATION FILED AUG. 1, 1918.

1,333,095.

Patented Mar. 9, 1920.

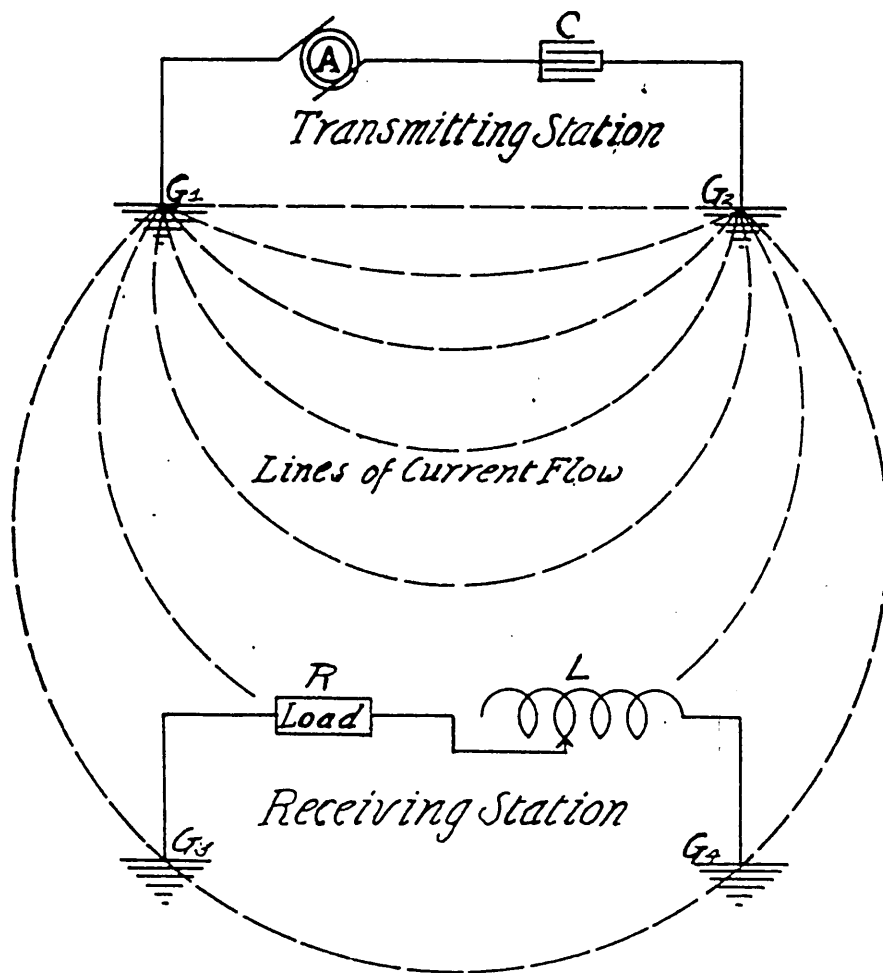

Inventor:
Chas. H. Roe

UNITED STATES PATENT OFFICE

CHARLES HARVEY RCE. OF WEIDMAN, MICHIGAN.

ART OF THE TRANSMISSION OF ELECTRICAL POWER WITHOUT WIRES.

1,333,095.

Specification of Letters Patent.

Patented Mar. 9, 1926.

Application filed August 1, 1918. Serial No. 247,839.

To all whom it may concern:

Be it known that I, CHARLES HARVEY RCE, a citizen of the United States, residing at Weidman, in the county of Isabella and the State of Michigan, have invented new and useful Improvements in the Art of the Transmission of Electrical Power Without Wires, of which the following is a specification.

This invention has for its object the transmission of electrical energy or power in the form of alternating current from a transmitting station to a distant receiving station where the current is utilized to operate electrical devices, all without the use of intermediate wires or other special conductors.

My method employs the principle of resonance in alternating current circuits wherein currents are propagated entirely by conduction, and is to be differentiated from all methods employing electric, electro-magnetic or electro-static waves and methods whereby currents are induced at a distance by electro-magnetic or electro-static fields. In the drawing, an alternating current circuit in which the impressed electromotive force is out of phase with the current is closed by connecting it at two separated points to the earth. This is shown in the diagram by an alternator A in series with a condenser C and the terminals of the circuit grounded at two points G_1 and G_2 distant from each other. The current flowing then has a wattless component and spreads out in all directions from the ground terminals G_1 and G_2 at the transmitting station as indicated by the dotted lines. If then two grounded terminals G_2 and G_1 at a distant receiving station be connected to a suitable receiving device, they will lie in the path of some one line of current flow from the transmitting station and an electromotive force, even though very slight, will be impressed upon the receiving circuit. A reactance introduced into the receiving circuit of such nature and dimensions as to produce conditions of resonance will then cause whatever current may flow as a result of the electromotive force impressed at the ground terminals G_2 and G_1 to be in phase with the generator electromotive force, that is, of unity power factor, and it may be used to actuate electrical devices. This is represented in the diagram by a variable inductance L adjustable to counterbalance the capacity

C at the transmitting station. The load R is shown in series with it, the terminals of the circuit being grounded at G_2 and G_1 in the same manner as those at the transmitting station.

In the figure there are two components of current flowing through the alternator A. One is almost ninety degrees behind the generated electromotive force and circulates through the circuit $A-C-G_2-G_1-A$, the great angle of phase difference being due to the use of the reactance in series, as at C; this component will be termed the wattless component. The other component is nearly in phase with the generated electromotive force and circulates through the circuit $A-C-G_2-G_1-L-R-G_2-G_1-A$; this component will be termed the power component, the current and electromotive force being very nearly in phase because the separate tendencies of the two reactances, L and C are in opposite directions and operate to neutralize each other. At the transmitting station, the wattless component may be kept very low by using sufficiently high reactance in series as at C; that is, the short circuit current through the ground between G_1 and G_2 or vice versa may be made very small and since even that is of a low power factor, the loss of power due to this feature may be maintained at a very low figure indeed. Consider now the circuit of the power component. According to the principles of alternating currents as expounded in standard textbooks and generally accepted, a non-reactive resistance in a circuit containing capacity and inductance in such proportions that

$$2(\pi)fL \text{ equals } \frac{1}{2(\pi)fC}$$

where f is the frequency of the circuit in cycles, L is the inductance in henries, C is the capacity in farads, will be traversed by a current whose magnitude is determined only by the electromotive force impressed upon the non-reactive resistance and the value of the resistance itself; that is, Ohm's law in its simplest form applies. In the circuit $A-C-G_2-G_1-L-R-G_2-G_1-A$, therefore, the two reactances L and C, being in series with each other, tend to neutralize each other and we have only the ohmic resistance of the circuit and of the load R to limit the amount of the current flowing. Accordingly, by keeping the ohmic resist-

ance of the entire circuit low enough and so arranging the various parts of the system as to impress the highest possible electromotive force across the terminals of the load R, the power component of the current flowing through R may be many times, even thousands, greater than the wattless component through the ground between G_1 and G_2 . Therefore, the efficiency of transmission, as defined by

$$\text{Efficiency} = \frac{\text{Watts transmitted and utilized in load R}}{\text{Watts transmitted and utilized in load R plus watts lost in short circuit between } G_1 \text{ and } G_2}$$

may be very high. This high efficiency of transmission is the principal advantage I claim for my invention. All other methods using conduction through the ground or other medium merely send out current in all directions from the transmitter and only a very small part of the current is picked up at the receiver and made to do work. That is, the efficiency of transmission is very low. By all other systems it is necessary to transmit hundreds or thousands of watts (sometimes hundreds of kilowatts) into the ground or other common medium in order to be able to pick up sufficient current at the receiver to operate the most sensitive devices known to electrical science. With my system this enormous waste of power is avoided and it is possible by my method to transmit power through the ground or other medium without wires with a loss of only a fraction of one per cent other than iron, copper and dielectric losses in the apparatus employed.

In practical application every effort is made to increase the resistance between the grounded terminals G_1 and G_2 at the transmitting station and thereby increase the electromotive force impressed upon the ground terminals G_1 and G_2 at the receiv-

ing station. This may be done by taking advantage of natural conditions, as for instance, where the two ground connections are made in two separate river beds more or less parallel to each other, the streams then acting as independent conductors. Veins of conducting ores may also be used, or even strata of earth separated by strata of material of lower conductivity, *e. g.*, rock. One terminal might be grounded at the surface of the earth and the other carried down an insulated conductor and grounded several hundred or a thousand feet below the surface. Of course the terminals at the receiving end must be similarly connected to the same natural conductors.

I claim:

The art of transmitting electrical power through the earth as a medium from a transmitting circuit to a receiving circuit, which art comprises the production of alternating currents of power factor less than unity, the impressing of said currents on an earth path and the increasing of the power factor of a part of said currents in such receiving circuit.

CHARLES HARVEY ROE.

J. H. ROGERS.
 RADIOSIGNALING SYSTEM.
 APPLICATION FILED MAY 2, 1917.

1,349,103.

Patented Aug. 10, 1920.

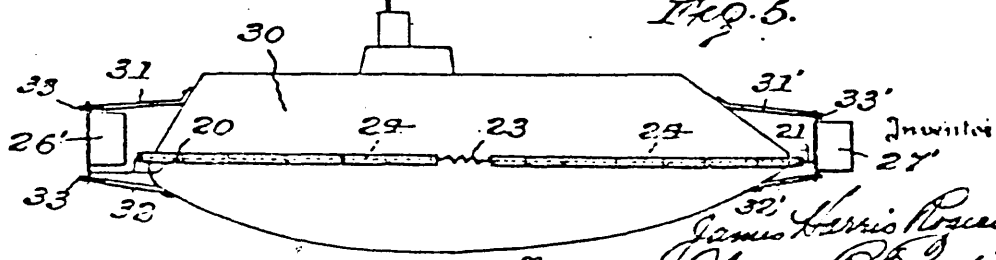
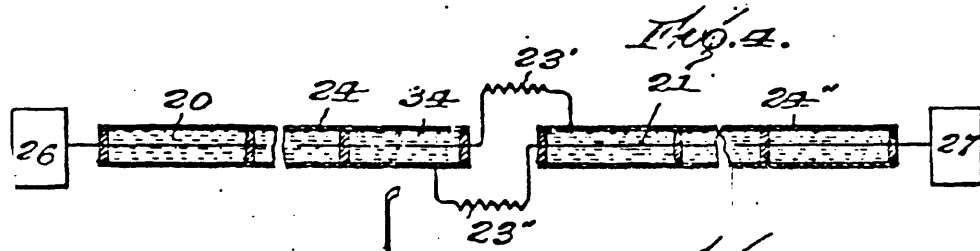
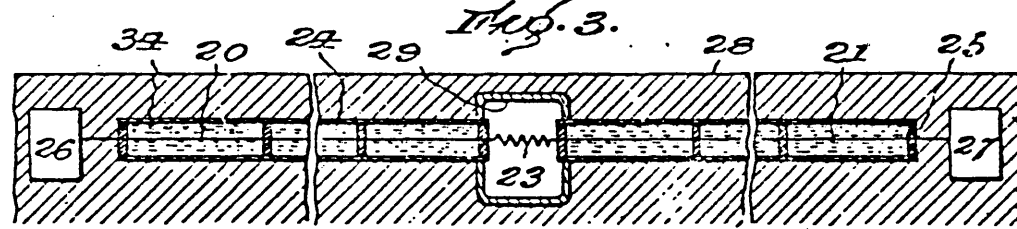
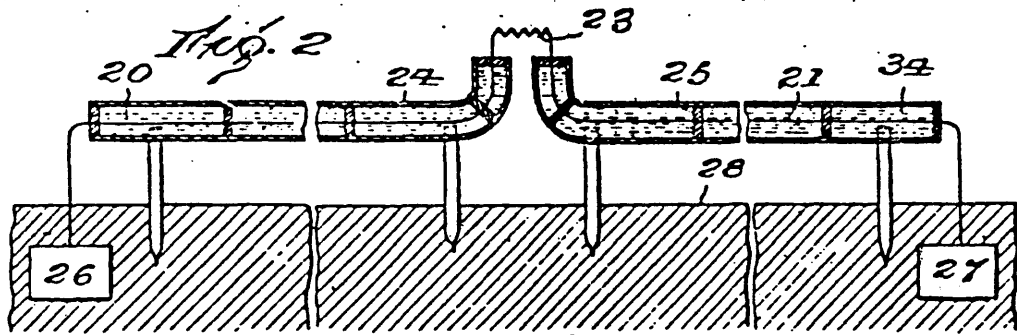
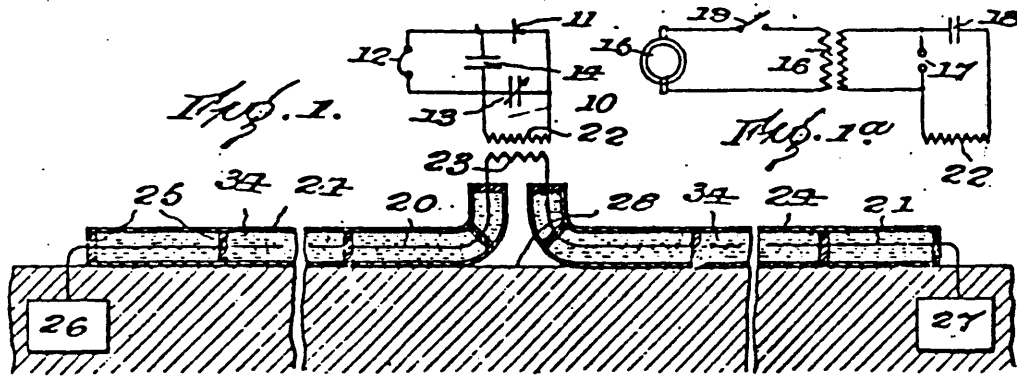

*James Harris Rogers,
 Denver R. Prater,
 Attorneys*

UNITED STATES PATENT OFFICE.

JAMES HARRIS ROGERS, OF HYATTSVILLE, MARYLAND.

RADIO SIGNALING SYSTEM.

1,349,103.

Specification of Letters Patent. Patented Aug. 10, 1920.

Application filed May 2, 1917. Serial No. 165,875.

To all whom it may concern:

It is known that I, JAMES HARRIS ROGERS, a citizen of the United States, residing at Hyattsville, in the county of Prince Georges and State of Maryland, have invented new and useful Improvements in Radiosignaling Systems, of which the following is a specification.

My invention relates to radio signaling or the sending and receiving of signals through space by means of electromagnetic waves, and it pertains particularly to the disposition of the radio conductor or conductors.

In the course of my experiments I have discovered that grounded radio conductors or antennae are highly efficient when disposed horizontally or substantially parallel to the surface of the earth, and surrounded by or inclosed in a uniform metallic screen practically throughout their length, but insulated therefrom. The advantages of long prostrate (as distinguished from erect) antennae are thus obtained and the objectionable effects of certain forms of static conditions are eliminated.

The invention consists in the novel construction and arrangement of apparatus and parts thereof for sending and receiving radio signals hereinafter described and claimed, and illustrated in the accompanying drawings, in which drawings—

Figure 1 is a diagrammatic view showing the screen for the antennae resting upon the surface of the earth, receiving instruments being shown associated with the antennae;

Fig. 1^a shows a conventional arrangement of sending instruments which may be substituted for the receiving instruments for transmitting signals;

Fig. 2 is a view similar to Fig. 1, but showing the inclosing screen for the antennae elevated above the surface of the earth, the instruments, receiving or transmitting, being merely indicated by one of the coupling coils;

Fig. 3 is a similar view showing the inclosing screen buried beneath the surface of the earth;

Fig. 4 shows diagrammatically a modification; and

Fig. 5 is a similar view showing the invention applied to a boat or vessel, such as a submarine.

Referring to the drawings, 10 indicates the signal instruments, which in Fig. 1 are

those for receiving signals, while in Fig. 1^a the instruments for sending signals are shown. In Fig. 1, 11 is a detector of any type, preferably an audion, 12 a telephone, and 13 and 14 the usual condensers. Any desired type of instruments and arrangement of connecting circuits may be employed.

In Fig. 1^a suitable sending instruments are conventionally shown. These comprise a generator 15, transformer 16, spark gap 17, condenser 18 and key 19.

The above-mentioned instruments are well known in the art of radio or magnetic wave signaling, and need not be further described.

20 and 21 are two antennae extending in different directions from the signal instruments, and are shown associated with these instruments by indirect coupling, as coils 22 and 23 of a transformer. These antennae may extend in opposite directions, and in order to attain maximum efficiency arrangement may be made so that they may be disposed in a line at right angles to the wave fronts when receiving. Such an arrangement is fully described in application S. No. 130,603, which has since issued as Patent No. 1,322,622, dated Nov. 25, 1919.

The antennae are each inclosed in a metallic screen shown as a metal pipe 24 in which the antenna is mounted by spacers or disks 25 of insulating material, such as porcelain, clay, fiber or the equivalent, so that while each antenna is inclosed substantially throughout its length by the metallic screen it is insulated therefrom. At the outer end, or end away from the instruments, each antenna 20 and 21 is connected to earth plates 26 and 27 respectively.

The length of each antenna may be selected to suit the conditions under which each system is to work, and may be several hundred or a thousand feet, or more. The pipe or screen may be of iron or other metal suitable to accomplish the purpose, and serves to protect the antenna from certain static conditions which would or might interfere with the sending or receiving of signals.

The surface of the earth is indicated at 28, and in Fig. 1 the antennae and their inclosing screens are shown resting upon and in contact with the surface of the earth substantially throughout their length.

In Fig. 2 the antennae and their inclosing

screens are shown supported above the surface of the earth, and may or may not be insulated therefrom. In this figure, as also in Figs. 3, 4 and 5, the sending and receiving instruments, whichever is connected for use at any given time, is merely indicated by one coil 23 of the coupling.

In Fig. 2 the antennae and their inclosing screens are shown buried beneath the surface of the earth, in which case the instruments may be in a covered chamber 29 below ground.

In Fig. 4 is shown an arrangement in which, instead of associating one set of signal instruments with both antennae, two sets of instruments are provided, one set 23' being connected to antenna 20 and screen or pipe 24'', and instruments 23'' being connected to antenna 21 and screen or pipe 24''.

In this way two sets of instruments may be used simultaneously, both sets for sending or receiving, or one set for sending and the other set for receiving.

In using the term "surface of the earth" I intend to designate the surface where there is water as well as where there is land. The invention is therefore equally applicable to boats or vessels, particularly submarines on which it is operative whether afloat or submerged. Such an embodiment of the invention is shown in Fig. 5, in which the vessel is indicated at 30, and the other parts designated as in Figs. 1, 2 and 3, so that they require no further description. The screens 24 are preferably extended through sheathing or hull, so that each antenna is inclosed substantially throughout its length within the vessel. The ground plate 26' at the forward end of the vessel is preferably pivotally mounted at its forward edge on brackets 31, 32 so as to swing freely with the movements of the vessel, but is insulated therefrom as shown diagrammatically at 33, 33. The antenna 20 is connected to plate 26' in any suitable manner. Ground plate 27' is similarly mounted on brackets 31', 32', at the stern of the vessel, and is connected to antenna 21. These plates may be mounted in any other suitable manner.

In all of the embodiments of the invention the pipe or screen is preferably filled with

oil such as is ordinarily used in transformers, for the purpose of preventing brush discharge, this being indicated at 34.

In accordance with the patent statutes I have described what I now believe to be the best embodiment of the invention, but I do not wish to be understood thereby as limiting myself or the scope of the invention, as many changes and modifications may be made without departing from the spirit of the invention and all such I aim to include in the scope of the appended claims. For instance, each antenna is shown as a single wire or conductor, whereas it might be composed of multiple conductors.

What I claim as new and desire to secure by Letters Patent of the United States, is—

1. A radio signaling system comprising an antenna extending horizontally substantially parallel to the surface of the earth, signal instruments associated with said antenna at one end and a ground connection at the other end, and a metallic screen in intimate contact with the earth substantially throughout its length and inclosing said antenna.

2. A radio signaling system comprising an antenna extending horizontally substantially parallel to the surface of the earth, signal instruments associated with said antenna at one end and a ground connection at the other end, and a metallic screen upon and in contact with the earth and inclosing said antenna substantially throughout its length but insulated therefrom.

3. A radio signaling system comprising an antenna extending horizontally substantially parallel to the surface of the earth, signal instruments associated with said antenna at one end and a ground connection at the other end, and a metallic screen buried beneath the surface of the earth and inclosing said antenna substantially throughout its length but insulated therefrom.

In testimony whereof I have hereunto set my hand in presence of two subscribing witnesses.

JAMES HARRIS ROGERS.

Witnesses:

ALEX J. HANSON;
WALTON C. CARROLL.

J. H. ROGERS.
RADIO SIGNALING SYSTEM.
APPLICATION FILED JAN. 17, 1918.

1,349,104.

Patented Aug. 10, 1920.

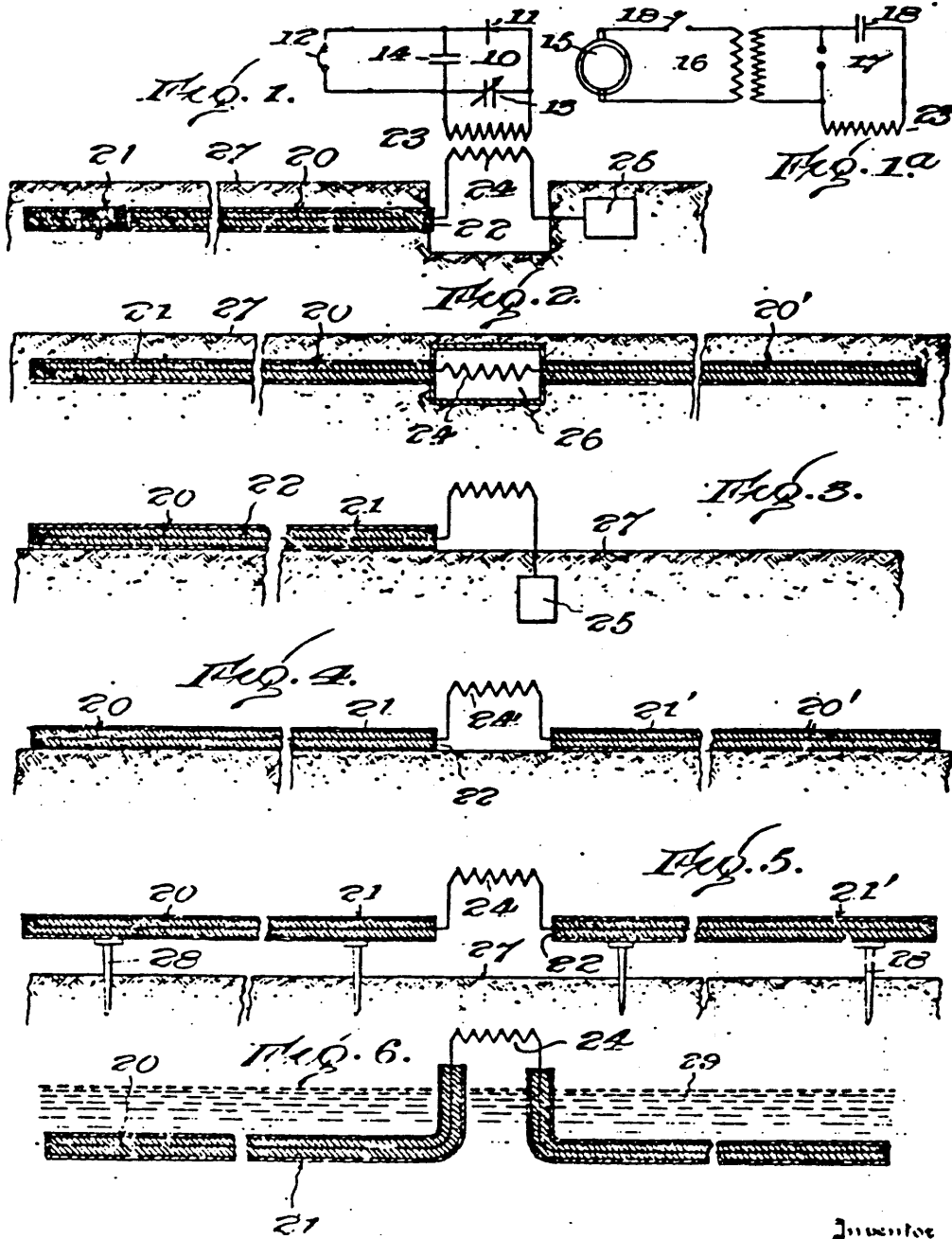

Inventor

James Harris Rogers
Henry B. ...

Attorney

UNITED STATES PATENT OFFICE.

JAMES HARRIS ROGERS, OF HYATTSVILLE, MARYLAND.

RADIOSIGNALING SYSTEM.

1,349,104.

Specification of Letters Patent. Patented Aug. 10, 1920.

Application filed January 17, 1918. Serial No. 212,137.

To all whom it may concern:

Be it known that I, JAMES HARRIS ROGERS, a citizen of the United States, residing at Hyattsville, in the county of Prince Georges and State of Maryland, have invented new and useful Improvements in Radiosignaling Systems, of which the following is a specification.

My invention relates to radio signaling systems and apparatus for sending and receiving signals through space by means of electromagnetic waves, and it relates particularly to that portion of such systems known as the antenna.

I have discovered that radio conductors or antennae are highly efficient when disposed horizontally or substantially parallel to the surface of the earth but completely insulated therefrom and inclosed in an inclosing metallic covering screen or casing practically throughout their entire length, but insulated therefrom. The metallic covering thus inclosing the antenna, but from which the latter is insulated, takes up the electromagnetic waves, in receiving, and transmits them to the antenna within at full strength and even with greater effect than when the antenna is used without the covering. A highly efficient action is thus obtained, the static is reduced, and at the same time the antenna is fully protected from deterioration by the corroding action of earth and water.

The invention consists in the novel construction and arrangement of apparatus and parts thereof for sending and receiving radio signals hereinafter described and claimed, and illustrated in the accompanying drawings, in which drawings—

Figure 1 is a diagrammatic view showing the antenna buried beneath the surface of the earth, receiving instruments being associated with the antenna;

Fig. 1* shows a conventional arrangement of sending instruments which may be substituted for the receiving instruments for transmitting signals, it being understood that either the sending or receiving instruments shown in Fig. 1 are to be used in connection with the arrangements shown in the remaining figures;

Fig. 2 is a view similar to Fig. 1 showing two antennae extending in opposite directions beneath the surface of the earth,

the connection for signaling instruments being located between the antennae and also beneath the surface of the earth;

Fig. 3 shows an antenna incased according to the invention and lying upon the surface of the earth, a ground connection and the instruments connected between the antenna and the ground connection;

Fig. 4 is a view similar to Fig. 3 showing two antennae instead of one antenna and a ground connection;

Fig. 5 is a view similar to Fig. 4 but showing the antennae supported above the surface of the earth but in close proximity thereto;

Fig. 6 is view similar to Fig. 2 in which the antennae are shown submerged in water.

Referring to the drawings, 10 indicates the signal instruments, which in Fig. 1 are those for receiving signals; while in Fig. 1* the instruments for sending signals are shown. In Fig. 1, 11 is a detector of any type, preferably an audion, 12 a telephone, and 13 and 14 the usual condensers. Any desired type of instruments and arrangement of connecting circuits may be employed.

In Fig. 1* suitable sending instruments are conventionally shown. These comprise a generator 15, transformer 16, spark gap 17, condenser 18 and key 19.

The above-mentioned instruments are well known in the art or radio or magnetic wave signaling, and need not be further described.

20 is an antenna for radiating or receiving electromagnetic waves, and as shown in Fig. 1 extends horizontally or substantially parallel to the earth's surface and buried in the earth. This antenna may be of any suitable or desired length, and is completely inclosed within a metallic covering, casing or screen 21 which may be a tube or pipe of lead, iron or any other suitable metal. The antenna is insulated from the metallic covering or casing by means of insulation 22. It will thus be seen that while the antenna is buried in the earth it is completely insulated therefrom and from the metallic covering or casing.

The receiving instruments shown in Fig. 1 are associated with the antenna by means of an inductive coupling comprising windings 23 and 24 of a transformer, but may be associated therewith in any other suitable

manner. The other terminal of winding 24 of the coupling is connected to ground at 25.

In the embodiment of the invention shown in Fig. 2 the ground connection is replaced by a second antenna 20' extending in a direction different from the direction of antenna 20, the signal instruments being connected between the antennæ as indicated by the winding 24 of the indirect coupling. In this figure also is shown the arrangement by which the signal instruments are located in the chamber 26 below the surface of the earth.

In the embodiment of the invention shown in Fig. 3, a single antenna is employed and is shown extending horizontally substantially parallel with the surface of the earth, and with the inclosing metallic covering or casing resting upon the surface of the earth, which latter is indicated at 27.

Fig. 4 shows an arrangement similar to Fig. 3 but with the employment of a second antenna 20' in place of the ground connection shown in Fig. 3.

Fig. 5 shows an arrangement similar to Fig. 4, but with the antennæ slightly elevated above the surface of the earth by means of struts or pins 28. Thus while the antennæ extend substantially parallel with the surface of the earth, the metallic covering or casing is not in direct contact with the earth but is separated therefrom by a short space. It may or may not be insulated from the earth according to the material of which the struts or pins 28 are made that is whether they are of conducting or of non-conducting material.

Fig. 6 shows the employment of two antennæ submerged beneath the surface of the earth where there is water, the water being indicated at 29. Here the metallic covering or casing is in contact with the water, but the antennæ and their connecting circuits are insulated from the water.

It will be understood that while I have shown and described arrangements embodying my invention in which one antenna and also two antennæ are employed, any desired number may be used, and it is desirable to have them extend in the proper direction to obtain the maximum effect both in sending and receiving of the electromagnetic waves. For this purpose a number of antennæ may be employed radiating in different directions from the instruments, and suitable switching mechanism may be provided for connecting any one or more of the antennæ to the signal instruments. Such an arrangement is shown and described in the application of myself jointly with Henry H. Lyon, S. No. 130,603, issued as Patent No. 1,322,622, dated Nov. 25, 1919, to which reference is here made for further details, so

that it is unnecessary to describe such an arrangement in this application.

It has been stated that the invention is applicable to the surface of the earth where there is water, one such application being illustrated in Fig. 6. It will be understood also that the invention is also applicable to ships at sea, but as the employment of my new antenna arrangement in such connection is obvious it is thought that illustration is unnecessary.

In accordance with the patent statutes I have described what I now believe to be the best embodiment of the invention, but I do not wish to be understood thereby as limiting myself or the scope of the invention, as many changes and modifications may be made without departing from the spirit of the invention and all such I aim to include in the scope of the appended claims.

What I claim as new and desire to secure by Letters Patent of the United States is:

1. A radio signaling system comprising an antenna extending horizontally substantially parallel to the surface of the earth and insulated therefrom, a metallic covering inclosing said antenna but insulated therefrom and in intimate contact with the earth substantially throughout its length, signal instruments associated with said antenna, and a balancing connection on the opposite side of said instruments.

2. A radio signaling system comprising an antenna extending horizontally substantially parallel to the surface of the earth and insulated therefrom, a metallic covering inclosing said antenna but insulated therefrom and in contact with the earth substantially throughout its length, and signal instruments associated with said antenna.

3. A radio signaling system comprising an antenna extending horizontally substantially parallel to the surface of the earth and insulated therefrom, a metallic covering inclosing said antenna but insulated therefrom, said metallic covering being buried in the earth in intimate contact therewith substantially throughout its length, and signal instruments associated with said antenna.

4. A radio signaling system comprising signal instruments, an antenna extending outwardly therefrom, a second antenna extending in a different direction, said antennæ being buried in the earth but insulated therefrom and substantially parallel to the surface of the earth, and said instruments being connected between said antennæ, and a metallic covering inclosing each of said antennæ substantially throughout its length but insulated therefrom and in intimate contact with the earth.

In testimony whereof I have heretofore set my hand.

JAMES HARRIS ROGERS.

R. A. WEAGANT.
 APPARATUS FOR PREVENTING STATIC INTERFERENCE IN RADIOSIGNALING.
 APPLICATION FILED DEC. 12, 1917.

1,353,002.

Patented Sept. 14, 1920.

Fig. 2.

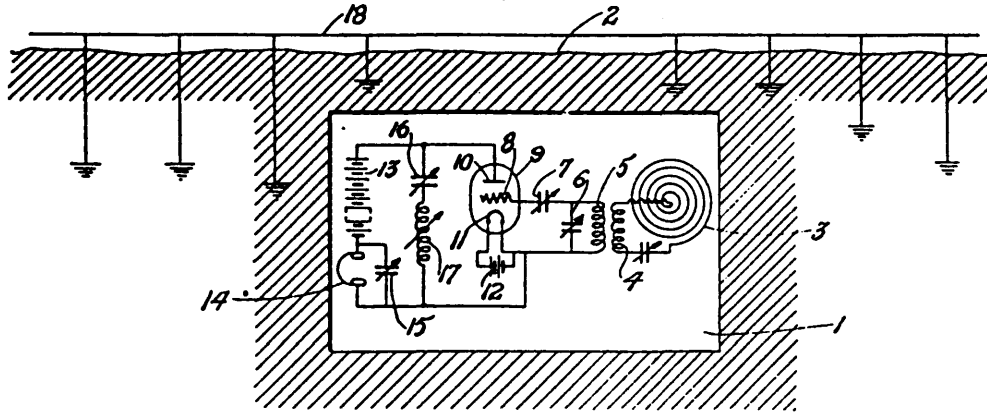
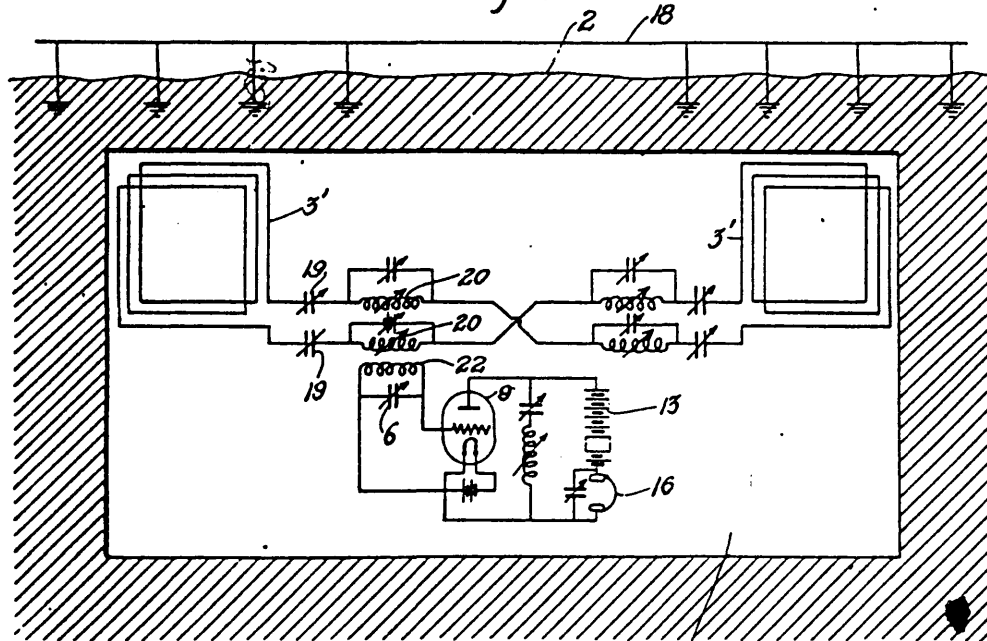

Fig. 1.



INVENTOR
Roy Alexander Weagant

BY
Sheffield & Betts
 his ATTORNEYS.

UNITED STATES PATENT OFFICE.

ROY A. WEAGANT, OF NEW YORK, N. Y., ASSIGNOR. BY MESNE ASSIGNMENTS, TO
RADIO CORPORATION OF AMERICA, A CORPORATION OF DELAWARE.

APPARATUS FOR PREVENTING STATIC INTERFERENCE IN RADIOSIGNALING.

1,353,002.

Specification of Letters Patent. Patented Sept. 14, 1920.

Application filed December 12, 1917. Serial No. 206,724.

To all whom it may concern:

Be it known that I, ROY ALEXANDER WEAGANT, a citizen of the United States, residing at Douglas Manor, in the county of Queens, city and State of New York, have invented or discovered certain new and useful Improvements in Apparatus for Preventing Static Interference in Radiosignaling, of which the following is a specification.

My invention relates to the art of radio signaling, and has for its principal object the provision of improved receiving apparatus for reducing or preventing static interference. In its preferred embodiment my invention is an improvement over the apparatus in my pending application Serial No. 181,458, filed July 19, 1917. In said application I call attention to the fact that whereas signal waves travel in a horizontal direction, and therefore affect successively the two parts of a divided antenna or collector disposed in the line of propagation of such waves, static waves affect the two parts of such an antenna simultaneously, and appear to be propagated in a vertical direction only, and I describe in said application means for making practical use of these observations for reducing or eliminating the effect of such static disturbances. My present invention is based on the further observation that the force or effect of static disturbance is very greatly diminished beneath the surface of the earth, whereas horizontally traveling signal waves, such as are now commercially used in radio signaling penetrate a substantial distance below the surface of the earth with small diminution in strength. In order to make practical use of these observations I place the receiver of my improved system, including the antenna or collector—the latter being preferably made as described in my said application—beneath the surface of the ground, and to further protect it from atmospheric disturbances, I cover the surface of the ground above the receiver with a metallic screen, as hereinafter described.

In the drawing accompanying and forming a part of this specification Figure 1 is a diagrammatic view of a receiving station embodying the preferred form of my invention, a divided collector of the general type

described in my said application being shown associated with receiving and detecting apparatus. Fig. 2 of the drawing is a diagrammatic view of a modified receiver in which a single collector is employed.

Referring in detail to the preferred form of apparatus shown in Fig. 1, 1 is a chamber beneath the surface 2 of the ground. Within this chamber there is disposed a divided collector having two coils 3' 3' disposed in a single vertical plane in the line of the signal waves to be received. The ends of the coils 3' are crossed and conductively connected so that a horizontally-extending portion of one collector opposes a similarly placed horizontal portion of the other collector. In the leads from each collector are variable capacities 19 and variable inductances 20, one of the inductance coils serving as the primary of a coupling transformer, the secondary of which is connected in the circuit of a detector or receiver of any approved type—that shown being a receiver of the vacuum valve type, comprising a vacuum valve 9 and an energizing battery 13. As this receiver and its mode of operation are now well known, it will not be described in detail.

A metallic conducting screen 18 is disposed on the surface of the ground above the receiving apparatus just described, and this screen is preferably grounded at a large number of points. In practice this screen may take the form of a net work of wires resting directly on the ground or a metallic screen of any kind supported immediately above the ground, as shown in the drawing.

Referring now to the modified apparatus shown in Fig. 2, this is in general the same as that shown in Fig. 1, except that the collector consists of a single coil 3 vertically disposed in the line of the signal waves to be received, instead of a plurality of coils as shown in Fig. 1. The ends of the coil 3 in this modified arrangement are connected to the oscillation transformer 4, the secondary of which is connected to the vacuum valve of receiver 9, which is shown to be of the same type referred to in connection with Fig. 1. The arrangement shown in Fig. 2 likewise comprises a screen 18 disposed along the surface of the ground.

From the foregoing it will be apparent

that the effects of atmospheric disturbances in both arrangements will be greatly reduced by reason of the fact that the collectors are beneath the surface of the ground, and from the fact that the apparatus is protected by a conducting screen against disturbances propagated in vertical directions. In addition the arrangement shown in Fig. 1, embodying, as it does, the principle of my earlier application, still further eliminates the effect of static disturbances by the use of the divided collectors. By reason of this arrangement static disturbances which succeed in penetrating the earth are in effect balanced out or canceled. That is to say, impulses set up in the collectors simultaneously, as by static disturbances, are made to oppose each other, whereas oscillations set up by signal waves being out of phase, act cumulatively on the detector.

While I have shown the collectors inclosed in a chamber beneath the surface of the ground, I have demonstrated that these collectors may be buried in the ground, and that successful operation may be had when they are so buried, even though the wires forming the collectors are not covered by insulation.

Having now described my invention what I claim is:

1. A receiving station for radio signals, comprising a collector disposed beneath the surface of the ground, in combination with a conducting screen disposed at the surface of the ground over the collector.

2. A receiving station for radio signals, all portions of which are beneath the surface of the ground, in combination with a conducting screen disposed at the surface of the ground over the station.

3. A receiving station for radio signals, comprising a looped collector disposed beneath the surface of the ground, in combination with a conducting screen disposed at the surface of the ground over the looped collector.

4. A receiving apparatus for wireless signals, comprising in combination, a pair of collectors lying beneath the surface of the ground in substantial alinement in the direction of desired reception, a detector circuit associated with said collectors, and means common to both said collectors for differentially affecting the detector circuit by static impulses received in said collectors.

ROY A. WEAGANT.

T. APPELBY AND L. M. KNOLL.
RADIO APPARATUS.
APPLICATION FILED JUNE 14, 1919.

1,365,579.

Patented Jan. 11, 1921.
3 SHEETS—SHEET 1.

FIG. 1.

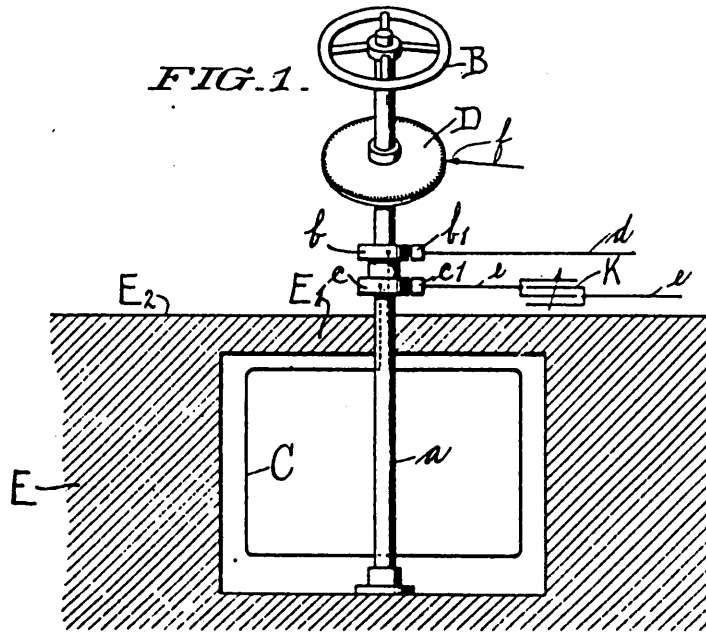

FIG. 2.

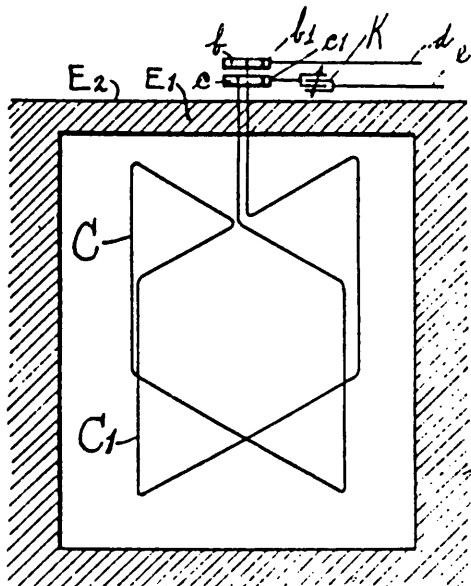
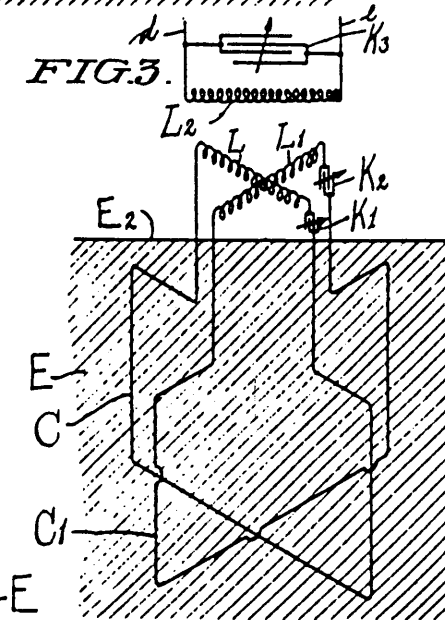

FIG. 3.



INVENTOR
Thomas Appelby and
Lloyd M. Knoll
BY
Conrad S. Chert
his ATTORNEY.

T. APPLEBY AND L. M. KNOLL.
 RADIO APPARATUS.
 APPLICATION FILED JUNE 14, 1919.

1,365,579.

Patented Jan. 11, 1921.
 3 SHEETS—SHEET 2.

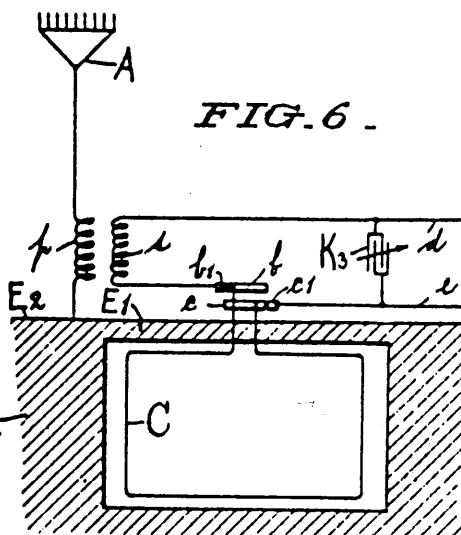
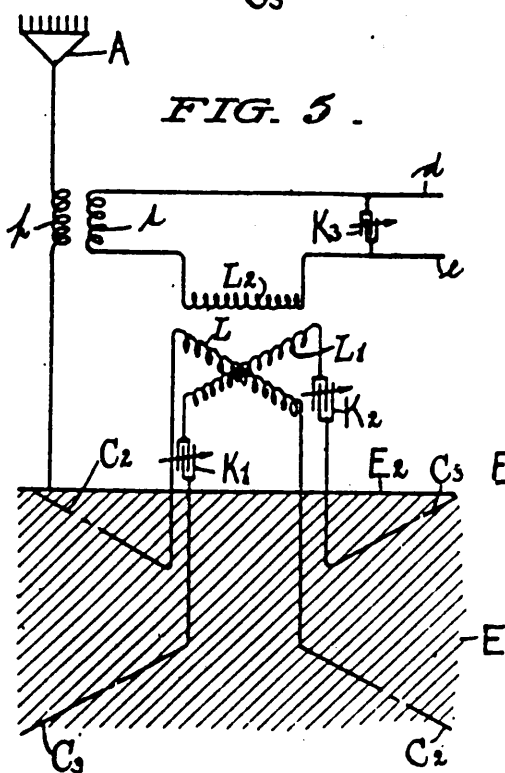
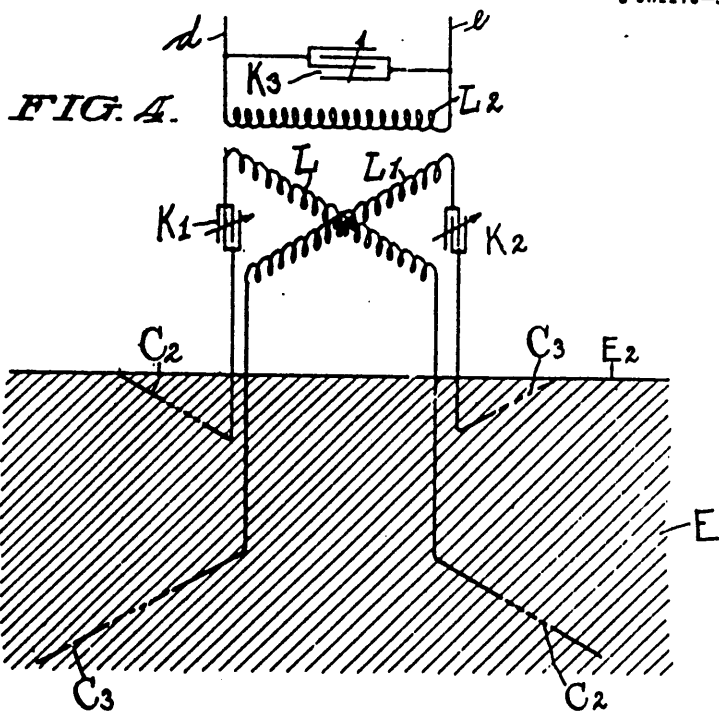

INVENTOR
 Thomas Appleby and
 Lloyd M. Knoll
 BY
 Charles S. Chert
 ATTORNEY.

T. APPLEBY AND L. M. KNOLL.
RADIO APPARATUS.
APPLICATION FILED JUNE 14, 1919.

1,365,579.

Patented Jan. 11, 1921.
3 SHEETS—SHEET 3.

FIG. 7.

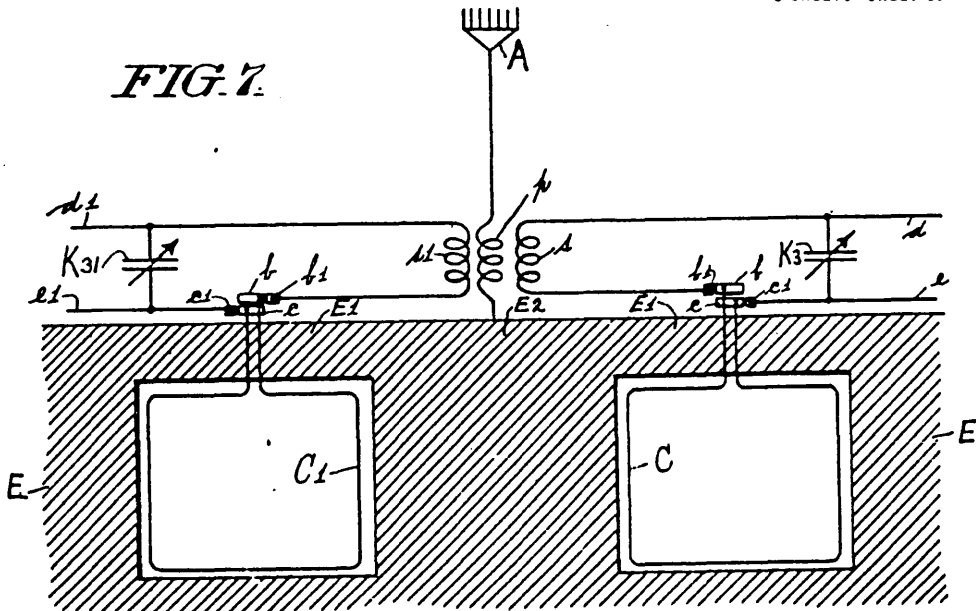
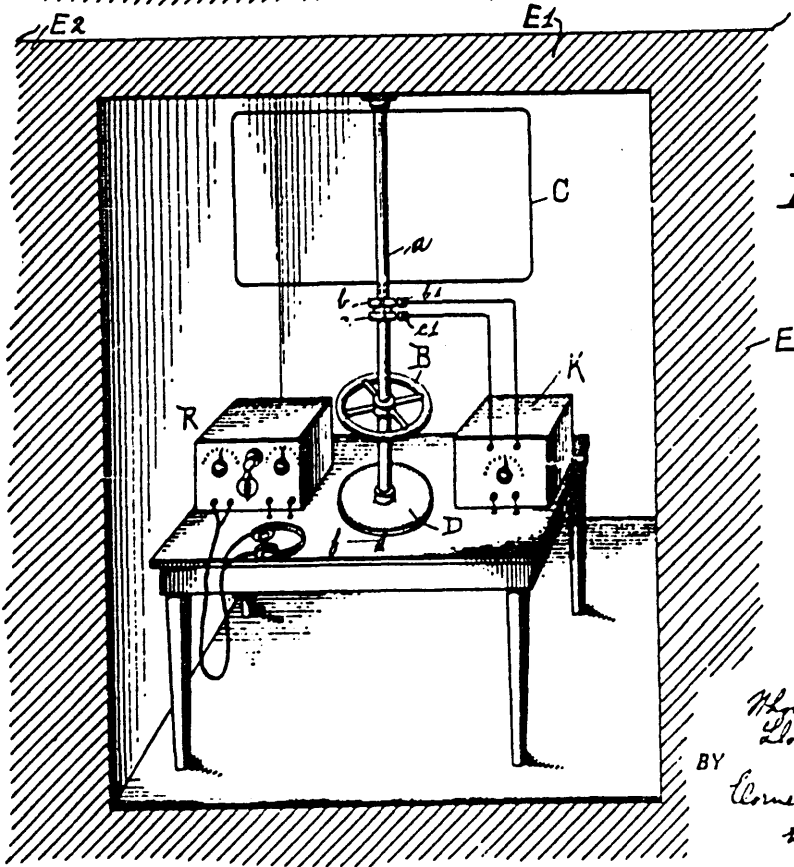

FIG. 8.



INVENTORS
Thomas Appleby and
Lloyd M. Knoll
BY
Cornelius L. Ebert
Attorney.

UNITED STATES PATENT OFFICE.

THOMAS APPLEBY AND LLOYD M. KNOLL, OF PHILADELPHIA, PENNSYLVANIA,
ASSIGNORS OF ONE-THIRD TO CORNELIUS D. EHRET, OF PHILADELPHIA,
PENNSYLVANIA.

RADIO APPARATUS.

1.365,579.

Specification of Letters Patent. Patented Jan. 11, 1921.

Application filed June 14, 1919. Serial No. 304,118.

To all whom it may concern:

Be it known that we, THOMAS APPLEBY and LLOYD M. KNOLL, citizens of the United States, residing in the city and county of Philadelphia, State of Pennsylvania, have invented certain new and useful Improvements in Radio Apparatus, of which the following is a specification.

Our invention relates to the transmission of high frequency energy, as electro-radiant energy, through the natural media for purposes of signaling, transmission of intelligence or messages, or for any other purpose.

Our invention resides in both transmitting and receiving apparatus for purposes of the character referred to, particularly for procuring directive effects and for preventing interference or other disturbances.

More particularly our invention resides in apparatus of the character referred to in which a part or the entire radiating or absorbing structure is more or less completely surrounded by a natural medium other than air, as for example, the earth or water; or such radiating or absorbing structure may be entirely or in part similarly more or less completely inclosed in a suitable screen or cage having the same or similar effects as the earth or water.

In connection with receiving apparatus employed as a radio compass because of directive effects as obtained, for example, by a rotatable absorbing coil structure, the accuracy of determination of direction of a source of radiant energy is sometimes materially interfered with by objects as conducting masses, or earth formations near the absorbing structure, with resultant distortion of the electric or magnetic field, or both, causing a variation of the determined direction from the true direction. By employment of our invention, however, the disturbing effects of distortion are materially reduced. And irrespective of distortion effects the critical maximum or minimum response in the receiving apparatus are more sharply defined whereby when the apparatus is so suitably shielded its directional or compass properties are improved.

Our invention resides also in multiplex apparatus of the character hereinafter described.

For an illustration of some of the many forms our structure may take, reference is

to be had to the accompanying drawings, in which:

Figure 1 is a view, partly diagrammatic, of apparatus comprising a rotatable absorbing or radiating-coil inclosed or screened by the earth or equivalent.

Fig. 2 is a similar view of a modified form where two rotatable coils at an angle to each other are employed.

Fig. 3 is a diagrammatic view of apparatus involving stationary radiating or absorbing coils at an angle to each other buried in the earth or otherwise screened.

Fig. 4 is a diagrammatic view of absorbing or radiating conductors disposed at an angle to each other and buried in the earth or similarly screened.

Fig. 5 is a view of apparatus comprising stationary absorbing or radiating structure buried in the earth or similarly screened in cooperation with absorbing or radiating structure disposed above the earth or outside of the screening structure.

Fig. 6 is a view of a rotatable radiating or absorbing coil structure buried in the earth or similarly screened in association with radiating or absorbing structure above the earth or external to the screening means.

Fig. 7 is a diagrammatic view illustrating multiplex apparatus.

Fig. 8 is a view, partly diagrammatic and partly in perspective, illustrating radiating or absorption structure together with connections thereto and instrumentalities cooperating therewith, all shielded.

Referring to Fig. 1, E represents the earth, water or equivalent screening or shielding means within which is buried or disposed a coil C of any suitable number of turns, rotatable by the shaft a about a vertical axis whereby the plane of the coil C may be caused to point in any direction. The terminals of the coil C terminate in the slip rings b, c, with which cooperate the brushes b₁, c₁, connected to the conductors d and e, with which may be associated the variable tuning condenser or capacity K, the conductors d and e connecting to any suitable receiving apparatus, as audion or thermionic detectors and amplifiers, when the apparatus is used as a radio compass or direction finder, or to any suitable source of high frequency oscillations when the apparatus is to be used for transmitting. Carried by the shaft a is

the compass scale or card D, with which operates a stationary pointer f , the shaft a and therefore the coil C and compass card D being rotatable by the hand wheel B.

5 When the apparatus is used as a radio compass, for example the shaft a is rotated until the coil C assumes that position giving either maximum, minimum or other critical response in the receiving apparatus to thereby determine the direction of a source of radiant energy located, for example, upon a ship which is steering into a harbor at or in the vicinity of which the coil C is installed.

10 It has been found that where such a radio compass is installed near masses of conducting material, or near unsymmetrical earth formations as a hill or cliff, a distortion of the electric or magnetic fields; or both, takes place, with the result that for critical response in the receiving apparatus the plane of the coil C will not coincide truly with the plane in which the source of radiant energy is disposed. However, by locating the absorbing structure in such position that it is wholly or largely surrounded by the earth or equivalent, the errors introduced by the aforesaid distortion are materially reduced.

15 While we have shown the absorbing structure C entirely surrounded by earth or equivalent, even by the covering portion F_1 , it will be understood that improved effects will be obtained even without such covering material; furthermore, the absorbing structure C may even project more or less above the earth's surface, though it is preferred that it be entirely beneath the surface E_2 .

20 In Fig. 2 the absorbing structure comprises two coils C and C_1 , each of any suitable number of turns, disposed at an angle with respect to each other and rotatable as in the case of Fig. 1. The coils C, C_1 are shown connected in series with each other, though it will be understood they may be connected in parallel. Here again any suitable transmitting or receiving apparatus may be associated with the coil structure C, C_1 , which may be either a radiating or absorbing structure.

25 In Fig. 3 the coils C and C_1 are stationary and buried or to a large part disposed in the earth E or equivalent, with their planes at an angle with respect to each other. In series with the coil C is connected a variable inductance L and variable capacity K_1 ; and in series with the coil C_1 is a variable inductance or coil L_1 and a variable capacity K_2 . Thus the coil circuits may be tuned to the energy to be absorbed or transmitted. The coils L, L_1 are placed at an angle with each other, preferably at an angle equal to the angle between their coils C, C_1 . In inductive relation to both coils L, L_1 is disposed

30 a rotatable adjustable coil or inductance L_2 whose circuit may be tuned by the variable capacity K_3 . When the apparatus is used as a direction finder or directionally selective receiver, there is associated with the coil L_2 and condenser K_3 a suitable detecting apparatus, the coil L_2 being rotated with respect to the stationary coils L and L_1 until a maximum or minimum response is obtained, whereupon the direction of the axis of the coil L_2 is then an indication of the direction of the source of radiant energy. While two coils C and C_1 are shown, it will be understood also that our invention comprises the use of only one of them, or of more of them.

35 In Fig. 4 in lieu of closed coils there are buried in the earth E or equivalent one or more insulated conductors C_2 and C_3 disposed at an angle with respect to each other; and in series with these conductors are the adjustable inductances and condensers L, K_1 and L_1 , K_2 , and adjustable inductance or coil L_2 being rotatable with respect to the inductances L, L_1 as described in connection with Fig. 3. With the inductance L_2 is associated the tuning condenser K_3 . Here again either for absorption or radiation a directive effect is obtained, the detecting apparatus being associated with condenser K_3 and inductance L_2 for reception or direction finding, or upon them may be impressed oscillations generated by any suitable source for transmitting purposes.

40 In Fig. 5 the arrangement is substantially similar to that of Fig. 4 so far as concerns one or more conductors C_2 and C_3 , inductances L, L_1 , L_2 and condensers K_1 , K_2 and K_3 . In series or otherwise suitably associated with the rotatable inductance L_2 and the condenser K_3 is a secondary s of an oscillation transformer whose primary p is in series with the antenna A connected to earth E or to any other suitable capacity. When the apparatus is used for reception as direction finding, the receiving apparatus connected to the conductors d and e is subjected to the conjoint effects of the buried conductors C_2 and C_3 as well as the effects produced in the aerial A, the aerial and all circuits preferably being attuned to the frequency of the received energy. By this combination the accuracy of determining direction is improved, the burying or equivalent shielding of the conductors C_2 and C_3 assisting in preventing effects of distortion.

45 In Fig. 6 the antenna is associated with a coil structure C of any suitable number of turns, which is preferably rotatable as described in connection with Fig. 1, the coil C and the antenna A cooperatively affecting the receiving apparatus connected to the receiving conductors d and e . The coil structure C may be of any suitable number of turns

and may be fixed or stationary, or may comprise coils fixed or stationary as in Figs. 2 and 3.

In both the cases of Figs. 5 and 6 the apparatus may be employed for direction finding or reception in general, or for directional transmitting by impressing upon both the antenna structure and the buried or shielded structure high frequency oscillations from any suitable source.

In arrangements such as indicated in Figs. 5 and 6, wherein in addition to directive transmitting or receiving structure there is employed in cooperation an antenna structure, the entire combination has uni-lateral characteristics in that in a direction opposite to that in which maximum transmitting and receiving effects are possible the transmitting and receiving effects are zero. In these combinations the burying or shielding of the directive elements, as conductors C_2 , C_3 of Fig. 5 and coil or coils C of Fig. 6, does not interfere with the uni-lateral characteristics, but increases the capacity of the apparatus as an entirety sharply to determine direction, either for transmitting or receiving, in addition to the advantage gained in eliminating or reducing distortion effects.

With uni-lateral arrangements of the character indicated in connection with Figs. 5 and 6, multiplex reception or transmission is readily effected by associating with the antenna any suitable number of shielded or buried structures each utilizable for a different direction of reception or transmission when cooperating with the antenna. In this connection each of the buried or shielded structures may have its own separate and distinct coupling, like p , s , with the cooperating antenna. Thus, messages from a plurality of transmitting stations located in different directions from the receiving apparatus such as shown in Figs. 5 and 6 may be simultaneously received in the aforementioned multiplex arrangement because as to each of such transmitting stations a different uni-lateral maximum reception is possible at the receiving station. Such multiplex apparatus is indicated in Fig. 7, wherein two shielded radiating or absorbing structures, as rotatable coils C and C_1 , co-act with the same antenna structure A , which latter is coupled to them by the primary p and secondaries s and s_1 . With the secondary s are associated the condenser K_1 and connecting conductors d and e ; while with the secondary s_1 are associated the variable condenser K_2 and the connecting conductors d_1 and e_1 .

In arrangements of all of the characters herein described the burying or shielding of absorbing or transmitting structure in addition to lessening the effects of distortion as described, more sharply defines the critical maximum or minimum responses

in the receiving apparatus and more sharply defines the direction of maximum radiation in transmitting apparatus.

While in some of the figures connections from the buried or shielded structure are shown as above the earth or outside of the shielding structure, it is to be understood that these connections and instrumentalities may also be buried or shielded. For example, in the cases of Figs. 1, 2 and 6 the receiving apparatus might be in the same chamber or cavity with the rotatable coil structures. And in connection with immovable shielded or buried structure as in Figs. 3, 4 and 5 the connections therefrom and appurtenant apparatus may be separately shielded, or may be disposed in a chamber or cavity in the earth or similarly shielded. Where the connections are above ground or outside the shielding structures, as diagrammatically indicated in some of the figures, such connections may themselves act somewhat as antennae, and so tend to produce undesired distortion or effects in the nature of uni-lateral effects. In Fig. 8 is shown an arrangement whereby absorption structure, as rotatable coil C , similar to Fig. 1, together with the connections therefrom and the instrumentalities employed therewith are all shielded. Thus, the connections from the absorption structure C to the condenser K , as well as the receiving instruments R , are shielded. It will be likewise understood that in case the structure C of Fig. 8 transmits or radiates energy, the associated transmitting apparatus may be similarly shielded.

We do not claim as our invention the combination of an antenna structure or path cooperating with a directional structure in transmitting or receiving apparatus for effecting uni-lateral operation, but claim as our invention in such combination the shielding by natural or artificial means, as earth or metallic screening structure, the directional structure of the combination.

For the sake of brevity, in the appended claims we employ the term "radio" as relating to undulatory, impulsive, or vibratory electrical effects transmitted through the natural media.

What we claim is:

1. The combination with radio transmitting or absorption structure comprising a rotary coil, of means for shielding said structure, whereby distortional effects are reduced and the directional characteristics increased.

2. The combination with radio transmitting or absorption structure comprising a coil rotatable about a substantially vertical axis, of means for shielding said structure, whereby distortional effects are reduced and the directional characteristic increased.

3. The combination with radio transmit-

ting or absorption structure comprising a rotary coil, of a natural medium other than air in which said rotary coil is shielded and to or from which said coil directly transmits or receives energy, whereby distortional effects are reduced and the directional characteristic increased.

4. The combination with radio transmitting or absorption structure comprising a coil rotatable about a substantially vertical axis, of a natural medium other than air in which said rotary coil is shielded and to or from which said coil directly transmits or receives energy, whereby distortional effects are reduced and the directional characteristic increased.

5. The combination with radio transmitting or absorption structure comprising a rotary coil, of means for shielding said structure, whereby distortional effects are reduced and the directional characteristic increased, and an unshielded antenna structure cooperating with said coil and independently transmitting or receiving energy.

6. The combination with radio transmitting or absorption structure comprising a coil rotatable about a substantially vertical axis, of means for shielding said structure, whereby distortional effects are reduced and the directional characteristic increased, and an unshielded antenna structure cooperating with said coil and independently transmitting or receiving energy.

7. The combination with radio transmitting or absorption structure comprising a rotary coil, of a natural medium other than air in which said rotary coil is shielded and to or from which said coil directly transmits or absorbs energy, whereby distortional effects are reduced and the directional characteristic increased, and a cooperating antenna structure.

8. The combination with radio transmitting or absorption structure comprising a coil rotatable about a substantially vertical axis, of a natural medium other than air in which said rotary coil is shielded and to or from which said coil directly transmits or absorbs energy, whereby distortional effects are reduced and the directional characteristic increased, and a cooperating antenna structure.

9. Radio receiving apparatus comprising a rotatable coil absorbing energy directly from a natural medium, means for shielding said coil, and variable capacity in circuit with said coil for tuning said circuit to the frequency of the energy absorbed from said natural medium.

10. Radio receiving apparatus comprising an unshielded antenna structure, a coil directly absorbing received energy and co-acting with said antenna structure, a shield for said coil, and variable capacity for tuning

the circuit of said coil to the frequency of the received energy.

11. Radio receiving apparatus comprising a stationary unshielded antenna structure, a rotary coil directly absorbing received energy and co-acting with said antenna structure, a shield for said coil, and variable capacity for tuning the circuit of said coil to the frequency of the received energy.

12. Multiplex radio transmitting or receiving structure comprising an antenna structure, and a plurality of shielded coils directly radiating or absorbing energy and co-acting with said antenna structure for either transmitting or receiving.

13. Multiplex radio transmitting or receiving structure comprising an unshielded antenna structure, and a plurality of rotatable shielded coils directly radiating or absorbing energy and co-acting with said antenna structure for either transmitting or receiving.

14. Radio transmitting or receiving apparatus comprising an unshielded antenna structure, a shielded radiating or absorbing structure co-acting therewith for either transmitting or receiving and having an independent oscillation path, and means for separately attuning the oscillation path of said shielded structure.

15. Multiplex radio receiving apparatus comprising an unshielded antenna structure, and a plurality of shielded structures directly absorbing received energy independently of said antenna structure and co-acting with said antenna structure in absorbing received energy, and signal translating means co-acting with each of said shielded structures and said unshielded antenna structure.

16. Multiplex radio receiving apparatus comprising an unshielded antenna structure, and a plurality of shielded coils each directly absorbing received energy and co-acting with said antenna structure in absorbing received energy, and signal translating means co-acting with each of said coils.

17. Multiplex radio receiving apparatus comprising an unshielded antenna structure, and a plurality of shielded structures directly absorbing receiving energy independently of said antenna structure and co-acting with said antenna structure in absorbing received energy, signal translating means co-acting with each of said shielded structures and said unshielded antenna structure, and means for attuning the oscillation paths of said shielded structures to the frequency of received energy.

18. Multiplex radio transmitting or receiving structure comprising an antenna structure, and a plurality of radiating or absorbing structures each adjustable as to its angular position with respect to the distant

65

70

75

80

85

90

95

100

105

110

115

120

125

receiving or transmitting station and independently co-acting with said antenna structure in radiating or absorbing energy.

19. Multiplex radio transmitting or receiving structure comprising an antenna structure, and a plurality of radiating or absorbing rotary coils each independently co-acting with said antenna structure in radiating or absorbing energy.

20. Multiplex radio receiving apparatus comprising an antenna structure, and a plurality of rotatable coils each co-acting independently with said antenna structure in radiating or absorbing energy, and signal translating means co-acting with each of said coils.

21. Radio transmitting or absorbing apparatus comprising an antenna structure, and a shielded rotatable coil directly transmitting or absorbing energy to or from a natural medium and co-acting with said antenna structure.

22. Multiplex radio transmitting or re-

ceiving structure comprising an unshielded antenna structure, and a plurality of radiating or absorbing coils each adjustable as to its angular position with respect to the distant receiving or transmitting station and independently co-acting with said antenna structure in radiating or absorbing energy, and means for shielding at least one of said coils.

23. Multiplex radio transmitting or receiving structure comprising an antenna structure, and a plurality of rotary coils independently radiating or absorbing energy to or from a natural medium and each independently co-acting with said antenna structure in radiating or absorbing energy, and means for shielding at least one of said coils.

In testimony whereof we have hereunto affixed our signatures this 9th day of June, 1919.

THOMAS APPLEBY.
LLOYD M. KNOLL.

E. T. JONES.
 UNDERGROUND OR UNDERWATER ANTENNA SYSTEM.
 APPLICATION FILED APR. 11, 1919.

1,372,658.

Patented Mar. 22, 1921.

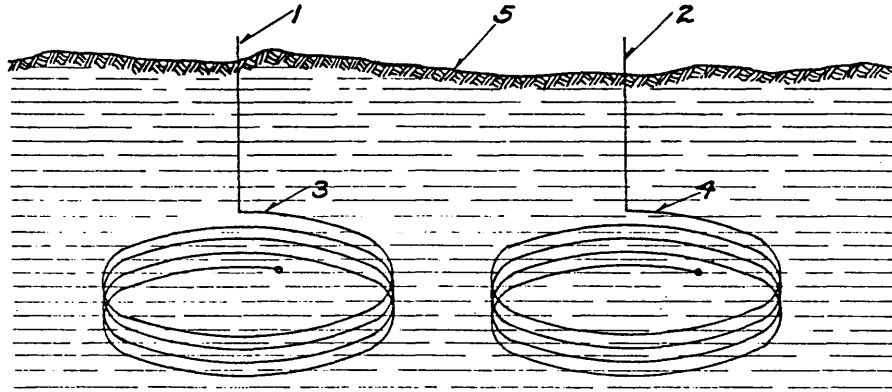

Fig. 1

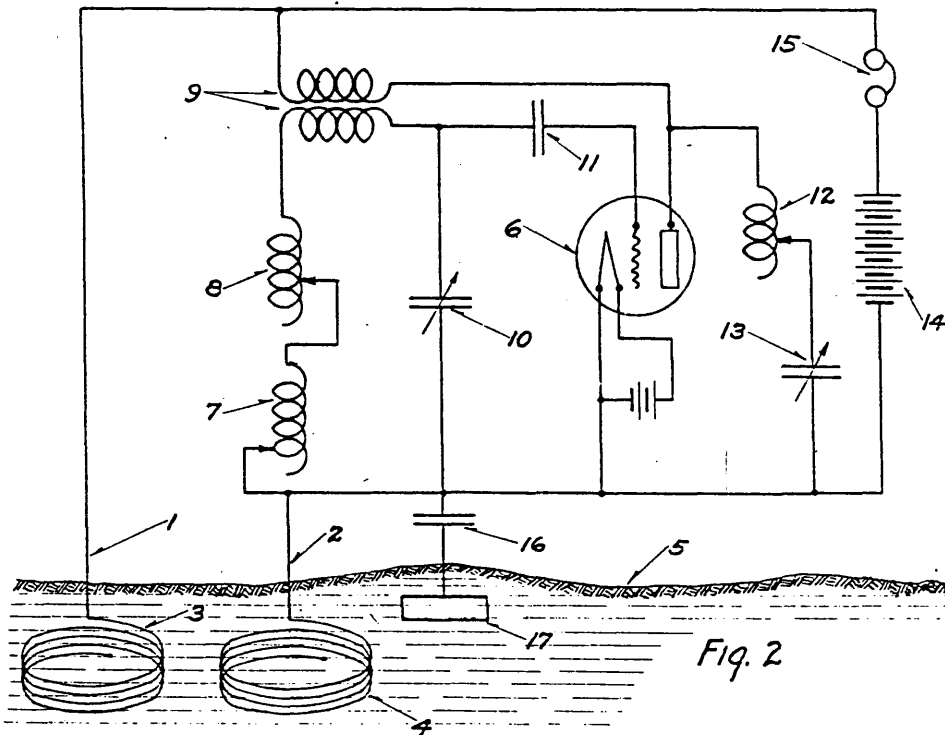

Fig. 2

WITNESSES
J. B. Brady
E. C. Hanson

INVENTOR
 E. T. JONES
 BY *E. H. Houghton*
 HIS ATTORNEY

UNITED STATES PATENT OFFICE.

EDWARD THOMAS JONES. OF NEW ORLEANS. LOUISIANA.

UNDERGROUND OR UNDERWATER ANTENNA SYSTEM.

1,372,658.

Specification of Letters Patent. Patented Mar. 22, 1921.

Application filed April 11, 1919. Serial No. 289,427.

To all whom it may concern:

Be it known that I, EDWARD THOMAS JONES, a citizen of the United States, stationed at the United States Naval Station, New Orleans, Louisiana, have invented an Improvement in Underground or Underwater Antennæ Systems, of which the following is a specification.

My invention relates broadly to radio communication and more particularly to underground and underwater antennæ systems for radio reception or transmission.

The object of this invention is to provide an underground or underwater antennæ system utilizing concentrated energy collecting means.

In prior underground antennæ systems it has been the practice to employ buried insulated cables of great length which systems require the construction of costly trenches and occupy extensive areas.

In the accompanying drawings are shown diagrammatically the electrical circuits illustrative of my invention. Figure 1 shows concentrated energy collecting means buried in the earth, and Fig. 2 discloses an oscillating radio frequency signal responsive circuit connected to the concentrated energy collecting means illustrated in Fig. 1.

As indicated in Fig. 1, concentrated energy collecting means 3 and 4 are buried in the earth 5 and electrically connected by insulated conductors 1 and 2 with the radio receiving apparatus.

In the particular drawing selected to illustrate the principle of my invention the concentrated energy collecting means 3 and 4 are shown as coils of insulated wire having the free ends suitably covered. While it will be understood that I do not limit myself specifically to this way of obtaining concentrated energy collecting means to be used as underground or underwater radio antennæ, nevertheless I have found this procedure practical in actual operation of such underground or underwater antennæ systems.

In Fig. 2 the coils 3 and 4 buried in the earth 5 are shown diagrammatically as being connected by means of insulated conductors 1 and 2 with a radio signal receiving circuit. This circuit comprises an audion detector 6, associated with the usual tuned oscillating circuit with variable condensers

10, 13, fixed condenser 11, inductances 7, 8, 9 and 12, high voltage battery 14 and a signal responsive device 15. The plate 17 buried in the earth is connected through a one microfarad condenser 16 to the tuned oscillatory circuit above described. The signal responsive device 15 may be for example, the well known telephone receiver ordinarily used in radio receiving stations.

In Figs. 1 and 2 the coils 3 and 4 are illustrated as buried in the earth 5. If desired the coils 3 and 4 may be placed in water, for example they could be submerged at a suitable depth and distance apart in a lake or river.

I have found from practical tests that it is possible to readily receive radio messages employing the system herein described at a time when it was impossible to copy radio messages using the usual form of overhead antennæ systems. Strays do not affect, to any noticeable extent, the practical operation of the underground and underwater antennæ system described, due to the concentrated form of the energy collecting means as opposed to the previous practice of employing long cable collecting means, which cables pick up increased strays in proportion to their length.

While I have shown diagrammatically the concentrated coils placed vertically in the earth it is apparent that the coils can be placed with their axes in any plane other than vertical in the earth or water.

My invention has proven highly successful in practical tests conducted at the United States Naval Station, New Orleans, Louisiana. The antennæ comprised two coils, each containing 200 feet of Packard cable, the coils having a diameter of 4 feet. These coils were placed 30 feet apart on the bed of the Mississippi River at a depth of 12 feet and leads brought to receiving apparatus on a wharf 15 feet above the surface of the water. Strong signals were received from Swan Island, Burwood, Colon Panama, Key West and Miami Florida, Arlington Virginia, Guantanamo and Moro Castle Cuba, Great Lakes Station and many ships at sea.

I have described the underground and underwater antennæ system as being connected to radio receiving apparatus but it is apparent that the antennæ system may be used for transmitting purposes and the con-

centrated elements employed for radiating energy without departing from the principle of my invention.

What I claim as new and desire to secure by Letters Patent of the United States, is:—

5 1. In an antennæ system, the combination of a plurality of energy collecting means with radio apparatus, said energy collecting means comprising simple concentrated free
10 ended coils of insulated cable embedded in the earth.

2. In an antennæ system, the combination of a plurality of energy collecting means

with radio apparatus associated therewith, said energy collecting means comprising
15 simple concentrated free ended coils of insulated cable separated a relatively short distance apart and embedded in the earth.

3. In an antennæ system the combination with energy collecting means of a circuit
20 therebetween, and radio apparatus therein, said energy collecting means comprising flat concentrated free ended coils embedded in the earth and connected at each end of said circuit.

EDWARD THOMAS JONES.

E. C. HANSON.
UNDERGROUND LOOP ANTENNA.
APPLICATION FILED MAR. 19, 1919.

1,373,612.

Patented Apr. 5, 1921.

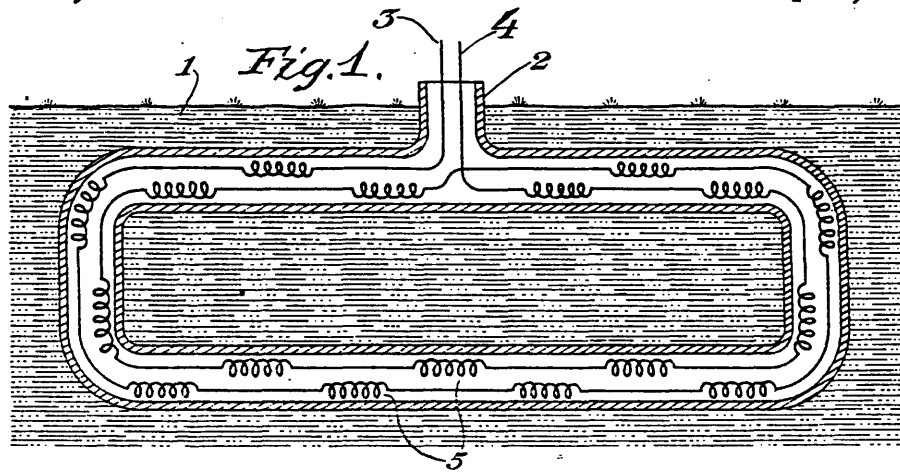
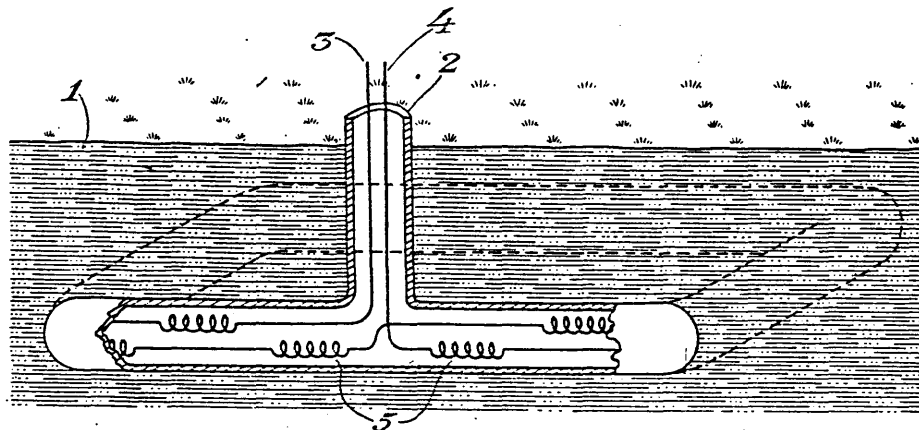

Fig. 2



WITNESS:

J. B. Brady

INVENTOR.

Earl C. Hanson

UNITED STATES PATENT OFFICE.

EARL C. HANSON, OF WASHINGTON, DISTRICT OF COLUMBIA.

UNDERGROUND LOOP-ANTENNA.

1,373,612.

Specification of Letters Patent.

Patented Apr. 5, 1921.

Application filed March 19, 1919. Serial No. 283,517.

To all whom it may concern:

Be it known that I, EARL C. HANSON, a citizen of the United States, and resident of Washington, District of Columbia, have invented a new and useful Improvement in Underground Loop-Antennæ, of which the following is a specification.

My invention relates to underground antenna systems for receiving radio signals, and more particularly to underground loop forms of antennæ.

The object of this invention is to provide a loop antenna adapted to be incased in a conduit and buried beneath the earth.

A further object of the invention is to provide such an underground loop antenna with filter coils inserted at intervals in the turns of the loop to prevent response to shock impulses produced by stray waves.

Referring to the drawings,

Figure 1 shows diagrammatically an underground vertical loop antenna;

Fig. 2 is a modification of Fig. 1, and indicates an underground loop antenna arranged in a horizontal plane below the surface of the earth.

Referring now more particularly to Fig. 1, reference character 2 represents a conduit buried in the earth 1. The conduit 2 is positioned vertically beneath the earth and incloses a number of convolutions of cable terminating at 3 and 4. Suitably located at intervals in the turns of the loop are filter coils 5 for the purpose to be more fully described hereinafter.

Fig. 2 represents a loop antenna system similar to that disclosed in Fig. 1, wherein the plane of the looped turns is parallel to the earth's surface.

This loop system is connected to suitable receiving apparatus at terminals 3 and 4. While the system has been described for use in conjunction with receiving apparatus, it is obvious that the antenna could be connected at 3 and 4 with radio transmitting apparatus and operated as a transmitting antenna. In Figs. 1 and 2, the loop system is shown as being underground, but it is well understood by those skilled in the art that such a loop antenna system can be submerged in water.

pendicularly to the surface of the earth arranged below said surface and a series of filter coils inserted at several points in the turns of the looped coil for substantially eliminating shock impulses in said coil.

3. An underground antenna system for radio signaling comprising a looped coil in-

In Figs. 1 and 2, the loop antenna systems are shown buried in a conduit. This conduit may be of any suitable material. In some cases it would be feasible to employ heavy insulated binding around the convolutions of the loop.

Considering the phenomenon of induced currents in the vertical loop coil, Fig. 1, from progressing radiated wave trains perpendicular to the surface of the earth, it is well known in the art that radiated waves do not penetrate earth or water to any appreciable depth. To utilize this phenomenon in an underground loop system, the coil shown in Fig. 1 is constructed of such dimensions and placed at such a depth as to allow only the top convolutions to be cut by the progressing wave trains, thus inducing currents which will actuate receiving apparatus connected to the terminals 3 and 4.

In Fig. 2 the progressing radiated perpendicular wave trains will induce currents in the turns of the horizontal loop and thereby actuate receiving apparatus connected to the terminals 3 and 4.

The filter coils 5 while not absolutely necessary are shown in the turns of the loop for the purpose of rendering the antenna irresponsive to any undesired frequency or shock excitation.

Resonant currents produced by passing wave trains of a definite frequency pass freely through the filter coils 5, while shock impulses produced by stray waves or waves of undesired frequencies are choked or filtered out. By filter coils it will be understood by those versed in the art is meant impedance or retardation coils represented at 5 throughout the several figures.

What I claim is:—

1. An underground antenna system for radio signaling comprising a looped coil inclosed in a conduit and arranged perpendicularly to the surface of the earth, and means electrically connected in the convolutions of the loop for substantially eliminating response to strays.

2. An underground antenna system for radio signaling comprising a looped coil having a plurality of turns positioned per-

closed in a conduit and buried beneath the surface of the earth and including a series of inductance coils within the turns thereof whereby response to shock excitation is substantially eliminated.

In testimony whereof I affix my signature.
EARL C. HANSON.

J. H. ROGERS.
 RADIOSIGNALING SYSTEM.
 APPLICATION FILED MAR. 9, 1920. RENEWED SEPT. 12, 1921.

1,395,454.

Patented Nov. 1, 1921.

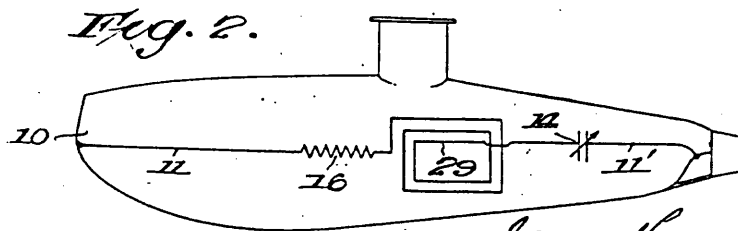
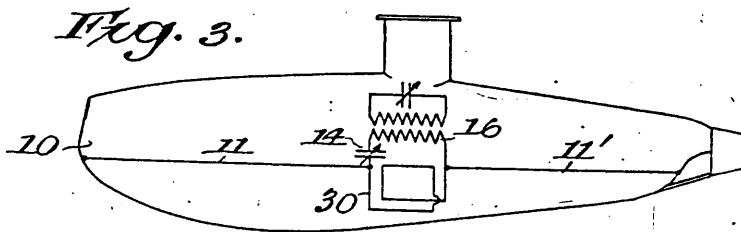
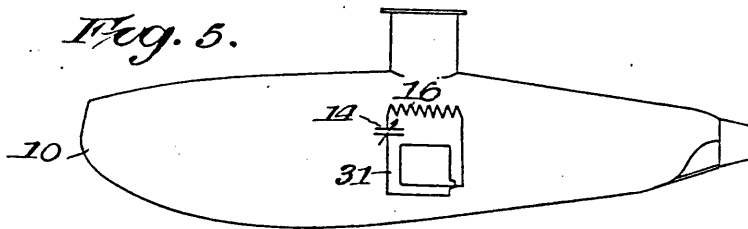
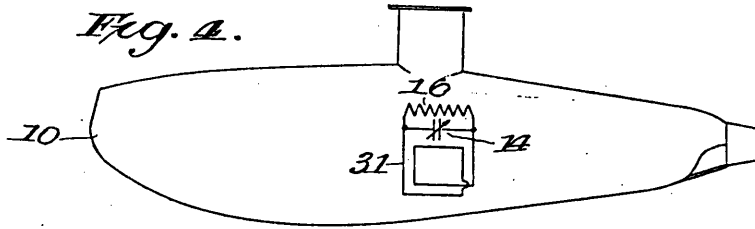
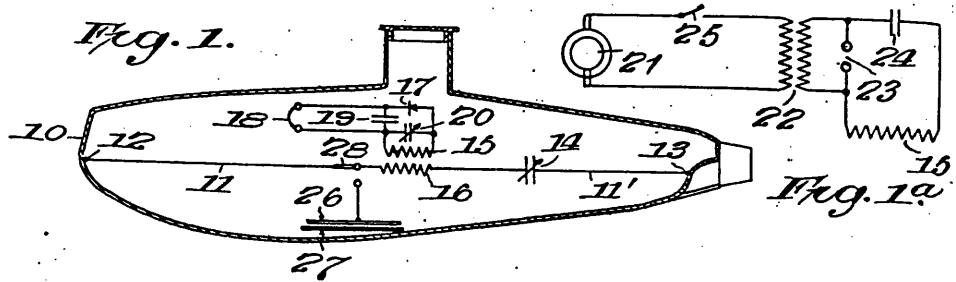

INVENTOR.
James Harris Rogers,
 by *Prentiss, Stone & Boyden,*
 ATTORNEYS.

UNITED STATES PATENT OFFICE.

JAMES HARRIS ROGERS, OF HYATTSVILLE, MARYLAND.

RADIO SIGNALING SYSTEM.

895,454.

Specification of Letters Patent.

Patented Nov. 1, 1921.

Application filed March 9, 1920, Serial No. 364,400. Renewed September 12, 1921. Serial No. 500,271.

Whom it may concern:

It is known that I, JAMES HARRIS ROGERS, a citizen of the United States, residing at Hyattsville, in the county of Prince Georges, State of Maryland, have invented certain new and useful Improvements in Radio-Signaling Systems, of which the following is a specification.

My invention relates to radio signaling and has for its object the provision of an improved system for use in connection with vessels, especially submarine vessels.

The invention includes the employment of an antenna or radio conductor upon which the signal electromagnetic waves are received, or from which such waves are radiated in sending, located within the metallic hull of the vessel, and in utilizing the vessel itself as part of the system. This and more specific objects will be fully explained hereinafter.

The invention consists in the novel construction and arrangement of parts of a radio system hereinafter described and claimed, and illustrated in the accompanying drawings, in which drawings:—

Figure 1 is a longitudinal section of a vessel with apparatus and circuits shown in diagram;

Fig. 1^a shows a conventional arrangement of sending instruments which may be substituted for the receiving instruments for transmitting signals;

Figs. 2, 3, 4 and 5 show in diagram various modifications of the invention, the vessel being indicated in outline.

Referring to the drawings and first particularly to Figs. 1 and 2 thereof, 10 indicates a vessel of the submarine type having

a metallic hull or sheathing which includes a deck or upper surface as well as the sides and bottom. Within the vessel is located an antenna or radio conductor 11—11' extending longitudinally of the vessel and having its ends electrically connected to the hull at 12 and 13. When the ends of the antenna are connected to the bow and stern of the hull respectively, I obtain the greatest advantage of the hull for a straight antenna

located therein, but it will be understood that the antenna may be made shorter and connected to the hull at other points if desired. If the antenna is not the proper length for the wave-length to be used, a tuning condenser may be employed as is well understood, and although it is thought this

need not be illustrated it is conventionally shown at 14.

Any well-known or desired radio signaling instruments may be associated with the antenna in a well known manner, as by coils 15, 16, of an inductive coupling or transformer. In Fig. 1 receiving radio or magnetic wave signaling instruments are conventionally shown in diagram, consisting of a detector 17 of any type, preferably an audion, telephone 18, and the usual condensers 19 and 20.

In Fig. 1^a suitable sending instruments are conventionally shown in diagram. These comprise a generator 21 or other source of alternating or other suitable current, transformer 22, spark gap 23, condenser 24 and key 25. These instruments are, of course, in the vessel and may be substituted for the receiving set when it is desired to transmit signals.

In the operation of the system as thus far described and supposing it is desired to receive signals from another submarine or other vessel, or from a land station, the receiving vessel is manipulated if necessary to obtain the best directional effect on its antenna which, being tuned to the proper wave-length, yields signals with clearness

and high audibility. It will thus be seen that my antenna extends longitudinally within the vessel and is completely inclosed by the metal (such as iron or steel) thereof. Moreover, the antenna forms a part of a loop conductor of which the hull of the vessel forms the other part.

In sending, the sending set is substituted for the receiving set and key 25 is manipulated as usual.

Instead of having the antenna extend from end to end of the vessel, one portion thereof, as 11, may be replaced by a capacity plate 26 which is located in proximity to, but separated by insulation 27 from the bottom or side of the hull. A switch 28 may be provided where it is desired to use or test the capacity as a substitute for a part of the antenna.

In Fig. 2, I have shown a coiled or looped portion 29 included in the antenna, this operating to obtain a greater length antenna and also improving the results in some instances.

Fig. 3 shows a closed circuit loop conductor connected in the circuit of antenna 11, 11', the tuning condenser being in series in

the loop. The loop itself is in shunt to the coil 16 of indirect coupling.

Fig. 4 shows a closed oscillating circuit looped antenna 31 entirely inclosed within the vessel but not connected electrically with the metallic hull or sheathing. The tuning condenser is bridged across the circuit.

Fig. 5 shows a similar arrangement except that the condenser is in series in the oscillating looped circuit. In both the arrangements the signal instruments are as in the other figures, and represented broadly by coil 16. Very good results are obtained by these arrangements.

In accordance with the patent statutes, I have described what I believe to be the best embodiment of the invention, but I do not wish to be understood as thereby limiting myself or the scope of the invention, as many changes and modifications may be made without departing from the spirit of the invention and all such I aim to include within the scope of the appended claims. For instance, a plurality of antennæ may be employed instead of one.

What I claim is:

1. The combination with a submarine vessel having a metallic hull or sheathing, of an antenna extending longitudinally within and inclosed by said hull or sheathing and electrically connected to the same, and signal instruments associated with said antenna.

2. The combination with a submarine vessel having a metallic hull or sheathing, of an antenna within and inclosed by said hull or sheathing, a portion at least of said antenna extending longitudinally of the vessel, and electrically connected to the hull or sheathing, and signal instruments associated with said antenna.

3. The combination with a submarine vessel having a metallic hull or sheathing, of an antenna extending longitudinally within and inclosed by said hull or sheathing with its ends at the ends of the vessel and electrically connected to corresponding ends of the same, and signal instruments associated with said antenna.

4. A radio signal system having a closed oscillating loop circuit comprising the metallic hull or sheathing of a vessel and a conductor extending longitudinally within and inclosed by and having its ends electrically connected with said metallic hull or sheathing, and signal instruments associated with said conductor.

5. A radio signal system having a closed oscillating loop circuit comprising the metallic hull or sheathing of a submarine vessel

and a conductor extending longitudinally within and inclosed by and having its ends electrically connected with said metallic hull or sheathing, and signal instruments associated with said conductor.

6. A radio signal system having a closed oscillating loop circuit comprising the metallic hull or sheathing of a vessel and a conductor extending longitudinally within and inclosed by and having its ends electrically connected with said metallic hull or sheathing, a tuning condenser in circuit with said conductor, and signal instruments associated with said conductor.

7. A radio signal system having a closed oscillating loop circuit comprising the metallic hull or sheathing of a vessel and a conductor extending longitudinally within and inclosed by and having its respective ends electrically connected with corresponding ends of said metallic hull or sheathing, a tuning condenser in circuit with said conductor, and signal instruments associated with said conductor.

8. The combination with a vessel having a metallic hull or sheathing, a closed oscillating loop within and inclosed by said hull or sheathing, a conductor extending from one side of said loop and making electrical connection with the hull or sheathing at approximately one end of the vessel, a second conductor extending from the other side of said loop and making electrical connection with the hull or sheathing at approximately the other end of the vessel, and electromagnetic wave signal instruments associated with said loop.

9. The combination with a vessel having a metallic hull or sheathing, an oscillating loop within said hull or sheathing, a conductor connecting said loop with the forward end of said hull and a second conductor connecting said loop with the rearward end of said hull, and radio signal instruments operatively associated with the circuit thus formed.

10. The combination with a vessel having a metallic hull or sheathing, an oscillating loop within said hull or sheathing, a conductor connecting said loop with the forward end of said hull and a second conductor connecting said loop with the rearward end of said hull, a tuning condenser in the circuit thus formed, and radio signal instruments operatively associated with said circuit.

In testimony whereof I affix my signature.

JAMES HARRIS ROGERS.

Sept. 10, 1929.

Q. C. A. CRAUFURD ET AL

1,727,536

WIRELESS SIGNALING SYSTEM

Filed Oct. 31, 1928

Fig.1.

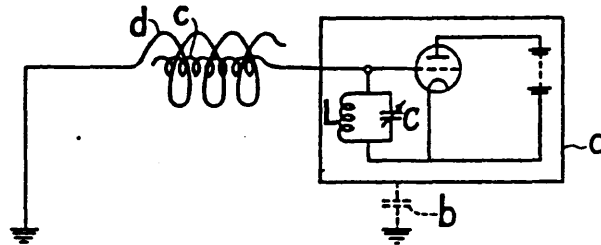

Fig.2.

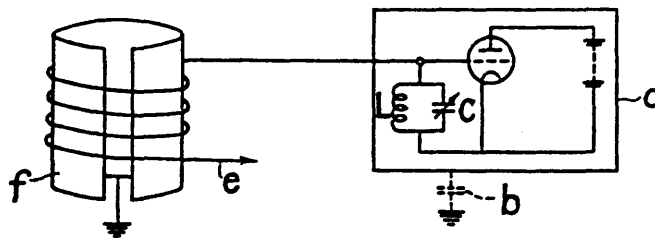

Fig.3.

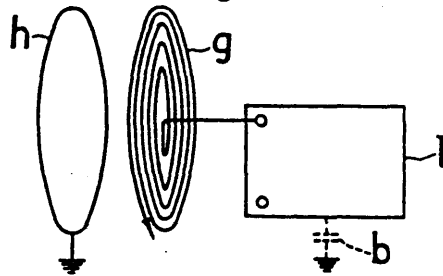

Fig.4.

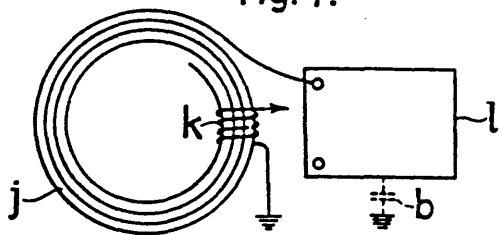
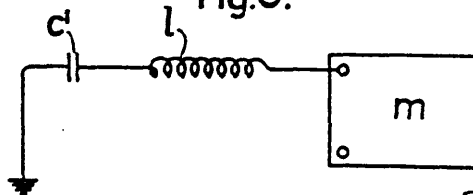

Fig.5.



INVENTORS
Q. C. A. CRAUFURD
C. C. J. FROST

By *D. T. Walcott*

UNITED STATES PATENT OFFICE.

QUENTIN CHARLES ALEXANDER CRAUFURD, OF LYDD, AND CYRIL CHARLES JAMES FROST, OF WINDSOR, ENGLAND.

WIRELESS SIGNALING SYSTEM.

Application filed October 31, 1928, Serial No. 316,300, and in Great Britain August 12, 1927.

This invention relates to wireless signaling systems and has for its object to provide a new or improved method of and means for transmitting and receiving electric radiations which are propagated through a conductive medium such as earth or sea. The invention may also be applied to wireless signaling apparatus disposed on or within a conducting body such as the hull of an airship, which may be surrounded by a dielectric medium.

According to the invention, wireless signaling apparatus is provided wherein electric oscillations or stationary electric waves are set up in a system of conductors which is electrostatically coupled to the earth or other conductive medium, such as the hull of a ship, but which has a low radiation resistance as regards the dielectric medium so that it is not appreciably affected under working conditions by Hertzian waves.

The invention, therefore, provides a means of utilizing the hysteresis in the said dielectric medium between earth and the said system of conductors which includes an inductance connected to earth or other conductive medium and one or more conductors possessing capacity relatively to earth and so acting as an equivalent condenser, and this utilization is effected by matching the lag due to polarization of the dielectric with the lag due to inertia of the inductance which, when charged by currents, creates a weak magnetic field around one armature of the afore-said capacity-possessing conductor or conductors forming the equivalent condenser.

This interaction of the two lags introduces such a time constant into the capacity of the equivalent condenser as to change that capacity relatively to the phase of the charging currents, the rate of change determining the position of a nodal or reflecting point for stationary waves while the magnetic field is being built up in one armature of the condenser and the dielectric is being polarized under the electric field.

In known systems of tuning, the inductance and capacity of the circuit are separate so that the E. M. F. may be brought into phase with the current or vice versa, but according to this invention, the inductance and capacity

are so closely associated at one point where the magnetic and electric fields are out of phase that a nodal point is produced according to each frequency.

Known systems of reception without using an elevated, or a frame, aerial have relied on buried antennæ, charged plates, or a plurality of condensers or of earth connections, or on the maintenance of electrical oscillations in the dielectric while receiving the incoming waves, but in the present invention one earth connection only is employed and the equivalent of one condenser in series with the oscillating circuit and it is not necessary to maintain oscillations in the dielectric and therefore the invention can be used in conjunction with a crystal detector.

The present invention is therefore an earth wave system wherein nodal points are formed relatively to the stationary waves set up in the earth or other conductive medium. The invention can also be used with advantage in an aerial circuit to sharpen the tuning by dividing the circuit into portions analogous to the fretting on a stringed instrument where the natural period of the string is altered by stopping and so creating nodal points where required.

In order that the invention may be more readily understood, reference will be made to the accompanying drawings in which:

Fig. 1 is a diagrammatic view of a radio signaling system embodying the novel features of the invention.

Fig. 2 is a view similar to Fig. 1 illustrating an alternative embodiment of the invention.

Fig. 3 is a view similar to Figs. 1 and 2 illustrating another alternative embodiment of the invention.

Fig. 4 is a view similar to Figs. 1 to 3 illustrating a further alternative embodiment of the invention; and

Fig. 5 is a view similar to Figs. 1 to 4 illustrating still another alternative embodiment of the invention.

In the arrangement shown in Figure 1, a conventional receiving set, having a tuned oscillatory circuit L. C. coupled to a valve detector, is enclosed in an insulated electrostatic

screen *a* which has a natural capacity to earth represented by the imaginary condenser shown in dotted lines at *b*.

The grid pole of the oscillatory circuit L. C. is connected to an oscillatory system which is electrostatically coupled to earth but which has a low radiation resistance so that it is not appreciably affected by Hertzian waves.

As indicated in the said Figure 1, the oscillatory system takes the form of two open coils *c, d* of insulated wire, wound one on the other, and connected one to earth and one to the grid pole of the oscillatory circuit L. C. as shown. For the purpose of reducing the mutual inductance as much as possible, the coils *c* and *d* are wound so that their turns cross one another at right angles.

The oscillatory system composed of the elements *c, d* will accept any frequencies within limits. It has a low radiation resistance such that it is not appreciably affected by Hertzian waves. Owing to the electrostatic coupling to earth however, the effect of electric oscillations transmitted through the earth will be to set up electric oscillations or stationary waves in the system *c, d*. The oscillation circuit L. C. is tuned to the frequency of the waves to be received and acts as a rejector for the selected frequency. When the circuit L. C. is correctly tuned, the acceptor composed of the elements *c, d* will apply magnified potential oscillations to the grid pole of the circuit L. C.

It will be seen that the acceptor could take many different forms.

For example, as shown in Figure 2, an open coil *e* of insulated wire connected at one end to the grid pole of the oscillatory circuit L. C. is wound on an earthed metal cylinder *f*.

Figure 3 shows an arrangement in which a flat spiral *g* of insulated wire is disposed adjacent an earthed metal disc *h*.

In Figures 3 and 4, the screen *a* is dispensed with and the coil *g* or *j* is connected to the aerial terminal of an ordinary receiving set. This set, together with the batteries, telephones and other devices associated therewith, is insulated from earth, but the filament supply leads and other conductors connected to the "earth" terminal of the set have a natural capacity to earth which is represented in the drawings by the imaginary condenser *b*.

In each of the arrangements shown in Figures 1-4, the screen *a* or the earth terminal of the receiving set (i. e. that pole of the circuit L. C. which is connected to the valve filament) may be connected to earth either directly or through a condenser. In most cases, however, the natural capacitive coupling represented by the imaginary condenser *b* is sufficient.

The oscillations induced in the system, *c, d, e, f, g, h* or *j, k* may be due in some measure to the fact that the system is electrostatically coupled to the earth at spaced points, i. e. at

the capacity between the elements of the oscillatory system and at the capacity between the receiving set or the screen *a* and the earth. The major effect, however, is probably due to the production of stationary electric waves in the conductors *c, d, e, f, g, h, j, k*; there being a potential loop at the grid pole of the oscillatory system L. C.

In the arrangement shown in Figure 5, *m* represents a conventional receiving set having a tuned oscillatory circuit and one or more valves (not shown) the whole of this apparatus (including batteries and telephone) being preferably insulated from the earth. The "aerial" terminal of the tuned oscillatory circuit is connected through an inductance *l* in series with a condenser *e'* to earth. When this system comes under the influence of electric oscillations transmitted through the earth, oscillations are set up in the system *l, e'* and affect the "aerial" terminal of the receiver.

Although the arrangements shown diagrammatically in the accompanying drawings are intended for use as receivers, it will be understood that the invention may be applied to transmitters by coupling any of the oscillatory systems described to a suitable generator of electric oscillations.

It will be understood that the arrangements described are independent of Hertzian waves transmitted from the radiating source through a dielectric medium, and can therefore be used underground, within the hulls of ships and in other places which are effectively screened as regards radiations which require a dielectric medium. Further, they could be used in the conducting hull of an airship, the oscillatory system being electrostatically coupled to the said conducting hull or to a conductor connected thereto.

We claim:—

1. In a radio signaling system, aperiodic collector means one end of which is free and the other end of which is connected to ground, a detector, and a coil in spaced relation to said aperiodic collector means connected with said detector, said aperiodic collector means comprising a coil the turns of which extend around the coil connected with the detector.

2. In a radio signaling system, aperiodic collector means one end of which is free and the other end of which is connected to ground, a detector, and a coil in spaced relation to said aperiodic collector means one end of which is free and the other end of which is connected with said detector, said aperiodic collector means comprising a coil the turns of which extend around the coil connected with the detector.

In testimony whereof we have affixed our signatures hereto this 19th day of October, 1928.

QUENTIN CHARLES ALEXANDER CRAUFURD.
CYRIL CHARLES JAMES FROST.



SECTION

4

DOUBLE GROUND
WITH
AERIAL CAPACITY

No. 750,429.

PATENTED JAN. 26, 1904.

F. BRAUN.
WIRELESS ELECTRIC TRANSMISSION OF SIGNALS OVER SURFACES.

APPLICATION FILED FEB. 6, 1899.

NO MODEL.

3 SHEETS—SHEET 1.

Fig. 1.

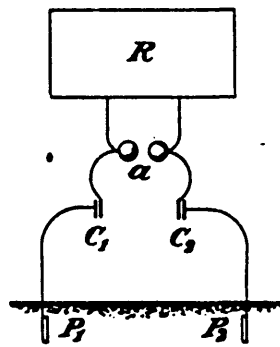

Fig. 2.

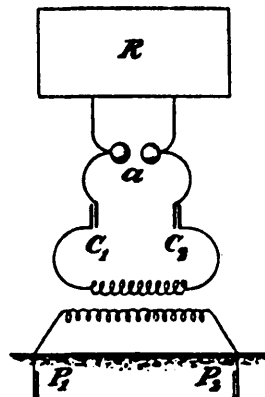

Fig. 3.

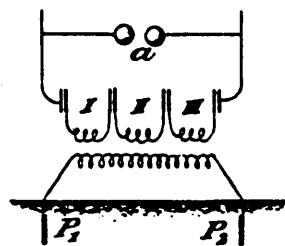

Fig. 5.

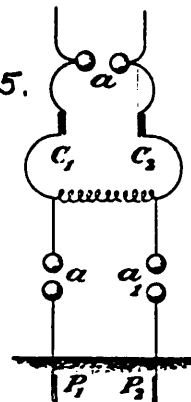
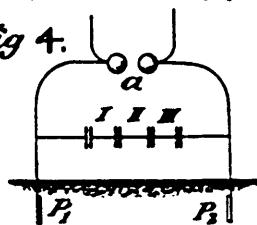

Fig. 4.



Attest
T. G. Hughes
Clerk

Inventor
Ferdinand Braun
By Philipp Phelps Sawyer
Atty

No. 750,429.

PATENTED JAN. 26, 1904.

F. BRAUN.

WIRELESS ELECTRIC TRANSMISSION OF SIGNALS OVER SURFACES.

APPLICATION FILED FEB. 6, 1899.

NO MODEL.

3 SHEETS—SHEET 2.

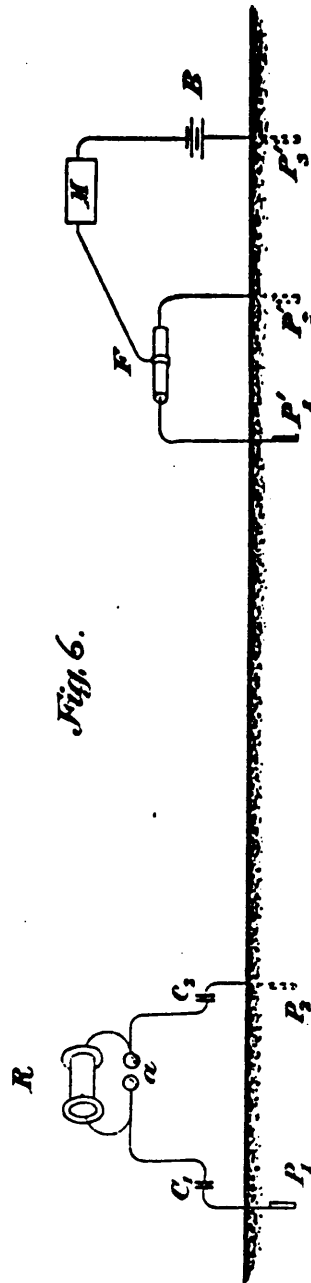

Fig. 6.

Attest:
T. F. Kehoe
G. M. Borah

Inventor
Ferdinand Braun
By Philip Phelps Sawyer
Atty

UNITED STATES PATENT OFFICE.

FERDINAND BRAUN, OF STRASSBURG, GERMANY.

WIRELESS ELECTRIC TRANSMISSION OF SIGNALS OVER SURFACES.

SPECIFICATION forming part of Letters Patent No. 750,429, dated January 26, 1904.

Application filed February 6, 1899. Serial No. 704,604. (No model.)

To all whom it may concern:

Be it known that I, FERDINAND BRAUN, a subject of the German Emperor, and a resident of Strassburg, Alsace, German Empire, have invented a new and useful Wireless Electric Transmission of Signals Over Surfaces, of which the following is a specification.

My invention relates to the transmission of electric signals without connecting-wires.

The accompanying drawings illustrate diagrammatically preferred apparatus for carrying out the invention.

Figure 1 shows a form of the transmitting apparatus. Fig. 2 shows an apparatus having induction-coils forming a transformer. Figs. 3, 4, and 5 show modifications hereinafter explained, and Fig. 6 shows the general arrangement of the electrical connections of the transmitting and receiving apparatus.

Hitherto the transmission of electric signals as above mentioned, usually termed "wireless telegraphy," has been based on the propagation of electric waves in space, and various difficulties have been encountered which have prevented such methods being satisfactory. According to my invention I avoid these difficulties by utilizing the surfaces of conducting-bodies as a medium for the transmission of the electric waves.

My invention is based on the fact, now well known to electricians, that when alternating currents of high frequency are supplied to cylindrical conductors the outer surface of the conductor is the important factor in transmitting the energy, and the inner portions of the conductor are of very little use. This fact, which is true for conducting bodies, is also true for semiconductors, such as water and earth, as experiments on a large scale have conclusively shown.

According to my invention I take advantage of the tendency above mentioned for electric-current waves to press toward the outer surface of a conductor or semiconductor by applying to two plates buried in the earth at a short distance apart an alternating current of very high intensity and frequency. The lines of flow of the current from one plate to the other will no longer take the shortest path, but will pass from their sources in large arcs

covering a considerable area. Within this area the current vibrations may be collected and utilized to give signals by devices of any suitable description. The application of the alternating current to the earth-plates can be arranged in various ways—for example, currents of high frequency may be created in a complete system by means of condensers, for instance, and these currents can be then supplied to the wires which lead to the earth-plates, or by means of rotary machines a very high frequency may be forcibly obtained which is independent of the self-induction and capacity of the earth-plates. With these details my present invention is not particularly concerned, as various methods of supply may be adopted. In order, however, that my invention may be clearly understood, I have shown in the accompanying diagrams various arrangements for supplying current to the earth-plates.

In Figs. 1 and 2, R represents a Ruhmkorff's induction-coil or a Holz's influence-machine, and *a a'* the spark-gaps in air or in oil. P' P'' are the earth-plates. This is the well-known apparatus used by Hertz, in which, as shown, for example, in Fig. 1, condensers may be interposed between the two pairs of balls. In Fig. 2 the earth-plates are connected with the spark-circuit through the medium of an induction-coil.

Figs. 3 and 4 show condensers joined in cascade, in Fig. 3 with primary coils interposed between the successive condensers, so as to act inductively on the circuit containing the earth-plates P' P'', and in Fig. 4 without any induction-coil.

Fig. 5 shows another arrangement in which two spark-gaps are provided in circuit with the earth-plates, in which the combined action of capacity and induction is used. The evident purpose of this arrangement is to retard the vibrations whose frequency depends in a well-known manner upon the product \sqrt{LC} , in which L signifies the self-induction, C the capacity. Various other arrangements of apparatus may be used.

The collection of the electric disturbances may be effected in the usual manner. Two earth-plates inserted at points of different pos-

tential and connected with each other by means of wire will serve for the purpose, a coherer being inserted in its circuit as a delicate receiving element.

5 A diagrammatical illustration of the manner of carrying out both the transmitting and receiving stations is shown in Fig. 6. R means a Ruhmkorff induction apparatus, with the air-gap *a*. C C' are the condensers; P' P'', the earth-plates, as mentioned above. All these are parts of the transmitting-station. In the receiving-station P' P'' are the collecting earth-plates; F, the well-known coherer or the like. M is a Morse apparatus with its battery B and earth-plate P'. In the moment of action a local circuit will be closed, comprising battery, Morse apparatus, coherer, and earth-plates, as the line coming from the battery is connected to the middle of the coherer. All these connections may be varied in the manner now well known by electricians well up in what has been done already in the line of wireless telegraphy.

The advantages of my improved system are, first, the suppression of aerial wires, with all their attendant evils and inconveniences; second, that the energy expended remaining upon the surface of the conductor it follows that the energy will not be diminished according to the square of the distance, as is the case when radiating freely through the space, but in a much less degree, being limited to surface extension; third, an uneven or a wood-
 30 ed surface will present no obstacle to the transmission.
 35

What I claim, and desire to secure by Letters Patent of the United States, is —

1. The method of transmitting signals elec-

trically from one station to another without the use of connecting-wires, consisting in supplying currents by means of an oscillation-circuit containing a condenser and a spark-gap to earth-plates connected to opposite poles of the transmitting apparatus, and collecting the impulses by earth-plates at the receiving-station connected to opposite poles of the collecting apparatus, substantially as described.

2. The method of transmitting signals electrically from one station to another without the use of connecting-wires, consisting in supplying currents by means of an oscillation-circuit containing a condenser, a spark-gap and an induction-coil to earth-plates connected to opposite poles of the transmitting apparatus, and collecting the impulses by earth-plates at the receiving-station connected to opposite poles of the collecting apparatus, substantially as described.

3. The method of transmitting signals electrically from one station to another without the use of connecting-wires, consisting in supplying currents produced by an oscillation-circuit containing a condenser, a spark-gap and the primary coil of a transformer to earth-plates connected to opposite poles of the secondary coil of said transformer, and collecting the impulses by earth-plates at the receiving-station connected to opposite poles of the collecting apparatus, substantially as described.

In testimony whereof I have hereunto set my hand in presence of two subscribing witnesses.

FERDINAND BRAUN.

Witnesses:

Fritz Niess,
 Max Adler.

No. 787,412.

PATENTED APR. 18, 1905.

N. TESLA.
ART OF TRANSMITTING ELECTRICAL ENERGY THROUGH THE NATURAL
MEDIUMS.

APPLICATION FILED MAY 16, 1900. RENEWED JUNE 17, 1902.

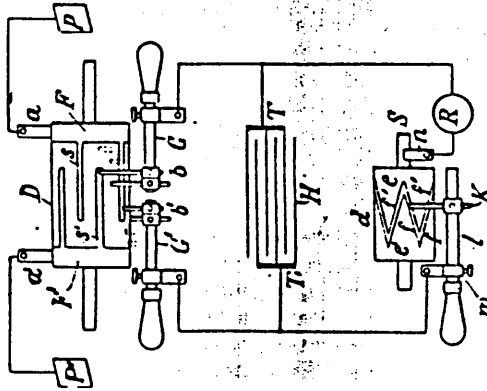

Fig. 2

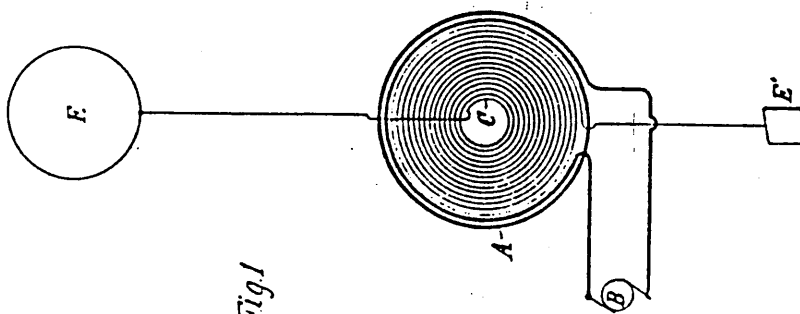

Fig. 1

Witnesses:
Papaël Peter
M. Lawson Dyer.

Nikola Tesla, Inventor
by New Page & Coole, Attys

UNITED STATES PATENT OFFICE.

NIKOLA TESLA, OF NEW YORK, N. Y.

ART OF TRANSMITTING ELECTRICAL ENERGY THROUGH THE NATURAL MEDIUMS.

SPECIFICATION forming part of Letters Patent No. 787,412, dated April 18, 1905.

Application filed May 16, 1900. Renewed June 17, 1902. Serial No. 112,034.

To all whom it may concern:

Be it known that I, NIKOLA TESLA, a citizen of the United States, residing in the borough of Manhattan, in the city, county, and State of New York, have discovered a new and useful Improvement in the Art of Transmitting Electrical Energy Through the Natural Media, of which the following is a specification, reference being had to the drawings accompanying and forming a part of the same.

It is known since a long time that electric currents may be propagated through the earth, and this knowledge has been utilized in many ways in the transmission of signals and the operation of a variety of receiving devices remote from the source of energy, mainly with the object of dispensing with a return conducting-wire. It is also known that electrical disturbances may be transmitted through portions of the earth by grounding only one of the poles of the source, and this fact I have made use of in systems which I have devised for the purposes of transmitting through the natural media intelligible signals or power and which are now familiar; but all experiments and observations heretofore made have tended to confirm the opinion held by the majority of scientific men that the earth, owing to its immense extent, although possessing conducting properties, does not behave in the manner of a conductor of limited dimensions with respect to the disturbances produced, but, on the contrary, much like a vast reservoir or ocean, which while it may be locally disturbed by a commotion of some kind remains unresponsive and quiescent in a large part or as a whole. Still another fact now of common knowledge is that when electrical waves or oscillations are impressed upon such a conducting-path as a metallic wire reflection takes place under certain conditions from the ends of the wire, and in consequence of the interference of the impressed and reflected oscillations the phenomenon of "stationary waves" with maxima and minima in definite fixed positions is produced. In any case the existence of these waves indicates that some of the outgoing waves have reached the boundaries of the conducting-path and have been reflected from the same. Now I have

discovered that notwithstanding its vast dimensions and contrary to all observations heretofore made the terrestrial globe may in a large part or as a whole behave toward disturbances impressed upon it in the same manner as a conductor of limited size, this fact being demonstrated by novel phenomena, which I shall hereinafter describe.

In the course of certain investigations which I carried on for the purpose of studying the effects of lightning discharges upon the electrical condition of the earth I observed that sensitive receiving instruments arranged so as to be capable of responding to electrical disturbances created by the discharges at times failed to respond when they should have done so, and upon inquiring into the causes of this unexpected behavior I discovered it to be due to the character of the electrical waves which were produced in the earth by the lightning discharges and which had nodal regions following at definite distances the shifting source of the disturbances. From data obtained in a large number of observations of the maxima and minima of these waves I found their length to vary approximately from twenty-five to seventy kilometers, and these results and certain theoretical deductions led me to the conclusion that waves of this kind may be propagated in all directions over the globe and that they may be of still more widely differing lengths, the extreme limits being imposed by the physical dimensions and properties of the earth. Recognizing in the existence of these waves an unmistakable evidence that the disturbances created had been conducted from their origin to the most remote portions of the globe and had been thence reflected, I conceived the idea of producing such waves in the earth by artificial means with the object of utilizing them for many useful purposes for which they are or might be found applicable. This problem was rendered extremely difficult owing to the immense dimensions of the planet, and consequently enormous movement of electricity or rate at which electrical energy had to be delivered in order to approximate, even in a remote degree, movements or rates which are manifestly attained in the displays of elec-

trical forces in nature and which seemed at first unrealizable by any human agencies; but by gradual and continuous improvements of a generator of electrical oscillations, which I have described in my Patents Nos. 645,576 and 649,621, I finally succeeded in reaching electrical movements or rates of delivery of electrical energy not only approximating, but, as shown in many comparative tests and measurements, actually surpassing those of lightning discharges, and by means of this apparatus I have found it possible to reproduce whenever desired phenomena in the earth the same as or similar to those due to such discharges. With the knowledge of the phenomena discovered by me and the means at command for accomplishing these results I am enabled not only to carry out many operations by the use of known instruments, but also to offer a solution for many important problems involving the operation or control of remote devices which for want of this knowledge and the absence of these means have heretofore been entirely impossible. For example, by the use of such a generator of stationary waves and receiving apparatus properly placed and adjusted in any other locality, however remote, it is practicable to transmit intelligible signals or to control or actuate at will any one or all of such apparatus for many other important and valuable purposes, as for indicating wherever desired the correct time of an observatory or for ascertaining the relative position of a body or distance of the same with reference to a given point or for determining the course of a moving object, such as a vessel at sea, the distance traversed by the same or its speed, or for producing many other useful effects at a distance dependent on the intensity, wave length, direction or velocity of movement, or other feature or property of disturbances of this character.

I shall typically illustrate the manner of applying my discovery by describing one of the specific uses of the same—namely, the transmission of intelligible signals or messages between distant points—and with this object reference is now made to the accompanying drawings, in which—

Figure 1 represents diagrammatically the generator which produces stationary waves in the earth, and Fig. 2 an apparatus situated in a remote locality for recording the effects of these waves.

In Fig. 1, A designates a primary coil forming part of a transformer and consisting generally of a few turns of a stout cable of inappreciable resistance, the ends of which are connected to the terminals of a source of powerful electrical oscillations, diagrammatically represented by B. This source is usually a condenser charged to a high potential and discharged in rapid succession through the primary, as in a type of transformer invented

by me and not well known; but when it is desired to produce stationary waves of great lengths an alternating dynamo of suitable construction may be used to energize the primary A. C is a spirally-wound secondary coil within the primary having the end nearer to the latter connected to the ground E' and the other end to an elevated terminal E. The physical constants of coil C, determining its period of vibration, are so chosen and adjusted that the secondary system E' C E is in the closest possible resonance with the oscillations impressed upon it by the primary A. It is, moreover, of the greatest importance in order to still further enhance the rise of pressure and to increase the electrical movement in the secondary system that its resistance be as small as practicable and its self-induction as large as possible under the conditions imposed. The ground should be made with great care, with the object of reducing its resistance. Instead of being directly grounded, as indicated, the coil C may be joined in series or otherwise to the primary A, in which case the latter will be connected to the plate E'; but be it that none or a part or all of the primary or exciting turns are included in the coil C the total length of the conductor from the ground-plate E' to the elevated terminal E should be equal to one-quarter of the wave length of the electrical disturbance in the system E' C E or else equal to that length multiplied by an odd number. This relation being observed, the terminal E will be made to coincide with the points of maximum pressure in the secondary or excited circuit, and the greatest flow of electricity will take place in the same. In order to magnify the electrical movement in the secondary as much as possible, it is essential that its inductive connection with the primary A should not be very intimate, as in ordinary transformers, but loose, so as to permit free oscillation—that is to say, their mutual induction should be small. The spiral form of coil C secures this advantage, while the turns near the primary A are subjected to a strong inductive action and develop a high initial electromotive force. These adjustments and relations being carefully completed and other constructive features indicated rigorously observed, the electrical movement produced in the secondary system by the inductive action of the primary A will be enormously magnified, the increase being directly proportionate to the inductance and frequency and inversely to the resistance of the secondary system. I have found it practicable to produce in this manner an electrical movement thousands of times greater than the initial—that is, the one impressed upon the secondary by the primary A—and I have thus reached activities or rates of flow of electrical energy in the system E' C E measured by many tens of thousands of horsepower. Such immense movements of elec-

tricity give rise to a variety of novel and striking phenomena, among which are those already described. The powerful electrical oscillations in the system E' C E being communicated to the ground cause corresponding vibrations to be propagated to distant parts of the globe, whence they are reflected and by interference with the outgoing vibrations produce stationary waves the crests and hollows of which lie in parallel circles relatively to which the ground-plate E' may be considered to be the pole. Stated otherwise, the terrestrial conductor is thrown into resonance with the oscillations impressed upon it just like a wire. More than this, a number of facts ascertained by me clearly show that the movement of electricity through it follows certain laws with nearly mathematical rigor. For the present it will be sufficient to state that the planet behaves like a perfectly smooth or polished conductor of inappreciable resistance with capacity and self induction uniformly distributed along the axis of symmetry of wave propagation and transmitting slow electrical oscillations without sensible distortion and attenuation.

Besides the above three requirements seem to be essential to the establishment of the resonating condition.

30 First. The earth's diameter passing through the pole should be an odd multiple of the quarter wave length—that is, of the ratio between the velocity of light—and four times the frequency of the currents.

35 Second. It is necessary to employ oscillations in which the rate of radiation of energy into space in the form of hertzian or electromagnetic waves is very small. To give an idea, I would say that the frequency should be smaller than twenty thousand per second, though shorter waves might be practicable. The lowest frequency would appear to be six per second, in which case there will be but one node, at or near the ground-plate, and, paradoxical as it may seem, the effect will increase with the distance and will be greatest in a region diametrically opposite the transmitter. With oscillations still slower the earth, strictly speaking, will not resonate, but simply act as a capacity, and the variation of potential will be more or less uniform over its entire surface.

Third. The most essential requirement is, however, that irrespective of frequency the wave or wave-train should continue for a certain interval of time, which I have estimated to be not less than one-twelfth or probably 0.08484 of a second and which is taken in passing to and returning from the region diametrically opposite the pole over the earth's surface with a mean velocity of about four hundred and seventy-one thousand two hundred and forty kilometers per second.

The presence of the stationary waves may be detected in many ways. For instance, a circuit may be connected directly or induct-

ively to the ground and to an elevated terminal and tuned to respond more effectively to the oscillations. Another way is to connect a tuned circuit to the ground at two points lying more or less in a meridian passing through the pole E' or, generally stated, to any two points of a different potential.

In Fig. 2 I have shown a device for detecting the presence of the waves such as I have used in a novel method of magnifying feeble effects which I have described in my Patents Nos. 685,953 and 685,955. It consists of a cylinder D, of insulating material, which is moved at a uniform rate of speed by clock-work or other suitable motive power and is provided with two metal rings F F', upon which bear brushes *a* and *a'*, connected, respectively, to the terminal plates P and P'. From the rings F F' extend narrow metallic segments *s* and *s'*, which by the rotation of the cylinder D are brought alternately into contact with double brushes *b* and *b'*, carried by and in contact with conducting-holders *h* and *h'*, supported in metallic bearings G and G', as shown. The latter are connected to the terminals T and T' of a condenser H, and it should be understood that they are capable of angular displacement as ordinary brush-supports. The object of using two brushes, as *b* and *b'*, in each of the holders *h* and *h'* is to vary at will the duration of the electric contact of the plates P and P' with the terminals T and T', to which is connected a receiving-circuit including a receiver R and a device *d*, performing the duty of closing the receiving-circuit at predetermined intervals of time and discharging the stored energy through the receiver. In the present case this device consists of a cylinder made partly of conducting and partly of insulating material *e* and *e'*, respectively, which is rotated at the desired rate of speed by any suitable means. The conducting part *e* is in good electrical connection with the shaft S and is provided with tapering segments *f* f', upon which slides a brush *k*, supported on a conducting-rod *l*, capable of longitudinal adjustment in a metallic support *m*. Another brush, *n*, is arranged to bear upon the shaft S, and it will be seen that whenever one of the segments *f*' comes in contact with the brush *k* the circuit including the receiver R is completed and the condenser discharged through the same. By an adjustment of the speed or rotation of the cylinder *d* and a displacement of the brush *k* along the cylinder the circuit may be made to open and close in as rapid succession and remain open or closed during such intervals of time as may be desired. The plates P and P', through which the electrical energy is conveyed to the brushes *a* and *a'*, may be at a considerable distance from each other in the ground or one in the ground and the other in the air, preferably at some height. If but one plate is connected to earth and the other maintained at an

elevation, the location of the apparatus must be determined with reference to the position of the stationary waves established by the generator, the effect evidently being greatest in a maximum and zero in a nodal region. On the other hand, if both plates be connected to earth the points of connection must be selected with reference to the difference of potential which it is desired to secure, the strongest effect being of course obtained when the plates are at a distance equal to half the wave length.

In illustration of the operation of the system let it be assumed that alternating electrical impulses from the generator are caused to produce stationary waves in the earth, as above described, and that the receiving apparatus is properly located with reference to the position of the nodal and ventral regions of the waves. The speed of rotation of the cylinder D is varied until it is made to turn in synchronism with the alternate impulses of the generator, and the position of the brushes b and b' is adjusted by angular displacement or otherwise, so that they are in contact with the segments S and S' during the periods when the impulses are at or near the maximum of their intensity. These requirements being fulfilled, electrical charges of the same sign will be conveyed to each of the terminals of the condenser, and with each fresh impulse it will be charged to a higher potential. The speed of rotation of the cylinder ω being adjustable at will, the energy of any number of separate impulses may thus be accumulated in potential form and discharged through the receiver R upon the brush k coming in contact with one of the segments f' . It will be understood that the capacity of the condenser should be such as to allow the storing of a much greater amount of energy than is required for the ordinary operation of the receiver. Since by this method a relatively great amount of energy and in a suitable form may be made available for the operation of a receiver, the latter need not be very sensitive; but when the impulses are very weak or when it is desired to operate a receiver very rapidly any of the well-known sensitive devices capable of responding to very feeble influences may be used in the manner indicated or in other ways. Under the conditions described it is evident that during the continuance of the stationary waves the receiver will be acted upon by current impulses more or less intense, according to its location with reference to the maxima and minima of said waves; but upon interrupting or reducing the flow of the current the stationary waves will disappear or diminish in intensity. Hence a great variety of effects may be produced in a receiver, according to the mode in which the waves are controlled. It is practicable, however, to shift the nodal and ventral regions of the waves at will from the sending-station, as by

varying the length of the waves under observance of the above requirements. In this manner the regions of maximum and minimum effect may be made to coincide with any receiving station or stations. By impressing upon the earth two or more oscillations of different wave length a resultant stationary wave may be made to travel slowly over the globe, and thus a great variety of useful effects may be produced. Evidently the course of a vessel may be easily determined without the use of a compass, as by a circuit connected to the earth at two points, for the effect exerted upon the circuit will be greatest when the plates P P' are lying on a meridian passing through ground-plate E' and will be n/λ when the plates are located at a parallel circle. If the nodal and ventral regions are maintained in fixed positions, the speed of a vessel carrying a receiving apparatus may be exactly computed from observations of the maxima and minima regions successively traversed. This will be understood when it is stated that the projections of all the nodes and loops on the earth's diameter passing through the pole or axis of symmetry of the wave movement are all equal. Hence in any region at the surface the wave length can be ascertained from simple rules of geometry. Conversely, knowing the wave length, the distance from the source can be readily calculated. In like ways the distance of one point from another, the latitude and longitude, the hour, &c., may be determined from the observation of such stationary waves. If several such generators of stationary waves, preferably of different length, were installed in judiciously-selected localities, the entire globe could be subdivided in definite zones of electric activity, and such and other important data could be at once obtained by simple calculation or readings from suitably-graduated instruments. Many other useful applications of my discovery will suggest themselves, and in this respect I do not wish to limit myself. Thus the specific plan herein described of producing the stationary waves might be departed from. For example, the circuit which impresses the powerful oscillations upon the earth might be connected to the latter at two points. In this application I have advanced various improvements in means and methods of producing and utilizing electrical effects which either in connection with my present discovery or independently of the same may be usefully applied.

I desire it to be understood that such novel features as are not herein specifically claimed will form the subjects of subsequent applications.

What I now claim is—

1. The improvement in the art of transmitting electrical energy to a distance which consists in establishing stationary electrical waves in the earth, as set forth.

2. The improvement in the art of transmit-

ting electrical energy to a distance which consists in impressing upon the earth electrical oscillations of such character as to produce stationary electrical waves therein, as set
5 forth.

3. The improvement in the art of transmitting and utilizing electrical energy which consists in establishing stationary electrical waves in the natural conducting media, and operating
10 thereby one or more receiving devices remote from the source of energy, as set forth.

4. The improvement in the art of transmitting and utilizing electrical energy which consists in establishing in the natural conducting
15 media, stationary electrical waves of predetermined length and operating thereby one or more receiving devices remote from the source of energy and properly located with respect

to the position of such waves, as herein set forth. 20

5. The improvement in the art of transmitting and utilizing electrical energy, which consists in establishing in the natural conducting media, stationary electrical waves, and varying the length of such waves, as herein set
25 forth.

6. The improvement in the art of transmitting and utilizing electrical energy, which consists in establishing in the natural conducting media stationary electrical waves and shifting
30 the nodal and ventral regions of these waves, as described.

NIKOLA TESLA.

Witnesses:

M. LAWSON DYER,
BENJAMIN MILLER.

No. 860,051.

PATENTED JULY 16, 1907.

J. MURGAS.
CONSTRUCTING ANTENNE OF WIRELESS TELEGRAPHY.

APPLICATION FILED FEB. 17, 1906.

3 SHEETS—SHEET 1.

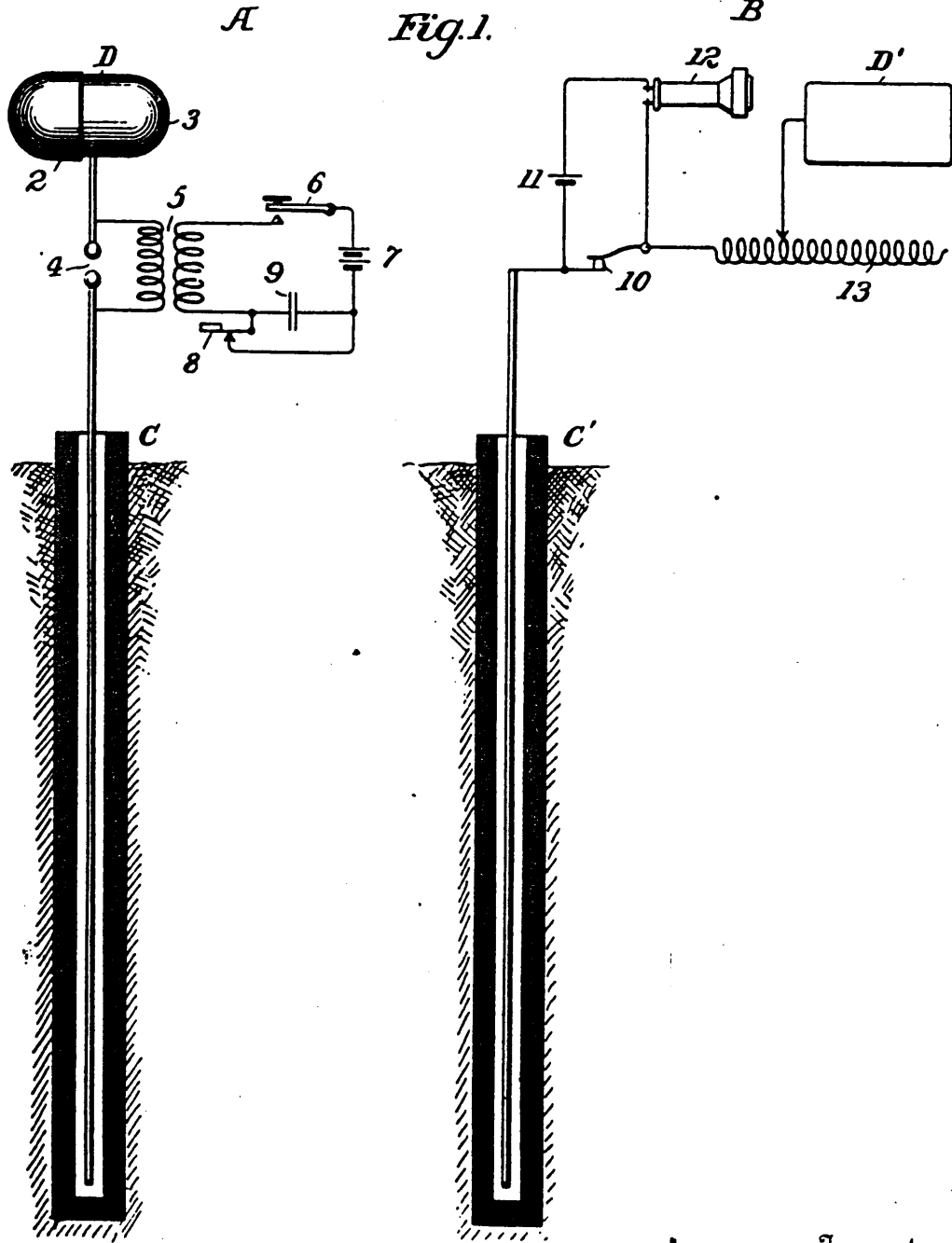

Witnesses
J. F. Stuebel
J. J. McCreath

Inventor
Joseph Murgas
 By *Joseph Freeman Weston*
 Attorneys

No. 860,051.

PATENTED JULY 16, 1907.

J. MURGAS.

CONSTRUCTING ANTENNE OF WIRELESS TELEGRAPHY.

APPLICATION FILED FEB. 17, 1906.

3 SHEETS—SHEET 2.

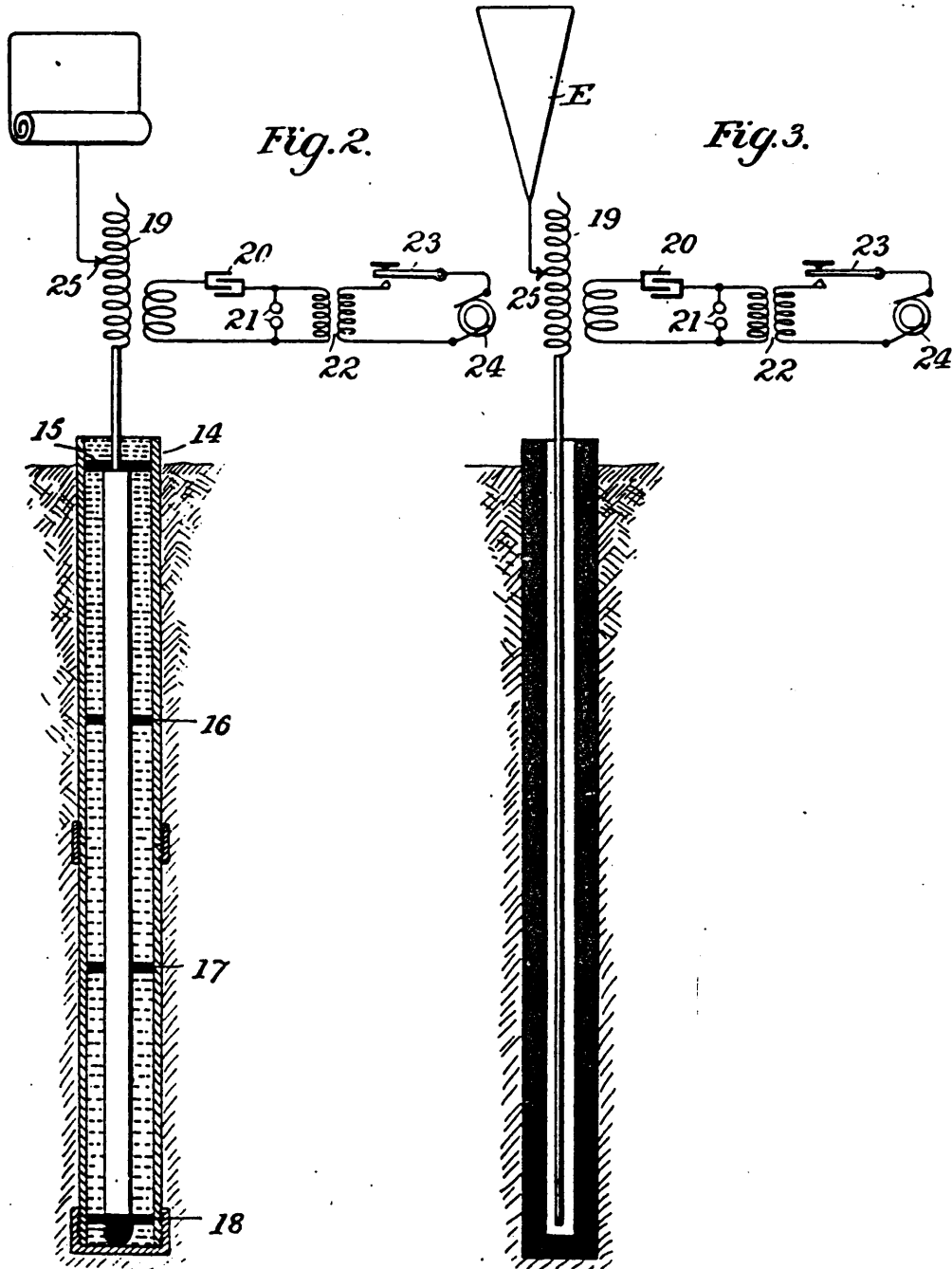

Witnesses
J. J. McCarthy

Inventor
Joseph Murgas
By *J. J. McCarthy*
Attorneys

No. 860,051.

PATENTED JULY 16, 1907.

J. MURGAS.
CONSTRUCTING ANTENNÆ OF WIRELESS TELEGRAPHY.
APPLICATION FILED FEB. 17, 1906.

3 SHEETS—SHEET 2.

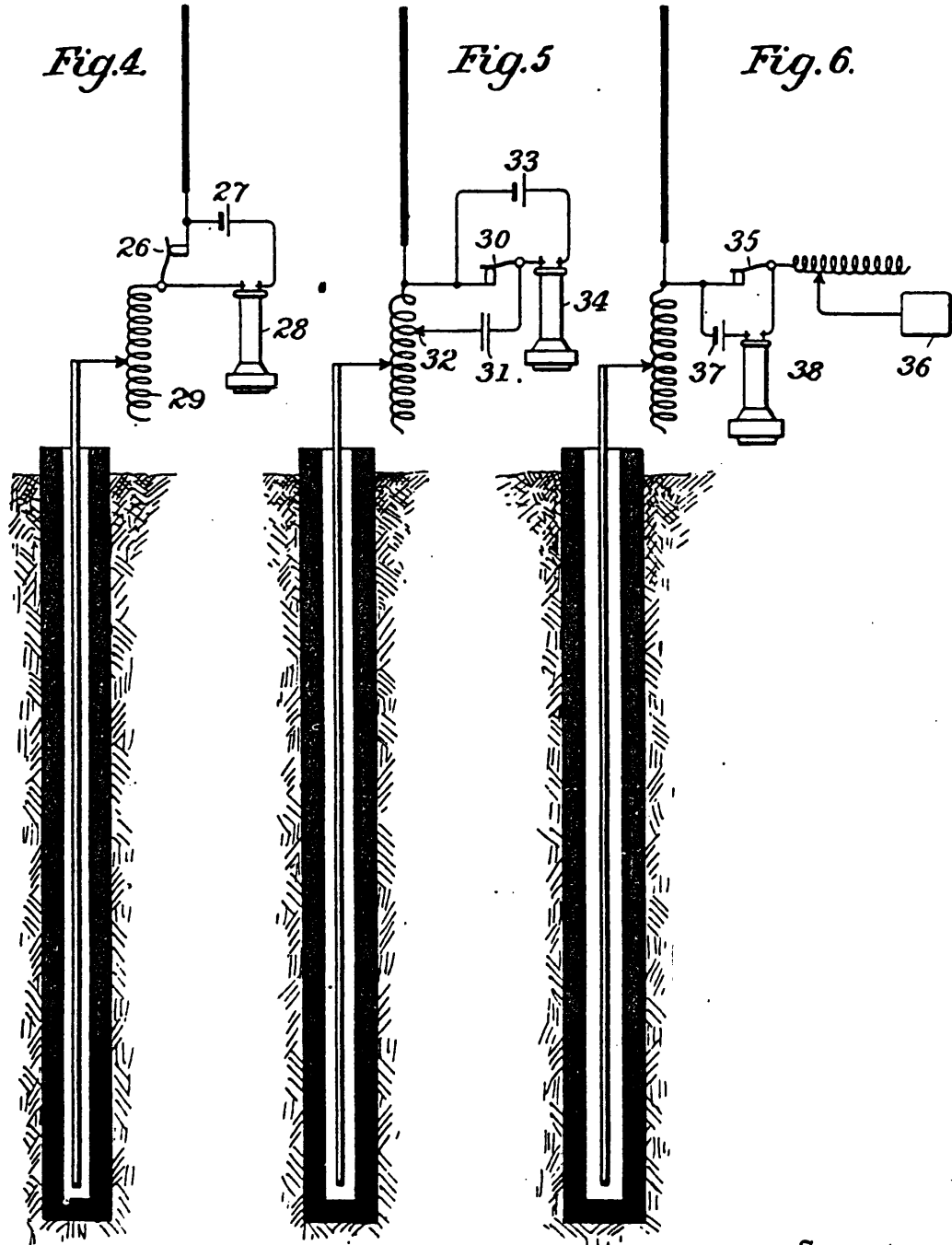

Witnesses
J. Stinkel
J. M. Cooney

Inventor
Joseph Murgas
by *W. H. ...*
Attorneys

UNITED STATES PATENT OFFICE.

JOSEPH MURGAS, OF WILKES-BARRE, PENNSYLVANIA.

CONSTRUCTING ANTENNÆ OF WIRELESS TELEGRAPHY.

No. 800,051.

Specification of Letters Patent.

Patented July 10, 1907.

Application filed February 17, 1906. Serial No. 301,646.

To all whom it may concern:

Be it known that I, Joseph Murgas, a citizen of the United States, residing at Wilkes-Barre, in the county of Luzerne and State of Pennsylvania, have invented certain new and useful Improvements in Constructing Antenna of Wireless Telegraphy, of which the following is a specification.

This invention relates to the wireless transmission of intelligence.

The object of the invention is to provide means whereby the oscillatory impulses are more vigorously propagated and more distinctly received than heretofore and whereby earth currents, unless distinctly of an oscillatory character, have no influence upon the receiving apparatus.

Other objects will appear hereinafter.

It has heretofore been the practice to connect the apparatus at a wireless station to the earth upon one side and upon the other side to an aerial antenna or antenna.

According to the present invention, the station apparatus is not connected to the ground at all. At that point on one side of the apparatus at which the earth connection is usually made, I connect an antenna of a length equal to that of the aerial antenna heretofore used, the length of which is found by well known rules. On the other side of the station apparatus I connect a capacity at the point where the aerial antenna is usually connected.

It will now be observed that my invention involves an inversion of the usual construction. Instead of being aerial, my antenna extends into the earth while the capacity connected upon the other side of the station apparatus corresponds to the capacity usually obtained by an earth connection.

Any transmitting or receiving apparatus which can be employed in connection with the usual aerial antenna can be made use of in connection with the present invention but I prefer to employ certain forms as will be hereinafter set forth.

I am aware that so called "artificial grounds" have been employed in which the station apparatus has been connected with a plate which was insulated from the earth but these plates were in no sense antennæ and therefore differ from the present apparatus in which the member which extends into the earth and is insulated therefrom is an antenna, being analogous to the usual aerial antenna.

In the accompanying drawings which illustrate the invention Figure 1 is a diagram showing a system having receiving and transmitting stations embodying the invention; Fig. 2 is a diagram showing a transmitting apparatus with a modified construction of the ground antenna and also modified constructions of other parts; Fig. 3 is a diagram showing a transmitting station having a similar arrangement of circuits to that

shown in Fig. 2, but with an aerial antenna substituted for the concentrated capacity shown in the previous figures as connected upon the opposite side of each station apparatus from the ground antenna; and Figs. 4, 5 and 6 different arrangements of receiving apparatus.

Referring to the drawings, each system of transmission comprises a transmitting station A and a receiving station B. The apparatus at each station, either transmitting or receiving, comprises upon one side an antenna C and upon the other side a capacity D.

In the apparatus of the transmitting station of Fig. 1, a tube of insulating material, it may be bituminized fiber conduit, having its lower end closed is sunk in the earth. Within this tube extends the ground antenna C of suitable length. The capacity D consists of two telescoping cylinders 2 and 3 whereby the capacity is rendered adjustable so that the vertical element may be attuned as is well understood. A spark gap 4 is interposed between the capacity D and the antenna C. A well known form of oscillator is connected across the spark gap and comprises the transformer 5 having its secondary connected across the spark gap and its primary connected in circuit with a sending key 6 a source of electricity as a battery 7, and an interrupter 8. To reduce sparking a condenser 9 may be connected across the interrupter.

The construction of the ground antenna C of the receiving station is the same as that described with reference to the transmitting station and is connected upon one side of the receiving apparatus, the capacity D being connected on the other side. Between the antenna and capacity is connected a suitable wave detecting means comprising a suitable imperfect contact 10 about which are connected a battery 11 and a telephone receiver 12. The capacity is not in this case, shown as adjustable and to provide means for attuning the vertical element, an adjustable inductance 13 may be connected between the capacity and antenna. The operation of the detecting means will be understood without further explanation.

The manner of transmitting intelligence being analogous to that of the well known aerial transmission, it need not be described further.

In Fig. 2, the capacity for the vertical element is adjustable being a suitably supported sheet of conducting material, the capacity being varied by rolling up or unrolling the sheet. The construction in relation to the antenna is also varied somewhat. Instead of an insulating tube being sunk in the earth and the antenna extended therein, a metal tube 14 is placed in the earth and the antenna is supported therein by means of insulating supports 15, 16, 17 and 18 and the moisture is excluded and the insulation rendered more secure by filling the tube about the antenna with oil. Between the capacity and antenna is connected a

adjustable oscillator which is shown as comprising a transformer 19 having its secondary connected in the vertical element and its primary connected in circuit with a condenser 20, a spark gap 21 and the secondary of a transformer 22, the primary of the transformer 22 being connected in circuit with a sending key 23 and an alternating current source 24. This oscillator is well understood. The secondary of the transformer 19 is extended as shown to form an inductance more or less of which may be included in the vertical element by the sliding contact 25. In this case the vertical element may be attuned by varying its inductance or capacity.

In Fig. 3 is shown the apparatus for a transmitting station in which the arrangement and construction is the same as in Fig. 2, except that an insulated aerial antenna E, in this case shown as multiple, is substituted for the concentrated capacity of the vertical element of the previous figures and the antenna is constructed as in Fig. 1.

In Fig. 4 are shown aerial and ground antenna as in the last preceding figure, except that the aerial is single, an imperfect contact being connected to the vertical element, and about the imperfect contact a battery 27 and telephone receiver 28 are connected. An adjustable inductance 29 is connected between the antenna for purposes as described in connection with the receiving apparatus of Fig. 1.

In Fig. 5, the vertical element is as in the last preceding figure except that the period of the circuit of the detecting means can be varied independently of that of the vertical element. The imperfect contact 30 is connected across a variable portion of the inductance of the vertical element in series with a condenser 31 by means of a sliding contact 32. Across the imperfect contact a battery 33 and telephone receiver 34 are connected in series.

In Fig. 6 is shown what may be termed an "open circuit" receiving apparatus. The vertical element is the same as in the last figure but instead of the detecting means being connected across the inductance of the vertical element, one terminal of the imperfect contact 35 is connected with the vertical element and the other terminal is connected with a capacity 36 which is not otherwise conductively connected. Across the imperfect contact a battery 37 and telephone receiver 38 are connected. An adjustable inductance 39 may be connected in the detecting circuit to provide means for adjusting the period of that circuit.

While the invention has been illustrated in what are believed to be its best embodiments, it may be embodied in other structures than those shown and is not therefore limited thereto.

Without limiting myself to the precise construction and arrangement shown, what I claim as new and desire to secure by Letters Patent, is

1. A wireless telegraph station comprising a wave apparatus, and an antenna connected to the wave apparatus between the apparatus and the earth extending into the earth and insulated from the latter.
2. Wireless station apparatus comprising an antenna upon one side of the apparatus extending into the earth and insulated from the latter, and a capacity upon the other side of the apparatus.
3. Wireless station apparatus comprising an antenna

upon one side of the apparatus extending into the earth and insulated from the latter and an aerial antenna upon the other side of the apparatus.

4. Wireless station apparatus comprising an antenna upon one side of the apparatus extending into the earth and insulated from the latter, a capacity upon the other side of the apparatus and an inductance connected between said antenna and capacity.

5. Wireless station apparatus comprising an antenna extending into the earth and insulated therefrom, an aerial antenna upon the other side of the apparatus and an inductance connected between said antenna.

6. Wireless station apparatus comprising an antenna upon one side of the apparatus extending into the earth and insulated from the latter, a capacity upon the other side of the apparatus and an adjustable inductance connected between said antenna and capacity.

7. Wireless station apparatus comprising an antenna extending into the earth and insulated therefrom, an aerial antenna upon the other side of the apparatus and an adjustable inductance connected between said antenna.

8. Wireless station apparatus comprising an antenna upon one side of the apparatus extending into the earth and insulated from the latter, a capacity upon the other side of the apparatus, detecting means having one terminal connected with said antenna and a capacity connected with the other terminal of said detecting means.

9. Wireless station apparatus comprising an antenna upon one side of the apparatus extending into the earth and insulated from the latter, an aerial antenna upon the other side of the apparatus, detecting means having one terminal connected with said antenna and a capacity connected with the other terminal of said detecting means.

10. Wireless station apparatus comprising an antenna upon one side of the apparatus extending into the earth and insulated from the latter, a capacity upon the other side of the apparatus, detecting means having one terminal connected with said antenna, a capacity connected with the other terminal of said detecting means, and an inductance connected between said antenna and the first mentioned capacity.

11. Wireless station apparatus comprising an antenna upon one side of the apparatus extending into the earth and insulated from the latter, an aerial antenna upon the other side of the apparatus, detecting means having one terminal connected with said antenna, a capacity connected with the other terminal of said detecting means, and an inductance connected between said antenna.

12. Wireless station apparatus comprising an antenna upon one side of the apparatus extending into the ground and insulated from the latter, a capacity upon the other side of the apparatus, detecting means having one terminal connected with said antenna, a second capacity connected with the other terminal of said detecting means and an inductance connected between said detecting means and said second capacity.

13. Wireless station apparatus comprising an antenna upon one side of the apparatus extending into the ground and insulated from the latter, a capacity upon the other side of the apparatus, detecting means having one terminal connected with said antenna, a second capacity connected with the other terminal of said detecting means and an adjustable inductance connected between said detecting means and said second capacity.

14. Wireless station apparatus comprising an antenna upon one side of the apparatus extending into the earth and insulated from the latter, an aerial antenna upon the other side of the apparatus, detecting means having one terminal connected with said antenna, a second capacity connected with the other terminal of said detecting means and an inductance connected between said detecting means and said second capacity.

15. Wireless station apparatus comprising an antenna upon one side of the apparatus extending into the earth and insulated from the latter, an aerial antenna upon the other side of the apparatus, detecting means having one terminal connected with said antenna, a second capacity connected with the other terminal of said detecting means and an adjustable inductance connected between said detecting means and said second capacity.

70

75

80

85

90

95

100

105

110

115

120

125

130

135

140

145

- 16. Wireless station apparatus comprising an antenna upon one side of the apparatus extending into the earth and insulated from the latter, a capacity upon the other side of the apparatus, detecting means having one terminal connected with said antenna, a second capacity connected with the other terminal of said detecting means, an inductance connected between said antenna and the first mentioned capacity and a second inductance connected between said detecting means and said second capacity.
- 17. Wireless station apparatus comprising an antenna upon one side of the apparatus extending into the earth and insulated from the latter, a capacity upon the other side of the apparatus, detecting means having one terminal connected with said antenna, a second capacity connected with the other terminal of said detecting means, and adjustable inductance connected between said antenna and the first mentioned capacity and a second adjustable inductance connected between said detecting means and said second capacity.
- 18. Wireless station apparatus comprising an antenna upon one side of the apparatus extending into the earth and insulated from the latter, an aerial antenna upon the other side of the apparatus, detecting means having one terminal connected with said antenna, a capacity connected with the other terminal of said detecting means, an inductance connected between said antenna and a second inductance connected between said capacity and detecting means.
- 19. Wireless station apparatus comprising an antenna upon one side of the apparatus extending into the earth and insulated from the latter, an aerial antenna upon the other side of the apparatus, detecting means having one terminal connected with said antenna, a capacity connected with the other terminal of said detecting means, an adjustable inductance connected between said antenna and a second adjustable inductance connected between said capacity and detecting means.
- 20. In a system for the wireless transmission of intelligence, the combination with sending apparatus, of a wave receiving apparatus, and an antenna connected to the wave

apparatus between the apparatus and the earth, extending into the earth and insulated from the latter.

21. In a system for the wireless transmission of intelligence, the combination with sending apparatus of receiving apparatus, each of said apparatus comprising an antenna upon one side of the apparatus extending into the ground and insulated from the latter and a capacity upon the other side of the apparatus.

22. In a system for the wireless transmission of intelligence, the combination with sending apparatus of receiving apparatus, each of said apparatus comprising an antenna upon one side of the apparatus extending into the ground and insulated from the latter, a capacity upon the other side of the apparatus, and an inductance connected between said antenna and said capacity.

23. In a system for the wireless transmission of intelligence, the combination with sending apparatus of receiving apparatus, each of said apparatus comprising an antenna upon one side of the apparatus extending into the ground and insulated from the latter, a capacity upon the other side of the apparatus, and an adjustable inductance connected between said antenna and said capacity.

24. In a system for the wireless transmission of intelligence, the combination with sending apparatus of receiving apparatus, each of said apparatus comprising an aerial antenna on one side of the apparatus and antenna on the other side of the apparatus extending into and insulated from the ground.

25. In a system for the wireless transmission of intelligence, the combination with sending apparatus of receiving apparatus, each of said apparatus comprising an aerial insulated antenna on one side of the apparatus combined with antenna on the other side of the apparatus extending into and insulated from the ground.

In testimony whereof I affix my signature in presence of two witnesses.

JOSEPH MURGAS.

Witnesses:
W. L. RAYNER,
K. E. FEENEY.

J. MURGAS.
 WIRELESS TELEGRAPHY.
 APPLICATION FILED MAY 17, 1907.

915,993.

Patented Mar. 23, 1909.

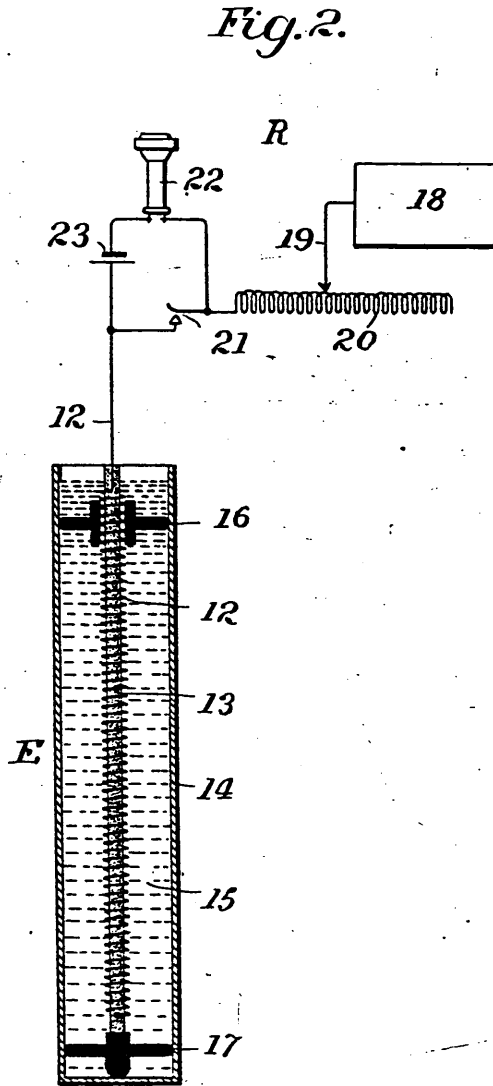
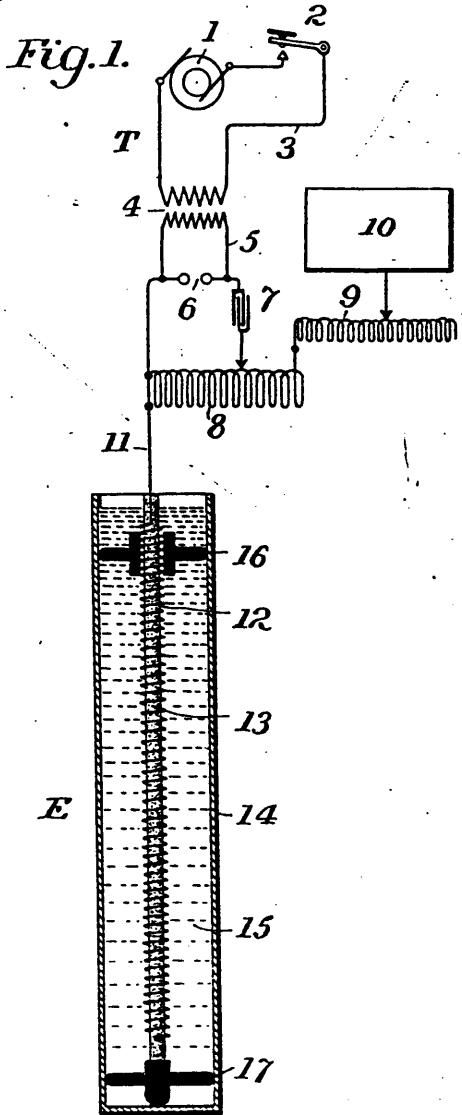

Witnesses
J. J. McConthy

Inventor
Joseph Murgas
 By *Foster Freeman Watson & Co.*
 Attorneys

UNITED STATES PATENT OFFICE.

JOSEPH MURGAS, OF WILKES-BARRE, PENNSYLVANIA.

WIRELESS TELEGRAPHY.

No. 915,993.

Specification of Letters Patent.

Patented March 23, 1909.

Application filed May 17, 1907. Serial No. 374,231.

To all whom it may concern:

Be it known that I, JOSEPH MURGAS, a citizen of the United States, and resident of Wilkes-Barre, Luzerne county, State of Pennsylvania, have invented certain new and useful Improvements in Wireless Telegraphy, of which the following is a specification.

This invention relates to improvements in wireless telegraphy, the object of the invention being to provide means whereby oscillatory impulses are more vigorously propagated and more distinctly received than heretofore, and whereby earth currents, unless distinctly of an oscillatory character, have no influence upon the receiving apparatus.

The invention relates more particularly to improvements upon the apparatus illustrated and described in my Patent No. 860,051, granted July 16, 1907.

The invention will be described in connection with the accompanying drawing, in which,

Figure 1 is a diagrammatic view of a transmitting station; and Fig. 2 is a similar view of a receiving station both embodying the invention.

In the application referred to the station apparatus is not connected to the ground. At the point in the apparatus at which the earth connection is usually made an antenna is connected, which antenna extends into the earth in a straight line, being however insulated from the earth. On the other side of each station apparatus a capacity is connected at the point where the aerial antenna is usually connected. In said application several forms of apparatus for transmitting and receiving are shown. Likewise, in the present case, any transmitting or receiving apparatus which can be employed in connection with the usual aerial antenna can be used. I have therefore illustrated but one form of each apparatus in the present case.

In experimenting with the apparatus illustrated in the patent mentioned, I observed that the earth is more susceptible of receiving and transmitting magnetic waves of low frequency than waves of high frequency. My present improvement is directed to rendering the apparatus equally sensitive to waves of any length and any frequency and also to reducing the length or depth of the well or hole for the antenna and therefore its cost. I accomplish these objects by coil-

ing the antenna into a helix having an axis much shorter than the straight antenna of the application mentioned.

Referring to the accompanying drawing, T indicates the transmitting apparatus and R the receiving apparatus. The transmitting apparatus, as illustrated, comprises an alternating current dynamo 1, and a key or circuit closer 2 in the dynamo circuit 3. A transformer 4 induces a current in an oscillator circuit 5 having an air gap 6 and a condenser 7. The oscillator circuit is closed through an inductance 8 which is connected at one end with a balancing-inductance 9 and a capacity 10, and at the other end with a conductor 11 connecting it with an antenna 12 in the form of a helix. The antenna is suitably insulated from the earth E. As shown it is wound upon a rod 13 of insulating material which is held centrally in a tube 14 inserted in the ground. The tube is closed at its lower end and filled with oil 15 to prevent dampness from interfering with the insulation of the antenna. Spacing insulating devices 16, 17, may be used to hold the antenna centrally in the tube 14.

As illustrated, the receiving apparatus comprises a capacity 18 connected by a conductor 19 with an inductance 20. The antenna of the receiving station may be identical with the antenna of the transmitting station and I have therefore applied the same reference figures both to the antenna and its supporting and insulating means. Between the antenna and the capacity is connected a suitable wave conducting means comprising an imperfect contact 21 around which is a circuit including a telephone receiver 22 and a battery 23.

The tube 14 may be of metal or other suitable material and the helix may be insulated therein in any suitable manner. The inductances 8, 9, and 20, are adjustable, as described in the patent above referred to.

Without limiting myself to the precise construction and arrangement illustrated and described, what I claim as new and desire to secure by Letters Patent is:

1. Wireless station apparatus comprising an antenna upon one side of the apparatus extending into the earth and insulated from the latter, and a capacity upon the other side of the apparatus, the antenna being arranged in a curved line, for the purpose set forth.

2. Wireless station apparatus comprising an antenna upon one side of the apparatus

extending into the earth and insulated from the latter, and a capacity upon the other side of the apparatus, the antenna being in the form of a helix, for the purpose set forth.

5 3. Wireless station apparatus comprising an antenna upon one side of the apparatus extending into the earth and insulated from the latter, and a capacity upon the other side of the apparatus, the antenna being in the
10 form of a helix, and means for suitably insulating the antenna from the earth.

4. Wireless station apparatus comprising an antenna upon one side of the apparatus extending into the earth, a capacity upon the
15 other side of the apparatus, and a tube or well sunk in the earth, the said antenna consisting in a helix arranged within said tube and insulated therefrom.

20 5. In a system for wireless transmission, the combination with transmitting apparatus, of receiving apparatus, each of said apparatus comprising an antenna suitably curved,

extending into the earth and insulated from the latter, whereby its direct length from end to end is much less than its actual length. 25

6. In a system for wireless transmission, the combination with transmitting apparatus, of receiving apparatus, each of said apparatus comprising an antenna in the form of a helix extending into the ground and insulated from the latter. 30

7. Wireless station apparatus comprising an antenna upon one side of the apparatus extending into the earth and insulated from the latter, and a capacity upon the other side of the apparatus, the antenna having a
35 length substantially greater than the distance between its ends.

In testimony whereof I affix my signature in presence of two witnesses.

JOSEPH MURGAS.

Witnesses:

JOHN P. POLLOCK,
GEO. W. LEURS.

GEORG GRAF VON ARCO.
 RADIOTELEGRAPHIC STATION.
 APPLICATION FILED FEB. 7, 1912.

1,082,221.

Patented Dec. 23, 1913.

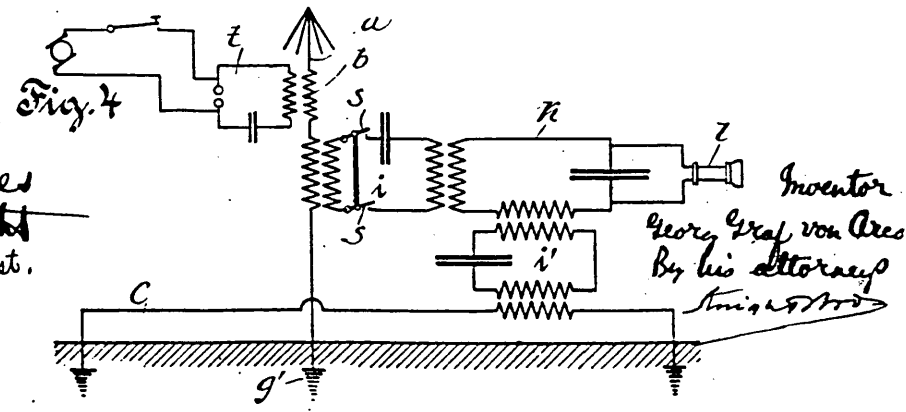
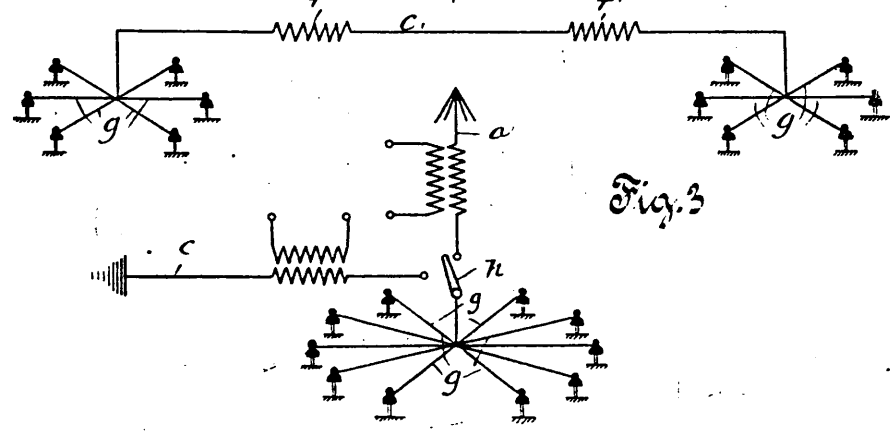
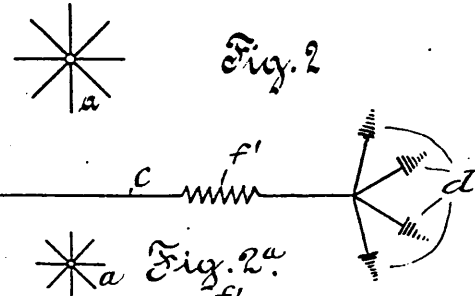
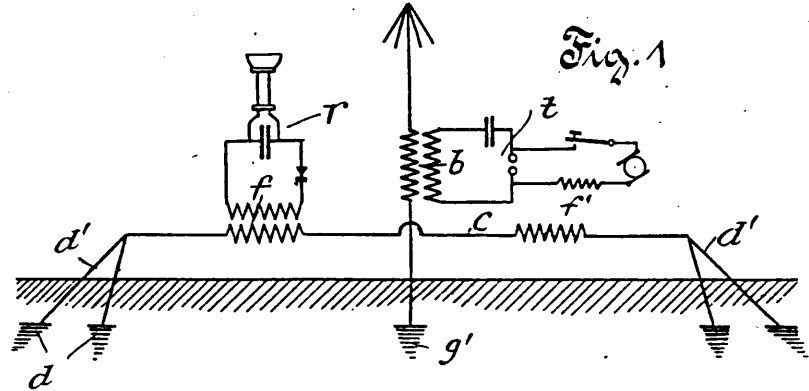

Witnesses
 H. H. Knipf
 Ray J. Ernst.

Inventor
 Georg Graf von Arco
 By his attorney
 S. J. G. M. S.

UNITED STATES PATENT OFFICE.

GEORG GRAF VON ARCO, OF BERLIN, GERMANY.

RADIOTELEGRAPHIC STATION.

1,082,221.

Specification of Letters Patent.

Patented Dec. 23, 1913.

Application filed February 7, 1912. Serial No. 676,132.

To all whom it may concern:

Be it known that I, GEORG GRAF VON ARCO, a subject of the German Emperor, and residing at Berlin, Germany, have invented certain new and useful Improvements in Radiotelegraphic Stations, of which the following is a specification.

My invention relates to aerials for radiotelegraphic stations.

In radiotelegraphy the dimension and shape of the aerials are of the greatest importance for the range of the stations. The selection of an antenna is connected with certain difficulties, however, because different points of view come into question for transmitting, from those for receiving electric oscillations.

When transmitting, the antenna should take up a predetermined, supplied quantity of energy and emit it with a sufficiently high efficiency. When receiving, on the contrary, as much energy as possible is to be taken up from as large a space as possible. While the first requirement is best fulfilled by a relatively small aerial-capacity of large vertical extent, for receiving, a large aerial-capacity of as large superficial area as possible is desired. A large vertical extent of aerial when receiving is objectionable, when atmospheric and other disturbances should be carefully avoided.

The principal object of my invention is to provide antennæ of various shapes for receiving and for transmitting.

Arrangements have heretofore been proposed which likewise comprise aerials of various shapes for transmitting and receiving. In these known arrangements, however, the aerials were of a form which led in practice to new difficulties which consisted in mutual disturbances occurring both when transmitting and when receiving. These disturbances could be obviated only by separating the two aerials in space some kilometers apart whereby, of course, in practice other disadvantages resulted. Now according to my invention I obviate these defects by employing separate antennæ for transmitting and for receiving, that for transmitting being formed as a standard antenna, while that principally used for receiving is formed as a low horizontal antenna, *i. e.* as an aerial which extends, principally horizontally, in immediate proximity to the ground. When the antennæ

used for transmitting and receiving are formed in this manner it is possible to arrange the same directly beside one another without causing mutual reaction of any kind. The directly contiguous arrangement of the two aerials besides has the advantage that not only the antenna specially provided for receiving, but also the vertical antenna can be simultaneously used for receiving the electric oscillations.

One illustrative embodiment of my invention and some modifications thereof are diagrammatically represented in the accompanying drawing, wherein:—

Figures 1 and 2 are elevation and plan view, respectively, showing an arrangement in which the low horizontal antenna is separated from the transmitter antenna and located symmetrically therewith; Fig. 2^a is a modification of the antennæ *c* shown in Fig. 2. Fig. 3 is a diagram showing an arrangement in which the receiving antenna is combined with the transmitting antenna, and Fig. 4 is a diagram showing an arrangement in which the low horizontal antenna and the aerial antenna act on one common receiving apparatus.

Referring firstly to Figs. 1 and 2, *a* designates a standard transmitter antenna, *e. g.* an umbrella-shaped antenna energized in known manner over the transformer *b*, which forms part of the transmitter circuit *t*. It is used for emitting the signals, while the latter are received by the low horizontal antenna *c* which is connected to the grounded plates *d, d'*, and transmits the energy by means of the transformer *f* in known manner to the receiving apparatus *r*. The transmitter antenna *a* is arranged laterally of and symmetrically to the receiving antenna, as clearly shown in Fig. 2. While the transmitter acts equally strongly in all directions, the receiver prefers the signals from that direction in which the low horizontal antenna extends. As Fig. 2 shows, the low horizontal antenna is arranged laterally of and symmetrically to the antenna *a* and connected on both sides by wires *d'* proceeding radially from their ends with a plurality of grounded plates *d*. Instead of the plurality of grounded plates one single plate may, of course, be used at each end. Furthermore, the grounded plates may be replaced by the full equivalent of horizontal nets or wires in the form of counterweights

arranged close above the ground and insulated therefrom as shown in Fig. 2^a. The distance between the grounded plates or the length of the low horizontal antenna is preferably approximately equal to half a wave-length.

In consequence of the symmetrical arrangement of the low horizontal antenna relatively to the transmitter antenna no reaction of the high frequency of the transmitter antenna takes place on the receiver. The waves proceeding from the transmitter antenna impact, on the contrary, in Fig. 2 for example, both ends of the low horizontal antenna perfectly uniformly, so that disturbing potential differences do not occur in the antenna and consequently duplex operation with a second station is possible.

It is preferable to utilize the means for grounding or balancing the transmitter antenna for grounding or balancing the low horizontal antenna. Fig. 3 shows an arrangement for using the same counterweight. The counterweight g which serves for balancing the antenna a when transmitting can be connected by the switch h with the low horizontal antenna and thus be used for forming the low horizontal antenna. Instead of the counterweight, however, the equivalent grounding arrangement g' used for the transmitter antenna a in Fig. 1 can likewise be used for the low horizontal antenna in the manner shown in Fig. 3 without departing from the spirit of the invention.

While the aerial antenna solely serves for transmitting it is preferable to use both antennæ for receiving which is readily possible in consequence of their being arranged close together. Fig. 4 shows such an arrangement. The transmitting antenna a besides being coupled with the transmitter circuit t , is also coupled with an intermediate circuit i , and the receiving antenna c is coupled with the intermediate circuit i' . Both circuits i and i' are coupled with one common detector circuit k . Antenna a is disconnected from the receiving system by means of double switch $s-s$, located in circuit i . In this case the energy taken up by the two antennæ is added together by the two intermediate circuits i, i' , in the common detector-circuit k and the strengthened signals can be perceived in the telephone l . The symmetrical arrangement of the two antennæ in

proximity to each other is advantageous also in this case.

I claim:—

1. In a radiotelegraphic station, the combination with a vertical antenna for transmitting, of a low horizontal antenna for receiving, said horizontal antenna being symmetrically disposed adjacent to the vertical antenna and in operative relation therewith to avoid mutual disturbance.

2. In a radiotelegraphic station, the combination with a vertical antenna for transmitting, of a low horizontal antenna for receiving, said horizontal antenna being symmetrically disposed adjacent to the vertical antenna and in operative relation therewith to avoid mutual disturbance and means adapted to ground both the vertical and the horizontal antenna.

3. In a radiotelegraphic station, the combination with a vertical antenna normally for transmitting, of a low horizontal antenna for receiving, said horizontal antenna being symmetrically disposed adjacent to the vertical antenna and in operative relation therewith to avoid mutual disturbance and a receiving apparatus operatively connected with the vertical and with the horizontal antenna, for the purpose specified.

4. In a station for wireless telegraphy, a vertical antenna, a low horizontal antenna, a transmitting device connected with said vertical antenna, a receiving device connected with said horizontal antenna, means for coupling the receiving device of the horizontal antenna with the vertical antenna and for uncoupling it therefrom to permit the receiving device to receive energy from both antennæ at will.

5. In a station for wireless telegraphy, a vertical antenna, a low horizontal antenna, a transmitting device connected with said vertical antenna, and a receiving device connected with said horizontal antenna, means for coupling with the vertical antenna and for uncoupling therefrom the receiving device of the horizontal antenna, the horizontal antenna being symmetrically arranged relatively to the vertical antenna.

In testimony whereof, I affix my signature in the presence of two witnesses.

GEORG GRAF von ARCO.

Witnesses:

WOLDEMAR HAUPT,
HENRY HASPER.

E. E. BUTCHER.
OSCILLATION RECEIVING APPARATUS.
APPLICATION FILED MAY 19, 1914.

1,228,647.

Patented June 5, 1917.
3 SHEETS—SHEET 1.

Fig. 1.

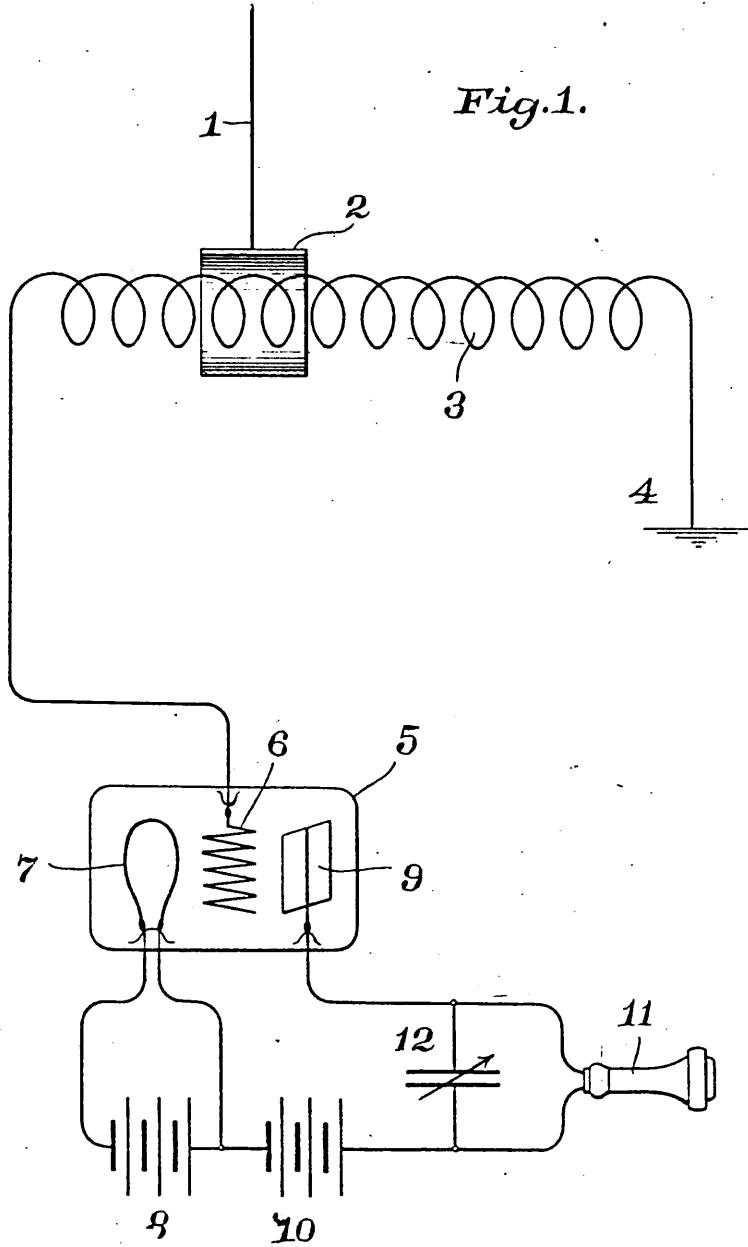

Witnesses:
M. M. Lutz
W. M. Earl

Inventor
Elmer E. Butcher
By his Attorneys
Sheffield, Busby, & Bets

erating the indicating mechanism when the receiver is ruptured, substantially as set forth.

16. In a system of signaling by electromagnetic waves, the combination of a receiving-circuit, a series of receivers, and means shifting any desired one of said receivers into and out of operative relation to the receiving-conductor, substantially as set forth.

17. A system for signaling by electromagnetic waves, the combination of a receiver, rods movable into and out of contact with the terminals of the receiver, contacts adapted to be brought into contact by the rods when shifted out of contact with the receiver-terminals, substantially as set forth.

18. A system for signaling by electromagnetic waves, in combination therewith, a tuning device consisting of one or more connected pairs of conductors and one or more contact-pieces connecting the legs of each pair movable along the same, substantially as set forth.

19. A system of signaling by electromagnetic waves, having in combination one or more connected pairs of connected conductors in series in the sending-circuit and contact-fingers adapted to bear against the conductors in succession, thereby shunting different portions of the sending-conductor, substantially as set forth.

20. A system of signaling by electromagnetic waves, having in combination a sending-conductor and a key provided with fingers arranged to be brought into contact with the sending-conductor at different points, substantially as set forth.

21. A system of signaling by electromagnetic waves, having in combination a sending-conductor and a key provided with fingers adapted to be brought into contact in succession with the sending-conductor at different points, substantially as set forth.

22. A system of signaling by electromagnetic waves, having in combination therewith mechanism for the production of the proper signal of a station at that station, as means for indicating the busy or free state of that station, substantially as set forth.

23. A system of signaling by electromagnetic waves, having in combination therewith automatic mechanism for the production of the proper signal of a station at that station,

as means for indicating the busy or free state of that station, substantially as set forth.

24. A system of signaling by electromagnetic waves, having in combination a sending-conductor and a normally closed shunt, said parts being so arranged that the sending-conductor will have the natural period proper to that station, substantially as set forth.

25. A system of signaling by electromagnetic waves, having in combination a sending-conductor, a sending-key forming part of a shunt for said conductor and provided with a finger normally in contact with the conductor so that said conductor will normally have the natural period proper to that station, substantially as set forth.

26. A system of signaling by electromagnetic waves having in combination therewith means for indicating to a third station during sending or receiving that such sending or receiving station is busy, substantially as set forth.

27. In a system of signaling by electromagnetic waves, the combination of radiating-conductor and a gap, one terminal of the gap being connected to ground, with means for changing the function of the conductor, *i. e.*, from sending to receiving, without bridging the gap, substantially as set forth.

28. In a system of signaling by electromagnetic waves, a sending-conductor, a receiving-conductor, a transformer connected in operative relation to the receiving-conductor, in combination with a current-actuated wave-responsive device (in the secondary circuit of the transformer,) the secondary circuit, receiving-conductor and sending-conductor all being tuned to the same periodicity.

29. A system for signaling by electromagnetic waves having in combination therewith an aerial conductor, a tuning device for said system including a pair of conductors constructed and arranged to inductance and capacity in substantially the same ratio as the aerial conductor, and means for varying the operative length of the pair of conductors, substantially as set forth.

In testimony whereof I have hereunto set my hand.

REGINALD A. FESSENDEN.

Witnesses:

DARWIN S. WOLCOTT,
F. E. GATHER.

R. G. MARX AND L. F. FULLER.
 RADIOTELEGRAPHY.
 APPLICATION FILED AUG. 13, 1917.

1,316,172.

Patented Sept. 16, 1919.

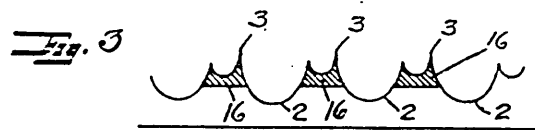
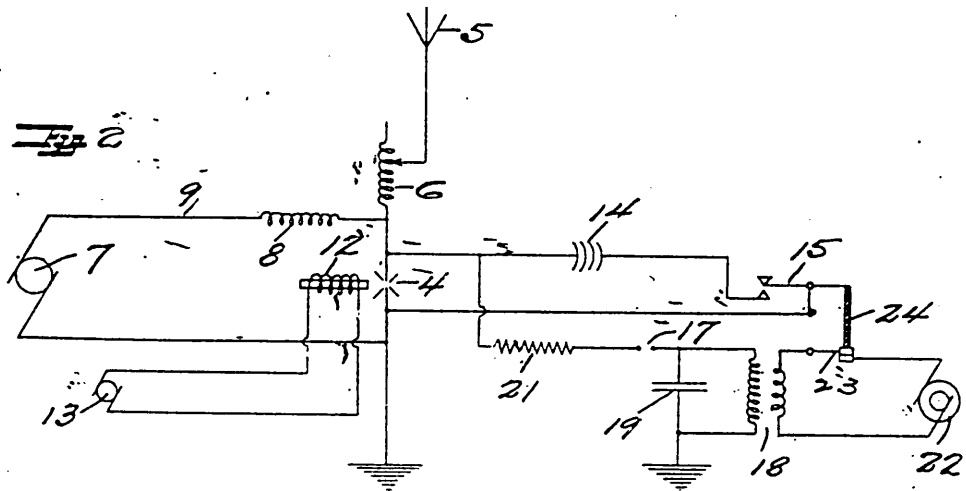
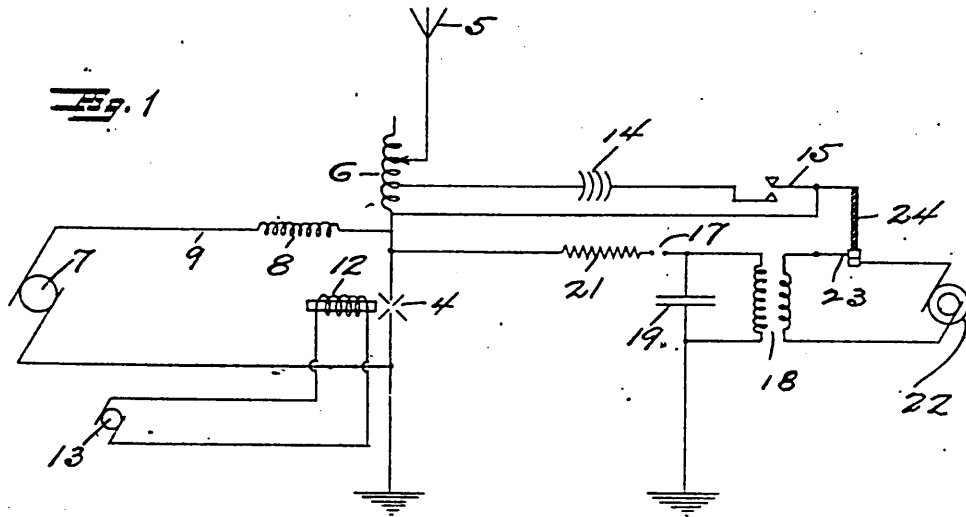

Witness

J. B. Gardner

INVENTORS
 R. G. MARX
 L. F. FULLER

By White Post

ATTORNEYS

UNITED STATES PATENT OFFICE.

ROLAND G. MARX, OF PALO ALTO, AND LEONARD F. FULLER, OF SAN FRANCISCO,
CALIFORNIA, ASSIGNORS TO FEDERAL TELEGRAPH COMPANY, OF SAN FRAN-
CISCO, CALIFORNIA, A CORPORATION OF CALIFORNIA.

RADIOTELEGRAPHY.

1,316,172.

Specification of Letters Patent. Patented Sept. 16, 1919.

Application filed August 13, 1917. Serial No. 185,908.

To all whom it may concern:

Be it known that we, ROLAND G. MARX and LEONARD F. FULLER, citizens of the United States, and residents, respectively, of Palo Alto, Santa Clara county, and the city and county of San Francisco, both in the State of California, have invented certain new and useful Improvements in Radiotelegraphy, of which the following is a specification.

The invention relates to a means of signaling and particularly to means of signaling with arc radio transmitters.

An object of the invention is to provide means for signaling which requires the handling of only relatively small currents.

Another object of the invention is to provide means for signaling involving extinguishing and re-igniting the arc.

The invention possesses other advantageous features, some of which, with the foregoing, will be set forth at length in the following description, where we shall outline in full that form of the invention which we have selected for illustration in the drawings accompanying and forming part of the present specification. It is to be understood, however, that the invention as expressed in the claims is not limited to the specific embodiment shown in the drawings.

Referring to said drawings:

Figure 1 is a diagrammatic representation of one form of the system of our invention.

Fig. 2 is a diagrammatic representation of a modified form.

Fig 3 is a diagrammatic representation of the potential curve across the arc.

The potential curve 2 taken across the arc is a very irregular curve having sharp peaks 3 without which the arc cannot oscillate and we provide means for robbing the potential curve of its peaks. When the curve is so robbed of its peaks, the arc is extinguished and radiant energy is not emitted from the antenna circuit. Signaling is accomplished by alternately extinguishing and reigniting the arc at telegraphic speed.

The transmission system comprises an arc oscillation generator 4, which is grounded on one side, preferably the negative, and connected on the other side to the antenna 5 through the variable inductance or loading

coil 6. Direct current is supplied to the arc oscillation generator by the generator 7 and a choke coil 8 is arranged in the lead 9 connected to the antenna side of the arc. The arc is subjected to a strong transverse magnetic field produced by the magnet coil 12, which may be separately excited by the generator 13.

The potential wave produced by the arc has a very jagged form, developing sharp peaks, and the wave may be robbed of these peaks at the arc or in the loading coil. This jagged wave form is impressed upon the first few turns of the antenna loading coil 6. In Fig. 1 we have shown the means for robbing the wave form of its peaks connected across the lower turns of the loading coil and in Fig. 2 we have shown this means connected across the arc.

Connected across the lower turns of the loading coil (Fig. 1) is a circuit containing an electrolytic lightning arrester 14 which acts as a potential valve and a signaling key 15. The lightning arrester is made up of two or more aluminum cells, connected in series, each cell consisting of two aluminum plates on which has been formed by chemical or electro-chemical processes, a film of hydroxid of aluminum, the plates being immersed in a suitable electrolyte. When the jagged wave form is impressed on the arrester, the film opens, as it were, and a current limited only by the internal resistance of the cells, which is low, flows through the arrester. The part of the potential curve eliminated by the cells is indicated by the shaded portions 16 of the potential curve. When the signaling key 15 is closed, the wave form is robbed of its potential peaks which discharge through the aluminum lightning arrester and the arc is extinguished. In Fig. 2, the circuit containing the lightning arrester 14 and the signaling key 15 is connected across the arc and when the key is closed the arc is likewise extinguished.

Ordinarily, when the key circuit is again opened, the arc will not reignite and means should be provided for reigniting the arc immediately, so that the key may be operated at telegraphic speed. One form of means which may be employed for reigniting the

arc is shown herein, this means being so arranged that the arc is ignited as the lightning arrester circuit is opened. Connected across the arc is a spark circuit containing the spark gap 17, the secondary of the transformer 18 and the capacity 19 shunting the secondary. A stopping resistance 21 is arranged between the spark gap and the antenna side of the arc to prevent direct current sufficient to maintain an arc across the spark gap from following the radio frequency current across the spark gap and passing through the secondary. The primary of the transformer is in series with an alternating current generator 22 and a switch 23 in the primary circuit is attached to the key 15 by an insulating rod 24. When the lightning arrester circuit is opened, the circuit through the primary is closed, producing a high potential in the spark circuit and producing a spark across the spark gap which sets up radio frequency surges which ignite the arc.

We claim:

1. An arc system for radio signaling comprising an arc, a current supply and an antenna circuit connected to the arc, and a circuit containing an aluminum lightning arrester arranged to shunt a portion of the oscillations produced by said arc.

2. An arc system for radio signaling, comprising a current supply and an oscillation circuit connected to an arc and a circuit containing a potential valve arranged to shunt a portion of the oscillation circuit.

3. An arc system for radio signaling comprising a current supply and an oscillation circuit connected to an arc and a circuit containing a potential valve and a signaling key arranged in shunt on a portion of the oscillation circuit.

4. An arc system for radio signaling comprising a current supply and an oscillation circuit connected to an arc and a circuit containing an aluminum lightning arrester and a signaling key arranged in shunt on a portion of the oscillation circuit.

5. An arc system for radio signaling comprising an arc which produces an oscillating

current having a peaked potential wave form, means for robbing the wave of its peaks whereby the arc is extinguished and means for reigniting the arc.

6. An arc system for radio signaling comprising a current supply and an oscillation circuit connected to an arc, a circuit containing a potential valve adapted to be shunted across a portion of the oscillation circuit, whereby the arc is extinguished, and means for reigniting the arc.

7. An arc system for radio signaling comprising a current supply and an oscillation circuit connected to an arc, a circuit containing a potential valve and a signaling key shunting a portion of the oscillation circuit, the closing of said key serving to extinguish the arc, and means operative in time with the opening of said key for reigniting the arc.

8. An arc system for radio signaling comprising a current supply and an oscillation circuit connected to an arc, a circuit containing an aluminum lightning arrester, and a signaling key shunting a portion of the oscillation circuit, the closing of said key serving to extinguish the arc, and means operative in time with the opening of said key for reigniting the arc.

9. The method of producing radio signals with an arc which produces an oscillatory current having a peaked potential wave form, which consists in robbing the wave of its peaks.

10. The method of producing radio signals which consists in producing an oscillatory current having a peaked potential wave form in an oscillating circuit and intermittently removing the peaks by shunting the circuit.

In testimony whereof, I have hereunto set my hand at Honolulu, Territory of Hawaii, this 19th day of July, 1917.

ROLAND G. MARX.

In testimony whereof, I have hereunto set my hand at the city and county of San Francisco, State of California, this 31st day of July, 1917.

LEONARD F. FULLER.

J. H. ROGERS.
 RADIOSIGNALING SYSTEM.
 APPLICATION FILED MAR. 28, 1919.

1,316,188.

Patented Sept. 16, 1919.

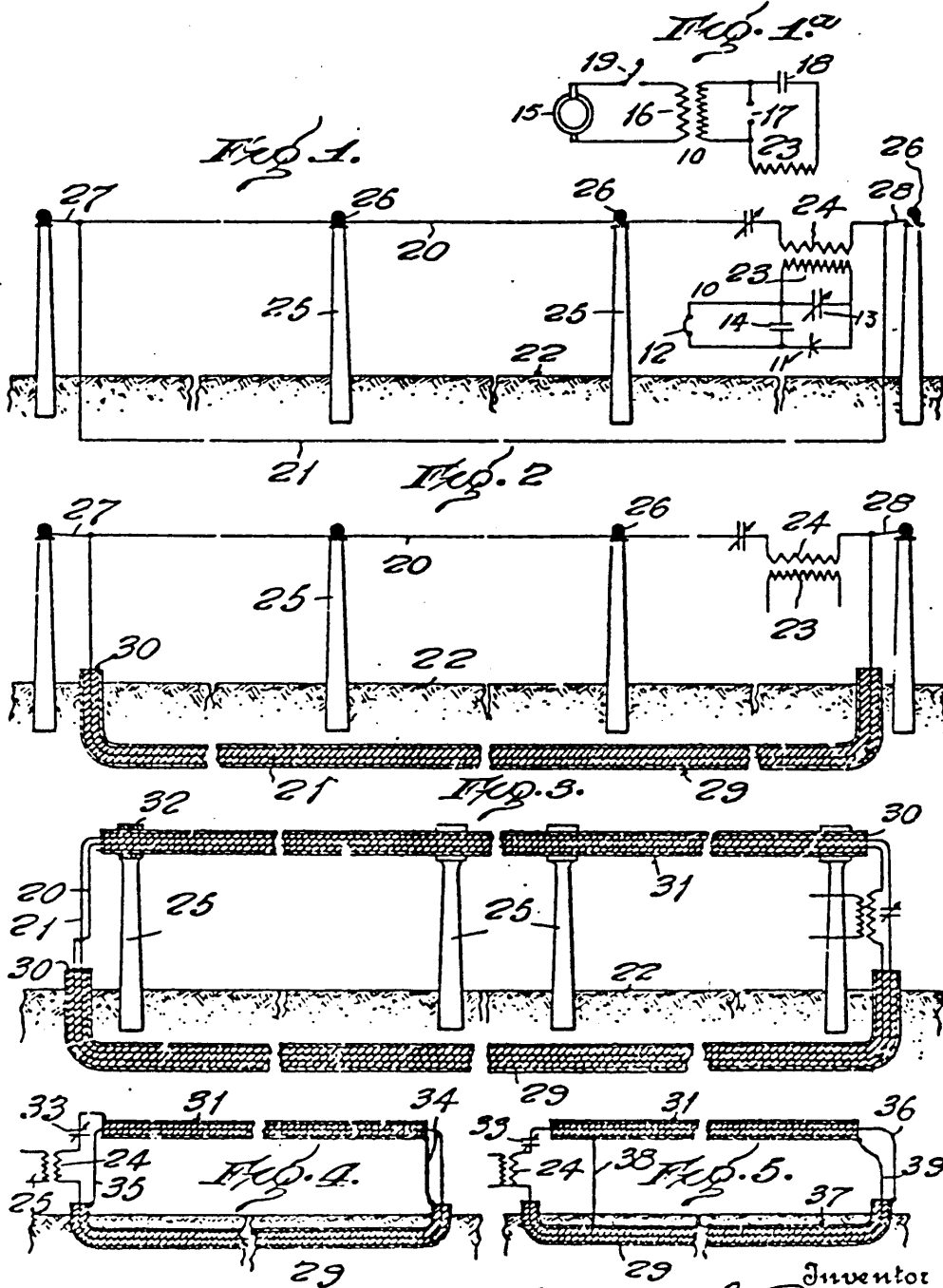

Inventor
James H. Rogers,
Henry B. Venturi,
 Attorney

UNITED STATES PATENT OFFICE.

JAMES H. ROGERS, OF HYATTSVILLE, MARYLAND.

RADIOSIGNALING SYSTEM.

1,316,188.

Specification of Letters Patent. Patented Sept. 16, 1919.

Application filed March 28, 1918. Serial No. 285,749.

To all whom it may concern:

Be it known that I, JAMES H. ROGERS, a citizen of the United States, residing at Hyattsville, in the county of Prince Georges and State of Maryland, have invented new and useful Improvements in Radiosignaling Systems, of which the following is a specification.

My invention relates to radio signaling systems, and particularly to that type of systems in which the antenna or radio conductor or conductor for radiating electromagnetic oscillations or receiving the same, is located either partly or entirely beneath the surface of the earth.

One object of the invention is to utilize more effectively the so-called "surface waves" traversing the earth's crust, and the so-called "space waves" propagated through the air or ether above the surface of the earth.

Another object is to eliminate more effectively the "strays" or static interferences which have proved so detrimental in wireless signaling.

In carrying the invention into effect I provide what is commonly called a loop, and this is arranged to extend substantially horizontally or parallel to the surface of the earth, one side of the loop being buried beneath the surface of the earth and the other side being disposed above the surface of the earth.

The invention consists in the novel combination and arrangement of apparatus and circuits constituting a wireless signaling system hereinafter described and claimed and illustrated in the accompanying drawings, all for the purpose of transmitting and receiving signals through space.

The invention is diagrammatically illustrated in the accompanying drawings, in which:

Figure 1 shows the looped conductor consisting of uninsulated wire, receiving instruments being associated with the conductor;

Fig. 1^a shows a conventional arrangement of sending instruments, which may be substituted for the receiving instruments for transmitting signals, it being understood either the sending or receiving instruments shown in Figs. 1 and 1^a are to be used in connection with the arrangement shown in the remaining figures;

Fig. 2 shows an embodiment of the in-

vention in which the portion of the radio conductor buried beneath the surface of the earth is insulated therefrom and inclosed within a metallic casing;

Fig. 3 shows an embodiment of the invention in which both the portion of the radio conductor below the surface of the earth and the portion above the surface of the earth are inclosed by a metallic casing;

Figs. 4 and 5 illustrate modifications in which a portion or portions of the radio conductor is or are inclosed within another portion or portions of the same.

Referring to the drawings, 10 indicates the signal instruments, which in Fig. 1 are those for receiving signals, while in Fig. 1^a the instruments for sending signals are shown. In Fig. 1, 11 is a detector of any type, preferably an audion, 12 a telephone, and 13 and 14 the usual condensers. Any desired type of instruments and arrangement of connecting circuits may be employed.

In Fig. 1^a suitable sending instruments are conventionally shown. These comprise a generator 15, transformer 16, spark gap 17, condenser 18 and key 19.

The above-mentioned instruments are well known in the art of radio or magnetic wave signaling, and need not be further described.

Referring first particularly to Fig. 1, the looped radio conductor is shown as an uninsulated wire disposed, one side 20 of the loop, above the surface of the earth, and the other side 21, buried beneath the surface of the earth. The surface of the earth is indicated at 22.

The signal instruments are shown associated with the radio conductor by means of an inductive coupling, one side 23 of which constitutes one winding of the transformer, and 24 the other winding of the transformer, but may be associated therewith in any other suitable manner. The winding 24 is included in the looped radio conductor.

One side of the loop 20 is supported above the surface of the earth in any suitable manner as by posts 25, upon which insulators 26 are provided. The posts 25 are preferably rather short, say ten to twenty feet, as it is not desirable to have the elevated side of the loop too far above the surface of the earth. A truss wire 27 may be employed at one end of the loop for securing that end, and a second truss wire 28 may be employed at the other end of the loop for

the same purpose. It will therefore be seen that the side 20 of the loop is supported above but insulated from the surface of the earth.

8 The other side 21 of the loop may be buried beneath the surface of the earth in electrical contact with the earth substantially throughout its length. It will be observed that both sides of the loop are disposed substantially horizontally or parallel to the surface of the earth, and the extent of the loop may be varied in accordance with the requirements and special conditions under which it is desired to work. For instance the loop may be 500 feet, 1000 feet, 10 15 or 25000 feet, or more, in length.

Instead of having the side of the loop buried beneath the surface of the earth in direct contact with the earth, it may be insulated therefrom as shown in Figs. 2 and 3. 20 In Fig. 2 the side 21 of the loop is shown inclosed within a metallic casing 29, which is preferably an ordinary iron pipe, from which the radio conductor is insulated by insulation 30. In this instance all of the 25 advantages of the action of the metallic casing inclosing the side of the loop may be obtained, the said casing being itself in intimate contact with the earth substantially throughout its length. 30

In Fig. 3, a plurality of coils of the looped conductor are shown, the signaling instrument being associated with one of these coils and the side 21 of the loop buried beneath 35 the surface of the earth is inclosed within a metallic casing 29 from which the radio conductors are insulated, as shown in Fig. 2. In the system here shown, also, the side 20 of the loop above the surface of the earth 40 is inclosed within a metallic casing 31 from which the radio conductor is insulated, as already described in connection with the side of the loop below the surface. The metallic casing 31 is supported by posts 25, from 45 which it is insulated by means of insulators 32.

In Fig. 4 the loop is shown as composed of various parts including both metallic casings and ordinary wire conductors. Here 50 the circuit is from coil 24 of the inductive coupling, condenser 33, the metallic casing 31 insulated above the surface of the ground, wire 34 connecting the other end of said metallic casing with the adjacent end of 55 the metallic casing 29 buried beneath the surface of the ground and in contact therewith substantially throughout its length, and wire 35 which extends through metallic casing 31 but insulated therefrom and then 60 through metallic casing 29 and return to coil 24. In this instance the entire structure will oscillate in accordance with the oscillations employed in sending or receiving signals.

65 In the modification shown in Fig. 5, the

loop is somewhat similar to that shown in Fig. 4, the circuit being from coil 24, condenser 33, conductor 36 passing through metallic casing 31 and insulated therefrom, and connected to the adjacent end 37 of 70 metallic casing 29, wire 38 connecting the opposite end of said casing 29 with the adjacent end of casing 31, the opposite end of casing 31 and through wire 39 to coil 24.

It will be understood that it is an intention in the above embodiments of the invention shown in Figs. 2, 3, 4 and 5, that the 75 side of the loop buried beneath the surface of the earth should in some instances be entirely insulated from the earth, and others that it should include one conductor within 80 another.

A looped radio conductor arranged as above described, decreases the disturbances to which radio signals are more or less subject, and this decrease is more or less according to the combination of wires and metallic casings employed, and the circuits, capacities, and inductances used at the point of receiving. The "strays" may be almost entirely "balanced", out by the proper 90 arrangements of values of the above mentioned circuits, capacities and inductances.

In accordance with the patent statutes I have described what I now believe to be the 95 best embodiment of the invention, but I do not wish to be understood thereby as limiting myself or the scope of the invention, as many changes and modifications may be made without departing from the spirit of 100 the invention and all such I aim to include in the scope of the appended claims.

What I claim as new, and desire to secure by Letters Patent of the United States, is:—

1. A radio signaling system comprising a 105 looped radio conductor containing a plurality of turns of radio conductor extending substantially parallel to and having one side of the loop buried beneath the surface of the earth, and radio signal instruments associated 110 with said conductor.

2. A radio signaling system comprising an elongated looped radio conductor, the sides of the loop extending substantially parallel to the surface of the earth, one side 115 of the loop being buried beneath the surface of the earth but insulated from the earth substantially throughout its length, the other side of the loop being supported above the surface of the earth, and signal instruments 120 associated with said conductor.

3. A radio signaling system comprising an elongated looped radio conductor, the sides of the loop extending substantially parallel to the surface of the earth, one 125 side of the loop being buried beneath the surface of the earth, a metallic covering inclosing said buried side of the loop throughout its length but insulated therefrom, the other side of said loop being sup- 130

ported above the surface of the earth but insulated therefrom, and signal instruments associated with said conductor.

4. A radio signaling system comprising an elongated looped radio conductor, the sides of the loop extending substantially parallel to the surface of the earth, one side of the loop being buried beneath the surface of the earth, a metallic covering inclosing said buried side of the loop throughout its length but insulated therefrom, the other side of said loop being supported above the surface of the earth, and a metallic casing inclosing said last mentioned side of the loop throughout its length but insulated therefrom and from the earth, and signal instruments associated with said conductors.

5. A radio signaling system comprising an elongated looped radio conductor, the sides of the loop extending substantially parallel to the surface of the earth, one side of the loop being buried beneath the surface of the earth, but insulated therefrom, the other side of said loop being supported above the surface of the earth, and a metal-

lic casing inclosing said last mentioned side of the loop throughout its length but insulated therefrom and from the earth, and signal instruments associated with said conductors.

6. A radio signaling system comprising an elongated looped conductor which includes within the loop one conductor passing through and inclosed within but insulated from the other conductor, and signal instruments associated with said conductor.

7. A radio signaling system comprising an elongated looped radio conductor containing a plurality of turns, one side of the loop extending substantially parallel to and having one side of the loop buried beneath the surface of the earth, the other side of the loop being supported above the surface of the earth, each side of the loop consisting of a metallic casing and a length of the radio conductor disposed therein but insulated therefrom.

In testimony whereof I have hereunto set my hand.

JAMES H. ROGERS.

W. E. BEAKES.
APPARATUS FOR WIRELESS TELEGRAPHY AND TELEPHONY.
APPLICATION FILED APR. 19, 1919.

1,362,383.

Patented Dec. 14, 1920.

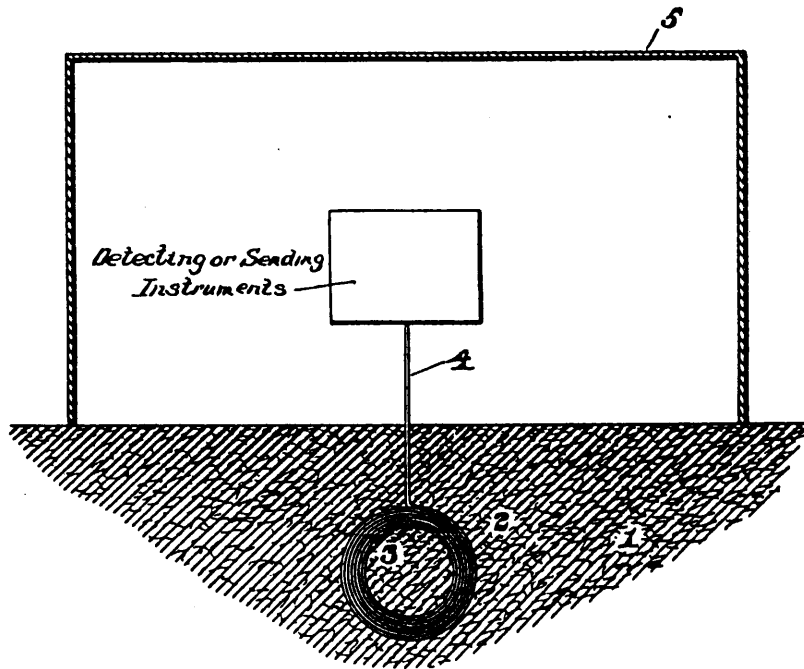

William E. Beakes
Inventor:

by Harrison F. Lyman
Atty.

UNITED STATES PATENT OFFICE.

WILLIAM E. BEAKES, OF NEW ORLEANS, LOUISIANA, ASSIGNOR TO UNITED FRUIT COMPANY, OF BOSTON, MASSACHUSETTS, A CORPORATION OF NEW JERSEY.

APPARATUS FOR WIRELESS TELEGRAPHY AND TELEPHONY.

1.362.383.

Specification of Letters Patent. Patented Dec. 14, 1920.

Application filed April 19, 1919. Serial No. 291,310.

To all whom it may concern:

Be it known that I, WILLIAM E. BEAKES, a citizen of the the United States, residing at New Orleans, parish of Orleans, State of Louisiana, have invented certain new and useful Improvements in an Apparatus for Wireless Telegraphy and Telephony, of which the following is a specification.

The chief purpose of my invention is to provide means for eliminating or reducing to a minimum the effect of static or other objectionable disturbances which often seriously interfere with the reception of radio signals. Heretofore it has been common practice to use vertically or horizontally extending antennæ supported in the air. More recently, however, it has been found possible to receive radio signals with an antenna embedded in the earth. My invention relates to systems in which the antenna is embedded in the earth, and broadly speaking, consists in using in such a system an antenna consisting of a coil of wire. This wire should be insulated, and preferably should be inductively wound. I find that by means of using such a coil it is possible largely to eliminate the effect of static and other disturbances. Such an antenna is, moreover, very much easier and cheaper to install and maintain than an antenna consisting of an extended wire.

I also preferably protect the leads and instruments connected with the antenna by surrounding them with a metallic shield.

I have illustrated one form of my invention in the accompanying drawing, in which 1 represents the earth and 2 an inductively wound coil of insulated wire embedded in the earth. This coil terminates at one end in an insulated dead end 3. The other end of the coil terminates in a lead 4 which is connected into any usual receiving circuit. Since the particular nature of the circuit used forms no part of my invention, it is not necessary to illustrate the receiving system. The antenna circuit, after passing through the receiving system, is preferably grounded in the usual manner.

5 represents a shield or screen of metal which rests upon the ground and within which are placed the receiving instruments and the portions of the circuit external to the ground. This shield has the function and effect of protecting the receiving instruments and the portions of the circuit external

to the ground from the effect of static or other disturbing electrical influences. It is important to avoid, so far as possible, any extended lead from the coil to the receiving instruments, and therefore I preferably place the shield and the instruments within it directly above the embedded coil, in this manner reducing to a minimum the extent of the lead from the coil to the instruments.

I may if desired use more than one such coil.

My invention is of chief value in a receiving system, but it may also be used as the antenna in a sending system, in such case the embedded coil being connected to any ordinary sending circuit.

The coil 2 may be wound in any desired manner, but preferably it should be inductively wound,—that is to say, the several turns should be in inductive relation to each other, and I have found that a coil in substantially the form illustrated in the drawing gives the best results.

The amount of wire used in the coil may be varied, but I prefer to use about as much wire as would ordinarily be used in the ordinary form of antenna.

Instead of embedding the coil 3 in the earth, I may embed it in a body of water, such as a river or a well; and embedding the coil in water has the advantage that the coil may be turned into different planes, according to the direction from which the signals to be received emanate.

The term "embedded in the earth" as used in the appended claims will be understood as including such embedment of the coils in water as above described.

What I claim and desire to secure by Letters Patent is:—

1. In an apparatus of the character described, an antenna consisting of a coil of insulated wire embedded in the earth, one end of said coil being a dead end and the other leading to detecting instruments, and thence to ground.

2. In an apparatus of the character described, an antenna consisting of a coil of inductively wound insulated wire embedded in the earth, the several turns of the wire lying in substantially vertical planes, said coil terminating at one end in a dead end and at the other in a lead to receiving instruments and thence to a ground connection.

60

65

70

75

80

85

90

95

100

105

110

2

1,362,383

3. In an apparatus of the character described, an antenna consisting of a coil of inductively round insulated wire embedded in the earth, the several turns of the wire lying in substantially vertical planes, said coil terminating at one end in a dead end and at the other in a lead to receiving instruments and thence to a ground connection, and a metallic shield protecting said

instruments and external portions of the circuit from external electrical disturbances.

In witness whereof, I have hereunto set my name in the presence of two witnesses this 10 day of April, 1919.

WILLIAM E. BEAKES.

Witnesses:

HECTOR M. HOLMES,
H. F. LYMAN.

L. DE FORREST,
 SUBTERRANEAN SIGNALING SYSTEM.
 APPLICATION FILED JUNE 16, 1917.

1,424,805.

Patented Aug. 8, 1922.

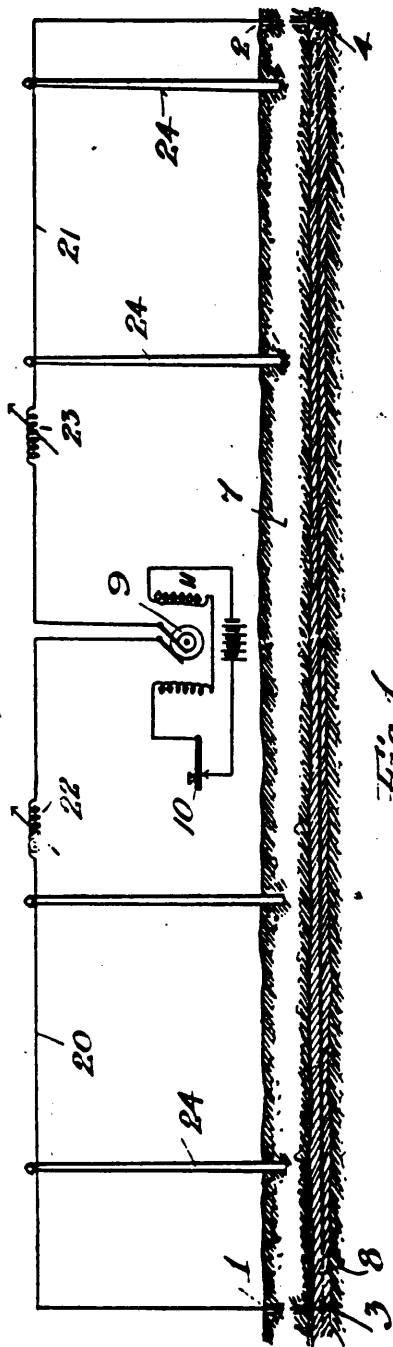

Fig. 1.

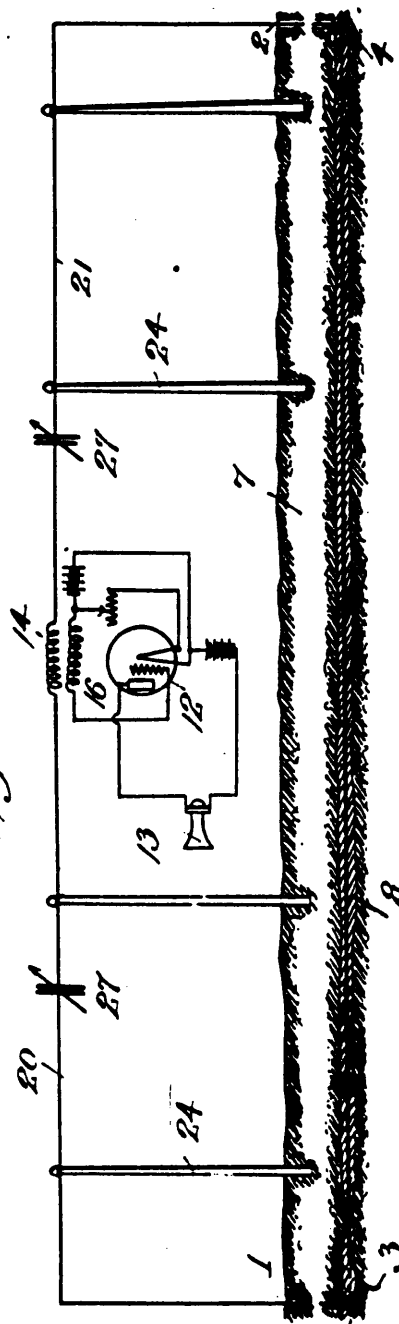

Fig. 2.

Inventor
L. de Forrest
By his attorney Samuel Darby

UNITED STATES PATENT OFFICE.

LEE DE FOREST, OF NEW YORK, N. Y.

SUBTERRANEAN SIGNALING SYSTEM.

1,424,805.

Specification of Letters Patent. Patented Aug. 8, 1922.

Application filed June 16, 1917. Serial No. 175,119.

To all whom it may concern:

Be it known that I, LEE DE FOREST, a citizen of the United States, residing at New York, in the county and State of New York, have made a certain new and useful Invention in Subterranean Signaling Systems, of which the following is a specification.

This invention relates to signaling systems and more particularly to electrical subterranean signaling systems.

The object of the invention is to provide an electrical subterranean signaling system which is simple in arrangement and efficient in operation.

Further objects of the invention will appear more fully hereinafter.

The invention consists substantially in the construction, combination, location and relative arrangement of parts, and the system employed, all as will be more fully hereinafter set forth, as shown by the accompanying drawing and finally pointed out in the appended claims.

Referring to the drawing:

Fig. 1 is a diagrammatic view of the subterranean transmission system embodying my invention.

Fig. 2 is a similar view of a receiving system embodying my invention. The same part is designated by the same reference numeral wherever it occurs throughout the several views.

Referring to the drawing:

I designate at 7 the upper stratum of the earth's surface and at 8 a lower stratum of different conductivity from the surface stratum, and a considerable distance below the surface of the earth. At 1 and 2 I show borings from the surface down to the stratum 8 through which the lines 20, 21 extend, which lines are provided at their ends with metallic plates or bodies 3 and 4 respectively which are lowered through the wells 1 and 2 and make contact with the conducting layer 8. The lines 20 and 21 extend up through wells 1 and 2 and are in the form of insulated wire or cable.

Earth plates 3 and 4 are separated by a considerable distance which may be several miles, or even several hundreds of miles, and are connected to each other through the overhead lines or group of wires 20, 21, separated by suitable insulated poles 24.

Fig. 1 represents the transmitting station, as above outlined and in the form shown is a telegraph transmitting station wherein any suitable source of current may be employed, such for example, as the alternating current dynamo 9. This generates alternating current preferably of sustained waves and of frequency low as compared with those now used in radio telegraphy, that is, from 500 to 25,000 per second. The current thus generated may be controlled in any desired manner, for example, by the Morse key 10, located in the field circuit 11, of the dynamo.

While I have shown the system as a telegraph system it is obvious that with but slight modification the system may be employed for telephone signals, and many of the improved apparatus well known in the art for use in connection with either of the telegraph or telephone systems, might be readily employed without departing from the scope of my invention as defined in the claims.

The earthed circuit is preferably attuned to the generator frequency by suitable means for example, the variable inductances 22, 23. I have discovered that for the frequencies above described the earth offers comparatively little impedance so that relatively large amounts of energy are radiated or sent out in the form of conduction currents so that great distances can be covered by this means of signaling, comparable even with those attained in radio communication with smaller amounts of energy at the transmitter. By this system I am enabled to avoid the interferences caused by atmospheric disturbances which so frequently interrupt aerial radial communication.

The problems of interferences between several stations are similar to those in the present radio art and are overcome in the same manner as in the present art for example, by tuning to resonance between stations. At the receiving station shown in Fig. 2 the source of alternating current 9 is replaced by a detector and telephone receiver for example, by the audion detector 12 associated with the overhead line 20, 21 by the transformer 14, 16 as shown. The receiver 13 is included in the usual audion receiving system well known in the art. In the receiving station the overhead line and earth return system should be tuned to the

frequency of the generator at the transmitting station in any desirable manner either by means of variable inductances as shown in Fig. 1, or by means of variable condensers 27, as shown in Fig. 2 or by both. It will be apparent, as shown, that it is preferable to have the earth plates 3 and 4 of the receiving system in the same stratum 8 as that in which the earth plates 3 and 4 of the transmitting system are buried.

Having now set forth the objects and nature of my invention and having shown and described a construction, embodying the principles thereof, what I claim as new and useful and of my own invention and desire to secure by Letters Patent is:

1. A system of electrical signalling comprising a pair of overhead base lines each formed between plates buried in the earth in substantially the same stratum of different conductivity from that of the earth's surface, and a signalling circuit associated with each of said base lines.

2. A system of electrical signalling comprising a pair of overhead base lines each formed between plates buried in the earth in substantially the same stratum of greater conductivity than that of the earth's surface, and a signalling circuit associated with each of said base lines.

3. A system of electrical signalling comprising a pair of overhead base lines each formed between plates buried in the earth in substantially the same stratum of different conductivity from that of the earth's surface, and a signal transmitting and a signal receiving system respectively associated with said base lines.

4. A system of electrical signalling comprising a pair of overhead base lines each formed between plates buried in the earth in substantially the same stratum of greater conductivity than that of the earth's surface, and a signal transmitting and a signal receiving system respectively associated with said base lines.

5. A system of electrical signalling comprising a pair of overhead base lines substantially parallel to each other, and widely separated, each of said base lines formed between plates widely separated and buried in the earth in substantially the same stratum and of different conductivity from that of the earth's surface, and a signalling circuit associated with each of said base lines.

6. A system of electrical signalling comprising a pair of overhead base lines substantially parallel to each other, and widely separated, each of said base lines formed between plates widely separated and buried in the earth in substantially the same stratum and of greater conductivity than that of the earth's surface, and a signaling circuit associated with each of said base lines.

7. A system of electrical signalling comprising a pair of overhead base lines substantially parallel to each other, and widely separated, each of said base lines formed between plates widely separated and buried in the earth in substantially the same stratum and of different conductivity from that of the earth's surface, and a signal transmitting and a signal receiving system respectively associated with said base lines.

8. A system of electrical signalling comprising a pair of overhead base lines substantially parallel to each other, and widely separated, each of said base lines formed between plates widely separated and buried in the earth in substantially the same stratum and of greater conductivity than that of the earth's surface, and a signal transmitting and a signal receiving system respectively associated with said base lines.

In testimony whereof I have hereunto set my hand on this 31st day of May, A. D. 1917.

LEE DE FOREST.

Nov. 13, 1923.

1,473,921

J. BETHENOD

HIGH FREQUENCY SIGNALING SYSTEM

Filed May 6, 1922

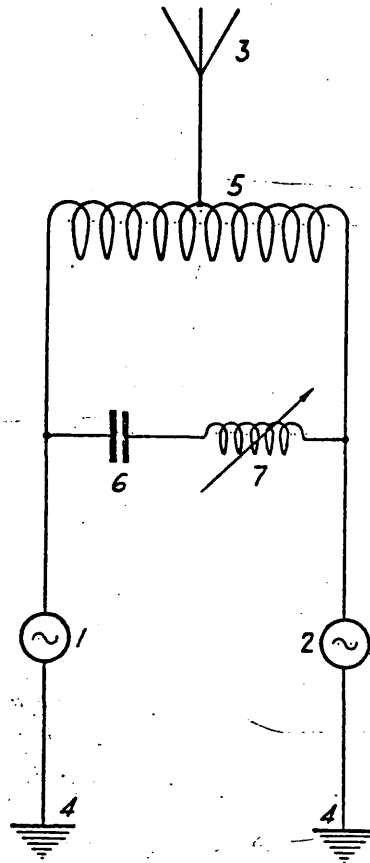

Inventor
JOSEPH BETHENOD

By his Attorney *Ira J Adams*

UNITED STATES PATENT OFFICE.

JOSEPH BETHENOD, OF PARIS, FRANCE.

HIGH-FREQUENCY SIGNALING SYSTEM.

Application filed May 6, 1922. Serial No. 559,009.

To all whom it may concern:

Be it known that I, JOSEPH BETHENOD, a citizen of the Republic of France, and a resident of Paris, France, have invented certain new and useful Improvements in High-Frequency Signaling Systems, of which the following is a specification, accompanied by drawings.

The object of the present invention is to provide arrangements for increasing and regulating the synchronizing connection of high frequency alternators connected in parallel.

The new circuit arrangement to be hereinafter described has two important advantages:

1. The condensers are only traversed by the synchronizing current, whereby their work is materially reduced.
2. The adjustment of the synchronizing connection may be effected independently of the adjustment of the useful individual load of the alternators. As a result of this, the adjustment is easily accomplished because it becomes independent of the usual placing in resonance of the charging circuit comprising the connected alternators and the external apparatus (antennæ, etc.)

In the single figure of the drawing a circuit arrangement is shown in accordance with the above. The high frequency alternators 1 and 2 are assumed directly to feed the antenna 3. One of the poles of each of the alternators is connected to the ground 4 and the two alternators are interconnected through the agency of an inductance coil 5, the central point of which is connected with the antenna 3. The terminals of this coil are short-circuited through the coupling condenser 6, the latter being preferably connected in series with a tuning coil 7.

It will be therefore readily seen that the condenser is traversed only by the synchronizing current, and this current may be tuned to the most suitable value by means of the coil 7. On the other hand, if the magnetic leakage between the two sections of the coil 5 is materially reduced, the ensemble comprising 5 and 6 has practically no appreciable influence on the tuning of the useful current supplied to the antenna 3, the ampere turns corresponding to this current being practically zero. However, the coil 5 may be replaced by a system of two inductances or two capacities connected in series, the

junction point being in turn connected to the antenna 3. But in this case, the system has a certain function in the tuning of the useful output current. However, the tuning of the synchronizing current may be independently effected by means of the ensemble 6, 7.

Obviously, the above described circuit arrangements may be variously modified and more particularly, may be adapted for systems in which the alternator is not connected directly to the antenna as shown in the system herein described, but through a transformer. The arrangement may also be applied to systems in which a plurality of alternators are used.

Having described my invention, what I claim is:

1. The combination of a radiating unit, a plurality of parallel high frequency generators for supplying said radiating unit and a synchronizing connection between said generators comprising a pair of impedances in series shunted by a condenser, said radiating unit being connected to the junction point of said impedances.
2. The combination of a radiating unit, a plurality of parallel high frequency generators for supplying said radiating unit and a synchronizing connection between said generators comprising a pair of impedances in series shunted by a condenser, and an inductance in series, said radiating unit being connected to the junction point of said impedances.
3. The combination of a radiating unit, a plurality of parallel high frequency generators for supplying said radiating unit and a synchronizing connection between said generators comprising a pair of impedances in series shunted by a condenser, and a variable inductance in series, said radiating unit being connected to the junction point of said impedances.
4. The combination of a radiating unit, a plurality of parallel high frequency generators for supplying said radiating unit and a synchronizing connection between said generators comprising an inductance shunted by a condenser, said radiating unit being connected to an intermediate point on said inductance.
5. The combination of a radiating unit, a plurality of parallel high frequency generators for supplying said radiating unit and a

synchronizing connection between said generators comprising an inductance shunted by a condenser between said generators, said radiating unit being connected to the middle of said inductance.

5

6. The combination of a radiating unit, a plurality of parallel high frequency generators for supplying said radiating unit and a synchronizing connection between said generators comprising an inductance shunted by a condenser and an inductance in series between said generators, said radiating unit

10

being connected to the middle of said inductance.

7. The combination of a radiating unit, a plurality of parallel high frequency generators for supplying said radiating unit, said generators being grounded at one terminal, and a synchronizing connection between the other terminals comprising an inductance shunted by a capacity, said radiating unit being connected to a middle point of said inductance.

JOSEPH BETHENOD

Dec. 22, 1925.

1,566,680

A. MEISSNER
SENDING ARRANGEMENT
Filed Sept. 3, 1921

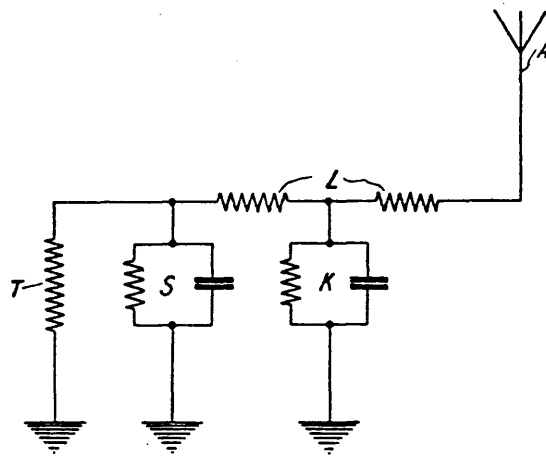

Inventor
ALEXANDER MEISSNER

By his Attorney

Wm J Adams

UNITED STATES PATENT OFFICE.

ALEXANDER MEISSNER, OF BERLIN, GERMANY, ASSIGNOR TO GESELLSCHAFT FÜR
DRAHTLOSE TELEGRAPHIE M. B. H. HALLESCHES, OF BERLIN, GERMANY, A COR-
PORATION OF GERMANY.

SENDING ARRANGEMENT.

Application filed September 3, 1921. Serial No. 498,421.

(GRANTED UNDER THE PROVISIONS OF THE ACT OF MARCH 3, 1921, 41 STAT. L., 1313.)

To all whom it may concern:

Be it known that I, ALEXANDER MEISSNER, citizen of the German Republic, residing at Berlin, Germany, have invented certain new and useful Improvements in Sending Arrangements (for which I have filed applications as follows: Germany, Pat. No. 317,541, filed Oct. 24, 1918; Argentina, Register No. 21 333/236, filed July 20, 1920; Brazil, Register No. 172 38, filed July 10, 1920; Chile, filed Sept. 23, 1920; Denmark, Register No. 3423/19, filed Dec. 18, 1919; Netherlands, Register No. 14287, filed March 13, 1920; Japan, Register No. 58307, filed July 1, 1920; Norway, Register No. 18896/19, filed Dec. 31, 1919; Austria, Register No. A3370/19, filed Dec. 23, 1919; Peru, filed Oct. 29, 1920; Sweden, Register No. 50290/19, filed Nov. 25, 1919; Spain, Patent No. 72216, Czechoslovakia, Register No. P. 4766/20, filed June 25, 1920), of which the following is a specification.

German Patent No. 304,361, and addition Patent, No. 310,731, describe circuit arrangements which prevent the intrusion into the antenna of the harmonics generated by the high frequency generator. It has been found that the object cannot be fully attained by the means disclosed in these patents, but that, on the contrary, a certain portion of the harmonics still reaches the antenna circuit and is then radiated therefrom. In order to avoid under all circumstances the resulting disturbances in the neighboring receiving stations, the present invention provides an improvement of the circuit arrangements disclosed in the above-mentioned patents in which one or a plurality of oscillating circuits tuned to the fundamental frequency of the arrangement are branched from parts of the antenna inductance.

The single figure of the drawing shows a circuit arrangement adapted for this purpose.

As shown, the antenna A is grounded and contains the secondary coil T of a transformer, the primary winding of which is connected with the high frequency generator. Obviously, if a cathode tube generator is employed, the cathode tube with its associated coupling elements may be connected into the antenna circuit in place of the secondary coil T. A closed or loop cir-

cuit S is connected to the antenna and ground in parallel with the secondary winding T, and this circuit is tuned to the fundamental frequency radiated by the antenna A. The circuit S presents an infinite resistance to current of the fundamental frequency, but short circuits the harmonics. The present invention provides for improvements in this circuit which forms the subject of the older patents, and, in accordance with the invention, one or a plurality of tuned loop circuits K are provided in the form of chain connections branched off from different points in the antenna self-inductance L. In other words, an inductance is provided between the points of connection with the antenna of the circuit S and the first circuit K, and inductances are also provided between the points of connection with the antenna of the circuits K, when a plurality of circuits K are employed. The circuits K are also tuned to the fundamental frequency and present an infinite resistance against the latter. On the other hand, the harmonics that reach the antenna notwithstanding the circuit S, find in the circuits K a path of slight resistance, and are, therefore, conducted through circuit K to ground and are not radiated from the antenna.

Obviously, the above described circuit arrangement can also be used in case, instead of a cathode tube generator, high frequency generators of other types, such as arc lamps, high frequency machines or similar devices are employed for producing the high frequency oscillations.

Having described my invention, what I claim is:

1. A sending arrangement for wireless telegraphy and telephony comprising a grounded antenna, a grounded loop circuit connected to the antenna in parallel with its grounded portion and tuned to the fundamental frequency of the arrangement, a second grounded loop circuit connected to the antenna in parallel with said first-mentioned circuit and also tuned to said fundamental frequency, and an inductance in the antenna between the points of connection of said loop circuits therewith.

2. A sending arrangement for wireless telegraphy and telephony comprising a grounded antenna, a plurality of loop circuits connected with the antenna in parallel

with each other and with the grounded portion of the antenna and tuned to the fundamental frequency of the arrangement, and inductances in the antenna between the points of connection of said circuits thereto.

3. A sending arrangement for wireless telegraphy and telephony comprising a grounded antenna having a source of energy connected therein, a grounded loop circuit connected with the antenna in parallel to said source and tuned to the fundamental frequency of the arrangement, and inductances in the antenna on opposite sides of the point of connection of said circuit thereto.

4. A sending arrangement for wireless telegraphy and telephony comprising a grounded antenna and means for preventing radiation of harmonics from the antenna, said means comprising a plurality of loop circuits connected with the antenna in parallel with each other and each comprising a capacity and an inductance, and inductances in the antenna between the points of connection of said circuits thereto.

5. A sending arrangement for wireless telegraphy and telephony comprising, a grounded antenna having a source of energy connected therein, a grounded loop circuit connected to the antenna in parallel with

said source and tuned to the fundamental frequency of the arrangement, a second grounded loop circuit connected to the antenna in parallel with said first mentioned circuit and also tuned to said fundamental frequency and a reactance in the antenna between the points of connection of said loop circuits thereto.

6. A sending arrangement for wireless telegraphy and telephony comprising, a grounded antenna having a source of energy connected therein, a grounded loop circuit connected with the antenna in parallel to said source and tuned to the fundamental frequency of the arrangement and reactances in the antenna on opposite sides of the point of connection of said loop circuit thereto.

7. A sending arrangement for wireless telegraphy and telephony comprising, a grounded antenna having a source of energy connected therein, a grounded loop circuit connected to the antenna in parallel to said source and tuned to the fundamental frequency of the arrangement, and a reactance in the antenna between the point of connection of said circuit thereto and said source.

In testimony whereof I affix the signature.
ALEXANDER MEISSNER.

Oct. 21, 1930.

F. S. CHAPMAN

Re. 17,844

METHOD OF DETECTING PRESENCE AND APPROXIMATE LOCATION OF METALLIC MASSES

Original Filed Nov. 12, 1919

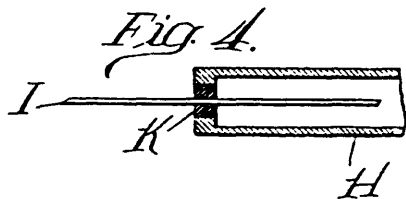
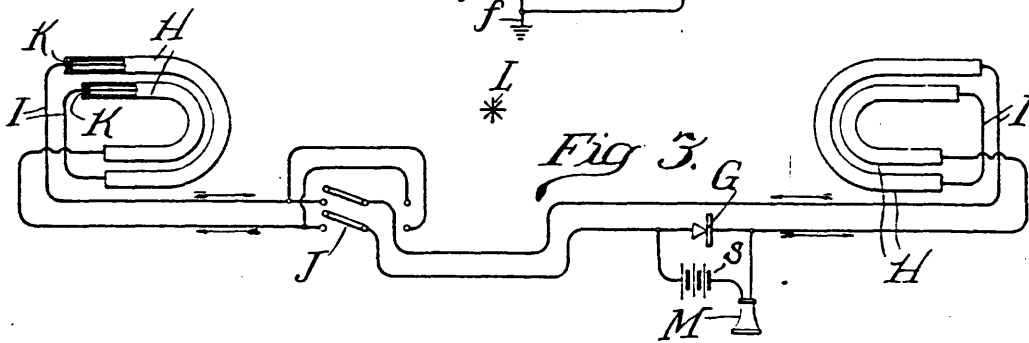
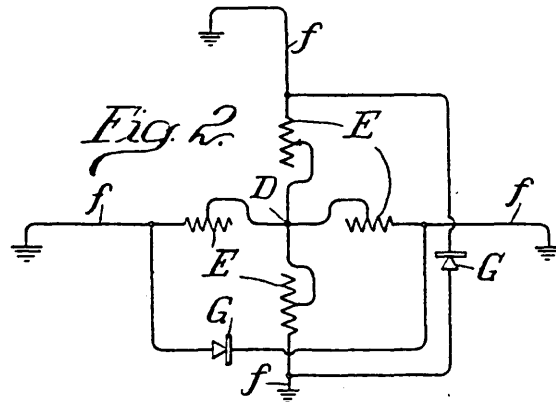
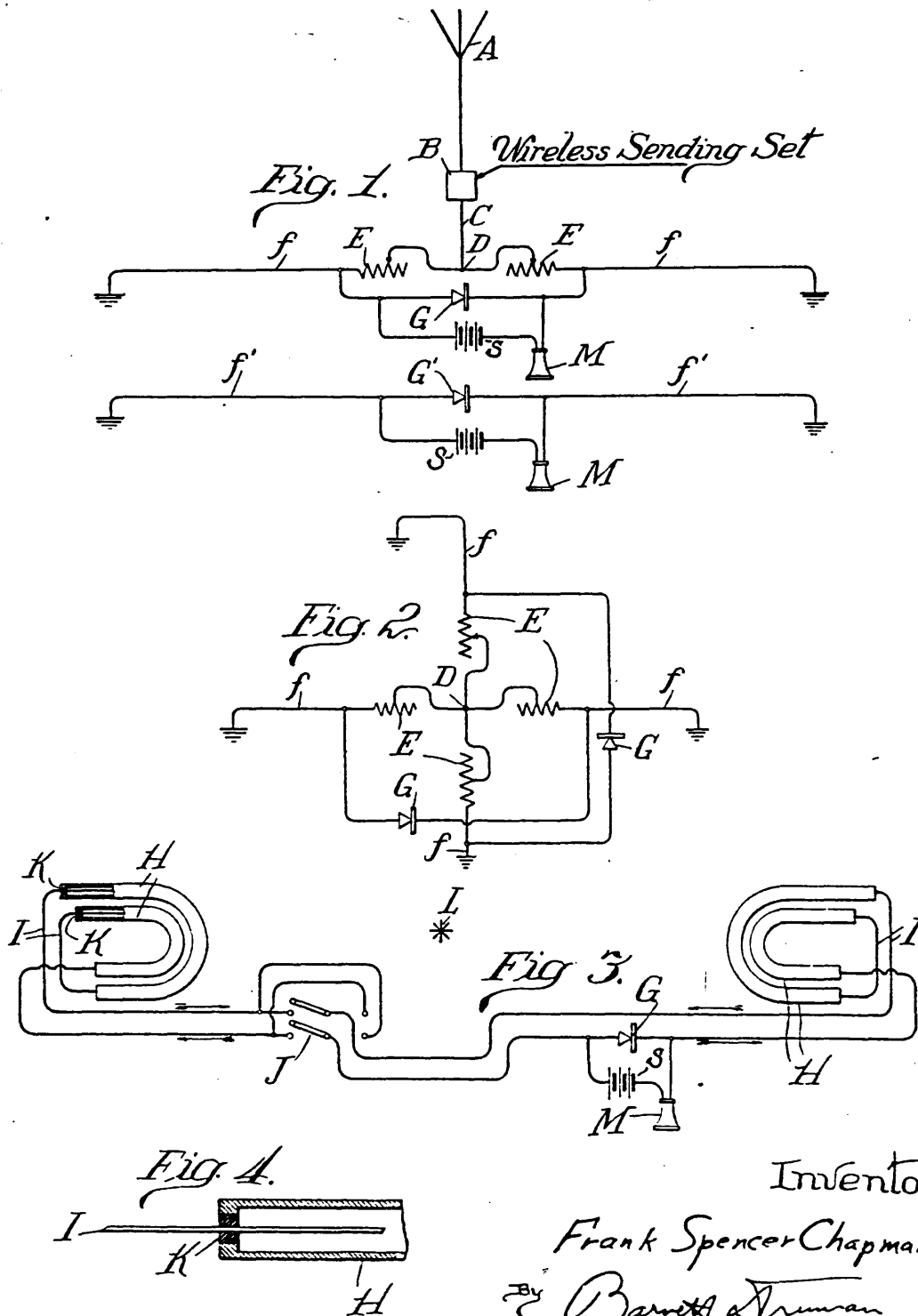

Inventor
Frank Spencer Chapman
By Barnett & Truman
Attorneys

UNITED STATES PATENT OFFICE

FRANK SPENCER CHAPMAN, OF MAYWOOD, ILLINOIS

METHOD OF DETECTING PRESENCE AND APPROXIMATE LOCATION OF METALLIC MASSES

Original No. 1,564,940, dated December 8, 1925, Serial No. 337,481, filed November 12, 1919. Application for reissue filed December 5, 1927. Serial No. 237,961.

My invention relates to wireless electric communication systems generally, and the object of my invention is—

First, to provide an improved means for receiving wireless impulses from beneath the ground or water-body surfaces;

Second, to provide an improved means whereby wireless electric impulses may be received at the same time wireless electric impulses are being sent;

Third, to provide an improved means whereby the direction of travel of wireless electric impulses may be determined, thus providing means which may be used in the art for other purposes; and

Fourth, to provide an improved method of detecting the presence and approximate location of metallic masses or other electrical conducting or wireless-wave reflecting masses.

By the terms "wireless" or "radio" as used herein, I mean to cover waves of any frequency, whether it be in the magnetic field produced by a low frequency source, a frequency in the audio range, or up to the highest radio wave that may be produced.

I attain these objects by the apparatus shown in the accompanying drawings in which:

Fig. 1 shows a portion of a sending-receiving wireless station having a ground-wireless antenna and an aerial antenna; Fig. 2 is merely another view of that portion of Fig. 1 comprising the antennæ *ff*, the function of Fig. 2 being to indicate that the antennæ *ff* of Fig. 1 comprise two sets at right angles to each other; Fig. 3 shows two large loop antennæ for receiving purposes, part of the wire thereof being shielded with iron or other suitable metal tubes. This loop system is in a balanced position with regard to L, a wireless-wave-source representing the central part of the field surrounding A, Fig. 1; Fig. 4 is an enlarged detail of part of H, Fig. 3.

Fig. 1 is a drawing showing the aerial antenna A, the wireless electric sending set B, and a ground wire C leading from B. C is divided at D as shown. EE are variable resistances. *ff* are two branches of C. *ff* comprise what I term the "ground antennæ" and are to be connected to earth or, if used on the

sea, are to be "grounded" by being attached to suitable electrodes submerged in the water. G is a detector and M the receiver located in the receiving circuit passing through detector G and receiver M and energized by the battery S associated therewith. G should be placed in the central or balanced position so that when current is flowing to ground from *ff* no current will flow through G. This may be done by well known methods. Under such conditions, impulses may be sent from the system and will not be heard in receiver M. Wireless electric impulses, coming from beneath the ground and traveling parallel with *ff* will cause a current to flow in *ff*, the resistance EE forcing the said current to flow through G and thus operate M.

But if the wireless impulses travel in a direction parallel with the sea surface and at right angles with *ff* no current will flow in *ff*. And by having the "ground" antenna movable this arrangement will provide means whereby the line of direction of the wireless impulses may be determined.

ff' is a second "ground" antenna only. It is used for receiving purposes only and in that respect it will function same as *ff*. Placed closely parallel with *ff* it will be easier to balance against outgoing impulses from this station, as it will not act as a conductor of outgoing current.

Fig. 2 shows two "ground" antennæ arranged at right angles to and crossing each other at the common central point, as shown, and joined at D to which is connected the wireless sending set B and aerial antenna A as in Fig. 1. With this, two messages may be received at the same time, if the direction from which they are coming be at right angles, or approximately so, with each other. Or the whole apparatus may be moved on the position of D as a pivot until, for a given set of impulses being received, no noise is heard in one receiver and the heaviest noise in the other. Thus the line of direction of the impulses under observation may be determined.

Fig. 3 shows two "looped" antennæ located some distance apart with a pair of wires connecting them through the line-reversing switch J. I, I are exposed wires

55

60

65

70

75

80

85

90

95

100

forming part of the "loop", the continuation of which wires enter H, H, which are iron tubes enclosing the continuation of I, I and insulated from the latter to all points. The purpose of H, H is to intercept the radio waves so that they will not cut through the tube-enclosed parts of I, I, so that no current will be induced in such enclosed part of I, I. Were all of the wire of the loop exposed, the wireless waves would induce current in both sides of the loop, of approximately equal strength, but the current from one side of the loop would be in a direction to oppose that from the other, and both would be somewhat neutralized, and hence would be somewhat inoperative as regards the receiver. But by enclosing part of I, I in the tubes as shown, a louder noise will be heard in the receiver and thus messages may be better received. By adding large numbers of turns to the loop, this may be greatly increased. This action of the system as shown depends, however, on the position of J. If it be closed in one position, the output from one of the "looped" antenna will coincide in direction with that from the other, and the effect be to "boost" the voltage and thus increase the receiving efficiency. But, if J be thrown to the other closed position, the two looped antennae will "buck" each other, and if both are at an equal distance from the wireless source, silence in the receiver will result.

Therefore, if "L" be a wireless wave source, (such as A and B, Fig. 1), separated from and at an approximately equal distance from both of the "looped" antennae, it may be worked and not heard in the receiver, if J be in the "bucking" position. It may be difficult to get absolute silence, but at least the sound will be greatly reduced. But another set of wireless impulses, their source being further from one of the looped antennae than the other and not in a direction parallel to II may be heard in the receiver and not interfered with by "L".

Impulses coming from "L" may cause induced impulses or reflected waves to come from a nearby metal mass and these induced impulses, cutting through the looped antennae may cause a noise in the receiver, and thus indicate the presence of an otherwise hidden metal mass. In this case, all the apparatus shown in Fig. 3 should be mounted on the same movable base, so that in action "L" will always be at an equal distance from both "looped" antennae. By proper maneuvering, the metal mass may be located. And substantially this same action and result may be had with Fig. 1.

The apparatus shown herein is also described, and claimed in my application for patent dated as filed May 7, 1921, Serial No. 467,752, "wireless communication system", the method of operating only being claimed herein.

Fig. 4 shows an enlarged detail of H with its insulating part K separating I from H.

The method of operation is as follows:

The system is first balanced in a location where it cannot be affected by the presence of any metal, care being taken to see that no such mass exists within its range, except that of the ship or mounting on which it is located, (the balancing takes care of such mounting). Then, assuming that the metal mass which it is desired to locate is beneath the sea surface, the apparatus being mounted on a ship, the said ship is moved continuously in any direction, the sending set B being worked at short intervals. And when at the time of such working, a noise corresponding in time and duration thereto is heard in any of the receivers M, it indicates the presence of a metal mass.

This noise may be first heard in any of the antennae, and if not in the apparatus covered by Fig. 3, there should be a change of direction of the ship until it is heard in M Fig. 3. The ship is then maneuvered in all possible directions and preferably over as small an area as possible until the noise in M, Fig. 3, ceases or diminishes with comparative suddenness. The ship is then in the same manner as before placed at right angles to the just-found silent position, and if the silence in M, Fig. 3 is still maintained, the ship is over the searched-for metal mass. If not, further maneuvering of the ship must be carried on until the suddenly-arrived-at silence or diminished reception is maintained in M, Fig. 3 in all positions of the ship. Thus the general line of direction between the ship and the metal mass may be determined as also the approximate location thereof.

When the metal mass to be located is beneath the ground, instead of beneath the surface of the sea, the apparatus may be transported from place to place on the earth's surface in the same manner that the ship was maneuvered in the above described operation.

By the expression "balancing out" or "balancing" as used herein in connection with the turning or moving of a receiving loop antenna so that the direction of wave travel may be found, I mean the ceasing or diminishing of reception, caused by two electric currents set up in the said loop antenna in such a way that they oppose each other, and if they are of equal strength they completely neutralize or balance each other. The said turning or moving usually brings about such a condition gradually, causing the said diminishing, and in a perfect operation of this sort final ceasing of reception. But such perfect operation may be rare, and instead of complete silence being attained there may be only a point of minimum reception, which will be adequate for the purposes of this method. In practical operation of this balancing method, the loop

antenna of a receiving set is usually turned on its vertical axis during reception until reception ceases, or a point of minimum reception is reached.

05 There are two distinct forms of balancing simultaneously utilized in this method. First, in each loop the current induced in one side of the loop is opposed to the current induced in the opposite side by positioning the
10 plane of the loop at right angles to the direction of reception of the waves. Secondly, the two loops are balanced against one another by opposing the currents induced in each loop, or the manifestations thereof,
15 against one another. In the apparatus here disclosed by way of example, this is accomplished by the reversing switch J.

I claim:

20 1. The method of determining the general line of direction between a given position and a metal or other mass capable of returning radio waves which consists in propagating radio waves, intercepting and translating reflex radio waves, and then balancing
25 out the said reflex radio waves or waves resulting therefrom.

30 2. The method of determining the location of a metal or other mass capable of returning radio waves which consists in propagating radio waves, intercepting and translating reflex radio waves, determining the general line of direction between a given position and the said mass by balancing out reflex radio waves or waves resulting therefrom,
35 then following the said line of direction.

40 3. The method of decreasing undesirable reception of radio waves in an antenna having a loop circuit, which consists in substantially balancing the said circuit against the said reception, and shielding the said circuit by a radio-reflecting member.

45 4. The herein described method consisting of moving a radio wave propagating device in a determined direction, propagating radio waves therefrom at intervals, intercepting and translating reflex radio waves and increasing the manifestations of said waves by means of additional currents until said interception and translation ceases or reaches
50 the minimum obtainable for that location, changing the direction of movement of the radio propagating device and again intercepting and translating reflex radio waves until said interception or translation ceases or reaches a minimum for that location.

55 5. The herein described method consisting of electrically balancing a radio wave propagating and receiving device in a location where the presence of a radio wave reflector is suspected, moving said device along a determined path in respect to said suspected reflector, propagating radio waves at intervals, intercepting and translating radio waves reflecting from said suspected reflector and increasing the manifestations of said
60 waves by means of additional currents until said interception and translation stops due to balancing action or reaches a minimum for that location, and then moving said device in a plurality of directions until said interception and translation again stops due to balancing action or reaches a minimum for that location thereby indicating the approximate location of the reflector.

65 6. In the operation of a looped antenna radio receiving system, the method of reducing reception of radio waves coming from a given source which consists in transposing the connection with each other of two looped antennæ located at equal distances from the source so that the induced currents are thrown into opposition with each other, and reducing reception of waves coming from a direction at right angles to the direction of the first waves by simultaneously rotating
70 the looped antennæ as a unit about the source of the first waves as a center.

75 7. The method of determining the location of a metal or other mass capable of returning radio waves, which consists in propagating radio waves, substantially balancing two wave-receiving devices at opposite sides of the source of the propagated waves, reducing direct reception from this source by opposing the currents directly induced in the wave-receiving devices, and rotating the wave-receiving devices as a unit about the source as a center to determine the position of minimum reception of waves returned from the mass.

80 8. In the operation of a looped antenna radio receiving system, the method of reducing the manifestations of radio waves received from a known source which consists in opposing the energies developed by the currents induced in each of two looped antennæ located at substantially equal distances from this source, and reducing the manifestations of waves received from a direction at an angle to the direction of the first waves by rotating the looped antennæ as a unit about the source of the first waves as a center.

85 9. The herein described method of locating masses capable of returning wireless waves consisting in propagating wireless waves from a source positioned in a location where the presence of the mass is suspected, and electrically balancing a wireless wave receiving device with respect to direct waves from the source, intercepting and translating reflex
90 wireless waves returned from said mass, until said interception and translation stops or reaches a minimum for that spot due to balancing action, and then successively moving said receiving device in a plurality of directions and repeating the balancing operations in each successive position until said interception and translation again stops or reaches a minimum for that spot.

95 10. The herein described method of locat- 130

ing masses capable of returning wireless waves consisting in propagating wireless waves from a source positioned in a location where the presence of the mass is suspected, and electrically balancing a wireless wave receiving device with respect to direct waves from the source, increasing the manifestations of received waves by means of additional current, intercepting and translating reflex wireless waves returned from said mass, until said interception and translation stops or reaches a minimum for that particular location due to balancing action, moving the receiving device to a new position in the approximate direction of the mass as thus determined, and repeating the balancing operations in the new position.

11. The herein described method of locating masses capable of returning wireless waves consisting in propagating wireless waves from a source positioned in a location where the presence of the mass is suspected, and electrically balancing a wireless wave receiving device with respect to direct waves from the source, increasing the manifestations of received waves by means of additional current, intercepting and translating reflex wireless waves returned from said mass, balancing the receiving device with respect to these intercepted waves to determine the approximate direction from which the reflex waves are received, moving the receiving device in this determined direction to a new position, and repeating the balancing operations in the new position.

12. The herein described method of locating masses capable of returning wireless waves consisting in moving a wireless wave receiving circuit having balancing properties in the presence of an operating wireless wave propagating circuit, increasing the manifestations of received waves by means of additional current, balancing out direct propagated waves or waves resulting therefrom, and receiving and translating wireless waves or manifestations thereof sent out from the mass as a result of the propagated waves.

13. In methods of finding masses by means of wireless waves, the steps of intercepting and balancing out interfering waves or manifestations thereof, and then intercepting and balancing out waves or manifestations thereof coming from the mass, so as to determine the approximate direction of the mass.

14. In methods of finding masses by means of wireless waves propagated from a known source, the steps of intercepting wireless waves and successively suppressing by balancing action the manifestations of waves from the known source, and then of reflex waves returned from the mass.

15. In methods of finding masses by means of wireless waves, operating a wireless wave propagating circuit, operating a wireless wave receiving circuit that is exposed to the

propagated waves or waves returned from a known mass under conditions in which these waves are eliminated or their manifestations suppressed, increasing the manifestations of received waves by means of additional current, then intercepting and translating reflex waves from an unknown mass and balancing the receiving circuit in partially suppress manifestations of these latter waves.

16. In methods of finding masses by means of wireless waves, operating a wireless wave propagating circuit, operating a wireless wave receiving circuit that is exposed to the propagated waves or waves returned from a known mass, positioning said receiving circuit so that these waves are eliminated or their manifestations suppressed, and then making observations by means of said receiving circuit to determine if reflex waves from an unknown mass are being received.

17. In methods of finding masses by means of wireless waves, operating a wireless wave propagating circuit, operating a wireless wave receiving circuit that is exposed to the propagated waves or waves returned from a known mass, positioning said receiving circuit so that these waves are eliminated or their manifestations suppressed, making observations by means of said receiving circuit to determine if reflex waves from an unknown mass are being received, and determining by balancing action the approximate direction from which these latter waves are received.

18. In methods of finding masses by means of wireless waves, operating a wireless wave propagating circuit, intercepting and translating reflex waves returned from the mass and received in a circuit having balancing characteristics, increasing the manifestations of received waves by means of additional current, and moving the receiving portion of this latter circuit so that the waves are intercepted at an angle differing from the original angle of reception, and noting any changes in intensity of reception resulting from this change in angle.

19. In methods of finding masses by means of wireless waves, operating a wireless wave propagating circuit, balancing a receiving circuit so that there are substantially no manifestations therein of direct waves from the propagating circuit, and then manipulating the receiving circuit to alter the manifestations therein of reflex waves and thus determine the direction of the source of these reflex waves.

20. In methods of finding a mass by means of wireless waves, operating a wireless wave propagating circuit, operating a wireless wave receiving device that increases manifestations of received waves by means of additional current and is exposed to waves propagated from the said circuit or radiated from an object whose location is known, said receiving device being in a position in which, if no

said mass is present, manifestation of said waves is at a minimum for that particular spot, there observing reception above the said minimum, and moving or rotating the said receiving device until manifestation of waves is at a minimum for that particular spot, thereby finding the said mass.

21. In methods of finding masses, intercepting interfering waves, increasing the manifestations of received waves by means of additional current, balancing out the said waves or waves resulting therefrom and then in the same circuit intercepting and translating waves coming from the mass being searched for, then suppressing their manifestation by a balancing method whereby the line of direction of wave travel is indicated, thus indicating the general direction of the said mass.

22. The method consisting in propagating waves, balancing out these waves or waves resulting therefrom, so that they are not manifest or are at least below the maximum for that spot, in a receiving apparatus capable of increasing the manifestations of these waves, and then in the same receiving apparatus receiving and translating reflex waves.

23. In searching methods, operating an electric circuit, intercepting two sets of waves having their primary power source in the said circuit, suppressing manifestation of one of the said sets of waves by a balancing method, translating, and manifesting the other said set of waves or waves resulting therefrom, thereby indicating the presence of an object.

24. In methods of locating a mass, operating a wave-propagating device whose location is known, thereby causing the said mass to radiate waves which commingle with waves from the said propagating device, intercepting the thus commingled waves, translating and manifesting them or waves resulting therefrom, maneuvering or rotating the intercepting device until, due to direction-finding action, whereby the general direction of wave travel is indicated, manifestation of waves reaches a minimum for that particular spot, thereby finding an indicated general line of wave travel under conditions caused by or as may be changed from the normal by the presence of the said mass, thereby indicating the general direction of the latter.

25. In a method of finding an object by means of waves, the steps of intercepting and balancing out interfering waves or manifestations thereof, and then intercepting waves coming from, or reaction waves caused by the presence of, the said object, translating them and utilizing additional current to increase the manifestations of these waves or waves resulting therefrom, thereby locating the said object.

26. In a finding method, operating an electric circuit intercepting certain waves therefrom, balancing out these waves or waves re-

sulting therefrom, so that they are not manifest, or are at least below the minimum for that spot, intercepting reaction waves coming from or caused by the presence of, an object, translating them, and by utilizing additional current manifesting said waves, or waves resulting therefrom, thereby indicating the presence of an object.

27. In methods of searching for masses by means of wireless waves, operating a wireless wave propagating circuit, operating a wireless wave receiving circuit capable of increasing the manifestations of received waves by means of additional current, and balancing said receiving circuit in positions in which direct propagated wave reception from a known source is eliminated or their manifestations suppressed, and then making observations by means of said receiving circuit to determine if waves from an unknown source are being received.

28. In methods of searching for masses by means of wireless waves, operating a wave-propagating circuit whose location is known, operating a wave receiving circuit capable of increasing manifestations of received waves by means of additional current and making observations by means of said receiving circuit to determine if waves from a mass whose location it is desired to determine are being received, said waves being caused automatically by the said operation of the propagating circuit, and if so, determining by balancing or radio direction finding methods, the approximate direction from which the said waves from a mass are being received, thereby locating the mass.

FRANK SPENCER CHAPMAN.

70

75

80

85

90

95

100

105

110

115

120

125

130

The page is framed by a decorative border. It features a central rectangular area defined by multiple parallel lines. The corners are filled with large, solid black triangles pointing inward. The top and bottom horizontal lines of the border are composed of several parallel lines, while the vertical lines are single. The text is centered within the white space of the border.

SECTION

5

VRIL
AND
SUBTERRANEAN
ELECTRICITY

The invention patented under the name of "Underground Wireless" or "Buried Antenna" was, what may be called an inversion of the usual antenna towers, namely, instead of an ordinary "aerial," the new antenna was extended into the earth by boring a hole deep in the ground, one at the sending and the other at the receiving end. Father Murgas' patent was granted on the basis of his workable model in the form of two 50 foot holes in the ground separated by about one hundred feet. Signals were really transmitted by this method but only with great difficulty, and as far as Murgas was concerned, it was but an idea which he promptly abandoned because he considered it unfeasible due to metallic absorption of electrical waves when projected into the earth. Newspapers and scientific journals of the world however, "played up" the idea in broad sensation as an item of human interest without consideration for Father Murgas' feelings.

The largest and most fantastic account of the experiment to appear in newspapers was that published by the "Chicago Sunday Record-Herald" for March 4, 1906. In the manner of a "special feature," it appeared as follows:

AN UNDERGROUND WIRELESS
(By Special Correspondent)

"In a few months, residents of New York City may be able to drop a message in a deep hole and have it arrive in London a few seconds later. They may receive a response by the same method just as quickly. Briefly, the underground wireless system has been invented by Father Joseph Murgas, Pastor of the Slovak Catholic Church of Wilkes-Barre who is a trained electrical expert, and it is considered that the underground wireless will be the cheapest and most productive system of telegraphy in existence.

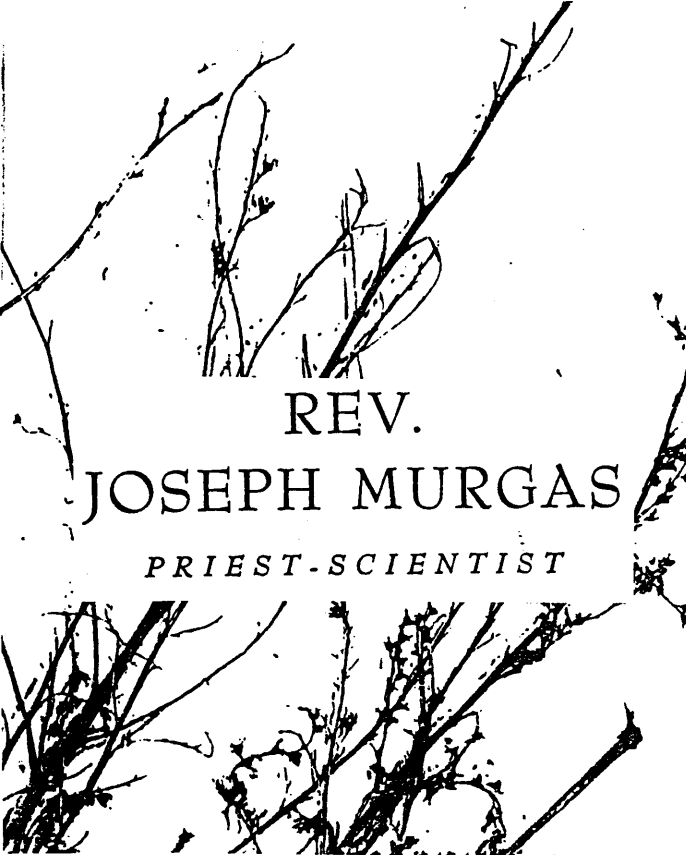

REV.
JOSEPH MURGAS
PRIEST-SCIENTIST

The Universal Aether Telegraph Company, backers of Father Murgas' work, promised to start work immediately by drilling a hole two miles deep in New York and London simultaneously. The holes will be concreted to prevent moisture effecting the copper wires which, of necessity, will be a very heavy type. The wires will connect the discharging and receiving apparatus at the bottom of the hole with a sending and receiving station on the surface.

An official of the company said that a hole 5,000 feet deep was recently drilled in Germany by a company prospecting for gold, and no difficulty was encountered. So confident is the Universal Aether Telegraph Company of the underground success that all other developments it has sponsored with Aerial telegraphy has been suspended . . .

The story, given here in condensed form, occupies two full columns of the newspaper without troubling to seek Murgas' confirmation or denial, and his patent papers for the invention in question do not claim what the news dispatch tended to indicate. The entire matter was no doubt exaggerated by members of the Syndicate for reasons of their own.

The seventh invention by Father Murgas filed for patent on March 17, 1906 and granted April 2, 1907 under No. 848,676 was known as "Electric Transformer," and as the name implies, was used in the adjustment of wireless means and improving the general function of the apparatus over that of any other systems.

The eighth patent filed May 17, 1907 and granted March 23, 1909 under No. 915,993 was simply called "Wireless Telegraphy" in as much that it represented an improvement on a previous patent No. 860,051 and was a means by which



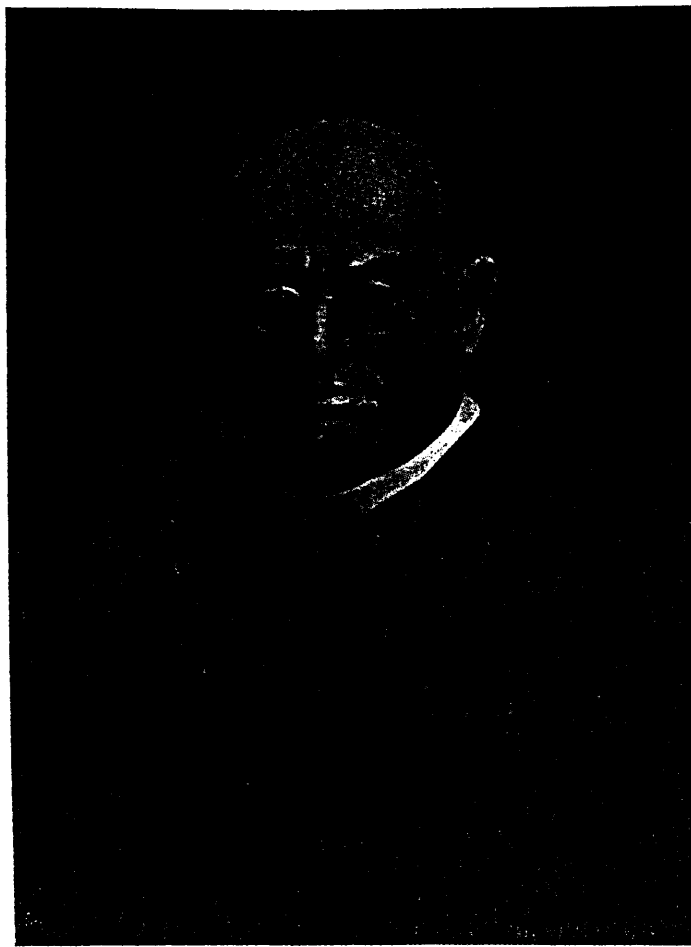

Rev. Jos. Murgas.

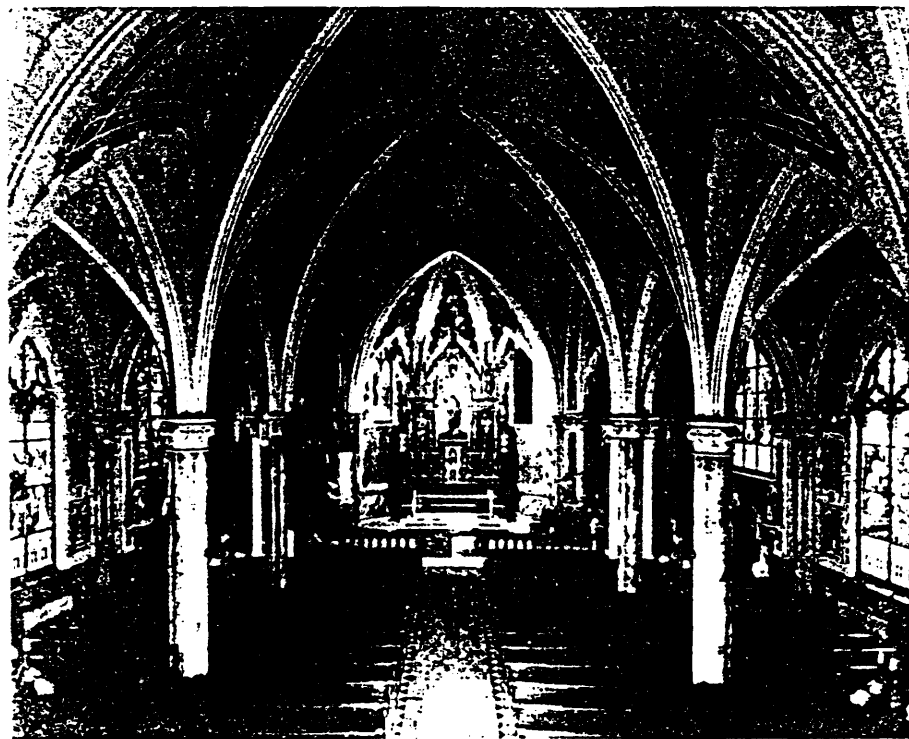

Interior Of The Present Sacred Heart Catholic Slovak Church Erected By Father Murgas.
His Painting Of The Sacred Heart of Jesus Can Be Seen Over The Main Altar.

A NEW SYSTEM OF WIRELESS TELEGRAPHY.

BY THE ENGLISH CORRESPONDENT OF THE SCIENTIFIC AMERICAN.

An interesting new system of telegraphing without wires has been invented by Mr. Axel Orling, a young Swedish electrician, and Mr. J. Tarbotton Armstrong, a well-known engineer of London, which is dissimilar from either the Marconi, Tesla, or other systems now in use. The invention was patented long before that of Marconi, but the inventors refrain from bringing it before the public until it had been developed and brought to a satisfactory state of perfection to render it available for commercial exigencies.

The advantages claimed for the Armori instrument are its simplicity, portability, the low cost of installation, and facility of manipulation. The Marconi and other systems at present practised, broadly speaking, consist of discharging induced high potential currents from a transmitter into the atmosphere, finally arresting them at their destination by means of a sensitive receiver. In the Armori system the earth is utilized as the conductor, and the currents discharged are of very low potential. The efficiency of the conductivity of the earth may be adequately realized from the fact that in order to transmit a message twenty miles, a current with a pressure of only eight volts is utilized, while even a pressure of four volts has been found sufficient to travel the same distance with complete satisfaction.

In the Armori invention induction coils, coherers, high masts and various other impediments incidental to the prevalent systems of telegraphing without wires are entirely dispensed with. The Armori apparatus is so small and compact that it can be compressed within the compass of a small box measuring seven inches in length by four inches in width, and eight inches in depth, and weighs from five to six pounds.

These interesting results have been achieved by the invention of a new receiver and transmitter, the former of which supplants the coherer. Hitherto the telephone receiver has been considered the most susceptible to electric currents, but this receiver has proven far more highly sensitive. It is described as the electro-capillary relay, and is an entirely new method of receiving electric currents. Through the courtesy of the inventor we are enabled to publish a sectional diagram of the device, and to describe its fundamental principles of working.

It is based upon the capillary attraction of mercury due to the electric currents. A is a small glass tube with one leg terminating in a finely-drawn point, while each is open at the end. At the top of the head of the tube is a small neck, *a*, fitted with a stopper, and to which the positive wire is attached. This instrument, which is only about four inches in total height, works on the principle of a siphon. One leg is inserted in the cell, B, which is filled with mercury, while the other point terminates in another cell, C, filled with a solution of acid and water. Upon the outer edge of this cell, C,

within the tube, with the result that a certain quantity of the mercury, varying according to the intensity of the current, exudes from the tube in cell, C, and drops on to the end of the balance. This immediately depresses this end of the beam and causes the opposite end to rise until it touches the contact point, F, and the current is conducted along the wire, G, to its requisite destination. As the balance, E, falls by the weight of the mercury, the latter is deposited upon the floor of the cell.

The balance of the beam, E, upon the agate pivot, D, is so delicate that the smallest quantity of mercury falling from the tube sets it in motion; and as the capillary attraction of the mercury within the tube is set up by even the faintest current of electricity, an adequate idea of the sensitiveness and delicacy of the device may be gathered. Electric currents which the most sensitive galvanometers fail to record, or

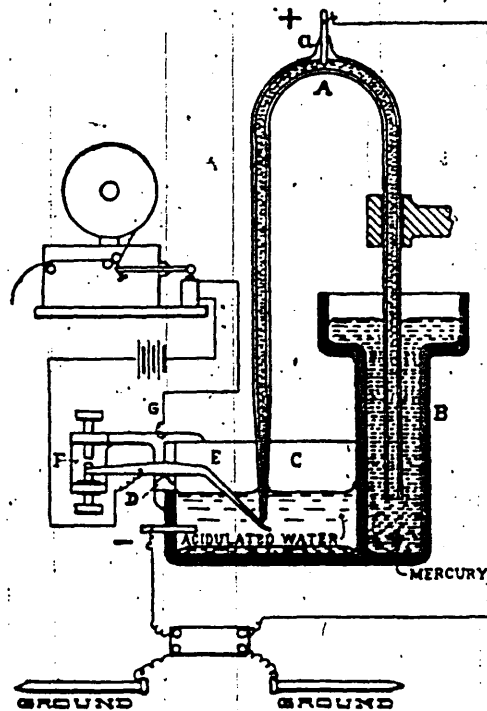

THE ARMORI SYSTEM OF WIRELESS TELEGRAPHY.

which will not affect the receiver of the telephone, will actuate this receiver, so that there is no possibility of a current entering the apparatus without moving the balance, E. For instance, if a cent piece is wetted, a dime placed upon it, and a wire from the coins is conveyed to the point, *a*, the faint and almost imperceptible current that is thus generated will be recorded. Another prominent feature of the apparatus also is that no self-induction is set up, which is the case with the existing type of relay. It may be contended that the embodiment of such a delicate mechanism within a portable box, which might be subjected to rough handling, would render it liable to be deranged, especially in field work, but the device is carefully and securely packed to obviate any such mishap.

The complete apparatus comprises this receiver and a small battery of eight volts packed in a case, which is provided upon the outside with two contact screws. Two pointed iron stakes are driven into the ground to a depth of approximately eighteen inches, and about twelve feet apart. To each of these a wire is attached connecting the negative and positive poles respectively of the instrument. A small key similar to that usually employed for dispatching Morse code signals is

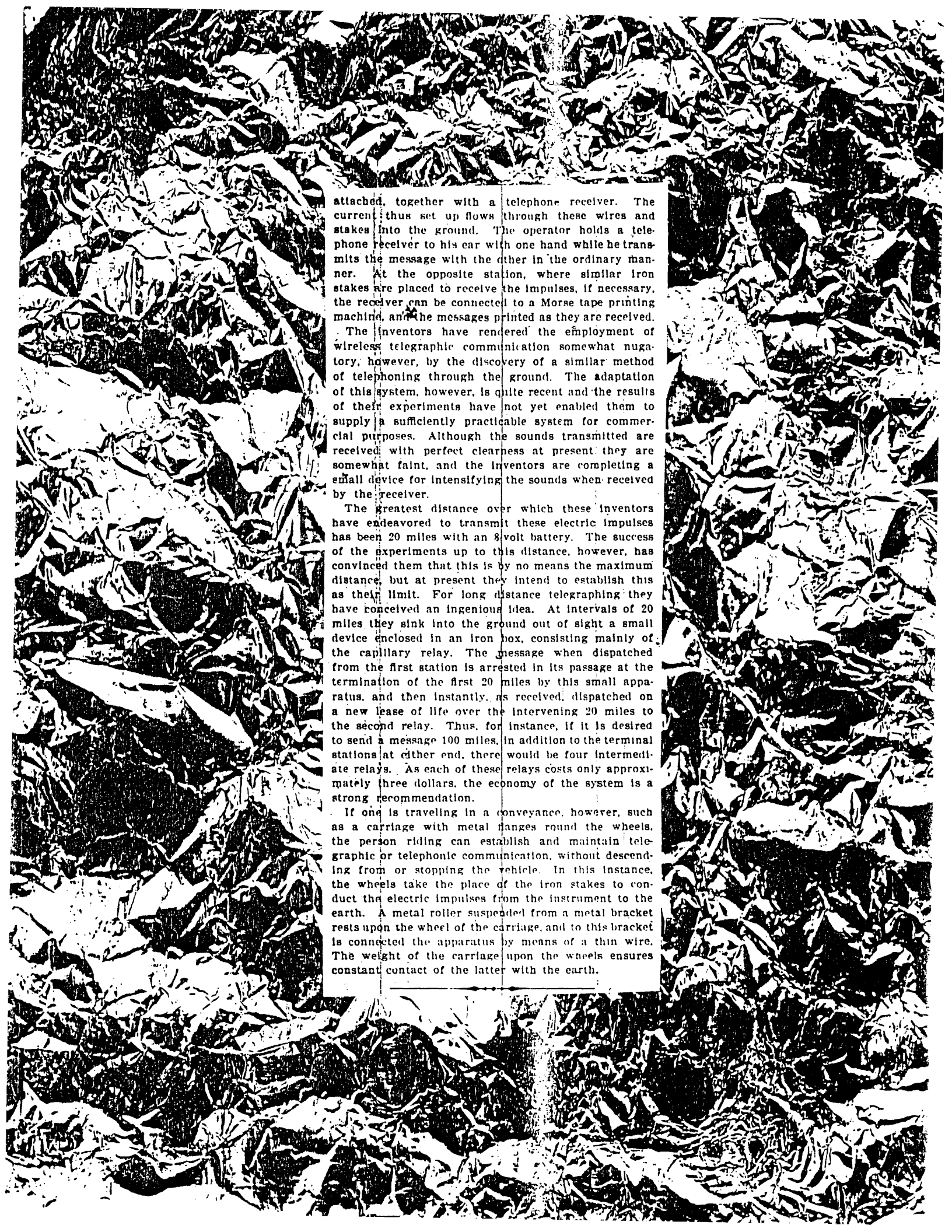

attached, together with a telephone receiver. The current thus set up flows through these wires and stakes into the ground. The operator holds a telephone receiver to his ear with one hand while he transmits the message with the other in the ordinary manner. At the opposite station, where similar iron stakes are placed to receive the impulses, if necessary, the receiver can be connected to a Morse tape printing machine, and the messages printed as they are received.

The inventors have rendered the employment of wireless telegraphic communication somewhat nugatory, however, by the discovery of a similar method of telephoning through the ground. The adaptation of this system, however, is quite recent and the results of their experiments have not yet enabled them to supply a sufficiently practicable system for commercial purposes. Although the sounds transmitted are received with perfect clearness at present they are somewhat faint, and the inventors are completing a small device for intensifying the sounds when received by the receiver.

The greatest distance over which these inventors have endeavored to transmit these electric impulses has been 20 miles with an 8-volt battery. The success of the experiments up to this distance, however, has convinced them that this is by no means the maximum distance, but at present they intend to establish this as their limit. For long distance telegraphing they have conceived an ingenious idea. At intervals of 20 miles they sink into the ground out of sight a small device enclosed in an iron box, consisting mainly of the capillary relay. The message when dispatched from the first station is arrested in its passage at the termination of the first 20 miles by this small apparatus, and then instantly, as received, dispatched on a new lease of life over the intervening 20 miles to the second relay. Thus, for instance, if it is desired to send a message 100 miles, in addition to the terminal stations at either end, there would be four intermediate relays. As each of these relays costs only approximately three dollars, the economy of the system is a strong recommendation.

If one is traveling in a conveyance, however, such as a carriage with metal fanges round the wheels, the person riding can establish and maintain telegraphic or telephonic communication, without descending from or stopping the vehicle. In this instance, the wheels take the place of the iron stakes to conduct the electric impulses from the instrument to the earth. A metal roller suspended from a metal bracket rests upon the wheel of the carriage, and to this bracket is connected the apparatus by means of a thin wire. The weight of the carriage upon the wheels ensures constant contact of the latter with the earth.

In Fig. 5 is shown an instrument devised by the writer, in which a coreless induction coil of peculiar construction is used in connection with the telephone for indicating the presence of metals. The induction coil consists of a primary coil, preferably of rectangular form, made of coarse wire, No. 18, and connected with a rapid automatic circuit breaker and battery. The secondary coil is made of fine wire, No. 36, and is arranged exactly at right angles to the coarse wire coil. A telephone is connected with the secondary coil. If the primary circuit is continuously and rapidly interrupted while the coil is not in the vicinity of any metal or magnetic material, no sound will be heard in the telephone, as all the inductive influences are equal and opposite; but when the coil is held in proximity to a body of metal or magnetic ore, this equilibrium is disturbed and the sound is heard in the telephone.

The distance through which this instrument is operative depends upon the diameters of the coils and the strength of the current used in the primary coil. The larger the coil and the larger the current, the greater will be the penetration of the inductive effect. As the induction is effective for only a few inches in an ordinary coil of 6 or 8 inches in length, the instrument is

useful for minerals lying near the surface. It may be used to advantage on the sea bottom, along cliffs, in wells and borings, and upon ground abounding in metals lying near the surface, by simply causing it to pass over or near such surfaces. When it is to be used under water, it must of course be inclosed in a waterproof casing of non-metallic material.

This instrument, which is an induction coil pure and simple, should not be confounded with the induction balance described below.



Fig. 5.—ELECTRICAL ORE FINDER.

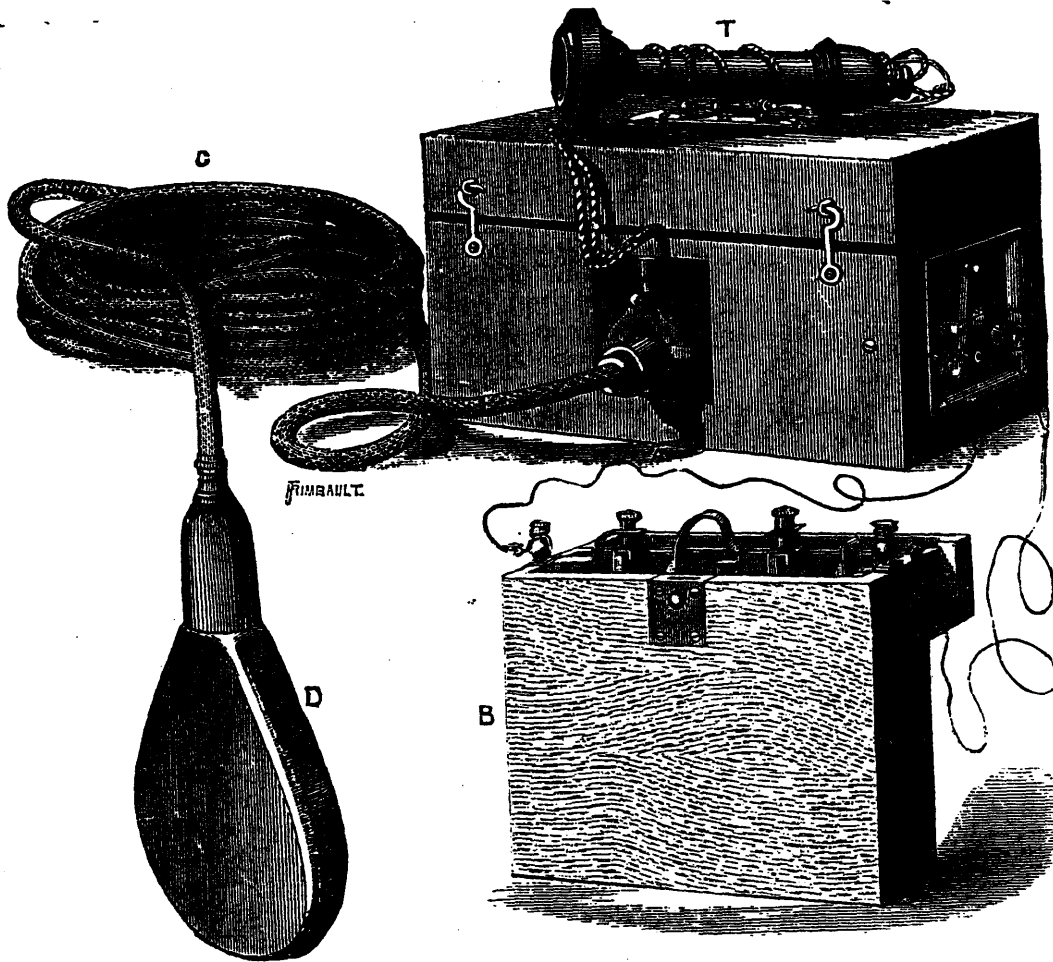

Fig. 7.—INSTRUMENT FOR DETECTING THE PRESENCE OF METALS UNDER WATER.

Fig. 7, where A is a portable case containing the adjustable coils, P S, and the interrupter, I; B is a voltaic battery of two cells, which may be replaced by a small magneto-electric machine giving alternating currents; T is the telephone in the secondary circuit; C is an insulated cable conveying the wires connecting up the two pairs of coils; and D is the detecting or exploring case containing the two secondary coils, S' P'. The coils, P S, inside the box, A, are separated by a layer of soft India rubber, and an ivory screw passes through both coils and the rubber washer between. An ebonite head to the screw is adjusted by hand so as to press the coils together or let them further apart by regulating the pressure between them and the India rubber. The simple device adjusts the balance of induction and reduces the telephone to silence.

The interrupter is a special device which consists of a small iron reed or tongue kept in vibration by a small double-poled electro-magnet, thereby interrupting the current a certain number of times per second, so as to give out a definite note which is easily recognizable in the telephone.

A switch, E, at the box turns the current from the battery on and off the interrupter at a moment's notice. The telephone is the ordinary speaking receiver of Bell.

B is a voltaic battery cells, which may be replaced by a small magneto-electric machine giving alternating currents; T is the telephone in the secondary circuit; C is an insulated cable conveying the wires connecting up the two pairs of coils; and D is the detecting or exploring case containing the two secondary coils, S' P'. The coils inside the box, A, are separated by a layer of India rubber, and an ivory screw passes through both coils and the rubber washer between. An ebonite head to the screw is adjusted by hand so as to press the coils together or let them further apart by regulating the pressure between them and the India rubber. The simple device adjusts the balance of induction and reduces the telephone to silence.

The interrupter is a special device which consists of a small iron reed or tongue kept in vibration by a small double-poled electro-magnet, thereby interrupting the current a certain number of times per second, so as to give out a definite note which is easily recognizable in the telephone.

A switch, E, at the box turns the current from the battery on and off the interrupter at a moment's notice. The telephone is the ordinary speaking receiver of Bell.

The cable, C, is insulated with India rubber having its pores filled up with ozokerit or black earth wax forced in under pressure and when in a hot fluid state. It is further protected with an outer braided sheathing, and is fitted to the box, A, by an ingenious socket, which in an instant establishes connection between the corresponding primaries and secondaries, and locks them together. The detecting case, D, is made of wood soaked with paraffin wax. It is watertight, and contains two exploring coils.

The induction balance invented by Professor D. E. Hughes has had a number of useful applications, one of which is the electric submarine detector of Captain McEvoy. Professor Hughes demonstrated the extraordinary sensitiveness of the apparatus to the presence of small pieces of metal when brought near to one or other pair of coils.

The arrangement of the balance will be understood from Fig. 6, where P S and P' S' are the four coils of the balance, arranged in pairs separated from each other and connected by insulated wires. The coils, P and P', are joined together through a battery, B, and a key or interrupter, I, thus constituting the "primary" circuit of the balance. The coils, S S', are connected through a telephone, T, and constitute the "secondary" circuit of the balance. The interrupter, I, may be either manipulated by hand or automatically, so as to give a continuous action. Whenever the primary circuit is closed by its means, a current traverses the primary coils, P P', and induces a corresponding current in the secondary coils, S S'. This current is of course audible in the telephone, T, but by reversing one of the secondary coils, say S', the current induced by the primary coil, P', in the coil, S', is made to oppose the current induced by the other primary coil, P, in the other secondary coil, S, so that it is possible to cause these two induced currents to annul one another and produce silence in the telephone.

This is done by making the two primary coils and also the two secondary coils alike in all respects, and placing the secondary, S, at the same distance from P that S' is from P'. The final adjustment to produce silence in the telephone can be made by altering the distance between a secondary coil and its primary, say the distance of S from P, or it can be made by means of a small piece of metal adjusted near one pair of coils, as was originally shown by Professor Hughes.

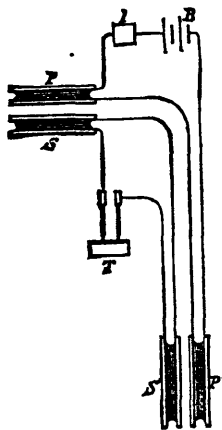

Fig. 6.—INDUCTION BALANCE.

A telephone is connected with the secondary coil. If the primary circuit is continuously and rapidly interrupted while the coil is not in the vicinity of any metal or magnetic material, no sound will be heard in the telephone, as all the inductive influences are equal and opposite; but when the coil is held in proximity to a body of metal or magnet

the inductive disturbance which its presence creates will upset the existing balance, and the telephone, before silent or nearly so, will give out distinctly audible sounds, owing to the predominance of the induced currents in the secondary, S', over those in the secondary, S.

The idea of applying the balance to the detection of metals has been worked out by Captain McEvoy, who has reduced it to a thoroughly practical form.

Ground Telegraphy in War

By H. GERNSBACK

WHEN trench warfare first became an accepted fact it became of vital importance that the front trenches should be in permanent communication at all times with the supporting trenches, as well as the general command behind the lines. At first

it becomes more or less an easy matter to shell these, and for that reason during the past year or so, the French have found it advantageous to do away entirely with metallic lines, running from the front to the supporting trenches, and thence rearward.

Ground telegraphy as its name implies, means sending impulses thru the earth without the use of intervening wires. The simplest system of this kind is shown in the annexed sketch where A and B are two metallic spikes driven into the ground, these spikes being connected with a bat-

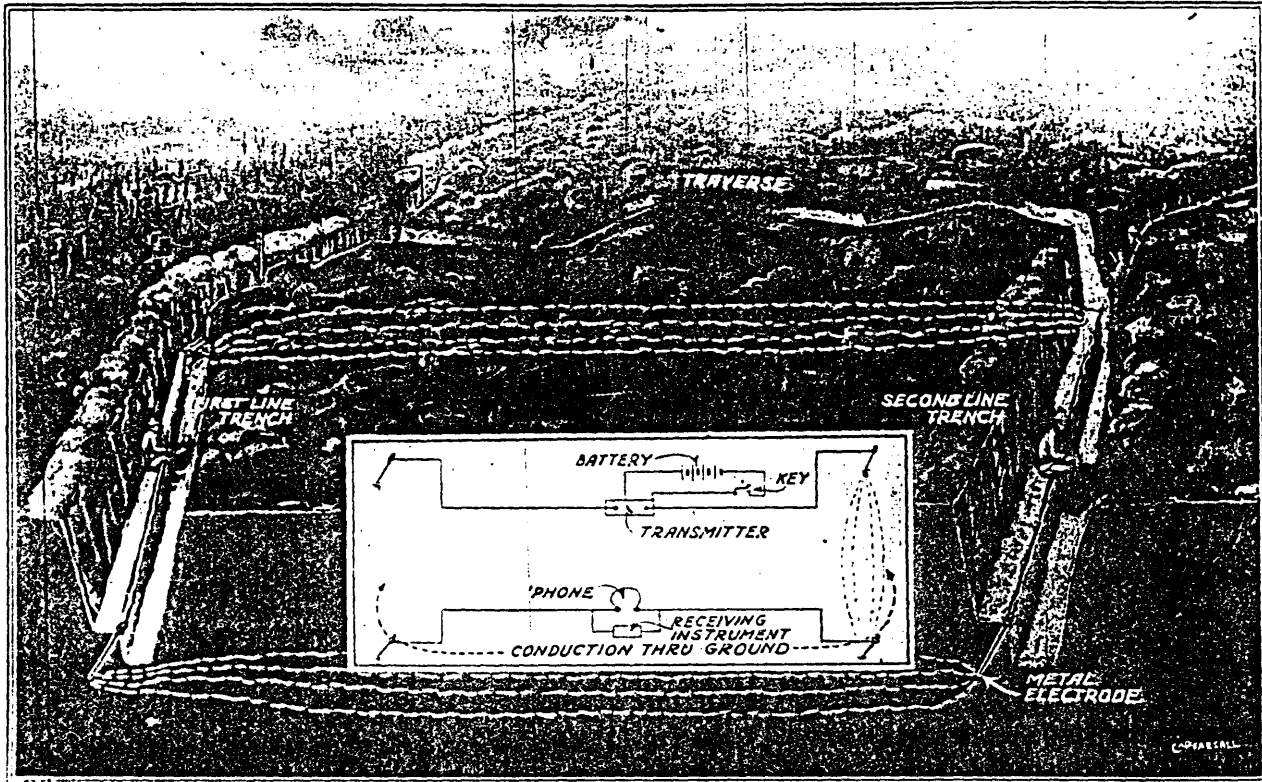

This New "Wireless" Communication Scheme Is Now Being Used in the French Front Line Trenches. This Is Nothing More Nor Less Than "Ground Telegraphy" in a New Dress. By Using Specially Tuned Transmitters and Screens, Interference By the Enemy Is Practically Eliminated.

ter, but regular telegraph lines were either at the bottom of the communication trenches, or otherwise they were encased by some form of insulator. In lines were not in all cases permanent, covered the purpose, as none of the lines were intended to stay up forever but to stand around more or less due to changing war conditions.

Moreover, under fire make it impossible to maintain unbroken cable or conductors, and it goes without saying that such lines are severed and burning frequently by shell bursts, and a surprise raid-party. After the enemy is driven away from him, the trench is not much left but a few scattered lines, and these are not of much use. The French, however, have found a way to overcome this difficulty by using a system of ground telegraphy. This system is based on the use of two metallic spikes driven into the ground, one in the front trench and one in the supporting trench. It is a simple system, but it is a very effective one, and it is the only one that is not subject to being cut by the enemy's shells.

It has been the writer's good fortune recently to interview a French "T. S. F." "Telegraphie Sans Fil" officer (Wireless Telegraph Corps) and the officer in question has been kind enough to give us interesting particulars as to the new ground telegraph system as is now used on practically all the fronts throughout Europe. This is nothing more or less than the ground conductive system, and it is not by

terry and a buzzer. If we now drive two further spikes C and D, say fifty or one hundred yards (or more) away from the first spikes, paralleling the latter, and if we connect spikes C and D by means of a telephone receiver T, then when we operate the buzzer by means of a telegraph key the sounds will be clearly received in the far off telephone T.

The explanation is that a certain amount of current is received by the spikes C and D, and the sound while weak is readily heard in the telephone receiver. Of course, this is the crudest system, but it works surprisingly well over equally surprising distances. Not only is it possible to telegraph over such a system, but by substituting a microphone for the buzzer, and provided we have enough current, articulate speech can be transmitted over such a ground system without the use of intervening wires. It is of course not as efficient as the "ether wave" radio-telephone system, but has certain military applications.



This Diagram Gives a Clear Idea of "Ground Telegraphy." Current Impulses Sent Out Thru Electrodes A and B Will Be Heard in Telephone Connected to Spikes C and D, Due to Current Leakage.

A system of this kind works always at its best when the spikes A and B are separated as far as it is possible. The further the spikes are separated, the further

(Continued on page 346)



GROUND TELEGRAPHY IN WAR.

(Continued from page 592)

the system will operate. The writer in 1903 by a system of this type was able to telephone over a distance of three miles, using an arrangement of buried plates whereby a zinc plate was buried in the ground, while a copper plate was buried three or four times the depth of the zinc plate. The plates in this case having the same function as the spikes described above.*

In the French system mentioned, the transmission of the intelligence is accomplished by means of a low power high frequency buzzer of a certain periodicity, and the signals are received at the other end by specially attuned wireless telegraph receiving apparatus, making use of a detector, tuning inductances, etc.

There are several reasons for this. In the first place if a very powerful buzzer were used in the front trenches, it will be understood that while the signals would be received in the rear without much trouble, using highly sensitive wireless receiving apparatus, the enemy as well would have but little trouble in receiving the same messages thru "No Man's Land."

While such messages could be sent in code, nevertheless, as has been pointed out frequently by us, codes are of very little use in this war, for given time, the enemy will decipher any code no matter how ingeniously contrived within a few hours. For that reason, even today at all fronts, codes are changed almost with every other message. It is merely the time element that is required to get the message thru, and even if the enemy does decipher the message, it will take him a few hours. His purpose will be defeated, however, as the order will probably have been executed long before the enemy found time to decipher the message.

Just the same, the French have taken precautions to see that whatever messages they do send by means of their new ground telegraph, these shall not fall into the hands of the enemy. And they have actually accomplished this.

THE COLLINS SYSTEM OF LONG-DISTANCE WIRELESS TELEPHONY.

The longest distance wireless telephone tests yet made on this side of the Atlantic have just been completed between Newark, N. J., and Philadelphia, Pa., a distance of eighty-one miles, as wireless waves travel.

The system by which this has been accomplished is due to A. Frederick Collins, a pioneer in the wireless telephone field. The first of his series of tests took place between his laboratory in Newark, where he has a high-power sending station, and the Singer Building in New York city, about twelve miles away, on the night of July 9, when spoken words were clearly and loudly transmitted across the intervening space. The following day the distance was increased to thirty-five miles, when the receiving station was located at Mr. Collins's country home at Congers, N. Y., and then, amplifying the power of the sending station and bringing the instruments into sharp resonance, the Newark-Philadelphia tests were made the following Tuesday at midnight, from the top of the Land Title Building.

This system of wireless telephony is the culmination of work begun by the inventor in 1899, and in its modified and present form it consists of an apparatus for generating continuous oscillations and an instrument for reconverting the received oscillations into audible, articulate speech. For the overland tests the initial energy employed was a direct current at 500 volts furnished by the Newark Public Service Corporation. This was increased to 5,000 volts by a direct-connected motor-generator set, the dynamo of which was especially designed by Mr. Collins to stand high-potential strains.

The latter current was used to energize a self-regulating arc lamp having revolving electrodes instead of the usual induction coil employed in spark telegraphy. A blow-out magnet was adjusted at right angles to the oscillation arc, and one of the ends of the magnet was placed in series with the positive wire, and the other coil in circuit with the negative wire. This magnet kept the arc in the best position; besides the coils serve to choke back the oscillations from the high-tension generator. Across the 500-volt direct-current circuit, the terminals of a small transformer coil are shunted, but a condenser is interposed to check the high-voltage direct current from flowing through it. The primary of the transformer is connected in series with a source of current developing 35 volts direct current and a telephone transmitter.

From the opposite sides of the arc the oscillation circuit leads off, and is completed by a battery of glass-plate condensers on either side of the tuning induction coil. The choking effect of the induction coil

causes the potential difference of the oscillations to be greatest on either side of the coil. Hence the aerial and ground wires are placed on opposite sides of the coil at the point where resonance is a maximum. An auto-transformer in the aerial serves further to step-up the potential to 100,000 volts or more of the oscillations surging through it.



Not the least important, though a subsidiary piece of apparatus, is the resonance tube devised by Mr. Collins for the instant visual determination of the proper values of inductance and capacity of the closed circuit, as well as when this latter circuit is in tune with the aerial wire system. The device consists of an exhausted glass tube 18

inches toward the ends of the tube, but always keeping close to the oppositely-disposed wires.

The length of the glow on the wires is proportional to the current strength, and thus the tube may also be used as a measuring apparatus instead of the milliammeter usually employed. The characteristics of the oscillations can also be easily observed; for, if they are positive the light will appear almost wholly on the end of one of the wires, and if the current is reversed on the opposite end; while if the current is oscillating with equal electro-motive forces, the light will have the same degree of intensity on both wires. By means of a revolving mirror the oscillations may be segregated, and it is then easy to see whether they are periodic or continuous, and if the latter, to analyze the wave form of the spoken words.

The receptor comprises a thermo-electric detector of Mr. Collins's invention, the fuller details of which it is inadvisable to give out at the present time. It may be said, however, that the principles upon which it is based are entirely different from the numerous other detectors that have made their appearance since the original form of the Branly coherer. Roughly, the detector in question consists of two corresponding wires of different metals crossed at right angles, and forming a couple, somewhat on the order of a thermocouple, the radiation beam. Under the junction of these wires is placed a resistance wire, which is heated by the currents surging in the aerial wire system. The detector is sensitive to oscillations of 1/1000 of an ampere and is especially well adapted for the reception of articulate speech. A variable electrolytic resistance is used to modify the current, while the tuning inductance and condensers are very much the same as in other wireless systems.

The highest degree of tuning is obtained by means of a thermocouplemeter. This instrument comprises a single loop of silver wire suspended between the poles of a permanent magnet. The lower end of the loop are connected with a thermocouple, which is heated by a fine filament of high speed resistance through which

passes the oscillating current. One end of the heater is connected with the frame of the instrument, in order to avoid electrostatic stress. The heat generated by the passage of the oscillations through the resistance falls on the thermo-junction, and the resulting electromotive force applied to the ends of the silver loop causes it to turn in the magnet field. In the Newark-New York tests the aerial wire at the sending station had a length of 350 feet, and was formed of four radiating phosphor-bronze wires, making a total of 1,400 feet of wire. At the Singer Building

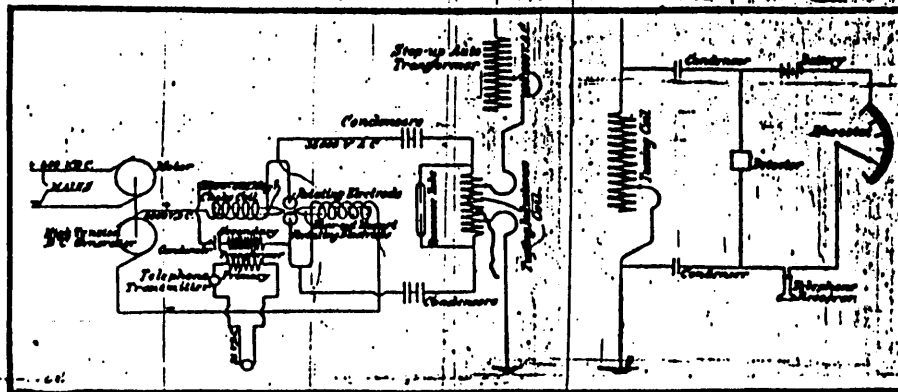

The Elements of the Collins Wireless Telephone System and Their Electrical Relation to One Another.

inches in length and 1 1/4 inches in diameter. Sealed in the ends are platinum wires 1/16 inch in diameter, and these extend longitudinally through the center of the tube until the ends almost touch each other. The outside terminals are connected in shunt with the induction coil. Now, when the first feeble oscillations begin to surge in the closed circuit, one or the other will glow, or both of the free ends of the inclosed wires will glow, depending on the oscillatory nature of the current. As the current strength of the oscillations increases the glow-light extends farther and farther

in the detector just described. One end of the heater is connected with the frame of the instrument, in order to avoid electrostatic stress. The heat generated by the passage of the oscillations through the resistance falls on the thermo-junction, and the resulting electromotive force applied to the ends of the silver loop causes it to turn in the magnet field. In the Newark-New York tests the aerial wire at the sending station had a length of 350 feet, and was formed of four radiating phosphor-bronze wires, making a total of 1,400 feet of wire. At the Singer Building

The Rogers Underground Aerial for Amateurs

SINCE the publication of the original article on the Rogers Underground Wireless System, published in the March, 1919, issue of the ELECTRICAL EXPERIMENTER, the Editors have been literally besieged by hundreds and thousands of letters from radio experimenters in all parts of the world, asking for data on the construction of Rogers underground aërials suited to the requirements of the Wireless Amateur. The original article contained a great deal of valuable data, which should be carefully read and digested by every radio man, whether he be a student or a professional. In the present article an effort has been made to answer some of the questions which have seemed to annoy the average radio "bug" considerably, — especially those residing in cities where it is difficult and frequently impossible to bury an aërial longer than a few feet. We may say right here, that for those experimenters so situated, there is a solution, or in fact, two solutions, namely—to use a spiral antenna, such as has been tried out successfully in U. S. Naval tests on the Rogers System, and which spirals may be buried in the ground a few feet, or placed in a well or other body of water; and secondly, for the experimenter who is not allowed to disfigure an apartment house or other pretentious dwelling with an ugly looking aërial, there is the newly developed, loop antenna, which can be used right in the radio room. Indoor aërials have been greatly perfected during the war, and now by means of greatly improved and highly sensitive wireless receiving instruments and amplifiers available, particularly those using audions as detectors and amplifiers, they are excellent, and satisfactory results are obtainable by means of a concentrated loop or spiral antenna, small enough to be placed in the radio laboratory.

For the present, we will listen to the sound advice given by our mutual friend, Mr. James Harris Rogers, on some of the practical outstanding features of his underground system, used in conjunction with straight-away single wire underground aërials, as well as loop aërials. Among other things, Mr. Rogers has the following to say regarding the installation of simple underground aërials:

Mr. Rogers Talks to the Amateurs.

"The first installation of my underground antenna was made in the woods about a mile from my laboratory and con-

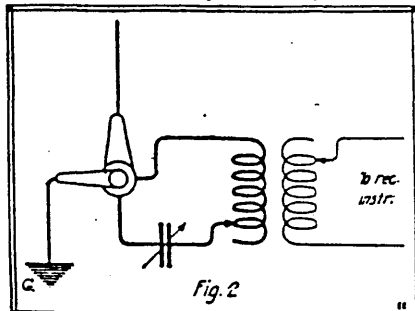

Using One Buried Aerial and Earth Gives Same "Directivity" as When Two Wires Are Used.

Specially Prepared with the Collaboration of Mr. James Harris Rogers

sisted in burying wires in the earth; the wires radiated from the station as the spokes of a wheel,—some wire bare and some insulated; their lengths varied from 200 to 1,000 feet. (See Fig. 1).

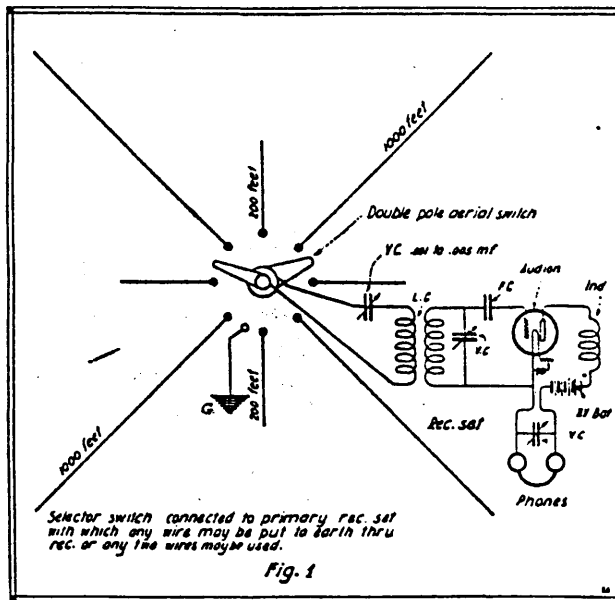

Rogers Underground Aerial System for General Requirements, Showing Bipolar Selector Switch Connected to Primary Circuit of Receiving Set. Any Aerial Wire May Be Grounded Thru the "Set," or Any Two Wires May Be Used as Desired.

"It is obvious that a number of persons can receive at the same time, one operator to each wire. There is no interference, one with another. Figure 1 shows eight (8) wires and a bipolar selector switch

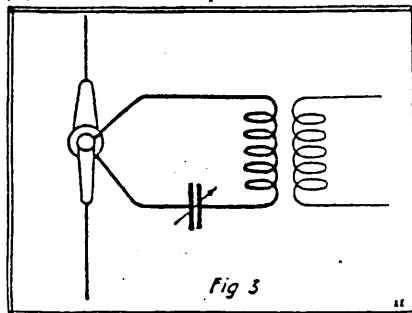

Using Two Ground Aërials for Receiving. The Aërials Should Lie in the Plane of the Station Being Received.

connected to the primary receiving circuit. With this switch any individual wire may be grounded, or any two wires may be used. Bare wires give the loudest signals but static is more pronounced. The deeper the wires are buried, the better the signals, with a corresponding reduction of static. Short wires show a remarkable degree of directivity; long ones to a less degree and in proportion to their length. (See Figs. 2 and 3).

"When using two wires at right angles

to each other, signals are heard from any direction. (Fig. 4).

"The system works best in fresh water or very wet earth. The primary circuit should have a variable condenser (.001 m.f. or higher capacity) in series. When insulated wires are covered with metal, lead, iron, etc., some remarkable results are obtained. These wires may be entirely enclosed in an iron gas pipe, for instance, (Fig. 5), or the joints may be connected by rubber hose. (Fig. 6).

"Here are some measurements taken with this last form of aerial:

Audibilities with one bulb only, on "Nauen" station, Germany:
Length When signals are weak better best

2,000 feet..	15	25	50
2,500 " ..	30	50	100
3,000 " ..	60	100	200
3,500 " ..	120	200	400
4,000 " ..	240	400	800

"Regarding the tests with loops I will state briefly that I have successfully tried different forms and sizes.

"I first had a well bailed out and lowered a loop antenna into it; the well was 50 feet deep. (See Fig. 7). The signals were as loud at the bottom as when above the earth. I next had the well filled with water and the results were the same, excepting that the note of the sending station became higher and higher as it was lowered. Upon revolving it I found the directional characteristics were the same in the water as when out. These tests were made about two years ago, and I at once realized that loops or cages could be used in the dugouts of France, or on submarines when submerged.

Regarding the dimensions of loop antennae used on submarines, these coils measure about 3 feet square in some instances. The wires are very heavily insulated and placed in a box filled with pitch, the connections are lead below and the coil can be revolved for directional observations."

Kind of Wire Used for Underground Aerials.

Most of the inquiries from Radio Experimenters and those intending to install experimental stations, and wishing to make use of the "static-proof" Rogers underground antenna, on which signals may be received even thru a thunderstorm, indicate that the greatest problem to solve seems to be the size and the kind of wire to be used, and how it shall be buried. Some very excellent results have been obtained in

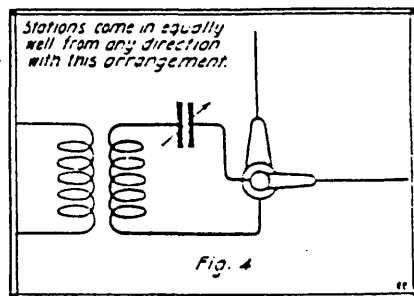

With This Arrangement the Signals Came in Equally Well from Any Direction. A Good "Stand-by" Hook-up.

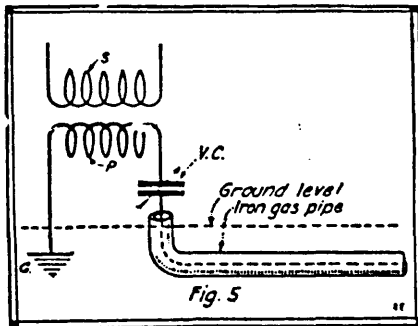

Ground Aerial Buried in a Continuous Section of Iron Pipe. Excellent Results Have Been Obtained with This Scheme.

experimental work carried on at one of the leading American universities with aerial conductors laid on the ground, and where the experimenter has the time and space to try this out, he may gain some useful and valuable knowledge by experimenting in this direction. Ordinarily the wire, of whatever kind it may be, as used when installing the Rogers underground aerial, is buried about three feet deep in the earth. For most Amateur requirements, the wire only need be about 100 to 200 feet long, and so the digging of the ditch is not such a great problem; in fact, it can be plowed open, at least part of the depth, and where rivers, brooks or ponds are available the insulated wire can be placed in them directly and allowed to rest on the bed.

Regarding the choice of wire to be used, it becomes evident that even bare copper or other wire may be utilized when desired, as Mr. Rogers has pointed out in the above contribution. The size of this wire should be about No. 12 or 14 B. & S. gage, the heavier the better.

The official U. S. Navy reports of tests on the Rogers Underground System mention that no increased efficiency is obtained by using more than one wire, and that this may be a No. 12 or 14 B. & S. gage, weather-proof or rubber-covered copper conductor. In any case, the free end of the wire should be well taped, and prefer-

ably covered with some rubber cement, so as to keep it insulated. Experiments have been tried both by Mr. Rogers at his Hyattsville, Md., laboratory, and also by the Navy Department, with underground aërials placed in terra cotta pipes, but this construction is rather expensive, and the results obtained do not justify its use.

Other forms of wire used both by Mr. Rogers and the Navy Department experts include lead-covered telephone cable, which is, of course, thoroly damp-proof, while a conductor holding considerable favor with the inventor is the heavy rubber-covered, high-tension, auto ignition cable. This is highly efficient for aerial requirements, as it is stranded and therefore of low high frequency resistance.

In any case, a little common sense and logic will give the answer to many of the simple problems arising in connection with the installation of these aërials, such as, for instance, the length of aerial to be used

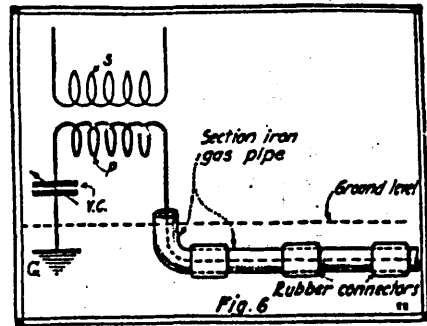

Here the Iron Pipe Jacket Surrounding the Buried Aerial is Divided up into 20-Foot Sections by Means of Rubber-Hose Connectors; a Later Development.

Spiral or Loop Aerials.

As shown in the diagram, Fig. 7, interesting results were obtained with a spiral antenna, composed of a dozen or so turns of insulated wire, such as high tension cable or No. 14 R. C. solid conductor lowered into a well, both with and without water in it.

As pointed out in the original article on the Rogers underground system in the March issue, very promising results have been obtained in transmitting with the underground antenna, and Fig. 8 shows how a small transmitting set was operated with such an aerial, coupling the exciting or spark gap circuit with the antenna oscillatory circuit by means of a two-coil oscillation transformer, L. C. In this case two metal plates, about one yard square, are placed in the earth adjacent to the well, one of which connects with the secondary, S, of the oscillation transformer, while the other plate connects with the free end of the spiral antenna.

If the spiral antenna is used, it should be mounted so as to be revolvable on its vertical axis, and it should be placed in the vertical plane as shown in Figs. 7 and 8. Excellent results have been and should be obtained in transmitting with the underground antenna, with the usual insulation incident to the form of conductor above

(Continued on page 187)

AUDIONS ON ALTERNATING CURRENT

Well, "Radio-Bugs," the very latest thing in Audion circuits is to cut out the expensive high voltage batteries, which are forever deteriorating and necessitating the purchase of new ones, or else the use of messy miniature storage batteries, and to operate your Audions, both filament and plate circuits, with ALTERNATING CURRENT. Sounds impossible, doesn't it? But it is a fact, nevertheless. Don't miss this important article, which will be worth many dollars to you, to appear in the next issue of the ELECTRICAL EXPERIMENTER. Read this special article entitled "Operate Your Audion Receiving Set on A.C." by Elliott A. White, formerly instructor in Radio at the Carnegie Institute of Technology, with diagrams and complete data on the building of the transformer, and other details. This is but one of the big feature Experimental Radio Engineering articles we have in preparation for the July number. It is the greatest revelation you ever read in Radio literature. Don't miss it, "Radio-Bugs"!

for a certain range of wave lengths. It is manifest that the longer the antenna, the longer the wave length to which it will properly respond.

Considering that an antenna is used having a length of, say, 150 to 200 feet, then practically all the shorter wave lengths up to 600 meters and more should be readily picked up on this antenna, especially with the variable condenser hooked up in series with the primary of the loose coupler, as shown in the accompanying diagrams. Naturally the wire buried in the ground has a higher electrostatic capacity than the old-style antenna wires, elevated 40 to 50 feet above the ground, and we can reduce this capacity as desired, so as to tune any certain wave lengths, by connecting another capacity in series with it: in exactly the same manner as short wave lengths are tuned in on the regular elevated aërials, by connecting a variable capacity in series with the antenna circuit, and the primary of the loose coupler.

Long wave lengths are tunable by using large condensers and loose couplers preferably.

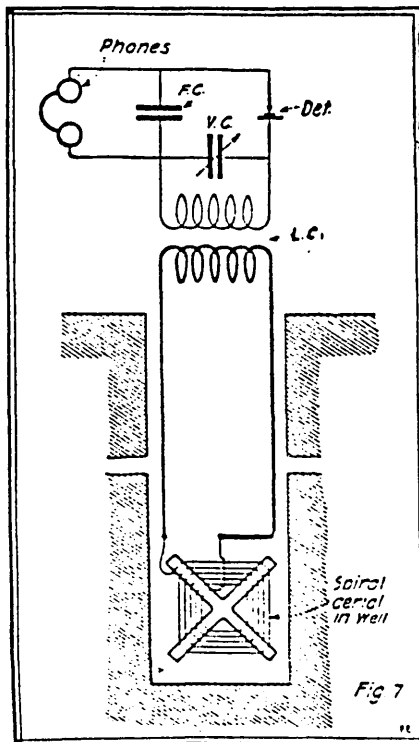

Some Very Surprising Results Were Obtained in Receiving with a Spiral Antenna Lowered into a Dry Well. Slightly Different Results Were Noticed with Water in the Well.

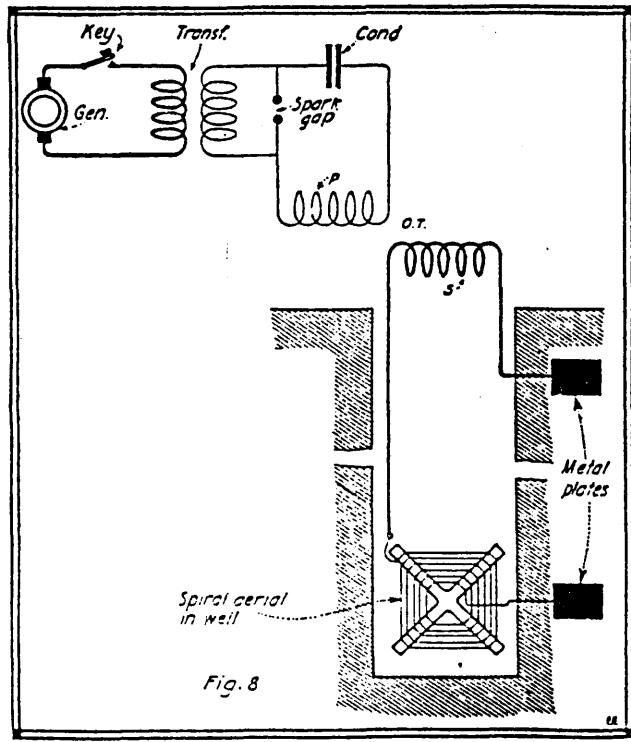

Distances up to Fifty Miles Have Been Covered Very Successfully in Transmitting with the Rogers Underground Aerial. In This "Transmitter," the Spiral Antenna is Placed Down in a Well, Metal Ground Plates Being Connected as Shown.



The Rogers' Underground Aerial for Amateurs

(Continued from page 137)

specified, where the transmitting set is one employing an audion oscillation generator. The voltage in this case will not be extremely high, and special precautions need not be taken to provide extra heavy insulation on the buried antenna. Official tests by the U. S. Navy have shown transmission by radio over 50 miles with the Rogers underground antenna. *The wire in such a case, however, should be especially well insulated to stand the higher voltage.*

Regarding loop aërials in general, it would appear that we can expect a great deal from them, as some of the really remarkable results achieved during the war would seem to point out. The number of turns and the amount of wire to be used in a spiral antenna, such as shown at Figs. 7 and 8, will vary of course for different wave lengths, etc., and here is where the Radio Amateur will have a chance to carry out some original experiments, which may net him some real knowledge, fame and money. Another form of lc antenna, so-called, and which has been tried out several years ago with such success that European stations could be copied in a laboratory located in Florida, is one composing a square form, several feet in height. This was used, as just mentioned, to receive stations using fairly long wave lengths, say from 8,000 to 12,000 meters, W. L. Here the insulating form was wound with a layer comprising several hundred turns of insulated wire, such as ordinary annunciator wire. This antenna was successfully used in some tests made by the Marconi radio engineers at a laboratory in Florida several years ago. Trans-Atlantic radio reception was effected at the radio laboratory of Union College, Schenectady, N. Y., just prior to America's entrance into the world war. This aerial comprised about two dozen turns of No. 14 or 12 bare or R.C. wire, mounted on porcelain knob insulators screwed on the inside wall of the laboratory. The turns were spaced about 3 inches apart. The inside turn was 3 feet square. Flexible leads, fitted with clips, serve to connect as many turns as desired.

Long Waves and "Strays" on Rogers Antennae

By LIEUT. COM. A. HOYT TAYLOR, U. S. N. R. F.

MANY of the properties of ground wires with respect to long wave reception have been touched upon in a previous paper which dealt mainly with short wave work (PROCEEDINGS OF THE INSTITUTE OF RADIO

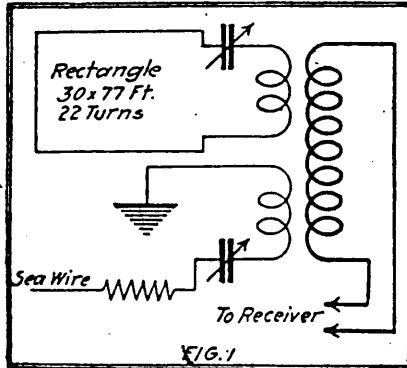

It Having Been Determined That the "Sea" Wires Had Twice as Good a Ratio for Signals and Strays as Rectangles. It Seemed Likely That One Ought to Be Able to Balance the Strays from a Rectangle, Those from the "Sea" Wires and Strays Having Some Signal Strength Left. The Differential Transformer Used in This Experiment is Here Shown, There Being Two Primary Coils, One for the Loop and One for the "Sea" Wire Circuit.

ENGINEERS, volume 7, number 4, 1919). "The purpose of this paper is to take up some of the special problems of long wave reception with ground wires, with special reference to the work done by the writer on the elimination of strays." Commander Taylor continues in the December, 1919 issue of the Institute of Radio Engineers' Proceedings.

OPTIMUM WIRE LENGTH FOR LONG WAVES.

Number 12 rubber covered wire was used for all of the earlier experiments on optimum wire length because it was found to hold its insulation for several weeks and was cheap and easy to handle. It is not recommended for permanent installations. It has already been shown that for 600 meters the optimum length for this wire was 125 feet (38.1 meters) each way, and that up to 1,125 meters this length seemed to be proportional to the wave length. It was therefore expected that a similar relation would hold for waves between 4,000 and 15,000 meters. For 12,000 meters the length was therefore expected to be 2,500 feet (763 meters). Since there was comparatively little arc work being done by stations south of Great Lakes, and since there were no arc stations north of Great Lakes, it was necessary in the work done here, to attempt optimum length experiments on stations either east or west of Great Lakes. At the laboratory on the bluff, it was not possible to lay wires in trenches for so great a distance, while at the station on the beach, it was only possible to lay a wire in one direction, using it against a ground. An attempt was made in two ways to determine whether or not optimum length existed for these long waves. First the signals from Lyons, France, on 15,000 meters were observed on a wire 3,000 feet (915 m.) long, running straight east into the lake, the outer end of the wire being sixty feet (18.3 m.) under water. This wire was gradually pulled in and observations taken. It was a laborious and difficult matter to obtain satisfactory observations in this way, but those that were taken indicated that 2,650 feet (808 m.) gave the

best signal for Lyons. The signals were too weak to get, with the amplification at that time available, any adequate measure which would indicate whether the ratio of signal to stray was better at this length than at others. About this time Doctor L. W. Austin reported that, as far as he could determine from the experiments made in the slightly brackish water of the Potomac at Anacostia, District of Columbia, there was no optimum wire length for long waves and that no proportionate increase in signal was observed after 2,000 feet (610 m.). In the Great Lakes experiments, all signals were compared with those received on a standard wire, 2,000 feet (610 m.) in length. In order to avoid the laborious process of hauling in the long wire, which occupied considerable time, the problem was attacked at Great Lakes on a different basis. Two wires, separated 50 or 60 feet (15 or 18 m.), running in the same direction were compared. They were both fixed in length, one being 2,000 feet (610 m.) and the other 1,750 feet (534 m.) long. For various wave lengths between 5,000 and 14,000 meters, the ratio of signals on the 2,000 foot (610 m.) wire to signals on the 1,750 foot (534 m.) wire was determined. These observations were insufficient in number to be at all conclusive, but the best ratio was obtained at 12,600 meters, Nauen's wave, indicating that 2,000 feet (610 m.) was not far

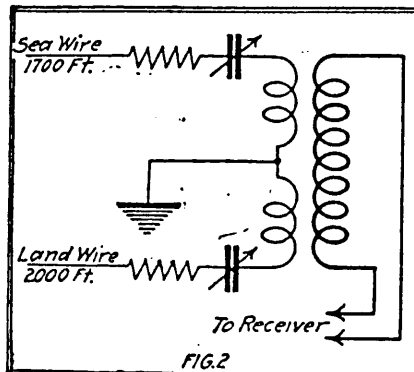

Another Attempt Made at Balancing Out the Signals and Strays Was Made, as Here Shown, by Placing a "Land" Wire Against a "Sea" Wire, but with Indifferent Results.

from the optimum length for this wave. It is, of course, possible that the relation between optimum wire length and wave length is not exactly linear, and it is deemed that the data herein reported is not entirely satisfactory. The experiments on optimum length were continued later at the U. S. Naval Radio Station, Belmar, New Jersey, which was then the principal station and control center of the trans-Atlantic system and where the writer was stationed as trans-Atlantic Communication Officer. The Belmar experiments on wires laid in the inlet (salt water) in front of the radio station, showed that up to the length of 1,500 feet (458 m.) signals from Nauen on 12,600 meters continued to increase. It was impossible to obtain a greater distance than 1,500 feet (458 m.) without deviating too far from the proper direction. During the month of January, ice formed on the inlet and a piece of "packard cable," number 11 high tension, was laid on the surface of the ice for the purpose of determining the optimum length of Nauen's short wave, 6,300 meters. The signal strength rose rather rapidly until a

thousand feet (305 m.) were used, after which it rose very slowly so that it was difficult to determine exactly where the optimum length lay. It was estimated to be 1,600 feet (488 m.). Similar experiments with a wire on the ice, using Lyons' spark wave of 5,300 meters, indicated an optimum length of 1,200 feet (366 m.) and showed also that the rise of signal strength was very gradual and that there was no practical advantage in using over 800 feet (344 m.) of wire for 5,000 meters and not over 1,000 feet (305 m.) for 6,000 meters. About this same time, January, 1918, lead-covered cable on the surface of the ground was tested at Belmar. The sheath of the cable was grounded at a number of points, special care being taken to get a good ground at the receiving end. The core of the cable contained two number 18 copper wires, which were connected to the receiving set and used against a ground connection. The behavior of lead-covered cable showed at once that the most suitable length for long waves was decidedly different from that proper for ground wires or submerged wires. For instance, while 2,000 feet (610 m.) of underground wire was found very suitable for waves of 10,000 meters and upwards, it was found that a lead-covered cable 3,000 feet (915 m.) in length showed up best on wave lengths between 5,000 and 6,000 meters. A lead-covered cable 7,000 feet (2,135 m.) in length was then opened at a series of points 500 feet (153 m.) apart and observations were taken on Nauen's 6,300 meter wave, comparison being made in each case with the signals obtained on a fixed 2,000-foot (610 m.) ground wire. A curve was plotted from this data which showed a maximum at 3,000 feet (915 m.); the curve was, however, very flat. A little later experiments were undertaken with a ground wire buried seven feet (2.1 m.) deep, a number of pits having been dug for the installation of disconnecting switches. Observations were taken on signals on 9,500 meters from Stavanger, Norway, and on Nauen's 6,300 meter wave. The total length of ground wire available was 2,000 feet (610 m.). The observations were inconclusive, the Stavanger signals at 9,500 meters indicating a maximum when the full length of the wire was used, whereas measurements on Nauen indicated a linear rise proportionate to the length of the wire, that is to say, the Nauen observations indicated no optimum length inside of 2,000 feet (610 m.).

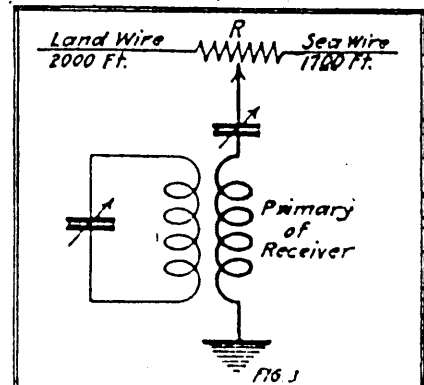

The Third Attempt Made in an Effort to Balance the Signals and Strays is Here Shown. A Small Potentiometer, It, Permits the "Land" Wire To Be Balanced Against the "Sea" Wire. This Arrangement Did Not Give the Results That Had Been Expected.

RATIO OF SIGNALS TO STRAYS.

In order for the ground wire system to be of practical value it must be able to show advantage in readability of signals not only over an ordinary aerial but over a properly designed receiving frame or closed loop, since the latter is more compact and easier of installation. The elimination of actual static is, of course, fairly complete on the ground wires, but the relative advantage of ground wires over rectangles, as far as the elimination of all strays was concerned, had to be made the subject of exhaustive tests. Early in January, 1918, the writer requested Lieut. A. Crossley at Great Lakes, to construct a rectangle 11 feet (3.36 m.) square, wound with 80 turns of number 13 double cotton-covered wire spaced 0.5 inch (1.27 cm.) apart. This rectangle was compared for a considerable period of time with the 1,200 foot (366 m.) "packard cable" at the Great Lakes laboratory station on the bluff, the cable being buried four feet (1.22 m.) under the surface of the earth. The ground wires gave signals averaging three times as strong as those on the rectangle. The ground at that time was partly frozen.

The average readability of signals at Great Lakes was 62.6 per cent better on the ground wire than on the rectangle. About the time the frost penetrated well into the ground at Great Lakes, it had been noted that the strays became distinctly worse. The same thing was noticed on the sea wires at Belmar when the shallow inlet froze up so that the wires were partly covered with a three-inch sheet of ice. In order to get further evidence, wires were laid at Belmar on top of the ice and directly over the sea wires and the ratios of signals to strays on many trans-Atlantic stations were obtained in comparison with the signals on the sea wires frozen in the ice. The readability of signals, defining readability as the ratio of signals to strays, was twice as good on the sea wires under the ice, altho not as good as on the same wires without any ice over them. In the meantime hundreds of observations had been accumulated at Belmar comparing the ratio of signals to strays received on rectangles 77 feet (23.5 m.) long by 30 feet (9.2 m.) high, with 12 turns of number 10 copper wire spaced 6 inches (15.2 cm.) apart, with those obtained on 1,200, 1,400, and 1,700-foot (366, 427, and 519 m.) sea wires and with those obtained on a 2,000-foot (610 m.) land wire buried 2 feet (61 cm.) deep. Many observations were also made on a 2,000-foot (610 m.) land wire buried 7 feet (2.14 m.) deep. This latter wire gave louder signals than the one buried 2 feet (61 cm.), but the same ratio of signals to strays. The general average showed that the signals obtained on rectangles and sea wires were of approximately the same intensity, but that the readability

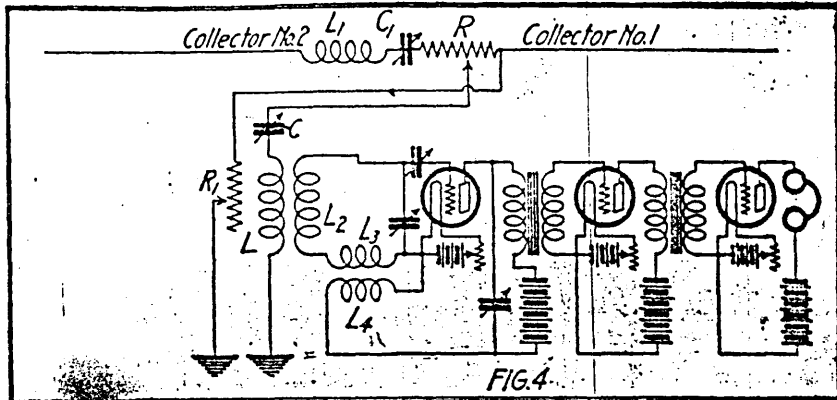

This is the Circuits Used in the Final Arrangement for the Balancing of the "Land" Wire against the "Sea" Wire, Where a Phase-Adjusting Device, L_1C_1 , is Put in Series with Either the "Land" or "Sea" Wire. The Signals Were Amplified by Several Audions in the Manner Indicated.

of the signals received on the sea wires was twice that received on the rectangles. On the other hand, the ground wires, altho giving signals four to five times as strong as the rectangle, showed no advantage whatever in readability.

THE ELIMINATION OF STRAYS FROM LAND AND SEA WIRES.

It was finally decided that the only way to do anything towards the further suppression of strays over and above that already obtained by the use of a good sea wire, was to apply the method of elimina-

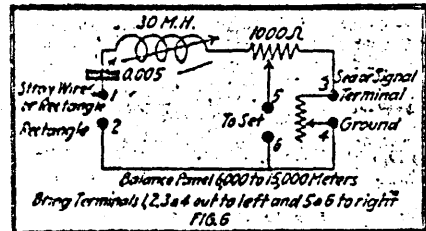

Design of Panel to Be Placed to the Left of a Standard Navy Long-Wave Radio Receiver; This Panel Provided the Necessary Terminals for "Sea" Wire and "Land" Wire, or Rectangles. It Also Contains the Phase-Adjusting Device in Series with the Rectangle or "Land" Wire, the Balance Resistance, and the Shunt-to-Earth on the "Sea" Wire Terminal.

tion ahead of the primary of the receiver. Considerable improvement in the ratio of signal to stray was obtained by placing a low resistance of value between 1 and 25 ohms across the primary of the receiving set. It will be remembered that the receiving sets were standard Navy long wave tuners and, therefore, had a series condenser, and that in ground wire work the tuning of the primary is dependent only

upon the constants of the primary and not upon the length of the ground wire, the only exception being when exceedingly short ground wires are used. There is also probably some slight deviation from the rule when working with short waves around the optimum wire length. The placing of the shunt around the primary therefore did not in any way affect the tuning of it. The improvement in signal-to-stray ratio obtained by the use of the shunt is at the cost of considerable diminution in signal strength and is not therefore of very great value in improvement in readability except in special cases. It having been determined that the sea wires had twice as good a ratio of signal to stray as the rectangles, it seemed likely that one ought to be able to balance the strays from a rectangle against those from a sea wire and still have some signal left over. This was first attempted by coupling magnetically the primary of the receiving set by means of a differential radio frequency transformer to both sea wire and rectangle. The differential transformer had one secondary coil which was in series with the primary of a receiving set and it had two primary coils, one of which by means of a series condenser was tuned to a rectangle and the other tuned by means of another series condenser and suitable loading coils to one of the sea wires. See Figure 4. As a balancing arrangement the device worked perfectly, but altho signals even of very great intensity could be accurately balanced out, it was not possible to balance out strays. It should be noted that the planes of the rectangle pointed in the same direction as the sea wire, that is towards the European stations. The failure of this experiment was, at the time, laid to a lack of exact similarity in directive properties of the two component parts of the balanced system, but it is the present opinion of the writer that the failure was due to the fact that the rectangle constitutes a relatively feebly damped receiving system while the sea wire is, especially for long waves, aperiodic. A similar attempt, shown in Figure 2, was made to balance a land wire against a sea wire and with the same results as far as this circuit is concerned. This is probably due to the fact that a land wire in dry soil is not so nearly aperiodic as a sea wire. If the land wire were laid in wet soil the experiment would also fail, because the ratio of signal to stray would be too nearly the same for both sides of the system. The next attempt, shown in Figure 3, was to balance by means of a small potentiometer arrangement, a land wire against a sea wire. The resistance R was a slide wire rheostat, various values being tried from 50 to 2,000 ohms. The idea in the arrangement of Figure 3 was that the current from sea wire to ground would be opposed in phase

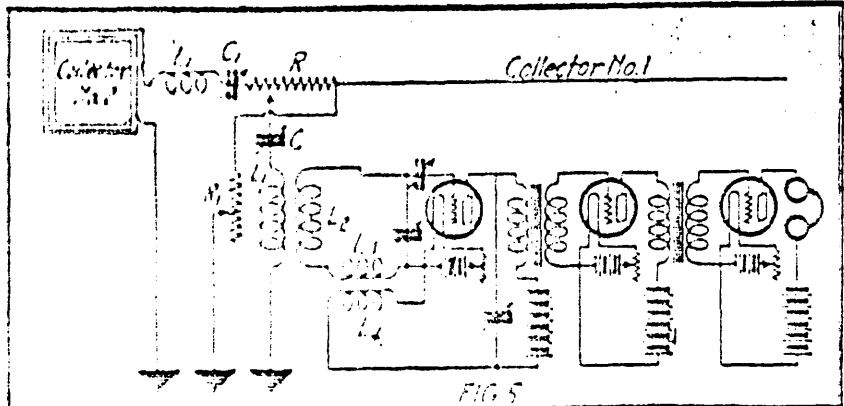

This Circuit Shows an Arrangement for Balancing the Land, Collector No. 2, Which Serves as a substitute for the "Land" Wire Balanced Against the "Sea" Wire, as Shown in the Previous Circuits. Notice That the "Sea" Wire is Shunted Through a Resistance R , Which Was Found Very Important. The Resistance R is Sufficiently High to Give the Loop 2 a Very High Q-factor.

(Continued on page 100)

Long Waves and "Strays" on Rogers Antennae

By LT. COM. A. HOYT TAYLOR, U.S.N.R.F.
(Continued from page 59)

from the current from land wire to ground and by suitably proportioning the two parts of the resistance R , the strays could be balanced out. Such, however, did not prove to be the case and it was recognized that the difficulty was due to the fact that the phase relationship of the current in the sea wire was not the same as for the current in the land wire. The final arrangement for the balance of the land wire against the sea wire is shown in Figure 4, where a phase-adjusting device, $L_1 C_1$, is put in series with either land wire or sea wire. It is not necessary to have this device in series with each collector. It was usually used in series with the land wire. It will be noted that the ratio of signal to stray on collector number 1, that is, the sea wire, has been further improved by the use of the resistance R_1 , which shunts the end of that wire directly to ground. This circuit at once gave very satisfactory results and experiments were immediately continued to determine whether the balance of strays was dependent upon the length and nature of the land and sea wires. It was found that within the limits wherein observations were taken on sea wires, namely from 1,000 to 2,000 feet (305 to 610 m.), the length of the sea wire had but little influence, best results being obtained from 1,500 feet (458 m.) of sea wire. The length of the land wire was found to depend upon the wave length, in general, shorter lengths working better when shorter waves were to be balanced. The lead-covered cable was used as a land wire very successfully when the strays were made as bad as possible on the cable by intersecting the sheath, every two hundred feet (61 m.). It is desirable, of course, that the land wire have as bad a ratio as possible. Exceedingly satisfactory balances were obtained thruout the summer of 1918 on all wave lengths between 6,000 and 15,000 meters. No work was done on shorter wave lengths than 6,000 meters. The device was put into the hands of the operators on April 7, 1918, and either this circuit or the following circuit was used at Belmar from that time on for copying all trans-Atlantic signals. Encouraged by the success of this method of balancing two wires, attention was again given to the rectangle, since the rectangle showed just as bad a ratio of signal to stray as the land wire and should have sufficiently similar directivity. The rectangle was therefore substituted for the land wire. The resistance R is sufficiently high to give the rectangle a very high decrement. The tuning is exceedingly flat. No marked success was obtained until the circuit shown in Figure 5 was adopted, that is, until the sea wire was shunted to earth thru a small resistance R_1 . The exact functioning of this resistance is not understood, but its presence, especially in the balancing of a rectangle against a sea wire, is of the utmost importance. Figure 6 shows the design of a panel to be placed to the left of a standard Navy long wave receiver, this panel providing the necessary terminals for sea wire and either land wire or rectangle. It also contains the phase adjusting device in series with the rectangle or land wire, the balance resistance, and the shunt to earth on the sea wire terminal. This circuit, Figure 5, is dependent also for its success upon the proper choice of the dimensions of the rectangle, since it is necessary to have a comparatively high resistance in series with it at all times. The rectangle must, therefore, be designed to have adequate collecting power. Naturally

this depends upon the wave length. For 6,000 meters a rectangle 30 feet (9.2 m.) by 77 feet (23.5 m.) with 12 turns of number 10 wire spaced 6 inches (15.2 cm.), was found satisfactory. For waves from 10,000 to 15,000 meters, a rectangle of the same dimensions but with double the number of turns was found best. The setting of the phase-adjusting condenser depends slightly on the depth of the water over a sea wire. As the tide came in it was found necessary to advance the phase slightly in the ground wire or rectangle, as the case might be.

METHODS OF ADJUSTING BALANCED SYSTEMS.

The method of adjusting the balanced system is described as follows (reference Figures 4 or 5):

(a) The slider of the resistance R is pushed to the right until there is little or no resistance between the slider and collector number 1. The primary of the receiver is adjusted by variation of the inductance L and the capacity C until it is tuned to the incoming signal. The resistance R_1 is adjusted to the lowest value which is consistent with good audibility of signal. The secondary L_1 is adjusted in the usual manner as are also the amplifiers.

(b) The slider of the resistance R is pushed to the left so that little or no resistance lies between the capacity C and the primary. Without changing the primary adjustment, the loading coil L_1 and the capacity C_1 are adjusted so that the same signal is received from collector number 2.

(c) The slider of the resistance R is then moved back and forth until the best readability of signals is obtained, the normal position being nearer the end of collector number 1 than to the capacity C_1 . In other words, the larger part of the resistance R will normally be in series with that collector which produces the worst strays.

(d) The condenser C_1 is now varied so as to shift the phase slightly in collector number 2. This adjustment is fairly broad, as on account of the resistance R , the tuning in the circuit involving collector number 2 is extremely broad, in fact the circuit is almost, if not quite, aperiodic. After a few adjustments have been made, the balance of the circuit is extremely simple, reminding one forcibly of the method of balancing employed in the bridge method for comparison of inductance at audio frequencies, where variable resistances and one variable inductance are used and the other unknown inductance is fixed. The difficulty of balance is of exactly the same order, which means that after a very little experience, it is not difficult at all. In fact, after one or two days' training, this system was put into the hands of operators who had had comparatively little experience, men who had been thru the Naval Radio School at Harvard University and whose only practical experience was that which had been acquired in the course of duty at the Belmar station. From time to time slight corrections in the balance may be advisable, as the character of the strays changes. These corrections are, however, mostly in the phase adjusting condenser C_1 , and were thought to be due largely to the influence of the tide in shifting the phase of the signal in the sea wire.

CHARACTER OF STRAYS.

The behavior of the balanced system is such as to lead to the conclusion that strays are very complex. Certain very sharp and violent strays were soon recognized, after experience with this set, to be of comparatively local origin, traceable to some storm within a radius of about one hundred miles (160 km.). It would frequently happen that it was possible to obtain trans-Atlantic copy when there were violent storms in the immediate vicinity of the station.

America's Greatest War Invention

The Rogers Underground Wireless

(Special Interview to the ELECTRICAL EXPERIMENTER.)

By H. Winfield Secor

(Associate Member Institute Radio Engineers.)

An invention which has been termed the greatest American war achievement is the Rogers underground and sub-sea radio system. The Rogers system does away entirely with aerial wires, and it is only a matter of months now before all aerial wire systems the world over will be pulled down. Wonderful things have been accomplished by the new Rogers underground system, chief of which is the total elimination of static and the increase of the loudness of received signals, which is often as high as 5000 times the usual strength. Interference, too, is done away with almost entirely now. The Rogers invention is of tremendous importance and revolutionizes our previous ideas on wireless to an extent never dreamt of before. We urge every one interested in radio to read the accompanying authoritative article which discloses the full technical data on the new system for the first time in any periodical.

THE greatest invention in the field of wireless telegraphy since Marconi first placed commercial radio-communication on a firm basis by his historic experiments in Italy, and later in England, is without a shade of doubt this latest triumph of radio research—the "Underground and Sub-sea Wireless", conceived and developed to a working stage by an American scientist and inventor, James Harris Rogers. Mr. Rogers is known as a second Edison, among his towns-people in Hyattsville, Maryland, where he has lived for many years, and now the whole world acclaims him.

It is Revealed Now That the Navy Department Had Been Using a Powerful Undersea Wireless During the War. The Instruments and System Were Invented by James H. Rogers, of Hyattsville, Md., and were Adopted by the Navy Department as an Invaluable Addition to the Wireless System of the Navy. The Two Lower Photos Show the Inventor, Mr. Rogers, in His Laboratory at Hyattsville.

Who is Mr. Rogers?

James Harris Rogers, practically unknown a few years ago in radio circles, except by a few select radio men who were investigating his invention for the Navy Department, has practically become overnight the center of all attractions in the field of science. Mr. Rogers is a son of the confederacy and a veteran of the great Civil War. He has followed electrical experimenting ever since and has been a strong devotee of radio telegraphy since Marconi performed his first experiments in this new branch of applied science. He is a refined, cultured southern gentleman who makes you feel at home at once; an invariable attribute of all of the truly great. Mr. Rogers was one of the first inventors of the "printing telegraph" and his full-sized working models saw actual commercial service on a circuit between

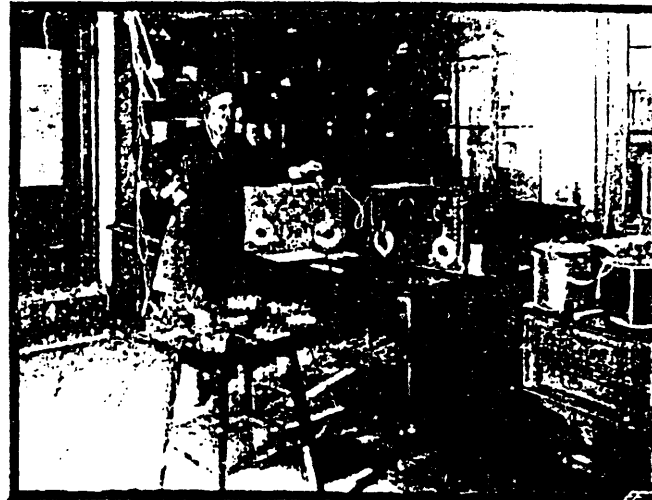

Baltimore and Washington, also in New York, back in 1880. These were seen by the writer and are wonderful pieces of mechanism.

The Rogers laboratory, which comprises several large rooms, is lined on all sides with glass cabinets containing electrical apparatus which he has invented from time to time thru his studious career. A novel and original high frequency generator was another of the devices that greatly interested the writer. It employed a jet of water shunted by a large capacity, the stream of water being connected to a high potential source of direct current. High frequency currents

Top Photo Shows Antenna Wires Being Placed in River by Mr. Rogers' Assistants. The Inventor Has Found that His System Works Just as Well Under Water as Thru the Earth. All of the High Power Stations in the World, from Nauen and Lyons to Honolulu, Are Heard in Mr. Rogers' Laboratory at Hyattsville, Md., Shown in the Center and Lower Views Herewith. The Author of This Article Also Heard the Transatlantic Stations Coming in Loud and Clear. Mr. Rogers' Invention is the Greatest in the War and is so Recognized by the Government.

of any range up to the limit of audibility, or about 30,000 cycles per second, could be readily obtained with this apparatus. The writer merely cites these facts to substantiate the standing of Mr. Rogers in the scientific field. Hundreds of other electrical inventions have been made by this modest genius of the quiet little Maryland town of Hyattsville, and the principal outstanding fact of all of his work is that he can show you a working model of each of these inventions, unlike many other inventors whose ideas exist only on paper, and which often fall down miserably, when actually built and tested.

In this connection it is interesting to consider for a moment that not one of the new wireless "static and interference preventers" proposed to the government radio experts during the war, proved practicable in the least.

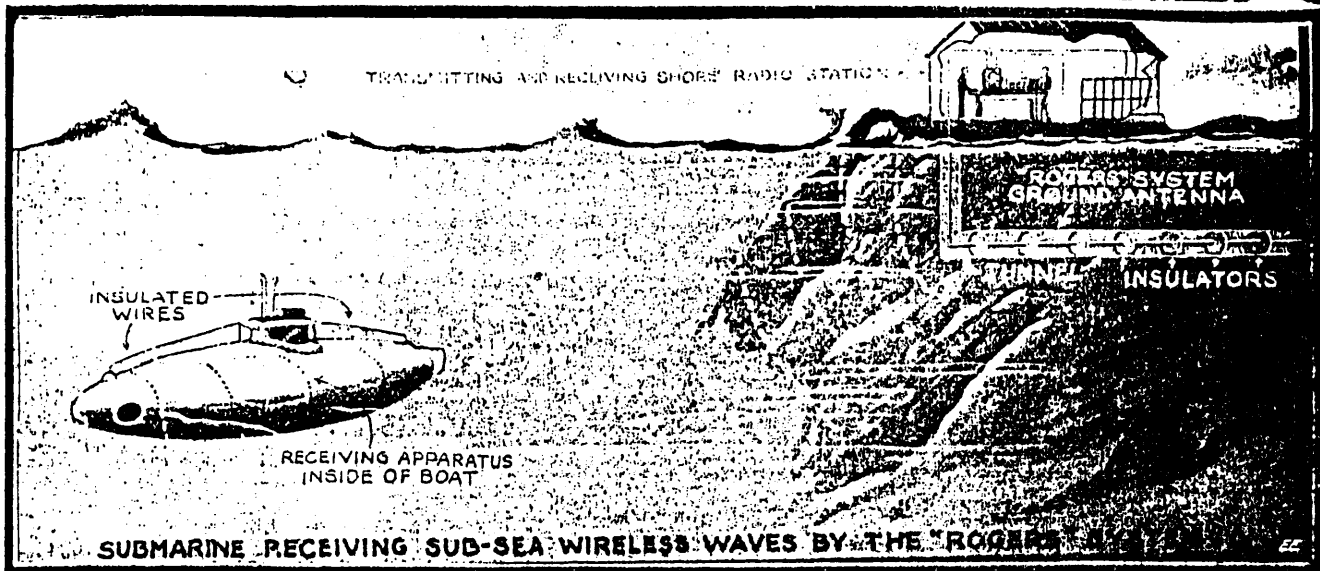

Copyright, 1919, by E. P. Co.

The Rogers Undersea Wireless Opens Up an Entirely New Field to Submarines and Ship Communication. Marconi Recently Stated that Submarines Had to Come to the Surface to Intercept Radio Messages, but the Rogers Invention Has Upset All This. On a Recent Test a U.S. Subsea Boat Submerged Off the American Coast to a Depth of 8 Feet and Picked Up Nauzen, the German Station. At Depths of 21 Feet Stations with Wave Lengths over 12,000 Meters Were Easily Picked Up. Transmission to Submarines Has Also Been Accomplishd.

Official recognition of Mr. Rogers as the one and only original inventor of "Under-ground and Sub-sea Wireless Communication," was soon forthcoming, and here it is in brief. These two official letters of recognition of Mr. Rogers' wonderful and revolutionizing invention represent but a

been in use by the Navy Department, may be judged by the fact that radio men everywhere are amazed at this feat. The distinguished radio savant Prof. George W. Pierce of Harvard University, congratulated Mr. Rogers heartily when he first tested and heard the new system work thru salt water, which he at first thought absolutely impossible.

For a decade Mr. Rogers has been studying radio subjects, and long before the United States entered the war he had experimented with the problem of ridding aerial communication of this static atmospheric electricity. He disagreed with all authorities who believed that the air, and

Hyattsville, Md.,
January 13, 1919.

Dr. Nikola Tesla,
New York City, N. Y.

Dear Dr. Tesla:—

I have just read with great interest your article in the *Electrical Experimenter*. For years I have been a firm believer in the theory that far distant aeriels were actuated thru the medium of the Earth and not thru the ether above, and it is a source of great satisfaction that so illustrious a personage as yourself has held to the same belief. I have never met a scientist who would entertain such a proposition until I demonstrated to them results described in the enclosed paper, illustrating one of the ways I have found for utilizing the energy so clearly and forcibly described by you. I am, nevertheless, confronted by some who will not give up old theories. If you would do me the great honor of writing a few lines upon the scientific feature I would deem it a great favor.

Should you chance to be in Washington at any time I will be highly gratified to have you visit my laboratory and witness the results obtained.

Very sincerely,

(Signed) J. Harris Rogers.

Below we give the two letters of official recognition by the Navy Department of Mr. Rogers' accomplishments, which are all that we have space for.

In response to an inquiry from Clarence J. Owens, director general of the Southern Commercial Congress, Admiral Griffin, U. S. N., chief of the bureau of steam engineering, wrote under date of December 27, 1918, as follows:

"In reply to your question regarding the originator of the underground radio system, you are advised that Mr. J. H. Rogers of Hyattsville, Md., was the originator of this system. There have been other claimants to methods of underground radio signalling, but none were useful, within the Navy Department's knowledge to the extent of being a valuable asset to the general scheme of radio communications. The introduction of Mr. Rogers' receiving system marked the beginning of the use of underground aeriels for receiving, to great advantage over raised aeriels, and has been valuable to the Navy during the war."

Rear Admiral Strother Smith, then Capt. Smith, wrote Mr. Rogers on December 7, 1917:

"It is a great pleasure to me to feel that I have been instrumental in bringing the result of your work before the Navy Department and assisting somewhat in putting it into actual practise. Out of the many thousand ideas presented you can realize that a very, very small percentage are valuable and it is worth at least a year's work to get one that I feel will give lasting benefit to the service that I take pleasure in serving."

The Navy Department interested.

Thru Dr. George H. Lamar and Senator Blair Lee the discovery and the status of the patents were brought to the attention of Secretary Daniels of the Navy. Secretary Daniels ordered inquiry into Mr. Rogers' claims, which showed that his invention worked, and requested Secretary Lane to give special consideration to pending patent applications.

Secretary Daniels then submitted the Rogers system to Rear Admiral (then Captain) Strother Smith, who called into consultation Capt. Hooper. These officers made a thoro study of the system and found it practicable. Capt. Hooper ordered it installed at New Orleans first and since then it has been employed at Belmar, N. J.,* and other stations.

* At the time of writing this article the Belmar Trans-Atlantic Receiving Station is still employing the Rogers underground antenna.

To the American Radio Amateur:

WITHIN the next few months peace will be declared and the amateur will be allowed to operate his station as before. Thanks to Mr. James H. Rogers, it will not, however, be necessary for you to put up an aerial again—at least not for receiving. Elevated aeriels will be a thing of the past, and well they may.

But ordinarily the amateur would not be permitted to use the underground aerial system on account of Mr. Rogers' fundamental patents. The writer, however, in conversation with Mr. Rogers, prevailed upon him to allow amateurs the free use of his revolutionary, as well as epoch-making invention.

Mr. Rogers thru the *ELECTRICAL EXPERIMENTER* therefore wishes to announce that he personally has no objection if amateurs use his system privately. It should be understood that the inventor only gives this permission to amateurs as such, and that this permission, of course, does not extend to firms or corporations or to individuals engaged in commercial Radio work.

We wish to congratulate our readers upon this important decision of Mr. Rogers, who certainly deserves the everlasting gratitude of all American Radio Amateurs.

H. GERNSBACK.

very small fraction of those he has received from radio engineers of high repute in all parts of the world, congratulating him on his masterly work. The Navy Department has just permitted information on the Rogers system to be given out, and how well they kept their secret during the World War, during which time this system has

not the earth and water, was best suited for wireless communication.

At first Mr. Rogers used the earth alone for sending messages to amateurs stationed near by. Using an audion bulb, he then buried a wire from his laboratory and heard Philadelphia and other stations. Further experiments were conducted at a laboratory

near Bladensburg, which he calls "Mount Hooper," in honor of Commander Hooper of the Navy, who rendered excellent service in adapting the invention to the needs of the Navy Department.

When Mr. Rogers first stated that messages could be received and sent from submarines when submerged it was unanimously declared to be impossible and the officials of the Bureau of Standards were not alone in this belief, as no less a personage than Marconi declared at a banquet given in his honor in Washington, that when wireless was used on submarines, "it was necessary for the submarine to come to the top in order to catch the ether waves."

To demonstrate more clearly the underground system and to show how it could be used in trench warfare, Mr. Rogers constructed an underground station, wholly inclosed beneath the surface of the earth, there being no visual existence of it outside. This place in Prince Georges county was visited by some very noted men, including Dr. Abraham, the head of the French Scientific Commission, who, upon entering the cave at Mount Hooper express his amazement and remarked, "the Germans can't get us here." Lieutenant Paternot, of the French Scientific Commission and the radio representative of France, also heard his native stations talking and express equal satisfaction, pleasure and amazement.

How He Conceived the Underground System.

The writer asked Mr. Rogers just how he came to form the idea of the "Underground and Subsea Radio." He explained that from his very first study of the method of transmitting radio signals by means of an elevated antenna, the question constantly presented itself to his mind—"If 50 units of power are past into the aerial, then what becomes of the equal amount of energy which passes into the

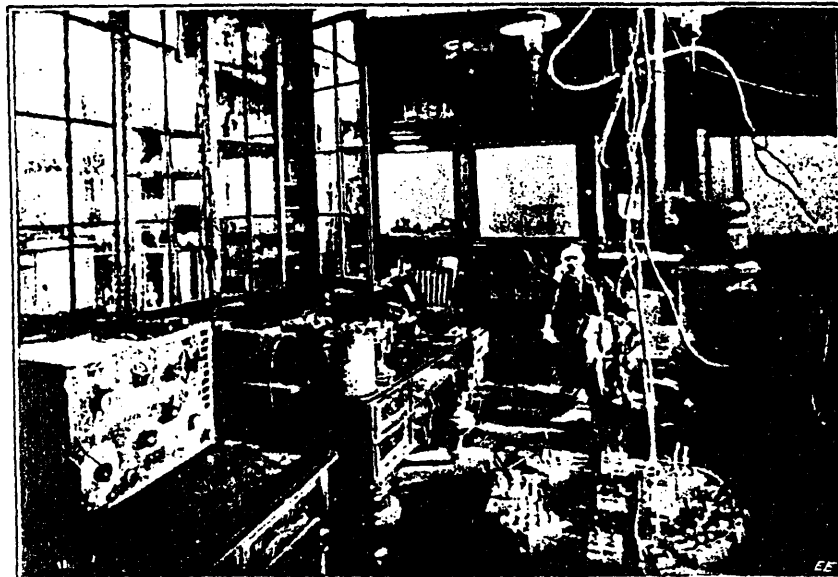

Another View of Mr. Rogers In His Laboratory. Note the Glass Instrument Cases, and in the Background May Be Seen His Early Printing Telegraph Model.

ground?" He became so obsessed with this conundrum that he finally asked several prominent radio savants this question. What do you suppose the answer was?—"It is dissipated in the form of heat in the ground," they answered. But still Mr. Rogers thought they were wrong and now

the waves reached the same point thru the ether above; when the waves thru the earth reached the base of the aerial the potential of the plate would be raised and lowered and the aerial would accordingly be energized. Thus was his basic and original idea conceived and settled upon.

Mr. Rogers' first trial with the underground wireless to nearby radio amateurs began about seven years ago, but his theory of the reason why it must work was formulated over ten years ago. Further, he conjectured that much less power would be required to propagate a wave or current thru the earth's conducting crust, which for one thing has smaller geometrical dimensions, than to propagate it thru the insulating atmospheric envelope alone. See Fig. 1.

The Theory of Operation.

A number of other radical ideas were entertained for several years by Mr. Rogers, and in the course of time he has found that his ideas were correct—it worked! it worked! it worked! And now the radio experts far and wide are holding a post mortem inquest on their theories and how it all happened. To start with, Mr. Rogers stated, "special credit is due the following gentlemen, who have re-

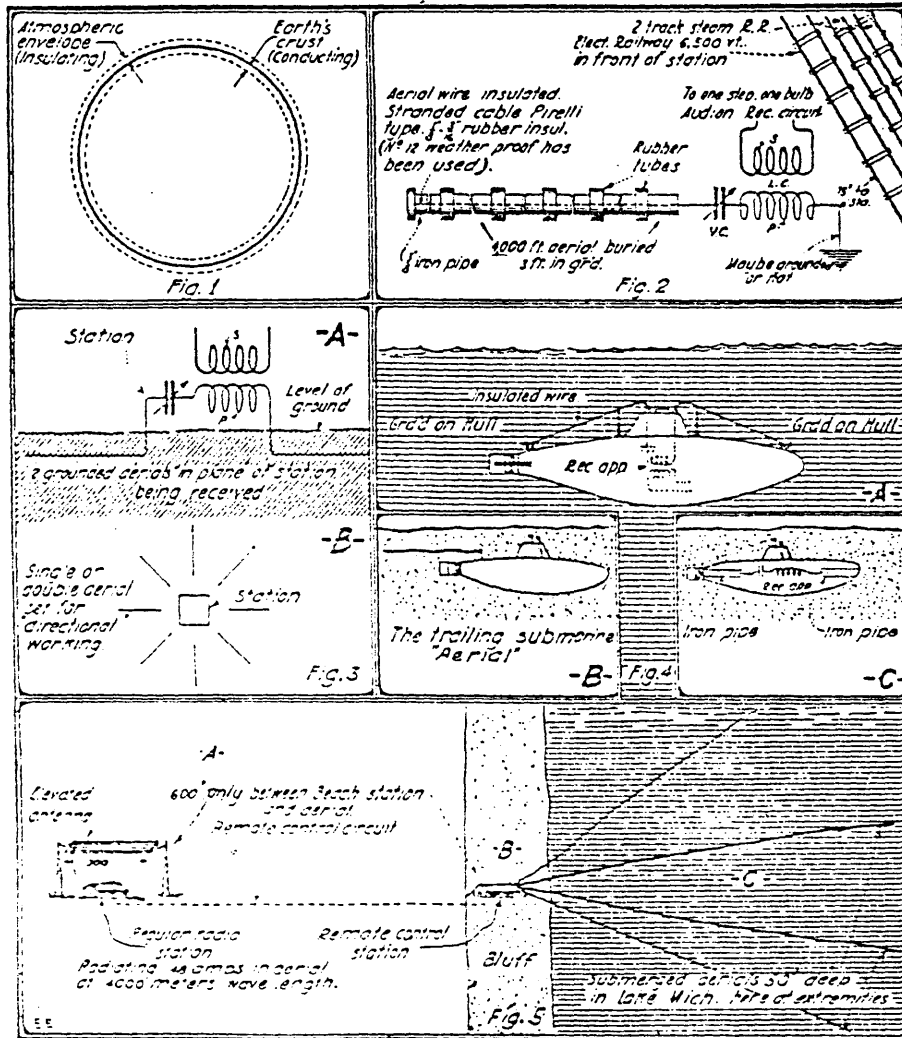

Various Arrangements of the Rogers Ground Aerial System, Including the Submarine "Underwater" Antenna.

(Cont. on page 832)

THE ROGERS UNDERGROUND WIRELESS.

(Continued from page 789)

mained enthusiastic and sincere in all the tests and installations made of my underground radio system thru all the trials and disappointments of its development, even when the system seemed to prove unworkable. Their perseverance and high skill in the radio art has hastened the official endorsement and the installation of the buried and submerged antenna." Commander A. Hoyt Taylor, D.Sc., U. S. N.; Dr. L. W. Austin, of the Bureau of Standards; Admiral Strother Smith, U. S. N.; Commander Hooper, U. S. N.; G. H. Clark, Expert Radio Aid, U. S. N.; Dr. George W. Pierce, of Harvard University; and Ensign A. Crossley, U. S. N., who has been actively engaged on the installation of the Rogers system at the Great Lakes Naval Radio Station, besides New Orleans, New London, Conn. (test station, now abandoned), and Norfolk, Va.

Like many other great inventions the exact mode of operation is hard to ascertain and define. The views of Mr. Rogers on the operation of this wireless system are briefly defined as follows:—First, that the electric energy liberated at the base of an antenna will be propagated thru the earth even in the absence of etheric space waves above, if such a condition were possible, and which in reality does occur when great distances are signalled over, so he believes. Second, that the propagation of earth waves no more depend upon the ether waves above the surface of the earth than these etheric space waves depend upon the earth waves. Further, that both waves are propagated simultaneously, one above and the other below the surface of the earth, and that at the initial start each is dependent upon the other, altho thereafter neither is dependent upon the other. Furthermore, Mr. Rogers believes that the ether waves gradually die out in intensity in proportion to the earth's curvature, and the distance over which they are propagated, and that at great distances the ether space waves do not have any appreciable effect upon receiving appliances, and that these are energized solely by the energy transmitted thru the earth.

These ground currents travel with the speed of light and are picked up at the receiving station. The space waves persist for an appreciable distance, which accounts for air-plane to air-plane and air-plane-to-earth radio-communication, but it is the belief of Mr. Rogers that in such long distance radio transmission as half-way around the globe (12,000 miles) that it is the ground wave current that does the work, and that the free space wave above the surface of the earth never reaches the station, due to the high resistance of the atmospheric envelope.

One of the Naval experts present mentioned that it has been found, that the penetration of the ground wave component increases with an increase in wave length. This is an important fact and helps to explain the operation of this new radio system, with its aërials buried in the ground. He also mentioned that "Radio to Mars" or other planets would be impossible, if we are to believe in the well-known "Heavyside" ionization layer, surrounding the earth at a height computed at from 30 to 50 miles, for no etheric wave can pass this layer without being reflected back to the earth, or at least restrained within this passageway.

Rogers System Eliminates "Static" and "Interference".

Mr. Rogers stated that his underground antenna, in itself, did not solve entirely the static or interference problem, but it made the nearest approach to this ideal condition—the goal of all radio engineers—than had ever been accomplished before. This problem has, thanks to a new arrangement perfected by Commander A. Hoyt Taylor, D.Sc., been solved and *static and interference have been practically totally eliminated, for all-year-around radio service.* Think what an advance this means! Further, *there is no rise and fall in the signal strength during the night or day, at any time of the year, due to the sun's ionization effect, as is the case where elevated antennae are employed.* The U. S. Naval reports and tests made with the Rogers' ground aërial in comparison with the usual form of elevated aërial, several of which are appended herewith, show the incomparable efficiency of this new radio system.

What the Facts Show.

First we will mention the test which Mr. Rogers and a naval officer conducted for the writer. The apparatus used in these tests are shown in the accompanying photographs. They included several large tuning inductances, variable condensers, a one-step audion amplifier (single Audiotron bulb only!) and two pairs of Baldwin phones (telephone receivers). This apparatus was connected up to one of Mr. Rogers' latest buried antennas—a single rubber covered, stranded copper cable, about the size of a small ignition cable, extending westward for a distance of 4,000 feet, so as to be in a plane with the high power European radio stations. *This cable is encased in iron pipe (gas pipe), each 20 foot section of which is insulated from the abutting sections by means of a rubber hose (garden hose) slipped over the pipe ends for a few inches.* This is buried in a dirt trench about 3 feet deep, filled in with soil. The cable is insulated at the free end and is connected up as in Fig. 2. The rubber covered wire alone has been used in all sub-aqueous tests, and gives fine results when simply buried in the ground, the decay not being so rapid as probably would be imagined. This latest aërial in the iron pipe is a new development and experiments are still going on with it. It works wonderfully well. The 4,000 foot aërial here described is best suited to receiving wave lengths of 6,000 to 16,000 meters. For shorter wave lengths aërials of smaller dimensions are employed.

"Here's the 'Lyons' station in France," said Mr. Rogers. A turn of the knob on the specially calibrated condenser, and there was "Lyons" (France)—sure enough. *Static and interference were unheard.* Next the great stations across the broad Atlantic, at Nauen, Germany; Carnarvon, Wales (England); and Rome, Italy, were heard with equal loudness and clarity. This laboratory station, which has been used by the Navy Department during the war, has picked up practically all the high power stations on the globe. American stations were then picked up by changing the wave length, and finally a test was made on a short (250 feet in length) buried ground antenna, adapted to receiving wave lengths of 200 to 800 meters. Wireless telephone messages were picked up from Washington, a distance of about seven miles. It is most interesting to note at this juncture, as the Naval tests at Norfolk, Va., on a similar aerial have shown, that a radio message from an airplane cannot be picked up on the underground aerial, until the 'plane is directly over the station. This would seem to prove two things—first, that the short waves sent out by the airplane radio set do not penetrate into the ground very far, if at all,—and second, that airplane radio transmission and reception are effected solely by etheric waves.

Referring to Figures 3 and 4, we find several interesting points. Fig. 3-A, shows how a double ground aerial is sometimes connected. Also, as in the case of Mr. Rogers' test station, several sets of these buried antennae are best employed, distributed about the station as shown in Fig. 3-B.

The Rogers underground antenna system has been used at the Belmar, N. J., station during the war with most gratifying results, as reported by the Navy Department, and its successful and unflinching operation during the twenty-four hours of the day, resulted in trebling and quadrupling the capacity of this great trans-Atlantic highway of intelligence communication. The official

reports in connection with the work accomplished with the underground Rogers system at Belmar state that not a single word of communication was lost during the reception of thousands of important official messages from Europe. The station at Tuckerton, N. J., has also been equipped with the Rogers underground aerial system and all of the larger stations of the Allied Powers in Europe have been copied successfully thru the 24 hours, at this point also.

Submarine Wireless.

Perhaps the most interesting tests of all are those which were made on *submerged submarines in salt water!* The aerial in this case was of heavily insulated stranded cable, stretched from stem to stern as Fig. 4-A illustrates. The two aërials were brought down thru the conning tower and joined to the receiving apparatus. A second form of aerial is illustrated at Fig. 4-B, where the insulated aerial wires are placed in iron pipes within the submarine. Here are the results of some of these tests, which do not include the transmitting tests to the submarine, from a ground antenna on shore. When submerged 8 feet, the German station at Nauen was picked up by the submarine while lying off the American coast! *Submarines have, in other official tests, picked up distant stations when submerged 21 feet, on a wave length of 12,500 meters or greater wave lengths.*

One of the naval officers, who has had much to do with the testing of the Rogers' system, stated that experience had demonstrated that *in fresh water the submerged antenna may be placed at any depth.* Salt water acts differently, but the aerial may be submerged any desired depth for wave lengths above 10,000 meters.

The same officer, who has made a close study of all American and European work in radio, explained how the best work ever done in radio was accomplished at the Great Lakes Naval Station, on the shore of Lake Michigan. Fig. 5 gives the general arrangement of this station. The test station was

on the beach and acted as a "remote control" station for the standard station at A. The shortest distance between a "receiving and control station" in the naval radio service heretofore has been 36 miles. Here a distance of 600 feet only, separate the elevated aerial of the main station from the submerged Rogers antenna terminating at the test station, B." Said he, "Now let the inventors of 'static and interference' preventers trot out their little pets, and show what they can DO! Here's what this station *actually did on schedule service:* With 48 amperes, at 4,000 meters wave length, being radiated in the elevated main antenna—the beach station, **ONLY 600 FEET AWAY,** was picking up Nauen on 12,000 meters, and New Orleans on 5,000 meters, without any interference or static—all on the Rogers sub-aqueous aërials. These were rubber-covered cables spreading in different directions, any one of which could be used, and laying 50 feet deep in the water at their outer extremities.

Imagine such a wonderful performance! But this is not all. The official tests show that the station at Cavite, P. I., 8,100 miles away, was received regularly on the Rogers sub-aqueous aërials at the Lake Michigan Station, on *schedule service*, at 11 A. M. and 5:30 P. M. daily, the working periods of that station.

Transmitting On Underground Aerials.

Tests were made by the naval experts, as well as by Mr. Rogers in his very first experiments in transmission from a ground or under-water antenna. *These were all successful.* It is only a matter of properly insulating the antenna so that it will not break down under the high potential applied to it by the transmitter. The early tests by the inventor were made with a one inch spark coil to the Bureau of Standards Radio Laboratory, a distance of seven miles, *the received signals having an audibility of 2,000, i.e., 2,000 times the strength of a clear, readable signal.* The audibility of the signals at the Washington Navy Yard

was 1,000. The transmitting tests at the Great Lakes Naval Station were made at first with a low power Oscillon bulb transmitter and later with a Clapp-Eastham hystone set. An elevated amateur style antenna of two wires was strung up between two houses 38 miles away. Clear signals were received with an audibility strength of 2,000. The ignition cable used for the aerial finally punctured, but even then the signals received were four times louder than the best amateur transmitter could send on a regular aerial, as tests proved.

Official U. S. Naval Tests of Underground Reception, at Naval Station, New Orleans, La., During 1917.

Excerpts.

In general, (relating to the Rogers' system) the point of interest lies in the use of wires buried in the ground, for both the transmitting and the receiving antenna. For instance, in receiving, a wire buried one foot below the surface of the earth extends for several hundred feet south of the receiving station, and a similar wire north, the receiver being located between the pairs of wires. The ordinary receiver was used. With this arrangement, signals from Darien, Nauen, and all Atlantic stations were received.

Tests at New Orleans Station.

Federal receiver used on main antenna, Western Electric receiver used on underground antenna, 1,400 feet buried wire. (The figures refer to audibility.)

Station	Main Antenna		Underground Antenna	
	Wave Length	Sig. aud.	Static aud.	Sig. Static aud.
San Diego	9800	1200	1000	750 15
Arlington	7500	2000	3000	1500 50

Impossible to read Arlington on the elevated antenna on account of static interference. United Fruit Company station of New Orleans interfered with signals from Arlington on main antenna, but offered no interference on underground antenna.

Test on message from U. S. S. "Are-

THE ROGERS UNDERGROUND WIRELESS.

(Continued from page 835)

thus" at sea about 150 miles from New Orleans.

Main Antenna		Underground Antenna (500' composite)	
Sig	Static	Sig	Static
400	5000	300	15

The "Arethusa" had been trying to get thru a naval despatch which could not be copied on elevated antenna on account of serious static interference. The despatch was taken on the underground antenna, and every word copied correctly.

At 9 P. M., April 7, 1917, it was possible to copy signals from Tuckerton with ease, while static on the elevated antenna made it impossible to read any arc signals.

The following results were obtained with spark signals:

Three hundred foot wires in parallel, ten feet apart, a .002 m.f. condenser in series with primary coil of a Telefunken receiver to obtain 600 meters.

Date	Station	W. L.	Sig. Static		Sig. Static	
			Aud	Aud	Main Antenna	Main Antenna
Apr. 2	Point Isabel	600	15			
Apr. 2	Tampa	600	200	0		3000
Apr. 2	Port Arthur	600	150	0		3000
Apr. 2	Pensacola	1200	20	0	100	150
Apr. 2	Ft. Sam Houston		150			

Of particular interest is the fact that when static prevents reception on the main antenna, reception can be continued on the underground antenna. This has even been done during a severe lightning storm, when the main antenna would have been dangerous without grounding. Reception is also directional and permits of avoiding interference to some extent by using wire "off direction" of an interfering station.

Strays: Strays are as a rule practically absent. Occasional loud cracks widely separated are received. (Ed. note. This has since been overcome.) These isolated strays, altho frequently loud, do not interfere in the least with the reception of signals. On two occasions, strays have risen to an audibility in excess of 5,000 on these separate cracks, but even in this case, reception of signals, altho a little difficult, was not interrupted. On these two occasions it was necessary to ground both of the (elevated) aerials at the main station.

Considering the matter of strays, it can be said that on four or five occasions during one week, which was one marked by tremendous storms in the Great Lakes region, that strays rose to an audibility in excess of 10,000 at the beach station. Even in this case, however, signals from boats within 100 miles and from shore stations, such as Ludington, Milwaukee and Manitowoc, were usually readable, because the strays while very loud, were nowhere near as numerous as on the elevated aerial. During these periods a messenger was kept at the beach station to carry up messages to the main station, which could not receive these signals on account of the strays.

There seems to be no appreciable advantage in using more than one wire—No. 12 weather proof insulated.

The experiments at Great Lakes confirm the work of the Bureau of Standards on the importance of adequate insulation of the wire. If the wires are grounded at the ends, it does not necessarily make much difference unless they are adjusted to the optimum wire length; but if properly adjusted to this length, grounding of the wires, either intentionally or accidentally, produces a diminution of the signals, which, however, even with the intentional grounding of the two ends, still leaves them 50% of their maximum value. Therefore, while the question of insulation is important, it does not mean that the system will fail entirely if the insulation becomes faulty.

THE WIRELESS WORLD

THE OFFICIAL ORGAN OF THE WIRELESS SOCIETY OF LONDON

VOL. VIII. No. 18.

NOVEMBER 27TH, 1920

FORTNIGHTLY

THE SUBMARINE'S WIRELESS

By PHILIP R. COURSEY, B.Sc., A.M.I.E.E.

UNTIL quite recently the submarine vessel if fitted with a radio installation at all has only been able to communicate with the shore or with other vessels when upon the surface. Before submergence the aerial system required to be dismantled or at least lowered from its usual position, Fig. 1. In addition to these arrangements, others are now possible which greatly augment the utility of these vessels.

In an earlier article dealing with Hertz's early experiments with electric waves* reference was made to some of the "optical" experiments that may be performed with them which emphasise the similar nature

* "The Discovery of Electromagnetic Waves," *Wireless World*, 8, pp. 73-75, May 1st, 1920.

of light and the longer hertzian waves. Using apparatus of the type there described or of any similar form, it is quite easy to show the opacity of all electrically conducting materials to the passage of the waves. The interposition of a sheet of metal between the transmitter and receiver serves to screen the latter almost completely from the effects of the emitted radiation. The reason for this effect is most simply seen by considering the electrical forces impressed upon the metal by the waves impinging upon it. The wave consists both of electrostatic and magnetic fields acting at right angles to one another. The action of both of these on a conducting body assists in the establishment in it of electrical potential differences and currents. By one of the most universally true of electri-

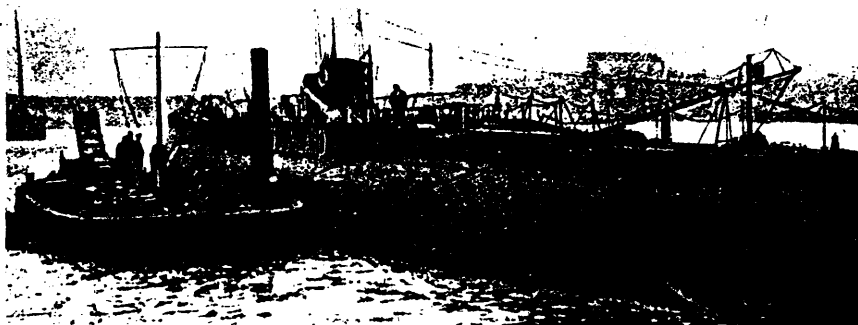

Fig. 1. General view of Submarine, showing Wireless Aerials of the ordinary type.

Photopress

cal laws, the direction of flow of these currents is such that the magnetic (and electric) fields set up by them act in opposition to the fields causing their establishment. These currents absorb the energy from the wave, with the result that to all intents and purposes the wave is stopped by the metal and prevented from travelling further in its original direction. The currents in the surface layers of the metal, however, set up magnetic and electric fields which give rise to waves which are propagated off in a direction perpendicular to the surface of the metal sheet. It is this secondary radiation that may be said to constitute the reflected wave sent back by the sheet.

As a result of these and similar experiments it has customarily been assumed that all conducting objects are completely opaque to electromagnetic waves. A consideration of the more accurate mathematical theory of wave propagation, however, shows that the whole of the energy of the incident waves is not absorbed by the surface layers of the metal, but that the absorption is gradual and follows an exponential law—that is to say as an approximate generalisation, the

The higher the frequency of the oscillations—i.e. the shorter the wavelength—the less does the effect penetrate into the conductor. Hence, long wavelength signals penetrate to a greater extent so that the waves used in ordinary commercial wireless signalling will penetrate to a much greater depth into conducting materials than will the very short waves set up by a Hertz oscillator.

Seawater being an electrical conductor will not allow the penetration into it to any great extent of the waves falling upon its surface. The development of the extremely sensitive receiving and amplifying apparatus using electronic tubes has rendered possible the detection and reception of wave energies very much more minute than could previously be effected. This development has not only rendered possible the successful transmission of radio signals over greater distances with a less expenditure of power at the transmitter, but has also enabled the submarine which when submerged has always in the past been completely cut off from the outside world, to receive messages and instructions from ships and from other high-power wireless stations.

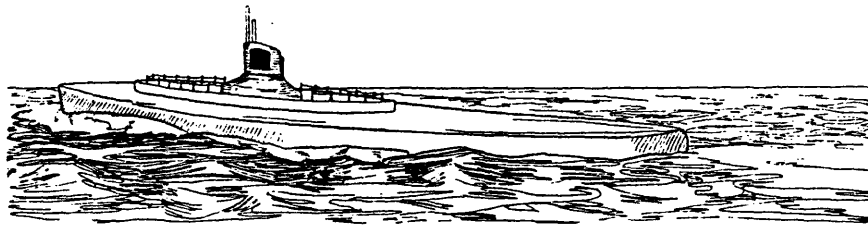

Fig. 2. Arrangement of fixed-frame Aerials on Submarine. (The frames containing the windings are mounted on each side of the conning tower. The position of one of them is indicated by the black square in this sketch.)

quantity of wave energy that exists at various depths in the metal or conductor decreases as the thickness of the metal is increased. The better the electrical conductivity of the metal the more rapidly does the effect disappear, and conversely with poorly conducting materials the wave penetrates to greater depths.

The arrangement adopted depends upon the properties of the loop aerial, as this proves much better suited to the problem than the conventional pattern of ship aerial. In some cases well insulated and suitably protected loop aerials have been mounted outside the hull of the vessel and connected (through watertight glands) to the ordinary

radio instruments inside, while in others—particularly in the American vessels—only a single turn loop has been employed stretched out for the whole length of the hull.

of the upper (wire) side of the loop by two leading-in wires brought down and into the conning tower. This second type of aerial has been used not only for the

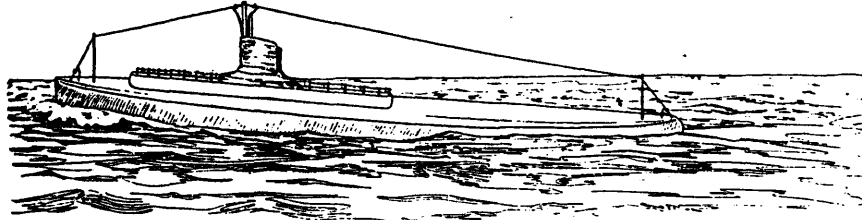

Fig. 3. Arrangement of single-turn loop Aerial on a Submarine. (The insulated wire is connected to the hull at both ends.)

The general arrangement of the former of these two types may be seen from Fig. 2, which depicts the arrangement of installation on a French submarine. The loop aerial is tuned to the wavelength to be received, by means of a variable condenser of appropriate value inserted between its ends. The condenser is joined to the terminals of an ordinary pattern of receiving amplifier and detector. A multi-stage high-frequency amplifier is practically essential for this purpose. This type of equipment is usually employed exclusively for reception.

The most important features of the American type of fitting are shown in Fig. 3. In this case the aerial consists of two wires which are led out from the radio apparatus and supported horizontally above the hull, one running forward and the other aft. At their extremities these wires are led down to the hull and connected to it, so that the return half of the loop is formed by the metallic shell of the submarine. Both wires should be most carefully insulated for their entire length from the leading-in glands and insulators to the points of connection to the hull, in order to preserve the proper loop character of the aerial. This type also is tuned and joined up to the radio apparatus in the same manner as the smaller multi-turn loop arrangement, the connections in this case being made from the centre

reception of wireless messages, but also for transmission between the submarines. The range obtainable (about 10 miles when only just submerged), although short is at least a step in the right direction to increase the safety of their craft. Since the energy penetration of the waves falls off with increasing depth, it is not practicable to carry on communication at great depths. The strength of the received signals also falls off rapidly as the ship is submerged.

As an illustration of this drop in transmitting range with increased depth of submergence, the following figures may be quoted :

	Range	Aerial Current
Submarine running full speed on surface in heavy sea . . .	50 miles	12 amps.
Submarine submerged, with top of loop near surface, and running at full speed . . .	12 miles	6 amps.
Submarine submerged with top of loop nine feet below surface . . .	3 miles	6 amps.

By means of relations established between the received signal strength and the depth of submergence, a comparison can be worked out between the transmission of radio signals entirely over sea and the transmission of the same signals to a submarine vessel at various depths, and in this way it is possible to ascertain at what depth signals can be received at various distances from a given transmitting station by using the ordinary type of wave transmission formula.

Radio Waves Penetrate 125 Feet of Rock
RADIO messages were received recently



© Kadel & Herbert

A FIRST-AID RADIOPHONE

This portable inductive radio set, designed for rescue work in mines, caissons and submarines, requires no ground or aerial, and the entire electrical power is furnished by small dry batteries. The inventor, Bernaye Johnson, reports that he has taken his apparatus 200 feet down into a coal mine and was heard clearly on the surface of the earth.

A Radio Method for Geologists

AMONG possible applications of radio to the study of rocks and ore deposits, a subject which POPULAR RADIO has already discussed on several occasions,* is a simple method described in a recent article by Professor Courant, of the University of Göttingen, Germany.† During the war Professor Courant was engaged in some studies of the ground-conduction telephone system—the so-called T. P. S. system—for the German Army.§ His present paper is a belated result.

The method which he suggests consists in determining the paths of flow of the alternating, ground-conducted field which goes out from a doubly-grounded transmitter. The transmitter may be merely a buzzer circuit, with both ends grounded. The detector is a combination of two coils, one oriented in a north-south plane, the other in an east-west plane. The coils are on

*See, for example, "Finding Mines by Radio," POPULAR RADIO, for September, 1924, pages 238-245.

†"On Variable Low-Frequency Currents in the Earth and Some Questions of Geophysics" (in German), by R. Courant. *Die Naturwissenschaften* (Berlin), volume 14, pages 61-64 (January 22, 1924).

§On the T. P. S. system, as used by the United States Army, see "Underground Radio Telegraph," by S. R. Winters. POPULAR RADIO for May, 1924, pages 490-492.

wooden frames about one yard square. Both ends of each coil are grounded. The north-south coil has one end grounded to the north, the other to the south. The east-west coil is similarly grounded; one end to the east, the other to the west. Mounded on the same axis as these two coils is a third coil, which can be rotated, like the coil of a radio-compass. In the circuit of this coil is a telephone. When thus arranged, the position of this inner coil which gives the minimum sound in the telephone indicates the direction of the audio-frequency field moving through the ground.

Professor Courant moves this receiver and the transmitter from place to place in the area to be examined, or, more conveniently, he uses a number of transmitters and a number of receivers. Thus he plots the paths of the lines of force through the surface soil of the area. These paths are not affected, he reports, by the superficial conductivity of the ground (as altered, for example, by rain). On the other hand, they are controlled largely by the geological nature of the country, the underlying rocks, the presence of faults and folds, and the like. He believes that methods along this line might be of service in geological surveys. Service in agricultural soil surveys is equally possible.

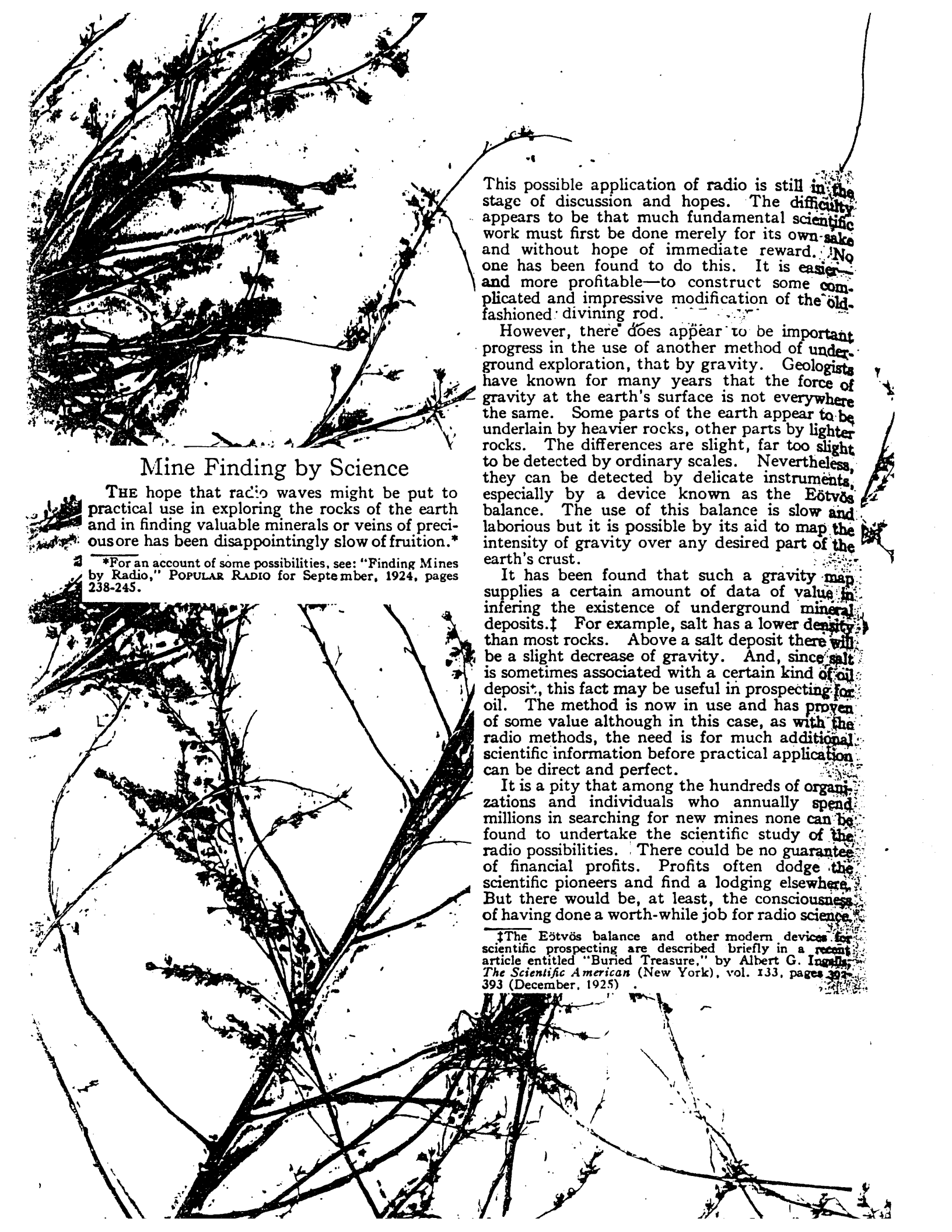

Mine Finding by Science

THE hope that radio waves might be put to practical use in exploring the rocks of the earth and in finding valuable minerals or veins of precious ore has been disappointingly slow of fruition.*

*For an account of some possibilities, see: "Finding Mines by Radio," POPULAR RADIO for September, 1924, pages 238-245.

This possible application of radio is still in the stage of discussion and hopes. The difficulty appears to be that much fundamental scientific work must first be done merely for its own sake and without hope of immediate reward. No one has been found to do this. It is easier—and more profitable—to construct some complicated and impressive modification of the old-fashioned divining rod.

However, there does appear to be important progress in the use of another method of underground exploration, that by gravity. Geologists have known for many years that the force of gravity at the earth's surface is not everywhere the same. Some parts of the earth appear to be underlain by heavier rocks, other parts by lighter rocks. The differences are slight, far too slight to be detected by ordinary scales. Nevertheless, they can be detected by delicate instruments, especially by a device known as the Eötvös balance. The use of this balance is slow and laborious but it is possible by its aid to map the intensity of gravity over any desired part of the earth's crust.

It has been found that such a gravity map supplies a certain amount of data of value in inferring the existence of underground mineral deposits.† For example, salt has a lower density than most rocks. Above a salt deposit there will be a slight decrease of gravity. And, since salt is sometimes associated with a certain kind of oil deposit, this fact may be useful in prospecting for oil. The method is now in use and has proven of some value although in this case, as with the radio methods, the need is for much additional scientific information before practical application can be direct and perfect.

It is a pity that among the hundreds of organizations and individuals who annually spend millions in searching for new mines none can be found to undertake the scientific study of the radio possibilities. There could be no guarantee of financial profits. Profits often dodge the scientific pioneers and find a lodging elsewhere. But there would be, at least, the consciousness of having done a worth-while job for radio science.

†The Eötvös balance and other modern devices for scientific prospecting are described briefly in a recent article entitled "Buried Treasure," by Albert G. Ingalls, *The Scientific American* (New York), vol. 133, pages 392-393 (December, 1925)

FINDING MINES BY RADIO

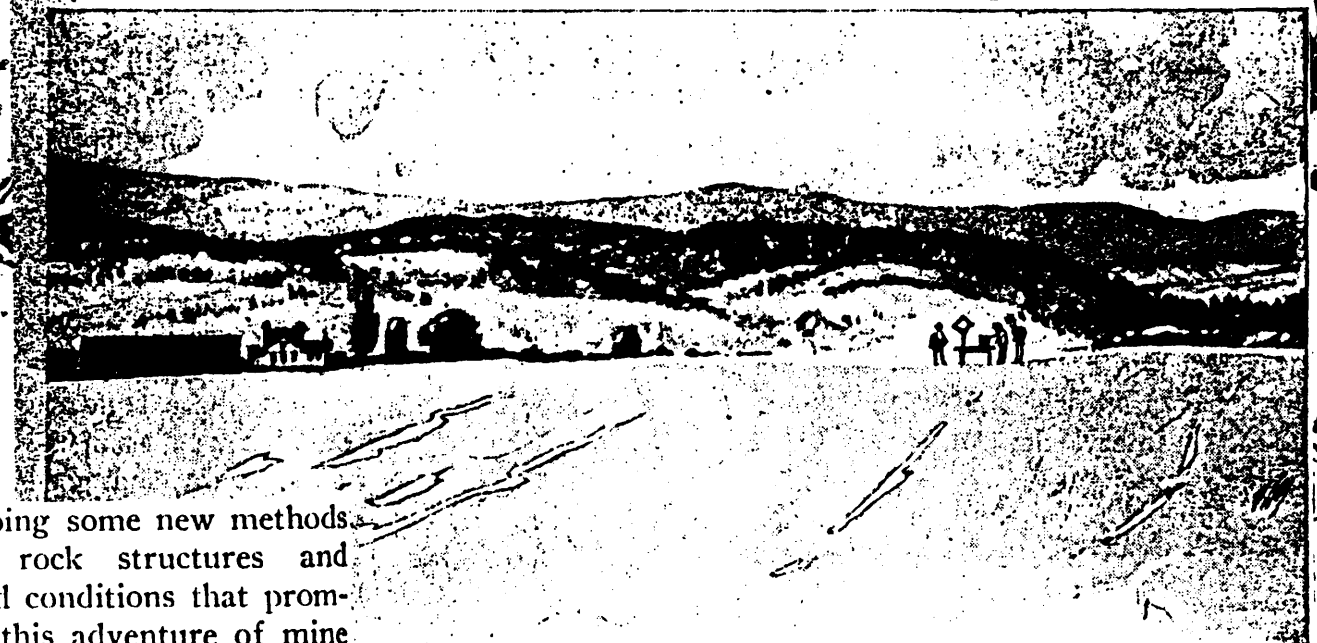

From a drawing made for POPULAR RADIO by Arthur Merrick

Science is developing some new methods of investigating rock structures and other underground conditions that promise much help in this adventure of mine finding. The most promising ones are radio methods. It is distinctly probable that the prospector, wandering around with his burro and his pick-pointed hammer, will give place in a year or two to a radio engineer riding on a wagon-

HOW RADIO CAN HELP US TO SEE UNDERGROUND

Radio waves sent out from a transmitter in one part of an existing mine can be received in other parts of the mine or by parties on the surface of the ground, and will furnish much information about intervening ore bodies, the existence of which is unknown.

load of coils and batteries and condensers. If anything is ever to improve the stumble-over-it method of King Solomon it

is probable that radio will be that thing.

This would be an extraordinarily important benefit to civilization.

Why is this? Have all the great mines been discovered?

No one believes it. There are probably a hundred bonanza ore bodies waiting to be discovered for every one that has been found. But they are not, perhaps, quite so evident on the surface of the ground. These unfound bonanzas are buried under barren rocks

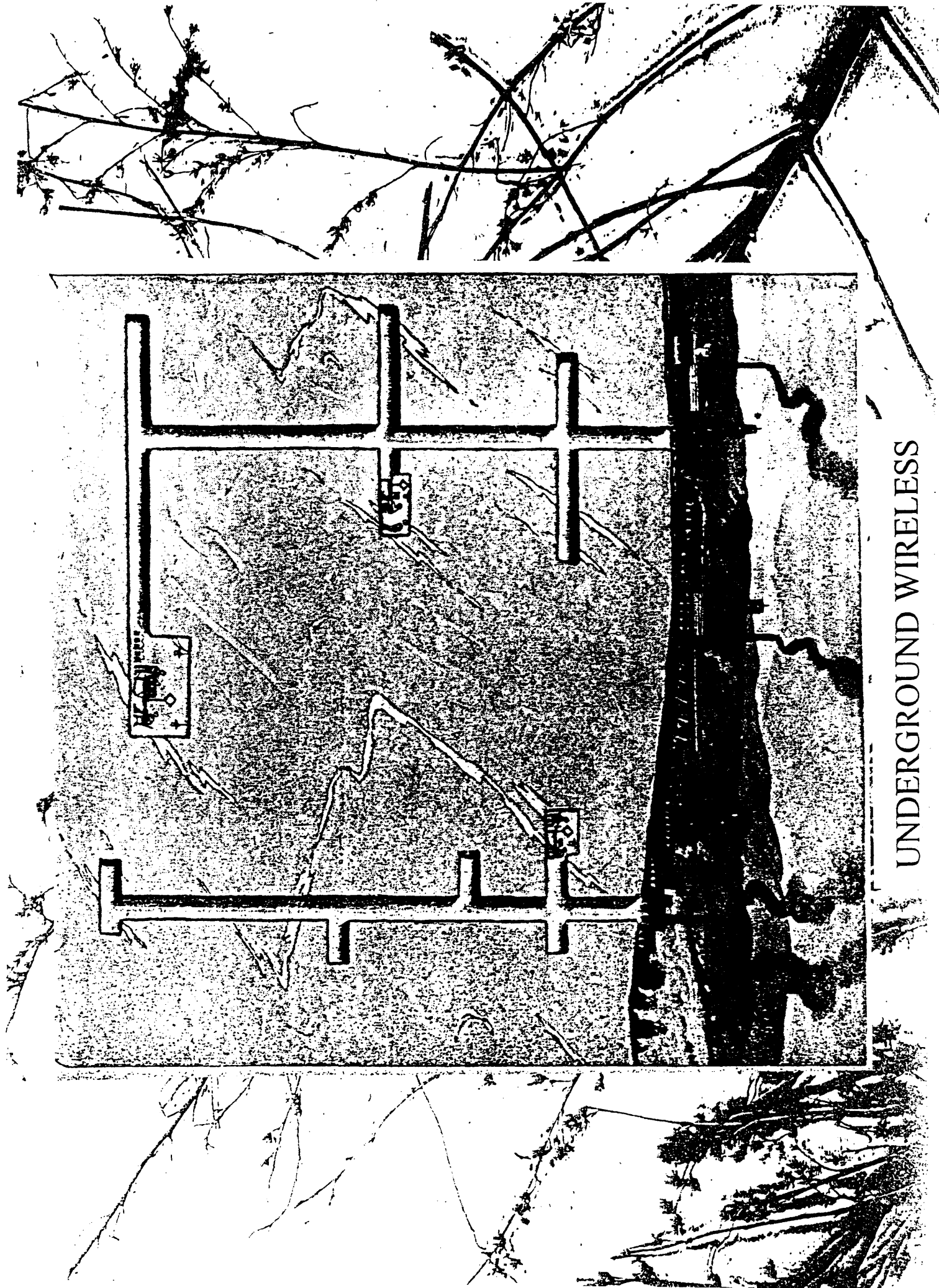

UNDERGROUND WIRELESS

CONCLUSIONS AS TO VALUE OF RADIO COMMUNICATION

In summing up the status of radio as a means of underground communication in times of disaster one can only repeat what has been said at the beginning of the chapter. Radio does not solve the underground communication problem, primarily not because the radio waves will not penetrate the earth (which they do to a considerable extent, depending inversely on the conductivity of the overburden), but because in the present state of development the apparatus is much too bulky for use under mine rescue conditions.

Although signals have been received in mines at some depth in the eastern part of the United States where these experiments were made, the reception was strongly suspected to have been carried into the mine through open shafts and over the wiring and piping systems. Any actual penetration of strata was thus drowned out by that received from the shafts and metallic conductors. In some of the Western States, however, there is considerable evidence of actual penetration of overburden. It should be noted, however, in this connection that the States in which this penetration was apparently obtained have an arid or semiarid climate. This, of course, means a dry overburden and a considerable increase in radio penetration. It is not believed, however, that this penetration is strong enough to permit the use of sufficiently simple and light receiving sets to allow even one-way communication under conditions required in mine rescue work.

Line radio offers no advantage for mine communication over the regularly installed mine telephones now in use. For both systems a break in the line destroys communication. Moreover, the line radio requires much more intricate and bulky apparatus. Therefore, line radio is evidently a much poorer method for mine communication than the ordinary telephone system after mine disasters.

Ground-conduction experiments deal with a signal system variously known as "ground conduction," "ground telegraphy," and, in military parlance, "T. P. S." The latter term, which, for brevity, will be used in this paper, comes from the French phrase "telegraphie par sol" (telegraphy through the ground).

The T. P. S. system was used widely by the Allies in the World War, and the apparatus used in the ground-conduction tests was largely that obtained from the United States Army Signal Corps. This apparatus consists primarily of induction-coil and ground connections operated by a battery as the transmitter, and head phones with similar ground connections as the receiver.

The T. P. S. system requires no metallic connection between the transmitting and receiving stations but differs from radio telegraphy in that the electrical energy is conducted through the ground at low frequency instead of through the air at high frequency. The frequency used in T. P. S. is 500 to 1,800 cycles per second, while that for radio telegraphy is 100 to 3,000 kilocycles.

METHOD OF OPERATION

In signaling on the surface by the T. P. S. method the terminals of the induction coil are grounded by iron pegs driven into the earth 50 to 1,000 feet apart, depending upon the distance that it is desirable to send messages. The maximum distance given would easily permit sending signals 1 mile under favorable conditions. When the transmitter is sending electrical current through the earth between two points the current is distributed somewhat like magnetic lines of force between the poles of a horseshoe magnet. The receiver may be considered a voltmeter having two grounded terminals approximately parallel to those of the transmitter. If the receiver is set up within the range of the conducting area, it will register the drop along the lines of current flow between its two terminals.

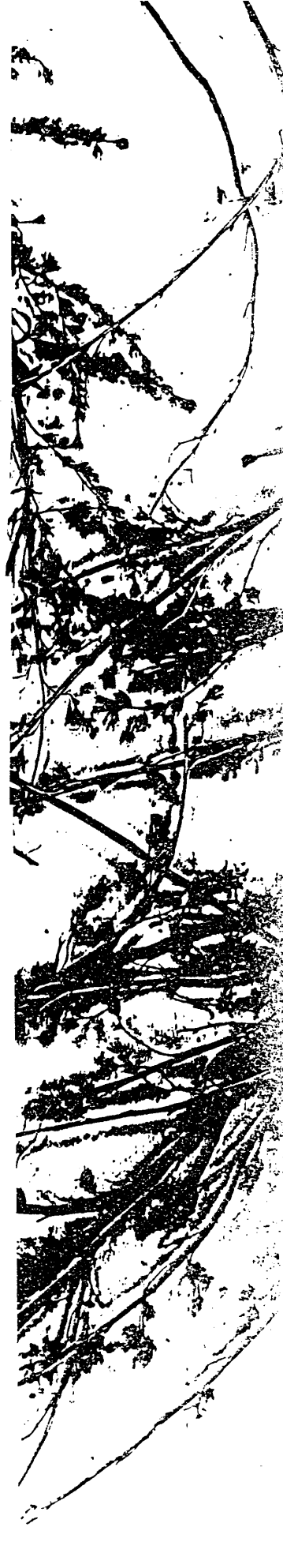

Inside the mine the grounds were plates laid on the solid floor, and wet floor dirt was placed on them to afford good conduction for the signal currents. One of these grounds was at the face of room 4 and the other in the airway about 650 feet from the entrance. The inside grounds were thus the same distance apart as the outside and parallel to them. The inside grounds were connected in series with

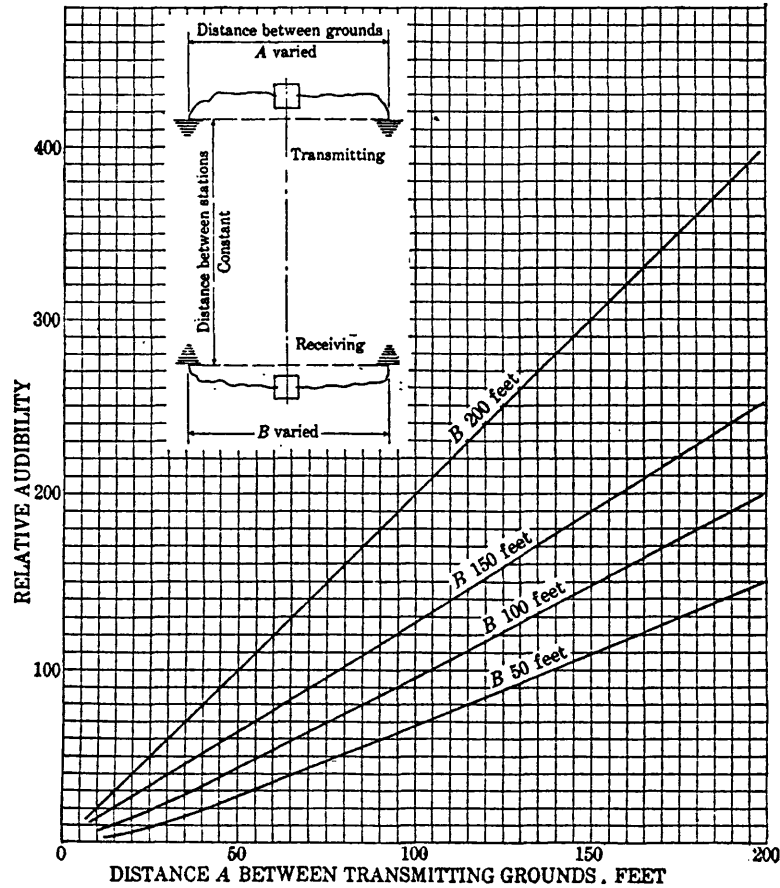

FIGURE 16.—Effect of distance between grounds

the transmitting apparatus by a suitable length of fixture wire by way of one of the butts.

The procedure was as follows: For transmission, it was only necessary to operate the transmitter as in previous tests. For reception, first the grounds were placed and connected to the line taps at the first station near the airway entrance and reception was carried out in the boiler house. After each test it was necessary to change the receiving grounds for the next test and repeat as before.

The test consisted in taking relative audibility readings and recording them. Both stages of the amplifier were used.

TEST RESULTS

SURFACE TESTS

Figure 16 shows the results of the first series of tests, Figures 17 and 18 the results of the second series, and Figure 19 the results of the third series.

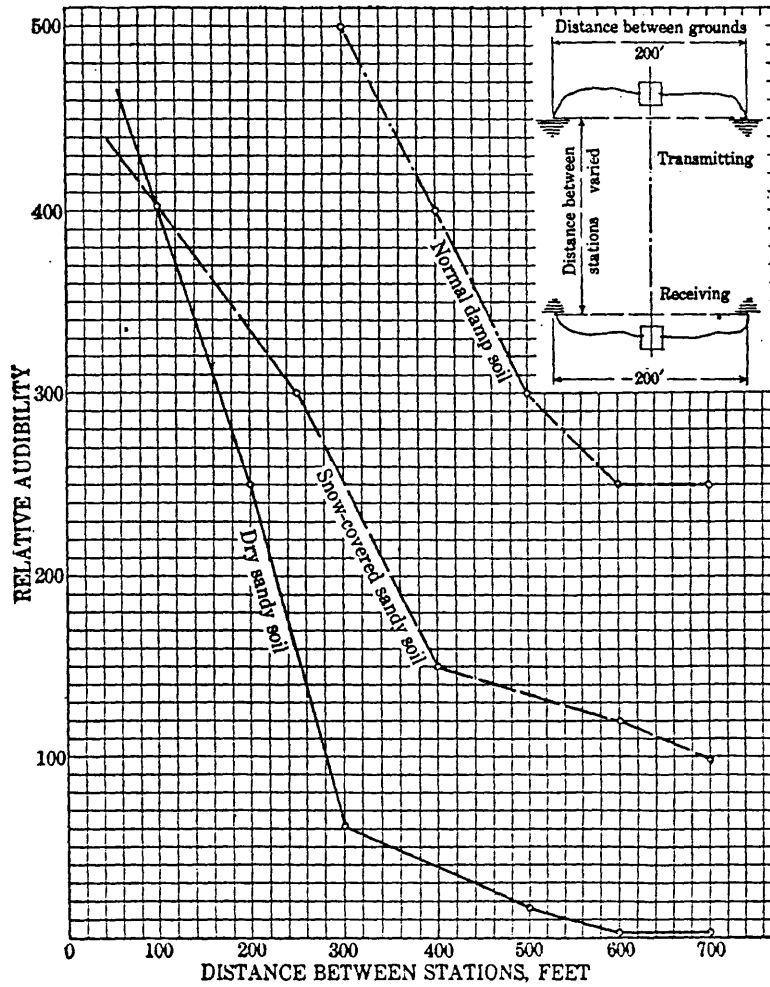

FIGURE 17.—Effect of distance between stations

UNDERGROUND TESTS

Figures 20 and 21 show the results of the tests using mine track and Figure 22 the results of the modified track experiments.

Figure 23 shows the results of the tests transmitting through the overburden at the experimental mine. The tests with both the service buzzer and the 10-watt amplifier were successful in going through the strata at the experimental mine, but the signals were not

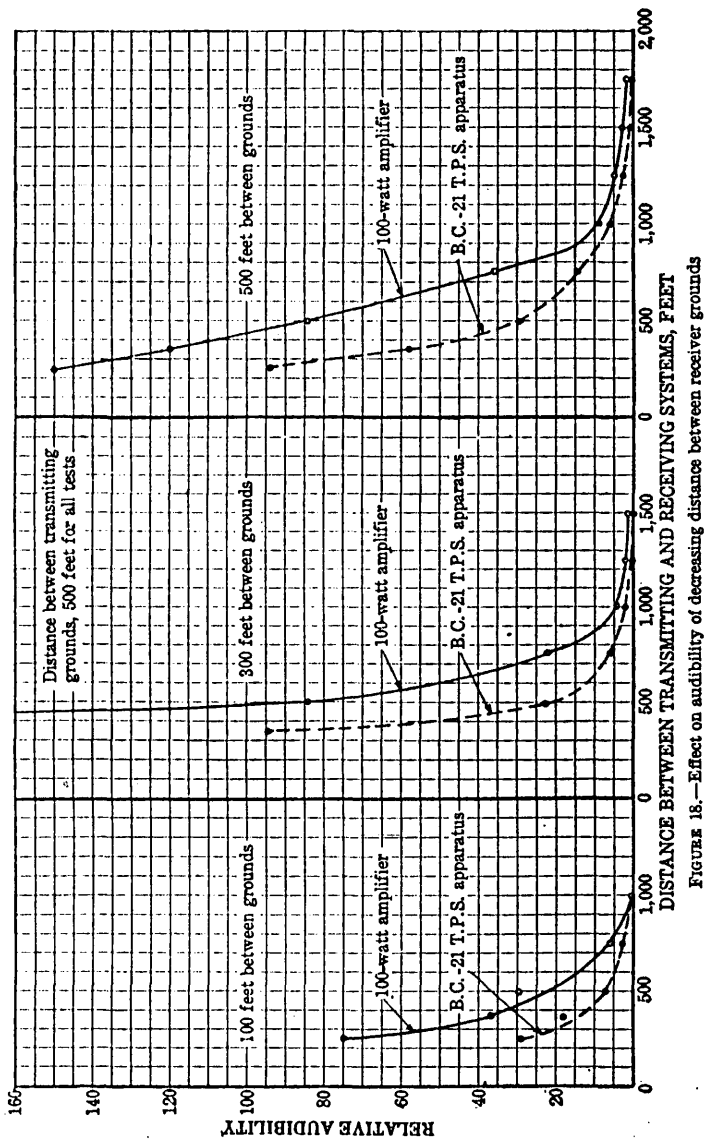

FIGURE 18.—Effect on audibility of decreasing distance between receiver grounds

as strong as with the B. C.-21 T. P. S. set. The peg ground in the coal seemed to give particularly poor transmission.

The results of the tests transmitting in the Terminal No. 3 mine to the surface were successful under the conditions of the test.

Figure 24 shows the results of the special tests at the experimental mine and Figures 25 and 26 the results of the special tests at Terminal No. 3 mine.

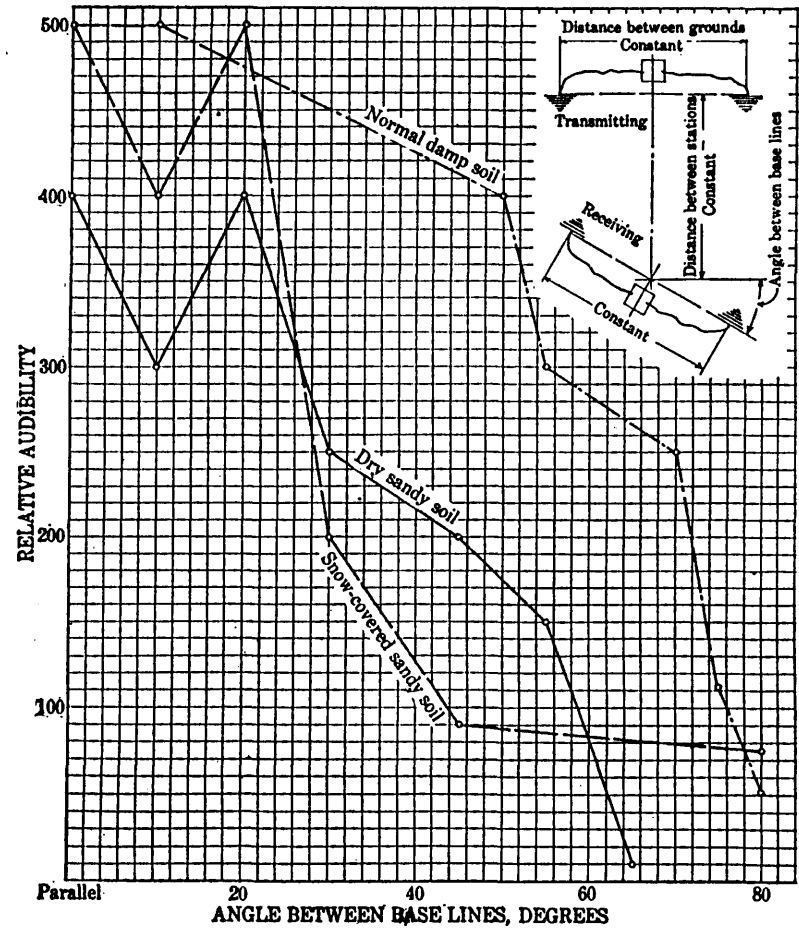

FIGURE 19.—Effect of angle between stations

DISCUSSION OF RESULTS

SURFACE TESTS

In some of the tests only one peg was used for each ground connection in receiving, because there did not seem to be any difference in the reception whether one peg or three were used. This can be readily understood when it is remembered that the currents which actuate a telephone receiver are very small; thus the change in resistance between one and three pegs is not noticeable.

It is interesting to note from Figure 18 that the 100-watt transmitter gave approximately twice the signal strength of the B. C.-21 T. P. S. set at a given distance. This ratio was maintained fairly consistently throughout the tests.

The curves indicate that the surface range of the T. P. S. method of transmission varies almost directly with the distance between the respective ground terminals.

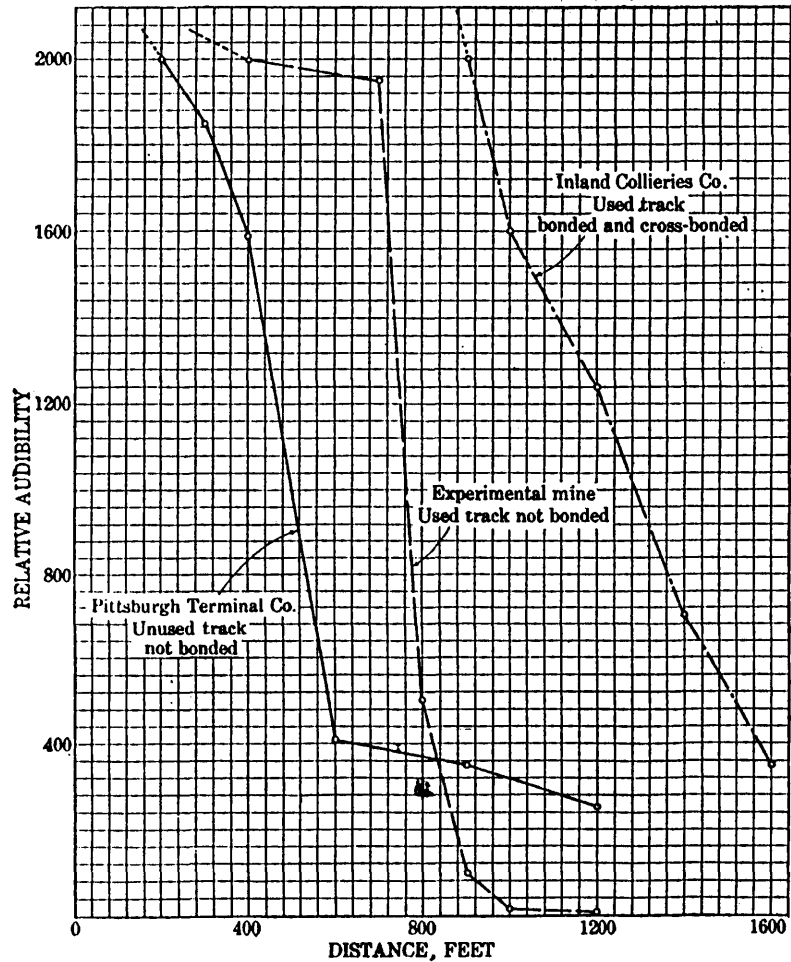

FIGURE 20.—Transmission along car rails

Figure 19 indicates that the strongest signals are received when the lines of the transmitter and receiver grounds are parallel. As the angle between these lines approaches a right angle the signal strength or audibility decreases abruptly, although the audibility varies widely with surface conditions.

UNDERGROUND TESTS

The tests using track transmission showed that with bonded track reception was possible over considerable distances. Strangely, cross bonding did not seem to cause any difficulty. Cars on the track

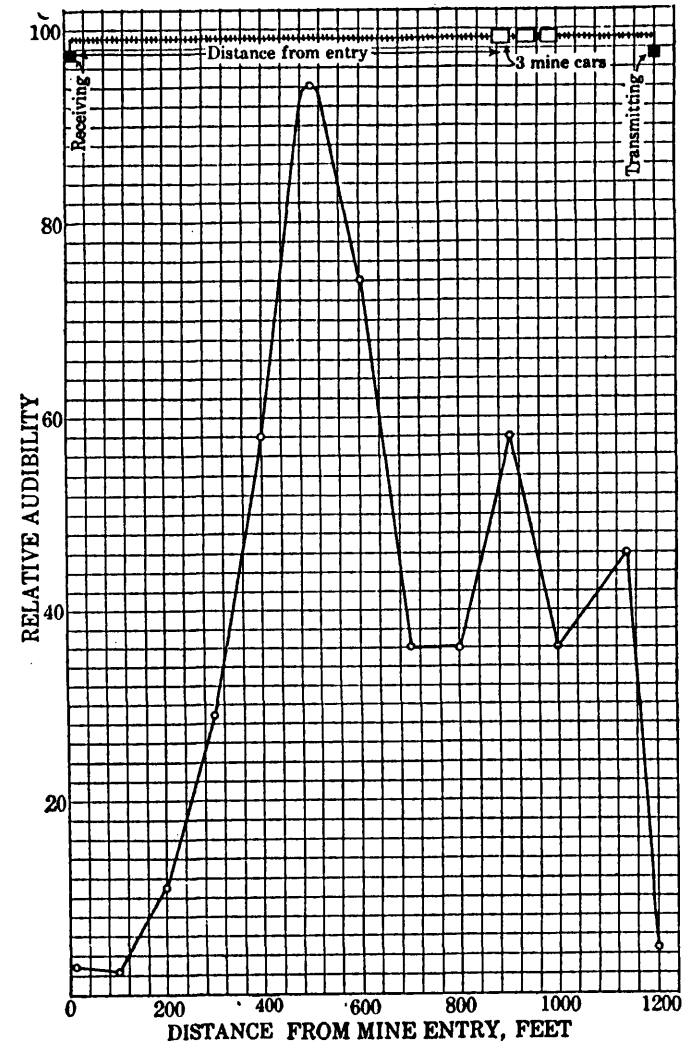

FIGURE 21.—Effect of mine cars on transmission along car rails

during the tests did not have very much effect until they were close to either transmitter or receiver.

In the tests with modified track conduction the curve shows that water connecting the track and the ground in the mine decreases the

strength of signals appreciably. The tests involving transmission through the overburden at first appeared to be successful; those at the

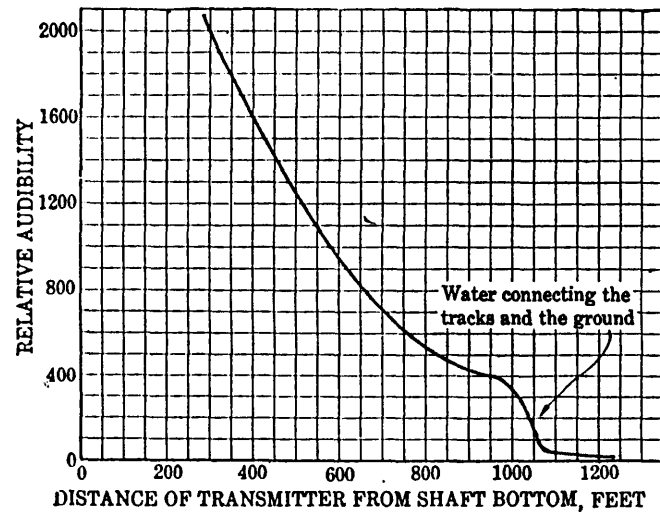

FIGURE 22.—Decrease in audibility with increase in distance from receiving station. (Modified track transmission, see fig. 14, B)

experimental mine especially seemed to show the actual penetration of overburden. The fact that this mine is shallow and contains considerable piping and two boreholes lent some doubt to the sup-

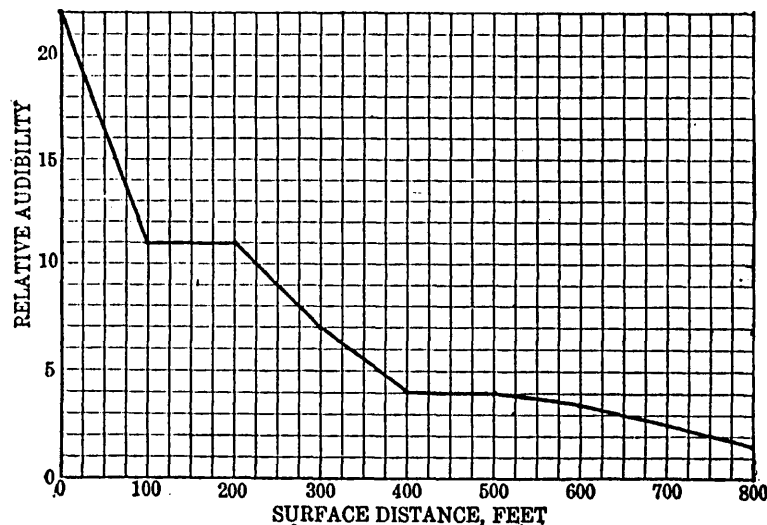

FIGURE 23.—Decrease in audibility with distance from transmitter

position that transmission was wholly through the strata. The fact that signals were received at Terminal No. 3 mine only when the

apparatus was close to the shaft confirmed this doubt. Therefore, it was decided to make some special tests at these two mines to find to what extent signals were carried by pipes, rails, rail return cables, up shafts, and shallow parts of the mine.

SPECIAL TESTS

The special tests at Terminal No. 3 mine seemed to show that the signals came up the shaft by way of a circuit, probably composed of the rail return cable and the shaft walls, instead of through the overburden. Tests made with both transmitter and receiver a rela-

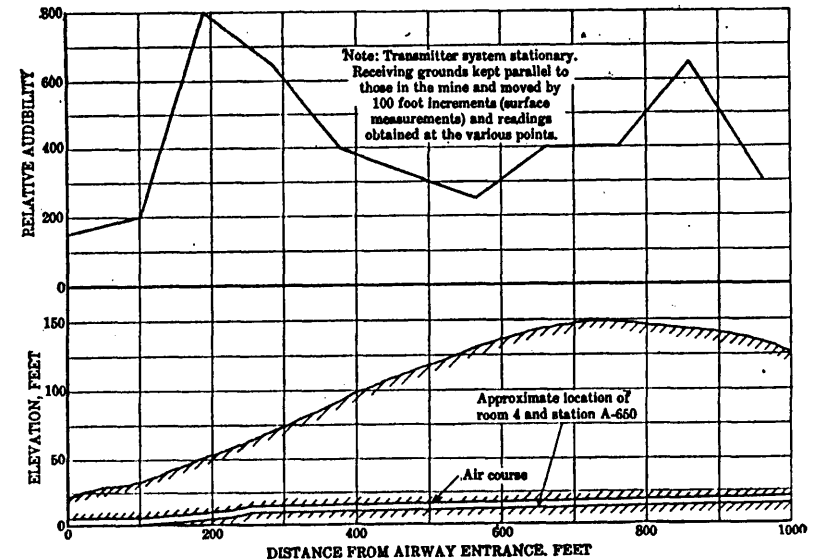

FIGURE 24.—Transmitting T. P. S. signals from inside experimental mine through overburden

tively short distance away from the shaft resulted in no signal, and moving either the transmitter grounds (in mine) or one receiving ground away from the shaft opening made the signals decrease rapidly.

Tests at the experimental mine showed that the strongest signals were received near the mine entrance and at the end of the entries. At the latter place the mine is approximately half as deep as over the transmitting set. It is probable that a considerable part of the signal current came out at these points, and being concentrated it showed relatively high audibility. The currents would however spread out over the surface from these points and would therefore be relatively weak between them.

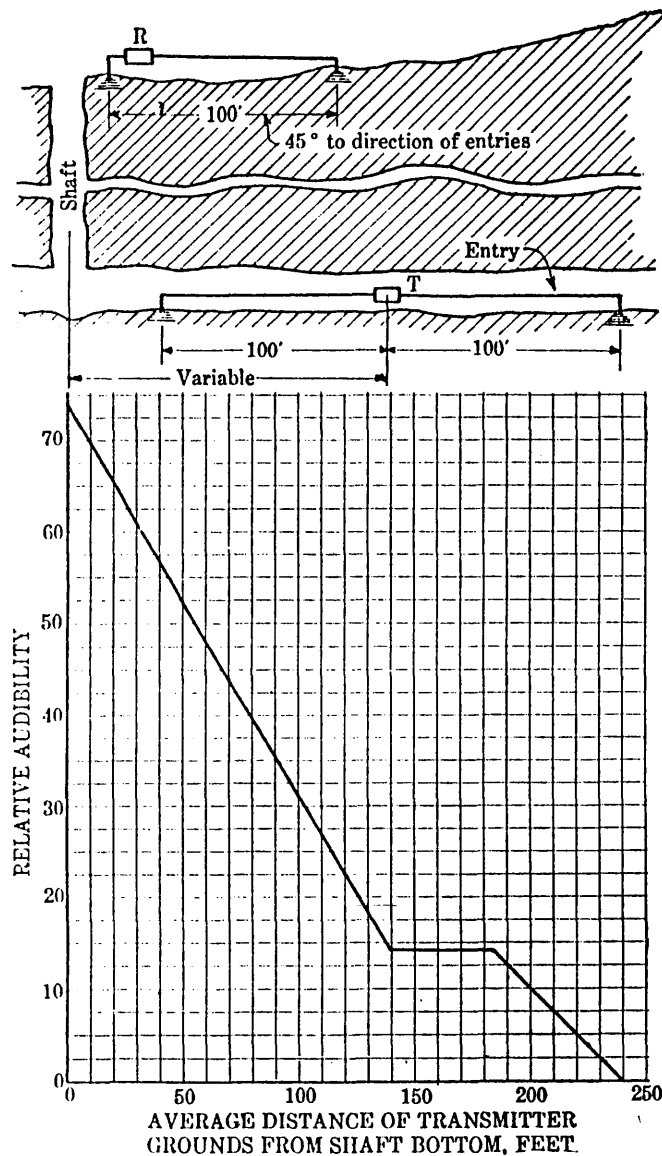

FIGURE 25.—Effect on audibility of increasing distance between transmitting and receiving stations

CONCLUSIONS AS TO VALUE OF GROUND CONDUCTION FOR COMMUNICATION

The ground-conduction or T. P. S. method is primarily for surface communication. The transmitted currents flow from one terminal to the other of the transmitter along the surface and do not penetrate the earth to any great distance.

The modified T. P. S. using rails and combinations of track and earth connections is better than the straight T. P. S., but the power requirement is too great and the range is still too limited and too variable to be practical.

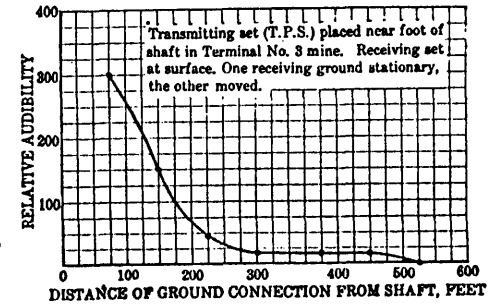

FIGURE 26.—Relation between audibility and distance between receiving grounds

EXPERIMENTS WITH TELEPHONES

HYPOTHESIS

During certain experimental work with the T. P. S. apparatus the possibility of obtaining signals by connecting a source of electrical potential vertically across the coal bed suggested itself. As coal has a comparatively high resistance, it would offer considerable opposition to a flow of electrical current. It was therefore believed that if one terminal were connected to a point above the coal bed, such as the rock roof or that part of the bed adjacent to the roof, and the other to a point between the coal bed and the mine floor, such as the rock bottom, mine rail, or sump, the paths of current flow might spread out to such an extent that some of them might reach the surface, where they might be picked up by a telephone receiver connected to suitably placed grounds. Accordingly, experiments in transmitting with a Signal Corps service buzzer were made and proved so successful that it was decided to try voice-modulated currents instead of buzzer-modulated currents.

NATURE OF TESTS

The tests are described under two heads—preliminary tests at the experimental mine and tests at the Indianola mine. The preliminary work involved finding the most efficient position for the ground connection in the mine above the coal, so as to take full advantage of the drop in voltage vertically across the coal—that is, between the mine roof and the mine floor (or rails or piping). In addition, it was necessary to discover the best apparatus and the best combination of apparatus for transmission and reception.

EARTH CONDUCTION EXPERIMENTS.

The Burial of the Loop Antenna
SCIENTISTS have been telling us that the familiar aerial, rising like a mast above the home of the radio fan, is doomed. Now they are burying the more modern loop antenna also—not, however, because it is obsolete, but because placing it underground increases its efficiency, as Mr. Dodge points out:

During the World War the United States Signal Corps and the Bureau of Standards made an exhaustive study of the properties of the loop aerial, and it is chiefly due to their development work that the loop aerial is used so much today. In their research work the Bureau of Standards discovered that the loop antenna was the best kind of aerial for diminishing atmospheric disturbances, or static, which sometimes renders a receiving station almost useless.

One successful method of eliminating these strays is the use of buried loops. In this method of lessening static a movable loop aerial is suspended in an underground room. When this is done the receiving set must also be placed in the underground room.

A regular aerial may be used with the underground loop and this is connected to the primary of the receiving transformer

which is connected to the earth. The secondary of the instrument is connected to the rest of the apparatus with the underground loop hooked up in series with one side of this circuit. It is interesting to note that the loops may be under water as well as under land, the liquid acting as a shield and having the same effect as the earth.

Not only may messages be received by means of the loops, but signals have been transmitted up to certain distances. With an ordinary antenna the transmitted waves are materially affected by surrounding objects, such as trees, mountains, buildings. This distorts the static or magnetic field, or both, and causes a variation of the determined direction from the true direction. The shielded underground loop greatly reduces the error resulting from this cause.

There is a great field for amateur experimentation in the use of buried aeri-als. Without going to the trouble of erecting a loop aerial, the interested amateur may simply dig a trench about a foot deep and lay some number fourteen insulated copper wire in the excavation and lead one end of the wire to the receiver. Signals with great directional effect can be heard with an antenna of this sort. Of course, in preparing for reception from a certain station, the underground wire should be pointed in that direction, that is, it should be laid out in a straight line with the lead-in wire at the end pointing to the station to be received.

Not only may messages be copied with insulated wire, but experiments prove that bare wire can be used. This seems astounding because in this case the wire is grounded, but still radio waves can be detected; and little difficulty should be experienced in picking up signals up to one hundred miles, employing one audion tube.

In the summer time when the static is bad, excellent results may be obtained in receiving the long-distance, high-powered land stations by making use of the directional property of the underground aerial or loop with a two- or three-step amplifier. It is much simpler to operate the underground loop than the buried aerial, as it is easily rotated on a pivot to the proper direction for maximum reception; in the case of the buried aerial the amateur has to constantly change the direction of the wire to secure the proper intensity of the signal.

Of all the different types of aeri-als used, the loop offers the greatest field for amateur research work. In time to come, when radio will possibly be developed so that two persons may converse by voice and not be overheard by anyone, the loop aerial will undoubtedly play an important part. The loops are being used more and more every day, especially by persons living in apartments in the city where overhead wires are "taboo." There may come a time when all amateur and commercial aeri-als will be constructed beneath the earth, with no exposed wires at all.

HERBERT WARREN DODGE

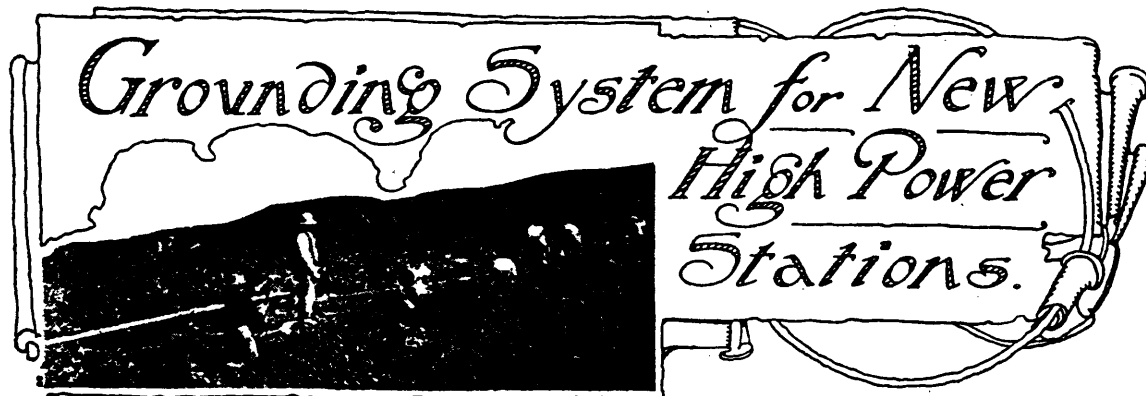

NE of the essential parts of the long distance stations is an effective grounding system. An idea of the importance of a thorough ground connection may be had by noting the extent of the system adopted by the Marconi Company and the precautions taken to get the best possible earth connection.

In selecting the sites for the erection of the stations a number of elements had to be considered carefully. The location required for the transmitting site and receiving site had to be more than twenty miles apart and co-related in such a manner that a line connecting them would be at right angles to the direction of desired transmission. The sites had to be chosen on low, marshy land on the coast, or near some waterway that would afford a direct electrical connection with the ocean.

These two essentials to location were difficult to find in the sites available, so where it was not possible to get the whole property in a marshy location it was necessary to have the land around the power house at least damp and moist. Then, by burying a network of copper wires and zinc ground plates a good electrical earth connection was possible.

With the middle of the oscillating circuit as a center, wires radiate to a circle of zinc plates at a radius of 100 feet. This circle is continuous, all the plates being bolted together, and buried vertically in a trench so

that the radiating wires can be led down to the ground and soldered to the upper edge of the zinc ring. From the center of the system about two hundred and twenty-four copper cables, made up of stranded copper wire, are led from two sides of the building through insulators to the top of eight poles set on a circle of eighty feet radius. From the insulators on the top of these poles the cables are separated and led down to the earth and soldered to points along the circle of zinc plates. The location of the eight poles and the separation of the cables is so arranged that the length of each cable from the center of the system to the point it enters the ground is approximately the same.

Radiating from the ring of zinc plates there are about one hundred and twelve copper cables soldered to the ring at equal distances. Each of these cables extends about three hundred feet beyond the zinc ring and terminates in a zinc plate thirty inches by eighty-four inches, buried vertically. From these outer plates, on the side of the circle under the aerial wires, extends a further grounding system parallel to the aerial and extending under its full length and a little beyond.

The foregoing description applies to the transmission stations in general, but in each particular case local conditions usually make it necessary to alter the arrangement slightly to obtain a grounding system equally effective. Thus the location of the power station at New Brunswick, New Jersey, is situated in a swampy

meadow and bounded by the Delaware and Raritan canal on the northeast side. Running beside the canal is a stream connected to the Raritan river by culverts under the canal. In view of this condition it was deemed advantageous at this station to straighten out one side of the circle of zinc plates and bury a large number of plates in the bed of the stream, by this means assuring a good electrical connection through the Raritan river with the ocean.

At the receiving stations the grounding system follows the same general arrangement as at the transmitting stations, but its scope is not nearly so extensive. The circle of ground plates is made with a fifty foot radius, with the receiving room of the operating house as the center. The only wires extending beyond the circle of zinc plates are a number of cables radiating from the center and extending in a marsh or waterway near which the operating house is situated. These lines each terminate in a zinc plate as at the transmitting site.

A precaution which is essential in the construction of the power house and the running of all power and lighting circuits, is to run all lines in iron conduit and thoroughly ground the conduit at frequent intervals. If this precaution is not taken considerable difficulty might be caused by the current induced from the high frequency oscillating circuits. Whenever possible all circuits are carried underground, and especially the main power supply in stations where the power is supplied by a commercial power company. The supply is run in conduit underground for about half a mile and approaches the power plant in a direction at right angles to the direction of the aerials.

Woman Operator Marries

Miss Nellie O'Farrell, of San Francisco, who has gained considerable notice as one of the first women wireless operators in the world, has retired from the operator's field. She was married recently.

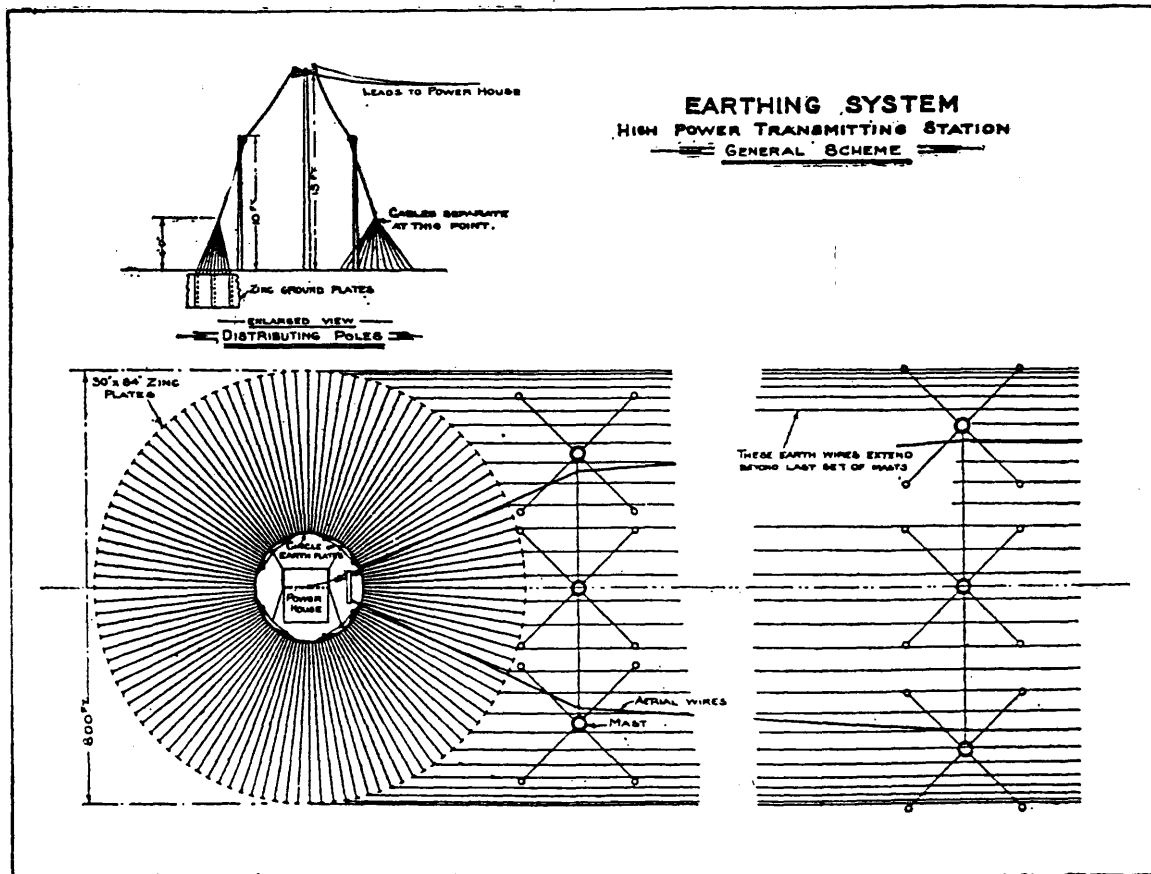

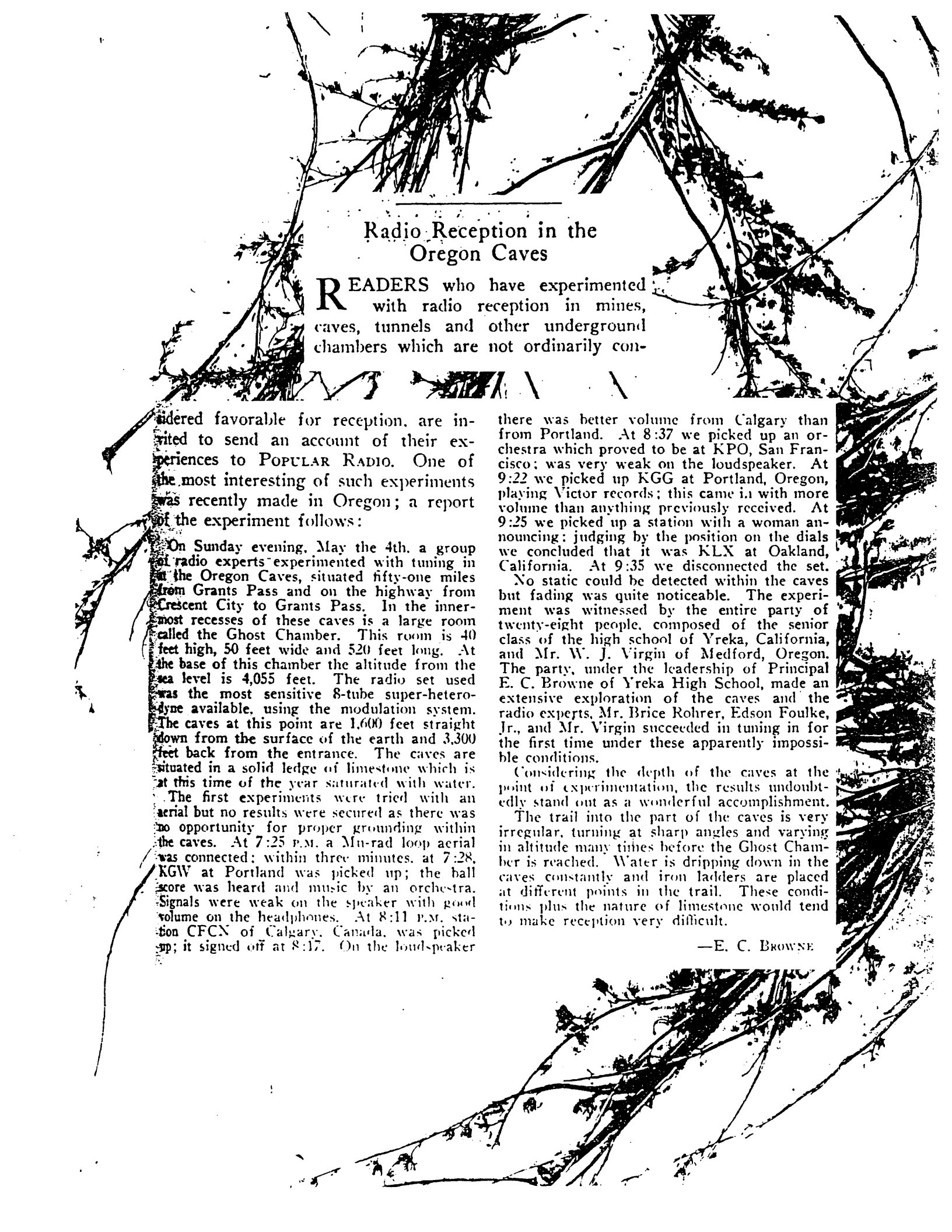

Radio Reception in the Oregon Caves

READERS who have experimented with radio reception in mines, caves, tunnels and other underground chambers which are not ordinarily con-

sidered favorable for reception, are invited to send an account of their experiences to POPULAR RADIO. One of the most interesting of such experiments was recently made in Oregon; a report of the experiment follows:

On Sunday evening, May the 4th, a group of radio experts experimented with tuning in at the Oregon Caves, situated fifty-one miles from Grants Pass and on the highway from Crescent City to Grants Pass. In the innermost recesses of these caves is a large room called the Ghost Chamber. This room is 40 feet high, 50 feet wide and 520 feet long. At the base of this chamber the altitude from the sea level is 4,055 feet. The radio set used was the most sensitive 8-tube super-heterodyne available, using the modulation system. The caves at this point are 1,600 feet straight down from the surface of the earth and 3,300 feet back from the entrance. The caves are situated in a solid ledge of limestone which is at this time of the year saturated with water.

The first experiments were tried with an aerial but no results were secured as there was no opportunity for proper grounding within the caves. At 7:25 p.m. a Mu-rad loop aerial was connected; within three minutes, at 7:28, KGW at Portland was picked up; the ball score was heard and music by an orchestra. Signals were weak on the speaker with good volume on the headphones. At 8:11 p.m. station CFCN of Calgary, Canada, was picked up; it signed off at 8:17. On the loudspeaker

there was better volume from Calgary than from Portland. At 8:37 we picked up an orchestra which proved to be at KPO, San Francisco; was very weak on the loudspeaker. At 9:22 we picked up KGG at Portland, Oregon, playing Victor records; this came in with more volume than anything previously received. At 9:25 we picked up a station with a woman announcing; judging by the position on the dials we concluded that it was KLX at Oakland, California. At 9:35 we disconnected the set.

No static could be detected within the caves but fading was quite noticeable. The experiment was witnessed by the entire party of twenty-eight people, composed of the senior class of the high school of Yreka, California, and Mr. W. J. Virgin of Medford, Oregon. The party, under the leadership of Principal E. C. Browne of Yreka High School, made an extensive exploration of the caves and the radio experts, Mr. Brice Rohrer, Edson Foulke, Jr., and Mr. Virgin succeeded in tuning in for the first time under these apparently impossible conditions.

Considering the depth of the caves at the point of experimentation, the results undoubtedly stand out as a wonderful accomplishment.

The trail into the part of the caves is very irregular, turning at sharp angles and varying in altitude many times before the Ghost Chamber is reached. Water is dripping down in the caves constantly and iron ladders are placed at different points in the trail. These conditions plus the nature of limestone would tend to make reception very difficult.

—E. C. BROWNE



* * *

Radio Waves 2,200 Feet Below the Earth

ANY question remaining that radio waves penetrate to great depths into the earth seems to be pretty well answered by the success of Meade W. Powel, an amateur of Warren, Ariz., in picking up a distant naval station while 2,200 feet below the earth's surface. He had no success with bare copper wire nor with a loop, but when he tried 100 feet of lead-covered No. 14 copper wire cable strung along the mine gallery midway between the roof and the floor, NPL, 400 miles distant, came in on a three-tube regenerative outfit, although a five-tube radio frequency set wouldn't percolate at all. Maybe it was freak reception, but the experiment is interesting because no means has yet been devised for two-way communication of a continuous order in the interest of saving lives and keeping in touch with entombed miners when a disaster takes place. The main problem, of course, is to overcome the rapid deterioration due to dampness, which breaks down insulation.

* * *

Bureau of Mines officials in the experimental mine operated by the Government near Pittsburgh. The new use of radio is expected to effect a revolution in the methods of rescuing entombed miners.

"We are trying," said James W. Paul of the Bureau, "to find out if communication can be established with miners who are a mile or more under ground, through the covering of rock, usually at least several hundred feet thick. Fire and other accidents easily put a telephone line out of service, but if radio communication can be maintained we will always have a way of reaching men quickly."

I was on a brief visit to Oudtshoorn, and had brought with me from Cape Town a Marconiphone six-valve set (five high-frequency), and a Marconiphone two-stage amplifier, having set out to privately experiment on the train journey. Whilst in Oudtshoorn I suddenly conceived the idea of attempting reception in the Congo Caves of wireless telephony, broadcast from Cape Town, about four hundred miles away, and from Johannesburg, about eight hundred miles away. So far as the general public and the broadcasting stations were concerned, I kept my intended visit quiet, feeling sure that I was on a wild goose chase, having regard to the nature of the country to be negotiated, not to speak of the fact that I was diving into the heart of a mountain.

Erecting the Aerial

My little party, in two motor-cars, arrived at the caves a few minutes after eight o'clock at night. Each member of the party was given something to carry, and the long narrow passage, with the steps down to the floor of Van Zyl's Hall, were quickly left behind, and we crossed over to the far side of the Hall. The erection of the aerial was the easiest thing I have ever done in that line, one end being secured to a stalactite on one side of the chamber, and the other to a rope fastened to a similar ready-made mast on the other side. A piece of water piping was driven into the ever moist floor.

coniphone wireless set and its attendant paraphernalia it would be not only difficult, but dangerous—for the six valve set. The footway is slippery, Tunnels just admitting a fairly stout individual have to be negotiated on all fours, there is a slide down a sloping flat rock into the dark unknown, and also a "chimney" to be climbed. It will therefore be readily understood why, when I took a wireless receiving set into the Congo Caves recently, I called a halt in Van Zyl's Hall, a chamber about five hundred feet from the entrance to the caves. When I say that in this chamber I erected a regulation size single-wire aerial, one hundred feet, across a segment of the hall, which is almost circular, readers will realise its size. The height, I may say, is proportionate to the width.

Wonderful Reception

Our doubts were soon at rest. Strange to say, the first words heard by wireless in the Congo Caves were "Cape Town calling," (Cape Town has no abbreviated call sign). There we were, four hundred miles from the broadcasting station, well underground, and yet, on the loud speaker, we got the most perfect wireless music I have ever heard. Oudtshoorn is known for its supply of atmospherics, and we heard all about them the next day from owners of sets, but, in our weird surroundings, there was an almost complete absence of them. I got as far from the loud speaker as I could, that is, just about the length of the aerial, and every word of a talk on "Angling" could be heard distinctly. The old guide told me that many European singers have tried their voices in this same hall, and have remarked on its wonderful acoustic properties. Johannesburg, eight hundred miles distant, was next tuned in, again with unlooked for success. It was all too wonderful, almost too wonderful to be true. "J.B." came through with good, healthy, loud-speaker strength though a station of weaker power than Cape Town, and there was no mistake about it, we could help ourselves to whichever station we wanted.

CAPACITY LOOP AERIALS

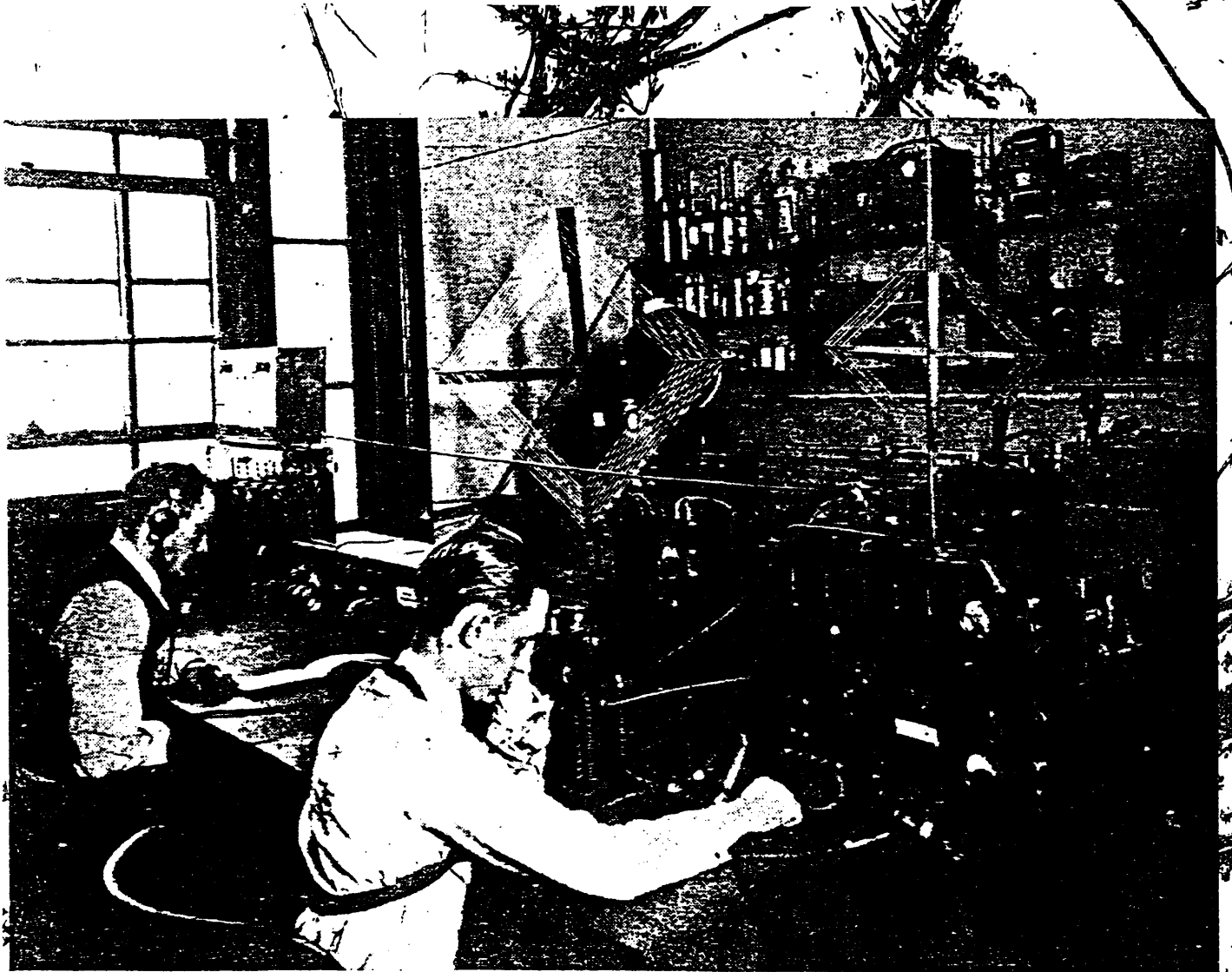

Henry Miller

RADIO SETS FOR COMMUNICATING UNDERGROUND

While miners pursue their work far beneath the earth's surface, radio apparatus such as this is employed to maintain constant communication with the outside world. The apparatus shown here is employed by the Bureau of Mines in tests which aim to perfect this type of communication.

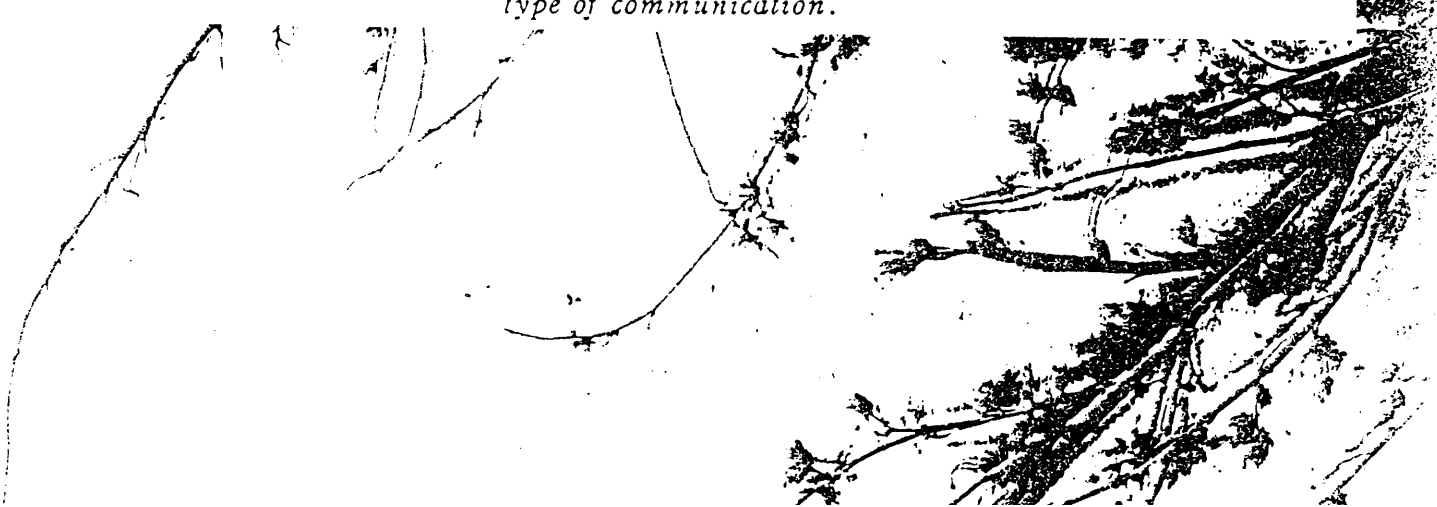

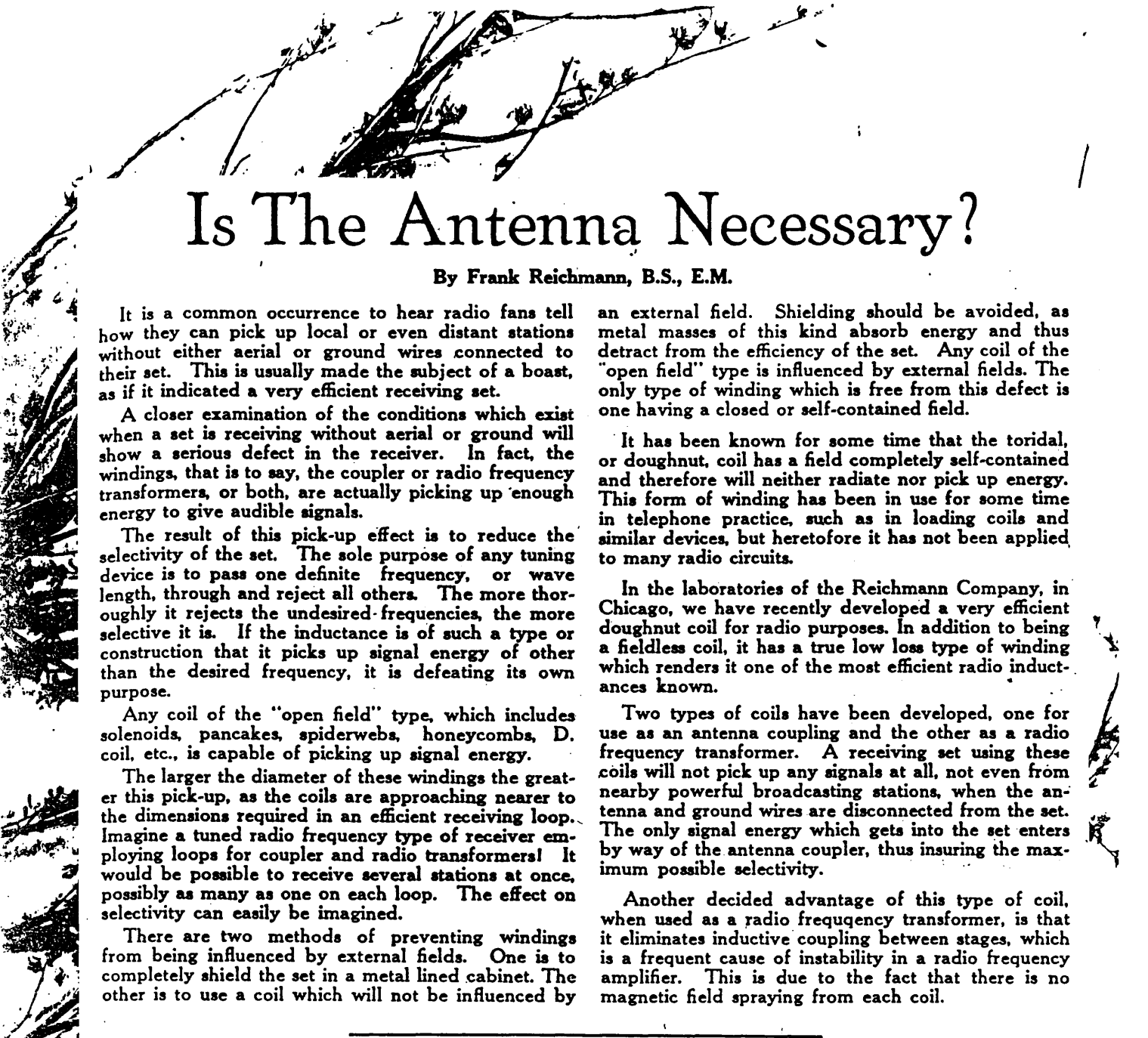

Is The Antenna Necessary?

By Frank Reichmann, B.S., E.M.

It is a common occurrence to hear radio fans tell how they can pick up local or even distant stations without either aerial or ground wires connected to their set. This is usually made the subject of a boast, as if it indicated a very efficient receiving set.

A closer examination of the conditions which exist when a set is receiving without aerial or ground will show a serious defect in the receiver. In fact, the windings, that is to say, the coupler or radio frequency transformers, or both, are actually picking up enough energy to give audible signals.

The result of this pick-up effect is to reduce the selectivity of the set. The sole purpose of any tuning device is to pass one definite frequency, or wave length, through and reject all others. The more thoroughly it rejects the undesired frequencies, the more selective it is. If the inductance is of such a type or construction that it picks up signal energy of other than the desired frequency, it is defeating its own purpose.

Any coil of the "open field" type, which includes solenoids, pancakes, spiderwebs, honeycombs, D. coil, etc., is capable of picking up signal energy.

The larger the diameter of these windings the greater this pick-up, as the coils are approaching nearer to the dimensions required in an efficient receiving loop. Imagine a tuned radio frequency type of receiver employing loops for coupler and radio transformers! It would be possible to receive several stations at once, possibly as many as one on each loop. The effect on selectivity can easily be imagined.

There are two methods of preventing windings from being influenced by external fields. One is to completely shield the set in a metal lined cabinet. The other is to use a coil which will not be influenced by

an external field. Shielding should be avoided, as metal masses of this kind absorb energy and thus detract from the efficiency of the set. Any coil of the "open field" type is influenced by external fields. The only type of winding which is free from this defect is one having a closed or self-contained field.

It has been known for some time that the toroidal, or doughnut, coil has a field completely self-contained and therefore will neither radiate nor pick up energy. This form of winding has been in use for some time in telephone practice, such as in loading coils and similar devices, but heretofore it has not been applied to many radio circuits.

In the laboratories of the Reichmann Company, in Chicago, we have recently developed a very efficient doughnut coil for radio purposes. In addition to being a fieldless coil, it has a true low loss type of winding which renders it one of the most efficient radio inductances known.

Two types of coils have been developed, one for use as an antenna coupling and the other as a radio frequency transformer. A receiving set using these coils will not pick up any signals at all, not even from nearby powerful broadcasting stations, when the antenna and ground wires are disconnected from the set. The only signal energy which gets into the set enters by way of the antenna coupler, thus insuring the maximum possible selectivity.

Another decided advantage of this type of coil, when used as a radio frequency transformer, is that it eliminates inductive coupling between stages, which is a frequent cause of instability in a radio frequency amplifier. This is due to the fact that there is no magnetic field spraying from each coil.





From a photograph made for POPULAR RADIO

HE MADE A "MISTAKE" THAT LED TO A DISCOVERY

When Ashley Hewitt found that he could receive signals with the antenna disconnected, he started experiments that brought results described below.

THE combination of ingenuity and a bit of luck sometimes leads to interesting results. Here is a letter from a fan who is not afraid to experiment:

Like most amateurs, I had been bothered a great deal by the larger wireless stations, particularly NAH and WNY, which broke in on the broadcasting and on the amateur work. I was unable to tune them out.

However, my problem is now solved, and, as is often the case with novices, I arrived at the solution entirely by accident. When I set up my two stage amplifying set, I used as a ground the discontinued city gas line which was left intact when electricity was put in the house. This seemed to work perfectly well, but I was still annoyed by NAH and others.

I was working with another amateur, trying to receive his signals, but was unable to get him; he suggested that I would get better results in any case if I grounded on the city water line. Accordingly I did this and found the strength of the signals vastly improved, as well as the clearness. Still I was bothered by the same trouble.

It was while listening to the 2XJ-KDOW tests that I made my "economical" mistake. I noticed that I could hear NAH with the antenna disconnected and the set tuned in.

This started me fooling with the antenna and

ground connections. Trying everything that I could, just to see what would happen, I put the wire which I had attached to the gas-pipe on the antenna terminal while the ground terminal was connected to the city water line. NAH was going at the time as well as 2XJ, but as soon as I made this accidental connection they both disappeared. On tuning up a little higher I heard 2XJ clearly but not NAH. The signal was a little weaker but it was worth it to have all the interference out.

Attaching the gas-pipe to the antenna in this way seems to have the effect of putting a condenser of great capacity in the antenna circuit.

There are several other effects that should be spoken of in case anyone else wishes to try it. First, it reverses the tuning of the Vernier condenser—that is, instead of tuning around 0 to 20 degrees, I have to start from the other end at 100 and tune towards 80. It also shifts the point of tuning on the regenerative dial; this moves upwards about 20 degrees. The wavelength is also moved up higher about 3 degrees. Another advantage is that it increases the sharpness of tuning enormously; I find that in the amateur range I can practically cut all signals except those on identically the same wavelength. The adjustment is so fine that I will have to put micrometer adjusting screws on the dial to be able to get the signals I want.

I am using this hook-up entirely now.

ASHLEY HEWITT

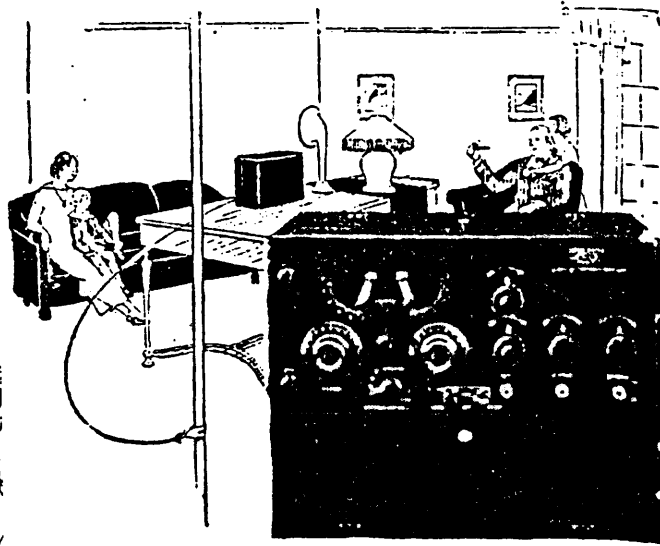

—hook it to the waterpipe

Moon "Satterlee Antennaless" Radio will produce wonderful results simply connected to a waterpipe. No antenna, loop or indoor wire is necessary.

Stations within a conservative 1000 mile radius are regularly received with a non-power loud speaker on this set.

It is the ideal set for use in apartments, automobiles, yachts or railroad trains where an antenna is not practical. Extremely sensitive, unusually selective, yet simple to operate.

*Write today for our folder
"California or Newark"*

MOON RADIO CORPORATION
501 Steinway Ave., Long Island City, N. Y.

In Canada: Continental Equipment Co., Ltd., New
Birks Bldg., Montreal, Quebec

MOON
Satterlee
antennaless
—RADIO—



Pacific & Atlantic

THE NEW SUBMARINE RECEIVER

This new set, which uses an underwater antenna for radiophone communication between submerged submarines, has recently been developed by scientists in the Naval Research Laboratories at Belleue, D. C.

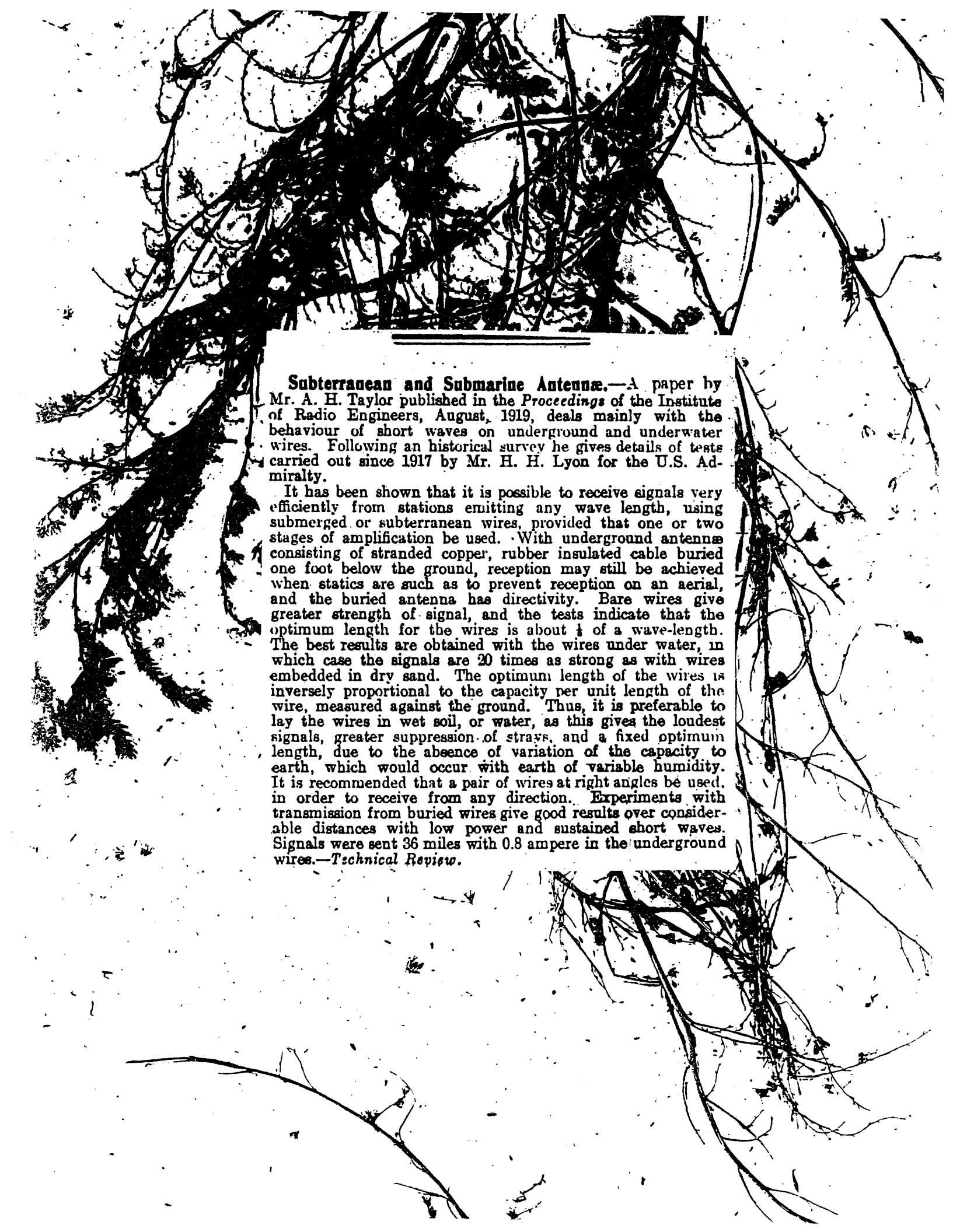

Subterranean and Submarine Antennæ.—A paper by Mr. A. H. Taylor published in the *Proceedings* of the Institute of Radio Engineers, August, 1919, deals mainly with the behaviour of short waves on underground and underwater wires. Following an historical survey he gives details of tests carried out since 1917 by Mr. H. H. Lyon for the U.S. Admiralty.

It has been shown that it is possible to receive signals very efficiently from stations emitting any wave length, using submerged or subterranean wires, provided that one or two stages of amplification be used. With underground antennæ consisting of stranded copper, rubber insulated cable buried one foot below the ground, reception may still be achieved when statics are such as to prevent reception on an aerial, and the buried antenna has directivity. Bare wires give greater strength of signal, and the tests indicate that the optimum length for the wires is about $\frac{1}{4}$ of a wave-length. The best results are obtained with the wires under water, in which case the signals are 20 times as strong as with wires embedded in dry sand. The optimum length of the wires is inversely proportional to the capacity per unit length of the wire, measured against the ground. Thus, it is preferable to lay the wires in wet soil, or water, as this gives the loudest signals, greater suppression of strays, and a fixed optimum length, due to the absence of variation of the capacity to earth, which would occur with earth of variable humidity. It is recommended that a pair of wires at right angles be used, in order to receive from any direction. Experiments with transmission from buried wires give good results over considerable distances with low power and sustained short waves. Signals were sent 36 miles with 0.8 ampere in the underground wires.—*Technical Review*.



Kadel & Herbert

A GLASS-INCLOSED RECEIVER

The noted doctor and X-ray specialist, Dr. F. L. Satterlee, demonstrates a set using his circuit that is claimed to work without an antenna. The theory of operation is based upon a tuned-ground system.

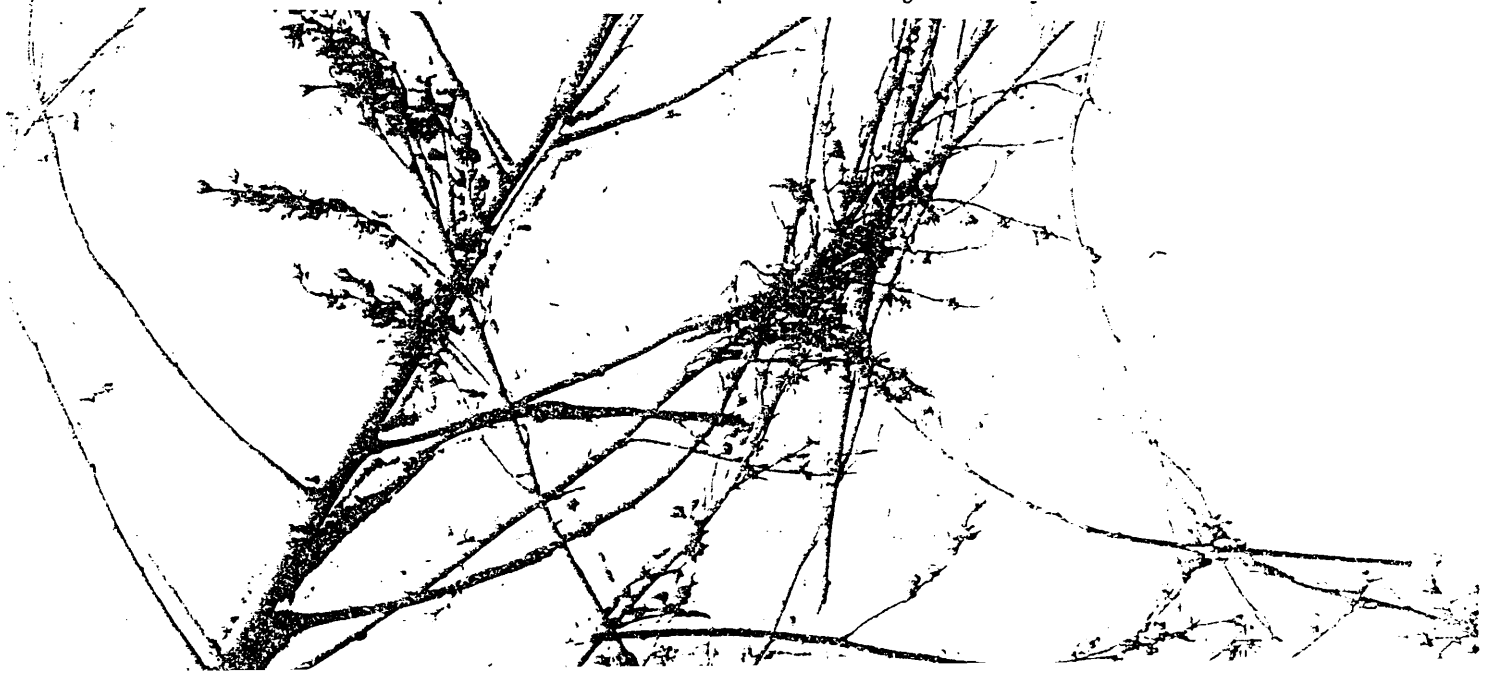

**NO AERIAL, EARTH
OR ACCUMULATORS
REQUIRED.**

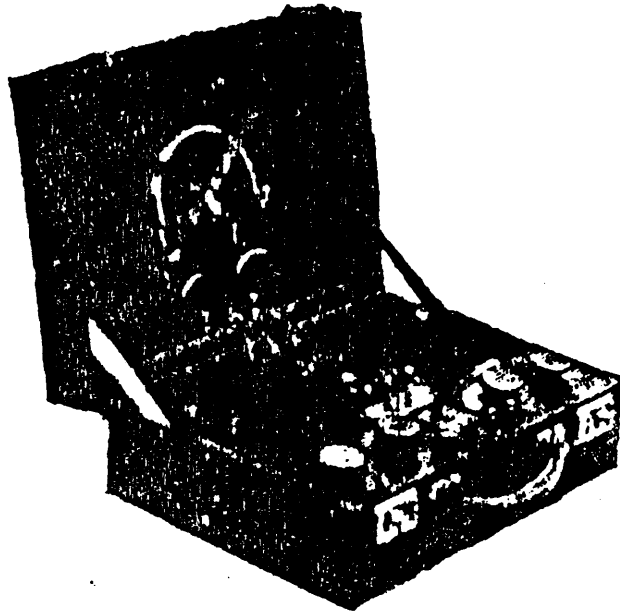

The "Rolls" Portable

THE SIMPLEST, NEATEST, CLEVEREST,
MOST EFFICIENT AND MOST PORTABLE
2 OR 3-VALVE SET IN THE WORLD.
EXQUISITELY FINISHED AND FITTED IN
A REAL HIDE CASE. Size 15 by 11 by 5 ins.

PRICE **£14 14 0**

COMPLETE. ALL READY FOR USE AND
MARCONI ROYALTIES PAID.

Demonstrations anywhere at any time.

3-Valve Model, guaranteed to work a loud-
speaker really well anywhere within 10 miles
of a Broadcast Station. Price \$18 18s. 0d.
No Extras.

H. LLOYD MARSHALL & CO.

8, WESTMORELAND BUILDINGS,
ALDRSGATE ST., E.C.1.

GOOD TERMS TO THE TRADE.



When an Aerial Wire is "Earthed"

In the case of an aerial wire which is "earthed," or connected to the earth at the lower end, there is in addition to this space wave or wave in the ether an "earth" electric wave propagated through the crust of the earth. This is proved by the fact that a high collecting aerial is not absolutely necessary for reception in wireless telegraphy. The signals from the Eiffel Tower Wireless Station in Paris can be detected in London merely by using as collector any metallic mass, such as a galvanized iron dustbin, which is insulated from the earth, the receiver being connected between this mass and the earth.

In the case of long distance wireless telegraphy we are probably concerned with electro-magnetic waves of both types—viz., true electro-magnetic waves propagated through the ether around the earth, partly arriving directly and partly after reflection or refraction by masses of conducting air in the upper atmosphere. Also the effect reaches the distant station as an electro-magnetic wave which is propagated along the surface of the earth, in the same manner that it travels along a wire.

The terrestrial atmosphere is therefore the seat of waves of many kinds. We have not only long aerial waves in the air itself, produced by winds or explosions, but the co-existing ether waves of short wave length, about one fifty-thousandth of an inch in wave length, which constitute light. Then there are in addition frequent natural but irregular vagrant electric waves of great wave length, produced by atmospheric electric discharges, such as lightning, or created, it may be, by extra terrestrial causes, such as explosions in the sun. Lastly, there are the countless long electric waves now intentionally made in telegraphic work, which cause a turmoil in the former comparative ætherial calm.

The mysterious ether transmits all these waves with the same velocity of 300,000 kilometres per second. In order that it may do this the ratio of its elasticity to its density must be a least 3,600 million times greater than that of steel.

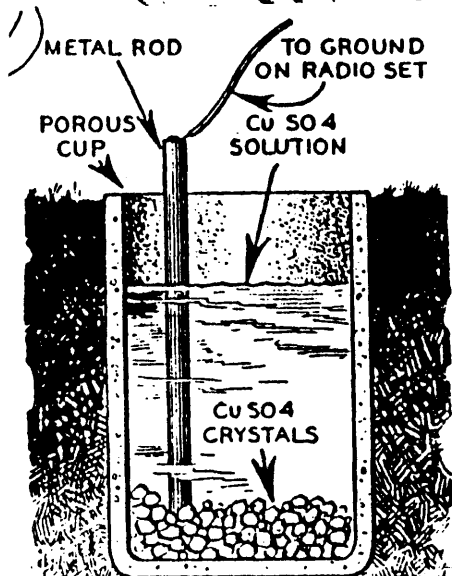

Porous Cup Ground Eliminates Crackling Noises

GALVANIC action between iron rod and ground sometimes causes ordinary grounded radio sets to emit terrible crackling noises. The difference in potential between rod and ground may sometimes be as high as 1,000 millivolts, and varies with electrical or magnetic disturbances in the earth.

A porous cup electrode buried in the earth, with no metallic part of the ground circuit touching the earth at any point, will entirely eliminate these crackling noises. Fill the cup with a concentrated solution of copper sulphate, and make contact to an iron or copper rod inside the cup. The copper sulphate seeps slowly through the cup into the ground, making excellent contact. The cup should be filled occasionally with the same solution. The resistance of this type of ground is usually around 400 ohms, but varies with the kind and moisture content of the soil. A ground of this type sets up absolutely no galvanic action, eliminating the problem of varying potential between rod and ground, and greatly improving radio reception.

EARTH NOISES AND THE FRAME AERIAL.

The Importance of Balancing Out Electrostatic Pick-up.

AN article in *The Wireless World* (September 14th, page 333) pointed out that the directional effect of a frame aerial could be considerably improved by centre-tapping the frame and connecting this tap to earth and to the valve filaments, as shown in the figure. The idea underlying this mode of connection is that the electrostatic pick-up, being more or less evenly distributed over the frame, should be balanced out, leaving an approximation to pure electromagnetic pick-up. The degree of success attained in eliminating the static pick-up can be gauged by the extent to which the local station can be eliminated by turning the frame into the position of minimum signals.

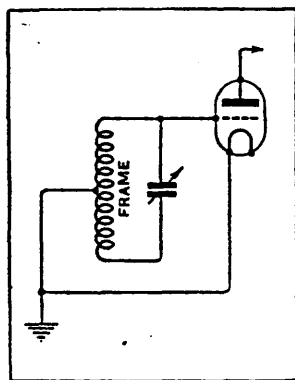

Frame aerial circuit giving comparative freedom from earth noises.

Those who live in large towns are very frequently annoyed by finding that all reception, save from the local station, is impossible, owing to the noises due to the electrical machinery which is now found everywhere. All moving electrically driven machinery, from a vacuum cleaner up to an electric train, seems to generate disturbances which are carried along the electric light mains ("wired wireless") for very considerable distances from their point of origin. These disturbances, which are usually classed together under the vague but inclusive title of "earth noises," make themselves known to the user of wireless receivers in the form of a wide variety of scratches, cracks, bangs, buzzings, and indeterminate uproar of all kinds whenever he ventures to tune in a station at any distance. In bad cases even the local station may have its programme punctuated by the louder of the noises, while every other station may be completely blotted out by a continuous roar. Since these noises are completely untuned, it is not possible to eliminate them by making the receiver ultra-selective.

Apparently, however, the majority of the noises are introduced into the receiver through electrostatic rather than electromagnetic pick-up, for if the frame aerial connections shown in the figure are employed, the ratio of noises to signals can be very considerably reduced. It is found that a frame, connected in the usual manner to the receiver, does not offer any very great relief from noise, but that if the connections shown in the figure are adopted, a very considerable improvement results. In bad cases it becomes necessary to extend the precautions beyond that of the simple centre tap by making the tapping on the frame, which must for this purpose be wound with bare wire, by means of a spring clip, adjusting its position carefully to give the minimum of interference.

Avoid Static Pick-up.

The lead from tuning condenser to grid, having no counterpart at the other end of the tuned circuit, must be shielded, which implies, in practice, that the tuning condenser must be within the set, and the whole enclosed in an earthed metal screen.

It is also essential to look very carefully after the leads connecting the two ends of the frame to the tuning condenser and to take every precaution to ensure that the static pick-up by them is identical. This could be achieved by using twin flex for the connections, but the high capacity between the wires makes it unsuitable.

A good method is to make a kind of rope-ladder, the two wires forming the uprights, while the rungs consist of ebonite or wood spacing strips. Alternatively, the two wires may be sewn into opposite edges of a piece of webbing, with the connection for the centre tap, if desired, down the centre.

These precautions may seem very elaborate, but it must be emphasised that half measures give but little relief from the earth noises, while a whole-hearted attack on them, on the lines laid down in the present note, will at the least make it possible to obtain some sort of entertainment from any station which, on an open aerial, is not so entirely blotted out by noise that its transmissions are unintelligible.

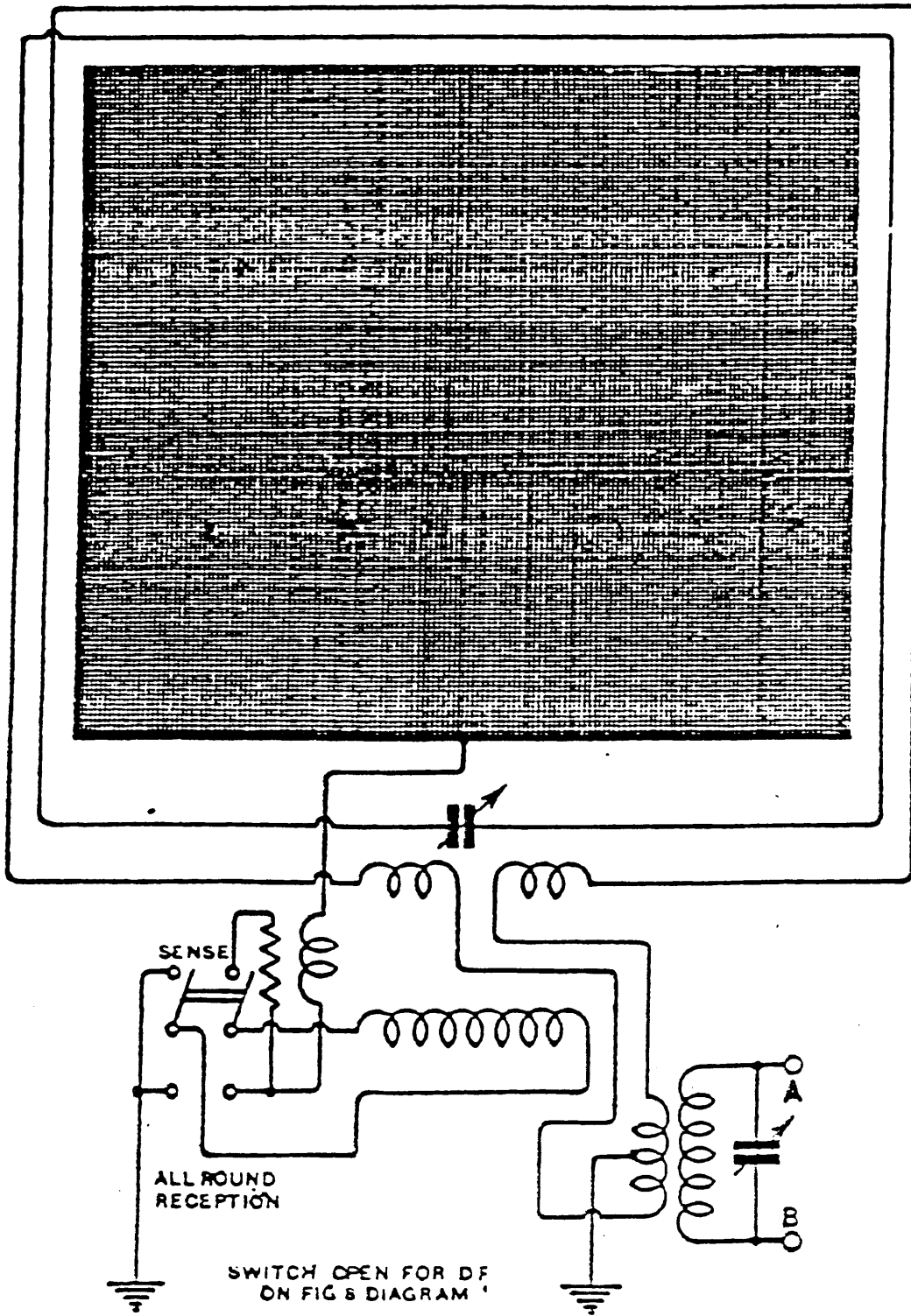

Switching device for obtaining either "All-Round" reception on the open aerial, [D.F. on the figure eight diagram or Sense Determination on the heart-shaped diagram.

EARTH COUNTERPOISE

July, 1923

MODERN WIRELESS

Experiments with Earthing Systems

By far the most interesting experiments have been made in connection with the earthing system. It is usually thought that if a good connection can be made to a waterpipe at the point where it enters the ground, and if the instruments are quite close to this point, very satisfactory results can be obtained. The writer was under the impression that very little could be done to improve his earth connection, but he decided to try a new scheme. In particular he has aimed at keeping the aerial and earth resistance as low as possible, even for reception.

had a bearing on the subject, tests were then made among the amateur 'phones on 440 metres and thereabouts. Here results were quite fifty per cent. better on the buried wires even with very strong signals from a station close at hand. Both weak and strong signals on this wave-length were much improved. On 200 metres results were still better and were almost equal to another valve. As previously pointed out, reaction on the aerial was not used in the tests.

Combining the waterpipe earth and the wires outside was tried in each case, but the combination turned out no better than the



Fig. 3.—Bird's-eye view of the aerial and buried earth wires.

The first new test was to pierce the window frame, fit a second lead-in insulator for the earth wire and then to take three long wires (new aerial wire)—one along each side of the garden and one up the middle of the lawn. These wires were simply laid on the bare ground and were connected through the lead-in insulator to the earth terminal. The waterpipe earth and the wires were then compared on received signals of different wave-lengths, and were found to be as good as one another, no perceptible difference being noticed. The tests were made in pouring rain and also while the ground was dry. No difference was observed in either case.

The wires were now buried in the ground at a depth of about two inches, two wires in the lawn and one in a flower bed. The arrangement of the wires is shown in Fig. 3, the drawing being roughly to scale. Comparisons between the waterpipe earth and the buried wires were then made. It was found that the tuning was not altered, even slightly, by the change.

Of the Dutch concert on Sunday afternoon there was nothing to choose between the two earths, but on 600 metres there was a very marked improvement by using the buried wires. As this suggested that wave-length

better of the two separately. So far no experiments have been made with a counterpoise earth (as such an arrangement is not convenient in the writer's garden), nor has a buried plate been tried. Readers who have buried plate earths may like to try the long wire method. A comparison should prove very interesting.

It is probable that insufficient attention has been given by experimenters to the position of the waterpipes relative to the aerial wires. In most cases the aerial is at the back of the house while the water mains run along the road in front, and the house connection is taken in a direction away from the aerial. If the waterpipes run *beneath* the aerial then better results will probably be obtained.

The writer does not claim any special importance for all these experiments. They are put forward merely to suggest to the beginner that it is just as well to try things for oneself, for probably results will vary at different stations. It is not wise to take the "other fellow's" word for too much, and by making experiments such as these new and improved aerial and earth arrangements may easily be found.

GROUND-CONDUCTION EXPERIMENTS

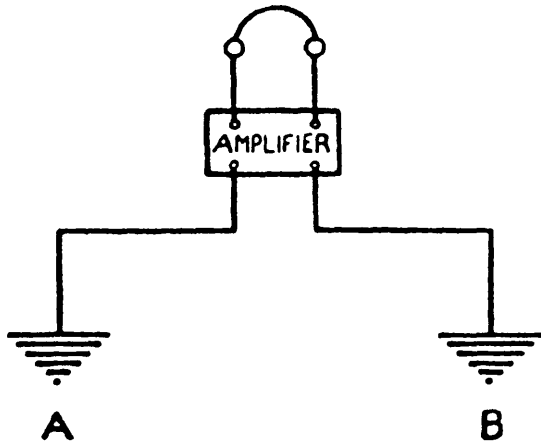

With such a circuit a most remarkable piping note is heard at times. At the front operators usually refer to these noises as "flying grenades." It is difficult to imitate the sound by a word but the spoken word "piou" gives a slight idea of what is heard. Physically the note appears to be that due to an oscillation of practically constant amplitude but of quickly varying frequency, the frequency at the beginning of the sound being the highest audible and dropping rapidly to the deepest audible tones. On account of the properties of the amplifier (design of telephone, etc.), the note is particularly strong when the frequency is 1,000. The whole phenomenon lasts about a second.

On many days these earth sounds were so strong and numerous that ordinary interception could not be carried on at the same time. The phenomenon seems to be correlated with atmospheric conditions and was particularly noticeable on the mornings of the warmer days of May and June. It differed completely from the normal atmospheric strays which produce only crackling or bubbling noises in the telephones.

The earth electrodes which are the origin of occasional noises can scarcely be regarded as the source of these sounds; neither is it probable that the effect is due to some meteorological influence on the deeply buried earth wires. Much more likely is the suggestion that the amplifier itself, energised by a particularly strong atmospheric generates these oscillations. But all experiments tried in the laboratory to imitate this phenomenon have so far failed. Various types of electrical impulses and spark flashes have been tried but with no result. Thus no complete theory can be advanced for the cause of these weak alternating currents which originate so freely in the earth.

Yale **GROUND HOG**

The Perfect Ground

INCREASES POWER AND DISTANCE

on your **RADIO**

Marvelous newly invented ground gives 100% improved reception. Increases power and distance, users say. Thousands getting results like D. S. Friedman, Radio Engineer of Burlington, Iowa, who writes, "Am very much pleased with way your Ground Hog operates. Am now able to tune in any good stations with *little trouble from static.*" Everyone pleased and delighted. Users report, "Leaks stopped," "Static reduced," "end to jangling even in midsummer," "Results never dreamed of." Absolute satisfaction guaranteed or *money back* at once.

Efficiency Always Insured

Only ground on market that has power to draw and hold moisture thus assuring maximum efficiency at all times. Holds moisture indefinitely. Highly sensitive to radio energy. Proven valuable aid to clear, powerful distance reception.

SEND NO MONEY

Every radio owner needs a Yale Ground Hog. To introduce, we offer to those who act at once, regular \$5.00 size for only \$2.00. Send name today and pay postman \$2.00 plus 17c. postage on delivery, or send only \$2.00 with order and save postage.

Highest Approval



Tested and approved by Popular Radio Laboratory and other high scientific radio authorities. You can order direct today with absolute confidence of value and satisfaction.

FREE—Complete description of Ground Hog, proof of user satisfaction and full details of amazing special offer free on request—Send name today.

**Yale Specialty
Supply Co.**

131 W. 5th St., Kansas City, Mo.



SUBANTENNA

UNDERGROUND ANTENNA SYSTEM

Be Sure to Tune In
KYW
 (536 Meters)
 every Wednesday Evening
 7:30 to 8:00 P. M. Central
 Daylight Saving Time. The
 SUBANTENNA CRU-
 SADERS and their accom-
 panists will entertain you.

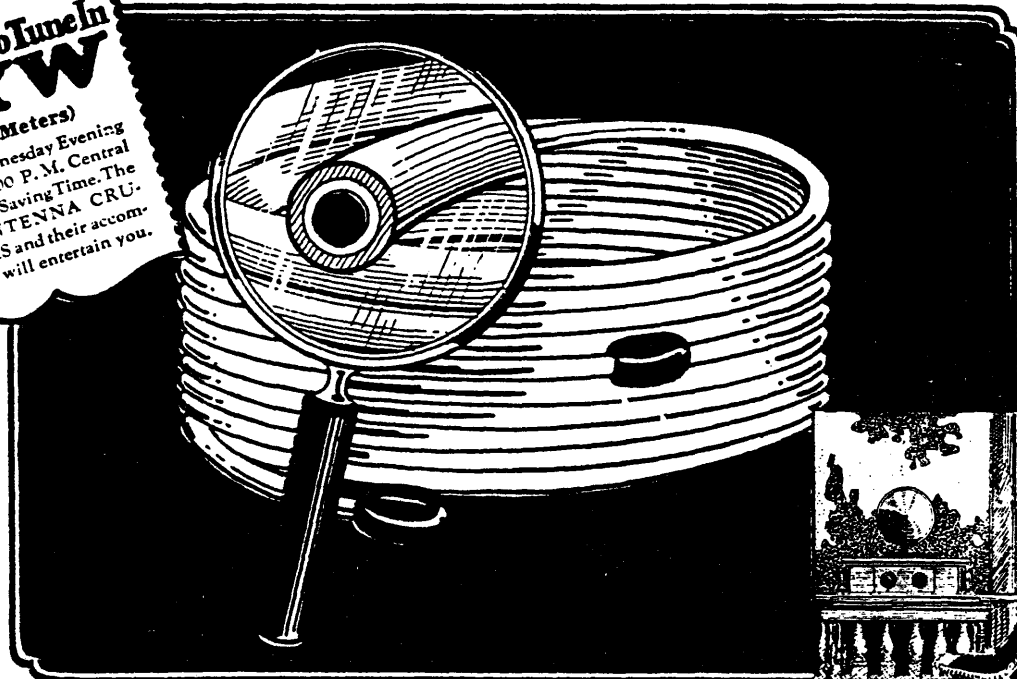

Gets Distant Stations Clear and Loud— Summer and Winter—Right thru Static

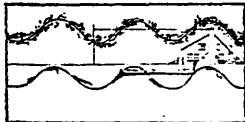

NOW—you can get "distance" in summertime. Loud, clean, clear distance, sweet and true

in tone—almost like local. The marvelous new device illustrated above makes this possible. STATIC is no longer a nuisance.

Engineers have long known that the ratio of static strength to signal strength IN THE AIR, favored Static, but that in the GROUND, the ratio of static strength to signal strength favored the music you wish to hear. They knew that if some device could be perfected whereby broadcast waves could be taken out of the GROUND instead of from the air, that all-year-round distant reception would become a reality. SUBANTENNA is the answer. It completely does away with the old style up-in-the-air aerial; it picks up clear, filtered waves from the ground—it delivers a strong signal; waves so powerful that the tiny amount of weak ground static they may contain is drowned out. The performance of SUBANTENNA is nothing short of marvelous. It will amaze you—just as it has amazed laboratories and thousands of critical fans.

User Says "Static Is No More"

"I have received the Subantenna. My grandson installed it. STATIC IS NO MORE. Am well satisfied. I can tune in stations I never could coax out of the air even though I had a long aerial."—A. E. F., Kans.

User Says "Greater Distance"

"To show you that I received a program from Station PWX in Havana, Cuba, I enclose herewith a verification card from that station. On January 28th, I received a program on my set broadcasted from Buenos Aires, South America at 10:15 in the evening. Many other long-distance stations have been heard on my set after installing the Subantenna. I never could receive such distance on my outside antenna."—W. C. F., Chicago, Ill.

User Says "Gets More Stations"

"I get plenty of stations with my Subantenna, on the loud speaker that I have never been able to reach with my outside aerial. It absolutely cuts down interference to the minimum, cuts static out too—not just partly out—but all out."—H. S. M., N. Car.

User Says "Cuts Out Interference"

"Have had Subantenna some months and it beats any antenna I have ever had by forty miles. Have a five tube set and get New York City, Atlantic City, Atlanta, New Orleans, Fort Worth, Denver perfectly clear, and next to an elevated train with much interference. Cuts it all out."—C. H. Y., Chicago.

User Says "More Volume"

"We have been receiving stations that formerly did not register on the outside antenna. A marked increase in volume on Stations over 300 Kilocycles has been noted."—Capt. F. W. F., Md.

Eliminates Lightning Risk

Not only does SUBANTENNA make possible loud, clear DX in summer—not only does this remarkable invention better the selectivity of any set—but it also completely eliminates the Lightning hazard. With SUBANTENNA one can go right on listening-in dur-

ing the most severe electrical storm without noise, fear of attracting lightning or damaging the set.

FREE TRIAL

Make This Convincing Test

Install SUBANTENNA. Leave your old aerial up. Select a bad night when DX is almost impossible with the ordinary aerial. Make a comparison station for station, connecting first your aerial, then SUBANTENNA. If, from stations that are just a mess of jumbled noise with the old aerial, you don't get reception that rivals local in sweetness and clarity the instant you switch to SUBANTENNA, this test won't cost you even a single penny. Obtain a SUBANTENNA from your dealer or send coupon at once for scientific explanation of SUBANTENNA and for particulars of GUARANTEE and FREE TRIAL OFFER. Send COUPON NOW!

CLIP AND MAIL AT ONCE

CLOVERLEAF MFG. CO.,
 2715-K Canal Street, Chicago, Illinois

Tell me all about SUBANTENNA, your unqualified, unconditional guarantee and your FREE TRIAL OFFER.

Name

Address

CLOVERLEAF MANUFACTURING CO.
 2715-K CANAL STREET

CHICAGO, ILLINOIS

PATENTED

SUBANTENNA!

The
One
Great
New
Thing
In
Radio

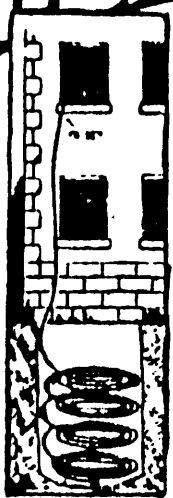

Amazing New UNDERGROUND ANTENNA

Gets Distance Clearly

Here you are, "Distance" fans! Install this new type underground "pick up system." Get distant stations loud and clear. SUB-ANTENNA so greatly reduces static and all other air noises that it lets the broadcast come thru clean and pure.

Reduces Bothersome INTERFERENCE

Power line leaks, arc light crackles, STATIC and other such nuisances as have made distance reception unpleasant, do not bother the "listener-in" with a SUBANTENNA. And you forever get rid of the unsightly mess of wire on your roof.

Opens Up New, Greater Amplifica- tion Possibilities

Instead of keeping your power turned way down to avoid amplifying foreign noises equally with the broadcast, you can now use the full power of your set to advantage. No matter how much amplification you choose to use, broadcast will so far dominate the air noises that the latter will be of no consequence.

FREE TRIAL OFFER!

Nothing else is like SUBANTENNA. It is not "just a wire." But you must try it to fully appreciate the wonderful new significance it gives to Radio. You can try it at our risk. Write at once for scientific explanation and for particulars of our FREE TRIAL OFFER. Write now. No obligation.

CLOVERLEAF MFG. CO.

2716-F So. Canal St.

Chicago

Amazing New Ground Antenna



Gets Far-away Stations Loud and Clear Regardless of Static Conditions

Radio Engineers and hundreds of users report that Aer-O-Liminator, the sensational new Ground Antenna, gets better long distance reception, almost unbelievable freedom from static and outside noises, far greater selectivity and marvelously clear and sweet tone quality.

Says "Cuts Out Static"

R. Curtis of Ill., says, "There's no such thing as static trouble since I got my Aer-O-Liminator. I get stations I never got before—so loud and clear I would almost swear they were in the next room." In addition you are free from troublesome overhead aerials that everyone now knows are static-gatherers. Aer-O-Liminator (Ground Antenna) is simple and easy to install. Takes but a few minutes.

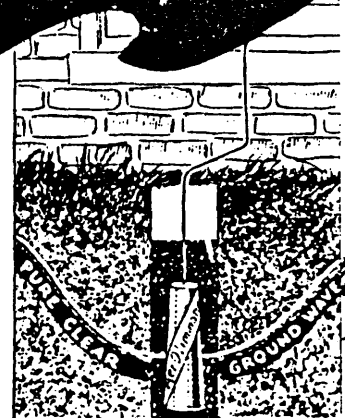

FREE TRIAL MAKE THIS THRILLING TEST AT OUR RISK!

Install an Aer-O-Liminator (Ground Antenna). Leave your old overhead aerial up. Try out on a night when static is bad. If you do not get a wonderful improvement in freedom from static, greater selectivity and clear, sweet tone without interfering noises, if you can't get good reception on stations that are drowned by static on your old

aerial you need not pay us a red cent for this test. Send coupon today for scientific explanation of Aer-O-Liminator (Ground Antenna), proof of performance, and our conclusive iron bound guarantee and remarkable Free Trial offer. Send coupon today!

CURTAN MFG. CO.

154 E. Erie St. Dept. 806-T
Chicago, Ill.

Rush This Important Coupon

Curtan Mfg. Co.,
154 E. Erie St., Dept. 806T,
Chicago, Ill.

Please send me at once complete description of Aer-O-Liminator with details of guarantee, Scientific Proof and FREE TRIAL OFFER.

Name.....

Address.....

City.....

State.....

Now-Make Your Radio Clear as a Bell- with Marvelous New **GROUND AERIAL!**



Sub-Aerial Endorsed by Experts

May 9th, 1928.
"I am very glad to state that after testing many Aerials in my Laboratory I find your Sub-Aerial is the best for clarity of tone and elimination of static, also for greater volume and selectivity."
"Your Sub-Aerial will fill a long-felt want among the Radio Fans."
A. B. Johnson, Radio Engineer, Aug. 21, 1928.
"I received my Underground Aerial all O. K. It has any aerial beat I have ever seen. I have used every aerial on the market since I have been a radio fan. The first day I installed it I got distant stations that my set had never touched before. It wasn't good radio weather either. I got stations in the East that I had never dreamed of getting and with absolute clearness and without static or interference. I heartily recommend your instrument to any lover of good radio reception."
A. N. Whitten, Box 505, El Reno, Okla.

Get Amazing Distance—Greater Volume and Finer Selectivity Without Distortion

Why go on listening to terrible static and other maddening outside noises? Now you can get the real music your present Radio is capable of giving, by hooking your set on to the clear, practically static free ground waves with Sub-Aerial. The air is always full of static and your overhead aerial picks it up and brings it to your speaker. So why stay in the air—when you can use the whole earth as a static and noise filter with Sub-Aerial?

SUB-AERIAL is a scientific, proven system of taking the radio waves from the ground, where they are filtered practically free of static. It brings these filtered waves to your radio set clear of static and interference common with overhead aerials. The result is positively clear reception, remarkable selectivity and greatly increased volume. The overhead aerial is a thing of the past because it is the weak link in radio. SUB-AERIAL has replaced overhead aerials because SUB-AERIAL is 100% efficient. How can you get good reception without one?

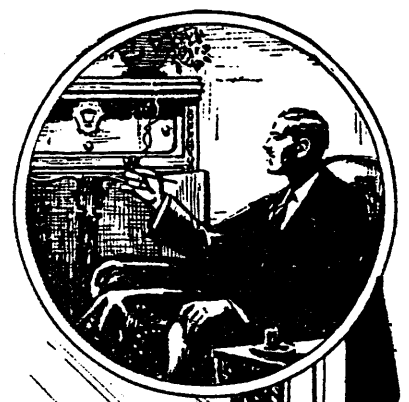

Low Original Cost—No Upkeep Cost

SUB-AERIAL costs no more than an overhead or loop aerial and less than many. Its first cost is the only one. SUB-AERIAL is permanent. No trouble—no hard work, or risking your neck on roofs.

25 Year Guarantee

SUB-AERIAL is guaranteed against any defects in workmanship or material and against deterioration for 25 years. Any SUB-AERIAL which has been installed according to directions and proves defective or deteriorates within 25 years, will be replaced free of charge; and also we will pay \$1.00 for installing any such new replacement.

TRY IT FREE!

We know so well the surprising results you'll get that we'll let you put in a Sub-Aerial entirely at our Risk. You be the Judge. Don't take down your overhead Aerial. Pick a summer night when static and noise interference on your old Aerial are "Just Terrible." If Sub-Aerial doesn't Sell Itself to You Right Then on Performance—you needn't pay us a cent. Send for "all the Dope on Sub-Aerial." You'll be surprised. Do it NOW.

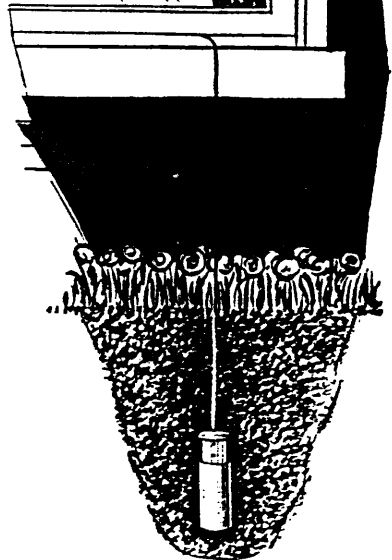

Can Be Installed
in a Few Minutes

UNDERGROUND AERIAL SYSTEMS

St. Clair Bldg., Dept. 402-S
Corner St. Clair and Erie Sts., Chicago, Ill.

Ground Out Static with SUB-AERIAL

Underground Aerial Systems, Dept. 402-S
St. Clair Bldg., cor St. Clair & Erie Sts., Chicago, Ill.
Send me complete information on Sub-Aerial. Proof and Free Trial Offer. No obligation.

Name

Address

City

State

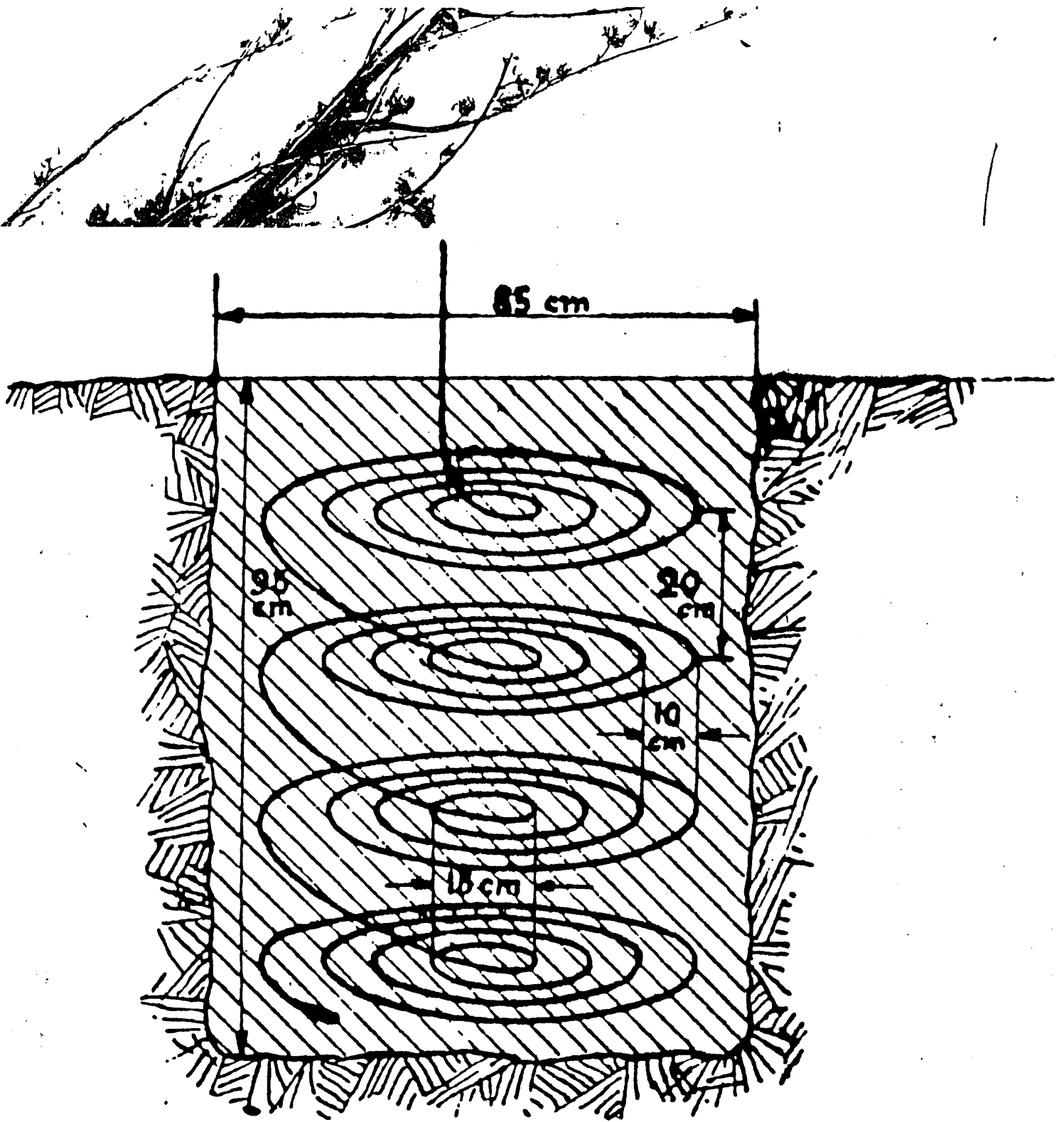

BURIED COIL AERIALS

EARTH CONDUCTION EXPERIMENTS

UNDERGROUND radio, which was quite a topic of conversation 40 years ago when the boys came back from the trenches of France, has popped into the news again after slumbering quietly for a few decades.

Several experiments using different theories are being carried out and some hobbyists have even rigged up their own sub-surface communications systems. One of the factors spurring the new boom in an old idea is the possibility of using underground radio in defense applications, particularly in connection with the growing network of buried missile installations. In this area it seems to have many advantages.

One dramatic experiment is being conducted near Edwards Air Force Base in an abandoned borax mine hundreds of feet beneath California's desolate Mojave Desert. Deep in the hole, scientists are transmitting electromagnetic waves into the earth and attempting to pick them up at various distances.

What does underground radio offer? Security is the main advantage, security against destruction and against interception. In an enemy attack our surface facilities would not be difficult to knock out but the only way to sever underground wireless connections would be to destroy the deeply buried transmitters and receivers. This would not be easy.

A buried receiving antenna intercepts this underground signal.

Long-wire antennas are used for transmitting, aimed in the direction of the receiving station. The waves are nearly non-directional but have a slight tendency to favor the direction the antenna is pointed, several hundred feet beneath the surface.

A second underground radio system uses signals propagated entirely within the earth and thus is impervious to jamming and atmospheric noise. In this approach, signals are fed into a dry rock substratum, a relatively good propagation medium, compared to moistened earth. The wet, conductive layers of the earth act as a shield while the dry layer passes the signal as would a waveguide.

To attain any distance in underground communications a great deal of power is required, so much that any comparison with the power required for overground communications for the same distance is pretty one-sided. Maximum usable range now is thought to be 100 miles. Besides inherent propagation difficulties, the earth offers other communications hazards in the form of plain noise, made up of its own magnetic field currents plus all the grounds of nearby 60-cycle AC power systems. The low frequencies are best for good communications underground.

Despite these drawbacks, Space Electronics Corp., Development Engineering Corp. and others are diligently improving antennas for greater directivity, coding messages for more efficient traffic handling, trying to solve the noise problem and experimenting with relay stations.

The work is being carried on because scientists are convinced that earth-current communication has a place, not only in military applications but for civilian use as well. Storms have no effect on the system, making it useful during such severe acts of nature as hurricanes, tornadoes and cyclones.

A company engineering a long pipeline in the Middle East is considering an earth-current system to connect its flow-control stations, which are about 50 miles apart. Instruments at these stations measure the rate of oil flow and transmit the information to other stations, which adjust valves accordingly. Microwave links are now used but this equipment, being above ground and unguarded, is notoriously susceptible to vandalism.

Should nuclear war ever come, earth currents might be the only thing to hold together a crumbling world.

EXPERIMENTAL AERIAL HYBRIDS

FERDINAND BRAUN (4B).—In 1898 Braun conducted some experiments on the transmission of Hertzian waves through water in the disused moats of the old Strasburg fortifications.

F. KIEBITZ (92).—In 1911 F. Kiebitz carried out a series of experiments at Belzig with extremely low aerials, only one metre high, and about 240 metres long. He considered that they were superior to a vertical aerial forty metres high. He was able to receive signals on these "earth" antennæ from all European stations, and he transmitted, by their aid, to a distance of about 230 kilometres. (Refer also to Hall's ground wire aerial system (985).

THE BEVERAGE AERIAL* (590), (589), (591), (795), (159).—This is another aerial of a very low horizontal type. It is usually erected at a height of about twelve feet from the earth, and is used by the Radio Corporation of America for transatlantic traffic.

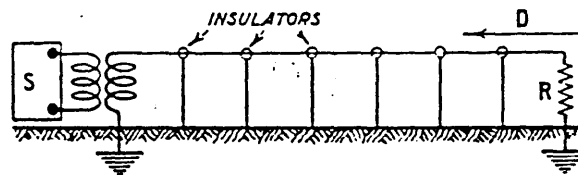

FIG. 184. The "Beverage" aerial is placed in line with direction of propagation of the waves to be received.

The potentials developed in this aerial are equal to those developed in a vertical aerial whose height is one-tenth of the length of the "Beverage" aerial (589). This aerial is shown in Fig. 184. It is directional, and is placed in line with the direction "D" of propagation of the waves. Its length is considerably greater than the wavelength of the received signals, and is determined by the following governing facts:

When the wave reaches the aerial it creates a current therein which will travel along the wire at a velocity determined by the electrical properties of the wire (resistance, inductance, capacity, etc.). This impulse will travel more slowly than the free wave, and the lag between the electrical forces in the wave and those in the wire will increase as the wave travels further and further along the wire, till at last a point will be reached when there is a maximum phase difference. After this a further increase in length will

* U.S.A. patent No. 1381089.

be of no further help in encouraging the growth of the E.M.F. in the aerial. It will begin to have exactly the opposite effect. We have now reached the correct length for maximum signal strength for the particular wavelength we are receiving, and any increase in length will only diminish the loudness of the signals.

When the wave reaches the set end of the aerial, the current is reflected back along the aerial and if allowed to do so would tend to reduce the E.M.F. therein. A resistance R is therefore inserted between the free end of the aerial and the earth, and arrangements are carefully made that the coupling unit at the set end S and the resistance at end R offer the same impedance to the wave as the aerial itself. The reflection effect will then be reduced to a minimum.

J. MURGAS (158).—In 1907 J. Murgas patented a method of signalling with buried antennæ. The aerials were well insulated and inserted vertically into holes in the ground.

J. HARRIS ROGERS (1024).—During the Great War, Rogers showed that it was possible to receive European communications in America by means of horizontal aerials buried below the surface of the ground, and he claims to have employed this type of aerial satisfactorily for transmissions.*

A. A. HALL (985).—In 1918 A. A. Hall patented a method of thermionic valve radio transmission and reception in which the usual elevated aerials are not employed. The transmitting and receiving stations each have two earth connections about an half-a-mile apart, connected to the sets by insulated conductors lying on the ground. For both transmission and reception valve circuits with reaction between grid and plate circuits are employed similar to those commonly used for reception and transmission. The negative side of the filament of the valve is connected to one earth, and instead of connecting the negative side of the H.T. supply to the same earth, it is connected to earth half-a-mile or so distant.

RECEPTION WITHOUT AERIALS (812).—The Author has pointed out that good broadcast reception can be obtained with any good single valve regenerative set with or without note magnification, at a distance of from fifteen to twenty miles from a main broadcasting station without the employment of any aerial in any of the following ways :

* Reference should be made to P. R. Coursey, page 228 of this book ; and Ref. (587) on signalling with submerged aerials from submarines.

(1) By connecting the grid of the detector valve to earth and leaving the usual earth terminal of the set free.

(2) By employing the same connections as above but with the addition of a variable condenser in the earth circuit. This arrangement is not very practicable, as it makes the set particularly sensitive to capacity effects due to the proximity of the operator's hands. This effect can be obviated to a great extent by connecting a high resistance across the condenser.

(3) A far better method is to connect two condensers in series across the aerial and earth terminals of the set, as shown in Fig. 158, page 270.

IONIZED BEAM AERIALS AND CONDUCTORS (979).—In 1916 J. Hettinger suggested the employment of searchlight beams, from tungsten arcs, mercury vapour lamps, or other sources of powerful ultra-violet radiation, the idea being to ionize the air, through which the beam (or plurality of beams) passed, and so render it electrically conductive. When such a beam is to be used as a transmitting aerial, electrical connection to the beam is made from the oscillatory circuits, by means of a wire net or metal grid through which the beam passes.*

A similar arrangement is suggested for reception. The ionized beam may be partly or wholly saturated by direct current, or low frequency alternating current, and the oscillations employed for signalling may be superimposed thereon.

IONIZED BEAMS AS CONDUCTORS (979).—Hettinger has also suggested the use of ionized beams as conductors for ordinary telegraphy or telephony.

THE AUTHOR'S EXPERIMENTS.—During 1923 and 1924 the Author carried out some experiments with ionized air (810). The air was ionized by means of two small radium-coated spirals of copper wire. One of these was well insulated, and attached to the grid of a Marconi QX valve, and the other was connected to one pole of the secondary of a small induction coil, the other terminal of which was earthed. Signals were transmitted in this way by the passage of ions across the lecture room; but it was not found possible to transmit at a greater speed than twelve words a minute. The Author suggests that it might be advantageous to substitute radioactive grids for those employed by Hettinger.

* Not only would the ionized beam offer a high resistance, but having an indefinite length it could not be expected to oscillate at any definite frequency.



Dr. W. H. Eccles introduced a simple method of making records when listening-in at a telephone receiver. Vertical marks are made by hand, the distance between them roughly representing the time between the disturbances, and the length of the vertical lines the loudness of the observed sounds (see 42, and Dr. W. H. Eccles' paper before the British Association at Dundee (43)).

In 1912, in a paper "On the Diurnal variation of the electric waves occurring in Nature, and the propagation of waves round the Bend of the Earth," Eccles showed that in ionized air the velocity of electric waves may be increased, and that owing to the increased velocity of electric waves, as they travel through the ionized layer (or Heaviside layer) of the atmosphere, they were bent down or refracted so that they were enabled to reach round the earth.

In certain cases the ionic refraction would be so great that the wave might be brought right down again to the earth's surface and its effective range reduced.

Both Dr. Eccles and Dr. J. A. Fleming (45) have pointed out that the decreasing density of the atmosphere should produce a certain amount of refraction, independent of the ionic refraction.

In his book, "The Principles of Electric Wave Telegraphy and Telephony," Fleming states that ordinary ship transmission and reception has "two or three times greater range by night than by day, when using a 600-metre wavelength."

For longer waves the difference may be all the other way. Senator Marconi called attention to this in his lecture of June 2nd, 1911, at the Royal Institution, when he stated that for waves 4,000 to 5,000 metres long, the transatlantic signals are sometimes stronger by day than by night. Speaking of diurnal variations, Marconi also said: "Waves about 4,000 metres in length, crossing the Atlantic from West to East, yield strong and steady signals all day at Clifden, which gradually weaken after sunset, reaching a minimum about an hour and a half afterwards. The signals at Clifden then gradually increase in intensity till after sunset at Cape Breton, when they attain a maximum which is occasionally very high. During the night they are variable in strength. Slightly before sunrise at Clifden the signals grow stronger, and sometimes pass quickly to a high maximum; they then



dwindle to a marked minimum about two hours after sunrise at Clifden, and then return to the normal day strength."

Similar observations have also been made by Eccles (87) and Airey, who conducted experiments simultaneously between Newcastle and London and published their results in 1911.

Appleton and Watt gave a very valuable paper on "Atmospherics" before the Royal Society in 1923 (48); they showed that only about half the atmospheric disturbances heard as X's in a wireless receiving station are oscillatory in character, and that nearly as many of the disturbances are aperiodic. In ten days they observed 590 atmospherics. The whole of their observations were made by means of a cathode-ray oscillograph (Fig. 69). This consists of a heated filament in a partially exhausted bulb. In front of the filament are two pairs of plates, arranged to be at right angles to one another, and the cathode stream from the filament passes between these plates and impinges on a fluorescent screen, or coating of fluorescent material, on the inside of the glass of the bulb (opposite to the filament). As the cathode beam impinges on the screen a bright spot of fluorescent light is seen, and when one pair of plates is connected to a source of alternating current it causes the cathode beam to oscillate to and fro, across the fluorescent screen, so quickly that the spot of light appears like a straight line running horizontally across the screen. The aerial of the receiving station is connected through a suitable amplifier to the other two plates of the oscillograph. Whenever a disturbance reaches the aerial the straight line of fluorescence on the screen is deflected up and down, so that it takes on a wave form and shows the true characteristics of the disturbance. At present, it has not been found possible to take photographic records; but they can be clearly observed by eye.

On June 27th, 1923, Watt gave a demonstration, and showed the oscillograph in action, at a lecture he delivered at the Institution of Electrical Engineers before the Radio Society of Great Britain. (See also Oscillograph of Wood & Dufour, Ref. 1107, 1108).

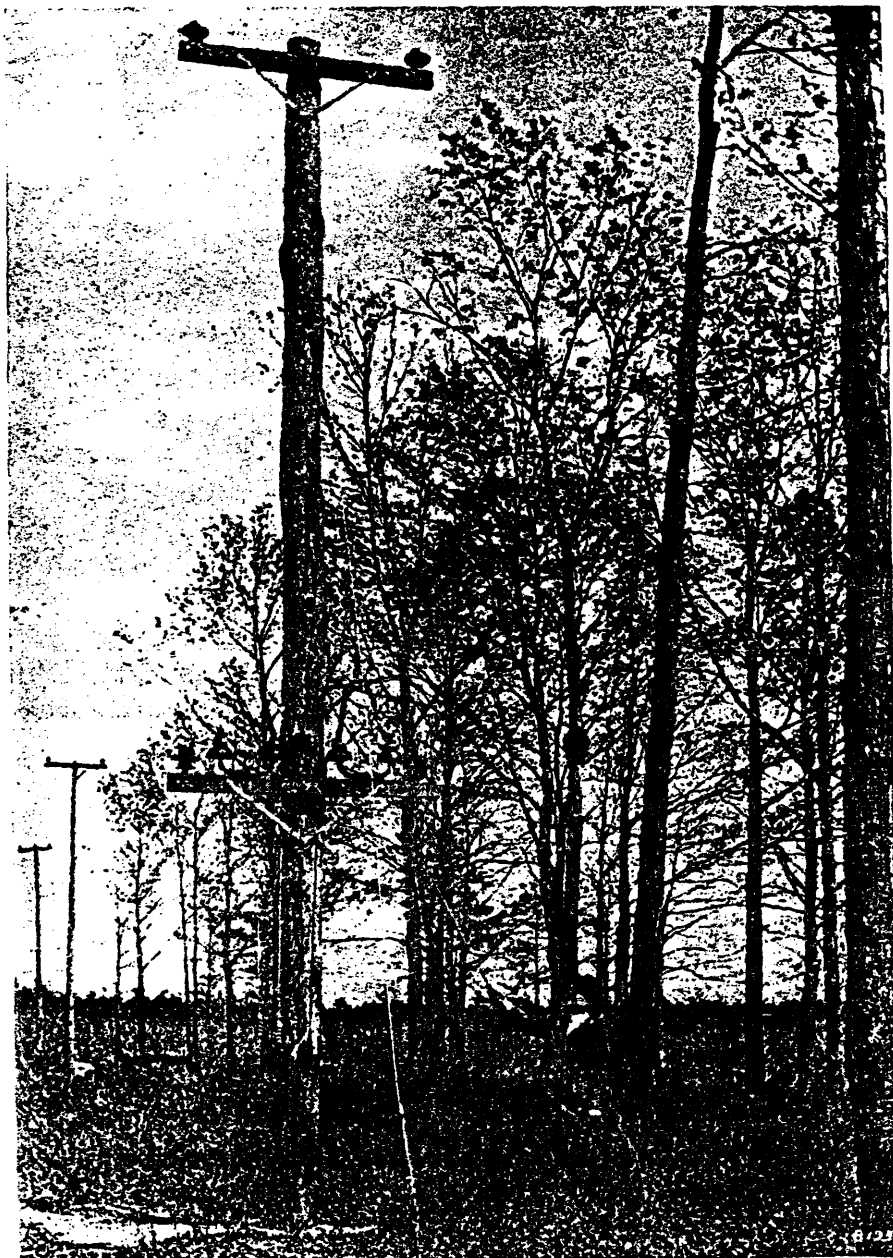

Radio Corporation of America

HOW THE BEVERAGE ANTENNA HELPS TO OVERCOME STATIC

The *Via* transatlantic radio stations find that a wire stretching for miles and grounded at the far end through a relatively high resistance, helps to bring in the signals louder than the static. The length of the wire must bear a definite relation to the wavelength. (See "Tracking Static to Its Lair," page 342.)

NEW GROUND AERIALS

RF Systems DX-7 Active Antenna

Launched in August 1992, the DX-7 is a budget version of the famous DX-1 active antenna (tested in WRTH 1988 and the 1993 WRTH Equipment Buyers Guide). It has slightly reduced performance characteristics, but it is also half the price of the DX-1.

The antenna is also far more compact, ideal for someone with limited space for an external antenna. Since the antenna is active it should be mounted on a metal pole outside the interference field of the house (at least 5 metres away from the building). The "coil" design is unique, enabling 2.3 metres of antenna to be wrapped round a sealed polyurethane pipe 50 cm long. The unit requires an indoor power supply. The DX-7 comes with a standard DC connection for a car battery (for portable use). An RF isolated power supply is also available as an optional extra, this operating on any AC power supply between 100-250 volts. Power is fed to the antenna through the coaxial cable (not supplied) and this may be anything up to 50 metres in length. The electronics for the antenna are housed inside the tube which is fully sealed from the outside elements. In order to avoid static build-up during thunderstorms we mounted the DX-7 on a grounded metal pipe (up to 40 mm in diameter is possible), threading the coaxial through the pipe.

The DX-7 produces noticeably less output than the DX-1 or the Dressler ARA-60. However, in comparison to the ARA-60, the intermodulation level is also lower..it is a medium efficiency antenna. The intercept point of our example was +24 dBm, lower than the ARA-60 and DX-1. However it was a quieter antenna than the ARA-60 resulting in less distortion on very weak signals which in turn improves the intelligibility. It is also considerably more compact. The antenna costs .399 in Holland, half the price of the DX-1. More details from: Doeven Electronics, Schutstraat 58, 7901 EE Hoogeveen, The Netherlands. Tel: +31 5280 69679. Fax: +31 5280 72221. In the US, Universal SW in Reynoldsburg, Ohio carries RF Systems products. Lowe Electronics distributes them in the UK.

