

Aether and
Gravitation

W. G. Hooper, F. S. S.

AETHER AND GRAVITATION

AETHER
AND
GRAVITATION

BY
WILLIAM GEORGE HOOPER, F.S.S.



LONDON
CHAPMAN AND HALL, LTD.

1903

QC
177
.H79

INTRODUCTORY NOTES

THE author in this work endeavours to solve the greatest scientific problem that has puzzled scientists for the past two hundred years. The question has arisen over and over again, since the discovery of universal gravitation by Sir Isaac Newton, as to what is the physical cause of the attraction of gravitation.

"Action at a distance" has long ceased to be recognized as a possible phenomenon, although up to the present, the medium and method of gravitational attraction have not yet been discovered.

It is, however, generally accepted by scientists, that the only possible medium which can give rise to the phenomena incidental to, and associated with the Law of Gravitation, must be the universal aether, which forms the common medium of all phenomena associated with light, heat, electricity and magnetism.

It is impossible, however, to reconcile gravitational phenomena with the present conception of the universal aether medium, and a new theory is therefore demanded, before the long-sought-for explanation will be forthcoming.

Professor Glazebrook definitely states the necessity for a new theory in his work on J. C. Maxwell, page 221, where he writes: "We are waiting for some one to give us a theory of the aether, which shall include the facts of electricity and magnetism, luminous radiation, and it may be gravitation."

A new theory of the aether is also demanded in view of the recent experimental results of Professor Lebedew, and Nichols and Hull of America. It is logically impossible to reconcile a frictionless aether, with their results relative to the pressure of light waves.

In the following pages of this work the author has endeavoured to perfect a theory, which will bring aetherial physics more into harmony with modern observation and experiments; and by so doing, believes that he has found the key that will unlock the problem not only of the cause of universal gravitation, but also other problems of physical science. The author

131967

has taken Newton's Rules of Philosophy as his guide in the making of the new theory, as he believes that if any man knew anything of the rules of Philosophy, that man was Sir Isaac Newton. The first chapter therefore deals with the generally recognized rules which govern philosophical reasoning, the same being three in number; the fundamental rule being, that in making any hypothesis, the results of experience as obtained by observation and experiments must not be violated.

In applying the rules to the present theory of the aether, he found that the theory as at present recognized violated two of the most important rules of Philosophy, because, while aether is supposed to be matter, yet it failed to fulfil the primary property of all matter, that is, it is not subject to the Law of Gravitation. If aether is matter, then, to be strictly logical and philosophical, it must possess the properties of matter as revealed by observation and experiment.

Those properties are given in Chapter III., where it is shown that they are atomicity, heaviness or weight, elasticity, density, inertia, and compressibility. To be strictly logical and philosophical, the author was compelled to postulate similar properties for the aether, or else his hypotheses would contravert the results of all experience.

The application of these properties to the aether will be found in Chapter IV., where the author has postulated atomicity, heaviness or weight, density, elasticity, inertia, and compressibility for the aether, and so brought the theory of the aether into perfect harmony with all observation and experiments relative to ordinary matter. It will be shown that Clerk Maxwell also definitely affirms the atomicity of the aether, while Tyndall and Huyghens also use the term "*particles of aether*" over and over again.

Moreover, in view of the most recent researches in electricity made by Sir William Crookes and Professor J. J. Thomson, we are compelled to accept an atomic basis for electricity, and as Dr. Lodge, in his *Modern Views of Electricity*, states that "Aether is made up of positive and negative electricity," then, unless we postulate atomicity for the aether, we have to suppose that it is possible for a non-atomic body (aether) to be made up of atoms or corpuscles, which conclusion is absurd, and therefore must be rejected as illogical and unphilosophical.

After postulating atomicity for the aether, we are then able to apply the Newtonian Law of Gravitation to it, which distinctly affirms that "every particle of matter attracts every other particle," and so we arrive at Thomas Young's fourth hypothesis given in the Philosophical Transactions of 1802, where he asserts that "All material bodies have an attraction for the aetherial

medium, by means of which it is accumulated within their substance, and for a small distance around them in a state of greater density." He adds the significant remark that this hypothesis is opposed to that of Newton's. With an atomic and gravitative aether it is shown in Chapter IV. how the elasticity, density, and inertia of the medium are brought into harmony with all observation and experiments.

In the succeeding chapters the new theory is applied to the phenomena of heat, light, electricity, and magnetism, and the principles enunciated therein are then applied to solar and stellar phenomena.

One of the greatest stumbling-blocks to the discovery of the physical cause of gravitation, apart from the unphilosophical theory of the aether medium, lies in the fact that apparently the Law of Gravitation only recognizes a force of one kind. Dr. Lodge refers to this phase of the subject on page 39 of his *Modern Views of Matter* just published. It is here where scientists have failed to solve the problem of universal gravitation, as there are *two* forces at work in the solar system and not one; that is, if we are to accept the results of up-to-date experiments in relation to radiant light and heat as performed by Professor Lebedew, and Nichols and Hull of America. Their experiments conclusively prove that light waves exert a pressure upon all bodies on which they fall, and by no reasoning can this pressure be resolved into an attractive force.

Herschel in his *Lectures on Scientific Subjects* definitely refers to the existence of a repulsive force in the solar system, and asserts that it offers the most interesting prospect of any future discovery.

The author has therefore attacked the problem of the cause of gravitation, by trying to solve the problem of the cause of the *repulsive* force which has been experimentally demonstrated to exist by Professor Lebedew and others.

In his efforts to ascertain the physical cause of the Centrifugal Force, he has been assisted by an unknown and original essay written by an unknown writer over twenty years ago. That unknown writer was the author's father, who wrote an essay on the *Complementary Law of Gravitation*, and if it had not been for that essay, the present work would never have been attempted.

The main object of the author in Chapters VI., VII., and VIII., is to prove beyond the possibility of contradiction, from the phenomena of heat, light, and electricity, the existence of *two* forces in the solar system; and by so doing, to bring our philosophy of the aether medium, and all gravitational phenomena, into harmony with all observation and experiments, which at present

is not the case. In seeking to do this he found that the new theory of the aether harmonized with views given by Faraday and Clerk Maxwell in relation to electric and magnetic phenomena, and by the new theory Maxwell's hypothesis of "Physical Lines of Force" receives a definite and physical basis. In Chapter X. the author endeavours to show what the Electro-Kinetic energy is, which term is used by Clerk Maxwell, the term being brought for the first time into harmony with our experience. The Electro-Magnetic Theory of Light also receives fresh light from the new theory of an atomic and gravitating aether.

In the succeeding chapters the theory is applied to Newton's Laws of Motion and Kepler's Laws, and is found to harmonize with all the results given by these laws. Such a result is a distinct advance on the application of a frictionless aether to solar and stellar phenomena, as it is impossible for Kepler's Laws to be reconciled in any way with our present theory of the aether.

In the concluding chapter on the unity of the universe, certain views are suggested as to the ultimate constitution of all matter, upon an aetherial basis, which hypothesis practically resolves itself into an electric basis for all matter. It is suggested that aether and electricity are one and the same medium, both being a form of matter, and both possessing exactly the same properties, viz. atomicity, weight, density, elasticity, inertia, and compressibility. This view of matter harmonizes with the most "Modern Views of Matter" as suggested by Sir Oliver Lodge in his Romanes Lecture 1903.

The author has accepted Newton's way of spelling "*aether*" as given in his work on *Optics*, and has given "*aetherial*" the same suffix as "material," in order to differentiate the word from "ethereal," which is too metaphysical a term for a material medium.

Nottingham,
Sept. 1903.

CONTENTS

CHAPTER I

PHILOSOPHY OF GRAVITATION

	PAGE
ART. 1. GRAVITATION	I
” 2. CAUSE OF GRAVITATION	1
” 3. NEWTON'S RULES OF PHILOSOPHY	3
” 4. FIRST RULE OF PHILOSOPHY	3
” 5. SECOND RULE OF PHILOSOPHY	4
” 6. THIRD RULE OF PHILOSOPHY	7
” 7. APPLICATION OF RULES TO GRAVITATION	9
” 8. ANALYSIS OF LAW OF GRAVITATION	9
” 9. PRIMITIVE IMPULSE	10
” 10. CENTRIPETAL FORCE	12
” 11. CENTRIFUGAL FORCE	13
” 12. NEWTON'S LAWS OF MOTION	15
” 13. FORCE	16
” 14. FIRST LAW OF MOTION	16
” 15. SECOND LAW OF MOTION	19
” 16. THIRD LAW OF MOTION	20
” 17. SUMMARY OF CHAPTER	22

CHAPTER II

PHILOSOPHY OF GRAVITATION—(continued)

ART. 18. GRAVITATION ATTRACTION	24
” 19. UNIVERSALITY OF GRAVITATION	24
” 20. DIRECTION OF THE FORCES	26
” 21. PROPORTION OF THE FORCES	26
” 22. LAW OF INVERSE SQUARES	27
” 23. TERRESTRIAL GRAVITY	29
” 24. CENTRIFUGAL FORCE	30
” 25. KEPLER'S LAWS	32
” 26. FIRST LAW OF KEPLER	33
” 27. SECOND LAW OF KEPLER	36
” 28. THIRD LAW OF KEPLER	37

CONTENTS

CHAPTER III

MATTER

	PAGE
ART. 29. WHAT IS MATTER?	40
" 30. CONSERVATION OF MATTER	42
" 31. MATTER IS ATOMIC	42
" 32. WHAT IS AN ATOM?	43
" 33. THE ATOMIC THEORY	44
" 34. KINDS OF ATOMS	44
" 35. ELEMENTS OF MATTER	47
" 36. THREE KINDS OF MATTER	47
" 37. MATTER IS GRAVITATIVE	50
" 38. MATTER POSSESSES DENSITY	51
" 39. MATTER POSSESSES ELASTICITY	51
" 40. MATTER POSSESSES INERTIA	52

CHAPTER IV

AETHER

ART. 42. AETHER IS MATTER	54
" 43. AETHER IS UNIVERSAL	58
" 44. AETHER IS ATOMIC	59
" 45. AETHER IS GRAVITATIVE	64
" 46. AETHER POSSESSES DENSITY	71
" 47. AETHER POSSESSES ELASTICITY	74
" 48. AETHER POSSESSES INERTIA	76
" 49. AETHER IS IMPRESSIBLE	78
" 50. AETHER AND ITS MOTIONS	80

CHAPTER V

ENERGY

ART. 51. ENERGY	83
" 52. CONSERVATION OF ENERGY	84
" 53. TRANSFORMATION OF ENERGY	86
" 54. POTENTIAL ENERGY	87
" 55. KINETIC ENERGY	89
" 56. ENERGY AND MOTION	91
" 57. CONSERVATION OF MOTION	92
" 58. TRANSFORMATION OF MOTION	93
" 59. MOTION AND WORK	95

CHAPTER VI

HEAT, A MODE OF MOTION

	PAGE
ART. 60. HEAT, A MODE OF MOTION	98
„ 61. HEAT AND MATTER	100
„ 62. RADIATION AND ABSORPTION	104
„ 63. HEAT IS A REPULSIVE MOTION	107
„ 64. RADIANT HEAT	109
„ 65. DIRECTION OF A RAY OF HEAT	111
„ 66. LAW OF INVERSE SQUARES	112
„ 67. FIRST LAW OF THERMODYNAMICS	114
„ 68. SECOND LAW OF THERMODYNAMICS	116
„ 69. IDENTITY OF HEAT AND LIGHT	119

CHAPTER VII

LIGHT, A MODE OF MOTION

ART. 70. LIGHT, A MODE OF MOTION	122
„ 71. TRANSVERSE VIBRATION OF LIGHT	130
„ 72. REFLECTION AND REFRACTION	135
„ 73. THE SOLAR SPECTRUM	139
„ 74. DIRECTION OF A RAY OF LIGHT	144
„ 75. INTENSITY OF LIGHT	145
„ 76. VELOCITY OF LIGHT	148
„ 77. DYNAMICAL VALUE OF LIGHT	150
„ 78. ELECTRO-MAGNETIC THEORY OF LIGHT	155

CHAPTER VIII

AETHER AND ELECTRICITY

ART. 79. ELECTRICITY, A MODE OF MOTION	162
„ 80. ELECTRIC FIELD	166
„ 81. ELECTRIC INDUCTION	174
„ 82. ELECTRIC ENERGY	179
„ 83. ELECTRIC RADIATION	182
„ 84. LAW OF INVERSE SQUARES	184
„ 85. SECOND LAW OF ELECTRICITY	186

CHAPTER IX

AETHER AND MAGNETISM

	PAGE
ART. 86. ELECTRO-MAGNETISM	192
„ 87. THE EARTH A MAGNET	195
„ 88. THE SUN AN ELECTRO-MAGNET	199
„ 89. FARADAY'S LINES OF FORCE	203
„ 90. TERRESTRIAL MAGNETISM	206
„ 91. SOLAR MAGNETS	211
„ 92. CAUSE OF ROTATION OF THE EARTH ON ITS AXIS .	219
„ 93. VORTEX MOTION	221
„ 94. RELATIVE MOTION OF AETHER AND MATTER	224
„ 95. VIBRATIONS IN THE ELECTRO-MAGNETIC THEORY OF LIGHT	228

CHAPTER X

AETHER AND NEWTON'S LAWS OF MOTION

ART. 96. AETHER AND CENTRIFUGAL FORCE	232
„ 97. AETHER AND CENTRIPETAL FORCE	236
„ 98. AETHER AND NEWTON'S FIRST LAW OF MOTION	239
„ 99. AETHER AND NEWTON'S SECOND LAW OF MOTION	244
„ 100. AETHER AND NEWTON'S THIRD LAW OF MOTION	251
„ 101. WHY PLANETS REVOLVE FROM WEST TO EAST	253

CHAPTER XI

AETHER AND KEPLER'S LAWS

ART. 102. AETHER AND KEPLER'S FIRST LAW	256
„ 103. AETHER AND KEPLER'S SECOND LAW	260
„ 104. AETHER AND KEPLER'S THIRD LAW	263
„ 105. ORBITAL MOTION OF PLANETS	266
„ 106. ECCENTRICITY OF THE MOON'S ORBIT	268
„ 107. THE SUN AND KEPLER'S FIRST LAW	270
„ 108. THE SUN AND KEPLER'S SECOND LAW	274
„ 109. AETHER AND THE PLANE OF THE ECLIPTIC	277
„ 110. AETHER AND THE CENTRIPETAL FORCE	282

CHAPTER XII

AETHER AND COMETS

	PAGE
ART. 111. WHAT IS A COMET?	291
„ 112. ORBITS OF COMETS	293
„ 113. KINDS OF COMETS.	296
„ 114. PARTS OF A COMET	298
„ 115. CENTRIFUGAL FORCE AND COMETS	300
„ 116. FORMATION OF TAILS	303

CHAPTER XIII

AETHER AND STARRY WORLD

ART. 117. STARRY WORLD	306
„ 118. STARS AND KEPLER'S LAWS	309
„ 119. AETHER AND NEBULAE	313
„ 120. WHAT IS A NEBULA?	314
„ 121. AETHER AND NEBULAR HYPOTHESIS	317
„ 122. KINDS OF NEBULAE	319

CHAPTER XIV

AETHER AND THE UNIVERSE

ART. 123. THE UNIVERSE	323
„ 124. UNITY OF THE UNIVERSE	326
„ 125. CONSTITUTION OF MATTER	334
„ 126. QUOD ERAT FACIENDUM	337
„ 127. GOD AND THE UNIVERSE	342
APPENDIX	349
INDEX	351

AETHER AND GRAVITATION

CHAPTER I

PHILOSOPHY OF GRAVITATION

ART. 1. *Gravitation.*—In the realm of Science, there exists a Force or Law that pervades and influences all Nature, and from the power of which, nothing, not even an atom, is free.

It holds together the component parts of each and every individual world, and in the world's revolving prevents both its inhabitants and its vegetation from being whirled off its surface into space. It exists in each and every central sun, and circles round each sun its associated system of planets. It rolls each satellite around its primary planet, and regulates the comet's mysterious flight into the depths of space, while the pendulation of even the remotest star is accomplished by this same force. Our own rocking world obeys the same mysterious power, that seems to grasp the entire material creation as with the grasp of the Infinite.

It exists in, and influences every atom, whose combinations compose and constitute the entire material creation, or each and every orb that bespangle the blue infinity.

As is readily seen, it weaves as it were around each and all, a mysterious network or chain, that binds star to star, and world to world, blending all into one entire, vast and complete unity. It decides all their orbits and distances, regulates and controls all their motions, from the most simple even to the more complex and intricate, ultimately producing that wondrous and beautiful order, unity and harmony that everywhere pervade and blend all the universe into one grand and harmonious whole.

That Law I need hardly say is the Law of Gravitation.

ART. 2. *Cause of Gravitation.*—Now the question arises, and indeed has arisen a thousand times since the discovery of this law by Sir Isaac Newton over two hundred years ago, as to what is the physical cause, the true explanation of this universal attraction.

MacLaurin in his work on the philosophical discoveries of Sir Isaac Newton says: "In all cases when bodies seem to act upon each other at a distance, and tend towards one another without any apparent cause impelling them, this force has been commonly called Attraction, and this term is frequently used by Sir Isaac Newton. But he gives repeated caution that he pretends not by the use of this term to define the nature of the power, or the manner in which it acts. Nor does he ever affirm or insinuate that a body can act upon another body at a distance, but by the intervention of other bodies."

The results of modern discovery show that action at a distance, without the intervention of any medium, as for example the sun attracting the earth, is not the universal condition which governs all so-called forces.

It is now recognized that light and heat are both forms of energy, and therefore forces, using the term in the same sense that it is applied to Gravitation.

Both light and heat are transmitted through space with finite velocity through the intervention of a medium, the universal Aether. It is therefore only reasonable to suppose, that if one or more particular kinds of energy, or forces, require a medium for their transmission, why not another force, as for example Gravitation?

Gravitation is an universal force which operates throughout the length and breadth of the entire universe, and if there be a medium which is to Gravitation, what the Aether is to light and heat, the question at once confronts us, as to what are the characteristics, properties, and qualities of that universal medium, which is to form the physical basis of this universal attraction?

Newton himself suggested that Gravitation was due to an aetherial subtle medium, which filled all space.

In his well-known letter to Bentley, Newton writes as follows: "That Gravity should be innate, inherent, and essential to matter, so that one body can act upon another body at a distance through a vacuum, without the mediation of anything else, by and through which their action and force may be conveyed from one to another, is to me so great an absurdity, that I believe no man who has any philosophical nature or competent faculty of thinking can ever fall into it."

We also know from his *Queries* in his book on *Optics*, that he sought for the explanation of Gravitation in the properties of a subtle, aetherial medium diffused over the universe.

MacLaurin on this point says: "It appears from his letters to Boyle, that this was his opinion early, and if he did not publish his opinion sooner, it proceeded from hence only, that he found he was not able from experiment and observation to give a

satisfactory account of this medium, and the manner of its operations in producing the chief phenomena of Nature."

Therefore, if we accept Newton's suggestion, and endeavour to trace the physical cause of Gravitation in the qualities, properties, and motions of this subtle aetherial medium to which he refers, we shall be simply working on the lines laid down by Sir Isaac Newton himself.

I wish therefore to premise, that the future pages of this work will deal with the hypothesis of this aetherial medium, by which will be accounted for, and that on a satisfactory and physical basis, the universal Law of Gravitation.

ART. 3. *Rules of Philosophy*.—In order that we may rightly understand the making of any hypothesis, I purpose giving some rules laid down by such philosophers as Newton and Herschel, so that we may be guided by right principles in the development of this new hypothesis as to the cause of Gravitation.

The rules that govern the making of any hypotheses, so far as I can discern, may be summed up under the three following heads—

- (1) Simplicity of conception.
- (2) Agreement with experience, observation, and experiment.
- (3) Satisfactorily accounting for, and explaining all phenomena sought to be explained.

ART. 4. *1st Rule. Simplicity of Conception*.—From this rule we learn that the hypothesis must be simple in conception, and simple in its fundamental principles, and further, that the same characteristic of simplicity must mark each step of its development.

This rule of simplicity is distinctly laid down by Sir Isaac Newton in his *Principia*, Book 3, under the heading "Regulæ Philosophandi."

In that work he writes: "Natura simplex est, et rerum causis superfluis non luxuriat."—"Nature is simple, and does not abound in superfluous causes of things."

He further states that: "Not more of the natural causes of things ought to be admitted, than those which are true and suffice to explain phenomena. In the nature of Philosophy nothing is done in vain, and by means of many things, it is done in vain when it can be done by fewer. For Nature is simple, and does not abound in superfluous causes."

While again in Rule 3, he adds: "Natura simplex est et sibi semper consona."—"Nature is simple, and always agrees with itself."

Whewell also considers simplicity as a fundamental principle of all true hypotheses. On this point he writes: "All the hypotheses should tend to simplicity and harmony. The new

suppositions resolve themselves into the old ones, or at least only require some easy modification of the hypothesis first assumed. In false theories the contrary is the case."

Thus, it is the very essence of philosophy to build upon a foundation of simplicity, combined with the results of experience, observation, and experiment. For example, if we desired to form a hypothesis as to the cause of day and night, two hypotheses might be assigned as to the cause.

First, that the earth revolves on its axis once a day, and so presents each part successively to the light and heat of the sun; and second, that the sun revolves round the earth once every 24 hours. But such an assumption as the latter would involve the revolution of the sun through an immense orbit at an enormous velocity, in order for the journey to be accomplished in the time. So that it is much simpler to conceive of the earth revolving on its axis once every 24 hours, than it is for the sun to perform this journey in the same period. Hence the rule of simplicity is in favour of day and night being caused by the revolving of the earth on its axis. The same rule might be illustrated in many ways; but, however illustrated, the principle, according to Newton, always holds good that all effects are produced by the simplest causes, and if there are apparently two causes to the same phenomenon, then the simpler cause is the true and correct one. So that in the making and development of any hypotheses of the physical cause of Gravitation, this rule of simplicity must always be recognized; and, in conjunction with the other rules, we must seek to make our hypotheses, so as to be able to account and explain all phenomena sought to be explained.

ART. 5. *2nd Rule. Experience.*—Newton fully recognized the necessity of experience in Philosophy. He saw the absolute necessity of appealing to experience, observation, and experiment, both as a basis for philosophical reasoning, and further, for the data which were necessary to verify particular applications of the hypotheses suggested.

In his Rules of Philosophy, referring to experience as a guide, he says: "Hoc est fundamentum philosophiæ."—"This is the basis of philosophy."

Herschel, writing on the same subject in his *Natural Philosophy*, writes thus with regard to experience: "We have pointed out that the great, and indeed the only ultimate source of our knowledge of nature, and its laws, is experience. By which I mean, not the experience of one man only, or of one generation, but the accumulated experience of all mankind in all ages registered in books or recorded in tradition. But experience may be acquired in two ways, either first by noticing facts as they occur

without any attempt to influence the frequency of their occurrence, or to vary the circumstances under which they occur. This is observation. Second, by putting in action causes and agents over which we have no control, and purposely varying their combination, and then noticing what effects take place. This is experiment. To these two sources we must look as the fountains of all natural science."

Herschel further writes: "Experience once recognized as the fountain of all our knowledge of nature, it follows, that in our study of nature and its laws, we ought at once to make up our minds to dismiss, as idle prejudices, or at least suspend as premature, all preconceived notion of what might, or ought to be the order of nature in any proposed case, and content ourselves as a plain matter of fact with what is. *To experience we refer as the only ground for all physical enquiry.* But before experience itself can be used to advantage, there is one preliminary step to make which depends wholly upon ourselves."

"It is the *absolute dismissal* and clearing the mind of all *prejudices* from whatever source arising, and the determination to stand or fall by the result of direct appeal to facts in the first instance, and to strict logical deduction from them afterwards."

From extracts like these, from such men as Newton and Herschel, it can at once be seen that experience, and experience alone, should be the chief fountain from whence we draw all our data to form the bases of any hypothesis or theory. If the hypothesis formed is contradicted by the result of any present or future observation or experiment, then such hypothesis will either become untenable, or must be so modified as to take in the new fact furnished by that observation and experiment.

It is a *sine quâ non* of all true philosophy, that philosophy should always agree with experience. To the extent that our Philosophy of Nature fails to agree with our experience, or with the results of observation and experiment, then to that extent it ceases to be philosophy. It may be a hypothesis or even a theory, but certainly it is not true Philosophy.

Now, in the elaboration and development of the theory as to the physical cause of Gravitation, I can premise that nothing will be postulated or supposed, unless such supposition can be directly verified by our own observation and experiments.

Any theory or hypotheses that are contradicted by our own experience in its widest form, will find no place in the development of this work. Further, any present accepted theory in relation to any natural phenomena, which is controverted by experiment, or observation, will be rejected as untenable in the scheme of Natural Philosophy to be submitted to the reader.

Whatever else the theory suggested may, or may not be, one

thing it certainly shall be, and that is, that it shall be strictly based upon the Philosophical Rules as given by some of the greatest philosophers the world has ever seen. I do not premise that the hypotheses advanced will be strictly correct in every detail.

That would be to assume that my experience of all natural phenomena was perfect. To the extent that our experience is limited, to that extent our hypotheses will be limited and faulty. It would need an Infinite mind to form a perfect theory of the philosophy of the universe, because only an Infinite mind possesses infinite experience. A finite mind can, however, form true philosophical conceptions of natural phenomena, if that mind will only follow the guidance of his own experience, and be willing to accept the teaching that always arises from the results of that experience. In order to do this, however, it must be observed, as Herschel points out, that all old prejudices must be put away, and the question or problem to be considered must be viewed with an open mind. Let me illustrate what I mean. Suppose, for example, that for two hundred years, chalk had always been thought to be a mineral, and then, owing to the development of the microscope, and to the increased magnifying powers of the lenses, it was conclusively demonstrated that chalk is made up of the shells and remains of certain organisms that lived in the sea ages ago. Would it be philosophical to throw over the results of the microscopical research, and, simply because for two hundred years chalk had been thought to be a mineral, to argue, and still retain the idea that chalk was a mineral?

Such a result would be entirely opposed to all the teaching and principles of philosophy. In a similar way, suppose in the development of the physical cause of Gravitation, a certain conception of the universal Aether has to be put forth in order to account for Gravitation, and that that conception is opposed to some of the theories which have been held relative to the Aether medium for the past two hundred years; but that the conception so advanced is supported by the experiments and observation of some of the ablest scientists of the present century, would it be philosophical to reject the newer conception which harmonized with all experiment and observation, and still retain the old conception of the aetherial medium; or, to accept the newer conception of that medium, and to reject some of the ideas included in the old conception? From a purely philosophic standpoint, there can only be one reply, which would be in favour of the newer conception, by which our philosophy would be brought into harmony with our experience.

This I premise will be done in this work, and the result will

be, that for the first time, our philosophy of the aetherial medium will agree with our experience ; and, as the natural result, several outstanding problems will be explained on a physical basis, which at the present time cannot be satisfactorily explained except from the mathematical standpoint.

ART. 6. *3rd Rule. Satisfactory explanation of the Phenomena sought to be Explained.*—The third rule which governs the making of any hypothesis is, that the hypothesis formed in accordance with the first and second rules shall satisfactorily account for all the phenomena sought to be explained.

Newton writes on this point as follows: “ No more causes of natural things are to be admitted, than such as are true, and sufficient to explain the phenomena.” While again in his fourth rule he states: “ In experimental philosophy, propositions collected by induction from phenomena are to be regarded as accurately true, or very nearly true, notwithstanding any contrary hypothesis, till other phenomena occur by which they are made more accurate, or are rendered subject to exceptions.” *Principia*, Book 3. Herschel in his *Natural Philosophy* points out, that one of the chief requirements of any assumed hypothesis is, that it shall be sufficient to account for the phenomena to be explained, and that it shall be suggested by analogy.

Now the object of this work is to give a physical explanation of the cause and working of Gravitation, and to show how, by the properties, qualities and motions of the universal Aether, Universal Gravitation may be accounted for on a physical basis. So that every phenomenon, associated with, or included in the Law of Gravitation, should receive a satisfactory physical explanation by the proposed theory.

Thus the physical cause of the centripetal and centrifugal forces should receive for the first time a physical explanation.

Newton's Laws of Motion, in so far as they conform to his own Rules of Philosophy, should also receive a physical explanation.

Kepler's Laws, which govern the motion of planets in their orbits, should also receive a similar physical explanation. Indeed, all phenomena which the Law of Gravitation explains from a mathematical standpoint, ought to receive a physical explanation by the proposed new conception of the Aether medium.

In addition to the outstanding physical cause of Gravitation, there are other physical problems that yet remain to be solved ; as, for example, there is the question as to what is the relative motion of Aether to moving matter. Does the Aether move with matter through space as suggested by Michelson's and Morley's experiment of America, or does it flow freely through all matter, as it is usually thought to do ? I premise I will give a satisfactory solution of this problem in due course.

Again, in relation to the Phenomena of Light, there is still outstanding the problem of the physical explanation as to the transverse vibration of light. This problem will also be dealt with from the standpoint of our new conception of the Aether. Whether it will be as satisfactorily solved, as the physical cause of Gravitation, remains to be seen.

Further, there is also the important question yet unsolved, as to what Matter is. Lord Kelvin and Dr. Larmor have recently given to the world certain conceptions as to the origin of Matter, and I shall endeavour to show that such conceptions receive confirmation and support by the proposed new conception of the Aether.

Another problem that will be attacked and solved, will be the cause of the Permanent Magnetism of the earth, with an answer to some of the questions propounded by Professor Schuster at the British Association of 1892 relative to the magnetism of solar bodies.

There is certainly some physical explanation as to the cause of the earth being a magnet, yet up to the present no satisfactory physical theory has been given. I premise that the new conception of the Aether, to be submitted in the after pages, will satisfactorily account, and that on a philosophical basis, for this phenomenon.

Lastly, one of the most interesting discoveries of the present day will receive an added confirmation and explanation in the conception of the Aether medium to be advanced. I refer to the system of Wireless Telegraphy that has been so successfully developed by Signor Marconi, and I premise that new light will be thrown on that discovery by the suggested theory of the Aether.

Now, if all these problems can be partially or wholly solved by the same theory that is advanced to explain the physical cause of Gravitation, it needs no further comment to show that that theory is considerably strengthened and more firmly established.

For it is a rule in Philosophy, that the more problems any suggested theory can solve, the greater are the claims of that theory for acceptance by scientists generally. For, if two rival theories can solve three and ten physical problems respectively, then, in giving a decision as to which is the better theory, the balance of opinion would be overwhelming in favour of that theory which could solve the ten problems. So that, if in addition to the satisfactory explanation of the physical cause of Gravitation, some, if not all of the other problems can be solved, as I premise they can, by the same conception of the Universal Aether, then it follows our third rule of Philosophy will be more than fulfilled, and the theory so advanced will be placed upon

such a strong foundation, that it can only be overthrown by proving that it contradicts the results of some undiscovered phenomena.

ART. 7. *Application of Rules to Gravitation.*—Let us therefore apply Newton's own Rules of Philosophy to the Law of Gravitation, and endeavour to find out if the law, as at present understood, fully satisfies his own Rules of Philosophy. No one can reasonably object to subjecting the Law of Gravitation to the test of those principles which he lays down as the fundamental Rules of Philosophy.

If it comes through the ordeal with complete success, that is, if it is essentially simple in its conception and development, and if all its details are fully in accord with experience, as revealed by observation and experiment, then there will be no need to alter any of its hypotheses or axioms. If, on the other hand, it violates any of the rules as laid down by Newton, then, to that extent, an alteration will be necessary, in order that the Law of Gravitation may be brought into conformity with his own rules, and our Philosophy made to agree with our experience and observation.

ART. 8. *Analysis of Law of Gravitation.*—In order to accomplish this, let us ask ourselves, "What are the component parts of this Law of Gravitation?" The Law is not a simple law, but a compound one. It is compounded primarily of three parts.

- 1st. A Primitive Impulse.
- 2nd. A Centripetal Force.
- 3rd. A Centrifugal Force.

To these must be added the three Laws of Motion; although they are not directly part of the Law of Gravitation, yet they are essential to its effectiveness and completion. Without any one of these, the Law of Gravitation would fail to account for all the phenomena that it does account for.

If there were no Primitive Impulse, then the planets and meteors, sun and stars would for ever remain at rest, and the Laws of Motion would remain inoperative. If there were no Centripetal Force, then the Centrifugal Force would hurl the planets and comets, asteroids or minor planets away into the depths of space, never to return to their central sun.

If there were no Centrifugal Force, then the Centripetal Force would draw all bodies, *i. e.* all planets, etc., to their central sun, and, instead of the planets continually revolving round the sun, there would be but one immense solitary mass in the centre of the solar system.

If there were no Laws of Motion, with their necessary corollary the Parallelogram of Forces, the Primitive Impulse would cease

to act, and the Law of Gravitation would again fail in its attempt to account for those phenomena it does account for.

Thus, as it may easily be seen, Gravitation is a compound Law, depending upon at least four hypotheses, and therefore is not essentially a simple Force, or Law.

If, therefore, in giving a physical explanation of the cause of Gravitation, we can reduce all these four elements of the Law into one single physical cause, *i. e.* the Universal Aether, and show how they may all be explained and accounted for by the properties, qualities and motions of that physical medium, then such a result will be strictly in harmony with the first Rule of Philosophy, as laid down by Newton and others.

We will, therefore, proceed to consider some of these parts of the Law of Gravitation in detail.

ART. 9. *Primitive Impulse.*—This may be explained as follows. At the creating and launching of each world, Newton supposed that there was given to each world an impulse or tendency to fly off from the controlling centre into space. On this matter MacLaurin writes as follows: "If we had engines of sufficient force, bodies might be projected from them, so as not only to be carried a vast distance away without falling to the earth, but so as to move round the whole earth without touching it; and, after returning to the first place, commence a new revolution with the same force they first received from the engine; and after the second revolution, a third, and thus revolve as a moon or satellite round the earth for ever. If this can be effected near the earth's surface, it may be done higher in the air, or even as high as the moon. By increasing the force or power, a body proportionately larger may be thus projected, and by a power sufficiently great, a heavy body, not inferior to the moon, might be put in motion, which might revolve for ever round the earth. Thus Sir Isaac Newton saw that the curvilinear motion of the moon in her orbit, and of a projectile at the surface of the earth, were phenomena of the same kind, and might be explained from the same principle extended from the earth so as to reach the moon, and that the moon was only a greater projectile that received its motion in the beginning of things from the Almighty Author of the Universe."

Now what I desire to know is, "What is the nature, the mode of operation, and, above all, the physical cause of this Primitive Impulse?" Is it in its nature and mode of operation a simple Force, or Cause? Does it fulfil the condition of Newton's First Rule of Philosophy? Permit me to suggest several lines of thought which may be made the basis of its analysis.

Astronomers tell us that there are in existence millions of

stars, and suns, flooding immensity and space with their light and heat.

Now the question I wish to ask regarding Primitive Impulse in relation to all these stars is this: "Was the Primitive Impulse imparted to each sun, and star, and planet, separately and distinctly?" If so, then there must have been just as many Primitive Impulses as there are stars and suns and planets, and there would be according to a certain astronomer's estimate at least 800,000,000 Primitive Impulses, which assumption is altogether opposed to, and violates the First Rule of Philosophy.

If, on the other hand, it is affirmed that they all received their motion at one and the same time, then I ask: "What was the physical cause and method adopted to communicate the impulse to each one at the same time?" If the reply is given, that it was by Universal Gravitation, I have two objections to make to such a reply: first, that Gravitation is altogether inoperative without the Primitive Impulse, otherwise why was it conceived? and secondly, what is the physical cause of Gravitation?

Again, scientists inform us that there is every reason for believing, that stars and suns are still being formed in the universe, and that there are certain distinctive phenomena which go to prove that statement. Now, if that be true, and I believe it to be true, I wish to ask if the Primitive Impulse as suggested by Newton, is applicable to the stars and suns already in process of formation in the various nebulae? and, if so, at what point in the star's history or development is that Impulse applied?

Personally, I cannot conceive of the Great Creator of all things being so lacking in inventive genius, if I may reverently use that term, as to necessitate a separate Impulse being given to every separate star, or sun, as each one is created or formed during the progress and development of the universe of worlds.

I would much rather believe that which I hold to be the correct explanation, viz. that He has given to a certain fundamental and primordial medium, certain qualities and properties, by, and through which are originated and perpetuated, all the motions of the heavenly bodies already existent in the universe, or that are ever likely to be existent throughout all time.

The question of separate Primitive Impulses for separate bodies becomes more and more incongruous and inadmissible, as we consider it in its application to such small bodies as meteors and planetoids. Is it not contrary to our fundamental principles of Philosophy, that a separate Impulse should be necessary for all small bodies that exist in their myriads throughout the solar system, not to speak of the universe of which that system forms a part? Such a conception as Primitive Impulse, to each separate world, is altogether opposed to one's

idea of that simplicity and beauty which govern the universe at large, and violates the first rule of our philosophical reasoning, and for this reason must be rejected from the System of Philosophy to be propounded in this work.

ART. 10. *Centripetal Force*.—Let us now look at the Centripetal Force, and ask ourselves what is meant by such a force, and what is its mode of action and working. Centripetal Force, strictly, may be defined as that force which is always exerted towards the centre of the attracting body.

Taking the earth as an example, Newton points out, that though the gravity of bodies arises from their gravitation towards several parts of the earth; yet, because this power acts always towards the centre of gravity of the earth, it is therefore called the Centripetal Force.

This force, then, is that part of the Law of Gravitation which corresponds to the Attraction of Gravitation, and is always exerted in that straight line from the body attracted, to the centre of the attracting body, which joins the centres of gravity of the two bodies concerned.

The combination and effect of the various forces included in the Law of Gravitation are illustrated by the familiar illustration of the ball whirled round the hand by a piece of string, or the bucket filled with water, whirled round in the same way. Let us take the former. A piece of string with a ball attached to one of the ends is held firmly by the hand. An impulse or motion is imparted to the ball by the hand, that motion being continued by the movement from the hand. The first impulse given to the ball by the hand represents the Primitive Impulse. The tension on the string which holds the ball to its controlling centre represents the Centripetal Force, while the opposite force on the string, which takes up the Primitive Impulse and continues it, is represented by the Centrifugal Force.

The conception of the Centripetal Force is therefore simple, and entirely in accordance with our experience as gathered from observation and experiments. Both in the spheres of electricity, and magnetism, we find a similar force acting, which tends towards the centre of the attracting body, and therefore the Centripetal Force satisfies the first two Rules of our Philosophy.

Further, it adequately accounts for certain distinctive phenomena which occur through the Law of Gravitation, as, for example, the falling of bodies to the earth, and therefore is entirely in harmony with all the requirements of those principles enunciated by Newton for the successful explanation of any phenomena. I need hardly point out, therefore, this being so, any physical cause suggested as the explanation of Gravitation must deal with the Centripetal Force, and be able to give a

physical explanation of the mode and manner in which the Centripetal Force operates.

The Attraction of Gravitation or the Centripetal Force, however, being, as its name implies, simply a drawing or pulling power to a centre, that is, a force that is ever and ever only drawing matter to matter, or body to body, it could not of, and by itself, accomplish those necessary stellar and planetary motions by which are produced that universal order, unity and harmony which characterize the universe. It is essentially in its operations and influences, a one-sided force, ever tending and influencing towards self, and therefore by itself would only be a detriment and an evil; and, unless it were accompanied by some companion or complementary and counter force, with which it acts in union and concert, and which exactly counteracts its pulling power and influence, it would soon draw star to star, and world to world, crashing and heaping them together in ruinous and dire confusion. So that, instead of the infinitude of worlds which now exist, which flash and sparkle in the heavens, and in their intricate, elaborate, and mazy motions move through the vast infinity like stately armies on the march, there would only be one agglomeration of matter, a silent and solitary mass existing in the vast abyss of space.

Therefore, as soon as Sir Isaac Newton had discovered and demonstrated the existence of the power of Attraction, as represented by the Centripetal Force, and its association with the universe at large, there was seen at once the necessity of another Force, of an opposite character, which would form the companion and complementary force to Attraction; a repulsive, repellent force, one tending or repelling from a centre, so as to counter-balance the influence of the Centripetal Force which ever tends towards the centre.

To fill up the blank, there was conceived to exist what is called a Centrifugal Force, that is, literally, a Force acting, and ever acting from a centre, and with that Force we will now deal.

ART. II. *Centrifugal Force*.—In applying our Rules of Philosophy to this Force, if by Centrifugal Force is simply meant that Force which is the exact opposite of the Centripetal Force, that is, a Force which acts from a centre, instead of to a centre, then such a Force is strictly in harmony with, and satisfies all the conditions of the two first Rules of Philosophy.

Not only is such a conception simple, but it is also in accordance with experience and observation. Professor Hicks in his address to the British Association in 1895 said: "What is called Centrifugal Force is an apparent bodily Force directed outwards from the centre of curvature of the body's path, and

having an intensity equal to the distance from the centre multiplied by the square of the absolute angular velocity."

In the sphere of magnetism and electricity, the operation of two equal and opposite forces prevails. The attractive force of electricity, which is exerted to the centre, is always accompanied by the generation and development of a repulsive force, it being one of the fundamental rules of electricity that equal and opposite quantities of electricity are always generated at one and the same time. So that if the Centrifugal Force is viewed as being simply the exact opposite of the Centripetal Force, it fully satisfies the test when the first two rules laid down by Newton are applied to it.

If, on the other hand, Centrifugal Force implies and embodies the idea of continuance of the Primitive Impulse, as I believe it is supposed to do, then to that extent it is not conformable to the principles of our Philosophy, as embodied in the rules given by Newton.

Simply because, while it supposes a source or origin of its activity at the first, it goes on to suppose a continuance of that activity, without recognizing a continuing source or cause. It only recognizes and supposes the one original impulse given at the beginning, to account for the cause of the continually existing, and exerted power of the Centrifugal Force. I do not for a moment suggest, that the Divine Creator of all things, and the Ordainer and Upholder of all powers, forces and laws could not, had He chosen to give such a force, have given it and for ever operating. With that aspect of the question I have nothing to do, and of it nothing to say. I am dealing, and only wish to deal, with scientific facts, and scientific teaching from the purely philosophical standpoint.

Such an idea of a continuing effect, without a continuing cause, is altogether opposed to experience and observation, and is a violation of the second Rule of Philosophy.

Look where we will, or at what we will, and not only effects and causes are seen on every side, and in every thing, linked together inseparably, but wherever, and in whatever phenomena there is found a continuance of effect or effects, there is always and without exception found also a continuing source or cause.

Wherever Nature, therefore, gives us a continuous effect of any kind or sort, she always gives us a continuing cause, that can be both proved and demonstrated to exist. Nowhere in Nature, amid all her powers, principles and laws, is there to be found an effect without a cause, and in all continuing effects, a continuing and perpetuating cause also, and that effect exists just as long as the cause exists.

If the effect is perpetual, then the source and cause is perpetual

also, both in its existence and energy. Hence if the Centrifugal Force embodies the idea of continuance of the Primitive Impulse, without showing how that Primitive Impulse is continued, then such an idea is an anomaly in the universe, is altogether opposed to the teaching of Nature and science, and violates the most fundamental principles of our Philosophy.

The philosophic explanation, therefore, of the Centrifugal Force, is that Force which flows from a centre, and *which is the exact opposite and counterpart of the Centripetal Force*. Further, as the Centripetal Force is an attractive Force ever attracting to a centre, so the Centrifugal Force, being its exact opposite, is a repulsive Force, which fulfils all the laws and conditions which govern the Centripetal Force, as it is in every phase and aspect the exact opposite, being indeed its complement and counterpart.

Any physical explanation of the Law of Gravitation, therefore, must also give a satisfactory physical explanation of this Force, and show its mode of operation and working. This I premise I will do without the faintest shadow of doubt or failure; that is, if we are to accept the evidence of some of the most delicate experiments of modern times relative to aetherial physics.

ART. 12. *Laws of Motion.*—One of the most important factors in the successful application of the Attraction of Gravitation to the universe at large, are the Laws of Motion enunciated by Sir Isaac Newton. These are three in number, and are as follows—

1st. Every body continues in its state of rest, or of uniform motion in a straight line, except in so far as it may be compelled by impressed Forces to change that state.

2nd. Change of motion is proportionate to the impressed Force, and takes place in the direction of the straight line in which the Force acts.

3rd. To every action there is always an equal and contrary reaction.

Corollary.—To these must be added the first Corollary of the three laws which is commonly known as the Parallelogram of Forces, which is as follows: "That when a body is acted upon by two Forces at the same time, it will describe a diagonal, by the motion resulting from their composition, in the same time that it would describe the sides of the parallelogram."

Now let us apply Newton's Rules of Philosophy to these laws, and see if they fulfil the conditions laid down therein.

In the first place, there being three laws necessary to cover all the motions involved, there is not that simplicity of conception which is a primary factor in the making of any hypothesis. Then it will be observed that even after postulating the three

laws, Newton was unable to account for the elliptic orbits of the planets, until he had added a Corollary known as the Parallelogram of Forces.

ART. 13. *Force*.—The question has arisen also, as to the meaning of the term Force which Newton uses. What is a Force, its cause and mode of operation? The idea of Force is conveyed to us by our “muscular sense,” which gives us the idea of pressure, as for example when we push or pull a body along the ground.

We must not, however, limit our idea of Force to that narrow circle. It has now been fully established that Sound and Heat, Light, Magnetism, and Electricity are Forces, and therefore capable of doing work, as will be shown later on. Newton’s use of the term Force is therefore somewhat vague; he does not definitely say what the Force is which causes the change of position, of the body, or of the rate of motion of that body. That it is something to do with Gravitation is obvious, but its exact nature or character is not revealed.

Since Newton’s time we have made an advance in the definition of Force, and have come to consider Force as a kind of energy; the application of Force being the application of energy. Such terms as Mechanical Force, Chemical Force, Vital Force, are therefore out of date, and in their place the more definite ideas of energy are substituted. Instead, therefore, of getting such terms as Transformation of Forces, we now get Transformations of Energy. In the chapter on Energy, I hope to show that even that is not a satisfactory solution of the definition of a Force. If we are to make our Philosophy agree with our experience, then Force is due to motion, and motion alone.

So that Centrifugal Force will imply a motion from the centre; Centripetal Force a motion whose effect is ever towards the centre of gravity of any body.

ART. 14. *First Law of Motion*.—This may naturally be divided into two parts for the purpose of applying the Rules of Philosophy.

(1) Every body continues in a state of rest, except in so far as it is compelled by impressed Forces to change that state. To what extent is this statement conformable to our experience and observation? If I place a body, as for example a weight, on a table, will it remain in that state until it is moved by some other Force? I think that it will so remain, and to that extent the law conforms to experiment.

Wider observation, and all experience, also prove the conformity of this part of the First Law of Motion to the second Rule of Philosophy, as all experience testifies to the fact that a body remains at rest, until some other power or force moves it from

the position of rest. The application of this position of rest to any of the planets is, however, very difficult to conceive. MacLaurin, in relation to this fact, states: "This perseverance of a body in a state of rest can only take place in absolute space, and can then only be intelligible by admitting it." In dealing with the physical cause of Gravitation, I hope to be able to show that it can not only be admitted as a mathematical proposition, but that it can be made intelligible from the physical standpoint.

The second part of the First Law of Motion may be stated as follows: "Every body continues in a state of uniform motion in a straight line, except in so far as it is compelled by impressed forces to change that state."

Now what is the testimony of observation and experiment in regard to this part of the First Law of Motion? Let us test the question by the results of our experience. If a ball is sent rolling along the ground, its motion is gradually reduced until it comes to rest. If the ground is very rough indeed, as for example a ploughed field, then its speed will be very soon reduced, and the ball quickly comes to a standstill. If, however, the ground is smooth and level, like a well-kept cricket-field, then the motion of the ball will be reduced more slowly, and it will travel further before being brought to rest; while, if the ball is thrown along a very smooth surface of ice, it will travel a much longer distance before it is finally brought to rest.

Thus we learn, that the more we can get rid of all resistances to the motion of any body, the greater distance will the body travel, and the less diminution there is in the uniform motion of the body. So that, if it were possible to obtain a medium which offered no resistance at all to a moving body, then it would be a legitimate inference to infer that a body in such a medium, when once set in motion, would move with uniform motion for ever. Under such conditions, therefore, this part of Newton's First Law of Motion is physically conceivable. The crux of the whole matter, therefore, lies in the problem as to whether there is, or there is not, in existence, such a thing as a frictionless medium. We will therefore consider the problem of the existence of a frictionless medium from the philosophical standpoint.

Professor Lodge, in *Modern Views of Electricity*, p. 331, writes: "Now, if there is one thing with which the human race has been more conversant than another, and concerning which more experience has been unconsciously accumulated than about almost anything else that can be mentioned, it is the action of one body upon another; the exertion of Force by one body on another, the transfer of motion and energy from one body to another, any kind of effect, no matter what, which can be produced in one

body by means of another, whether the bodies be animate or inanimate."

"Now I wish to appeal to this mass of experience, and to ask, Is not the direct action of one body on another across empty space, and with no means of communication whatever, is not this absolutely unthinkable? We must not answer the question off-hand, but must give it due consideration, and we shall find, I think, that wherever one body acts on another body by obvious contact, we are satisfied and have a feeling that the phenomena is simple and intelligible, and that, whenever one body apparently acts on another body at a distance, we are irresistibly impelled to look for the connecting medium."

Again, on p. 333 of the same work, he adds: "Remember then, that whenever we see a thing being moved, we must look for the rope. It may be visible, or it may be invisible, but unless there is either a push or a pull, there can be no action."

Now, in relation to celestial phenomena, we are confronted with the fact of bodies acting on one another, and yet apparently they do not act upon one another by or through a medium, and to that extent according to the above extracts, such phenomena are opposed to universal experience. Again, we find planets and satellites moving through space with more or less uniform speed, and yet apparently there is no physical medium that acts upon them with either a push or a pull, as the present conception of the Aether is that of a frictionless medium, so that experience in its widest form seems altogether opposed to the existence of a frictionless medium.

Again, Tait in his *Natural Philosophy* says: "The greater masses, planets and comets moving in a less resisting medium, show less indications of resistance. Indeed it cannot be said that observations upon any one of these bodies, with the exception of Encke's Comet, has demonstrated resistance. The greater masses, planets and comets moving in a less resisting medium, show less indications. No motion in Nature can take place without meeting resistance due to some if not all of these influences. *The analogies of Nature and the ascertained facts of physical science forbid us to doubt that every one of them, every star, and every body of every kind has its relative motion impeded by the air, gas, vapour, medium, or whatever we choose to call the substance occupying the space around it, just as the motion of a rifle-bullet is impeded by the resistance of the air.*"

What is the testimony of our own personal observation and experiments to such an impossible entity as a frictionless medium? Can any of the readers tell me of any medium, be it solid, liquid, or gaseous, that they have ever heard of, or read of, or experimented with, that possesses the quality of being

frictionless? The answer is unanimously in the negative. But a frictionless medium was absolutely imperative to the success of the Newtonian aspect of the Law of Gravitation. If the Aether had not been frictionless, then the First Law of Motion would have been violated, and a body, as for example a planet set in motion, would not then have moved with uniform motion, but would have been brought to a standstill by the resistance of the Aether. Accepting therefore experience as a guide, as we are bound to do if we wish to be strictly philosophical, as Newton pointed out, then we are compelled to come to the conclusion that there is no such thing in the entire universe as a frictionless medium. Such a hypothesis is contrary to all laws and rules of Philosophy, and to continue to advocate its claims is to remain where we are in relation to the cause of Gravitation, and in complete ignorance of the beauty and harmony of the wonderful physical mechanism that underlies the whole of the universe. Of course, if experience and observation are no guide to Philosophy, then we will let imagination run riot, and postulate the most extravagant explanations for the varied phenomena of the heavens. With experience of no account, we will affirm that the moon is made of green cheese, that the earth is flat, that the sun revolves round the moon, and a host of other absurd hypotheses that require no correction by experience and observation. But there, a truce to such absurd imaginations. Experience is a guide to Philosophy, its claims are recognized by the greatest Philosopher the world has ever known, and therefore as either experience or a frictionless medium has to go, we will part with the frictionless medium, and endeavour to make a hypothesis of the Aether that is in greater harmony with our Rules of Philosophy.

ART. 15. *Second Law of Motion.*—The application of Newton's Rules of Philosophy to the Second Law of Motion is attended with greater success than was the case with his First Law. "Change of motion," he states, "is proportionate to the impressed Force, and takes place in the direction of the straight line in which the Force acts."

Newton adds this explanation to his Second Law: "If a Force generates any motion, a double Force will generate double motion, and a triple Force triple motion, whether they are applied simultaneously or gradually and successively. And this motion, if the body were already moving, is either added to the previous motion, if it is in the same direction, or subtracted from it if directly opposed to it, or is compounded with the previous motion if the two are inclined at an angle."

According to that, a force which presses or pushes with a four-pound pressure per square inch, if doubled, would press with a force of eight pounds per square inch, which fact agrees with

experience. If the force is applied gradually, then the change of motion would be gradual; if applied suddenly, then the resultant motion would be sudden and violent.

The impressed force, therefore, always produces a definite and corresponding effect on any moving body, however that force may be originated, and however it may be applied. The effect so produced is always a change of motion, or, in present scientific terms, a change of momentum in the moving body. If the impressed force is halved, by an alteration in the mass of the body which exerts the impressed force, then the resultant momentum produced is halved also. If the impressed force is doubled, through any alteration in the velocity of the body which exerts the force, then the momentum produced in the moving body will be doubled also. So that the impressed force is equal to the change of momentum in the moving body upon which it is impressed.

When similar forces are impressed upon exactly similar bodies, the velocities produced are exactly the same; but, if similar forces act on dissimilar bodies, then the velocities produced in the different bodies are not the same; yet the total motion produced on all bodies, according to the Second Law of Motion, must always be proportionate to the impressed force. So that when we compare the effect of similar forces on different bodies, we find that there are two factors involved, viz., the mass and velocity of the moving body. The product of these two quantities is termed the momentum of the body.

When we apply the Second Law of Motion to the theory of aetherial dynamics, as suggested in this work, we shall seek to show that Newton's Second Law of Motion holds good in its application to the new theory. With the present conception of a frictionless Aether, however, it is philosophically impossible for the Aether to exert force on any body that may exist in it. Because, to the extent that it is frictionless, to that extent it ceases to possess mass. If it does possess mass, then it cannot be frictionless. Such an assumption violates all the Rules of Philosophy.

Yet the Aether is supposed, in some unknown manner, to possess inertia, which property is also dependent on mass. If the Aether really possesses inertia, then it must possess mass, and possessing mass it ceases to be a frictionless medium. So that if it possesses mass, then it can exert force the same as any other body, and Newton's Second Law of Motion is applicable to it.

ART. 16. *Third Law of Motion.*—Newton's Third Law of Motion reads as follows—

“Action and re-action are equal and opposite, or, to every action there is always an equal and contrary re-action.” This

law is also conformable to experience ; for, by experiment, it has been proved to hold good for electric and magnetic action. As MacLaurin points out, the Third Law of Motion may be extended to all sorts of powers that take place in Nature, and belongs to attraction and repulsion of all kinds, and must not be considered as being arbitrarily introduced by Newton.

The mutual action between any two bodies has, therefore, a double action. Thus a piece of stretched string must be conceived as pulling at both ends ; the pull at the one end being exactly equal and opposite to the pull on the other end.

A magnet will attract a piece of iron with a certain force, but it is equally true that the iron attracts the magnet with an exactly equal and opposite force. We might even extend the application of this Third Law to a falling stone in its relation to the earth. Thus, if a stone is dropped from a high altitude to the surface of the earth, although the motion seems to be all in one direction, yet if the Third Law holds good, then the earth is attracted by the stone in exactly an equal, but opposite direction, to that in which the earth attracts the stone.

As, however, the mass of the earth is very great compared with that of the stone, it follows that the velocity of the stone compared with the velocity of the earth, must be very much greater, in order that the forces shall be equal.

The application of this Third Rule of Motion to planetary and celestial phenomena is therefore philosophical, in that its conception agrees with experience and observation.

Thus, while it is true that the sun attracts each of the planets in his system, it is equally true that the planets, in their turn, attract the sun with an exactly equal and opposite force. But the velocity of motion induced by the earth's attractive power upon the sun, would be less than the velocity of motion induced by the sun's attractive power upon the earth, although the two forces would be equal and opposite, simply because force, being a compound quantity, is dependent upon the mass of a body as well as upon its velocity.

Not only, however, is it true that the sun and all the planets jointly attract each other, but it is equally true that the planets attract each other also, with an exactly equal and opposite effect. Indeed, as Gravitation is universal, it has to be conceived that there are no two bodies existing, but what the Third Law of Motion equally applies to those two bodies ; so that equality of action and re-action is as universal as the Law of Gravitation itself.

In coming to a conclusion with reference to Philosophy and the Laws of Motion, I wish to say that I am strongly of the opinion that the day has come, or will soon come, when they will pass away and give place to a more direct and simple method of

working of the great Law of Gravitation. I look upon the Laws of Motion as part of the scaffolding which has been used to build up the Law of Gravitation. That Law has now been erected, and stands firm and secure in its position in the universe. Whatever changes may take place in its scaffolding, the Law itself will stand out with greater beauty and clearness, if we could but see the perfected structure, apart from the props and helps which have assisted in its successful erection and completion. As Dr. Larmor said, in his address to the British Association, 1900: "There has even appeared a disposition to consider that the Newtonian principles, which have formed the basis of physical phenomena for nearly two centuries, must be replaced in these deeper subjects by a method of more direct description of the cause of the phenomena. The question has arisen, as to how far the new methods of aetherial physics are to be considered as an independent departure; or how far they form the natural development of existing dynamical science."

I hope, therefore, to be able in this work to do something towards clearing the completed Law from some of the outside props, which have long hidden the simplicity, beauty and harmony of the physical working of Gravitation from the eyes of those who feign would see its wonderful mechanism.

In the elaboration and development, therefore, of the physical cause of Gravitation, it will be necessary to conceive a medium, whose properties and motions shall be able to account for all the movements of the planets, comets, suns and stars that the Laws of Motion now account for. Instead, however, of there being several Laws purely and simply mathematical in their application, there will be one physical medium, which will by its properties and motions account for—and that in a satisfactory manner—all the motions of the heavenly bodies. That such a medium is required in the scientific world is proved by the statement made by Professor Glazebrook, in his work on J. C. Maxwell, page 221, where he says: "We are still waiting for some one to give us a theory of the Aether, which shall include the facts of electricity and magnetism, luminous radiation, and it may be Gravitation."

ART. 17. *Summary of the Chapter.*—In summing up the contents of this chapter, we find therefrom, that there is a Universal Law in existence that is known as the Law of Gravitation. The physical cause of this Law, however, is unknown; Newton suggesting that it was due to the properties of an aetherial medium that pervaded the universe.

To form a right conception of this medium, and to develop the hypotheses of the same on strictly philosophical lines, it is essential for us to know the rules which govern the making of any hypothesis.

Those rules, according to Newton, and other philosophers, are chiefly three in number, and form the very essence of any philosophical reasoning. Any departure from those rules will entail partial or entire failure in the success of the undertaking.

The application of Newton's rules to parts of the great Law of Gravitation show that some of those parts are not fully in harmony with the rules which Newton laid down in his *Principia*.

Any physical theory that may be hereafter suggested as the physical basis for the Law of Gravitation, must itself not only account for the various forces already referred to, but must itself fulfil the Rules of Philosophy laid down by Newton. That is to say, the conception of the physical medium must be simple in character, its properties and motions must agree with all our experience, as given by observation, and experiments; and the properties and motions postulated for it must satisfactorily account for, and explain all the phenomena that are presented to us by the Universal Law of Gravitation.

If all this be done, then from the standpoint of strict philosophical reasoning, the physical medium so suggested, and the theory so made, will be incapable of being overthrown or disproved.

CHAPTER II

PHILOSOPHY OF GRAVITATION

ART. 18. *Gravitation Attraction.*—The Law of Gravitation being a compound law, and not a simple law (Art. 8), it is necessary that the principles which govern universal attraction should now be considered.

The law which governs Gravitation Attraction may be defined as follows: Every particle of matter in the universe attracts every other particle with a force whose direction is that of a line joining the centre of their masses, whose magnitude is directly as the product of their masses, and inversely as the square of the distance between them.

This may be divided into four parts.

- (1) The Universality of Gravitation.
- (2) The Direction of the Forces involved.
- (3) The Proportion of these Forces.
- (4) The Law of Inverse Squares.

The theory of the Aether, therefore, which will be perfected in this work, must not only satisfactorily account for the Attraction of Gravitation on a strictly philosophical basis, but the laws, governing the pressures or tensions of that physical medium, must harmonize with each of the parts of the complex Law of Gravitation into which it has been resolved.

ART. 19. *Universality of the Attractive Force.*—The principle upon which Universal Attraction rests is found in the words: "Every particle of matter in the universe attracts every other particle." It must, however, be admitted that this statement has never actually been proved. The smallest body that Newton used to prove his Law of Attraction was our satellite the moon.

Cavendish, however, in 1798, by a series of experiments, conclusively demonstrated that the force of Gravitation existed in small bodies. He took two small leaden balls of a certain weight, and fixed them at the ends of a rod about six feet long, the rod being suspended by a piece of wire in the air. Large leaden balls were then brought near the small ones, and great care was taken to see if there were any twist in the wire by which they were suspended. It was found that the wire had become

twisted on the approach of the large leaden balls, and thus he was able to prove that every particle of the attracted and attracting body are mutually concerned in the Attraction of Gravitation. There is abundant evidence of the application of this force in relation to our earth, as we shall see later on.

The universality of the Attraction of Gravitation is a fact that has been proved in a thousand ways, and a thousand times. All stars and suns, and all planets, satellites and comets and nebulae are subject to this universal law. Astronomy teaches us that its power extends across the vast abysses of space, and that stars situated at distances that cannot possibly be measured, are subject to this world-wide law. Some of the greatest discoveries in astronomical science were due to the operations of this wonderful law, the gravitating influences of certain planets indicating their existence, although their discovery had not yet been made.

The discovery of Neptune through the mathematical calculations of Le Verrier and Mr. Adams in 1846 was the crowning proof of the Law of Gravitation. Mr. Adams in England had noticed that the planet Uranus was being pulled out of the course by some unknown power, and so set to work to calculate the position of the body which thus influenced the motion of Uranus in its orbit. He located the position of the supposed influencing body strictly by mathematical calculations, and then took his results to the Astronomer Royal. Delay, however, occurred in the search for the supposed new planet, and nothing was done further in the matter for many months. Meanwhile Le Verrier in France, unknown to Mr. Adams, had been making similar calculations with reference to the perturbations of Uranus, and had arrived at similar results.

These results were sent to the Berlin astronomers, and the heavens were searched for the supposed new planet. After a time, the planet was discovered in that part of the heavens indicated by Le Verrier, and for a time his name stood out as the sole discoverer. Gradually, however, the claims of Adams were admitted and recognized, and to-day his claims to participate in the honour of the wonderful achievement are generally admitted. Thus the discovery of Neptune gave to the Law of Gravitation a stability and proof that perhaps it had never received before.

Further evidence of the existence of the universality of the attractive force, is to be found in a certain system of stars known as binary stars, which revolve around each other, while they gravitate around a common centre. Recent researches in astronomy only seek more and more to confirm the universality and effectiveness of this grand law, that seems to hold the entire universe in its sway.

Any medium, therefore, which is postulated as the physical

cause of Gravitation, must itself be as universal as Gravitation, in order for it to be able to fulfil this condition of universality. We shall find, as we proceed, that the only possible medium which can fulfil this condition, is the universal Aether, whose qualities and properties are already partly known and partly understood.

ART. 20. *Direction of the Forces.*—The attraction of Gravitation is always directed along the straight line which joins the centres of masses of the attracting and attracted bodies. Thus, if the earth and moon are taken as examples, an imaginary straight line drawn from the centre of the earth's mass to the centre of the mass of the moon would be the direction in which the gravitative force would be exerted. Now a line which joins the central body to its satellite we shall see when we come to deal with Kepler's Laws is known as the Radius Vector. Thus the path of the attraction between the two bodies is along the Radius Vector. It is a singular coincidence that the path of a ray of light from the sun also coincides with the Radius Vector, as it is one of the laws of light that the path of a ray always follows a straight line.

It must not, however, be assumed, that while the attractive power is being exerted along any one straight line joining the centres of two bodies, therefore the attractive power is not operative in relation to any other part of the space, around the body. If our earth, for example, had four moons instead of one, and they were each in different positions in relation to the earth, then the law as to the direction of the forces would still hold good. We have examples of this in the case of Jupiter with his five moons, and Saturn with his eight moons. So that the attractive force of Gravitation is again like light, it operates on all sides equally at one and the same time. A lamp in the middle of a room sends its light waves on every side at one and the same time, so that while each ray has for its path a straight line, yet those rays are emitted equally on every side. In like manner, though the direction of the forces between two attracting bodies is that of a straight line, yet the law of universal attraction is equally exerted on every side of the planet at one and the same time.

In the theory of the Aether, therefore, to be developed in this work, it will have to be demonstrated that the direction of the forces, which are originated and transmitted by that physical medium, must philosophically fulfil the conditions which govern the direction of the forces, as observed in gravitational phenomena.

ART. 21. *Proportion of the Forces.*—Newton proved that the attraction is proportional to the product of the masses of the bodies concerned.

Hence it is that the sun, which is the centre of the solar system, is capable of attracting the most remote planets, because the mass of the sun is greater than the mass of all the planets put together. Or take another illustration. Suppose that the sun and the earth are at equal distances from Saturn. Now the sun's mass is about 300,000 times that of our earth. Therefore if the earth draws Saturn through a certain distance in one second, the sun would draw Saturn through a distance which is 300,000 greater than the earth in the same period.

The governing principle, therefore, which decides the proportion of the attractive forces between two bodies is mass, and not simply density or volume. The mass of a body is a property which remains the same, as long as the inertia of the body remains constant. Mass is really a measure of the inertia of a body, or that property of a body by which it continues in its state of motion or of rest.

Mass is therefore a compound quantity, being equal to volume multiplied by density, so that if the volume of any body is halved, the density is doubled. Thus, the proportion of the attractive force between any two bodies ever remains the same, so long as the masses of the two bodies remain the same. Through all the changes of volume and density of any body, its attractive force remains constant, as long as the mass remains constant; for the simple reason, that as the volume of a body is increased, the density is proportionately decreased; or, as the volume is decreased, the density is increased.

For example, the volume of the sun as compared with the volume of the earth, is about 1,300,000 times greater, but the proportion of the attractive forces between the two bodies, is about 324,000 to 1. This difference is accounted for by the fact, that the density of the sun is about one quarter the mean density of the earth, hence their masses are in the proportion of 324,000 to 1. Thus the proportion of the attractive forces between any two bodies is dependent upon their masses, and not simply upon their volume or density.

ART. 22. Law of Inverse Squares.—The Law of Inverse Squares which is applicable to Gravitation is equally true of Sound, Light, Heat and Electricity, the Law being that Gravitation acts inversely as the square of distance. That is to say, if the distance of any body from the sun, for example, be doubled, then the force of Gravitation is diminished to one quarter of the intensity which would be exerted on the body in the first position.

Thus the further a body is from its controlling centre, the weaker the Attraction of Gravitation upon it becomes. Taking therefore Mercury and the earth as examples, we find that their

mean distances are respectively 35,000,000 miles and 92,000,000, which is a proportion of about 1 to 2½. So that the intensity of the sun's attraction on the earth is about four-twenty-fifths of what it is on Mercury, that being the inverse square of the relative distances of the two bodies.

Now the intensity of Light and Heat received by the earth is regulated by the same law of inverse squares, so that the earth would receive about four-twenty-fifths the intensity of light and heat which Mercury receives when they are both at their mean distances.

This law of inverse squares is applicable to every body which acts as a gravitating source throughout the whole of the universe, whether that body be small or large, and whether it be in the form of meteor, satellite, planet, sun or star.

Each satellite, planet or sun exerts an attractive influence upon every body that exists, that attractive influence being regulated by the masses of the respective bodies, and decreasing inversely as the square of the distance from the body viewed as the centre of attraction. So that, the further the attracted body is from the attracting body, the less is the intensity of the mutual attracting forces, though that intensity does not vary simply as the distance, but rather as the square of the distance, and that in its inverse ratio. Thus if we take two masses of any kind or sort, and place them at various distances as represented by the numbers 1, 2, 3, 4, 5, 6, the intensity of the attracting forces between the same masses at the relative distances will be represented by the numbers 1, $\frac{1}{4}$, $\frac{1}{9}$, $\frac{1}{16}$, $\frac{1}{25}$, $\frac{1}{36}$, which are the inverse squares of the respective numbers representing their distances. As we shall see, the same law holds good in relation to heat, light and electricity, and indeed to all forms of energy which radiate out from a centre equally in all directions.

There is no need to apply Newton's Rules of Philosophy to this Attraction of Gravitation, as it has been demonstrated to exist, times without number. Moreover its laws are exactly the same as those governing the phenomena of sound, light, heat, and electricity, so that apart from being proved by actual experiments in relation to the gravity of the earth, we have a wider experience of the application of the same ruling principles of the law in other departments of science.

The Law of Universal Attraction, which is strictly the Centripetal Force of the compound Law of Gravitation, fully satisfies the three governing rules of Newton's Philosophy. Not only is it simple in its conception, but it is borne out by experience, and adequately accounts for the distinctive phenomena which it seeks to explain. By it, astronomical observations can be taken with a precision and certainty that defy error or failure. The motion

of a planet in its orbit can be so perfectly calculated, that its position in space in relation to other planets can be foretold years in advance. The theory of the Aether, therefore, which is to be perfected in this work, must philosophically show that the pressures or tensions of that medium, which are postulated as the cause of Gravitation Attraction, must themselves fulfil the laws of inverse squares, which govern light, heat, electricity and the Attraction of Gravitation. I premise that this will be done in the theory of the Aether to be submitted to the reader in the after pages of this work.

ART. 23. *Terrestrial Gravity*.—Before passing from this phase of the subject, I should like briefly to look at the question of the Attraction of Gravitation from the standpoint of our own earth, as by so doing we shall notice some facts regarding the same, hitherto unnoticed, in the preceding articles.

Terrestrial Gravity is but a phase of Universal Gravitation. One of the most familiar facts and phenomena of everyday life is, that when a body, such as a stone or stick or bullet, is thrown or projected into the air, it always falls to the earth again. This is due to the attraction of the earth and the stone for each other. It has been proved experimentally that if a stone and a weight are let fall from a height of 16 feet, they would reach the earth in one second of time. Again, a feather, or cork, or even a piece of iron would take exactly the same time falling through the same space, provided that the feather or cork could be screened from the resistance of the air.

The distance, however, through which a body falls in one second varies at different parts of the earth's surface, being least at the equator, and greatest at the North and South Poles. This is accounted for by the fact that the polar diameter is only 7899 miles, while the equatorial diameter is 7925 miles, thus the distance from the centre of the earth to either pole is about 3950 miles, or 13 miles less than the equatorial radius of the earth. Now the force of gravity decreases upwards from the earth's surface inversely as the square of the distance from the earth's centre of gravity, but decreases downwards simply as the distance from the centre decreases. Thus if a ball were taken down 2000 miles, that is half the distance to the centre, it would only weigh half-a-pound, while if it were taken to the centre of the earth, it would have no weight at all; while a pound weight at the equator would not weigh one pound at the poles, because it would be nearer the centre of the earth by 13 miles.

Thus a pound weight is not always a pound weight. It varies as we carry it to different parts of the earth's surface, depending upon its relation to the centre of the earth for its exact weight. The point which I wish to make perfectly clear,

as it will be necessary for future reference, is, that there is no such thing as weight apart from the gravity of the earth; or, if we apply the principle to the solar system, there is no gravitating force in that system apart from the gravitating force of the central body, the sun, or the planets and other bodies which form the solar system.

Let us look at this matter from another standpoint, in order to prove this truth and make the same perfectly clear. If a pound weight were put in a spring-balance, then at the surface of the earth it would weigh one pound. Now, we will suppose that we have taken the weight to a height of 4000 miles above the surface of the earth, that is exactly double the distance from the centre of the earth, the radius of the earth being approximately 4000 miles. According to the law of inverse squares, the force of Gravitation decreases inversely as the square of the distance. The distance having been doubled, the proportion of the forces at the two places, *i. e.* the earth's surface and 4000 miles above it, are as 1 to $\frac{1}{4}$.

Thus at a distance of 4000 miles the weight which weighed one pound at the earth's surface, now only weighs a quarter of a pound. At a distance of 8000 miles, the distance would be trebled, therefore the force of Gravitation is one-ninth, and the weight would weigh one-ninth of a pound. If we could take the pound weight to the moon, the attractive force of the earth would be reduced to 1-3600, as the moon is 240,000 miles distant, that is sixty times the earth's radius. The square of 60 is 3600, and if we invert that we get 1-3600, so that the weight which weighs a pound at the earth's surface, would only weigh 1-3600 part of a pound at the distance of the moon. This again proves, that apart from the Attraction of Gravitation, there is no such thing as weight, and that the weight so called of any body, such as a planet or satellite, increases or decreases as its distance increases or decreases from its central attracting body.

ART. 24. *Centrifugal Force.*—I have already shown in Art. 10 that the Centripetal Force and Universal Attraction are one and the same; as the Centripetal Force always acts towards the centre, and must therefore be in its operation and influence a gravitating or attractive power.

I have also pointed out in the same article, the necessity of another force, which is to be the complement, and the counter part of Gravitation Attraction. That complement and counter force was conceived by Newton, and called by him the Centrifugal Force. The very nature of the Centripetal Force demands and necessitates a force which in its mode of operation is exactly the opposite of the Centripetal Force. Unless there were such a force, a repellent and repulsive force, then instead

of there being that harmonious working of the universe that now exists, there must inevitably be a gradual drawing together of all planets and satellites, of all stars and suns, into one vast, solitary, and ruinous body.

There are also other phenomena which demand a Centrifugal Force in the universe. It is a well-known fact, that there exist between the orbits of Jupiter and Mars, what are called planetoids, about 500 in number, which are supposed to be the remnants of a broken or shattered world. As may be expected from such an accumulation, they present the most extraordinary diversities and eccentricities in the orbits that can possibly be conceived. They are of all shapes and sizes, and besides their orbits round the sun, have orbits among themselves. They are so clustered together that their orbits intersect each other at numerous points, and when in conjunction are said to suffer great perturbations, being pulled great distances this way and that by each other's attractive influence. It is further stated that their orbits so intersect each other, that if they were imagined to be material rings, they would be inseparable, and the whole could be suspended by taking any one of them up at random. Here, then, is presented to us a kind or order of celestial phenomena for whose well-being and effectual working the Centripetal Force or the Attraction of Gravitation cannot possibly account. In their case another force is demanded which shall be the exact complement and counterpart of the Centripetal Force. There needs therefore a force, not an imagined one, simply conceived to fill a want, but a real Force, as real and as plainly to be understood as the Centripetal Force. A force existing in each world just like the Attraction of Gravitation, only the reverse of Gravitation, a repellent, repulsive Force, acting in the reverse mode, and way, to universal attraction. This Force must be governed by the same rules and laws that govern the Centripetal Force, if it is to work in harmony with the same. It must be universal in its character, having a proportion of forces equal to the product of the masses of the two bodies which are concerned, and its path must coincide with the path of gravitational attraction, that is, in the straight line which joins the centres of gravity of the two bodies. Further, and what is perhaps the most important of all, it must act as a repelling or repulsive force which shall be in the same proportion in regard to distance, as the law governing Centripetal Force, that is, inversely as the square of the distance.

Again, and briefly, there are also in existence small bodies called meteors, which are said to exist by myriads, which float in space, and circle round the sun. They are of all shapes and sizes, from one ounce to a ton or even tons, thousands of them

coming into contact with our earth's atmosphere every year, especially in August and November. All of these small bodies have orbits among themselves, and gravitate round one another, as they revolve round the sun. Now if the orbits of the planetoids be such an entangled mass, what must be the orbits of these meteors? What an indescribable, unimaginable mass of labyrinthian motions must exist among these myriads of little bodies! How they must intersect, cross and intermingle each other's orbits! What attraction and counter-attraction they must exert upon each other! Let me ask any man to sit down and try to imagine how the present recognized Centripetal and Centrifugal Forces can account for the effectual working of these meteors. As illustrating the necessity of a real and physical Centrifugal Force which is to be the exact counterpart of the Centripetal Force, I would call the attention of the reader to Herschel's view of this matter. In dealing with the phenomena of comets' tails he writes:¹ "Beyond a doubt, the widest and most interesting prospect of future discovery, which this study holds out to us, is, that distinction between gravitating and levitating matter, that positive and irrefutable demonstration in nature of a repulsive force, co-extensive with, but enormously more powerful than the attractive force we call gravity which the phenomena of their tails afford." I premise that this prophecy of Herschel's will be fully demonstrated and proved in the succeeding pages of this work. For, in the theory of the Aether that is to be afterwards perfected, it will be philosophically proved that the physical medium so conceived will satisfactorily account for a force or motion from the centre of all bodies; which motions fulfil all the conditions required by that Centrifugal Force, which is the complement and counterpart of the Attraction of Gravitation. At the present time, with the conception of a frictionless Aether, it is impossible to harmonize the existence of such a force or motion with our theory of the Aether. Yet Professor Lebedew of Moscow, and Nichols and Hull of America, have incontrovertibly demonstrated by actual experiments the existence of such a force. Therefore it follows, that if our present theory of the Aether fails to agree with experimental evidence, such a theory must be reconstructed in order that our philosophy may be made to agree with our experiments and our experience.

ART. 25. *Kepler's Laws*.—A long time before Newton had discovered the Law of Gravitation, Kepler had found out that the motions of the planets were governed by certain laws, and these came to be known as Kepler's Laws.

These laws which were given to the world by Kepler, simply

¹ *Lectures on Scientific Subjects.*

represented facts or phenomena which had been discovered by observation, as Kepler was unable to account for them, or to give any mathematical basis for the same.

On the discovery, however, of Universal Gravitation, Newton saw at once that these laws were simply the outcome of the application of the Law of Gravitation to the planets, and that they could be accounted for on a mathematical basis by the Law of Gravitation, as they seemed to flow naturally from that law.

Kepler's Laws are three in number and may be thus stated—

1st Law. Each planet revolves round the sun in an elliptic orbit, with the sun occupying one of the Foci.

2nd Law. In the revolution of a planet round the sun, the Radius Vector describes equal areas in equal times.

3rd Law. The squares of the periodic times of planets are proportional to the cubes of their mean distances.

Now the question arises, whether it is possible to form a theory of the Aether which shall satisfactorily and philosophically account for all the phenomena associated with Kepler's Laws in their relation to the motions of planets, satellites, or other solar bodies? On the present conception of the Aether such a result is an absolute impossibility. With the theory of the Aether, however, to be submitted to the reader in this work, the result is possible and attainable. If, therefore, such a result is philosophically proved, as I submit will be done, then we shall have greater evidence still that the theory so propounded is a more perfect theory than the one at present recognized by scientists generally.

ART. 26. *Kepler's First Law.*—Each planet revolves round the sun in an elliptic orbit, the sun occupying one of the Foci.

The ancients thought that the paths of the planets around the sun were circular in form, because they held that circular motion was perfect. A system of circular orbits for the paths of the planets round the sun would be very simple in its conception, and would be full of beauty and harmony. But exact calculations reveal to us that the path of a planet is not exactly that of a circle, as the distance of a planet from the sun in various parts of its orbit is sometimes greater, and sometimes less, than its mean distance.

The planet Venus has the nearest approach to a circular orbit, as there are only 500,000 miles between the mean, and greatest and least distances, but both Mercury and Mars show great differences between their greatest and least distances from the sun.

If, therefore, the orbits of a planet are not exactly circular, what is their exact shape? Kepler solved this problem, and

D

proved that the exact path of a planet round its central body the sun was that of an ellipse, or an elongated circle. Thus he gave to the world the first of his famous laws which stated that each planet revolves round the sun in an orbit which has an elliptic form, the sun occupying one of the Foci.

Not only is the orbit of a planet round the sun elliptic in form, but the path of the moon round the earth, or the path of any satellite, as for example a satellite of Mars or Jupiter or Saturn, is also that of an ellipse, the planet round which it revolves occupying one of the Foci.

It has also been found that certain comets have orbits which cannot be distinguished from that of an elongated ellipse, the sun occupying one of the Foci.

Now let us apply the Law of Gravitation to Kepler's First Law, and note carefully its application.

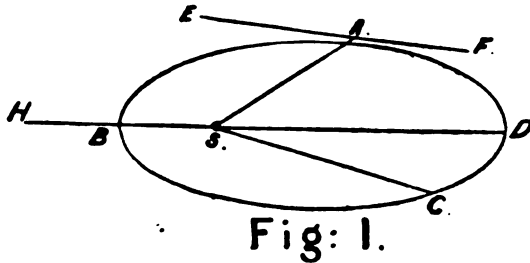

Let *A, B, C, D* be an ellipse representing the orbit of the earth, and let *S* represent the sun situated at one of the Foci.

We will suppose that the earth is projected into space at the point *A*, then according to the First Law of Motion, it would proceed in a straight line in the direction of *AE*, if there were no other force acting upon the earth. But it is acted upon by the attraction of the sun, that is the Centripetal Force which is exerted along the straight line *SA* (Art. 20), which continues to act upon it according to the principle already explained in Arts. 21 and 22.

Now, according to the Second Law of Motion and the Parallelogram of Forces, instead of the earth going off at a tangent in the direction of *AE*, it will take a mean path in the direction of *AB*, its path being curved instead of being a straight line.

If the sun were stationary in space, then the mean distance, that is, the length of the imaginary straight line joining the sun *SA* to the earth, would remain unaltered. The Radius Vector *SA*, or the straight line referred to, would then be perpendicular

to the tangent, and the velocity of the earth round the sun would be uniform, its path being that of a circle.

The Radius Vector SA , however, is not always perpendicular to the tangent FE , and therefore the velocity of the earth is not always uniform in its motion in its orbit, as sometimes it travels at a lesser or greater speed than its average speed, which is about 18 miles per second.

It has to be remembered that the sun itself is in motion, having a velocity through space of about $4\frac{1}{2}$ miles per second, so that, while the earth is travelling from A to B the sun is also travelling in the direction of SB . Thus the orbital velocity of the earth, and the orbital velocity of the sun, together with the Centripetal Force or universal Gravitation Attraction, are all acting in the same direction when the earth is travelling from A to B , that is, in the direction of the orbit situated at B . This point of the orbit is known as the perihelion, and at that point the velocity of the earth is at its greatest, because the earth is then nearest the sun.

According to Newton, the planet when at B would still have a tendency to fly off into space owing to its Centrifugal Force, but it is held in check by the Centripetal Force, so that instead of it flying off into space, it is whirled round and starts off on its journey away from the sun in the direction of B, C . The sun, however, is still continuing its journey in the direction of S, H , so that not only is the increased orbital velocity of the earth, which it obtained at its perihelion, urging the earth away from the sun, but the sun itself in its advance through space is leaving the earth behind it. The combined effect of the two motions, the advancing motion of the sun, and the receding motion of the earth, due to its increased orbital velocity, drives the earth towards the aphelion, where its distance from the sun is greatest, and its orbital velocity is the least.

By the time the planet has arrived at point C , its motion through space has gradually decreased, and the Centripetal Force begins to re-assert itself, with the result that the earth is slowly made to proceed towards the point D of the ellipse, at which point its motion is the slowest in orbital velocity, only travelling about 16 miles per second, while the distance of the earth from the sun is the greatest and has increased from 91,000,000 miles at the perihelion to 94,500,000. This point of the orbit is known as its aphelion.

After rounding this point, the orbital velocity of the earth begins to increase again, owing to the diminishing distance of the earth from the sun, which according to the law of inverse squares (Art. 22) gives an added intensity to the Centripetal Force.

Thus by the combination of the Laws of Motion and the Law of Gravitation discovered by Newton, he was able to satisfactorily account for and explain on a mathematical basis, the reason why the earth and all the other planets move round the sun in elliptic orbits, according to Kepler's First Law.

In the development of the physical cause of gravitation, therefore, the same physical medium, which accounts for that law, must also give a satisfactory explanation of the first of Kepler's Laws.

ART. 27. Kepler's Second Law.—This law states that the Radius Vector describes equal areas in equal times. The Radius Vector is the imaginary straight line joining the centres of the sun and the earth or planet. While the First Law shows us the kind of path which a planet takes in revolving round the sun, the Second Law describes how the velocity of the planet varies in different parts of its orbit.

If the earth's orbit were a circle, it can be readily seen that equal areas would be traversed in equal times, as the distance from the sun would always be the same, so that the Radius Vector being of uniform length, the rate of motion would be uniform, and consequently equal areas would be traversed in equal times. Take as an illustration the earth, which describes its revolution round the sun in $365\frac{1}{4}$ days. Now if the orbit of the earth were circular, then equal parts of the earth's orbit would be traversed by the Radius Vector in equal times. So that with a perfectly circular orbit, one half of the orbit would be traversed by the Radius Vector in half a year, one quarter in one quarter of a year, one-eighth in one-eighth of a year, and so on; the area covered by the Radius Vector being always exactly proportionate to the time.

From Kepler's First Law, however, we know that the planet's distance does vary from the sun, and therefore the Radius Vector is sometimes longer and sometimes shorter than when the earth is at its mean distance; the Radius Vector being shortest at the perihelion of the orbit, and longest at the aphelion. We learn from Kepler's Second Law that when the Radius Vector is shortest, that is, when the planet is nearest the sun, it acquires its greatest orbital velocity; and when the Radius Vector is longest, that is, when the planet is farthest from the sun, the orbital velocity of a planet is the slowest.

Let A, B, D, C represent the elliptic orbit of a planet, with S sun at one of the Foci, and let the triangles A, S, B and D, S, C be triangles of equal area. Then, according to Kepler's Second Law, the time taken for the Radius Vector to traverse the area A, S, B is equal to the time that the Radius Vector takes to traverse the area D, S, C . So that the planet would take an

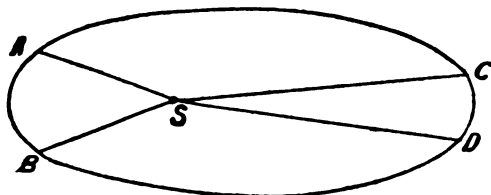

Fig: 2.

equal time in going from *A* to *B* of its orbit, as it would take in going from *D* to *C*. Thus the nearer the planet is to the sun, the greater is its orbital velocity, and the farther it is away from the sun the slower is its velocity, the velocity being regulated by the distance. The manner in which the difference of velocity is accounted for by the Law of Gravitation has already been explained in the preceding article. Thus Newton proved that Kepler's Second Law was capable of being mathematically explained, and accounted for, by the universal Law of Gravitation.

If, therefore, a physical cause can be given for Newton's Law of Gravitation, then such physical cause must also be able to account for, and that on a strictly philosophical basis, the second of Kepler's Laws as well as the first.

ART. 28. Kepler's Third Law.—The Third Law of Kepler gives the relation between the periodic time of a planet, and its distance from the sun. The periodic time of any planet is the time which it takes to go once round the sun. Thus the periodic time of the earth is $365\frac{1}{4}$ days. The periodic time of Venus is 224·7 days, while that of Mars is 686·9 days.

Kepler had found out that different planets had different periodic times; he also found out that the greater the mean distance of the planet, the greater was the time which the planet took to perform its journey round the sun, and so he set to work to find out the relationship of the periodic time to the planet's mean distance.

After many trials and many failures he arrived at the right conclusion, and at last discovered the true law which is known as Kepler's Third Law, which states that for each and every planet, the squares of their periodic times are proportional to the cubes of their mean distances.

For purposes of illustration let us take the earth and the planet Venus and compare these two. The periodic time of the earth is 365 days, omitting the quarter day. The periodic time of Venus is 224 days approximately. Now, according to Kepler's

Third Law, the square of 365 is to the square of 224, as the cube of the earth's mean distance is to the cube of Venus's mean distance, which are 92·7 millions of miles and 67 millions of miles respectively. The problem may be thus stated—

As $365^2 : 224^2 :: 92\cdot7^3 : 67^3 :$

This worked out gives—

133,225 : 50,176 : 796,597,982 : cube of Venus's mean distance.

So that by Kepler's Third Law, if we have the periodic time of any two planets, and the mean distance of either, we can find out the mean distance of the other by simple proportion.

In making astronomical calculations, the distances of the planets are generally obtained by means of Kepler's Third Law, as the periodic time of the planet is a calculation that may be made by astronomers with great certainty, and when once the periodic times are found, and the mean distance of a planet, as our earth for example, is known, the mean distances of all the other planets in the solar system may soon be obtained.

In like manner this Third Law of Kepler's is equally applicable to the satellites of any planet. For example, when the periodic time of both of Mars' satellites, Phobos and Deimos, are known, being about 8 hours and 30 hours respectively, and the distance of either is known, as Phobos with a mean distance of 5800 miles, then the mean distance of Deimos can easily be calculated by this law, and is found to be 14,500 miles.

As discovered by Kepler, the Third Law was simply the result of observation. He was unable to give any mathematical basis for its existence. The Laws as they were given to the world by Kepler were simply three great truths which had been discovered by observation. It rested with Newton to show how these laws could be accounted for on a mathematical basis, and to show how they all sprang from one and the same source, namely the universal Law of Gravitation. In his *Principia* he proved that all Kepler's Laws were fully expounded and explained by his great discovery of Universal Gravitation.

Now what Newton has done for Kepler's Laws from the mathematical standpoint, we propose to do from the physical standpoint. In the development of the physical agency or cause of Gravitation, therefore, among the phenomena and laws, which have to be satisfactorily accounted for on a physical basis, are these three Laws of Kepler's just referred to.

So that in addition to the satisfactory explanation of a physical cause for the Laws of Motion, and the Centripetal and Centrifugal Forces, the hypothesis of a physical cause of Gravitation must fully and satisfactorily account for the Laws of Kepler, whose mathematical explanation was given by Newton.

Further, and what is as equally important, the explanation so

given must be strictly in harmony with the Rules of Philosophy as laid down in Art. 3. That is, the explanation must be simple in character, must not be contrary to experience or observation, and must satisfactorily account for the laws which the hypothesis of the physical cause of Gravitation seeks to explain. This I premise we will do as we pass from stage to stage in the development of the theory.

I can safely premise that it will be simple in character and conception, that it will be entirely in harmony with all experience and observation, and that the physical cause so advanced will give as physical a basis to Kepler's Laws as Newton's mathematical calculations gave them a mathematical basis.

In summing up, I need hardly point out, that if all that I have premised in this and the preceding chapter is accomplished in the after chapters of this book, then for the first time since the discovery of Universal Gravitation by Sir Isaac Newton, his great discovery will have received the long-expected and long-desired physical explanation, that explanation and cause being founded on his own Rules of Philosophy given in his immortal *Principia*, and for the first time our Philosophy will be brought strictly into harmony with our universal experience.

CHAPTER III

MATTER

ART. 29. *What is Matter?*—The law of Universal Attraction states that “Every particle of matter attracts every other particle,” etc., and the question at once arises as to what is meant by the term Matter, what are its properties and its constitution? Tait, in his *Natural Philosophy*, gives the following as the definition: “Matter is that which can be perceived by the senses, or is that which can be acted upon by, or can exert force.”

It has already been pointed out in Art. 13 that force is due to motion, and that wherever we get motion of any kind or sort, there we get energy, or what used to be termed force. The consideration of this phase of the question will be more fully dealt with in the chapter on Energy and Motion. Suffice to say, that all experience teaches us that force is the outcome of motion.

Accepting this definition therefore of force, Tait's definition of matter will read thus, if brought up to date: “Matter is that which can be perceived by the senses, or is that which can be acted upon by motion, or which can exert motion.”

The common idea that matter can only be that which can be seen or actually felt, is not large enough for a definition of Matter. There are numbers of things in Nature which cannot either be seen or felt, yet which are included in the term Matter. Let us take one or two examples. Every one admits that nitrogen and oxygen are matter, yet I venture to say that no one has actually seen or felt either of these gases. Both of these gases are colourless and invisible, and are both tasteless. You may open your mouth and inspire both gases, and yet if they are pure, you cannot taste either of them. They are only matter, in the sense that they appeal to our sense of force through the motion which they may acquire.

Or again, take air, which is a mechanical mixture of several gases. Can you see air? If it be free from vapour and smoke, air is invisible, and on a clear day you may look for miles across the sea, or from the top of a mountain, and yet not have your sight impeded in any way by the atmosphere. Neither can it

be felt by the sense of touch. Open and shut your hand, and see if you can feel the air while you do so. In similar ways it may be demonstrated that the air is tasteless. So that it is not necessary for us to see, or feel, or taste, or even smell that which we term Matter, in order for it to be included in that term. So long as that which we term Matter is able to accept motion in any manner from any body that is either moving, or in a state of vibration, and not only accepts, but also transmits the vibratory, or the kinetic motion so called of the moving body, then that which accepts the motion is legitimately termed Matter.

It becomes perfectly clear, therefore, why air, aether, oxygen, and hydrogen are termed Matter. Because they can be all acted upon by motion, and after being so acted upon, they can exert motion upon some other body. Heat is a form of motion, and when heat acts upon the air, the latter is set in motion, and we have what are commonly known as winds. It is unnecessary for me to prove that the motion of winds can be transmitted to other matter, as we have numerous examples from our observation and experience, in the case of windmills driven by the motive power of the winds, and also balloons urged along by the same cause; apart from the devastating effect produced in towns and country by a hurricane or storm.

The point which I wish to emphasize is, that Matter, strictly defined, is that which can be acted upon by motion, such as heat or electricity, both being forms of motion, and which can exert the motion so derived upon some other body.

Wherever, therefore, in the universe we find any body, whether it be solid, liquid or gaseous, or any medium which can be acted upon by motion, and after being so acted upon, can exert motion, that body or medium may legitimately be included in the term Matter, although it may be absolutely invisible to the eyes, or insensible to the sense of touch, or taste, or smell. In the same work,¹ Tait states that in the physical universe there are but two classes of things, "Matter and Energy," and then goes on to give examples of both. He adds that a stone, piece of brass, water, air, *aether*, are particles of matter, while springs, water-power, wind, waves, heat and electric currents are examples of energy associated with Matter.

Now I may add here, that within these two statements is to be found the germ of the physical cause of Gravitation, together with the satisfactory explanation of all phenomena that the universe reveals to us, either by observation or by experiments. I purpose therefore, before giving any detailed accounts of that medium which is to form the physical basis for the cause of

¹ Tait, *Natural Philosophy*.

Gravitation, to look at the term Matter in all its aspects, in order that we may get a right conception of the universe, and of the part that Matter plays in the same.

ART. 30. *Conservation of Matter.*—The Theory of the Indestructibility of Matter was first introduced by Lavoisier in 1789. This theory may be thus summed up; that Matter which fills the universe is unchangeable in quantity, so that the total quantity ever remains the same. Changes may take place in regard to the state of the Matter, but the sum-total of Matter throughout all the changes remains unaltered. Thus when we burn coal, it is changed into carbonic acid by combination with the oxygen of the atmosphere; when sugar is put into water, it simply passes from the solid to the liquid condition. If a piece of iron or steel is allowed to rust, the surface of the iron has entered into combination with the oxygen and water of the atmosphere, and formed a new substance. So that a body may change from solid to liquid, as for example from ice to water, or from liquid to a gaseous condition, as from water to steam, and probably from a gaseous condition to an aetherial condition as we shall see later on, but the sum-total of Matter throughout all these changes ever remains the same. Thus, throughout all the physical and chemical changes that Matter may undergo in the universe, there is no actual loss in weight or quantity. Throughout the whole realm of Nature we do not find a single instance of the production of absolutely new Matter. We may, and can produce new combinations of the forms of Matter. The substance so formed by chemical combination may be different from anything that has ever been seen or produced before, but the elements of which it is formed must have existed in some other form before its production.

This principle is the great underlying principle of all chemical investigation and research, and may be proved at any time by means of the scales or balance in the laboratory. Lavoisier first made the experiment with the scales and proved this truth by actual demonstration.

ART. 31. *Matter is Atomic.*—The hypothesis that Matter is made up of infinitely small particles which are termed atoms, was first proposed by the Grecian philosophers. This hypothesis has gradually taken definite shape, but it remained for Dalton to first put the hypothesis into a connected form, and that form is now known as Dalton's Atomic Theory.

According to this theory, an atom of hydrogen was the lightest atom known, but comparatively recent researches by Sir W. Crookes have shown that there are possibly in existence minute particles which are even lighter than an atom of hydrogen. Thus Sir W. Crookes has suggested that there are certain

particles associated with an atom of hydrogen which are 700 times less in weight than the atom itself.

Professor J. J. Thompson has further suggested that if we could divide an atom into a thousand parts, and could take one of those parts, we should find that this corpuscle, as he has termed it, would be the carrier of the charges in an electric current, so that it will be seen that we are moving into the direction of the continuity of Matter. Let us now look at the question as to what is meant by an atom more fully.

ART. 32. *What is an Atom?*—Clerk Maxwell's definition of an atom is, "a body that cannot be cut in two." An atom is the smallest part of a simple substance which can enter into combination with another element, and is incapable of being further subdivided.

An atom of hydrogen is the smallest part of that particular gas which can enter into combination with any other element, as oxygen, to form a chemical compound as water, which is composed of two atoms of hydrogen and one of oxygen.

Further, an atom of any kind or sort, retains its identity and remains the same throughout all chemical combinations or physical changes which it may undergo. By spectroscopic analysis, it has been ascertained, for example, that hydrogen exists in the sun and stars, and the conclusion is arrived at in connection therewith, that an atom of hydrogen in any sun or star is the same as an atom of hydrogen in our atmosphere, or in any of the compounds, as water, in which it is found. Thus it has come to be received as an accepted fact, that every atom of any substance, as oxygen, nitrogen, and hydrogen, whether they exist in the earth or sun, in meteorites or the farthest stars or nebulae, wherever they are found, possesses the same identity and the same physical properties.

Atoms attract one another, and this atomic attraction is known as affinity. There is not the least possible doubt that affinity is a form of universal attraction, except that the affinity of atoms is selective. This affinity of atoms for each other gives rise to the combination of atoms known as molecules and chemical compounds.

Size of Atoms.—It has been computed by Lord Kelvin and others, that an atom may be as small as $\frac{1}{100,000,000}$ of an inch in diameter, so that if 50,000,000 of them were put side by side, they would just measure one inch in length. Atoms are not all of the same size or weight. An atom of oxygen weighs 16 times as much as an atom of hydrogen. It has been proved by Kirchoff and Bunsen, that the $\frac{1}{1,000,000}$ part of a milligramme of sodium chloride is sufficient to give a yellow colour to a gas-jet. Faraday prepared some sheets of gold, so thin that he

estimated they only measured the $\frac{1}{10^8}$ part of the length of a light-wave. We have to remember that each sheet of gold must have contained molecules of gold composed of atoms. What must have been the size of the atoms therefore of which the sheet was composed?

ART. 33. *The Atomic Theory.*—The Atomic Theory was revived by Dalton in 1804, in order to account for the fact that elements unite in certain definite proportions. From that time to the present, the theory has grown and developed until at the present time it is looked upon as a well-established theory. It is, however, simply a theory, and from the very nature of the hypothesis is incapable of proof. No one has ever seen an atom of hydrogen or oxygen, or an atom of any solid, liquid, or gaseous matter. The Atomic Theory suggests, therefore, that there is a limit to the divisibility of matter. All chemical experiments lend support to the theory, and by it we are able to give an intelligible and easy method of expression to what would otherwise be difficult phenomena to explain.

Ancient philosophers were divided on the question of the infinite divisibility of matter. The Epicureans were of the opinion that matter was incapable of infinite division, and that even if we were able to make the smallest possible division, it would be impossible for us to reach the smallest particle termed "Atom."

ART. 34. *Kinds of Atoms.*—Various forms of atoms have been conceived by philosophers from time to time, ranging from the Hard Atom, and the simple point-centres of Boscovitch, until we come to the more modern Vortex Atom of Lord Kelvin, or the Strain Atom of Dr. Larmor, which will be looked at separately. Democritus conceived a hard atom as long ago as 500 B.C., while the notion of a hard atom is not absent from the works of Newton himself. We find that Newton suggested that the particles of air might be hard spherical bodies, at a distance from one another of about nine times their diameter.

The hard atom, however, seems to be refuted by spectroscopic analysis, which reveals to us in a manner that has never been revealed before, something of the sizes and vibrations of atoms.

From the phenomenon of heat, which is simply matter in motion, we feel compelled to accept the fact that an atom is not a hard particle, but that it is something which is more closely allied to the Vortex Atom, or the Strain Atom of Dr. Larmor.

Boscovitch Atom.—According to Boscovitch's theory, each atom is simply an indivisible point in space capable of motion, and possessing a certain mass whereby a certain amount of energy is required to produce a certain change of motion. In addition to this, any two atoms could attract or repel each other

with a force depending upon their distance apart. The Law which regulates these forces for all distances greater than $\frac{1}{1000}$ of an inch is an attraction varying inversely as the square of the distance, and a repulsion for less distances.

We have, therefore, to suppose that in place of the hard atom, there is merely a geometrical point which can exert attractive or repulsive forces to, or from, the central point. So far as external particles are concerned, they would behave just the same as a hard atom would do. This conception was largely entertained in recent times by Faraday. It is more a mathematical explanation than a physical one, but has been found convenient in explaining what takes place in the interior of bodies in their three states, namely: solid, liquid, and gaseous.

Lord Kelvin's Vortex Atom.—Another hypothesis which has been suggested for the constitution of an atom, is that known as the Vortex Atom, which received its birth at the hands of Lord Kelvin. The underlying principle of this Vortex Atom is, that matter may be entirely due to the rotating parts of a fundamental medium, the Aether, which fills all space.

The properties of vortex motion were first mathematically calculated by Helmholtz, but it was left to Sir Wm. Thompson, now Lord Kelvin, to give a physical idea of the Vortex Atom.

Before entering further into the question of the Vortex Atom, it may be as well to explain how vortex smoke rings may be made.

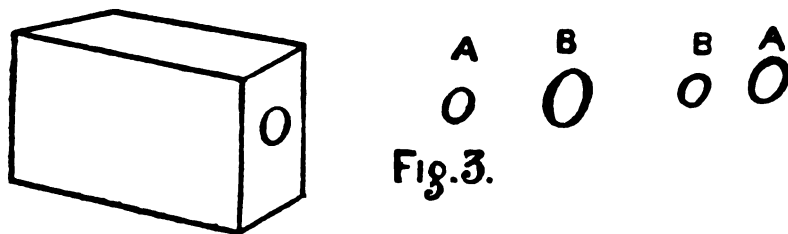

Fig. 3.

All that is required is a wooden box, about one cubic foot in size, with a round hole perforated in one of the sides, and the opposite side covered with a piece of linen in place of the wooden side. The bottom of the box should then be covered with some strong solution of ammonia, and some hydrochloric acid poured into a saucer and put into the box. The combination of these two will cause thick clouds to form in the box, and if the linen is sharply tapped by the hand, a ring of this cloud will be forced through the hole on the opposite side of the box. The ring so formed will be circular in shape, and will go sailing through the room in which it is made.

When the hole is circular, the rings will be found circular also, but if the hole is square, then the rings will be irregular in shape. One remarkable characteristic about these rings is, that when two of the rings are travelling in the same straight line, the one behind will overtake the front one, and while so doing, the diameter of the front one is enlarged, while that of the one behind contracts. The front one will also travel slower, while the one behind travels faster until it has caught up the former, and then the latter, having contracted sufficiently, will pass through the diameter of the former as illustrated in the figure. This alternation of contraction and expansion is continued as long as the two rings move in the same plane and until they are destroyed. When, however, the two rings are moving in opposite directions, and meeting each other in the same straight line, they will repel one another, instead of attracting each other.

Their rate of progress is gradually reduced as they approach together, and they begin to expand and enlarge, but they never touch each other. Another peculiar feature about the rings consists in the fact, that the central core of air in the ring remains the same all the time the ring is in motion through the room, so that it has the same core of air at the end of its journey as it had when it left the box.

As Lord Kelvin pointed out, if there were no friction of the air, the ring once created would rotate for ever. If, therefore, there were such a thing as a perfect fluid, and there were vortex rings in it, nothing could destroy these rings when once they were created, and this is one of the most striking suggestions with reference to the Vortex Atom theory of matter. It remains to be seen whether in the universe we have such a medium as a perfect fluid.

Sir Wm. Thompson has applied the Vortex Atom theory of matter to the Aether, but from mathematical calculation he was unable to arrive at a satisfactory conclusion as to the Aether being composed of vortex atoms.

Another remarkable property belonging to these rings, lies in the fact that they cannot be cut in two. It will be found that when the knife is brought near to them, they seem to recoil from the knife. In that sense, it is literally an atom, a thing which cannot be cut in two.

The Vortex Atom has many recommendations in its favour. Many of the most important properties of matter are possessed by it, as for example indestructibility, elasticity, inertia, compressibility, and its incapability to be cut in two. Further, it may be linked with another ring, and so give the basis to the combining properties of atomic weights.

The Vortex Atom theory is simple in character, as it does not postulate any extravagant hypothesis, but makes use of the Aether as the common basis for all matter, simply stating that this property of rotation may be the basis of all that we call matter. We shall further consider the relation of the Vortex Atom to matter, when we deal with the constitution of matter and the unity of the universe.

ART. 35. *Elements of Matter*.—As is well known, modern chemistry has succeeded in reducing all the complex forms of matter in Nature into a number of simple substances, which are called elements. Of these elements about seventy are at present known, some of which, however, are very rare. An element therefore is a simple substance which cannot be decomposed by any known force or process, as heat or electricity, into other elements.

There are, however, only about fourteen of these elements that enter largely into the constitution of the earth, the most common being oxygen and silicon. By the use of the spectroscope, it has been proved that many of these elements, as for example oxygen, hydrogen, sodium and calcium, exist in the sun and stars, as well as in the most distant nebulae. Most of the elementary bodies are to be found in a gaseous form as hydrogen, oxygen, fluorine and chlorine, though it has been found possible to liquefy even these gases. Thus we see that matter may be roughly divided into three states, viz. solid, liquid, or gaseous.

The condition in which the substance is found depends upon its temperature and pressure. An example of matter in its three stages is best shown in the case of water, where in the solid condition we have it as ice, in the liquid condition as water, and in the gaseous condition as steam.

By recent researches it has been found possible to liquefy gases at a very low temperature and increased pressure, with the result that now nearly all known gases as hydrogen, oxygen, and carbonic acid are to be obtained in liquid form. By still more recent experiments made by Professor Dewar, it has even become possible to liquefy the air we breathe, with the result that at a temperature of about 270 degrees below freezing-point and at an increased pressure, the otherwise invisible and gaseous air may be changed into a liquid, and poured out from one vessel into another in the same way that water can be poured out. A vessel, however, at the ordinary temperature into which such liquid air is poured, would be so hot compared with the coldness of the liquid air, that as soon as the exceedingly cold liquid air came into contact with the vessel, the comparatively hot vessel would make the liquid air to boil.

ART. 36. *Three Divisions of Matter*.—Matter has been divided

into three divisions, viz. solid, liquid, and gaseous. These divisions are each known by characteristic qualities, which separate the one division from another. At the same time, it is possible for matter to pass from one division into another, as for example in the case of water, which may exist in solid, liquid, and gaseous form. In view of the recent researches of Sir. Wm. Crookes and Professor J. J. Thompson, it is very probable that before long we shall have to add a fourth division to matter, which we should have to call ultra-gaseous form, or it may possibly be the aetherial form. If it should prove to be true that Aether is matter, and possesses the essential qualities of matter as suggested by Lord Kelvin, then certainly we shall have reached the boundary of another great division of matter, and our conception of the divisions of matter will have to be enlarged to take in that form, so that matter would then be divided into four great divisions, viz. solid, liquid, gaseous, and aetherial.

We will now consider the three groups as at present recognized.

Solid.—Examples of solid bodies are common and familiar, and are typified by such things as iron, silver, copper, and lead. The chief characteristic of this condition of matter is that its condition or state is fixed, and cannot be altered without the expenditure of heat or electricity or some other form of energy.

All solid elementary substances, with the exception of carbon, can be melted or reduced to a molten condition, although some of them require a very high temperature to effect this reduction, as, for example, platinum. When a still higher temperature is applied, the metals may be vaporized, or reduced from a molten state to that of a vaporous condition. In the case of solids, the atoms have not a free path in which to move. It must not be thought, however, that the atoms of a solid are motionless, as there is nothing absolutely motionless in the universe. In the case of the solid, the molecules which compose it, preserve their relative position and are linked together in relation to each other by the force of Cohesion.

Liquid.—When matter is in a liquid condition, as, for example, water and oil, the condition of its molecules are not so fixed and stable as they are in the solid state. The molecules can move freely about one another, and their freedom is increased compared with their condition when in the solid state.

As already indicated, the reduction of a solid body to a liquid or molten state may be effected by heat. When heat is applied to a solid body, several results follow, each of which is the outcome of the other.

1. There is an increase of temperature which is due to the increased energy of the molecules, through the added heat.

2. There is an enlargement of the volume or size of the body, and if the addition of heat be continued, the molecular forces which hold the molecules together are broken down, and then the molecules, loosened from those forces which in the solid state have bound them together, begin to move about with greater freedom, and thus give rise to the molten condition of metals, or liquid condition of water. Thus, it is the heat which has set the atoms which compose the molecules in motion. The atoms of the solid have absorbed the heat, and the heat which has thus been absorbed has imparted vibratory energy to the atoms, which they did not possess before. Now when a substance is in the liquid state, the atoms of that substance have not only a vibratory motion, but have also a translatory motion, so that they can move in and out among one another. This is proved by the phenomenon of diffusion, where we have the case of two different-coloured liquids, for example, intermingling with each other, which is conclusive evidence of the translatory motion of the atoms in liquids.

Gaseous.—The third state in which matter is found is the gaseous state. In this condition, the particles of matter which form the gas have the greatest possible freedom of movement, and are able to move about with inconceivable velocity. There is abundant evidence to prove that gases consist of particles of matter which are perfectly free, and are able to fly about in all directions. The simplest proof is obtained by mixing two gases together, as, for example, when any gaseous substance is allowed to mix with the air of a room, when we find that the particular gas soon mixes itself thoroughly with all the air in the room. This process of mixing is known as Diffusion, and the lighter a gas is, the more quickly does it diffuse itself. The rate of movement of the various particles is varied, by reason of the encounters which each particle undergoes from time to time. Through experiments made by Joule, he arrived at the conclusion that particles of hydrogen attained a velocity of 6055 feet per second at 0° C., which is a velocity much greater than that of a cannon-ball. In spite of the enormous velocity with which a particle of hydrogen would move, there are such a large number of particles in a single cubic inch of space, that no one particle has an absolutely free path from the one side of the enclosed space to the other. To this constant movement of the individual particles is due the elasticity or pressure of gases. The outward pressure which they exert on any body which encloses the gas is caused by the total effect of the impact of the particles, and is proportional to the sum of their masses multiplied into the

E

square of their velocities. If we halve the enclosed space, then we should double the number of impacts in a given time, so that the number of impacts is inversely as the volume of the gas. This is equivalent to the statement, that the pressure of a gas varies inversely as its volume, which is Boyle and Marriotte's Law.

ART. 37. *Matter is Gravitative.*—If there is one property which is essentially characteristic to all matter, it is that all matter is gravitative. To this rule there is no exception, as the universal Law of Attraction states that "every particle of matter attracts every other particle." Thus, wherever in the whole universe there is a particle of matter of any kind or sort, whether such matter be solid, liquid, or gaseous, there the force of attraction will be exerted with a force proportionate to the mass of the particle, and inversely as the square of the distance between the attracted particles.

Gravitation, then, is a property which is essentially inherent in matter, and any substance which is termed matter, or fulfils the conditions that govern matter, must be gravitative, whatever other property it may, or may not, possess. Unless this be so, we should have a violation of the universal Law of Gravitation, which would cease at once to be a universal law, for instead of reading "every particle of matter attracts every other particle," we should have to say that "some particles of matter attract some other particles," which would be a violation of that universal law which, through the genius of Newton, has given to the universe an unity from the philosophical standpoint that it did not possess before.

Some matter may, or may not be elastic; it may, or may not be solid, or liquid, or gaseous; but there is this fact regarding matter which is absolutely undeniable, and that is, "All matter is gravitative."

That this is true of each and all kinds of matter has been proved by direct experiment times without number, and the constant application of the law to all forms of matter is a fact observable from the phenomena incidental to every-day life. Astronomical observation teaches us also, that all stars, suns, planets, satellites, and comets are subject to this great Law of Gravitation, as indeed they must be if they are composed of matter. That they are all composed of exactly similar elements of which the earth is composed, has been proved again and again by spectroscopic analysis, which teaches that hydrogen, iron, and calcium, etc., are to be found in distant stars and nebulae, as they are equally to be found in the composition of the earth. Thus throughout the wide universe so far as observation and experiment can teach us, we learn that without any exception,

everything that is termed matter is subject to this universal Law of Gravitation.

ART. 38. *Matter possesses Density.*—Density is that property of matter which decides the weight of a body per unit of volume.

The density of any substance may be shown in several ways. It may denote, first of all, the number of molecules in a given body. Let us take as an illustration, the case of air being forced into a vessel of a given size, say one cubic foot capacity. We will suppose that in such a vessel there are 1,000,000 molecules. If we pump in a quantity of air equal to the amount it contained at first, then it is obvious that we have doubled the number of molecules in the same vessel, and therefore we say we have doubled the density. Not only so, but the weight of the air in the vessel will have been doubled. Looked at from this standpoint, density means the number of molecules in unit volume such as a cubic inch, or cubic centimetre.

Again, as has already been shown in Art. 35, the different elements have different atomic weights. Thus an atom of carbon weighs twelve times as much as an atom of hydrogen, that is to say, there are twelve times as much matter by weight in an atom of carbon as there is in an atom of hydrogen, so that it would take twelve times as many hydrogen atoms to weigh a pound as compared with the number of atoms of carbon. This is only another way of stating that carbon has twelve times the density of hydrogen. If we compare lead and silver with hydrogen in the same way, we find that the density is 206 times and 107 times greater than that of hydrogen.

Thus, it may be seen, that all matter possesses density, and that that density depends partly upon its atomic constitution. If the molecule of matter is composed of atoms whose atomic weights are very large compared with that of hydrogen, as iron, silver, lead and gold, then the molecules will have a much greater density, than a molecule formed of oxygen and hydrogen, *i.e.* water. This property of the density of matter plays a most important part in the transmission of any kind of wave-motion.

ART. 39. *Matter possesses Elasticity.*—Matter possesses elasticity. Elasticity is that property of matter which enables all bodies to resume their original shape, when the pressure which has caused the alteration of shape has been removed.

For example, suppose an ivory ball be dropped upon a marble table, or any other hard surface. It will then rebound, and rise almost to the same height from which it was dropped. If the surface upon which it fell was first covered with blacklead, a circular spot of lead will be found on the ivory ball. From this fact, we arrive at the conclusion that when the ball came into

contact with the table, at the moment of contact it was flattened, and then owing to its elasticity it rebounded into the air again.

Now the measure of the elasticity of a body is proportionate to the velocity of the wave-motion which it can transmit. A good illustration of the transmission of wave-motion may be shown with a number of ivory bagatelle or billiard balls. If eight or more of these be put in a row, all touching each other, and a single ball be placed about an inch or so away from the others in a straight line with them, then when the single ball is struck with a cue against the other eight, the motion of the single ball is transmitted by each one of the eight successively with such rapidity, that the end ball would be set in motion in a quicker time than a single ball would take to reach the end ball, if it had been free to move along without encountering any opposition.

It is a fact capable of demonstration, that the smaller the particle of matter, the greater will be its vibratory motion. Thus the particles of air are very, very small, and consequently air is found to be very elastic, and allows sound to be transmitted through it with comparatively great velocity, some sounds travelling at the rate of over 1000 feet per second.

A most important factor in determining the propagation of any wave-motion, through a gas or solid, is the relationship of the elasticity of the gas or solid to its density. Suffice to say, that the velocity of any wave-motion is determined by the relation of the elasticity to the density. For example, sound, which is a wave-motion of the air, can not only be transmitted through gaseous bodies as air, but also through liquids and solids. Sound travels faster through solids than through liquids, and faster through liquids than through gases. In liquids, the relation of the elasticity to density is greater than in air, and in solids the relation is greater still. Therefore sound travels much faster in liquids than in gases, and faster in solids than in liquids.

This is the reason why a train can be heard coming if the ear is put to the railway-line, when no indication of its approach is given to the ear by the atmosphere. Some examples of the velocities of sound through different substances are as follows—

GASES O. C.		LIQUIDS.		SOLIDS.	
FEET		FEET		FEET	
Air	1090 per sec.	Water	4708 per sec. (8° C.).	Gold	5717 per sec.
Oxygen	1040 " "	Alcohol	4218 " " (20° C.).	Silver	8553 " "

ART. 40. *Matter possesses Inertia.*—Inertia is that property of matter, by which matter cannot of itself alter, or change its state of motion, or of rest.

Newton's first law of motion states that a body at rest remains

at rest until some force or motion acts upon it. If a stone be dropped from a balloon, the stone does not fall because of any property which it possesses, but because the force of gravity acts upon it. If it were possible to eliminate this force of gravity, then if there were no other force which could act upon the stone, it would remain suspended in space.

The inertia of a body is equal to the mass of that body, or the amount of matter in the body as measured by gravity, so that if a body is halved, its inertia will be halved also, and if doubled, its inertia will be doubled also. As the inertia of matter opposes all kinds of motion, the amount of force required to overcome the inertia of a body is proportionate to its mass. So that if the mass of a body is doubled, then twice the force would be required to move it, while if the body were halved, half the force would suffice to do it.

Inertia is possessed quite as much by a moving body as a body at rest. The definition given points this out, as it states that matter cannot of itself change its state of motion. If a body therefore is in motion, it requires a certain amount of resistance to bring the body to a state of rest, or the loss of an equal amount of energy, by friction or otherwise, equal to the quantity which it absorbed in order for it to be set in motion.

We get numerous examples of this property of the inertia of bodies in our daily experience. Many of the accidents that befall people in various ways are due to this property of the inertia of matter. A cyclist is riding a machine down-hill, and loses control over his machine, with the result that he runs into a wall, and is killed. Now what has happened? The cyclist has participated in the motion of the machine, with the result that when the machine has been suddenly stopped, the body has been thrown forward owing to the momentum it had acquired.

We are constantly being affected by the property of inertia of matter, in tram and train and bus. Whenever any of these are suddenly stopped, or suddenly started, we are thrown either backward or forward, owing to the body either not having acquired the motion of the train, or, having acquired it, is unable to lose its motion as quickly as the train, and is therefore thrown forward.

CHAPTER IV

AETHER IS MATTER

ART. 42. *Aether is Matter.*—The hypothesis of an Aether which fills all space was made in order that scientists might be able to account for certain phenomena of Light, which otherwise were difficult to account for. Its existence is demanded not only for the phenomena of Light, and Heat, but, in view of the comparatively recent researches of Hertz on "Electric Waves," of Electricity also.

The Aetherial Medium is generally assumed to be that fundamental medium, by means of which possibly all the properties of matter, and all the phenomena of motion of the universe are to be explained. Light and Heat have been proved to be due to the periodic wave-motion of this universal Aether, while from the investigations and researches of such men as Clerk Maxwell, Poynting, Thompson and Hertz, it has been proved that electro-magnetic phenomena are due to this same medium.

Several different forms of Aether have been postulated by various philosophers from time to time, but the only Aether that has survived, is that which was first conceived by Huyghens to explain the phenomena of Light, though it was Thomas Young who finally succeeded in placing the conception of the Aether on a sound basis. Each discovery of science has only strengthened the hypothesis and existence of the Aether, the latest discovery, that of wireless telegraphy so successfully developed by Signor Marconi, being attributed to the electro-magnetic properties of this self-same Aether.

It has already been pointed out that Newton endeavoured to account for Gravitation by the pressure of the Aether. If, therefore, Gravitation be really due to this universal medium it becomes necessary to ask ourselves, What are the properties and characteristic qualities of this wonderful medium? What then is Aether, and what its properties?

It has already been pointed out in Art. 29 that Aether is matter. Such an assumption is strictly in accordance with the Rules of Philosophy, quoted in Chap. I.

Not only is this hypothesis a simple one, but it is also in accord with all our experience and observation.

It is a simple supposition, because, unless Aether is assumed to be matter, then, instead of the universe being composed of two classes of things, matter and motion, we have to add a third class, which we call Aether. It can be readily seen, that by the introduction of a third class into the composition of the universe, such an addition, instead of simplifying the constitution of the universe, adds greater complexity to the same.

By accepting the hypothesis that Aether is matter, we do away with the third class of essentials in the universe, and so reduce the number to two classes. If we could go one step further, and prove that instead of there being two classes of things in the universe, there was only one group, and show that all material things, and all phenomena could come under the head of either matter, or motion, then we should have reduced the universe to the simplest conception possible. As, however, it is not possible, at least in our present state of knowledge, for us to come to this fundamental and simple hypothesis of unity for the entire universe, we must accept the next simpler solution, and affirm that the universe is composed of two classes of things, viz. matter and motion, and this as I have already shown is a simpler classification than by putting Aether into a class by itself, and therefore is in accord with our first Rule of Philosophy.

Again, it is entirely in accord with our second Rule of Philosophy, as it in no way violates the results of experiment, experience, or observation. Look where we will, or at what we will, whatever we see, touch, taste, or smell is termed matter. The burning sun, the glowing star, the flying meteor, the glowing comet, the earth, our own island home, the towering rock, the wide ocean, the running river, the green trees of the forest, the tiny insect, the lordly elephant, all animals, plants, and our own physical body, all are composed of matter, either in solid, liquid or gaseous form. Therefore when we affirm that Aether is matter, the affirmation is strictly in accordance with the elementary principles of Philosophy, and in no way violates their rules or laws. To affirm that Aether is not matter, is to affirm something contrary to all experience, unless it be affirmed that Aether is motion, for which assumption the evidence is not nearly so strong or conclusive as that it is matter. Therefore the objector to this assumption is himself unphilosophical, in that he postulates or supposes that the Aether is a medium, with qualities which lie altogether outside the range of our experience and observation.

There is a growing conviction in the minds of scientific men, that Aether belongs to that group of things which we describe

by the term matter. Lord Kelvin in giving an address to the British Association, 1901, on "Clustering of Gravitational Matter in any part of the Universe," said: "We are all convinced with our President (Professor Rucker) that *Aether is Matter*. Aether we relegate to a distinct species of matter which has inertia, rigidity, elasticity, compressibility, but not heaviness."

Dr. Larmor in *Aether and Matter* writes: "Matter must be constituted of isolated portions, each of which is of necessity a permanent nucleus belonging to the Aether, of some such type as is represented for example by a minute vortex ring in a perfect fluid."

Faraday in relation to this subject writes (*Exp. Res.*, vol. ii.): "The view now stated of the composition of matter would seem to involve the conclusion that matter fills all space, or at least all space to which Gravitation extends, *including the sun and its system*, for Gravitation is a property of matter dependable on a certain Force, and it is this Force which constitutes matter." As the Aether fills all space, including the solar system, therefore, according to Faraday, "Aether must also be Matter."

By the hypothesis that Aether is matter, with all the properties that such a hypothesis logically gives to Aether, I venture to premise that the third Rule of Philosophy will be fulfilled, and that there is no phenomenon of the astronomical world, and no part of the universal Law of Gravitation which such a hypothesis will fail to account for on a satisfactory physical basis. For the first time a physical explanation will be given to Newton's Laws of Motion, at least to those laws which are strictly in accordance with the first and second Rules of Philosophy. For the first time a physical conception will be given to all Kepler's Laws, and what the mathematical Laws of Gravitation have done to Kepler's Laws, in giving them a mathematical basis, the simple hypothesis that Aether is matter, with all that is logically involved therein, will do for the same laws from the physical standpoint. For the first time a physical conception will be given to the Centrifugal and Centripetal Forces, which are the complement and the counterpart of each other, that physical conception being the outcome of the same hypothesis that Aether is matter.

In addition to this, light is thrown upon such problems as are referred to by Lord Kelvin (*Phil. Mag.*, July 1902) in his paper on "Clouds on the Undulatory Theory of Light," and further light is given to some theories of Electricity advanced by such men as Faraday, Clerk Maxwell, and Professor Thompson. I venture to think, therefore, that the hypothesis advanced, and the conception put forward that Aether is matter, is philosophically correct, and is warranted by the results that arise out of such a hypothesis.

It may be thought by some that the hypothesis that I have advanced is already conceded, and that the fact that Aether is matter is already admitted by scientists and advanced thinkers generally. But such an idea is only partly correct. It is already admitted by some of our most advanced scientists that Aether is matter, but that admission is only carried partially to its logical conclusion.

Lord Kelvin in an address to the British Association, 1901, gave utterance to the following remarks on the relation of Aether to Matter: "We are convinced with our President (Professor Rucker) that Aether is Matter, but we are forced to say that the properties of Matter are not to be looked for in Aether, as generally known to us by action resulting from force between atoms of Matter and atoms of Aether. *Here I am ILLOGICAL when I say between Matter and Aether*, as if Aether were not Matter. Aether we relegate to a distinct species of Matter which has inertia, rigidity, elasticity, compressibility, but NOT HEAVINESS."

From a quotation of this kind, which is from the lips of one of the keenest intellects of the present time, I think I am justified when I make the statement, that it is not conceded that Aether is matter, with all that that concession logically involves. Because, as Lord Kelvin points out, though it is admitted that Aether is matter, yet that admission is only a qualified admission, and not one which carries with it all the properties that essentially belong to matter, or an admission which includes the fact that Aether is gravitative, that is, subject to Gravitation. To be strictly logical and philosophical, in the statement that Aether is matter, it must be conceded not only that Aether is subject to such properties as elasticity, inertia, and compressibility, but that it is also gravitative or possesses weight. For either Aether is matter, or it is not matter.

It cannot be both at one and the same time. Such a conception is altogether opposed to that simplicity which is the chief characteristic of Nature as pointed out by Newton.

If therefore Aether be matter, then, to be strictly logical and philosophical, it must be conceded that Aether is gravitative, as well as having the other properties of matter, as elasticity and inertia, etc. Unless this is conceded, then we have the anomaly in Nature of matter, which is not matter, because it violates the very principles which above all others decide what is matter, viz., "That every particle of matter attracts every other particle," etc., that is, that it is gravitative. Thus by supposing that the Aether is matter, and yet not being gravitative, all the Rules of Philosophy are violated, as such a hypothesis is opposed to both the first and second Rules of Philosophy, and is contrary to all

observation and experience. If Aether therefore be matter, as is conceded by the most advanced thinkers of the time, then it follows that the only logical and philosophical conclusion that can be arrived at is, that it is also subject to those properties which are the chief characteristics of all matter. These properties may be classified as follows: atomicity, gravitation, density, elasticity, inertia, and compressibility.

ART. 43. *Aether is Universal*.—Young in his first Hypothesis on the Aether medium states that, "A Luminiferous Aether pervades the Universe rare and elastic in a high degree" (*Phil. Tran.*, 1802).

As Young points out, this invisible and elastic Aether fills all space and floods the universe at large. In it suns blaze, stars shine, worlds and planets roll, meteors flash, and comets rush in their mysterious flight. In it all material and physical things exist, for it is to them not only the primary medium of their existence, but, just as the infinite and ever-active energy of the Divine is to the universe in its entirety and fulness, the exciting and stimulating spirit of its energies and powers, so this aetherial ocean is to the material and physical universe, the exciting and stimulating medium of all its activities, energies, and powers; and without which, though all material and physical things were endowed with the varied capacities of their kind or life, yet they could neither exert nor exercise them, nor even exhibit the simple activity of motion. Hence everywhere, where material and physical things are, there, as the medium of their existence and energy, the Aether is; and where the Aether is not, no material or physical thing is, or can be. That the Aether is universal is proved by the phenomena of light. Light-waves have a velocity of about 186,000 miles per second. Now the distance of the sun from the earth is about 92,000,000 of miles, so that light takes about eight minutes and a half to travel from the sun to the earth.

A ray of light from the nearest fixed star takes about three and a half years to reach the earth, while there are some stars so far away that astronomers tell us, that though light travels with so great a velocity, yet it would take several thousand years to reach the earth. This fact implies that throughout boundless space there is to be found this aetherial medium. Thus interplanetary and interstellar space is not empty, but is filled with this ever-present, all-pervading Aether; and not only so, but every particle of matter in the universe is surrounded by this universal Aether, which forms the exciting and stimulating medium of all the activities, energies, and motions of all Matter. Thus the Aether is both universal and infinite in its extent.

Clerk Maxwell, in his paper on "Action at a Distance"

(*Collected Works*, by Niven), with reference to the universality of the Aether, writes: "The vast interplanetary and interstellar regions will no longer be regarded as waste places in the universe, which the Creator has not seen fit to fill with the symbols of the manifold order of His Kingdom. We shall find them to be full of this wonderful medium, so full, that no human power can remove it from the smallest portion of space, or produce the slightest flaw in its infinite continuity. It extends unbroken from star to star, and when a molecule of hydrogen vibrates in the Dog Star, the medium receives the impulses of those vibrations, and transmits them to distant worlds. But the medium has other functions besides bearing light from world to world, and giving evidence of the absolute unity of the material system of the universe. Its minute parts may have rotatory as well as vibratory motions, and the axes of rotation form those lines of magnetic force which extend in unbroken continuity into regions which no eye has seen, and which, by their action on our magnets, are telling us in language not yet interpreted what is going on in the hidden world from century to century." Now I premise, that in the theory of the Aether to be submitted in this work, the physical interpretation of this statement of Maxwell's will receive its literal fulfilment.

ART. 44. *Aether is Atomic.*—If there is one fundamental truth which is applicable to all matter, it is, that all matter is atomic.

Professor Rucker, in his Presidential Address to the British Association of 1901, in dealing with this question, said: "The believer in the atomic theory asserts that matter exists in a particular state, that it consists of parts which are separate and distinct from one another, and as such are capable of independent movement. It is certain that matter consists of discrete parts in a state of motion, which can penetrate into spaces between the corresponding parts of surrounding bodies. Every great advance in chemical knowledge during the last ninety years finds its interpretation in Dalton's Atomic Theory."

From such an authority as this, and from the facts which he gave in his dealing with the question, we are bound to admit that all matter is atomic. That being granted, when the statement is made, therefore, that Aether is matter, the only logical conclusion that can be arrived at, with reference to the question of the atomicity of the Aether, is, that Aether is also atomic. Unless this be conceded, we have the first and second rules of our Philosophy violated, as an atomless Aether is opposed to that simplicity of conception, which is an essential requirement of all hypotheses, and is moreover contrary to that presumptive evidence gathered from observation and experiment, which teaches us that

all matter is atomic. If it be argued, that it is impossible to decide upon a question as to the atomicity of the Aether, my reply is that the same argument may reasonably be applied to all matter. But, as Professor Rucker stated, all the evidence on matter points out and supports the theory of its atomicity, and, therefore, the only logical and philosophical conclusion is, that Aether is atomic also. Again, it may be suggested that we cannot see or touch an atom of Aether, and that it is not only invisible, but apparently incapable of being made sensible to our senses. In reply to that, as I have already shown in Art. 31, that objection can be equally used against an atom of hydrogen, or an atom of oxygen. Does any one doubt the existence of the hydrogen atom or the atom of oxygen, because it is invisible to the sense of sight, or cannot be revealed to the limited sense of touch? Certainly not! By the same reasoning, it is just as illogical to deny the existence of an atom of Aether because it cannot be seen or felt, as it is to deny the existence of an atom of hydrogen or oxygen. An atom of Aether reveals itself to the senses in the same way that an atom of hydrogen or oxygen does, that is, by the force or energy which it exerts. Its vibrations can be manifested to the body in the form of heat, while the undulatory motion which the aetherial atoms transmit in the form of light, reveal the presence of the aetherial atom to the sense of sight. The question at once arises as to what constitutes an aetherial atom, what are its properties and motions?

Now, in order for us to enter successfully into this speculative region, it is essential that we should, as far as possible, conform to the Rules of Philosophy, and endeavour to gain some conception of an aetherial atom from the results of experience and observation. In doing this, we are at once confronted with the difficulty, that no one has ever seen an atom, or analyzed the properties of one. Actual experiment has revealed, nothing absolutely certain as to the ultimate character of an atom, and if this be true of the atoms of matter, then it must also be true of an aetherial atom. It would seem at first, therefore, that we have no results of experiment, or observation, by which we may be guided in formulating a right conception as to the constitution of an aetherial atom, and therefore we are thrown simply into the regions of speculation as to its constitution and properties.

But I venture to suggest, that there is a method which is strictly philosophical in its application, by which we may possibly arrive at a clear conception of an aetherial atom. All great discoveries of science have been the outcome of applying the principle, that what is true of the visible and seen, is true of the invisible and unseen; that what is true of the known, is true

of the unknown ; that the principles and laws which govern the small also govern the large and the great. It was thus that Newton discovered his great Law of Gravitation, as he was able from the falling of an apple, to rise to the application of the same principle to our satellite the moon, and this led him on to the discovery of the Law of Gravitation.

If, therefore, in Philosophy, the laws governing the small things are also applicable to the great things, then the converse equally holds good, that the laws governing great things are the reflex of the laws which govern the small things. For example, the laws which govern the light and heat of the sun are the same which govern the light and heat of a candle or a glow-worm ; and the laws which govern a planet or world are the same as those which govern an atom. Thus a planet or world, which is simply an agglomeration of atoms, may reveal to us in its motions and laws, what are the motions and laws which govern the atomic world.

In looking at the properties and motions of a planet, therefore, as our earth for example, we find that a planet is a sphere, or more correctly an oblate spheroid ; that the earth or planet is a magnet possessing polarity, having a north and south pole ; that it has rotation on an axis, in addition to translation in an orbit, and that it is subject to the universal Law of Gravitation.

If, therefore, it holds good in Philosophy, that the small things are the index to the greater, and that the laws governing the small things also govern the greater, then the converse holds good, that what is true of the large is true of the small, and that the laws governing the great also govern the small.

So that gathering up those chief properties of the earth to which I have already referred, and applying them to an aethereal atom, or any other atom if necessary, we arrive at the conclusion that an atom must be spherical in shape, must possess rotation, and must have an orbit, must possess polarity, and also be subject to the universal Law of Gravitation.

Here, then, we have given to us certain data by which we are enabled to form our conception of an atom, aethereal or otherwise. The question arises, whether, among the forms of atoms which have been devised by scientists, any of the atoms so conceived fulfil all, or nearly all of these requirements. We have Boscovitch's Atom, the Hard Atom of Lucretius, and the more recent conception of the Vortex Atom of Lord Kelvin. Of all the hypotheses in regard to the ultimate nature and constitution of an atom, the Vortex Theory probably is the one which offers to the mind the simplest conception of an aethereal atom.

The Vortex Ring Atom, however, which has been so fully developed by Lord Kelvin, hardly fulfils all the requirements of

an aetherial atom. In the first place it is not spherical in shape, and I hold that to be one of the fundamental bases of the aetherial atom. Then, in the next place it does not, so far as I can read, possess polarity ; that is, it does not possess a north and south pole, through being a magnet in the same way as the earth is a magnet. We must therefore look for a modification of the vortex ring to discover the constitution of our aetherial atom, and I venture to think that such a modification is to be found in Professor Hill's conception of a Spherical Vortex Atom (*Phil. Trans.*, 1894).

In the conception there put forward, and mathematically worked out, Professor Hill showed that his spherical vortex atom possessed similar properties and characteristics to the vortex rings of Lord Kelvin. So that the spherical vortex atom would possess rotation on an axis, and it would be a magnet, as I shall prove later on, because it rotates in an electro-magnetic medium. It would possess elasticity, compressibility, inertia, and, further, would possess a certain amount of mass. That mass might be infinitely small, but nevertheless it would possess mass of an infinitesimal order.

Further, if we are to be strictly correct, in our analogy between the earth and the aetherial atom, its polar diameter must be shorter than its equatorial diameter, as that is one of the facts observable regarding the shape of our earth, so that the shape of the aetherial atom will not be strictly spherical, but its actual shape would be that of an oblate spheroid, being flatter at the poles, and bulging out in the equatorial regions.

This exact analogy between the earth and an aetherial atom may not at present seem of very great importance, but its importance will be seen later on, when we come to deal with the phenomena of heat, light, and electricity.

Here, then, is our conception of an aetherial atom in the rough, based not upon any imaginative hypothesis, but rather upon that strict conformity to observation and experience, which is the very groundwork of all true Philosophy.

For, after all, what is the earth but an atom on a large scale ? In comparison with illimitable space, with its infinite distances, that can alone be measured by the velocity of light, our own earth is but a speck of dust, a very atom that helps to make up the universe, and, as such, should teach us the shape and properties of other atoms of which the same universe is composed.

We have therefore to conceive of the all-space-pervading Aether as being composed of infinitesimal portions of Aether, which are nearly spherical in shape, and ever in a state of rotation ; this state of rotation differentiating the atom of Aether from the free Aether, if such an entity exists. So that an atom

of Aether would simply be an infinitesimal portion of the Aether in a state of rotation.

If, by any means, we could stop the rotation, we should at once destroy the atom, in the same way that the smoke vortex ring would cease to be a ring, if its rotation were stopped. The cessation of the rotation I, however, believe to be impossible. So that even in the ultimate atom of that universal medium the Aether, we have an illustration of the combination of those two forms which are inseparably connected throughout the whole universe, viz. matter and motion, and it is the combination of these two that gives to the aetherial atom its form, and its very existence, without which it has no life, and ceases to exist.

It may be necessary in the development of this work as we proceed, to slightly modify our conception of the aetherial atom, but that modification will rather be of a constructive character, than a destructive one. There may also be certain objections to meet and explain away when we deal with the phenomena of light, heat, and electricity, and Gravitation, and the part which the aetherial atom plays in those phenomena, but these objections I hope to meet and answer as they arise.

The atomicity of the Aether has already been suggested by such scientists as Clerk Maxwell, Lord Kelvin, Dr. Larmor, and Professors Lodge and J. J. Thompson. Clerk Maxwell, in an article on "Action at a Distance,"¹ referring to the atomicity of the Aether, writes: "Its minute parts may have rotatory as well as vibratory motions, and the axes of rotation may form those lines of magnetic force which extend in unbroken continuity into regions which no eye has seen." I premise that I will conclusively prove that this statement finds its literal fulfilment in the theory of the Aether that will be developed in this work.

Lord Kelvin, in several articles on "Vortex Motion" in the *Philosophical Magazines* of recent years, has mathematically dealt with the Aether from the atomic standpoint, and has endeavoured to prove that the Aether medium is composed of vortex rings, but he was unable to come to any satisfactory conclusion. With the theory that Aether is matter, and therefore possesses mass, his conception is now brought within the range of physical explanation, as well as mathematical calculation.

Dr. Larmor, in his *Aether and Matter*, has successfully applied the principle of the atomicity to the Aether, on what is termed the "Electron" basis. He states that an electron is nothing more or less than "a point singularity in the electro-dynamic and optical Aether." So that our aetherial atom is practically synonymous with Dr. Larmor's electron. Again, Dr. Larmor, in the same work, states that "the atomicity of

¹ *Collected Works*, by Niven.

electricity is coming within the scope of direct experiment.”¹ But Professor Lodge, in his *Modern Views of Electricity*, states that “the Aether is composed of positive and negative electricity, the combination of these two forming the Aether medium.”² Now, if the Aether is composed of positive and negative electricity, and the atomicity of electricity is coming within the scope of direct experiment, it follows as a matter of necessity that the atomicity of Aether and the atomicity of electricity are one and the same, and therefore the atomicity of Aether is coming within the scope of direct experiment. Professor J. J. Thompson, who has also attacked the problem of the atomicity of electricity, speaks of “corpuscles” which are the actual carriers of the positive and negative electricity, in the atoms of the various elements. These corpuscles therefore indicate the fact that electricity has an atomic basis.

Now if there is any such identity between Aether and electricity, as there undoubtedly is, and electricity has an atomic basis, then the atomicity of the Aether follows as a matter of course, otherwise we shall have a medium composed of atoms which is itself not atomic, which conclusion is absurd and therefore unphilosophical. So that the most recent researches into electricity confirm and establish the atomicity of the Aether.

ART. 45. *Aether is Gravitative.*—Young, in the *Philosophical Trans.* of 1802, in regard to this question, states in his Fourth Hypothesis: “All material bodies have an attraction for the aetherial medium, by means of which it is accumulated within their substance, and for a small distance around them, in a state of greater density, but not greater elasticity.” He adds that “this fourth hypothesis is opposed to that of Newton’s.”

Scientific research has justified the conception of his first three hypotheses with respect to the universality, elasticity and vibrations of the aetherial medium, but up to the present I am not aware that science has accepted his fourth hypothesis.

I propose to show how, from a strictly philosophical and logical standpoint, his fourth hypothesis is just as true as his first three hypotheses, and that it henceforth passes out of the realm of the hypothetical into the realms of fact and science, not only by philosophical reasoning, but by actual experiment made by some of the most advanced scientists of the present time.

Let us consider the question first from the standpoint of the Rules of Philosophy. Our first Rule of Philosophy states, that any hypothesis must be simple in connection. Now I put it to any intelligent man, and ask him which is the simpler conception of Aether? To affirm that Aether is matter, and therefore

¹ Preface to *Aether and Matter*.

² Page 348.

subject to the properties of matter, as elasticity, density, inertia and Gravitation, or to affirm that Aether is matter, but while it is subject to some of the properties of matter, as elasticity, density and inertia, it is not subject to the very property which of all properties is the most fundamental, viz. Gravitation. There can, in my opinion, only be one answer to the question, so that, when we affirm that Aether is matter, we are compelled to affirm, in order to conform to the first Rule of Philosophy, that it is gravitative also. Faraday was also of the opinion that Aether was subject to the Law of Gravity, for, writing in *Experimental Researches*, he states: "The view now stated of the constitution of matter, would seem to involve the conclusion, that matter fills all space, or at least all space to which Gravitation extends, INCLUDING THE SUN AND ITS SYSTEM. For Gravitation is a property of matter, dependable on a certain force, and it is this force which constitutes matter."

Let us also test the question by our second Rule of Philosophy, and we shall find greater evidence still for the statement that Aether is gravitative. What do experience and observation teach us with reference to matter? As we have already seen (Art. 37), if there is one truth that they teach us regarding matter, it is that it is gravitative.

There is not the slightest evidence throughout the universe, as far as our observation can lead us to form an opinion, that there is any kind of matter which is not subject to the Law of Gravitation. Therefore to assume that Aether is matter, and yet not to assume that it is also subject to Gravitation, is to assume that which is directly opposed to the most fundamental principle of all philosophical teaching and scientific research. If Aether be matter, therefore, and yet is not gravitative, we shall have an anomaly in an otherwise universal law, as we shall have some kind of matter which fails to come within the scope of the universal Law of Gravitation.

To be consistent, therefore, we must either cease to call Aether matter, or else admit that Aether, like all other matter, is gravitative. It is absolutely impossible to be strictly logical and admit that Aether is matter, and not to admit that it is subject to the most universal law that governs matter, as the Law of Gravitation distinctly states that "every particle or atom of matter attracts every other particle." This universal law in view of a gravitationless Aether would have to be amended to "Some particles of matter attract some other particles." Thus the universal Law of Gravitation ceases at once to be a universal law, and such a result is opposed to all experience and experiment. Again, let us apply our third Rule of Philosophy to this supposed gravitationless Aether, and see what the result is.

F

Our third rule states, that any hypothesis put forward must satisfactorily account for the phenomena sought to be explained and accounted for. The Aether was conceived in order to explain the phenomena of light, and one of the properties it was conceived to possess was elasticity, yet that very conception was devoid of the most fundamental property of matter, without which there is no elasticity, that is, that it was not atomic.

I have already shown in Art. 44, that Aether is atomic, and therefore there is given to the Aether a structure which is capable of exhibiting elasticity, inertia, density, and even Gravitation, while at the same time, the conception is fully in harmony with philosophical reasoning and Newton's Rules of Philosophy.

Let us consider the question whether Aether is, or is not gravitative, from another aspect. For several hundred years, the physical cause of Gravitation has been outstanding, while the world has held the conception that Aether is a gravitationless and frictionless medium. The earth has been rolling on in her orbit year in, year out, together with all the other planets in their annual march round the sun, and yet through all that time no one has been able to suggest, or give any satisfactory or adequate physical explanation, as to what moves the earth along.

I am fully aware that Newton suggested and proved, that it was because of the Law of Gravitation. But I look upon that as a mathematical explanation and not as a physical one.

Now I venture to predict this, that on the assumption of a gravitationless medium, the physical explanation so longed for will always be outstanding, as a gravitationless Aether is synonymous with a frictionless medium, and so long as we admit that there is a frictionless medium, so long will the physical cause of Gravitation, and therefore the physical cause of all the movements of the planets and comets, be outstanding and unexplained.

If, however, instead of being illogical in our reasoning, we become logical, and affirm that Aether is matter, and because all matter is gravitative, therefore Aether is gravitative; and if, instead of being unphilosophical, we become philosophical, and affirm that because a gravitationless Aether violates both the first and second Rules of Philosophy, such a conception must be put away, and in its place a more philosophical conception must be forthcoming, which is that Aether is gravitative; then, upon such a logical and philosophical basis, I venture to premise that the great problem which is still outstanding of the cause of Gravitation, will remain outstanding no longer, and the physical cause of all the movements of all celestial bodies will be put upon a physical basis, in addition to a mathematical one.

If such a result can be arrived at by the logical and philosophical conception of a gravitative Aether, then the three Rules of Philosophy are fully satisfied, and the assumption of a gravitative Aether is warranted on a strictly philosophical basis.

So that Thomas Young is strictly correct from a philosophical standpoint in his fourth hypothesis, when he states: "That all material bodies have an attraction for the aetherial medium, by means of which it is accumulated within their substance and for a small distance around them in a state of greater density but not greater elasticity." He is not, however, correct when he states that though there is a greater density near the body, there is not a greater elasticity, as such an assumption is opposed to experiment and observation in relation to perfect gases, as I shall show when dealing with the elasticity of the Aether.

Again, in view of the fact that the Aether is atomic, it can now be easily understood how it may be subject to Gravitation. The very essence of Gravitation is that atoms, or particles, attract each other. If there were no particles, or atoms, it is obvious that there would be no attraction, and therefore no Gravitation. Wherever, therefore, there are to be found atoms of any kind or sort, whether they be atoms of hydrogen, oxygen, silver or aetherial atoms, there the Law of Gravitation holds good, and attraction between these atoms is to be found. In other words, any substance which is atomic, is also gravitative. Now Aether is atomic as has been shown, and therefore from that standpoint it is also gravitative. It may, however, be objected that the assumption of gravitative properties for the Aether is after all but a speculation, and that Young's fourth hypothesis was only a hypothesis, and that the gravitating properties of the aetherial medium have never come within the scope of direct experiment, without which no hypothesis can be fully accepted.

If such an argument be advanced against a gravitating Aether, then I must differ from those scientists who advance such an objection. My contention is that the gravitating properties of the Aether have already been made the subject of some of the most refined and delicate experiments that have been made during the past few years.

I refer to the experiments of Michelson and Morley of America.

For an outline and explanation of such experiments I must refer the reader to the *Phil. Mag.* of December 1887.

Now what is the result of these experiments?

I believe it is almost unanimously conceded by all scientists, that their experiments prove that the Aether is carried along by the earth. Let us carefully look at this conclusion and see what it implies in relation to the question at issue.

If the Aether is carried along by the earth, it necessarily follows that there is some governing law or principle which holds it to the earth, while the earth moves through space with its velocity of 68,000 miles per hour.

Now what is that governing principle or law, which is capable of holding such an aetherial atmosphere to its central body? If we wish to be strictly philosophical, it is necessary, according to our second Rule of Philosophy, that we should not go outside experience and the analogy of Nature.

Where is there a similar analogy in Nature to that of the Aether being carried along through space by the earth? I know of only one analogy which can be used, and that is the analogy of the atmosphere, which is also carried along by the earth through space, as it rushes on in its orbit round the sun.

That being so, the question arises, what principle or law holds the atmosphere to the earth? for, whatever be the law which governs the atmosphere, to be consistent with the second Rule of Philosophy, we must infer that the same law also holds the Aether in its place. There is only one answer to the latter question, and that is the Law of Gravitation. If it were not for that law, and the fact that the atmosphere is subject to that law, the atmosphere would simply be swept off from its central body, the earth, as the latter rushed through space with its comparatively enormous velocity.

The only legitimate and philosophical conclusion that we can arrive at, therefore, is that the Aether must be carried along with its central body, the earth, through being acted upon by the self-same Law of Gravitation, and for it to be so acted upon it must obviously be gravitative. It would be unphilosophical to suggest that it was held in its place by any other force, as that would be introducing a new force or law into Nature, contrary to our experience in relation to an exactly similar phenomenon of Nature.

We have therefore, it seems to me, direct proof by actual experiment that Young's fourth hypothesis was correct, and that not only in relation to the atomic world, but also in relation to the planetary world, and the stellar world, all bodies exert an attractive influence upon the surrounding Aether, by means of which the Aether is accumulated near the surfaces of all bodies in a state of greater density, and therefore of greater elasticity.

Let us apply this truth to the solar system, and see what we get. If it is true that the earth exerts an attractive influence upon the surrounding Aether by means of which it is held in its place relatively to the earth, then it is equally true that Mercury, Venus, Mars, Jupiter, Saturn, Uranus and Neptune also exert gravitating or attractive influences upon the surrounding Aether, in the same way that they do upon their own atmospheres. So

that in their cases also, the surrounding Aether is carried along by them through space. Professor Stokes has suggested that this is so, in order to account for the aberration of light, as we shall see later on.

Not only so, but the sun also would have an attractive power over the Aether by means of which its aetherial atmosphere would be carried through space, as it moved along in its progress at an estimated rate of 17,000 or 18,000 miles per hour.

I would like to point out here, that this explanation of the effect of the planets' attractive power over the surrounding Aether is only a partial one, as there are other effects directly involved in the fact that the Aether is subject to the gravitating influence of all satellites and planets.

This is not the place, however, to go fuller into the matter, the consideration of the subject being taken up in a later chapter.

Thus I have tried to show a gravitating Aether is strictly in accord with the three Rules of Philosophy, for it is simple in conception, is not contrary to experience, and by it I premise that it is possible to explain the physical cause of Gravitation, with all that is involved in that law.

Once more, if Aether is gravitative, then every atom and particle in the universe, as well as every planet, and sun, and star, exert an attractive power over the Aether, so that every atom is enveloped in an atmosphere of Aether, in the same way that every planet, and sun, and star is enveloped by the aetherial atmosphere.

The Aether, however, while it may flow through the spaces that exist between the molecules of bodies, yet is held bound to those molecules in the same way, and by exactly the same force, that holds the atmosphere to a planet or world.

Further, if the atoms possess different masses or weights, as they do, then each atom would possess an aetherial atmosphere proportionate to its mass, with the result that an atom of carbon, with its atomic weight of 12, ought to possess a denser aetherial atmosphere than an atom of hydrogen, and so on right through the atomic scale. I need hardly point out that this conception of the Aether in relation to atoms, and molecules of bodies, will solve certain problems relating to the density of Aether in connection with matter, which problem up to the present cannot be solved by the present conception of a frictionless medium.

That problem may be stated as follows: Does the presence of matter affect the Aether in any way, so as to load or make it denser? Professor Lodge, in *Modern Views of Electricity*, in relation to the density of the Aether, writes: "The neighbourhood of gross matter seems to render Aether more dense. It is difficult to suppose that it can really condense an incompressible fluid,

but it may load it, or otherwise modify it, so as to produce the effect of increased density."

In view of the fact that Aether is gravitative, the reply is to be found in the Law of Gravitation, "Every particle of matter attracts every other particle of matter, etc.," and as Aether is matter, it will be attracted by the other matter irrespective of whether that matter be in the atomic, molecular, or planetary or stellar form. We shall see that this is so when we come to deal with the density of the Aether.

It may be objected in relation to this aspect of Aether, that Young also asserted that the Aether flows as freely through matter, as the air flows through the trees of the forest, and that such a statement therefore contradicts his fourth proposition regarding the gravitating properties of Aether. A little reflection will, however, put a different construction on this objection.

Let us consider the analogy from the standpoint of experience, and see what that analogy teaches us. From experience we learn that the air is gravitative, but we also learn that it is possible to be moved from place to place as winds, and that as such it can move freely between the trees of the forest, causing their boughs and leaves to tremble and bend beneath its energy and power.

I have yet to learn, however, that while it moves between the trees as separate and distinct objects, such a movement militates or destroys its gravitating properties.

Does the air cease to be any less gravitative, or subject to the Law of Gravity, when it is subject to certain movements, which give rise to certain currents as winds? Such an assumption is altogether opposed to philosophical reasoning.

Whether the air is stationary or in motion, it is ever subject to the great Law of Gravitation, and accepting that as an analogy, the apparent contradiction between the oft-quoted simile of Young and his fourth hypothesis is at once removed, and from analogy we learn that it is quite possible for Aether to move between bodies because of certain currents which may be originated by heat, light or electricity, yet at the same time the existence of such currents does not violate its gravitating tendency.

Young's fourth hypothesis is therefore in perfect harmony with his oft-quoted simile, that the Aether flows through the interstices of bodies as the wind flows through a group of trees, but like the air-currents it does not so flow unless the currents are generated by some form of energy, as heat or light, electricity or magnetism.

From these considerations therefore we are compelled to come to the conclusion that Aether, like all other matter, is subject to the same universal Law of Gravitation. If further evidence of the

gravitating tendency of the Aether were required, I would refer the reader to Lord Kelvin's utterance on this subject.

Lord Kelvin, *Phil. Mag.*, November 1899, in relation to the Aether writes: "We are accustomed to call Aether imponderable. How do we know that it is imponderable? If we had never dealt with air except by our senses, air would be imponderable to us, but we know by experiment that a vacuum glass tube shows an increased weight when air is allowed to flow into it. We have not the slightest reason to believe that Aether is imponderable. It is just as likely to be attracted by the sun as air is. At all events the *onus of proof rests with those who assert it is imponderable*. I think we shall have to modify our ideas of what Gravitation is, if we have a mass spreading through space with mutual attraction between its parts, without being attracted by other bodies."

We have already seen in the previous article that Faraday was of opinion that the Law of Gravitation extended throughout the whole of the solar system, and as Aether fills the solar system, then obviously Aether must also be subject to the Law of Gravitation.

ART. 46. *Aether possesses Density*.—That matter possesses density has already been shown in Art. 38, and on the hypothesis that Aether is matter, Aether must possess density also. This property has already been postulated for the Aether, in order to account for certain phenomena in connection with the reflection and refraction of light. Young assumed different densities for the Aether near bodies owing to its being attracted by those bodies (Art. 45). Reflection and refraction of light are produced by a change of density of the Aether. It is now generally accepted that the optical difference of bodies depends mainly on the different densities of Aether in association with those bodies. Professor Tyndall, in his *Lectures on Light*, writes on the density of the Aether as follows: "The density of the Aether is greater in liquids and solids than in gases, and greater in gases than in vacuo. A compressing force seems to be exerted on the Aether by the molecules of these bodies."

Apart, however, from the atomicity and gravitative properties of the Aether, it is difficult to understand how there can be density of the medium, and still more difficult to give a satisfactory explanation of different degrees of density for the same medium, which some scientists assume it to have.

If, however, all that is logically included in the statement that Aether is matter, and therefore is atomic and gravitative, is conceded, then, from the analogy of our own atmosphere in relation to the earth, the density of the Aether, and different degrees of density also, is at once put upon a logical and philo-

sophical basis, as it is brought into harmony with all experience and observation, and is simple in its conception.

On the other hand, an Aether which is not atomic or gravitative cannot possess different degrees of density, except by assuming the existence of some unknown law of which we have no knowledge, which conception is altogether opposed to the fundamental principles of simplicity, observation, and experiment as laid down not only by Newton but by every true philosopher.

Therefore, that Aether can possess different degrees of density, is only the logical outcome of the statement that Aether is matter, seeing that such a statement without the shadow of a doubt must at least imply that it is gravitative.

I need hardly point out, that it is much more philosophical to be able to account for the density of the Aether in a reasonable and philosophical manner, than simply to postulate for the Aether certain properties and qualities, because certain phenomena demand the existence of such properties.

The Aether has been such a hypothetical medium, that it has been easy to postulate for it certain properties, if certain phenomena have demanded the existence of those properties.

Thus if the Aether were required to be elastic, then elasticity was postulated for it; if more elastic, then greater elasticity was added. If density were demanded, then density was postulated, and if less or more density, less or more density was given to it.

That method of speculation may be satisfactory up to a certain point, but no one will admit that such a method is wholly philosophical. It will be a far better method to adopt, if, in dealing with the universal Aether, we can make it conform to certain recognized laws and principles, and from the application of those well-known laws, be able to infer the exact constitution of this space-filling Aether medium.

Now the question arises, if Aether is gravitative, what effect has the Gravitation of any body, be it an atom, or a meteor or planet, sun or star, upon the Aether in which it moves, and which surrounds it?

That we may have some light thrown upon the matter, I would like now to take the reader to Newton's *Optics*, in order that he may give us his opinion as to this property of density of the Aether. In his nineteenth query Newton (*Optics*) asks this question—

“Is not this medium much rarer within the dense bodies of the sun, stars, planets and comets than in the empty spaces between them, and in passing from them to great distances, doth it not grow denser and denser perpetually, and thereby cause the gravity of those great bodies towards one another, and of their

part towards the bodies, every body endeavouring to go from the denser parts of the medium towards the rarer?"

Here then we have given to us an indication of what is the possible state of things in relation to the gravitation of the Aether, and all bodies in solar and stellar space. The only mistake that Newton made, was in inverting the right order of comparatively dense and rarer parts of the aetherial medium, by putting the rarer parts of the medium near to the bodies, and supposing the denser parts to be farther away in space.

As a matter of fact, the correct view is exactly the opposite, that is, if we are to form our conception by following out those philosophical rules that Newton laid down. For either the rules are right, or his supposition is right. They cannot both be right, as his supposition is contrary to the second Rule of Philosophy, as all experience and observation from the analogy of Nature teach us that a medium enveloping any body, as planet, star or sun, is densest nearest to the body, becoming rarer the further that medium gets away from the central body. Let us take for our illustration the best example, that experience and observation afford, that of the atmosphere surrounding the earth. The analogy is so perfect, that one is almost tempted to believe that the atmosphere and the Aether are in some way intimately associated with each other. Some years ago Lord Kelvin was of the opinion that the Aether was but an extension of the atmosphere, though I am not certain whether he holds that view at the present time. Clerk Maxwell, writing in the *Phil. Mag.* in May 1861, writes: "I have deduced from this result the relation between statical or dynamical electricity, and have shown that the elasticity of the magnetic medium in air is the same as that of the luminiferous medium, *if these two coexistent, coextensive, and equally elastic media are not rather one medium.*"

Now for the comparison. Both the atmosphere and Aether are matter. Both are atomic, both are gravitative, both possess elasticity, and both possess density. The atmosphere also possesses different degrees of density, so does the Aether. In the case of the atmosphere, however, experience and experiment teach us that the atmosphere is denser nearer the earth than farther away.

When we ascend mountains, it is a matter of common knowledge that the higher we ascend, that is the further we get from the earth, the rarer the atmosphere becomes. When we ascend in balloons, we find that the air becomes so rare and so light, that the blood will flow from the nose, on account of the reduced pressure exerted on it, the pressure inside the body being greater than that outside. Now in accordance with our second Rule of Philosophy, if experience is to be any guide at all, then it most

conclusively teaches us that the Aether being subject to the same laws as the atmosphere, the same results inevitably follow. Therefore the Aether nearest the earth is denser than any layer immediately above it, and that layer denser than the one above it, and so on for great distances, with the result that the only conclusion we can come to in regard to the density and rarity of Aether in relation to all gravitating bodies is, that the densest part of the Aether is nearest to them, and the rarest, the farthest away from them. So that while Newton's suggestion in his nineteenth query is correct in principle, it is incorrect in application to space.

I would like to point out here, that what is true of the earth in relation to the density of the surrounding Aether, must also be true, according to our second Rule of Philosophy, of every other planet, or sun, or star. So that every planet, satellite, every sun or star has its atmosphere, if I may so term it, of Aether, which obeys and follows the same laws as the earth's atmosphere does.

This is a most important fact, and has a most important bearing upon the physical cause of Gravitation as applied to each planet, and sun and star, as I shall afterwards show.

I wish now to bring the reader into contact with a Theory of Gravitation that was given to the world by Professor Challis of Cambridge, 1872. In the *Philosophical Magazine* of June of that year he writes: "I assume that all the active forces of Nature are different modes of pressure under different circumstances of a universal elastic Aether, which presses always proportionately to its density."

Now what I wish to point out is, that while Prof. Challis admits the density of the Aether, and also varying degrees of density, as he states that the Aether presses proportionately to the density, he does not show how that varying density is accounted for. If there is this varying density, then there must be some underlying principle which governs the variation in density, and I know of only one principle or law which can regulate that variation in density, and that is that Aether is gravitative, and being gravitative it not only possesses density, but also variations in density.

Thus by admitting that Aether is gravitative, because it is matter, we have at once a satisfactory explanation for the density of the Aether and also for different degrees of density both in the atomic world, and in the planetary and stellar world.

ART. 47. *Aether is Elastic*.—In Art. 39, matter was shown to be elastic, and on the assumption that Aether is matter, the elasticity of the Aether, which has been postulated for it by various scientists, can be logically and philosophically accounted for.

In view of the transmission of light through space with a definite and finite velocity, we are compelled to regard Aether as possessing elasticity, similar to that of an elastic solid body.

If we take the analogy of sound, we find that sound is transmitted and propagated through matter, by waves of alternate condensation and rarefaction, and that transmission is regulated by the relation of the density of the medium to its elasticity. Light has been proved to be due to the undulatory wave-motions of the Aether, and in order to account for the transmission of the wave-motion, it is essential that the Aether should possess the property of elasticity.

As Young points out in his First Hypothesis,¹ the Aether possesses this property of elasticity, but with the advance of scientific knowledge and research, the elasticity of the Aether may be said to have passed out of the hypothetical stage, into the state of actual fact and experiment. Both McCullagh and Fresnel have assumed this property of elasticity for the aetherial medium in order to account for certain phenomena of light.

Apart, however, from the atomicity of the Aether, it is exceedingly difficult to understand how such a property can belong to it. Atoms are exceedingly small particles, possessing the property of elasticity, or the power to recover their original shape after distortion or change of shape. If the Aether therefore be atomic, as is pointed out in Art. 44, it can at once be readily understood how the Aether as a whole can possess the property of elasticity. The atoms of the Aether must be inconceivably small, as the light-waves travel with the enormous velocity of 186,000 miles per second.

What must therefore be the atomic vibration which such a statement implies? If, on the other hand, the Aether is assumed to be continuous and non-atomic, it must be seen how exceedingly difficult it is to account for the elasticity of the Aether, as it seems absolutely impossible for a medium which is continuous, and non-atomic, to be able to transmit the waves of light with a finite velocity.

Apart, therefore, from atomicity of some kind or other, elasticity of the Aether is an assumption philosophically incorrect, as it is contrary to that simplicity of conception laid down by Newton, and is also contrary to all experience, and thus violates the second Rule of Philosophy.

Aether therefore must be said to be perfectly elastic; so perfectly elastic, that it is susceptible to the least touch of any natural thing, so that even an atom, so small that it cannot be seen with the most powerful microscope, yet so elastic is this Aether medium, that the least motion or vibration of one of

¹ *Phil. Trans.*, 1802.

these atoms, though the motion did not exceed the 20- or 40-millionth part of an inch, yet even this would create in the aetherial ocean, Aether-waves, just as a body moving in water creates water-waves, which, radiating from the place of their birth, beget and create others, the process continuing until they reach the margin of the water in which they were generated. It is precisely so with these Aether-waves, when once generated and set in motion. They create others, the process being continued and perpetuated; and, unless arrested in their course, may continue until they reach the very limits and confines of material immensity and space.

It is, perhaps, only necessary to say, regarding the perfection of the elasticity of the Aether medium, that though it takes from 40,000 to 69,000 waves to complete the space of one inch in extent, yet it is done with such miraculous rapidity, as to speed the distance of 186,000 miles in the short space of a second of time; or, taking the number of Aether-waves to complete an inch as 50,000, its elasticity is such that it makes $50,000 \times 186,000 \times 12 \times 5280$ vibrations in one second of time.

We have already seen in Art. 39, that according to Boyle and Marriotte's Law, the velocity of a wave-motion, as sound in the air, is determined by the relation of the elasticity of the medium to its density. If the temperature of the atmosphere remains the same, then the *elasticity* varies in the same proportion as its density.

According to Art. 45, Aether is gravitative, and that fact produces different degrees of density in the aetherial atmosphere of an atom or planet or meteor, sun or star; that part of the Aether being densest nearest the central body, and rarer the further we go away from that body.

Now the question at once arises, what is the effect of the increased density of the Aether near the body upon the elasticity of the Aether?

From the analogy of sound in air, we arrive at the conclusion that Boyle and Marriotte's Law equally applies to the Aether, as it does to the atmosphere of any planet. That is, if the temperature of any stratum or layer of the Aether remains the same, then the elasticity of the aetherial medium in that layer is proportionate to its density, so that while the gravitating property of the Aether makes it denser nearest the central body, the fact that the elasticity is proportionate to the density, does not affect the transmission of any wave-motion.

ART. 48. *Aether possesses Inertia.*—From Art. 40 we have seen that all matter possesses inertia, inertia being that property of matter by which it cannot of itself change its state of motion or of rest.

If Aether be matter, therefore, then it must also possess inertia. This property of inertia is already postulated for Aether by scientists, and to that extent is conformable to the Rules of Philosophy. Professor Tyndall, with reference to the inertia of the Aether, writes: "The motion of Aether communicated to material substances throws them into motion. It must be therefore itself a substance. Aether is a substance endowed with inertia, and capable, in accordance with the established laws of motion, of imparting its motion to other substances."¹

Again, Lord Kelvin in his Address to the British Association, 1901, on the "Clustering of Gravitational Matter in any part of the Universe," states: "Aether we relegate to a distinct species of matter which has inertia, etc." Aether, therefore, according to Tyndall, "is a substance or medium endowed with inertia, and capable, in accordance with Newton's Laws of Motion, of imparting its motion to other substances."

If, however, the Aether is frictionless, as has generally been supposed, then it cannot possess inertia, because to the extent that a body possesses inertia, to that extent it is opposed to being frictionless.

Inertia is really the equivalent of mass, or the amount of matter measured by gravity, and if Aether possesses mass in any sense at all, as it must do if it is matter, then, possessing mass or weight, it must offer resistance to any body moving through it, and to that extent cannot be frictionless. To suppose that the Aether is frictionless, and yet possesses inertia, is to suppose something altogether opposed to all the Rules of Philosophy and therefore of experience.

I have already shown that a frictionless medium is opposed to all philosophy and experience, and is an anomaly in the universe.

On the strictly philosophical assumption that Aether is matter, and therefore atomic and gravitative, the whole question of the inertia of the Aether is reduced to one of common experience. It is, at least to my mind, difficult to conceive of mass without weight or without atomicity, and yet that is the unphilosophical position of the present state of science in relation to the Aether. In other words, while the Aether is supposed to possess inertia, which is dependent upon mass, as measured by gravity, yet it is supposed not to be gravitative, that is, that the mass of the Aether has no weight at all, and therefore is not mass, which assumption contradicts itself. From Arts. 44 and 45, however, we have seen, to be strictly philosophical, that Aether must be atomic and also gravitative. It can now be easily understood how it can possess inertia like any other matter, and is therefore

¹ *Lectures on Light.*

capable of receiving motion from other matter, and also of imparting that motion to other matter.

So that, wherever there is motion of any kind in the Aether, either in the form of vibratory motion as heat, or undulatory motion as light, or rotatory motion as electricity, those motions will affect adjoining matter in the same way that the motion of any other moving matter affects any body with which it comes into contact.

From the fact that Aether possesses inertia, and is also gravitative, we have now to alter our conception of this universal space-filling medium, and in place of a frictionless medium, which is incapable of imparting motion to any body, we have now to remember henceforth that the Aether is matter, which possesses inertia, and therefore has the capacity not only of offering resistance to any body moving through it, as a comet or meteor, but also of imparting the motion which it may receive in any manner to any other matter, as a planet, satellite, or sun, that may be floating in it.

With this philosophical view of the Aether, which is entirely in harmony with our first and second Rules of Philosophy, we shall be able to give a physical explanation of the Law of Gravitation, as we have now a physical medium existing in all atomic, solar, and stellar space, which can both accept motion, and transmit that motion to other bodies. In other words, we have a medium which can both push and pull.

ART. 49. *Aether is Impressible.*—Another characteristic property of this Aether medium is, that it is as perfectly impressible as it is elastic. So perfectly impressible, that it receives, retains, and perpetuates for thousands of years, and for distances to human mind incalculable, every impression given to it of light, form, colour, tint, and shade; and that, too, with a perfect fidelity that nothing mars, even to the least and most infinitesimal detail.

Therefore, irrespective of distance, wherever there is matter to arrest and reflect the impressions received, there those impressions of light (and all that in the luminosity is involved and contained) become visible and revealed, and wherever there is power of vision to receive and concentrate these Aether- or light-waves, there, not only luminosity or light, but all that constitutes and is involved in that luminosity, becomes at once visible and seen.

It is by this means we see the colour, tints, shades, and forms of suns and planets; of stars, constellations, etc., with all the varied forms, configurations, and movements of the celestial phenomena. Each and every one, small or great, glittering or blazing, sun or planet, are ever creating or generating Aether-

waves, and impressing them with all the details and particulars of their nature and existence; and these Aether-waves ever bear upon their mystic wings the impressions received, carrying the information given with lightning speed to the very confines and limits of infinite space or the material universe; beyond which exists nothing but the ever-living and active energy of the Divine, the only unlimited, unbounded, and absolute infinitive.

It is by the interception and concentration of these waves by our perceptive powers, aided with the giant powers of the telescope, that we obtain the information given, or become cognizant of the nature and existence of the varied lights, colours, tints, and shades of the celestial bodies.

The vision, assisted by the giant power of the telescope, collects and concentrates these Aether-waves into a perfect image of those things that gave them birth, and by this means reveals to us the knowledge of things afar, their existence, nature, characteristics, properties, and powers.

Thus it is we see the solar orb, with its huge fires all aglow, obtain a knowledge of its character and powers, see its huge spots, its quivering fringe of flame, and high-leaping prominences, or watch its slowly revolving form.

Thus we see the planets that around it sweep and roll; swift-footed Mercury with his wondrous speed, and dazzling Venus with her silver sheen; Mars the god of war with his ruddy glow, and mighty Jupiter with his orange hue, and the yellow Saturn with her mysterious rings, the blue Uranus, and the more distant Neptune, with all the satellites that to it belong.

Then far far away the brilliant Sirius—the Dog Star, Cygnet, Centauri, the Great Bear, and a thousand others.

The Pleiades and the twenty millions of suns that form our own galaxy and the Milky Way, with all their varied colours, tints, and hues of white, golden, orange, ruby, red and blue, green and grey, silver, purple and yellow, buff and fawn, emerald and green, lilac and coppery. Thus we see the distant Orion, so far away that swift-footed Light, with its speed of more than eleven million miles per minute, has to travel for more than thirty thousand years before it spans the gulf that intervenes between it and us, and brings to us the news of its existence there.

Then the spectroscope with its revealing power literally tears asunder wave from wave, and reveals the mystic message which each doth bear, of the distant things from which they come, of each and every sort and kind.

Thus we know, that in the solar fires there ever burn such things as hydrogen, oxygen and nitrogen, and also, in a vaporous state, aluminium, sodium, iron, magnesium, cobalt, calcium, chromium, copper, manganese, zinc, and others.

Thus light-waves are speeding everywhere, and from all material things. They come from our own sun, and rush in, and flood the earth's aerial veil, the atmosphere; and "Each little atom of matter, like a mirror, reflects and re-reflects them as if in sport, buffeting each luminous ray from one to another, increasing and amplifying it by an infinity of repercussions" (Herschel), and then in their entirety and whole, like a huge multi-mirror, so blend and mingle them that they come to earth's surface in that soft radiance we call Light, and bathe it as in a sea of mellowed glory.

ART. 50. *Aether: its Motions.*—The question of the exact motions of the Aether is a question which has involved the attention of scientific men for many years, and which is at the present time receiving the attention of some of our most advanced scientists, not only in this country but in other countries also.

Whether the Aether in space is at rest, or is moving along with all the bodies that float in it, so to speak, is a question of the greatest importance to scientists and philosophers generally, as the particular character of the motions of the Aether, which are either suggested or ascribed to it from the analogies of Nature, are sure to have a most important bearing not only on the motions of all the planets and satellites, but also upon such questions as the aberration of light, and such difficulties as presented by Lord Kelvin in his paper on "Clouds on the Undulatory Theory of Light" (*Phil. Mag.*, July 1902).

I need hardly point out that the hypothesis that Aether is gravitative, is bound to play a most important part in the consideration and development of this phase of the study of the universal aetherial medium. It is not my intention, however, at this stage of the work to go fully into the development of this aspect of the subject.

The application of this principle will be considered at the right time, and in the right place. It is, however, generally assumed, that the Aether is at rest in space, and that the earth, the planets, and the sun and all stars, move through it with varying velocity, although, as Lord Kelvin points out, such an assumption is covered with a cloud which up to the present is "as dense as ever." Of course, if the Aether be at rest, and the planets and other heavenly bodies move through it with varying velocity, then the only assumption regarding the Aether is, that it is frictionless, but, as I have shown in Art. 45, this is opposed to all philosophical reasoning, and therefore to experience and observation.

We have, therefore, to postulate for the Aether such motions as shall fulfil all the Rules of Philosophy, that is, shall be simple in conception, shall be in harmony with our experience

and observation, and which shall satisfactorily account for the phenomena sought to be explained, that is, the universal Law of Gravitation ; for it is by the properties, combined with the motions of the Aether, that the physical cause of Gravitation is alone to be explained.

Let us revert to the question of a stationary Aether for a moment or two, and let us ask ourselves, where is the evidence for such an assumption ? Has the sun ever ceased to shine, or to send its light-waves with their enormous velocity speeding through the solar system ? So far as experience and observation go, I have never read of any record of such a fact, or that light-waves have ceased to proceed from the sun and fill the solar system with Aether-waves.

Not only is this true of the sun, but it is equally true of every planet and satellite, every meteor or comet, every star and sun that exist or dwell in this aetherial medium ; for, as has already been shown (Art. 49), every body emits Aether-waves, and these waves spread out in all directions in a spherical form.

The truth is, that the universal Aether is in eternal motion, and that motion forms the physical life of the universe. If it were possible to destroy the motion, then the whole fabric of the universe would fall to pieces, and the beauty, order, and harmony of the celestial mechanism would be replaced by disorder, confusion, and ultimate ruin. Take any analogy of Nature, and see what such an analogy teaches us. Look at any planet, sun, or star. Do we find any one of these stationary or at rest ? Why from the smallest meteorite or satellite, to the largest star that shines in the firmament of heaven, there is nothing but motion ; each satellite, planet, sun, and star moving on and on, ever and ever through the countless ages of time until its course is run and its existence ended. But rest, never ! Such a thing as rest is unknown in the entire universe, whether it be in the atomic systems of matter, or the systems of stars and suns that form the universe of worlds.

Take another illustration—that of the ocean ! Is that ever at rest, with its unceasing wave and tidal motion ? Has the reader ever stood on the shore and seen the ocean when it has been absolutely still, or when the tide has ceased to flow ? Such a possibility is almost absurd to contemplate. The same argument applies to the air with its regular flow of winds. Now in regard to the aetherial and universal medium, there are just as regular motions as the flowing of the tide round the earth, or the revolving of a satellite round a planet, or a planet round the sun.

And what is as important, all the motions can be as satisfactorily explained and accounted for from the physical standpoint, as the flow of the tide, or the revolution of a planet.

Year in and year out, the motions of the Aether remain the same, governed by the same laws and producing the same effects. Age after age, the Aether has been moving, producing by its various motions the continuity of that beauty, order, and harmony that govern the universe as a whole.

I have already indicated in Art. 45 the effect of Gravitation on the Aether surrounding each satellite, or planet, or star, or sun. As each satellite, or planet, or star moves through the universal Aether, it takes with it its surrounding Aether as indicated in Art. 45, in the same way that each planet or sun takes with it its own associated atmosphere, which is held in contact with it by the self-same force of Gravitation.

In addition to this motion of the aetherial atmosphere through space, there are other motions of this same gravitating Aether that have to be taken into consideration, before a complete and adequate conception of all the motions of the Aether can be arrived at.

I do not intend, however, at this stage to go fully into such motions, but rather wish to lead up to them from a consideration of hypotheses put forward by such men as Rankine, Challis, Maxwell, Lord Kelvin, McCullagh, and Helmholtz, and from a consideration of such hypotheses in the realm of heat, light, and electricity to be able to form a scientific conception of the proper motions of the Aether, as well as a philosophical one.

CHAPTER V

ENERGY

ART. 51. *Energy*.—In the days of Newton, and for a long time afterwards, all energy went by the name of "Force." Thus Newton in his *Laws of Motion* refers to the action of forces on stationary or moving bodies, and shows how the motion of any body is effected by the impressed force. (Art 13.)

As science advanced, and scientific research was carried into the fields of heat, light, and electricity, we find that the various forces began to be particularized, with the result that such terms as electrical force, magnetic force, chemical force, etc., became common and familiar terms. As gradually it became known that one particular kind of force was the outcome of another kind, there was given to the world such terms as the *Correlation of Forces* (Grove), in which he proved that whenever one kind of force appeared as heat or light, it was at the expense of another kind of force, as electricity.

Of later years, however, another term has crept into Philosophy, and instead of the term Force, which is very indistinct and indefinite in character, there appeared the term Energy, although Force and Energy are not exactly synonymous terms. Thus electricity, heat, and light are forms of energy, and are convertible into one another, in the same way that the forces were convertible. Thus we get transformations of energy in the same way that we had transformations of force, and conservation of energy in the same way that we had conservation of force.

Even the term Energy, however, is being replaced in the present times by something more definite and simple, and instead of the term Energy, we shall find, in the development of this phase of natural phenomena, that that term is being replaced by the simple idea of motion, or modes of motion, and that all forms of energy, as light, heat, magnetism, and electricity, and even Gravitation itself, are due to motion of some kind or other. We will, however, lead up to this truth by looking briefly at the term Energy, and see what it implies and embodies.

Energy, therefore, is that property which a body possesses, by which it is capable of doing work. Thus our ideas of work give

us our conception of energy. For example, when a weight is lifted, work is done, and a certain amount of energy is expended in the process. Further, the amount of work done is proportionate to the weight lifted, and the height to which the body is raised. Work is done against resistance, so that whenever resistance is overcome, then work is the result. For example, suppose one pound is lifted one foot high, in opposition to the force of gravity, then work is done, and this amount of work is known as a foot-pound.

If a body weighs ten pounds, and is lifted ten feet, the work done is equal to ten pounds multiplied by ten feet (10×10 equals 100), so that one hundred times the amount of work has been done in comparison with the lifting of the one pound one foot high.

As all weight is essentially a gravitational measure, depending upon the intensity of gravity at the place, then, whenever a body is raised or lifted, the work so done is done against the gravity of the earth.

Work is also done, as Newton points out in the first and second laws, whenever we apply force to any body, either stationary or already in motion. The results of all observation and experiments prove, that whenever we have two bodies upon which work is being done, the amount of work is determined by the amount of energy transferred from one body to the other, and that the actual amount of energy gained by one is equal to the amount of energy lost by the other.

Energy is always found in association with matter, so that matter has sometimes been termed the Vehicle of Energy. Wherever, therefore, we find energy of any kind or sort, there we find matter also, as the two are inseparably connected together. Thus, wherever we have heat, we have matter in a particular state of motion, generally understood as vibratory motion. Wherever we have light, which is also a form of energy, we also have matter in motion, that is the Aether, in a state of periodic wave-motion; and wherever we have electricity, we have again matter possibly in a state of rotatory motion, as we shall see later on. Energy, therefore, is the power which a body possesses to do work.

ART. 52. Conservation of Energy.—The principle of the Conservation of Energy was first enunciated by Mayer in 1842. The principle may be defined as follows: The total amount of all the energy, as light, heat, electricity and magnetism, Gravitation, etc., in Nature is unchangeable; so that, according to this law, the universe possesses a store of energy which is unchangeable in quantity throughout all time. The energy may pass from one form to another, yet the total amount ever remains the same. It is almost unnecessary to say, that this is a principle which, like

the conservation of matter, is incapable of absolute proof, but its assumption has greatly helped scientific thought and speculation from time to time. Clerk Maxwell says (*Theory of Heat*) on this point: "The total energy of any body is a quantity which can neither be increased nor decreased by any mutual action of the bodies, though it may be transformed into those forms of which energy is susceptible."

The conservation of energy is inseparably connected with the conservation of matter (Art. 30). They cannot be divided, because, if energy is only to be found in association with matter, then if the law of the conservation of matter falls to the ground, the principle of the conservation of energy falls with it. Energy, therefore, like matter, cannot be destroyed or created by any process known to man. As there is no process known, either in the chemical or in the physical world, by which new matter may be created by man, so, in relation to energy of any kind or sort, there is no process known by which man can create or even destroy the smallest form of energy that exists. If energy appears in any body or in any particular form, it is solely because of the loss of energy in some other body, or in some other form.

All changes of energy, therefore, are simply changes due to the difference in form in which the energy is manifested. At one time it will be manifested in the form of light, then of heat, then in mechanical motion, and so on. Joule gave us some good illustrations of this principle of the conservation of energy. He showed us how electricity could be changed into heat, and the heat into work. When light, which is a form of energy, is absorbed by any opaque body, it is found that the body which has absorbed it has become hotter. The energy of light has not been destroyed, but as its energy cannot pass through the opaque body, it has been employed in agitating the particles and atoms of that body, which becomes hotter in consequence.

Thus from the principle of the conservation of energy, which is in operation not only in our planetary world, but throughout the whole of the solar and stellar space, and indeed throughout the whole universe, we arrive at the conclusion that the total quantity of energy throughout the universe is unchangeable. In the evolution and development of worlds, and in the destruction of those worlds after long periods of time, throughout all the varied manifestations of heat, light, electricity, and magnetism, associated with the development and destruction of each globe, the sum-total of the energy of the universe remains the same. Meteors may rush into the atmosphere of planets, and be dissolved into Aether through the friction, comets may be dissolved into their component gases as they near the sun, water may be changed

into vapour by the heat of the summer sun, vegetation may be produced from apparently dead matter, and then that vegetation may itself decay and return to the dust by which it had been built up, but throughout all these processes of birth and death, of evolution and devolution, the sum-total of active living energy which is associated with all the phenomena, remains unalterable and unchangeable. Such is the teaching of the great principle of the Conservation of Energy as enunciated by Mayer and Helmholtz.

ART. 53. *Transformation of Energy.*—One of the chief characteristics of energy is, that we can transform it, and it is chiefly of use to us because of its capability to be transformed, but in all its transformations, the total quantity of energy remains the same. The transformation of energy renders it necessary to the existence of all life, and to all physical change in the universe. Mayer showed us that all energy in the solar system primarily derives its existence from the sun, and that all plant life and physical life owe their continued existence to the energy which is poured out from the sun upon the planetary worlds. So that energy is always flowing from the sun into the surrounding space in the form of light, heat, and electricity, the medium of its passage being the universal Aether.

This principle of transformation teaches us, that heat may be converted into electricity; that light may be converted into heat, or electricity may be converted into either heat or light or both. This principle of transformation naturally follows from the principle of the conservation of energy; because, if energy cannot be destroyed in any way, but is made to disappear by any process, it must reappear in some other form, and therefore has been transformed from its original state. So that, whenever one kind of energy disappears, then it is absolutely necessary, according to the principle of conservation of energy, that some other kind shall be produced. There cannot be any real loss or destruction.

That leads us to the next point regarding this principle of transformation, which is that all transformations of energy take place in fixed proportions. When a certain quantity of coal is burned, a certain quantity of heat, or thermal energy as it is sometimes called, is produced, and the quantity of heat so produced is definitely proportionate to the quantity of coal consumed.

If a certain quantity of coal were burned in a perfect steam-engine, that is one in which there would be no loss of heat, then also a definite amount of mechanical work would be done, which would be strictly proportionate to the heat generated by the consumption of the coal. So that when coal is put into an engine, the potential energy of the coal is transformed into

kinetic energy of the steam, and that is again transformed into actual mechanical energy of the engine itself, by which work is done in driving or pushing or pulling the train along, and the amount of work done is proportionate to the coal consumed. Illustrations of transformation are common, and may be seen by any person living in a large town. Thus at any electrical station or electric tram terminus, these transformations of various forms of energy are very familiar sights. We have first the transformation of the coal in the furnace into heat. This heat converts water into steam, whose motion is communicated by proper machinery into a dynamo, the product of which is electricity. That electricity is then conveyed along wires, and work is done by it, by moving trams along the connected tram system, or it may be converted into heat in the carbon filament in the car itself, which, if heated enough, will then produce the electric light. So that starting from the coal, we have several transformations therefrom into the forms of heat, light, motion, and finally mechanical energy, which results in Work. The question arises as to what is the law of equivalence in regard to the transformation of energy. That is, if we have a certain amount of energy of a given sort, how much of any other sort can be produced by it? The answer is partly to be found in a statement made by Joule in 1843, which practically embodies what is known as the first law of Thermo-dynamics, and is as follows: "When equal quantities of mechanical effects are produced by any means whatever, from purely thermal sources, or lost in purely thermal effects, then equal quantities of heat are put out of existence or are generated, and for every unit of heat measured by raising a pound of water one degree F. in temperature, you have to expend 772 foot-pounds of work." From this law we learn that heat may be used to do work, but that a certain amount of heat is always used up in the process. It can also be demonstrated that electric currents can do work, but to generate the currents a certain amount of work must be done.

This equivalence and transformation prevail in all forms of energy, whether it be mechanical energy, thermal or heat energy, or electrical energy.

ART. 54. *Potential Energy*.—Energy has been divided into two classes, which are termed respectively Potential Energy and Kinetic Energy. We will look at the former first.

Potential Energy may be briefly defined as energy of position.

Thus if we lift a body from the ground, the energy which has been imparted to it is energy of position, or potential energy. A glacier high up the mountain possesses potential energy, because of its position. By the mere fact that it is situated high

up the mountain, it has a capacity for doing work by its descent, and if that descent be very sudden, the work done will be destructive work, as it may sweep away all houses and villages in its sudden descent. Thus, by the mere fact of its elevation, it possesses a power of doing work, which it has lost when it has descended. Again, work done in winding up the spring of a clock is stored up in the form of potential energy, and gradually runs out in the form of motion or kinetic energy.

Potential energy is really the complementary principle of kinetic energy. That is to say, the amount of potential energy lost by any body, is equal to the amount of kinetic energy gained by the other body, to which the energy has been transferred. In the case of a body falling, as the potential energy diminishes, the kinetic energy increases, but the total amount of the two combined always remains the same. This is well illustrated in the case of a swinging pendulum. When a pendulum is at the highest point of its swing, its velocity or kinetic energy is zero, but at that point its potential energy is greatest. As it descends, the potential energy decreases, but the kinetic energy increases. When the pendulum is at the lowest point its energy is wholly kinetic, the potential energy being zero at that point, while it has sufficient kinetic energy to raise it to the highest level again. Throughout the cycle of these operations, the sum-total of the two energies always remains the same.

Professor Tait points out, in his *Recent Advances in Physical Science*, that the available sources of all potential energy may be divided into four classes—

- 1st. Fuel.
- 2nd. Food of Animals.
- 3rd. Water-power.
- 4th. Tidal Water-power.

All these are different forms of potential energy. Under the head of fuel he includes not only wood, coal, but also all forms of matter that may be used or burnt up by heat, or dissolved by chemical agencies. Thus zinc and lead, which are used in batteries, are merely forms of fuel. That potential energy resides in such things as wood and coal is a matter of common experience. All our coal-fields are stores of energy, which received their energy when in plant form, ages ago, from the sun, and this energy is now being used to drive our machinery, to warm our houses, and to give light to our homes and our cities. It has been calculated that a pound of coal would give out 14,000 heat units, which is equal to 11,000,000 foot-pounds of work, which is also equal to the amount of work a horse can do in five hours. Again, all food, whether it be the

food of animals, as vegetables and plants, or of man, as bread, meat, etc., are all forms of potential energy, or energy which is stored up in matter. All forms of food have a certain amount of energy in them, which is used up in the body in building up waste tissue and imparting energy to the physical frame.

Again, all forms of water-power, whether it be in the form of the flowing river or the tidal motion of the sea, possess a large amount of potential energy which may be used up to do mechanical work. They also possess kinetic energy, or energy of motion. We find illustrations of the possession of potential energy by rivers and tides, in the fact that by their fall from a higher to a lower level they may be made to do mechanical work, as in the case of the turning of the water-wheel by the fall of the water, which motion is communicated to machinery, and various forms of work are the result. In Switzerland and America advantage is being taken of the energy of falling water to generate electricity, by means of which villages and towns are being supplied with electric light at a very small cost.

ART. 55. *Kinetic Energy*.—Kinetic energy may be defined as energy of motion, and is the energy which a body possesses in consequence of its motion. A body in motion thus possesses kinetic energy, which it must impart to some other body before it can be brought to a state of rest. The body may be simply an atom, as a vortex atom, but if it be in motion, as all atoms are, then it must possess kinetic energy, which may be transferred to another atom by collision, or by some other method. As has already been pointed out in previous articles, kinetic and potential energy are complementary to one another, the sum-total of the two combined always remaining the same in any cycle of work, according to the principle of the conservation of energy. We get a good example of this oscillation from kinetic to potential, and *vice versa*, in the planetary system. When the earth is farthest from the sun, its velocity, and consequently its kinetic energy, is at its lowest point; but there the potential energy is at its greatest. As the earth turns round in its orbit, however, and begins to approach the sun again, its potential energy decreases, while its kinetic energy increases with its increased velocity. So that by the time it has reached the nearest part of its orbit to the sun, its velocity, and consequently its kinetic energy, is at a maximum, while the potential energy is at a minimum. Then as the earth passes round its perihelion, the kinetic energy is used up in assisting the earth to overcome the attraction of the sun. Thus there is this oscillation from kinetic to potential, and from potential to kinetic, year in and year out, as the earth performs its cycle round its central body the sun.

Professor Tait, in the work referred to in the previous Article, gives examples of kinetic forms of energy under the following heads—

- 1st. Winds.
- 2nd. Currents of Water.
- 3rd. Hot Springs and Volcanoes.

It can be readily seen that winds are a form of energy, as we have innumerable instances of the power and energy which they exert. Advantage is taken of that kinetic energy by means of windmills, in which the energy of the wind is imparted to the revolving sails, and thence to the machinery, various forms of mechanical work being the result, as, for example, the grinding of corn, or the pumping of water. The pressure or energy of winds has even been calculated, the following figures being examples—

VELOCITY IN MILES PER HOUR.	FORCE IN LBS. PER SQ. FOOT.
1 mile.	'005 lb. per sq. foot.
5 "	'123 " " "
10 "	'496 " " "
15 "	1'11 " " "
20 "	1'98 " " "
30 "	4'5 " " "
40 "	7'9 " " "
50 "	12'5 " " "

In the case of currents of water, whether they are in the form of river currents or ocean currents, as has already been pointed out in the previous article, the question of potential energy, or energy of position, is associated with their kinetic energy. Water is taken at a certain elevation, and then allowed to fall to a lower level, and in its fall from the high level to the lower level, its kinetic energy is used to drive mill-wheels, and thus work is done, the kinetic energy of the water being transformed into the motion of the machinery. This machinery may be used to work a dynamo, and thus electric light may be generated, or it may drive an electric motor which may perform all sorts of mechanical work. The great underlying principle of either kinetic or potential energy rests in the fact, that wherever we have energy of any kind or sort, whether it be associated with water, wind, or Aether, there we have the capacity to do work, the amount of work depending upon the amount of energy that exists in the matter which is the vehicle of energy.

In Art. 50 it has been indicated that the Aether possesses several kinds of motions. From the sphere of light and heat, we learn that the Aether possesses certain motions which are always exerted in a direction from the central body, which gives

rise to the light- and heat-waves. That being so, it conclusively follows that the Aether possesses kinetic energy, and therefore, possessing this energy, it also possesses the power to do work. It must be remembered we are no longer dealing with a frictionless medium, but with a gravitating medium, possessing mass and inertia, and, that being so, wherever we have the Aether in motion, there we have kinetic energy or the power to do work ; and that work will correspond to the particular kind of motion which is exerted on any body by the aetherial motions, and will be equally subject to Newton's Laws of Motion.

ART. 56. *Energy and Motion*.—An advance, however, as to the meaning of the term Energy has been made within recent years, which brings it more into harmony with that simplicity of conception, and accordance with experience which are the very foundation of all philosophy. Instead of the term Energy, there is now being used another term to denote the forces which form the life of the universe, and that term is the word "Motion."

Professor Poynting says : "All energy is energy of motion" (*British Association Report, 1899*).

Thus motion is the fundamental principle of all phenomena. If we analyze all forms of energy with which we are familiar, we shall soon find that they are only changes of one form of motion into another. Thus we shall see that heat is a mode of motion, as has been proved by Tyndall, that light is another mode of motion, and that electricity is also a mode of motion. I need hardly point out that this advance in our conception of energy is strictly in accord with the Rules of Philosophy. First, it is simple in conception. When we say that a body possesses energy, whether that energy be potential energy or kinetic energy, it does not convey to the mind some definite concrete fact, as does the statement that a body possesses motion. Every one, whether familiar with scientific teaching or not, understands and is familiar with the word Motion, as it is a common phenomenon of everyday life and experience. As Energy was simpler in conception than Newton's term Force, so Motion is simpler in conception than the rather vague and indefinite term Energy ; therefore when we say that all energy is energy of motion of some kind or sort, we state that which is philosophically correct.

It is also in accord with the second Rule of Philosophy, in that it is strictly in harmony with experience and observation. Look where we will, or at what we will, there we find motion of some kind or other, whether it be among the innumerable stars, or in our own solar system, or any phenomena on the earth, or even among the world of atoms in their minute and atomic systems.

Such a thing as absolute rest, or stagnation, is unknown in the universe. Wherever there is matter, there we find motion of some kind or other. It may be vibratory motion as heat, or wave motion as light, or rotatory motion as electricity, but motion of some sort is inseparably connected with all matter. So that when we say that all energy of the universe is the energy of motion, and motion only, we state that which according to the second Rule of Philosophy is absolutely correct.

Further, I wish to premise that by the use of the term modes of motion, in lieu of energy, the third Rule of Philosophy will be fulfilled. For if all phenomena of the universe, whether it be heat, light, electricity, be due to different modes of motion, then Gravitation should be explained from the physical standpoint by some kind of aetherial motion also. This I can safely premise will be done, and in the later chapters of this work, Gravitation will be shown to be due to the motions of the aetherial medium which floods all space. By so doing, all the Rules of Philosophy will be fully satisfied, and Gravitation will then be brought into line with all the other forms of motion, as heat, light, electricity, and magnetism, which are in themselves modes of motion, as will be shown in subsequent articles.

ART. 57. *Conservation of Motion.*—If it be true that all energy is the energy of motion, then the principle of the conservation of energy ought also to apply to all the modes of motion, and in its place we should then have the principle of the conservation of the various forms of motion. This defined would be, that the total amount of all motion in the universe, as heat and light, electricity, magnetism, and Gravitation also, if that be due to the motion of the Aether, is unalterable and unchangeable.

There may be changes from one form of motion to another, from heat to light, and light back to heat; heat into electricity, and electricity into light or heat; from Gravitation into heat or into light, or even into electricity; but the sum-total of the whole remains the same.

Again, as the principle of the conservation of energy is inseparably connected with the conservation of matter, so the principle of the conservation of all the modes of motion is also inseparably connected with the conservation of matter. They cannot be divided, so that wherever we get matter of any kind or sort, there we get motion of some kind, either in the form of heat, light, or electricity, or those aetherial motions which produce those phenomena associated with Gravitation.

As matter cannot be destroyed by any known process to man, so motion cannot be destroyed either. On the vortex atom theory of matter, this principle of the conservation of any mode of motion is perfectly intelligible, especially if added to that

theory we have Dr. Larmor's electron theory as the basis of the vortex atom. An atom in its ultimate state is nothing more or less than Aether in rotation, and as Aether is matter, we see that on the assumption of this atomic basis, we have even in the atomic world an illustration of this conservation of matter and motion, as in such an atom we have nothing but matter (*i. e.* Aether) and motion. Carrying the idea upwards in the atomic scale, if atoms of hydrogen or oxygen are multiples of these vortex atoms, then again we have nothing in all the elements, or combination of the elements, but matter and motion. Again, as all planets and satellites, suns and stars, are but agglomerations of elements, we have still the same two classes of things, matter and motion, and so from the most infinitesimal atom in existence, up to the most ponderous star that exists in the universe, we have running through them all the principle of the conservation of motion, which is to matter the source of all its activities, energies, and powers. Motion, therefore, might almost be said to be eternal. We have heard from time to time of the term perpetual motion. Philosophers have from time to time endeavoured to discover some application of this perpetual motion, but all efforts in this direction up to the present have proved futile. In one sense there is no such thing as perpetual motion. In another sense, that is from the standpoint of the conservation of all modes of motion, as motion cannot be destroyed, it must therefore be perpetual.

It is an absolute impossibility to obtain motion except from some antecedent energy, which is itself a form of motion. It would require the distinctive fiat of an Almighty Creator to produce motion from nothing, and I question whether such a result is obtainable, as I hold that if the Creator, at any time in the history of the universe, set any substance in motion, the source from which that motion was derived, was His own Divine Energy, and in that sense the physical motion was not produced from nothing. Such an assumption is altogether opposed to all philosophical reasoning and experience. I hope to deal with the question either in the last chapter of this book, or in another work.

ART. 58. *Transformation of Motion.*—Again, if energy be the energy of motion, and the principle of the transformations of energy holds good, then it is equally true that all modes of motion are also transformable. Thus heat is a mode of motion, being due to the vibration of the atoms which go to make up any body. Light is also a mode of motion, being due, as far as solar light is concerned, to the periodic wave motion of the Aether. While electricity, as we shall see later on, is also due to some form of rotatory motion. It has already been shown

(Art. 54) that light can be converted into heat, so that the periodic wave motion of light can be transformed into the vibratory motion of heat.

Heat can also be converted into electricity, and if electricity be rotatory motion, then the vibratory motion of heat can be transformed into the rotatory motion of electricity. Again, as electricity can be converted into light, the rotatory motion of electricity can thus be transformed into the periodic wave motion of light. Thus through all the forms of motion with which we are familiar, we find this principle of transformation holds good, so that each form of motion may be directly or indirectly transformed into any one of the other kinds. Whenever, therefore, one kind of motion disappears, it is absolutely necessary, according to the principle of the conservation of motion, that some other kind shall be produced. There cannot be any real loss or destruction of the motion. It may be transformed, but not lost. By the use of proper apparatus, therefore, any form of motion with which we are familiar may be converted into another form, and in the process not the least quantity of any form of motion is lost. Heat may be changed into light, and light into heat; electricity into light, and light into electricity; heat into electricity, and electricity into heat. Indeed, starting from any one form, any of the other modes of motion may be produced, either directly or indirectly, and mechanical effects or work may be produced by each and all. Then, again, the order can be reversed, as by doing work which is simply applied motion, any of the other modes of motion can be produced. Thus heat can be produced by friction, and if the friction which is the outcome of muscular energy be continued long enough, a light will be the result, in the form of fire. When certain forms of work are done, as the turning of the handle of an electrical machine, frictional electricity will be produced. So that not only are all the modes of motion convertible into work, but work itself can be transformed into the modes of motion known as heat, light, electricity, and magnetism.

Now, if Gravitation be due to motion of the Aether, and if it is true that all modes of motion are convertible, then the application of this principle should also hold good in relation to Gravitation. It has been demonstrated by Joule and others that Gravitation can be converted into heat, light, and electricity. It can be converted first into heat. Joule made a number of experiments to ascertain what quantity of heat is produced by falling bodies, that is bodies under the influence of Gravitation. From experiments he has calculated that if one lb. of water falls through a space of 772 feet, it would raise the temperature of

the water one degree Fahrenheit—that is, the water after its fall will be one degree hotter than when it started to fall. Here, then, we have the exact equivalence of a certain amount of gravitational motion expressed in terms of heat. So that, whenever motion of a falling body produced by gravity is arrested, heat is generated, and as heat is a mode of motion, it follows that the motion of Gravitation has been converted into the motion of heat. Again, the motion of gravity may be converted into that of light. This may be demonstrated as follows: Lord Kelvin has suggested that the light and heat of the sun are maintained by the falling into the sun of meteorites. Now the cause of the falling of these meteorites into the sun is the Attraction of Gravitation, and therefore if the falling of these meteorites produces light and heat, it necessarily follows that the motion of Gravitation, whatever that may be due to, is converted into the motion known as light and heat. Thus it can be seen that Gravitation, looked at from the standpoint of a mode of motion, is itself conformable to the principle of the transformation of motion, and this is an indirect argument in favour of the fact that Gravitation is itself due to certain motions of the universal Aether.

ART. 59. *Motion and Work*.—In Art. 52 we have seen that energy is the power which a body possesses to do work, the amount of work which a body can perform being regulated by the amount of energy which such a body possesses. In Art. 57 we have further seen that all energy is the energy of motion, and that wherever we have energy of any kind or sort, whether it be in the form of light, heat, or electricity, there we have motion of some kind or other. That being so, we arrive at the conclusion, that wherever in the universe we have motion of any kind or sort, whether it be the motion of Aether, or wind, or water, there we have the power of doing work, and the work so done will be proportionate to the motion which the medium possesses. The amount of work that air in motion can do has been measured, as we have already seen (Art. 55) that air which moves at the rate of 30 miles per hour exerts a force of $4\frac{1}{2}$ lb. per square foot.

The amount of work that water in motion can do has also been measured. The carrying and erosive powers of a river depend on the rapidity of its currents. It has been calculated that a velocity of three inches per second will transport fine clay; eight inches per second coarse sand; while three feet per second will transport stones as large as eggs.

If, therefore, air moving at the rate of 30 miles an hour can exert a force of $4\frac{1}{2}$ lb. per square foot, what must be the force or pressure of aetherial motion, as light-waves for example,

which move with a velocity of 186,000 miles per second? The amount of work which such an aetherial motion can perform has actually been measured by Professor Lebedew of Moscow, and will be dealt with in the chapter on "Light, a Mode of Motion," when the application of the work done on a body, as a planet for example, will also be considered. Work, therefore, can always be done by motion against resistance. This is a fundamental principle in the sphere of dynamics, which is incontrovertible, as all experience, observation, and experiment teach us, that wherever we get motion of any kind or sort, there we have the capacity or power to do work. The work done may be either in the form of pushing a body along, or pulling a body towards a centre. All experience and observation teach us that no body moves (whether it be an atom, or moon, or planet, or sun, or star), unless some other body or medium, which is in direct contact with the moving body, exercises some pressure or pull upon the moving body. The action is purely and simply a mechanical one. So that if this be true, then the earth and the planets, the sun and stars, comets and meteors, are moved through space solely because they are being pushed by some medium, or pulled to the centre by the motions of the same medium. If this can be proved to be true, then, as can be readily seen, our philosophy will then be made to agree with our experience, and the second Rule of Philosophy fully satisfied. As has already been pointed out, there is no such thing as action at a distance, therefore the Law of Gravitation demands a medium for its operation, production, and continuity. Newton distinctly points this out in his Letters to Bentley, where he says: "That one body should act upon another through empty space without the mediation of anything else, by and through which their action and pressure may be conveyed from one to another, is to me so great an absurdity that I believe no man who has in philosophical matters a faculty for thinking can ever fall into it." It has already been pointed out (Art. 42), that the only medium which is universal is the Aether medium, and we have therefore to look to the motions and properties of that medium for the solution of the problem as to the physical cause of Gravitation. That such a medium has motions which are as regular as the tides of the sea, or the trade winds of the atmosphere, will be proved later on, when it will be found that Gravitation, with all that that law implies, is due, as Newton and Challis suggested, to the pressure, properties, and motions of the aetherial medium, which is as universal as Gravitation itself. This being so, it is essential that we should set ourselves to find out from the analogies of Nature, what are those properties and motions of the Aether which give rise to the universal Law of

Gravitation. This I propose doing by a consideration of three different modes of motion—viz. Heat, a mode of motion ; Light, a mode of motion ; and Electricity, a mode of motion. I venture to premise, from a careful consideration of these three truths, that we shall be able logically and philosophically to arrive at the simple, yet grand truth which reveals the physical source of all motion of the universe.

CHAPTER VI

HEAT IS MOTION

ART. 60. *Heat is Motion.*—On the phenomena of Heat, Newton in his eighteenth query in *Optics* asks the questions: "Is not the heat of a warm room conveyed through the vacuum by the vibrations of a much subtler medium than air, and is not the medium the same as that medium by which light is reflected and refracted, or by whose vibrations light communicates heat to bodies? And do not the vibrations of this medium in hot bodies, contribute to the intenseness and duration of their heat? And do not hot bodies communicate their heat to contiguous cold ones by the vibrations of this medium propagated from them into the cold ones? And is not this medium exceedingly more rare and subtle than air, and exceedingly more elastic and active?" Thus it can be seen that Newton was of the opinion that heat consists in a minute vibratory motion of the particles of bodies, and that such motion was communicated through what he calls a vacuum by the vibrations of an elastic medium, the Aether, which was also concerned in the phenomena of light.

One of the first experimental investigations into the real nature of Heat was made in 1798 by Count Rumford.

While he was engaged in boring brass cannon in the arsenal at Munich, he was struck with the degree of heat which the brass gun acquired, and with the still more intense heat which the metallic chips, which were thrown off, possessed. Of the phenomena he says: "The more I meditated on these phenomena, the more they appeared to me to be curious and interesting. A thorough investigation seemed even to bid fair to give us a farther insight into the hidden nature of Heat." Rumford therefore set himself to find out by actual experiments what the nature of Heat was. For this purpose he constructed a cylinder, and mounted it so that it could be made to rotate by horse-power. At the beginning of the experiment the thermometer stood at 60° Fahrenheit, and after half-an-hour, when the cylinder had made 900 revolutions, the temperature was found to be 130° Fahrenheit, so that there had been an increase in the temperature of the cylinder of 70° Fahrenheit. The experiment was again

repeated in another form with similar results. Rumford in dealing with the results of his experiments said : " It appears to me to be extremely difficult, if not quite impossible, to form any distinct idea of anything capable of being excited and communicated, in the manner the Heat was excited and communicated, in these experiments, except it be Motion."

Only a year later, Davy gave to the world some results of experiments which he had performed, by which he had arrived at a similar conclusion to that of Rumford, viz. that " Heat is motion of some kind." His experiment consisted of rubbing two pieces of ice together, and by so doing showed the ice could be melted. He then caused two pieces of metal to be rubbed together, keeping them surrounded by ice, and still he found that the two pieces of metal when rubbed together, produced heat, and melted the ice. He therefore rightly concluded that heat was produced by friction, and of the experiment adds : " A motion or vibration of the corpuscles of bodies must necessarily be generated by friction. Therefore we may reasonably conclude that this motion or vibration is Heat. Heat then may be defined as a peculiar motion, probably a vibration of the corpuscles of bodies tending to separate them. It may with propriety be called a repulsive motion. Now bodies exist in different states, and those states depend upon the action of the attractive and of the repulsive powers on their corpuscles, or in other words, on their different quantities of repulsion and attraction." It was not, however, till 1812 that Davy confidently stated that " The immediate cause of the phenomena of Heat is motion, and the laws of its communication are precisely the same as the laws of the communication of motion."

The question therefore confronts us, if heat be motion, what is the particular character of that motion? Is it a vibratory motion as Davy suggested, or is it similar to the undulatory wave motion of light? I need hardly point out, that we have evidence in favour of the hypothesis that light is due to some form of periodic wave motion in the Aether, the hypothesis being that known as the undulatory theory. We have also similar evidence in favour of the hypothesis, that heat is also due to some form of motion of the same aetherial medium. Indeed, it can be shown that heat possesses all the properties of light, and is subject to the same laws, with the exception that it cannot affect the sense of sight.

Heat, then, is due to some motion in the universal aetherial medium, that not only fills all space, but also forms an atmosphere around every atom or particle of matter that exists in the universe, and that motion is generally known as a vibratory or backward and forward motion.

Heat, then, may be said to be due to the vibrations of the

Aether that surrounds all atoms and molecules, and of which those very atoms are composed, that is if we accept the aetherial constitution of all matter. So that, whenever a body, whether it be an atom or a molecule, or a planet or sun or star, is heated in any way whatever, such bodies excite waves in the surrounding Aether, and these waves travel through the Aether towards us from the heated body with the velocity of light. When these waves fall upon any other body, they become more or less absorbed by the body on which they fall, and cause corresponding vibratory motions in the same, which give rise to the phenomenon of heat in that particular body.

It has to be remembered that nothing definite is actually known as to the character of this vibratory motion. It is called a vibratory motion because it possesses a periodic vibratory movement, but as to its exact character, that has not yet been discovered. I hope, however, to indicate what the motion is that produces heat before the completion of this work.

ART. 61. *Heat and Matter*.—If it be true that heat is due to the vibrations of the aetherial medium, the question now arises, as to how a body may become heated, and by so doing be transformed into the three stages in which matter is found. We have already seen (Art. 36), that matter may be found in three forms, viz. solid, liquid, and gaseous, and that all these different forms of matter are composed of minute parts called atoms. In the case of the solid, the atoms are held closely together by some strong attractive power, termed cohesion; in the case of the liquid, the atoms have a greater freedom; while in the gaseous form they have a greater freedom of movement than when in either the liquid or the solid state. According to Young's Fourth Hypothesis (Art. 45), we find that all matter, and therefore all atoms have an attraction for the Aether, by means of which it is accumulated within their substance, and for a small distance around them in a state of greater density, and therefore of greater elasticity. In other words, as Aether is gravitative, every atom possesses an atmosphere of Aether in the same way that the earth has its atmosphere of air; and further, the aetherial atmosphere of each atom is densest nearest to the atom, gradually getting rarer and rarer the further the atmosphere recedes from the nucleus or centre, the elasticity or pressure being always proportionate to the density. Professor Challis, in his *Dynamical Theory of Light and Heat*, states that all the forces in Nature are different modes of pressure under different circumstances of the universal Aether, and as heat is a Force, and therefore a mode of motion, that also must be due to some form of pressure due to the vibrations of the Aether.

Professor Challis¹ on this point says: "According to this theory, the atoms of any substance are kept in position of equilibrium by attractions and repulsions resulting from the dynamical action of the vibrations of the Aether which have their origin at the atoms. Each atom is the centre of vibration propagated equally from it in all directions, and that part of the velocity of the vibration which is accompanied by change of density (of the Aether) gives rise to a repulsive action on the surrounding atoms. This action is the repulsion of heat, which keeps the individual atoms asunder."

With all these facts before us, we are now in a position to account for the changes of matter which take place when heat is applied to either a solid or a liquid body. We have already seen (Art. 36) that it is by the application of heat that matter in its solid form is changed into a liquid, and from a liquid into a vaporous or gaseous form. It is now for us to endeavour to form a mental picture as to how this is done.

For example, let us take an iron ball, and apply heat to it, either by putting it in a furnace or suspending it in some way over an intense heat. As the heat, which is vibratory motion of the Aether, begins to be absorbed by the iron ball, it sets the atoms which compose the ball in motion, urging them to separate, and thus cause the iron ball to expand and increase in volume. As greater heat is absorbed, so greater motion among the atoms is the result. So that the motion of heat is tending all the time to expand the body, while they are held together by the attraction of cohesion, whatever that may be. As the heat is further increased, the iron ball begins to assume a liquid or molten form, its atoms beginning to move about with greater freedom, though held together by a decreased attractive power. In this condition we now say that it is in the molten state. Now during all this time, what has the Aether been doing, or what part has it played in the expansion and changing of the solid to a liquid? We have to remember, from Art. 60, that wherever there is motion of any kind or sort, there we have a capacity to do work, and that the aetherial motion which we term heat is no exception to this rule. We are now no longer dealing with a frictionless medium, but with a medium which possesses weight, because it is gravitative, and consequently possesses inertia also. So that whenever the Aether is set in motion by flame or heat, its motion would be transmitted by waves of some kind to the iron ball. These periodic waves, acting upon the mass of the ball, attack the molecules of the ball and begin to set them in motion. It is supposed that they are already in motion, as nothing is abso-

¹ *Phil Mag.*, 1859.

lutely cold, and the motion of the aetherial waves imparts a greater motion still to the molecules, with the result that the agitation becomes greater and greater, until at length the agitation becomes so great, that the molecules break away from the power of attraction that holds them together, and so begin to move about with greater freedom and with greater rapidity. It is this state which we call molten. Now if Aether be frictionless, as has hitherto been supposed, and if heat be due to the vibratory motions of Aether, the problem confronts us, as to how the motion of a frictionless medium can do work in expanding a body, and urging the molecules of a body further and further apart. If the Aether be frictionless, then the waves of Aether known as aetherial heat waves ought to pass between the atoms as water passes through a sieve, or wind passes through a forest. Yet it is assumed that the vibratory motions of a hot body are caused by vibrations of the periodic waves of the Aether, which act upon the molecules of the body; and, in order for such an assumption to be consistent with the results, the only possible conception that can be accepted of the Aether, is that it is gravitative, and consequently possesses mass and inertia, and therefore has a capacity not only to accept motion, but also to transmit motion to another body, and impart the motion which it has accepted to a colder body.

By imparting such motion, it increases the motion of the cold body, and gradually changes its state from a solid to a liquid condition. Here, then, from the realm of heat we have another argument in favour of the fact that Aether is gravitative, and therefore possesses mass and inertia.

In the experiment of reducing the iron ball from a liquid state, so to speak, to a vaporous condition, we have practically a continuation of the same process, only that greater heat or greater aetherial motion is required, and whereas in the previous experiment the molecules of the ball were acted upon, in this case the atoms are more directly acted upon by the Aether waves. In all these processes it suggests itself to me that the aetherial atmosphere must take its share in the expansion and transformation of the liquid form into a gaseous form, or the solid into a liquid form. Taking the analogy of our atmosphere in its relation to the earth, we know that when heat is absorbed by it, it expands, the result being that a greater pressure is exerted by the expanding atmosphere, than would be exerted if it remained at the same temperature all the time. If, therefore, each atom has an aetherial atmosphere, which is capable of expansion, then the effect of the absorbed aetherial motion of the heat waves on each atomic atmosphere must be to expand it, and thus there will be a pressure *away from* the atom, because of the increased elasticity acquired by the heated aetherial atmosphere. So that

the expansion of the liquid is due to the increased elasticity of the aetherial atomic atmosphere, which has been expanded by heat, and which exerts an increased pressure on neighbouring atoms, thus seeking to push them farther away from each other. There are other motions of the atoms themselves in addition to this to be considered, but I am now seeking to show only the effect of the aetherial atmosphere of each atom upon the neighbouring atoms. This would give each atom a larger sphere of freedom in which to move, and that state would then be called a gaseous and not a liquid one. This assumption of the part which the aetherial atmosphere plays in the expansion of a body is therefore in agreement with Professor Challis' theory of heat already referred to, in which he states that heat gives rise to aetherial vibrations which act repulsively on the neighbouring atoms. In further confirmation of the existence of these aetherial atmospheres that exist around atoms, I would like to draw the attention of the reader to a theory of heat given to the world by Rankine, *Phil. Mag.*, 1851. His theory is known as the "Hypothesis of Molecular Vortices."

He assumed that "each atom of matter consists of a nucleus or central point, enveloped by an elastic atmosphere, which is retained in its position by attractive forces, and that the elasticity due to heat arises from the centrifugal force of those atmospheres revolving or oscillating about their nuclei or centres."

Now in this assumption we find that he admits that each atom has an atmosphere, such atmosphere evidently being an aetherial one, and in that case the hypothesis would agree with the statement in Art. 46, that every atom possesses an aetherial atmosphere. He further points out that the atmosphere is retained in its position by attractive forces. This is also in harmony with the hypothesis given in Art. 45, which proves that Aether is gravitative, and therefore the atmosphere of the atom would be held in its position by the attractive force of Gravitation, as suggested by Young in his Fourth Hypothesis.

Further, he goes on to show that the elasticity of the atomic atmosphere is proportionate to its density, which is also in conformity with the statement made in Art. 47, and is also in accordance with Boyle's Law. Then he goes on to prove that the quantity of heat in a body is measured by the molecular revolutions of the vortices.

He does not clearly define the exact character of those molecular vortices, but I take it to mean that each atmosphere is in a state of revolution around its atomic centre, in the same way that the atmosphere of a planet is in a state of revolution around its central body.

Such an assumption is entirely in harmony with experience, as

there is an analogy for its assumption from the planetary system ; and if an atom is a world in miniature, as I believe it to be, then the atmosphere of the atom ought to revolve around its central nucleus in the same way that the atmosphere of a planet revolves around its nucleus or central body.

He then deals with temperature, and with the pressure of gases caused by heat, showing the relation of elasticity and pressure to temperature in a table of results given in the *Phil. Mag.* for 1851. I must refer the reader to the paper itself for fuller details. Thus from one of the greatest thinkers of modern times we have further testimony to the hypothesis that Aether is matter and is therefore gravitative, and because of its gravitating tendency, it forms around every atom and molecule elastic envelopes or atmospheres, whose pressure is always proportionate to their density.

ART. 62. *Radiation and Absorption.*—We have already seen (Art. 31) that all matter is made up of atoms and molecules, each of which is surrounded by its atmosphere of Aether. By means of the Aether, motion in the form of light and heat may be transmitted from one atom and molecule to another. The transmission of heat from one body to another is termed Radiation, while the acceptance of heat is termed Absorption. Tyndall defines Radiation as “the communication of molecular motion from the heated body to the Aether in which it is immersed,”¹ and Absorption, therefore, would be the acceptance of motion by the body from the Aether. So that in Radiation, the atom, molecule, or body parts with motion to the Aether, while in Absorption it gains motion from the Aether.

Now in order for us to understand this theory of Radiation and Absorption, it will be well for us if we look at a similar effect in the sphere of music and sound. Let us suppose that we have two tuning-forks of the same pitch, placed on a table at a distance of a foot from each other. If we set one of the forks vibrating, the waves which it radiates through the air will fall upon the other one, and will also set it in vibration, because they are of the same period or size as those waves which it would itself give off when sounded. Thus while one is losing its motion, the other is gaining it, or while one is radiating motion, the other is absorbing motion. This can readily be proved by stopping the vibration of the first fork, when it will be found that the second fork is now giving out a similar note to the first, although it was silent at the commencement. Thus we have here an example of radiation and absorption of sound, the success of the experiment depending upon the fact that both forks shall have the same pitch. Again, it must be noted, that if we have two tuning-forks

¹ *Heat, a Mode of Motion.*

both of which are of the same pitch, and both vibrating at the same time, then, while one is radiating sound and consequently losing motion to the other, yet at the same time it is absorbing motion from the other. Because, if fork A can transfer motion to fork B, the latter can equally transfer its motion to fork A, and when both are vibrating together, each is the recipient of part of the other's motion, while at the same time giving off motion in the form of sound waves itself. So that the power of a fork to radiate sound waves equals its power to absorb sound waves. If now we apply this simile to the atomic and molecular world, we shall be able to form a mental picture as to what takes place in radiation and absorption.

All atoms and molecules are ever in a state of ceaseless motion, ever moving, never still. All are creating Aether waves which move away with the velocity of light. If, in the transmission of the waves by the Aether, they fall upon another atom which can emit a wave of similar length, in the same way that two tuning-forks emitted sound waves of the same length, then the atom upon which the waves strike will be set in vibration, as the second tuning-fork was set in vibration by the first. We shall look again at the principle of wave motion in the next chapter. Further, from the simile of the two forks, which absorb sound at the same time that they radiate sound, we learn that an atom or body radiates heat waves at the same time that it is absorbing heat waves. Suppose that we have two bodies at equal temperatures, it must not be thought that the radiation or absorption has ceased, for, according to the simile used, they both still continue to vibrate and emit the aetherial heat waves; but where we get equality of temperatures, there we get equality of radiation and absorption. Before this equality of temperatures, however, is reached, the hotter body will radiate more heat waves than it absorbs, while the colder body will absorb more heat waves than it emits. All bodies, whatever their temperature, are incessantly radiating heat waves. This may be proved experimentally with proper apparatus, as for example with an instrument known as the thermopile. When, however, the total heat waves radiated out by a body are less than it absorbs, the body gets gradually colder, and the temperature decreases. So long as this is continued, so long will the body continue to get colder and colder, until it arrives at the same temperature as the surrounding bodies, at which point the total heat waves radiated out will equal the total heat waves absorbed, and at that point the temperature of the body will remain constant.

This aspect of temperature was first introduced by Prevost of Geneva in 1792, in an article in which he tried to explain the radiation from a cold body. According to his reasoning, a body

is not simply regarded as radiating heat when its temperature is falling, or absorbing heat when it is rising.

What he tried to make clear was, that both radiation and absorption were going on at one and the same time; the radiation depending upon the body itself, but the absorption depending upon the nature of the body. While radiation and absorption are thus reciprocal, which implies that a good radiator is a good absorber, and a bad radiator is a bad absorber, it does not follow that all bodies radiate and absorb alike.

The capacity of bodies to radiate and to absorb differ considerably. Dr. Franklin made several simple experiments to prove the relative powers of radiation and absorption with several pieces of cloth. These were put out on the snow, and exposed to the heat of the sun. He found that the pieces which were dark in colour sank deepest into the snow, while those which were lightest in colour sank the least. From this he inferred that the darkest pieces were the best absorbers, and therefore the best radiators, while the light-coloured cloths were the worst absorbers, and therefore the worst radiators.

Radiation, therefore, may be said to be the propagation of a wave motion through the Aether; and, as all motion is a source of power or energy, we have in the radiation of heat from one body to another by the aetherial waves, the transmission of a motive power capable of doing work, either internal work as increasing the temperature of the molecule or body, or external work as separating the atoms, or driving them further apart. It can readily be seen that if the Aether were frictionless, as has generally been supposed, the Aether could not have any motive power at all, and therefore could not transmit heat from one body to another. Professor Tyndall¹ on this point says, referring to the cooling of a red-hot ball: "The atoms of the ball oscillate in a resisting medium, which accepts their motion and transmits it on all sides with inconceivable velocity." Now in the previous quotation given in this article from the same authority, he states that the atoms are immersed in the Aether. So that evidently in his opinion the Aether and the resisting medium are one and the same. So that our assumption of the gravitative property of the Aether is perfectly in accord with Professor Tyndall's conception of the Aether, in so far as it concerns the propagation of heat waves; and, as will be shown later on, heat and light waves are due to the same physical agent—that is, the Aether; therefore, wherever we get heat and light, there, according to Professor Tyndall's statement, we must have a resisting medium, and as Aether fills all space, the

¹ *Heat, a Mode of Motion.*

resisting medium must fill all space. This is perfectly in accord with our assumption that the Aether is gravitative and possesses inertia—that is, the capacity to receive and to impart motion, and being gravitative it possesses mass or weight, which is the very quality necessary for the existence of a resisting medium.

ART. 63. *Heat is a Repulsive Motion.*—Whatever be the particular character of the vibratory motion of the Aether termed heat, there is one fact regarding the same that is very patent and obvious to all; and that is, that the vibratory motion of heat is essentially a repulsive motion, or a motion from a centre and not one to a centre.

Professor Davy points this out (Art. 60) where he says of heat, "It may with propriety be called a repulsive motion," while Professor Challis (Art. 61) states that "Each atom is the centre of vibrations propagated from it equally in all directions, which give rise to a repulsive action on the surrounding atoms. This action (he adds) is the repulsion of heat which keeps the individual atoms asunder."

There have been many experiments undertaken which go to prove that a repulsive action between atoms and molecules is produced by heat. It has been demonstrated that certain coloured rings, known as Newton's rings, change their shape and position when the glasses between which they appear are heated, thus indicating the presence of a repulsive power due to the increased heat. If we consider the change of state that heat induces in matter, as, for example, from solid to a liquid, or liquid to a gaseous form, we are compelled to admit that heat possesses an expanding and therefore a repulsive motion. It is almost an universal law that heat expands and cold contracts, and the greater the heat absorbed, the greater the expansion. In the case of a solid being converted into a liquid, a much greater heat or repulsive motion is required to separate the particles, on account of the power of cohesion being greater in the solid than in the liquid. As Professor Tyndall¹ states when dealing with the stability of matter from the molecular standpoint: "Every atom is held apart from its neighbour by a force of repulsion. Why then do not the mutually repellent members of the group part company? The reason of this stability is that *two* forces, the one attractive and the other repulsive, are in operation; between every two atoms, and the position of every atom is determined by the equilibration of these two forces. The point at which attraction and repulsion are equal to each other is the atom's position of equilibrium. When the atoms approach too

¹ *Heat, a Mode of Motion.*

near each other, repulsion predominates and drives them apart ; when they recede to too great a distance, attraction predominates and draws them together." If, therefore, there are TWO forces at work in the atomic world, viz. attraction and repulsion, then the question arises, Can that repulsive power be increased in any way, and if so, by what means ? Such repulsive motion, as experiment and experience teach us, can be increased, and such increase may be derived from the absorption of heat which gives rise to increased atomic motion, and so to increased aetherial motion away from the atom, by which the repulsive action of one atom upon another is increased. Thus an atom's repulsive power may be increased by heat ; the greater the heat absorbed, the greater the repulsive power that any atom or body exerts upon a neighbouring atom or body. We can therefore understand how it is, that a body when changed from a solid to a liquid condition occupies a larger space in the latter condition than in the former ; or why a body when changed from a liquid to a gaseous condition occupies a still larger volume in the latter than in its previous condition. The expansion in both cases is essentially the result of the increased repulsive motion that has been imparted to its atoms or molecules by the increased heat, and this increased repulsive power has overcome the attractive power of the atoms or molecules, with the result that they have been driven further and further apart, until, in the gaseous state, the atoms may be very far apart indeed. Wherever, therefore, we have heat of any kind, there we have a repulsive motion, such motion being proportionate to the heat radiated, that is, the aetherial waves propagated by the body. If, therefore, in the atomic world we find a repulsive motion, which is due to the vibratory motions of the Aether generated by heat, the question now confronts us, as to whether in the solar system, and indeed all through the universe, there is not the same repulsive motion from a central body due to the wave motions of the Aether termed Heat.

May we not find in the repulsive power of heat in the atomic world, an indication of that very power for which we are seeking in the solar system—that is, a Centrifugal Force or motion which is the exact opposite of the Centripetal Force or attractive power of Gravitation ? For if heat be a repulsive motion at all, then to be strictly logical it must be equally repulsive in relation to large masses, the sun and the planets for example, as it is in the atomic world, otherwise we have a phenomenon in Nature which contradicts itself, which assumption would be contrary to the simplicity which is to govern our philosophy, and also contradictory to experience, which is the primary factor of philosophical reasoning. Now what are the facts with reference to

the sun, which is the central body of our solar system, and the source of all light and heat in that system? We will look at this aspect of the question under the heading of Radiant Heat.

ART. 64. *Radiant Heat*.—The source of all light and heat, not only of our earth, but also of all the other planets, is to be found in the sun. We have therefore to deal, not with an atom which is generating heat waves on every side, but with a globe about 860,000 miles in diameter, and with a circumference of over 2,700,000 miles. This huge orb consists of a central body, molten or partly solid, with a temperature so hot that it is almost impossible to conceive its intensity. The quantity of heat emitted by the sun has been ascertained by Sir John Herschel from experiments made at the Cape of Good Hope, and by M. Pouillet in Paris.

Sir John Herschel found that the heating power of the sun when it was directly overhead was capable of melting $\cdot 00754$ of an inch of ice per minute. According to M. Pouillet the quantity was $\cdot 00703$ of an inch, which is equal to about half-an-inch per hour. From these results it has been calculated that if the direct heat of the sun were received upon a block of ice one mile square, 26,000 tons would be melted per hour by the heat which would be absorbed. Again, as Herschel¹ puts it: "Supposing a cylinder of ice, 45 miles in diameter, to be continually darted into the sun with the velocity of light, the heat given off constantly from the sun by radiation would be wholly expended in liquefaction on the one hand, while on the other, the actual temperature at the sun's surface would undergo no diminution." Sir John Herschel further says: "All the heat we enjoy comes from the sun. Imagine the heat we should have to endure if the sun were to approach us, or we the sun, to a point the one hundred and sixtieth part of the present distance. It would not be merely as if 160 suns were shining on us all at once, but 160 times 160 suns according to the rule of inverse squares—that is, 25,600. Imagine a globe emitting heat 25,600 times fiercer than that of an equatorial sunshine at noonday, with the sun vertical. In such a heat there is no solid substance we know of which would not run like water, boil, or be converted into smoke or vapour."

Lockyer points out that the heat radiated from every square yard of the sun's surface is equal to the amount of heat produced by the burning of six tons of coal on that area in one hour. Now the surface of the sun may be estimated at 2,284,000,000,000 square miles, and there are 3,097,600 square yards in each square mile; what therefore must be the number of tons of coal

¹ *Lectures on Scientific Subjects.*

which must be burnt per hour to represent the amount of heat radiated from the sun into space? The approximate result may be calculated by multiplication, but the figures arrived at fail to give any adequate conception of the actual result.

From these facts it may be seen that the sun has a temperature far exceeding any temperature that can be produced on the earth by artificial means. All known elements would be transformed into a vaporous condition if brought close to the sun's surface. It may readily be seen, therefore, that the sun is constantly sending forth an incessant flood of radiant heat in all directions, and on every side into space. Now if heat be motion, and be primarily due to the vibratory motion of Aether, what must be the volume and the intensity of the aetherial waves, known as heat waves, generated by the sun? When we remember its ponderous mass, with its volume more than 1,200,000 times that of our earth, its huge girth of more than $2\frac{1}{2}$ millions of miles, and this always aglow with fire the most extensive known—fires so intense that they cover its huge form with a quivering fringe of flames which leap into space a distance of 80,000 miles, or even 100,000 miles, or over one-third of the distance of the moon from the earth,—remembering all these facts, what must be the volume and intensity of the aetherial heat waves which they generate and send upon their course into space on all sides! What a very storm of energy and power must there be in this aetherial atmosphere which exists around the sun's huge form, and with what volume of power must the aetherial heat waves speed away from so great a generating source! Some idea as to their velocity of motion may be gained by the fact, that these aetherial heat waves traverse the distance of 92,000,000 miles between the sun and our earth in the short space of $8\frac{1}{2}$ minutes. With such a velocity of motion as that, and with the fact before us that all motion is a source of energy or power, what must be the energy possessed by these heat waves! There must, therefore, be a power in these aetherial heat waves which is strictly proportionate to their intensity and flow. So that, whenever they come into contact with any body, as a planet, as they flow outwards from the sun, they must exert a power upon such a planet which is directed *away* from the sun, and therefore act upon that planet by the energy of their motion away from the sun, the source of the aetherial heat waves. Therefore, not only in the atomic world is heat a repulsive motion, but equally in the solar world, which is but an atomic world on a large scale, the same principle prevails, and the effect of radiant heat is essentially a repulsive, that is, a centrifugal motion, as it is always directed from the central body, the sun.

Further, it can be shown that the repulsive power of heat in the solar system has already received the attention of scientists, especially in France. This will be seen more fully when we come to deal with the phenomena of comets' tails. One remarkable feature about comets' tails is, that they are always directed away from the sun, and various hypotheses have been advanced to account for that fact. Among them is the hypothesis of M. Faye, in which he assumes that there is a repulsive force which has its origin in the heat of the sun. This repulsive force is not propagated instantaneously, but the velocity of propagation is the same as that of a ray of light. By means of this repulsive power due to the heat of the sun, M. Faye explains how it is that the tails of comets are always turned away from the sun. Here, then, we have an indication of the existence of this repulsive force of heat which we are considering—a repulsive power which finds its source in the aetherial waves, which give rise to the phenomena of Heat, and to which we must look for the ultimate source of that repulsive power or Centrifugal Force which is to form the complementary power to the attractive force of Gravitation.

ART. 65. *Direction of Ray of Heat.*—The question as to the path which a ray of heat takes may best be attacked by finding out what is the path which a ray of light takes in its progress through the Aether. When we come to deal with light, we shall find that it has been experimentally proved that the path of a ray of light is that of a straight line through space; so that if we have any body emitting light, the rays of light will proceed from that body in straight lines, with decreasing intensity, according to the law of inverse squares, the same as Gravitation.

It can readily be shown, that wherever there is light there is heat. For example, the radiant heat from the sun proceeds through space along with the light from the sun, and when one set of waves, the light waves for instance, are intercepted, the heat waves are also intercepted. Or, to take another illustration, when the sun is eclipsed, we feel the sun's heat as long as any portion of the sun is visible, but as soon as the sun is totally eclipsed, then the light waves disappear, and with it the heat waves. From this we can readily see, that not only do the heat and light waves from the sun proceed in the same straight line, but that they also travel at the same rate through space, at the rate of 186,000 miles per second. Then again the common lens, which is so familiar to every one, will prove the same fact by concentrating the rays of light to a focus, and by so doing will produce sufficient heat to burn a piece of paper, or even set fire to wood. If, therefore, the path of a ray of light be that of a straight line, proceeding from the luminous or lighted

body, and the path of a ray of heat coincides with the path of a ray of light, the path of the ray of heat must also be in the direction of a straight line from the heated or luminous body, which, as we shall see in a subsequent article, also decreases in intensity according to the law of inverse squares the same as Gravitation Attraction.

Professor Tyndall, on the direction of a ray of heat,¹ states his opinion on the matter as follows: "A wave of Aether starting from a radiant point in all directions in a uniform medium constitutes a spherical shell, which expands with the velocity of light or of radiant heat. A ray of light or a ray of heat is a line perpendicular to the wave, and in the case here supposed, the rays would be the radii of the spherical shell." From this it can be seen that a ray of light or heat corresponds to what is known as the radius vector of a circle (Art. 20), and therefore a ray of light and heat takes exactly the same path through space (if we consider the sun as the source of the light and heat) as the path of the attractive power of Gravitation. Collecting, therefore, our results from the preceding articles of this chapter, we learn that heat is due to vibrating wave motion of the Aether, and that that motion is a motion which is always directed from the central body which is the source of the heat; and further, that this motion amounts to a repulsive motion acting in an opposite direction to the attractive power of gravity or to the centripetal force of Gravitation. What is more remarkable still, the path of a ray of heat corresponds with, and takes up exactly the same direction through space, whether it be atomic space, solar space, or interstellar space, as the attractive force of Gravitation.

Looking at the subject from the standpoint of the solar system, with the sun as the central body, we see that while we have the sun, which acts as the controlling centre of the particular system of planets, holding all the planets in their orbits by its attractive power, yet at the same time it is also the source of all light and heat. Now heat being due to the wave motion of the aetherial medium, such motion being always exerted from the central body, we arrive at the only legitimate conclusion that can be arrived at, viz. that the sun is also the source of a repulsive motion, which motion coincides with the path that the attractive power of Gravitation takes, that is, along the radius vector of the circle, as shown in Art. 20.

ART. 66. *Law of Inverse Squares applied to Heat.*—The law of inverse squares which governs not only the Law of Gravitation Attraction (Art. 22), but also electricity and light, is equally

¹ *Heat, a Mode of Motion.*

applicable to the phenomena of heat, so that we say the intensity of heat varies inversely as the square of the distance. Thus, if we double the distance of any body from the source of heat, the amount of heat which such a body receives at the increased distance is one-quarter of the heat compared with its original position. If the distance were trebled, then the intensity of the heat would be reduced to one-ninth; while if the distance were four times as great, the intensity of the heat would only be one-sixteenth of what it would receive in its first position. This may be proved from experiments as given by Tyndall in his *Heat, a Mode of Motion*.

Let us apply the law of inverse squares in relation to heat to the solar system, and see what the result gives. In our solar system, we have the sun as the central body, the source of all light and heat, with the eight planets, Mercury, Venus, the Earth, Mars, Jupiter, Saturn, Uranus, Neptune, describing orbits around the central body, and at the same time receiving from it the light and heat which the sun is ever pouring forth into space. The mean distance of Mercury from the sun is about 36,000,000 miles, while that of the Earth is about 92,000,000 miles, so that reckoning the distance of Mercury as unity, the distance of the Earth is a little more than $2\frac{1}{2}$ times that of Mercury from the sun. Now the square of $2\frac{1}{2}$ is $\frac{25}{4}$, and that inverted gives us $\frac{4}{25}$, so that according to the law of inverse squares, the intensity of heat at the Earth's distance from the sun is $\frac{4}{25}$ of what the intensity of heat is at the mean distance of Mercury. Again, the mean distance of Mars is 141,000,000 miles, while the mean distance of Saturn is 884,000,000 miles, and taking Mars' distance from the sun as unity, the distance of Saturn would be represented by $6\frac{1}{4}$. Now the square of $6\frac{1}{4}$ is $(\frac{25}{4})^2$ which gives $\frac{625}{16}$, and the inverse of that is $\frac{16}{625}$, so that the intensity of heat at the distance of Saturn's mean distance from the sun, in comparison with the intensity of heat at Mars' mean distance, would be about $\frac{16}{625}$; or in other words, the heat received by Saturn would be only $\frac{16}{625}$ of the intensity of heat received by the planet Mars. In Art. 63 we have seen that heat is a repulsive motion, being a wave motion of the Aether which is propagated from the heated and central body, which in this case is the sun. Therefore, according to the law of inverse squares from the standpoint of heat, we find in the solar system a repulsive motion, due to the wave motion of the Aether, which is always exerted away from the sun in the same path that the centripetal force takes, and which like that force diminishes in intensity inversely as the square of the distance. So that, wherever the centripetal force, or the attractive force of Gravitation, is diminished on account of the increased distance

from the sun, the repulsive motion due to heat is also diminished in exactly the same proportion and along exactly the same path. If at any point in the solar system the attractive force is doubled, then according to our repulsive theory of heat, and the law of inverse squares, the repulsive motion is also doubled. If the attractive force is halved, then the repulsive motion is halved also, the repulsive motion being always and at all places exactly proportional to the increase or decrease of the attraction of Gravitation.

ART. 67. *First Law of Thermodynamics.*—The Law of Thermodynamics is based on two fundamental truths which have reference to the conversion of Heat into Work, and Work into Heat. In Art. 54 we have already seen that energy in the form of heat, light, electricity and magnetism is capable of being converted into other forms of energy, while in Art. 59 we have seen that Joule gave us the exact relation in foot-pounds between heat and work. He showed that when 1 lb. of water fell through 772 feet its temperature was raised one degree Fahr. Thus the principle underlying the first law of thermodynamics states, that whenever work is spent in producing heat, the amount of work done is proportionate to the quantity of heat generated; and conversely, whenever heat is employed to do work, a certain amount of heat is used up, which is the equivalent of the work done. This principle is also in accord with the conservation of Energy and Motion (Arts. 52 and 57), which assert that whenever energy or motion disappears in one form, it is manifested in some other form. Thus, from the first law of thermodynamics, we learn that wherever we have heat we have the power to do work, and the amount of work so done is proportionate to the heat used up. Heat, then, has a capacity to perform work, and that power is known as the mechanical equivalent of heat. Both Mayer of Germany, and Dr. Joule of Manchester, have worked out this problem, and have given us the mechanical value of heat. By experiments Mayer found out that a quantity of heat sufficient to raise 1 lb. of water one degree Fahr. in temperature was able to raise a weight 771.4 lb. one foot high. Dr. Joule of Manchester, after making a number of experiments which lasted over many years, came to the conclusion that the mechanical equivalent of a unit of heat was 772 foot-pounds, a unit of heat being the quantity of heat which would raise 1 lb. of water one degree Fahr. So that if a 1-lb. weight fell from a height of 772 feet, an amount of heat is generated which would raise 1 lb. of water one degree Fahr.; and conversely, to lift 1 lb. 772 feet high, one degree Fahr. of heat would be consumed.

Now if this law of thermodynamics is true, it must not only

be true in relation to terrestrial heat, or heat produced by artificial means on our earth, but it must equally hold good in relation to the solar system ; and not only the solar system, but equally true throughout all the systems of worlds that flood the universe. So that wherever we get heat in the universe, in the solar system for example, there, according to our first law of thermodynamics, we should have the capacity to do work of some kind or other. That work may take either the form of expanding a body, as the atmosphere of a planet for example, or it may take a mechanical form, that is, actually moving a body by the increased pressure due to aetherial heat waves generated by the sun. We have already seen in Art. 64, on Radiant Heat, what a store of heat the sun has. For thousands and millions of years the sun has been pouring forth its heat rays into space, and yet its temperature does not seem to be diminished. The great Carboniferous or coal period of past geological times is an indication of the heat and light of the sun, which it must have radiated out millions of years ago ; and year by year, these aetherial heat waves are still being poured forth by the sun on every side into space, so that no matter where a planet may be in its orbit, there it may be the recipient of these aetherial heat waves which break upon its surface. Now if there be this quantity of heat existing in the sun, and heat according to the first law of thermodynamics has a mechanical value, which is that it can push or lift a body through space, the question arises, as to what is the mechanical value of this heat of the sun ? Are we to suppose that if one unit of heat can lift 1 lb. 772 feet, the millions and millions of units of heat which are constantly being poured out of the sun into space are doing no work at all ? Such an assumption is not only contrary to that simplicity which governs our Philosophy, but is entirely opposed to experience, which is the very foundation of all philosophical reasoning. If, therefore, experience is to be any guide at all, we are compelled to come to the conclusion that the heat poured forth into space does do work on the bodies, as comets, meteors, planets, upon which the aetherial heat waves fall. The problem is, what is the character of the work done ? I have already indicated part of the work, viz. in the expansion of the atmosphere of the planets. Then there is also the reception of the heat by the animal and vegetable life of the planet, but these do not account for all the motive power of the aetherial waves, which break upon the planet or its atmospheres.

The true solution of the first law of thermodynamics, in its relation to the solar system, seems to me to be found in the fact already stated in Art. 63, viz. that heat is a repulsive motion,

and the law of thermodynamics confirms that statement, and shows that the work done on a planet by the aetherial heat waves is that of pushing it, or urging it by their very energy and motion away from their controlling centre, the sun. This would practically amount to a repulsive force which had its home in the sun, and this conception would bring our Philosophy into harmony with our experience, which teaches us that wherever there is heat there is the capacity of doing work, the amount of work being proportionate to the heat generated and consumed.

ART. 68. *Second Law of Thermodynamics.*—This law was enunciated by Sadi Carnot in 1824, when he wrote an essay on the Motive Power of Heat. Previous to the time of Carnot no definite relation seems to have been suggested between work and heat; Carnot, however, discovered what were those general laws which govern the relation between heat and work. In arriving at his conclusion, he based his results on the truth of the principle of the conservation of energy already referred to (Art. 52).

Carnot started his reasoning on the assumption that heat was matter, and therefore indestructible. The two great truths in relation to heat and work, enunciated by Carnot, are known as, first, a Cycle of operations; and, secondly, what he termed a Reversible Cycle. In order to be able to reason upon the work done by a heat-engine, say a steam-engine for example, Carnot stated we must imagine a cycle of operations, by which, at the end of such operations, the steam or water is brought back to exactly the same state in which it was at its start. He calls this a cycle of operations, and of it he says, that only at the conclusion of the cycle are we entitled to reason upon the relation between the work done and the heat spent in doing it. His other idea of the reversible cycle implies that an engine is reversible when, instead of using heat and getting work from it, the engine may be driven through the cycle of operations the reverse way, that is, by taking in work, it can pump back heat to the boiler again. Carnot showed that if you can obtain such a reversible engine, it is a perfect engine. All perfect engines, that is all reversible engines, will do exactly the same amount of work with the same amount of heat, the amount of work being strictly proportionate to the amount of heat consumed. I need hardly point out that the reversible engine, or the perfect engine of Carnot, is only the ideal one, as there is no engine in which all the heat is converted into work, as a great deal of the heat is radiated away and not converted into work at all. Again, working from the standpoint that heat is matter, Carnot reasoned that in the heat-engine the work is performed, not by

the actual consumption of heat, but by its transportation from a hot body to a cold one. Thus, by the fall of heat from a higher to a lower temperature, work could be done in the same way that work could be done by allowing water to fall from a higher to a lower level. The quantity of water which reaches the lower level is exactly the same as that which leaves the higher level, as none of the water is destroyed in the fall. He argued, therefore, that the work produced by a heat-engine was produced in a similar manner, the quantity of heat which reaches the condenser being supposed to be equal to that which left the source. Thus the work was done by the heat flowing from a hot body to a cold one, and, in doing this work, it lost its momentum like falling water, and was brought to rest. One of the most important points noted by Carnot is the necessity that, in all engines which derive work from heat, there must be two bodies at different temperatures, that is, a source and a condenser, which correspond to a hot and cold body, so that there may be the passage of heat from the hot to the cold body. In order to get work out of heat it is absolutely necessary to have a hotter and a colder body. From this reasoning we learn, therefore, that work is obtained from heat by using up the heat of the hotter body, part of which is converted into actual work, while part is absorbed by the colder body. So that wherever we have two bodies at different temperatures, according to the second law of thermodynamics, there we have the power of doing work by the transmission of heat, from the body of higher to the one of lower temperature.

That Carnot ultimately came to believe in the dynamical theory of heat, is proved by the following passage taken from his notes on the Motive Power of Heat: "It would be ridiculous to suppose that it is an emission of matter, while the light which accompanies it could only be a movement. Could a motion produce matter? No! undoubtedly, it can only produce a motion. Heat is then the result of motion. It is plain then that it could be produced by the consumption of motive power, and that it could produce this power. Heat is then simply motive power, or rather motion which has changed its form. It is a movement among the particles of bodies. Wherever there is a destruction of motive power, there is at the same time production of heat in quantity exactly proportional to the quantity of motive power destroyed. Reciprocally, whenever there is destruction of heat there is production of motive power."

Let us apply this principle to the solar system, and endeavour to find out whether in that system we have, in relation to the heat thereof, either a cycle of operations or a reversible cycle. We have again to consider the sun as the source of all light and

heat in the solar system, radiating forth on every side, year by year, the countless units of heat which go to form the continuance of all planetary life and existence. One of the problems that has confronted scientific men for many years is this, Where does the sun get its supply of heat from? When we remember the incessant loss of heat which the sun suffers through its radiation of heat into space, we are compelled to ask, How is that supply maintained, and how has it been kept up through the countless ages of the past? Several suggestions have been made, and several theories advanced to account for the fact. Mayer, of Germany, suggested that the heat is partly maintained by the falling into the sun of meteors, which, like comets, pursue a path through the heavens, and are subject to the attractive influence of the sun. In the combustion of these meteorites, or meteors, he contended there were the means by which the light and heat of the sun might be maintained. Whatever theory, however, may be suggested as to the maintenance and the source of the continuity of the sun's heat, I do not think it has been suggested by any scientist that the heat emitted and radiated by the sun is ever returned in any way back to the sun from infinite space, whether by reflection or by any other method. So far as I can learn, there are no facts in connection with the solar system which would lead us to make that assumption. On the contrary, experience and experiment teach us that radiation implies loss of heat, and that the body, which so radiates, ultimately becomes cold, unless its internal heat is kept up by some means or other. So that the terms introduced by Carnot in the second law of thermodynamics, viz. that of a Cycle of Operations and of a Reversible Cycle, do not apply to the solar system, and the solar system, viewed from the standpoint of a machine, with the sun as the source of the heat, does not represent a perfect engine, that is, all the heat is not used up in doing work, some of it being radiated out into space. Wherever, however, the heat, that is the aetherial heat waves generated by the sun, comes into contact with a planet, as Mercury, Venus, or Jupiter, then, in accordance with Carnot's reasoning, work is done. Carnot points out that, in order for work to be done, we must have a source and a condenser, that is, two bodies at different temperatures, a hot body and a cold one. Now these conditions of work are satisfactorily fulfilled in the solar system, and as a result work is performed. We have the sun with its huge fires, and its intensity of heat, representing the source or the hot body, while every planet and every meteor and comet, that come under its influence, represent the cold body, and between the two work is always going on. That work is represented by the repulsive power of heat, which I have

already indicated, so that, viewed from Carnot's standpoint with relation to the motive power of heat, we find that there are in the solar system those conditions which govern work, and by which, from a mechanical standpoint, work is performed; further, that work takes the form of a repulsive power on every planet or other body upon which the aetherial heat waves fall. Therefore, from the second law of thermodynamics we have another proof of this repulsive power of heat already indicated and referred to in Art. 63.

ART. 69. *Identity of Heat and Light.*—We have seen from the preceding articles of this chapter, that heat is due to a periodic wave motion of the Aether, and in the succeeding chapter we shall also see that light is due to some kind of periodic wave motion in the Aether. So that not only heat, but light also, it would appear, is due to certain periodic wave motions that are set up in the Aether by the vibrations of hot or luminous bodies. The question therefore arises, how many wave motions are there in the Aether? Are there different wave motions which in one case produce light, and in the other case produce heat, or are light and heat both produced [by the same set of aetherial waves? The identity of light waves with heat waves is manifested by the fact that wherever we get light we get heat, as can be proved in many ways. One of the simplest proofs is found in the common lens or burning-glass, by which the light waves are brought to a focus, and as a result, heat is manifested. Although there is this close identity between light and heat waves, yet there must be some distinction between the heat and light waves, because while light waves affect the eye, heat waves do not. There is actually a difference between the two kinds of waves, and that difference is one of period or length. It must not, however, be thought that there are really two classes or sets of waves in the Aether, one of which could be called light waves, and the other heat waves, but rather the same wave may be manifested in two different forms because of its different wave lengths. In one case the waves may affect the eye, and we have the sensation of sight, but in the other case they affect the body, and we experience the sensation of warmth. An analogy from the waves of sound may make these facts much clearer. We know that sound travels about 1100 feet per second. If, therefore, we have a bell which vibrates about 1100 times per second, we should have a wave one foot long. If it vibrated 100 times per second the waves would be 11 feet long, while if it vibrated only 11 times per second, the waves would be 100 feet long. Now the impression made upon the ear depends upon the number of vibrations the bell makes per second, and from the rate of vibration we get the idea of pitch. If the vibrations are very

rapid, then we get a note of high pitch, and if the vibrations are slow, then we get a note of low pitch. A note of high pitch, therefore, will correspond to waves of short length, while a low note will correspond to waves of a greater length; so that the greater the rapidity with which a sounding bell vibrates, the shorter will be the length of the sound waves which it generates, and *vice versa*. The range of the ear however for sound waves is limited, so that if the vibrations be too rapid or too slow, the ear may not be able to respond to the vibrations, and so no distinct impression of the sound will be conveyed to the brain. It need hardly be pointed out, that both the very short and long waves are of exactly the same character as those of a medium length, which the ear can detect, the only difference being one of rapidity. We do not therefore suggest that in the case of sound, where the vibrations lie outside the compass of the ear, those which lie outside are not sound waves, or that they are different from those which lie within the compass of the ear, and which the ear can detect. Whether the sound waves are long or short, whether they can be detected by the ear or not, we still say that all are sound waves, and that all are due to the vibrations of the sounding body, which vibrations are transmitted through the air, in waves, that fall upon the tympanum or drum of the ear, and set that vibrating, which vibrations are transmitted to the auditory nerve and so give rise to the sensation of hearing. In a similar manner, every atom and every particle of matter, every planet, every sun and star, is constantly in a state of vibration, sending off aetherial waves on every side. Nothing in Nature is absolutely cold, nothing is absolutely still. Therefore all matter, whether in the atomic form, or in the planetary or solar world, is constantly generating aetherial waves, which travel from their source or origin with the velocity of light. If these aetherial waves so generated fall within certain limits, then they affect the eye, and we get the sensation of sight. To do this they must vibrate 5000 billion times per second, and if they fail to do this, they fail to give rise to the sensation of sight. If the aetherial waves fall below this limit, then they affect the body, and give rise to the sensation of heat. For it must be remembered, that as the ear has a certain compass for sound waves, which may vary in different individuals, so the eye has also a certain compass for aetherial waves, with the result that some waves may be too slow or too rapid to affect the eye, and consequently fail to give rise to the sensation of sight. When that is so, the sensation of warmth helps us to detect these longer waves, so that the longer waves would warm us and make their presence felt in that manner. We shall see in the next chapter that there are both shorter and longer waves, which may be

detected in other ways. From these facts it can be readily seen, that we have a common origin for both light and heat, and that they are both due to periodic waves in the Aether, and therefore all the laws that govern heat should also govern the phenomena of light. Further, if heat possesses a dynamical value, and if there be such a truth as the motive power of heat, then there ought equally to be a motive power of light ; and further, if heat possesses a repulsive motion, then because of the identity of light and heat, light should equally possess this repulsive power, because it is due to similar periodic wave motions in the Aether. With regard to the same laws governing both light and heat, we shall see that this fact also holds good. We have already seen (Art. 66) that the intensity of heat is inversely as the square of the distance, and we shall also see in the succeeding chapter that the same law holds good in relation to light. We have seen (Art. 65) that the path of a ray of heat is that of a straight line ; we shall see in the succeeding chapter that the path of a ray of light is that of a straight line also.

Indeed, there is no law applicable to heat which is not applicable to light. The law of reflection and refraction of heat equally holds good in relation to light ; and further, Professor Forbes has shown that heat can be polarized in a similar manner to the polarization of light. This last fact is considered the most conclusive argument as to the identity of light and heat, and proves that the only difference between the two is simply the difference corresponding to the difference between a high note and a low note in sound. That being so, I hope to be able to show that as heat possesses a dynamical value, so light equally possesses a dynamical value, and that as heat is a repulsive motion, then light must equally possess a similar repulsive motion, that motion always being directed from the central body, being caused by the same agency, viz. the waves of the Aether, the common source of both light and heat. I purpose to address myself to this subject in the following chapter, which I have termed Light, a Mode of Motion.

CHAPTER VII

LIGHT, A MODE OF MOTION

ART. 70. *Light, a Mode of Motion.*—No subject has in the past received greater attention from philosophers and scientists than that involved in the question as to “What is Light?” Indeed, it may truthfully be said, that even to-day its exact character is not positively known. That it is due like heat to some periodic wave motion in the Aether is known, but the exact character of that wave motion has yet to be determined. As in the case of heat, so in the case of light, there have been two theories which have contended with each other for supremacy in endeavouring to answer the question as to “What is Light?” Those two theories are known as the Emission or Corpuscular Theory, and the Undulatory or Wave Theory. The corpuscular theory was introduced and developed by Newton in his work on *Optics*, which ranks second only to the *Principia* as a work revealing masterly research and scientific genius. Newton supposed that a luminous or lighted body actually emitted minute particles, which were shot out from the body with the velocity of light, that is, at the rate of 186,000 miles per second. These minute particles he termed corpuscles. In the work just referred to regarding this matter, he asks the question, “Are not rays of light very small bodies emitted from shining substances?” These small particles or corpuscles were supposed by him to actually strike the retina of the eye, and so produce the sensation of Sight, in the same way that odorous particles entering the nostril, come into contact with the olfactory nerves and produce the sensation of Smell. In order, however, to account for certain phenomena of light, he was compelled to postulate an aetherial medium to fill all space, in which his luminous corpuscles travelled, and which would excite waves in that medium. In his eighteenth query on this point he asks: “Is not the heat of a warm room conveyed through the vacuum by the vibration of a much subtler medium than air, and is not this medium the same with that medium by which light is reflected or refracted, and by whose vibrations light communicates Heat to bodies, and is put into fits of easy reflection and easy transmission?” The corpuscular theory, however, received its

death-blow when, in competition with the wave theory of light, as developed by Young, it was found that the latter theory satisfactorily accounted for certain phenomena as the refraction of light, which the corpuscular theory did not adequately account for. Even while Newton was developing his theory, Huyghens, a contemporary of Newton, was developing another theory which is now known as the undulatory or wave theory. Huyghens drew his conclusions from the analogy of sound. He knew that sounds were propagated by waves through the air, and from the region of the known, endeavoured to carry the principle into the region of the unknown, a strictly philosophical method, and one in accordance with the second Rule of Philosophy. He supposed that light, therefore, like sound, might be due to wave motion, but if it were wave motion, there must have been a medium to propagate the waves. In order to account for this wave motion, he supposed all space to be filled with a luminiferous Aether, which would be to his light waves what air is to sound waves. In this conception he was supported by Euler the mathematician, and in 1690 he was able to give a satisfactory explanation of the reflection and refraction of light, on the hypothesis that light was due to wave motion in the Aether. It was not, however, till the advent of Thomas Young, that the undulatory or wave theory reached its perfection, and finally overthrew its competitor the corpuscular theory. Young made himself thoroughly acquainted with wave motion of all kinds, and applied his knowledge and experience to the phenomena of light, and from the analogies so obtained, he gradually built up the undulatory theory, and gave to it a foundation from which it has not yet been moved. Young made use of the same aetherial medium in order to propagate the wave motion of light in the same way that Huyghens did. From that conception, the Aether has been gradually perfected, until we have the conception which has been presented to the reader in Chapter IV., in which I have endeavoured to show that this aetherial medium is matter, but infinitely more rarefied and infinitely more elastic, but notwithstanding its extreme rarefaction and elasticity, it possesses inertia, because it is gravitative. It is this Aether, then, that is concerned in the propagation of light, and is the universal medium which is to light what air is to sound. Young, therefore, having applied himself to the wave motion of sound, from such researches was able to explain the physical cause of colour, and that phenomenon termed interference.

We will therefore look at wave motion, in order to understand the wave theory of light.

Now in all wave motion, whether it be water waves or sound waves, that which is propagated or conveyed from place to place

is energy, or motion. If a stone is thrown into water, a series of concentric circles of waves are generated, which spread out with increasing size, but decreasing power or motion, regularly on all sides. The water, however, does not move away from the generating source. There is a motion of the water, but it is simply a wave motion, so that the propagation of a wave is the propagation of motion, rather than the transference of the actual water which constitutes the wave. In the case of sound waves, we have again an illustration of the same principle. For example, suppose we strike a bell, and so set the particles of that bell in a state of vibration. These vibrations give the air in contact with the bell a forward movement, and then, owing to the elasticity and inertia of the air, a backward movement is set up, with the result that a series of waves are set in motion from the bell on every side, which gradually diminish in intensity the farther they recede from the generating body. According to the wave theory, therefore, we have to picture all heated and luminous bodies in a state of vibration, and the atoms of such luminous bodies imparting the vibrations to the atoms of the Aether, in the same way that the atoms of a bell impart their vibrations to the atoms of the air in contact with it. These vibrations are then propagated through the Aether in waves, which, entering the eye, impinge or strike upon the retina at the back of the eye, and being transmitted to the brain give rise to the sensation of sight. It must not be forgotten that the waves of Aether, as pointed out in Art. 64 in relation to heat, really form spherical shells which radiate out in all directions from the central body which gives rise to them. Thus it can be seen, that all points in the spherical wave which are at equal distances from the vibratory or luminous body, must possess the same intensity, and possess equal lighting powers. Light, therefore, like heat, is due to a periodic wave motion set up in the Aether by the vibrating atomic motion of heated or luminous bodies. It must be also noticed, that if we could see the air through which the sound waves are passing, we should see that each atom or particle of the atmosphere was vibrating to and fro in the direction of propagation. If, however, we could see an atom of Aether in vibration, accepting the principle that Aether is atomic, we should see that each aetherial atom is not vibrating in the direction of propagation, but across the line in which the wave is travelling. Thus the vibration of the air is said to be longitudinal, but the vibrations of the Aether are transversal. An illustration of the transverse motion of a light wave may be obtained by taking a rope and imparting to it a series of undulations by shaking it up and down, when it will be observed that the wave motion of the rope is transverse to the straight line in

which it is propagated. The physical explanation of the transverse vibration of light will be dealt with in a subsequent article.

Now the question suggests itself to our mind, as to what effect the atomicity of the Aether has upon the undulatory theory of light. Does it establish it upon a firmer basis, or does it in any way destroy its truth as a theory? I venture to think that the atomicity of the Aether in no sense destroys any part of the undulatory theory of light, but rather tends to confirm and establish it upon a logical and philosophical basis.

For instance, as has been pointed out in Art. 47, in order for the undulatory theory to have any existence at all, it is essential that the Aether should possess the property of elasticity. But how the Aether possessed the property of elasticity while at the same time it was frictionless, and therefore possessed no mass, has been a problem that has taxed the ingenuity and resources of scientists for a century past, and up to the present is a problem which still remains unsolved. Now, however, with our atomic Aether, it is just as easy to conceive Aether transmitting a wave as it is for air to transmit sound waves, or water to transmit water waves.

Tyndall, in his *Lectures on Light*, seems to have appreciated the difficulty, and to avoid confusion, again and again refers to a *particle* of Aether. While Huyghens himself in speculating upon the elasticity of the Aether in his *Traité de la Lumière*, 1678, makes a suggestion as to its origin, which practically amounts to the fact that the aetherial atom which gives rise to this elasticity is the core or centre of a vortex ring. Thus it can be seen that the elasticity of the Aether, so essential to the undulatory theory, is a problem that cannot be solved apart from recognizing the hypothesis of an atomic Aether.

Then, again, in the undulatory theory of light, the density of the Aether around molecules of bodies has to be taken into consideration to account for such phenomena as the refraction and reflection of light, but, as we have seen in Art. 46, such a property as density is inconceivable in connection with a medium which is neither atomic and possesses no mass. On the assumption, however, of an atomic and gravitative Aether, the difficulty is at once solved, and the density of the Aether, and different degrees of density are at once placed upon a logical and philosophical basis. So that in relation to the elasticity and density of the Aether upon which the transmission and reflection of wave motion depend, an atomic and gravitative Aether establishes and confirms the undulatory theory.

There is also another aspect of the subject that is worthy of notice. I refer to the effect of an atomic and gravitative Aether

upon Newton's corpuscular theory of light. Newton's corpuscular theory failed in not being able to account for the relative velocity of light in rare and denser media, and if by an atomic Aether in conjunction with the undulatory theory, the phenomenon can be accounted for, as I believe it can, then our aetherial vortex atoms are analogous to Newton's corpuscles. This distinction will, however, have to be made, viz. that Newton supposed his luminous corpuscles to be emitted by the luminous body, whereas in the conception of our aetherial atoms, we conceive them to be stationary relatively in space, and only subject to those vibrations and oscillations that give rise to the aetherial waves recognized in the undulatory theory.

It would indeed be a consummation to be desired, if, by an atomic Aether, it can be proved that Newton's Corpuscular Theory was made to harmonize with the Undulatory Theory, and that it can be I am profoundly convinced. Professor Preston is also of this view, for in his *Theory of Light*, writing on this subject, he says, page 19: "In conclusion, we may state that we believe an ingenious exponent of the emission theory, by suitably framing his fundamental postulates, might fairly meet all the objections that have been raised against it."

We will now apply the hypothesis of an atomic and gravitating Aether to Huyghens' principle of wave propagation, and see if this atomicity in any way destroys that principle, or whether it simplifies and confirms it.

Let us briefly review our conception of the Aether before making the application. In the first place, because Aether is gravitative, we learned from Art. 45 that it surrounds all bodies in the universe, from the smallest atom to the largest sun or star in the firmament of heaven. Our sun, then, which is to our system the source of all its light, will be surrounded by what are practically spherical aetherial envelopes or shells which decrease in density as they recede from the sun (Art. 46). These aetherial shells are, according to our conception, made up of minute aetherial spherical vortex atoms possessing polarity and rotation (Art. 43), and these atoms will be closer together the nearer they are to the central body, because of the increased density of the Aether due to the attractive influence of the sun. Thus, when a wave motion is set up in the Aether around the sun by the intense atomic activity of that incandescent body, each atom of that aetherial spherical shell or envelope participates in the motion or impulse received, at one and the same time, so that the wave is transmitted from envelope to envelope, by the elasticity of the aetherial atoms which compose the envelope or shell. Thus the light wave is always spherical in form, or nearly so, as the rotational and orbital motion of the sun affect the

exact shape of the aetherial envelope as we shall learn more fully later on.

Further, the wave front always takes the form of a sphere, as the waves are radiated out from the luminous body in all directions, and we shall learn, in the next article, that the vibrations are always in the wave front, that is, take place on the surface of each of these envelopes, and these vibrations are also transverse to the propagation of the wave. As these aetherial envelopes extend right into space, the wave is transmitted from envelope to envelope by means of the aetherial atoms with the velocity of 186,000 miles per second, but as each succeeding envelope possesses a larger surface than the preceding one, the intensity of the light is proportionally decreased. The surface of such envelope is always proportionate to the square of the radius, the other quantities remaining equal. So that the intensity of the light waves, which are coincident with the

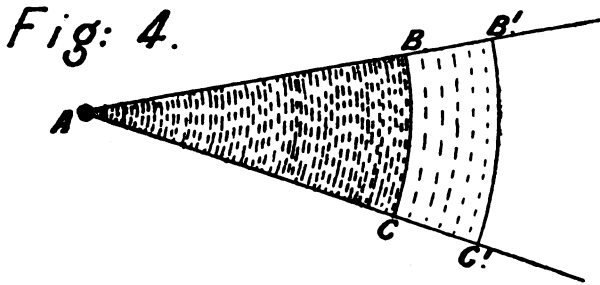

surface of each spherical envelope, will always vary inversely as the square of the distance from the luminous body, which agrees with the law of inverse squares that governs light and heat.

We have considered the wave motion as a whole, that is, we have viewed it from the standpoint of the whole of the aetherial elastic envelope. Now we will look at the subject from the atomic standpoint, and see if it is in accordance with Huyghens' principle of wave propagation.

We will suppose that an undulatory movement is started by a luminous body at point *A* situated in the Aether, and surrounded by that medium. *A* may represent a part of any luminous body, as the sun or star, while *BC* and *B'C'* represent a segment of the aetherial envelopes already referred to, which exist around the sun. We will further suppose that the small dots surrounding the luminous body represent the aetherial atoms forming the envelope, which transmit the impulse or energy received from the atomic vibrations of the luminous body. As each aetherial atom

is moved or pushed forwards, each atom directly in contact with it accepts and transmits the impulse. But each of these atoms stands in relation to those in front of them, as they did in relation to the first row of atoms, so to speak, and therefore exert a corresponding impulse on the front row.

But the third row stands in relation to the fourth row as the second row did to the third, and so on to infinity. Thus each atom being surrounded by other atoms may be looked on as the centre of a new wave system, so that every particle of the wave system is itself a centre of a new wave system which is transmitted in all directions. As these innumerable and minute wave systems co-operate with one another, they form a principal wave system which is coincident with the surface of the spherical envelope, part of which is represented by $B C$. Then if we conceive of all the aetherial atoms in part of the principal wave system $B C$, as themselves becoming the centre of wave propagation, by their wave systems the principal wave will be transmitted further on into space to another aetherial envelope $B' C'$, which represents part of another principal wave, which again is coincident with the surface of one of the spherical aetherial envelopes. So that by the action of the aetherial atoms which exist on all sides of the luminous body, the aetherial wave can be transmitted from atom to atom in more or less spherical form.

Now let us compare this explanation of the transmission of light by an atomic Aether with the celebrated Huyghens' principle which is thus enunciated. "When an undulatory movement propagates itself through an elastic medium, every *particle* imitates the movement of the particle first excited. But every particle stands in relation to the adjoining ones in exactly the same relation that the first particle did to its neighbours, and consequently must exert upon those surrounding it, exactly the same influence as the first did. Every vibratory particle is therefore to be regarded as if it were the originally excited particle of the wave system; and as the innumerable and simultaneous elementary wave systems co-operate with one another at each instant, we obtain exactly that principal wave system by which the elastic medium appears at any moment to be moved." Now here, in this statement, we have the definite term *particles* used several times by Huyghens. But in the generally accepted theory of the Aether, such a term is unknown and unrecognized, with the obvious result that the definite and simple statement of Huyghens loses all its simplicity and meaning. Replace, however, the non-atomic Aether as at present recognized, by an atomic and gravitating Aether, and then Huyghens' exposition or principle stands out in all its

simplicity and clearness, and finds in an atomic Aether its literal fulfilment and complete verification.

In conclusion on this point, viz. that light is a mode of aetherial motion, let us endeavour to form a mental picture of our atomic and aetherial world. We have to remember that every particle and atom of matter in existence are ever vibrating, and by their vibrations are ever creating and generating Aether waves in the aetherial medium. These waves, begetting others, the process is continued until they are either intercepted and brought to rest by other matter, or else speed away until they reach the boundary of space.

Now it is scarcely necessary for me to say, that if one atom can create and generate these Aether waves, a thousand atoms can create them in greater abundance still, and millions of atoms in even still greater abundance, and so on in proportion to the quantity or bulk of the matter vibrating. Further, as it is with quantity, so will it be with intensity, or activity of vibration. The more intensely an atom vibrates, the more intense would be the movement of the generated Aether waves, and the intensity would be in exact proportion to the intensity of the motion of the atoms vibrating. In regard to the power of atomic motions or vibrations, those are the greatest and most intense in energy or motion, which are produced by combustion or burning. The chemical activity by which the burning is brought about arouses and excites the atoms of matter subject thereto, into an intensity of motion, thousands, it may be millions of times greater than can be produced by any other known means. Therefore it can be readily seen, that the Aether waves generated by this means will be greater and more abundant, both in their volume and intensity, than the Aether waves produced merely by a cold body. For example, take a candle at night-time when the light has disappeared; look at it and feel it. Though its atoms are all in motion, generating Aether waves which are impressed with its own particular form and colour, yet it can scarcely be seen even at a short distance; but light it, and what a change takes place! We can both see it, and are enabled by its light to see other things also. By the power of combustion, its atoms have been excited into greater energy or motion, generating and speeding Aether waves on every side, and these Aether waves being reflected and re-reflected by the atoms of the air, and the walls of the house, give light to all that are in the house. I must now ask the reader to refer to Art. 64 on Radiant Heat, in order that we may recall facts regarding the heat of the sun. Remembering the intensity of the heat of the sun as calculated by Herschel and others, and remembering that the sun is 1,200,000 times larger

in volume than our earth, the question naturally suggests itself to our mind, what must be the volume and intensity of the light waves as they flow from the sun into space? What a storm of fury and of motion must there be within the aetherial atmosphere around the sun, and with what volume and power must these light waves speed away from so mighty a source! Some idea may be gained from the fact that they speed away to the distant Neptune, a distance of nearly three thousand millions of miles, and impart to that planet the energy of light and heat which to the planet forms the physical source of all its life and activities. Thus from the sun, the centre of the solar system, there are ever being poured forth into space these aetherial light waves. The solar fires are ever glowing, and their flames ever burning, robbing the solar disc with its quivering fringe, or madly leaping on every side to a distance of one hundred thousand miles, and by their madness lashing the aetherial atmosphere into fury, creating aetherial waves, myriads upon myriads, and sending them with lightning speed across the intervening space. As swift-footed messengers they come, the bearers of life and beauty to distant planets. They come to this our island home in space, these aetherial light waves, like rich argosies freighted with the treasures of light, of life, of beauty, and of glory, and the transmission of this life and beauty is effected by the incessant wave motion generated in the Aether by the central body of our solar system, the sun. Let us therefore endeavour to form a mental picture of this aetherial wave motion with its transverse vibrations.

ART. 71. *Transverse Vibration of Light.*—In the previous article we saw that the vibration of light was transverse to the line of propagation. If we could see the particles of air which are vibrating when sound waves are produced, we should find that each particle or atom is vibrating backwards and forwards in the direction of propagation.

In the case of an aetherial atom, however, which, according to our own theory, participates in the vibration, we have to try to conceive of each atom as vibrating across the line of propagation. So that if AB represents a ray of light proceeding from a luminous body, as the sun (Fig. 5), then the vibration must be across the line, as up and down and across that line as shown in the figure, each phase of the vibration being at right angles to the line of propagation—that is, to AB . How can we form a physical conception of this phenomenon? There must be some physical explanation to it, for if it be an effect there must be a cause for its existence and production. Up to the present, however, no physical explanation has been forthcoming, so that for over 200 years a frictionless medium has failed to account

for, or to explain, the transverse vibration of light as suggested by Fresnel.

If, therefore, by the hypothesis of an atomic and gravitative Aether, we succeed in accomplishing a result that a frictionless Aether has failed to accomplish, then the explanation will be a most important factor in proving the atomicity and consequent gravitative property of the Aether.

Let us therefore revert to our hypothesis of the Aether as given in Art. 45. From that we learn, because Aether is atomic, it is also gravitative, and therefore forms around every atom and molecule, every satellite, planet, sun and star, an aetherial

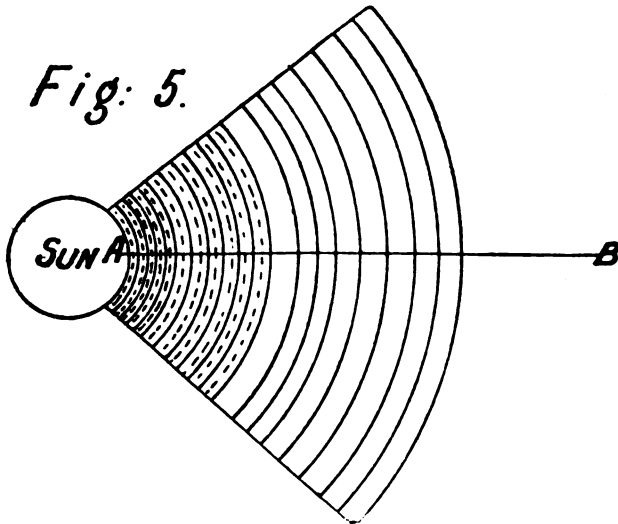

atmosphere—such aetherial atmosphere being doubtless proportionate to the mass of the atom or molecule or planet as the case may be, in accordance with the Law of Gravitation. We shall consider this view of the subject later on.

Thus we learn that every particle of matter, and every body in the universe has its aetherial atmosphere so to speak, to which it is held bound by the universal Law of Gravitation. In the case of a satellite or planet or sun or star, that atmosphere will be more or less spherical in shape, decreasing in density as it recedes from the attracting body. As we saw in the previous chapter, Tyndall stated that the waves of light really formed spherical shells which surrounded the luminous body. In the conception of an atomic and gravitating Aether we can form a physical conception of these aetherial shells, which can be

pictured as elastic envelopes, or rather series of envelopes surrounding each particle of matter, and also surrounding each satellite, planet, sun, and star; each envelope getting gradually less and less dense as the distance from the central body is increased.

Now we learn from experiments that the vibration is always in the wave front, but the wave front is coincident with the surface of each aetherial spherical shell, therefore the vibration must be in, and coincide with, the surfaces of the spherical shells that are formed around every body in the universe.

We are now, however, dealing specially with one body which is the source of light, viz. the sun, and have therefore to picture the sun as being surrounded by these aetherial elastic envelopes, which gradually get less and less dense as they recede from it. What, therefore, will be the effect of the heat of that body as it is poured forth into space? We have already learned (Art. 63) of the untold quantity of heat that is continually being poured forth into space from the sun with its diameter of 856,000 miles, and its circumference of over $2\frac{1}{2}$ million miles. What intense activity it must generate in the Aether near its surface! and what must be the direct effect of that heat upon the aetherial elastic envelopes or shells which surround it?

Perhaps the answer can be best illustrated by a simple experiment. Let us take an ordinary toy balloon, with its elastic envelope, and fill it moderately full with air, and observe what the effect on it is when we put it near the fire. Gradually, as heat is imparted to the air in the balloon, the air which is also elastic expands, with the result that the envelope of the balloon is extended, and its size enlarged. Now withdraw it from the fire and note what happens.

As the air inside gets cold again, the elastic envelope of the balloon gradually shrinks, until it has been reduced to its former size. What has been taking place during this experiment with regard to the elastic envelope and the atoms thereof? May we not say that there has been a vibration or oscillation, among the particles which go to make up the elastic envelope, that forms the surface of the balloon? Certainly there has been some form of motion, and that motion took first the form of an expansion, and then contraction of the individual particles; and we have only to conceive of this process being repeated quickly and continuously, to form a mental picture of what takes place in any aetherial elastic envelope or shell that surrounds the sun.

The illustration is not, however, perfect, because we have made the source of heat to be outside instead of inside the elastic envelope, as is the case with the sun and its aetherial atmo-

sphere or envelope. We will therefore slightly modify the experiment, and take two balloons, *A*, *B*, one smaller than the other, and put the smaller one *A* into the interior of the larger one, inflating the smaller one, so that it can be situated in the middle of the larger one, the latter having twice the diameter of the smaller one, as in the diagram (Fig. 6). To the neck of the smaller balloon *A* we will attach an india-rubber tube which ends in a closed bulb *C*. We have now the two balloons inflated. Let us press the bulb *C* and notice what happens. The effect will be exactly the same as it was when we brought the balloon in contact with the heat of the fire in the first experiment—that is, the elastic envelope will be again expanded. As soon as we take the pressure from the bulb *C* the envelope, being elastic, seeks to recover its original position, with the result that it springs back to its original size. If we pressed the bulb *C*

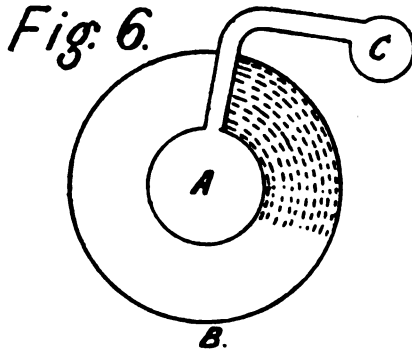

20 times per minute, we should get 20 vibrations of the particles of the envelopes per minute, and if we pressed it 1000 times per minute, we should get 1000 vibrations among the particles of the elastic envelope, so that the number of vibrations would correspond to the number of times we pressed the bulb. Now how did this vibration reach the elastic envelope of the balloon *B* from the balloon *A*?

The reply is, by means of the particles, or atoms of air that exist between the two surfaces of the balloons, and that transmission would take the form of a wave propagated from particle to particle, so that we might put dots on the right side of *A* to represent the atoms of air which transmit the wave from *A* to *B*.

But the vibration which takes place in the surface of the envelope of the outer balloon is *across* this line of propagation, because as the wave proceeds from *A* to *B*, the elastic envelope

expands and stretches always *across* the line of propagation—that is, it stretches up and down, left and right, as it is expanded outwards, so that the vibration or oscillation of the particles always takes place in the surface of the elastic envelope across the line of propagation. Let us therefore apply the result of this simple experiment to our solar system and the Aether, and see if it can be made to explain the transverse vibration of light. Let *A* represent the sun (Fig. 7) and *B* an aetherial elastic envelope surrounding the sun. In this case we dispense with the bulb *C*, as the sun possesses within itself the power to generate heat, and so to produce the required expansion of the elastic aetherial envelopes *B*, *G*, *H*, etc.

Instead, however, of having air particles between *A* and *B*, we will put in their place our aetherial atoms which we have conceived according to Art. 44. These surround the sun, repre-

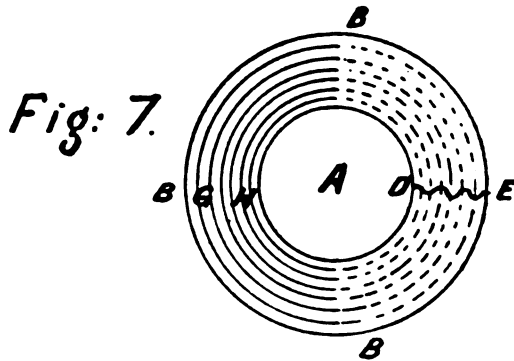

sented by *A*, forming elastic spherical shells or envelopes. As the sun radiates its heat into space, it urges the aetherial atoms against each other, with the result that they transmit the energy from atom to atom, or particle to particle, till they come to the elastic aetherial envelopes of *H*, *G*, *B*.

The effect on *B*, or on any other aetherial envelope, is to expand it outwardly, and thus set the atoms of which it is composed into vibration. The wave, which is now an aetherial wave travelling with a velocity of 186,000 miles per second, may be represented by the line *D E*. But while it is travelling from *D* to *E* the same energy is being radiated out in all directions, so that a wave reaches the whole surface of the elastic envelope *B* at the same time, with the result that the whole of the shell or envelope is set in vibration as it expands outwardly.

Thus the vibration is always in the wave front, and the wave front is always coincident with the surface of one of these

envelopes, and as these aetherial envelopes are themselves formed by aetherial atoms, the wave is spread outwardly from any central point in a spherical form as proved by experiment. Not only, therefore, is the vibration in the wave front, but it is always transverse to the line of propagation, for the simple reason that the surface of the spherical shell or envelope is always at right angles to the radius vector or straight line which joins any centre to the surface of a spherical envelope.

As soon as the aetherial atom which forms the spherical aetherial envelope has reached the limit of its expansion, it seeks to recover its former position because of its elasticity, with the result that the whole envelope contracts again, and arrives at its original position in space ready to accept motion again and transmit it onwards in the same manner as before.

Thus, by the acceptance of an atomic and gravitating Aether, we may form a physical conception of one of the greatest problems in optical phenomena, viz. the transverse vibration of light which always takes place in the wave front, and across the line of propagation. Whether this explanation is exactly correct in detail, or not, I am convinced that the true physical explanation of the problem is to be found in an atomic and gravitating Aether, as hitherto a frictionless Aether has failed even to suggest to any scientist how such a transverse vibration can take place.

ART. 72. *Reflection and Refraction.*—A ray or wave of light is said to be reflected when it meets with an obstacle which opposes its free passage and turns it back. We have illustrations of this law of reflection in the case of water waves striking against a breakwater, or a sound wave striking against the wall of a room. In either case the wave is turned back, and reflection is the result. A ray or a wave of light is said to be refracted when, in passing from one medium into another, it is turned from the straight path in which it was going before it entered the refracting medium. An illustration of the refraction of light is to be found in the case of the glass lens, so often used to converge the light waves into one focus. We have up to the present dealt with only two theories of light, the Corpuscular theory and the Undulatory or Wave theory. We have seen how both harmonize with Huyghens' principle, and the question arises as to whether both can be made to harmonize with the phenomena of reflection and refraction.

In the Corpuscular theory we have luminous particles emitted by luminous bodies. These particles we have learned are practically synonymous with our aetherial atoms.

In the Wave theory it is impossible to conceive of a wave without conceiving of particles which transmit the wave; even

Huyghens refers to particles of Aether, and so does Tyndall in his *Notes on Light*.

In the Electro-magnetic theory of light we have again to think of atoms, which are termed electrons by Dr. Larmor and Sir William Crookes; while Professor J. J. Thompson calls them corpuscles.

So that in all three theories we have the same fundamental idea of atoms, either expressed or imagined, underlying all the three theories. Now what is the property of the Aether on which all reflection and refraction is based? Is it not the property of density? Fresnel assumes that reflection and refraction of light are dependent upon different degrees of density of the Aether associated with any body, and has given a mathematical formula, which decides the index of refraction, such formula being entirely dependent upon the relative density of the Aether in association with the refracting medium.

But with a frictionless medium, it is an absolute impossibility to conceive of different degrees of density of the Aether in association with matter.

If the Aether does possess different degrees of density which decide the refractive index of the substance, then of a certainty there must be some law to govern and decide the density, and that law can only be the Law of Gravitation.

As Young points out in his Fourth Hypothesis, every particle of matter has an attraction for the Aether by which it is accumulated around it with greater density. Now on the basis of our conception of a gravitative Aether, every atom and molecule, and indeed every body in the universe, possess aetherial atmospheres, which possess varying degrees of density, the denser layers being nearest to the nucleus of the atom or molecule as the case may be, the elasticity of each layer or envelope being always proportionate to its density.

When we apply the corpuscular theory to the reflection of light we find that it satisfactorily accounts for the phenomenon.

According to Newton's corpuscular theory, each luminous particle travels in a straight line through a homogeneous medium. When, however, it comes almost into contact with a reflecting surface, which in our case we conceive to be a layer of one of the aetherial elastic envelopes surrounding the atoms or molecules of the reflecting body, then, according to Newton, the light particle is repelled, or reflected by the medium; the angle of reflection or repulsion being always equal to the angle of incidence. So that the emission theory harmonizes with the wave theory in regard to reflection.

When, however, we come to deal with the refraction of light, the corpuscular theory apparently breaks down, and it was in

relation to this phase of the phenomena of light that the undulatory theory overthrew the corpuscular theory.

According to the corpuscular theory, when a luminous particle or corpuscle is nearing the surface of a denser medium, as glass or water, it was attracted by the denser medium, with the result that the velocity of the particle in the denser medium was greater than its velocity in air. But direct experiments prove exactly the opposite, as it is found that when light passes from a rare into a denser medium, the velocity of light in the denser or more refracting medium is less than it was in the air. Here then was a test to decide the respective merits of the two theories. As the undulatory theory was able to give a satisfactory explanation of the phenomenon, the corpuscular theory was rejected, and the undulatory theory was accepted. Now the question suggests itself, as to whether it is possible to reconcile the two theories in relation to the refraction of light by our conception of an atomic and gravitative Aether. I believe it is possible. Let us look at the case for a moment. We have, according to our theory of the Aether, to conceive of all atoms and molecules, of all planets and suns and stars, being surrounded by aetherial elastic atmospheres, or envelopes, which, like the atmosphere in association with the earth, are always the densest nearest the nucleus of the atom, getting gradually less and less dense the further they recede from the central point. Further, according to our theory, with regard to the elasticity or pressure of these elastic envelopes, they exert a pressure proportionate to their density. So that the nearer the aetherial atmosphere or envelope is to the central point or nucleus of the atom, the greater will be the elasticity or pressure.

Now what I wish to call the reader's special attention to is, that the pressure in each and every case of the aetherial elastic envelopes which surround the central nucleus, is always directed *away from* the central point, and here it seems to me is the solution of the difficulty which Newton failed to solve. For when a luminous corpuscle enters any medium, assuming it to do so, it would have to overcome the pressure due to the increased elasticity of the denser aetherial envelopes, and as the two motions, viz. that of the incident ray, and the pressure due to the elasticity of the elastic envelope, would be in opposition to each other, the result would be that the luminous corpuscle, if it entered the medium at all, would be retarded and not accelerated as suggested by Newton, and such a result is perfectly in harmony with experiment. So that by our theory of an atomic and gravitating Aether, it seems to me that it now becomes possible to reconcile the two theories.

There is another difficulty that the emission theory had to

contend with, and that was, how was it possible for the same surface of any substance to reflect and refract a corpuscle at one and the same time? Newton overcame this difficulty by suggesting, from the results of his observations on certain coloured rings, that each particle had what he called certain phases or fits, of easy reflection or refraction, so that at certain times they would be refracted, and at other times they would be reflected.

Boscovitch has suggested that the fits were due to the fact that each luminous corpuscle possessed polarity; which, by rotating, alternately offered their different sides to the refractive and reflecting surfaces, so that sometimes they would be reflected or repelled, and at other times attracted or refracted.

A similar hypothesis has also been suggested by Biot. Now if such a hypothesis will satisfactorily account for the fact that the same medium will reflect or refract the luminous corpuscles, as the case may be, then in our aetherial atom we have the very conditions which would satisfy both Boscovitch and Biot's hypothesis. For one of the properties that we suggested regarding our aetherial atom was, that it possessed rotation like our own earth, and that it also possessed polarity.

The harmonizing of the two theories, therefore, seems to rest upon the atomicity or non-atomicity of the Aether.

It is absolutely certain that the electro-magnetic theory of light demands the recognition of some form of atomicity for the Aether. For if light be really an electro-magnetic phenomena, as has been proved by Maxwell and experimentally demonstrated by Hertz, then, in view of the fact that the atomicity of electricity is coming within the scope of direct experiment as asserted by Dr. Larmor, unless we accept atomicity of the Aether in some way, we shall be in the unphilosophical position of having the Aether of space not being composed of atoms, while the electricity associated with that Aether in some unknown way is composed of atoms. In other words, we shall have a non-atomic body composed of atoms, which conclusion is absurd. Therefore, from the electro-magnetic theory of light, we are again compelled to postulate atoms of some kind for the Aether.

If there are electrical atoms in association with the Aether, then they must be of two kinds, positive and negative, as it is impossible to find positive electricity disassociated from negative. Therefore, from the electro-magnetic theory of light we get further evidence of the polarity of the aetherial atom, by which Newton's fits of easy reflection or refraction may be physically conceived.

I am convinced, that with the hypothesis of an atomic and gravitative Aether as suggested by Young in his Fourth Hypothesis, all three theories of light in relation to the phenomena of reflection and refraction can be harmonized. I wish only to point

out the direction in which to look for the solution, and must leave it to scientists to work out the problem.

ART. 73. *The Solar Spectrum*.—When a ray or beam of solar light is passed through a prism, it is broken up or decomposed into its constituent parts. This is called dispersion, and conclusively proves that the light from the sun is not a simple, but a compound colour. We have illustrations of this decomposition of pure white light in the rainbow, where the colours of the sunlight are revealed against the sky with clearness and precision. A simple experiment to prove that the solar light is a compound one may be made by boring a small hole in a shutter, and then allowing the sunlight that passes through the hole to fall upon a prism, such as the pendant of a candelabrum. When this is done, then on the opposite wall of the room will be seen, not one colour, but seven colours, ranged in the following order: Red, Orange, Yellow, Green, Blue, Indigo, Violet. This is termed the Visible Spectrum.

It may be asked, What is the cause of the various colours in the spectrum? We have already seen that light is due to a wave motion of the Aether, and it can be demonstrated that the various colours of light are due to different wave lengths. Colour is to light what pitch is to sound. As has been shown in Art. 62, the pitch of a note depends upon the number of air waves which strike upon the tympanum of the ear in a given time. The more rapid the vibration, the higher the note. The more rapidly a sounding body vibrates, the shorter will be the length of each wave. If a violinist wants to produce a note of higher pitch, he presses his finger on the string, thereby shortening it, and by so doing increases the rapidity of vibration, and raises the pitch of the note. Now the colours of the spectrum are to the eye what the notes are to the ear. The aetherial waves which produce the red colour are slower in their vibrations, and are longer than those which produce the orange colour. Those which produce the orange colour are of slower vibrations, and longer than those which produce the yellow colour, and so on through all the other colours; until we get to the violet and to the ultra-violet, or invisible violet rays, which are the most rapid in their vibrations, and consequently their wave lengths are the shortest of the whole group. It has been ascertained that it takes about 39,000 waves of red light to measure an inch if placed end to end. Now light has a velocity of 186,000 miles per second. If this is reduced to inches, we find that there are 11,784,960,000 in that distance. Let us therefore multiply this number by 39,000, and we shall then find how many waves of red light must enter the eye to produce the sensation of red colour. That number is 459,613,440,000,000, so

that all these waves enter the eye in one second of time, and must strike the retina of the eye in order to produce the sensation of redness. In the same way, the number of waves that must strike the retina of the eye to produce the sensation of violet can be determined. It takes about 57,500 waves of violet to measure an inch, so that a violet wave is only $\frac{1}{57500}$ part of an inch in length. All the other colours of the spectrum which lie between the violet and the red waves gradually get longer and longer in their wave lengths, and slower and slower in their vibrations, until at the red end of the spectrum and beyond it we have the longest waves, which are from $\frac{1}{37500}$ part of an inch in length to $\frac{1}{10000}$ part of an inch.

The seven colours seen in the spectrum are called the Visible Spectrum. There are, however, rays of light beyond both ends of the spectrum which do not affect the optic nerves of the eye, and therefore are invisible to sight. The rays in the spectrum which lie beyond the red are termed ultra-red rays, while those beyond the violet are called ultra-violet rays. It can be proved the former are rich in heating power, while the latter possess great chemical power. By means of an instrument known as the thermo-electric pile, or thermopile, the various heating power of the whole spectrum, visible and invisible, can be determined.

Let us look for a moment at these invisible or dark rays. Strictly speaking, all light is invisible, as we cannot see light itself, we can only see it by reflection. We have seen that light is due to a wave motion in the Aether, but we cannot see that wave motion, neither can we see the Aether itself, so that it is not strictly correct to call a ray visible or invisible. We have, however, accepted the terms in relation to the rays of the spectrum, to distinguish between the invisible or obscure rays of the spectrum and the visible rays. It was Sir W. Herschel who first discovered the existence of these invisible waves. He passed a thermometer through the various colours of the solar spectrum, and then noted the temperature of each colour. He did not, however, stop at the limit of the visible spectrum, but experimented with his thermometer beyond its limits, and then found that beyond the red rays there were other rays, the ultra-red rays, which possessed greater heating power than any other rays of the spectrum. Thus his experiments proved, that side by side with the luminous or light waves, there were other rays, which, though they possessed greater heating power, yet were not able to excite the optic nerve, and so produce the sensation of sight.

From these facts we learn that the solar spectrum may be divided into three parts—

1. The red or ultra-red end of the spectrum which possesses the greatest heating power.
2. The central part, yellow and green, which is the greatest in luminous power or light waves.
3. The violet or ultra-violet end, which possesses great chemical or actinic power as it is sometimes termed.

We have already seen (Art. 69) that the same aetherial waves which give rise to heat, also give rise to light, and that the only physical difference between heat and light is, that the waves which cause the phenomena of heat are of slower period, and of greater length, than those which cause the phenomena of light. From the solar spectrum we learn that there are a third class of Aether waves, which are of more rapid vibration, and therefore shorter in length than either the aetherial heat waves or the aetherial light waves. As already stated, these are called chemical or actinic waves, because they possess a greater chemical power than either the heat or the light waves that form the central part of the spectrum.

Now this question suggests itself to us in relation to these chemical waves. What are these so-called chemical waves that are produced in the aetherial medium by the activity and heat of the sun? It must be remembered that the aetherial waves which give rise to both light and heat, and also these chemical waves, are first set in motion by the sun, at least as far as our solar system is concerned. We are perfectly conversant with the phenomena and characteristics of both heat and light. We are able to exactly determine what their particular effect will be on matter, and to describe that effect in a perfectly straightforward manner. The same, however, cannot be said of these so-called chemical waves that lie chiefly in the violet and ultra-violet end of the solar spectrum. What, then, is a chemical wave, its particular nature, and its exact properties? That we know it can decompose certain compounds, as Carbonic Acid Gas, CO_2 , and so give rise to chemical decomposition, has been proved by Professor Tyndall and others, but I have never yet seen any record of any attempt to find out what these chemical waves are. There may have been such attempts made to discover their origin and character, but I have not seen any such record. I purpose, therefore, to offer an explanation as to the character and origin of these chemical or actinic waves, which I hope to prove by philosophical reasoning. We have already seen (Arts. 54 and 59) that both heat and light are convertible, or can be transformed into electricity, so that the same aetherial wave motion which can produce light can also produce heat, and that in its turn can produce electricity. Thus we learn that there is a very close identity between light, heat, and electricity; indeed

it can be demonstrated that the same aetherial wave motion which produces electricity can produce the other two.

Lorentz,¹ in an article on "The Identity of Light Vibrations with Electric Currents," states that "the vibrations of light are themselves electric currents." Now if this is true, and I believe it to be true, as I hope to prove later on from Clerk Maxwell's works, then it necessarily follows, that wherever we get aetherial light waves, we must at the same time also get aetherial electric waves. If that be so, then in the solar spectrum we ought to have revealed to us, not only indications of the presence of the heat and light vibrations, but equally so the presence of electric waves. This, I believe, is actually the case, and the electric waves are the so-called chemical waves in the violet and ultra-violet end of the spectrum. I think that we shall find sufficient arguments and analogy to support this hypothesis, as we look further into the matter. One of the greatest scientists of the past century, Clerk Maxwell, has given to the world the genesis of what he termed the Electro-Magnetic Theory of Light, in which he proved that light was nothing more nor less than an electro-magnetic phenomenon. He pointed out that the same Aether which was concerned in the propagation of light and heat through space, must therefore be equally concerned in the propagation of electric displacements in the free Aether; as he states, it would be philosophically wrong to assume that there was one aetherial medium for light, and another for electric phenomena. If, therefore, there is such a theory as the Electro-Magnetic Theory of Light, and there undoubtedly is, as has been proved by the researches of Hertz on electric waves, then it follows, either that light waves are themselves electric currents, as suggested by Lorentz, or that the light waves are directly associated with electric waves in the same way that they are associated with heat waves. So that the only difference between them would be one of period of vibration and of length, the electric waves of the Aether being of greater rapidity and therefore of shorter length than either the light or heat waves. The only conclusion, therefore, that it seems possible to come to regarding these chemical waves is, that they are the electric waves of the spectrum. Thus, in the solar spectrum, there are three classes of waves indicated by the various colours, and beyond the limits of these colours, viz. (1) Thermal or Heat waves in the red or ultra-red end of the spectrum; (2) Luminous or Light waves at the middle of the spectrum; and (3) Electric or Chemical waves in the violet or ultra-violet end of the spectrum. Now in looking at this hypothesis from the standpoint

¹ *Phil. Mag.*, 1867.

of our Rules of Philosophy, I venture to assert that all the three rules are satisfactorily fulfilled, and that being so, the hypothesis advanced is philosophically correct. In the first place, such a conception that the chemical waves or violet waves are really electric waves is simple in its hypothesis, and so fulfils our first Rule of Philosophy. It is simple, because it puts in the place of unknown chemical waves, a certain kind of aetherial waves with whose action we are definitely familiar, and whose origin and effect can be satisfactorily accounted for, as proved by Hertz. Chemical waves are not simple in conception, because we do not know exactly what they are, or how they are originated. Besides, as Newton points out, there is nothing superfluous in Nature. If one cause can effect the desired end, as electric waves, then another cause as chemical waves is superfluous and unnecessary. Further, in our hypothesis of the electric character of these chemical waves, we have a solution which satisfactorily fulfils the second Rule of our Philosophy. Experience and experiment teach us, that there are electric waves constantly being generated in a thousand ways. Indeed, it is an absolute impossibility to perform the simplest act of ordinary life, as brushing a hat, or wiping the boots on a mat, cutting an orange, or any other act of simple everyday life, but that these aetherial electric waves are generated. But as for these so-called chemical waves, experience has little to say about them, and experiment still less. If we decompose water, dividing it up into two gases, Oxygen and Hydrogen, we do it by passing a current of electricity through the water. If we want to decompose or split up a binary compound, as HCl, into its two elements, Hydrogen and Chlorine, then we can do it by electricity—that is, by the decomposing action of these electric waves. In all these experiments and results we know definitely what we are doing, and what the effect will be. There is no vagueness about the terms used. When we speak of chemical action we look to a definite source for that action, and we do not say that such action is produced by chemical waves, but rather by electricity. So that all experience teaches us, and all experiments made by such men as Faraday, Davy, Maxwell, and Hertz confirm the statement, that these aetherial electric currents can accomplish all that the so-called chemical waves accomplish, and that being so, the third Rule of our Philosophy is also fulfilled, as we have in the aetherial electric waves a satisfactory explanation for the fact which we seek to explain, viz. the character and origin of the chemical waves that exist in the violet end of the spectrum. Thus, we learn, that not only is the sun the source of all heat and light, in that it gives rise to the vibrations of the Aether which are propagated through it in waves, but that it is also

the source of all electric waves in the solar system, in that electric currents are primarily due to the wave motion set up in the Aether, those electric waves also traversing space with the velocity of light.

ART. 74. *Direction of Ray of Light.*—In Art. 65 it was shown that the direction of a ray of heat was that of a straight line from the heated or luminous body from which the Aether waves proceeded. We have also seen in Art. 69 that the aetherial waves which give rise to the phenomena of heat are identical with those that give rise to light, so the direction of a ray of light must also be that of a straight line proceeding from the luminous body. A ray of light is a line perpendicular to the Aether waves which are propagated through space in concentric spheres from the luminous body, which, by its atomic vibrations, gives rise to the light waves. It must, however, be remembered that rays have no physical existence, for it is the waves that are propagated, and not the ray, which simply indicates the direction that the light takes, this truth being known as the rectilinear propagation of light. That light proceeds in straight lines may be proved in several ways. For example, we cannot see round corners, which would be possible if light took a curved path instead of a straight one. A better proof, however, may be obtained by making a small hole in the window-shutter, and allowing the sunlight to pass into the darkened room. The beam of light which passes into the room will then be seen to take a straight course, its presence being revealed by the particles of dust that float about the room.

Another conclusive proof that light proceeds in straight lines is to be found in the fact, that all images formed on any screen by the rays of light after passing through a small hole are inverted. For example, suppose we have a window-shutter with a small hole in it, while in the garden fronting the window there stands a tree. Now if the rays of light which pass from the tree through the hole in the window-shutter are allowed to fall upon a screen in the darkened room, it will be found that the image is inverted.

This is accounted for by the fact, that the rays cross each other at the hole, and proceeding in straight lines, form an inverted picture on the screen. It can further be proved, that the path of a ray of light through space as it proceeds from the sun is also that of a straight line. Whenever there is a solar eclipse we have light so long as we can see the smallest part of the sun's surface. The instant, however, that we have a total eclipse, at that instant the whole of the light of the sun is shut off, and for a brief space there is darkness, until the planet which is causing the eclipse has passed on in its orbit and the

sun's surface reappears again. Now if light did not proceed in straight lines, such an event as a total eclipse would be impossible; because, if the light proceeded in curved lines instead of straight ones from the sun, then even when the planet which causes the eclipse got directly between the earth and the sun, the rays of light being curved instead of straight would bend round the eclipsing planet, and so would not all be intercepted, and thus such an event as a total eclipse would be an impossibility. From this we learn, therefore, that the path of a ray of light as it proceeds from the sun through space is that of a straight line, and that the path corresponds to the radius vector of a circle, which is also the path that the centripetal force takes.

Viewing the matter from the standpoint of the solar system, we find the sun, which is the centre of that system, exerting an attractive force along the radius vector of all the orbits of the planets, with a force which decreases in intensity inversely as the square of the distance. At the same time, being the source of all light, it is constantly propagating into space aetherial light waves with a velocity almost inconceivable; which also decrease in exactly the same ratio as the attractive power of the sun decreases. If, therefore, it can be shown that there is such a truth as the dynamical value of light, in the same way that it has been shown that there is a dynamical value of heat, then it follows, that not only is the sun the centre of an attractive power which proceeds in straight lines, but it is equally the centre of a power whose influence and motion are exerted along exactly the same path as the centripetal force, but in an opposite direction, that is, away from the sun. I hope to be able to show that the aetherial light waves do possess such a dynamical value, and if that is accomplished, then not only from the realm of heat, but also from the realm of light, we shall have conclusive evidence of a power or motion whose influence is directed away from the sun, which, therefore, would correspond to a centrifugal force—that is, a force or motion directed from a central body as the sun.

ART. 75. *Intensity of Light.*—The intensity of light diminishes with the distance from the luminous body, according to the same law that governs sound, and heat, and electricity. We have already seen (Art. 67) that the intensity of heat diminishes inversely as the square of the distance, so that if the same law holds good for light that holds good for heat, then, according to the law of the inverse squares, if we double the distance from the luminous body, the intensity of light is only $\frac{1}{4}$ of what it was in its first position. If the distance be trebled, then the intensity will be decreased $\frac{1}{9}$. This can easily be proved

L

by the following experiment: Suppose we have a lighted lamp, and at a distance of 1, 2 and 3 feet respectively, we have three square surfaces. It can then be demonstrated that the light which falls on the square 1 foot away, if allowed to fall upon the square 2 feet away, would cover four times the area of the first square; and if allowed to fall on the square 3 feet away, it would cover nine times the area. Therefore the intensity of the light on the square 2 feet away, covering four times the area, would only be $\frac{1}{4}$ of what it is on the square 1 foot away, while the intensity of light on the square 3 feet away, which covers nine times the area, would only be $\frac{1}{9}$ of the intensity received by the first square.

If the difference in the distances therefore be represented by the figures 1, 2, and 3 feet respectively, the intensity would be represented by the figures 1, $\frac{1}{4}$, $\frac{1}{9}$. The decrease in the intensity of light is really a decrease in motion. The intensity of a note in sound depends upon the vibration of the particles of air, while the intensity of light also depends upon the vibrations of the aetherial atom.

If, therefore, we get a decrease in the vibration of the aetherial atom, the further we get from the luminous body, it can be readily seen that the intensity of light really implies a decrease of motion.

Now let us apply the law of inverse squares in relation to light to the solar system. We have the sun with its huge form all aglow with fires, as the source of all light to the planetary worlds that revolve around it. Year in and year out, for many ages past, the sun has been pouring out its light into space on every side, lighting up the planets or other bodies that revolve round it on that side only which is presented to the sun. Thus Mercury, at its distance of about 36,000,000 miles, obtains a light from the sun which is of far greater intensity than the light which Venus receives, while Venus receives a light of greater intensity than the light which the Earth receives, and the Earth receives light of greater intensity than any of the planets outside its orbit in the solar system, as Mars, Jupiter, Saturn, Uranus, or Neptune. This decrease in the intensity of light is according to the inverse square of the distance from the central body, the sun. So that if we have one planet at twice the distance from the sun, as compared with another planet, the intensity of light at that distance will be only $\frac{1}{4}$ of the intensity received by the nearer planet. This decrease of the intensity of light, however, may be compensated for by a difference in the constituents of the planets' atmosphere, by means of which it may be possible that the outermost planets enjoy climatic conditions similar to our own.

Now we have proved, in the previous chapter, that heat is a repulsive motion, and as the same aetherial waves give rise to the phenomena of light, then it ought to follow that light has equally a repulsive power on the planets with which it comes into contact. If that can be proved, and I submit that it can, then from the phenomena of light, we learn that there is a force, or rather a motion, ever proceeding from the sun in straight lines, as shown in the previous Art., which decreases in power or intensity inversely as the square of the distance. So that not only is the sun the centre of an attractive Force, the Centripetal force, or the attractive Force of Gravity, which proceeds in straight lines through space, decreasing in intensity inversely as the square of the distance, but at the same time it is also the centre of a motion, that is, the aetherial wave motion of light, which takes exactly the same path as Gravitation Attraction, and which is subject to exactly the same laws. Unlike Gravitation Attraction, however, its power and motion is ever directed away from the central body, the sun; and if such motion exerts any power on any planet with which it comes into contact, that power or motion can only be a repulsive motion in the same way that heat is a repulsive motion. Assuming, therefore, that light, through the medium of the aetherial waves, does exert this repulsive motion, then, according to the law of inverse squares, it can be seen that if a planet's distance be doubled, the repelling power of the aetherial light waves would be decreased $\frac{1}{4}$, while at the same time the attractive power of the centripetal force would be decreased $\frac{1}{4}$ also. If, on the other hand, the planet's distance from the sun be reduced to $\frac{1}{2}$ of its former distance, then the repelling power of the aetherial light waves would be increased four times, but contemporaneously with the increase there would be an increase in the attractive power of gravity, which would exactly counter-balance the increased repelling power of the light waves. So that in assuming that there is this repelling power in the light waves, there are thus two forces in existence in the solar system (which is a type of all other systems), or rather two motions, as all forces resolve themselves into motions of some kind, one motion ever tending from the central body, that is, the motion of the aetherial light waves, and the other tending to the central body, that is, the force of gravity, which we shall see later on is also a motion of the Aether, whose influence is ever towards the central body, be it a sun, star, or planet. These two motions, therefore, are subject to the same law, viz. that their power or intensity is not only directed in straight lines from the central body, but their intensity is regulated exactly by the same law of inverse squares. If the repelling motion be doubled, then the

attractive motion or power would be doubled also; if the repelling motion be quadrupled or halved, then the attractive force of gravity would be quadrupled or halved in the same way, the two forces being exactly increased or decreased in the same ratio according to the law of inverse squares.

ART. 76. *Velocity of Light*.—The transmission of light is not instantaneous, as it requires time for its propagation through space, from the luminous body which gives rise to all light, as the sun for example, until it reaches the body which it lights up. The velocity of the light waves, however, is so great, that it is almost impossible to give any comparative idea of their rate of transmission. The velocity of the light waves was first established by Roemer, a Danish astronomer, in 1675. He ascertained the velocity of light by observations made on the satellites of Jupiter. His methods of reasoning can easily be understood by reference to the following diagram.

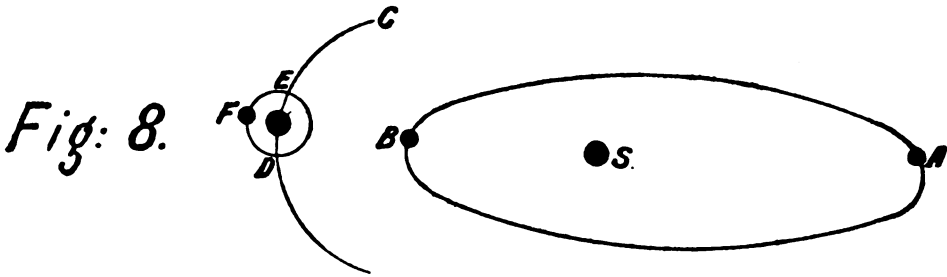

Let S represent the sun, and A and B the orbit of the earth round the sun; $C E D$ part of Jupiter's orbit round the sun; while $D E F$ represents the orbit of Jupiter's satellite. When the earth, Jupiter, and the satellite are in a straight line with each other, the satellite suffers an eclipse through passing into the shadow thrown by Jupiter. Now Roemer found that there was a difference in the time of the eclipse when the earth was at B , that is, when it was nearest to Jupiter, and when it was at A , which is that part of the earth's orbit furthest away from Jupiter. That difference was accounted for by the fact, that when the earth was at A the light had to travel further from Jupiter than when the earth was nearest to Jupiter, that is at point B . Thus, when the earth was nearest to Jupiter, the light had a shorter journey to travel than when it was furthest from Jupiter. The difference, he found, was about 16 minutes, and he reasoned that this difference was caused by the light having to cross the earth's orbit from B to A , in its longer journey, than when it only had to reach the earth at B . The

mean distance of the earth from the sun, that is, the radius of the earth's orbit, is about $92\frac{1}{2}$ million miles, so that the diameter of the earth's orbit is about 185,000,000 miles, and if it takes about 16 minutes for light to traverse this distance, we find that light has a velocity, according to Roemer, of 192,500 miles per second. The result, however, arrived at by Roemer was not generally accepted at that time, and it was not till 1728 that Bradley discovered what is known as the Aberration of Light, and from that discovery proved that light was not transmitted instantaneously through space, but that it was transmitted with finite velocity; and that that velocity corresponded fairly well with the velocity given by Roemer. Bradley, in his astronomical observations, noticed that some of the fixed stars, so called, did not appear to be really fixed, but that they described small circles in the heavens each year. This fact greatly perplexed him, until at last he hit upon the true solution by taking into account the motion of the earth in its orbit, together with the fact that light had a finite velocity. This result showed that the light from the stars travelled with the same velocity as that which travelled from Jupiter's satellites. The Aberration of Light, as his discovery was termed, may be illustrated in the following way—Suppose that you are standing still, and that it is raining, the rain descending vertically on the umbrella that you hold up to cover you. As soon as you begin to walk, the rain-drops will apparently begin to slant, and if the walk is changed into a run, the greater apparently will be the slanting direction that the rain-drops take. In the same way, the rays of light from a star would fall vertically upon the earth if it were motionless, but as the earth is moving through space with varying velocity, it gives to the rays of light a slanting direction. By calculating the speed of the earth, and ascertaining the exact slanting direction of the rays, the velocity of light may be ascertained. This Bradley did, and showed that it coincided almost with the result arrived at by Roemer. Various other means have been adapted to test the results arrived at by these two astronomers. Fizeau, in 1849, was able to measure the velocity of light by using, not planetary or stellar distances, but by simply using distances in the city of Paris; while Foucault, in 1860, devised a method of measuring the velocity of light in air or any other medium. The results arrived at by these men leave no doubt as to the exact speed of light, which may now be reckoned to have a velocity of 186,000 miles, or 300,000,000 metres per second. Notwithstanding this great speed at which light travels, the nearest stars are so far off that their light takes about $3\frac{1}{2}$ years to reach the earth, while scientists tell us that some of the most distant stars are so remote, that their

light takes thousands of years to reach our earth, travelling at the rate of 186,000 miles per second. From considerations like these we get a dim conception of the almost illimitable extent of the universe. Now let us try to understand what this rate of motion really means. We have to remember that light is caused by wave motions in the Aether, so that we have here a wave motion which is travelling through the Aether at the enormous rate already quoted. Light takes about $8\frac{1}{2}$ minutes to travel from the sun to the earth, a distance of 92,000,000 miles. Our fastest trains do not travel 80 miles an hour, and if a train left the sun and continued its journey through space at that rate, it would take over 130 years before it reached our earth, while the light would perform the journey in $8\frac{1}{2}$ minutes. We have some idea of the velocity of a train travelling at 80 miles an hour; what, however, must be the velocity of a wave motion which travels 22,500 times as fast? In Art. 56 we have seen that all energy is the energy of motion, and therefore wherever we get motion of any kind or sort, there we must have energy accompanying it, or the power to do work. We have here, then, a source of energy in the aetherial waves known as light waves, with their enormous velocity which is almost inconceivable and illimitable. What must be the energy which exists in space due to the wave motion of the Aether? We have to remember on this point that we are no longer dealing with a frictionless medium, but that we are dealing with matter, only in a far more rarefied and far more elastic form than ordinary matter, but nevertheless matter just as air is considered matter, and, being matter, its very motion imparts to the light waves a power and a force which make them capable of doing work. The kind of work done will be considered later on, when we deal with the dynamical value of light. That we do not feel the power and energy of the light waves is due to the well-known fact that their power is broken by the activity of the atmospheric particles, each of which, in their myriads, is ever moving with great velocity, and therefore bombard the light waves, as they endeavour to strike the earth. Thus the aetherial light waves are broken up and shattered, and fall to the earth not with their full energy or power, but in a blended form, or with that reflected energy which we call light. If they were to come unbroken and unchecked upon us, and on the earth, in the same way that they apparently do upon our satellite the moon, we doubtless should experience very different effects of their energy and power due to their enormous velocity.

ART. 77. *Dynamical Value of Light.*—We have already learned (Art. 68) that heat possesses a dynamical value, such value being measured by Joule, and its equivalent in foot-pounds

being exactly ascertained. We have further seen (Art. 69, on the identity of light and heat), that the same aetherial waves which produce heat are also concerned in the production of light. If, therefore, the aetherial waves which give rise to heat possess a dynamical action and equivalent, it follows that light must also possess a dynamical action and equivalent, and such action should be capable of being expressed in terms of foot-pounds. Clerk Maxwell has recorded the exact dynamical equivalent of light. On this matter he writes:¹ "If in strong sunlight the energy of light which falls upon a square foot is 83·4 foot-pounds per second, the mean energy of one cubic foot of sunlight is about 0,000,000,882 of a foot-pound, and the mean pressure on a square foot is 0,000,000,882 of a pound weight." We have here then the exact dynamical equivalent, according to Maxwell, of a cubic foot of sunlight near the earth's surface, and of the pressure exerted by light on a body with which it comes into contact.

Again, Lord Kelvin² has measured the exact dynamical equivalent of a cubic mile of sunlight, both near the surface of the sun and then near the surface of the earth, and in a note adds that the relation of the two values is as 46,000 to 1. So that if the dynamical value of a cubic mile of sunlight near the earth's surface be represented by unity, then the value of a cubic mile of sunlight near the sun's surface would be 46,000 times greater, while he further adds that it would take 4140 horse-power every minute, as the amount of work required to generate the energy existing in a cubic kilometre of light near the sun, a kilometre being equal to about 1093 yards.

Professor Challis³ stated in 1872 that "Light is to be ranked with the physical forces, and its dynamical action is equally to be ascribed to the pressure of the Aether." Now I want to put this question to the reader: If light possesses this dynamical action, that is, if it possesses a motive or driving power, what must be the exact effect of the dynamical action of the light waves from the sun upon all the planets and meteors that revolve round it? We know that the sun is 324,000 times the mass of our earth, and that it has a diameter of about 856,000 miles and a circumference of over two million and a half miles. What, therefore, must be the energy of the aetherial light waves that it speeds on their way through space on every side? Stokes,⁴ in regard to the mechanical energy of Light, states that "the amount of energy poured forth into space corresponds in round numbers to 12,000 horse-power per square

¹ *Magnetism and Electricity.*

² *Ibid.*, 1872.

³ *Phil. Mag.*, 1902.

⁴ *Burnet Lectures.*

foot," and that every square foot of the sun's surface supplies energy at the above rate. The number of feet in the sun's surface can be approximately determined. Roughly, there are 2,284,000,000 square miles of surface on the sun's huge form, and there are 27,878,400 square feet in a mile. By multiplying these two numbers we can ascertain the exact number of square feet on the surface of the sun. If, therefore, every square foot possesses a mechanical value equal to 12,000 horse-power, what must be the mechanical equivalent of the sun's radiation of light that it pours forth into space?

I want to call the attention of the reader to another fact, and that is, that light always proceeds in straight lines from the sun (Art. 76), and therefore if there be any mechanical action in light at all, that action must be one which is always directed from the sun in straight lines. Now experience universally teaches us, that if a body is pushed, and pushed with such a force as has been indicated, then that body not only moves, but moves in the direction that the supposed horses would push. I have already shown (Art. 76) that the path of light is that of a straight line corresponding to the path of the attractive force of gravity; therefore these horses must ever push in a direction *from* the sun along the same path that the sun's attractive power takes. In other words, the mechanical action of these supposed horses will be a repulsive one, that repulsion being due to the dynamical action of the light waves upon the body that they come into contact with. If this is correct, then not only is heat a repulsive motion, as stated in Art. 63, but light is equally the possessor of a repulsive motion, because its action is ever directed from the sun. We might continue to follow the supposed horses as they continued their course through space, and we should find that their energy decreased inversely as the square of the distance, partly because the further they proceeded into space the larger the area would be they would have to cover, and therefore their energy would be decreased proportionately.

Professor Stokes, in the same work¹ already referred to, in continuation of the same idea, states: "At the distance of the earth the energy received would correspond to about one horse-power for every square of 5 feet, on that side of the earth's surface facing the sun, supposing the rays to fall perpendicularly." That being so, we can exactly calculate in horse-power the energy received from light on that side of the earth facing the sun, at its distance of 92,000,000 miles. The area of the earth's surface is, roughly, 200,000,000 × 5280 square feet, and if the energy received is equal to one horse-power for

¹ *Burnet Lectures.*

every 5 square feet, then the amount of energy received by the earth on that side facing the sun would be equal to $\frac{200,000,000 \times 5280 \times 1}{2 \times 5}$ horse-power. This power, it must be

remembered, is ever directed *away from* the sun, and upon that side of the planet that faces the solar orb. So that we have virtually a repulsive force ever directed against the earth, estimated by Professor Stokes to be equal to the estimated horse-power.

This assumption of the repulsive power of light brings the phenomena of light into harmony with that of heat, because we have already seen (Art. 63) that heat is essentially a repulsive motion, as indicated by Davy, Rumford and others; and, as heat and light both have a common origin, then light should possess a repulsive power also.

As further proof of this statement, let me again quote from Clerk Maxwell. In the quotation already given in this Art. we have seen that the pressure of sunlight on a square foot is equal to 83 $\frac{1}{4}$ lb. He adds the following words to those already quoted: "A flat body exposed to sunlight would experience this pressure on its illuminated side only, and would therefore be repelled from the side on which the light falls."

Now if more conclusive proof of the correctness of the argument I am advancing were required, I do not think it could be given from any greater authority than that just quoted. Coming from the pen of one of the most brilliant scientists that the past century has known, I venture to think the opinion will be received with that due weight which it demands.

This statement of Clerk Maxwell's has received, however, definite and experimental proof from Professor Lebedew of Moscow University, and by Nichols and Hull of America. The former has given, in the *Annalen der Physik* for November 1901, the results of his experiments in relation to the pressure of light. The following are the results: He proved, 1st, that the incident beam of light exerts pressure both upon an absorbing and a reflecting body; 2nd, that the pressure of light is proportionate to the amount of incident energy, and is independent of the colour of light; 3rd, that the pressure of light corresponds with the forces of radiation as calculated by Maxwell.

About the same time, Nichols and Hull of America were engaged upon experiments relating to the pressure of light waves, and their results were published in the November *Physical Review*, 1901. Thus, from two separate and independent sources, Maxwell's equations as to the pressure which light waves exert upon any body on which they fall received definite experimental confirmation.

The repulsive power of the light waves receives further confirmation from that theory known as the electro-magnetic theory, which supposes light to be nothing more or less than an electro-magnetic phenomenon; that is to say, it is directly or indirectly due to the action of electric currents.

As already indicated, Lorentz was of the opinion that the light waves were themselves electric currents, and whether this is the actual fact or not, certainly it is true that the electro-magnetic theory of light is no mere fable or myth, but that it ranks as one of the most advanced and correct hypotheses in regard to light that has ever been given to the world. According to that theory, which we shall look at subsequently, we find that the aetherial medium is not only the medium for the light waves, but that it is also the medium which conveys and carries the electric currents through space, and even through all matter. Further, from that theory we shall have good reasons for assuming that the aetherial light waves are either themselves electric currents, or closely identified with them, in the same way that the light waves are identified with heat waves. If these facts should be found to hold good relative to the identity of aetherial light waves and the aetherial electric waves, then it can very readily be seen that such a hypothesis gives added weight to the repulsive power of light. One of the very commonest facts regarding electricity and its currents is, that wherever we get electricity, we not only get attraction, but there is always associated with that attractive force a repulsive force, which is equal in amount to the attractive force. So that if, wherever we get electric currents, we find associated with those currents a repulsive force, then, in view of the electro-magnetic theory of light, it should also follow that on that hypothesis we ought also to find a repulsive power in light. From the dynamical aspect of light on the bases of facts given to the world by such men as Professor Stokes, Clerk Maxwell, Lord Kelvin, and Professor Lebedew, we are compelled, therefore, to come to the conclusion that light does possess such a repulsive force, such force being due to the dynamical action of the aetherial light waves.

Thus we learn from the dynamical action of light, that not only is the sun the centre of an attractive force, but that it is equally the centre of a repellent or repulsive power or motion; which repulsive power always follows the path of the radius vector, and diminishes with an intensity which is inversely as the square of the distance. What we have to ask ourselves therefore is, whether the repulsive power of light is the Centrifugal Force that we are trying to discover? In Art. 24 we found out what were the necessary characteristics of the Centrifugal

Force, which is to form the companion law to the attractive law of gravity, or the Centripetal Force. We there saw that this centrifugal law must be universal in character; that it must coincide with the path of the centripetal force; that it must also be subject to the same law of intensity, viz. the law of inverse squares; and further, that the force must be proportional to the product of the two masses concerned. We find in the repulsive power of light three at any rate of these conditions fulfilled. Light is universal because Aether is universal. It is always subject to the law of inverse squares, and what is more, its repelling power coincides exactly with the path which the centripetal force takes, that is, the radius vector. We have not, however, discovered that light fulfils the remaining necessary condition, which is, that the repelling powers of light emitted by any two bodies are equal to the product of their masses. So that until this is done, it cannot be said that the aetherial light waves form the centrifugal force or motion from a central body that we are seeking for. But while that may be true, yet if light be not the centrifugal motion, it certainly indicates in what direction we are to look for that force, and that is to the Aether, whose periodic waves give rise to the phenomena of light. For, after all, light is due to aetherial wave motion, and, therefore, while light from certain standpoints may be conceived to be the cause of other phenomena, yet primarily the real cause of all phenomena which are due to light are due to the aetherial waves which themselves give rise to the phenomena of light. Thus light acts as a guide-post to us, pointing out the direction we should take in order to find out the real centrifugal force or motion, and as plainly as it possibly can, it indicates to us that the true solution of our centrifugal motion that we are seeking for is to be found, and alone found, in that universal aetherial medium which, by its vibrations and wave motions, gives rise to that which we term Light. In conclusion of this point, it may be pointed out that Professor Challis¹ also took this view of light, as he distinctly states that "Light is to be ranked with the physical forces, and its dynamical action is equally to be ascribed to the pressure of the Aether," and then proceeded to show how repulsion could be exerted on atoms by the periodic wave motion of the Aether.

ART. 78. *The Electro-Magnetic Theory of Light.*—We have seen (Art. 71) that light is due to a periodic wave motion of the Aether, and we have previously seen that heat is also due to a periodic wave motion of the Aether. Thus in the phenomena of light and heat, Aether is the medium in which the energy of

¹ *Phil. Mag.*, 1872.

light is stored, and by which it is transmitted in its passage from a luminous body, as the sun, until it comes into contact with a planet or satellite from which it is reflected, thus giving rise to light and heat. When, however, we come to deal with electro-magnetic phenomena, which are the results and effects produced by electricity and magnetism, we find certain phenomena similar to those that we find in relation to light and heat. Thus, when light is emitted by a luminous body, a certain amount of energy is given out by that body, and if such light is absorbed by another body, the latter becomes heated, a clear proof that it has received energy or motion from some outside source. From the time it left the luminous body till it reached the lighted or absorbing body, it must have existed as energy, that is, motion in the Aether. As we have already seen, Newton thought that the transference of energy was accomplished by the actual transference of certain small corpuscles or atoms given out by the luminous body, which conveyed the energy of the one body to the other. According to the wave theory of light, however, we find that the transference of energy is accomplished by a wave motion in the Aether, which is periodic both in time and space, by which wave motion the energy is transferred from the luminous to the illuminated body. Now every one is familiar with the effects of magnetism and electricity in some form or other, and such familiarity teaches that various kinds of work may be done by electricity. If an electric current be generated and allowed to flow through any circuit, as the ramifications, for example, of an electric-tram system, it can readily be seen that by the action of the current large masses or bodies as trams may be moved. To generate the current requires the expenditure of energy, and for the tram to be moved requires the transmission of that energy from the generating station till it reaches the body to be moved. By what means is such energy transmitted? because if it disappears at one place and reappears at another, it must have passed through a medium during the interval. It has been demonstrated that the medium which conveys the current from place to place is the Aether, so that as light is transmitted through space by the Aether, in a similar manner electric currents are transmitted through space also by the same medium. The discoverer of this great truth was Clerk Maxwell, and it was from the consideration of electro-magnetic phenomena that he was able to lay the foundation of that theory known as the Electro-Magnetic Theory of Light. In paragraph 781 of his greatest work¹ he says: "In several parts of this treatise an attempt has been made to explain electro-magnetic

¹ *Mag. and Elec.*

phenomena by means of mechanical action from one body to another by means of a medium occupying space between them. The undulatory theory of light also assumes the existence of a medium. We have now to show that the properties of the electro-magnetic medium are identical with those of the luminiferous medium." He then points out that, "to fill all space with a new medium, whenever any new phenomenon is to be explained, is by no means philosophical"; and further adds, that "If it should be found that the velocity of propagation of electro-magnetic disturbances is the same as the velocity of light, and this not only in air, but in other transparent media, we shall have strong reasons for believing that light is an electro-magnetic phenomena." In the wave theory of light we have seen (Art. 70), that two properties are necessary to any medium before it is capable of transmitting wave motion of any kind. Those two properties are elasticity and inertia. Water possesses these properties, and so can transmit ocean waves; air also possesses these properties, and so can transmit sound waves; and Aether, being matter, also possesses these properties (Arts. 47 and 48), and is therefore capable of transmitting light waves. The elasticity is essential in order for the medium to store up energy, and also to enable it to resume its original shape after deformation, while the inertia is necessary in order that the medium may transmit the impulse, and oscillate to and fro until the impulse received has been passed on. This elasticity and inertia may be well illustrated by the bending of a lath or cane. If we pull one end down, holding the other end quite still, we shall see that the lath oscillates to and fro until gradually it comes to rest. The elasticity of the lath allows it to be pulled out of its original position, and also enables it to rebound, while its inertia causes it to swing back again past its original position. Both combined together cause it to swing backwards and forwards till its energy is used up. If such a series of springs could be set in motion at equal intervals of space and time, we should then have a good illustration of a wave motion.

What analogy, may be asked, is there in electro-magnetic phenomena to correspond to this elasticity and inertia of the Aether, so essential to the propagation of light? Let us look at the familiar illustration of charging a Leyden jar. In charging a Leyden jar with electricity a certain amount of energy is spent, work is done, and the result is found in the electrified state of the jar. That which has actually been accomplished is the storing up of energy in the Aether around the jar. This storing up of energy is analogous to pulling aside the lath, and is the making use of the elasticity of the Aether, in order to produce a tendency to recoil. When the jar is discharged, which is analogous

to letting go the lath, the Aether seeks to recover its former condition by discharging the energy it received. In these operations the elasticity of the Aether is called into play. After the jar is discharged, however, the recoil of the Aether produces a current, and the inertia of the current causes it to overshoot its original position, and for an instant the charge of the jar is reversed. The current now flows backwards in the same way that the lath returned back, and charges the jar as at first. This discharging and recharging continue backward and forward, so to speak, until all the energy which was originally given to the jar has been expended, and it resumes its normal condition. In this experiment the elasticity and inertia of the Aether have both been called into play, so that we see in this electrical experiment a similar illustration of the elasticity and inertia of the Aether, as manifested in the undulatory or wave theory of light. The question now arises, what are the corresponding properties as given by Maxwell in his electro-magnetic theory? In Art. 782 he writes: "In the theory of electricity and magnetism adopted in this treatise two forms of energy are recognized—the electro-static and the electro-kinetic—and these are supposed to have their seat, not merely in the electrified or magnetized bodies, but in every part of the surrounding space where electric or magnetic force is observed to act. Hence our theory agrees with the undulatory theory in assuming the existence of a medium which is capable of becoming a receptacle of two forms of energy." Faraday, in his *Experimental Researches*, paragraph 3075, in referring to the character of magnetic phenomena external to the magnet, writes: "I am more inclined to the notion that in the transmission of force there is such an action external to the magnet, than that the effects are merely attraction and repulsion at a distance. Such a function may be a function of the Aether if it should have other uses than simply the conveyance of radiations" (light and heat). From this extract we learn that Faraday was also of the opinion that the Aether around a magnet or any electrified body was directly concerned in the propagation of the electric and magnetic forces, these forces according to Maxwell being of two kinds. From the illustration of the charging and discharging of the Leyden jar, we learn that aetherial electrical waves can be produced by electric means, and from the alternate charging and recharging of the jar we learn that these aetherial waves travel to and from the jar with a periodic wave motion. Here, therefore, we have an aetherial wave motion which is produced wholly by electricity, and yet which answers our definition of a wave motion of light, in that it is periodic both in time and space, and in that aetherial wave motion Maxwell states that two forms of energy are called into

play, which he calls Electro-Static and Electro-Kinetic. These correspond respectively to the elasticity and inertia in the older theory of the wave motion of light. It was upon this basis that Maxwell built up his electro-magnetic theory. Even this theory does not tell us what is the exact character or nature of the periodic wave motion of the Aether. All it tells us is, that the electro-magnetic wave motion of the Aether is the same in nature and character as the wave motion which produces light and heat. Thus it shows that light and electricity have a common origin, and proves that light is nothing more or less than an electro-magnetic phenomenon. Maxwell gave a number of proofs in support of his theory. He showed that the velocity of the electro-magnetic waves was almost identical with the velocity of light waves, his results being as follows—

VELOCITY OF ELECTRO-MAGNETIC WAVES.		VELOCITY OF LIGHT IN METRES PER SEC.	
Weber	. 310,740,000 metres per sec.	Fizeau	. 314,000,000
Maxwell	. 288,000,000 " "	Foucault	. 298,360,000
Thompson	. 282,000,000 " "		

From these figures it can readily be seen that the velocity of an aetherial wave, generated by electric means, is approximately the same as an aetherial wave generated by a luminous body. Thus one of the most important results of Maxwell's theory was to show that electro-magnetic disturbances produced in the Aether by an electrified or magnetic body might be propagated through space with a velocity equal to that of light.

It was left, however, for Professor Hertz to place the electro-magnetic theory of light upon a sure and certain foundation. The results are to be found in his work on *Electric Waves*, translated by Professor Jones, 1893.

In his paper on "The Velocity of Propagation of Electro-dynamic Action," he gave definite and experimental proof of the hitherto theoretical fact that the velocity of the electric waves in air was exactly the same as that of light, whereas he found that in wires the ratio was not the same, being 4 to 7. This was afterwards found out to be an error by some experiments made at Geneva, when it was discovered that the propagation in wires was the same as in the air. Among his experiments Hertz succeeded in producing very short electric waves of 30 centimetres in length, that is, about one and one-fifth of an inch. According to Maxwell's theory, such a wave ought to behave exactly as a beam of ordinary light does. Hertz proved that this was the case, and published his proofs in his paper on "Electric Radiation." In that paper he showed how such electric radiation was propagated in straight lines, like light, and

that it could also be refracted and reflected. Thus he gave to Maxwell's electro-magnetic theory experimental demonstration, and placed it on a solid and immovable foundation. In summing up the results of this theory, we learn, therefore, that Hertz has conclusively proved that electric and magnetic effects are propagated through the Aether which fills all space with the same velocity that light is propagated. Further, he has conclusively proved the identity between light and electricity, and shown that electric and light radiations are essentially one and the same, and that they are both propagated by periodic wave motions of the Aether. Further, he has proved that the velocity of the propagation of light is the same as that of the electro-magnetic waves, and that these waves obey all the laws that govern light and heat. We have here, therefore, experimental proof of the identity between electricity and light, and in Art. 69 we have also proved the identity of light and heat, so that we have now experimental proof that light, heat and electricity are all due to the periodic wave motions and vibrations of the universal Aether, which not only fills all space, but which surrounds every atom and every particle of matter throughout the whole universe. Having established, therefore, the identity of heat, light and electricity, and having proved that they are all due to the periodic wave motions or vibrations of the universal Aether, it must follow as a matter of necessity that wherever in interplanetary or interstellar space we find light or heat waves we must also find electricity. We have already seen that aetherial light waves flood all space, both interplanetary and interstellar space, so that in view of the identity of the aetherial light waves and aetherial electric waves, it follows that the aetherial electric waves flood all space in the same way, and at the same time. Wherever, therefore, we find the light waves, there we find the electric waves also ; and it will be impossible to find the one without the other. Thus, throughout all space, and indeed throughout the universe, light waves will not be found apart from electric waves. They are as incapable of being dissociated as are light and heat waves. Now we have already seen (Art. 64), so far as the solar system is concerned, that the sun is the generator of all light and heat, and that these light waves speed from the sun on every side with a velocity of 186,000 miles per second. From the identity of light and electric waves, therefore, given to us by the electro-magnetic theory of light, it must follow that the sun is equally the source and generator of the electric waves. Not only so, but as the light waves flood all solar space, these electric waves, being identical with the light waves, must flood the solar system also. Thus we learn from Maxwell's theory as developed by Hertz, that not

only is the sun the generator of light and heat waves which are poured forth into space continually with a velocity almost inconceivable, but at the same time the sun is pouring forth into space electric waves which travel outwards in spherical shells in the same way as light waves do, and with a similar intensity, as we shall see in the next chapter. Now let me ask the reader to ponder over the fact given to us by this electro-magnetic theory in its relation to the solar system, and endeavour to find out what such an application teaches us. Let it be remembered that we are looking for a Centrifugal force or motion, that is, a motion from a centre, which is to be the exact counterpart of the Centripetal force, *i. e.* motion to a centre; and further, that the Centrifugal motion must be a repulsive motion acting in the opposite way to the attractive power of the Centripetal force, that is, the attractive power of gravity. We have seen (Art. 77) that light possesses a repulsive power. We have now only to prove that electricity or the aetherial electric waves have a repulsive motion, which will be the easiest of all to prove, and then we shall have proved beyond the possibility of contradiction, the existence of that repulsive force referred to by Herschel in Art. 24, which is to form the complementary and counterpart of the attractive power of gravity. If it can be proved that electricity does possess such a power, that is, a repulsive power, ever acting from a centre, then in view of the identity of light, heat and electricity, the correctness of the views we have advanced as to the repulsive power of light and heat will be proved beyond the shadow of a doubt, otherwise Maxwell's electro-magnetic theory of light is a fable and a myth, and Hertz' experiments were never performed. Further, if all electro-magnetic phenomena are due to the same aetherial medium which gives rise by its wave motions to light, heat and electricity, then we shall have discovered a medium which throughout the universe can by its wave motions transmit and propagate both repulsions and attractions, that is, the aetherial medium which is to be the physical cause of Universal Gravitation. In order to further develop and establish this point we will now consider the subject of Electricity as a Mode of Motion.

CHAPTER VIII

AETHER AND ELECTRICITY

ART. 79. *Electricity, a Mode of Motion.*—The question as to What is Electricity? is one of the greatest problems of modern times. In view of the electro-magnetic theory of light, however, science is able to give a better definition as to what electricity is, than it was able to do previous to the introduction of the theory by Maxwell, and its practical establishment by Hertz.

If that theory teaches us anything at all with regard to the nature of electricity, it teaches us that electricity is due to certain motions of the universal Aether, that not only fills all so-called Space, but surrounds all particles and atoms of all Matter.

The question has been asked by various scientists, "Is Aether Electricity, or, in other words, are Aether and Electricity one and the same?" Let us look at the question from the standpoint of the analogy from the phenomena of light and heat. As we have already seen (Art. 61), heat is due to a particular kind of motion of the universal Aether, generally known as vibratory motion, which motion is communicated to the Aether by a luminous or heated body.

So that we learn that heat at any rate has an aetherial basis, as it is a particular kind of aetherial motion. From Art. 70 we learn also that light is due to an undulatory or wave motion in the Aether; the waves, however, in this case being shorter, and of more rapid vibration than those waves which give rise to heat.

Thus light and heat both have an aetherial basis, being due to vibrations of that medium. From these analogies, therefore, we come to the conclusion that electricity and magnetism have an aetherial basis, and are also due to certain kinds of motion in the Aether.

That motion may be rotatory motion or vibratory motion, as the case may be, but whatever definition we give of electricity, we cannot as yet say definitely that Aether is electricity.

We may assume, and indeed prove, that Aether has an electrical and magnetic basis, in the same way that it has a thermal or heat basis, or a luminiferous or light basis; but while

we admit such a hypothesis, we cannot admit as yet that Aether and electricity are one and the same thing. It is not within the province of this work, however, to prove what electricity is, or show the relation of Aether to all the various forms of electricity with which we are conversant, but I think I may venture to make this statement, that all forms of electricity, whether it is electrostatic, that is electricity at rest, or current electricity, or electro-magnetism, are due to certain forms of motion of the universal Aether, in the same way that light and heat are also particular forms of motion of the same medium. I need hardly point out that it is an absolute impossibility for me to deal with such a subject as Electricity in all its details and various aspects in one chapter; so that I shall have to assume that the reader is familiar with some of the elementary truths of the subject.

At the same time, I will endeavour to make clear most of the technical terms used as we proceed. From the Electro-Magnetic theory of light, therefore, we learn that Aether has an electrical or electro-magnetic basis, so that, wherever we get Aether, there we have the bases and conditions which will produce all the phenomena with which we are conversant in the sphere of electricity. Given the required motions in the Aether necessary to produce any particular form of electricity, then that form is produced as soon as the motions of the Aether are generated by any charged or electrified body. Produce a circular current in any way in the Aether, and you will have a circular current of electricity; produce radiations from a radiating body, and you will get electric radiations which speed away with the velocity of light.

This phase of the Aether is entirely in harmony with Dr. Larmor's Hypothesis of Electrons, which has already been referred to in Art. 44. Dr. Larmor in his work indicates that electricity has an atomic basis, and further states that "the atomicity of electricity is coming within the scope of direct experiment."¹

Now, if electricity, as I have indicated, be due to certain motions in the Aether, then it can easily be seen that postulating atomicity for electricity will be the same as postulating atomicity for the Aether. Dr. Larmor² definitely and clearly states, "that each electron has an effective mass of aetherial origin, which forms part, and may be the whole, of the mass of matter to which it is attached;" and again points out (p. 64) that "an electron is nothing more than a point singularity or pole in the electro-dynamic and optical Aether." Thus we see that Dr. Larmor's hypothesis as to the atomicity of electricity is a further proof

¹ *Aether and Matter*, p. 8.

² *Ibid.*, p. 64.

of the atomicity of Aether, and is also in harmony with the electro-magnetic theory of light.

Now in dealing with electricity as a mode of motion, it will be necessary to show that electricity is also a form of energy in the same way that heat and light are forms of energy.

If it can be demonstrated that electricity is a form of energy, then it can easily be demonstrated that work can be done by it, and that that work may take a mechanical form in the same way that the energy of heat and light may produce mechanical results. Clerk Maxwell has given us, in his greatest work, his conception of the two kinds of energy due to electricity and magnetism. On the subject he writes: "In the theory of Electricity and Magnetism accepted in this treatise, two forms of energy are recognized, the Electro-Static and Electro-Kinetic (paragraphs 630 and 636), and these are supposed to have their seat not merely in electrified or magnetized bodies, but in every part of surrounding space, wherever electric or magnetic force is observed to act. Hence our theory agrees with the undulatory theory of light in assuming the existence of a medium which is capable of becoming susceptible to two forms of energy."¹ The question has arisen many times as to what is meant by the terms Electro-Static and Electro-Kinetic energy used by Maxwell, and various hypotheses have been advanced to explain the same.

Electro-static energy is said to be that phase of electricity in which we deal with stresses set up in the Aether by an electrified body at rest, whether that body be small or large. It further deals with the process of induction, that is, the action of an electrified body upon another body, such action taking place through the medium between the two bodies. Electro-kinetic energy is the energy due to electricity in motion. On this point Maxwell says: "A conducting circuit in which the current has been set up has the power of doing work in virtue of the current, for it is really and truly energy. It appears, therefore, that a system containing an electric current is a seat of energy of some kind; and, since we can form no conception of electric current except as a kinetic phenomenon, its energy must be kinetic energy, that is to say, the energy which a moving body has in virtue of its motion." (Arts. 551 and 552.)

It is not our purpose to deal with the electro-kinetic form of energy referred to by Maxwell in this chapter. We shall deal with that form of energy due to electricity in the succeeding chapter. We will consider first the effect of the electro-static energy in relation to electrified bodies, but I wish it to be distinctly understood, that in all the different kinds of electric

¹ *Magnetism and Electricity*, by C. Maxwell, Art. 782.

phenomena manifested, the Aether plays the chief part, and without it, none of the phenomena observed could be produced ; because, what Aether is to light and heat, so it is to electricity, being that medium which by its motions propagates and gives rise to all electrical phenomena.

This being so, we have now to apply some of the facts taught us by electricity, and especially by the electro-magnetic theory of light, to our solar system, with the hope that we shall find further evidence of a Centrifugal Force which is physical in character, and whose action can be traced throughout the whole realm of space. Let us, in starting to apply some of the truths already learned, recall some of the facts concerning light, its production and its propagation. We recall the fact that light is produced by the action of the sun upon the Aether, giving rise to waves which speed away from the generating source with a velocity of 186,000 miles per second. We further remember that Hertz has definitely proved that these light waves are identical with electro-magnetic waves, as they ought to be if the Aether possesses an electrical basis, as Dr. Larmor and Professor Lodge suggest.

In order that there may be no mistake on this point, let me quote from one of Hertz' papers, where, in his conclusion, he says : "The experiments described appear to me, at any rate, eminently adapted to remove any doubt of the identity of light, radiant heat, and electro-magnetic wave motion." Now, what I want to point out regarding this fact is this. If the sun gives rise to the aetherial light waves, and these light waves are identical with electro-magnetic waves as proved by Hertz, then the sun must either be an electrified body or else a magnet.

It must be one or the other, because, if it were not, we should then have an anomaly in Nature of a body emitting electro-magnetic waves which is itself neither electrified nor a magnet. Therefore, according to our second Rule of Philosophy, such a body would be incapable of giving rise to these waves, as such a result would be contrary to universal experience and experiment.

We know that the earth is a magnet, but up to the present it has never been proved that the sun is a magnet, although, as I shall show later on, Lord Kelvin and others have suggested such a possibility. If we assume that the sun is a magnet, our grounds for assumption would not be so strong at this point, and our reasons so philosophical, as they are if we assume that the sun is an electrified body.

We have philosophical reasoning to prove that the sun is an electrified body in the fact that it emits or gives rise to electro-magnetic waves in the Aether, and no other hypothesis can be

made other than that the sun is an electrified body, in order to prove the connection between the two.

Thus we affirm that the sun is an electrified body, which like any other electrified body is capable of generating electric waves, and speeding them through the Aether with similar velocity to that of light. Not only so, but, like any other electrified body, it must have its electric field and possess the ability to electrify any other body by induction, that may happen to be in its electric field, as we shall see later on.

Further, being an electrified body, the electric density will be greatest near the sun's surface, and this fact fully accords with our statement in Art. 45, that Aether is gravitative. As pointed out in that Art., if Aether be gravitative, it must be densest nearest to the attracting body; and, as Aether has an electric basis, then with the denser Aether there must be an increased electric density, which can only happen provided the sun is an electrified body.

Sir G. Stokes was also of this opinion, for in his Burnet Lectures on Light he writes (p. 212): "There is nothing, therefore, unreasonable in supposing that the sun may be a permanently charged body."

So that all the reasoning that has led to this result seems to harmonize and confirm each several hypothesis which has been advanced. There can be little doubt, therefore, that the sun is an electrified body, and it is for us now to carry out this fact to its logical and philosophical conclusion, by applying all the truths which circle round it to the solar system, when we shall find greater confirmation of the statement just advanced than any we have yet adduced.

No } According to Professor Young of America, the sun is not only an electrified body, but is also the abode of living and sentient beings. This astronomer has suggested that the sun is the centre of electric force, and that converging streams of Electricity are ever flowing to it as a centre; but on meeting with the atmosphere they give rise to brilliant discharges, which thus gives the appearance of a solid incandescent body.

Now, whether this hypothesis is correct or not, it is absolutely certain that the sun is an electrified body, as it gives rise to electro-magnetic waves in the Aether, as philosophically proved by direct experiments.

ART. 80. *Aether and Electric Fields*.—Before proceeding to apply some of the facts of Electricity to the solar system, let us find out what is meant by an Electric Field. An electric field is to an electrified body, what a thermal or heat field is to a heated body, or a luminous or lighted field is to a luminous body. If a lamp, for example, be lighted, its light waves spread out on

every side, and extend for a considerable distance unless impeded by such obstacles as the wall of a room.

The extent to which the light waves reach and flow might well be called the lighted or luminous field, and in that field the effect of the aetherial light waves would be manifested and seen.

Now, in a similar manner, when any body is electrified, the electric waves spread out on every side of the electrified body, and the extent to which the waves spread out form what is known as an electric field.

So that an electric field may be defined as any region or space in which electric energy is manifested by means of the aetherial electric waves, and across which induction may take place.

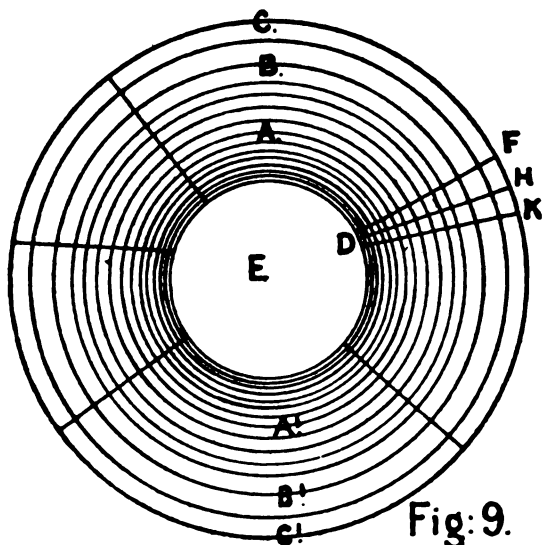

Fig: 9.

Thus, for example, let E be an electrified body (Fig. 9), then it will generate electric waves which will speed from the body with a velocity equal to that of light. If the body be a sphere, then the waves will be spherical in shape, and will proceed from the generating source in the shape of concentric spheres as indicated in the figure. Before proceeding any further, it is necessary that we should look at the electric field from the physical aspect, with a view to discover something of what takes place therein. As has already been indicated, all electric phenomena are due to motions of the universal Aether.

It was left for Faraday to give us a true conception of an electric field, and for Maxwell to perfect that conception and

give us a physical aspect of the same. Faraday conceived that stretching out from a magnet or electrified body through space, that is, through the Aether, were what he called "Lines of Force," and that these lines of force indicated not only the direction of the magnetic and electric forces, but also their intensity or power.

Where the lines of force were closest together, there the electric or magnetic energy was the greatest and most intense; and where they were the farthest apart, there the field was weakest in energy. An illustration of the magnetic lines of force may be obtained by placing a piece of paper over a magnet, and then strewing iron filings over the same, when it will be seen that the iron filings will arrange themselves in certain curved lines, which Faraday called Magnetic Lines of Force. In this way Faraday mapped out the lines of force, relative not only to single magnets, but also to magnets with poles placed in various positions relatively to poles of other magnets.

Now as there are lines of force which reveal the intensity and direction of the magnetic energy, so there are lines of force radiating out from electrified bodies which reveal the intensity and power of the electric field. The electric lines of force are radial, and are shown in the figure (Fig. 9) by the straight lines *D F, D H, D K*.

If an electrified pith ball, for example, be hung up in a room, then the lines of force, which extend from the ball, indicate the stress in the Aether surrounding the pith ball, so that if a hair be placed across these lines of force, any movement of the pith ball will be indicated by the motion of the hair.

It was Clerk Maxwell, however, who gave to the world a true physical conception of Faraday's Lines of Force, in his paper on "Physical Lines of Force."¹

In the opening words of that paper he writes as follows: "We cannot help thinking that in every place where we find these lines of force, some physical state or action must exist in sufficient energy to produce the actual phenomena." Maxwell then went on to show what these physical actions were, which took place in the dielectric—that is, the medium surrounding the electrified body which we now know to be the Aether.

This electric field, he pointed out, was "in a state of stress, which consisted of pressures or tensions different in different directions at the same part of the medium. The relation of these forces were threefold, and consisted in the most general type of stress of three pressures or tensions in directions at right angles to each other."

¹ *Phil. Mag.*, 1861.

Thus, in Maxwell's opinion, the existence of a medium, which by its physical character was able to exert energy on material bodies, was one of the fundamental hypotheses of his theory as to the physical character of Faraday's Lines of Force.

This physical medium was to be capable of certain motions, and both electric and magnetic forces were produced by its motions and its stresses. Maxwell's conception, however, of the physical lines of force was more or less hypothetical, and up to the present, as far as I can learn, has not received that authority from science that such a hypothesis requires to make it an accepted theory in science.

But what I venture to point out is, that with the view of the aetherial medium that is submitted in this work, Maxwell's hypothesis remains a hypothesis no longer, and that the hypothetical character of his theory ceases to exist. For, by our conception of an atomic and gravitative Aether, we are able to see that his physical lines of force are indeed physical, and that his brilliant hypothesis now receives a true physical foundation which otherwise it would not receive from a frictionless Aether.

There is nothing, I venture to predict, in Maxwell's hypothesis which cannot be accounted for on a truly physical basis, by the conception of the Aether as given in this work. So that when Faraday saw in his mind's eye lines of force traversing space, he saw by his imagination that which was actually the real state of affairs, and when Maxwell enlarged the conception by giving to those lines of force a definite atomic and cellular structure, he, too, but anticipated the real nature and character of the Aether as given in Chapter IV., which theory is the direct outcome of Newton's philosophical rules, and the result of discarding everything that is not in accordance with experience and observation. Thus the lines of force which exist and surround a magnetic or electrified body are as real as ocean currents, or the waves of the sea, in that they are the manifestations of the motions of the universal Aether, which is as truly matter as air or water.

Let us look at the analogy which exists between the lines of force and the gravitative Aether, and we shall see that a gravitative Aether fully agrees with the conception of an electric Aether as revealed to us by the lines of force in an electric field.

As is well known, the lines of force are closer together in that part of the electric field where the intensity of the field is greatest; and the intensity of a field being greatest at the surface of an electrified body, the lines of force are therefore closer together nearest to the surface of such a body than further away.

Now according to Art. 45 Aether is gravitative, therefore the

Aether nearest the surface of a body is densest, and the aetherial atoms are therefore more pressed upon than the layer immediately above it. Such a result is exactly what should happen provided that Aether has an electric basis, and that Aether is gravitative. For, in Art. 45, we have seen that because Aether is gravitative, therefore it must possess various degrees of density, being densest nearest the surface of an attracting body.

In electricity we find a similar phenomenon which corresponds to aetherial density, which is known as Electric Density, by which term is meant the amount or quantity of electricity spread over a certain area or surface. If we double the quantity of electricity on that given surface, then we double the density, and we say that the electric density is doubled, while if we halve the quantity of electricity, then we say the electric density is halved, and so on.

But this is exactly what happens in the case of aetherial density, as proved in Art. 46. We have only to picture the number of aetherial atoms being doubled on a given area, and at once the physical conception of electric density is furnished, if we remember that Aether has an electric basis as suggested by Maxwell and proved by Hertz. Thus we see at once why it is the lines of force should be closer together nearer the electrified body than farther away.

Electric Potential.—There is another aspect of the electric field that I wish to call the reader's attention to, and that is the Electric Potential of such a field.

Electric potential is to electricity what temperature is to heat, or pressure is to any medium of different densities. We have already seen, according to the laws of thermodynamics, that heat will flow from a higher temperature to a lower one, with the result that work is done. In the case also of water at two different levels, work can also be done by the water flowing from a higher to a lower level.

A similar thing happens in electricity; where we have two conductors or two parts of an electrical fluid at different potentials, electricity will flow from the place of higher potential, until the potentials are equalized, in the same way that the temperature of two bodies at different temperatures would be equalized by the flow of heat.

So that electric potential agrees with our conception of a gravitative Aether in that, being gravitative, it is denser in those parts nearest to the attracting body than farther away, and as the elasticity or pressure is proportionate to the density (Art. 47), therefore we learn that the electric potential of the Aether, and the thermal condition of the Aether, if I may use

such a term, both agree and coincide with the density and elasticity of the Aether.

Any equipotential surface which represents a particular aetherial density, would also correspond with a particular elasticity or pressure of the Aether, while it would further correspond with a particular temperature, if such a term is applicable to the Aether.

Equipotential Surfaces.—The fact that in an electric field there are different points at different potentials, leads us to the truth that in an electric field there are also equipotential surfaces; that is to say, there are surfaces where the electric density or the aetherial density are equal at all points on such a surface. If, for example, E be an electrified body (Fig. 9), and $A A'$, $B B'$, represent equipotential surfaces around the body, then all the points on $A A'$ would be of equal potential—that is, of equal energy, or pressure.

We have to remember that $A A'$, $B B'$, are sections of a sphere, so that when the body as E is a sphere, then the equipotential surfaces are spheres also. This agrees with Art. 77, in which we saw that the pressure around any body due to aetherial density also possessed equipotential surfaces.

It could equally be shown that there were equipotential surfaces so far as the phenomena of heat and light are concerned, as these also are subject to the same laws. Having now very briefly considered the meaning of the Electric Field, Electric Potential, Electric Density, and Equipotential Surfaces, we are now in a position to apply these facts to our solar system, at least as far as the sun is concerned.

In the foregoing Art. we arrived at the conclusion that the sun was an electrified body, therefore, in accordance with all experiment and observation, it, too, must have an electric field. Not only must it have an electric field, but that field must possess different potentials, possessing a higher potential the nearer the field gets to the sun, and a lower potential the farther away the field is.

Further, around the sun there must also exist not imaginary but real physical lines of force which indicate the electric and magnetic forces, and which are made real by the atomic character of the Aether that surrounds it; and those lines of force would be closer together the nearer they got to the sun on account of the electric density of the electric Aether, which coincides with the density of the Aether from the gravitative standpoint. There would also be aetherial equipotential spheres, or rather oblate spheroids around the sun, as the sun is not strictly a sphere, its polar diameter being less than its equatorial diameter.

Let us therefore endeavour to picture the sun under these conditions as the centre of our solar system. Let S be the sun

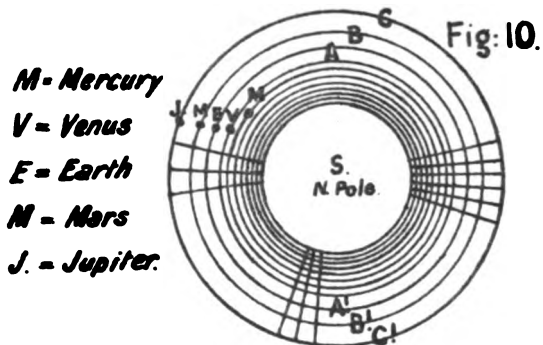

(Fig. 10), and the lines AA' , BB' , CC' , etc. represent Equipotential Surfaces, Fig. 11 being a vertical section and Fig. 10

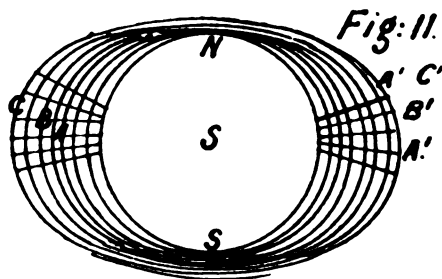

being an equatorial section. In Fig. 11 the sections of the equipotential surfaces would be vertical, while in Fig. 10 the sections of the equipotential surfaces would be horizontal, while the electric lines of force would be radial, as all electric radiations take place in straight lines, as we shall see was proved by Hertz, later on. We will suppose that the sun is stationary, as the question of the movement of the sun, both axially and through space, will be considered in a subsequent article.

Then the question arises, How far does the sun's electric field extend? That is rather a difficult question to answer, but the correct answer would be, "As far as the sun's light extends, so far does the sun's electric field extend." From the electromagnetic theory of light we know that wherever there are light waves, there are electro-magnetic waves, though at the

present moment we are only dealing with the electric aspect of those waves.

We know that the aetherial light waves reach at least as far as Neptune, a distance of 2,750,000,000 miles, therefore we know that the sun's electric field must also extend to that distance. How much further in space it extends we cannot tell, because the data on which to form a basis is inadequate.

Thus we learn that the sun's electric field extends east and west for that enormous distance, but we cannot say that it extends the same distance north and south. Now why is that? The first reason I should give is the well-known experiment of a revolving body, by which we learn that when a body is revolving, as the sun for example, the atmosphere around it would seek to extend itself east and west, owing to the

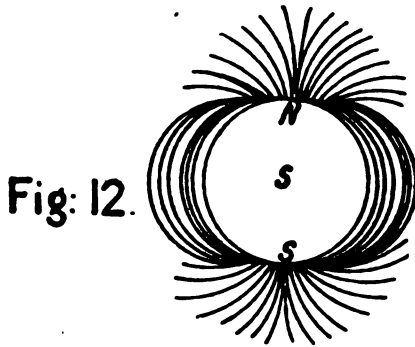

Centrifugal Force so called. But a better reason than that will be found from an analogy of a magnetized body. Faraday has shown in his drawings illustrating lines of force, that if a spherical body is magnetized, the magnetic lines of force extend in circles east and west, but go out into space in almost straight lines north, and south as the preceding figure shows.

Therefore, accepting Faraday's experiment as the basis for our conception of the magnetic lines of force in the sun's electric field, we come to the conclusion that the electric field around the sun extends east and west, while the lines of force, north and south, are more or less radial into space as depicted in the figure.

Throughout the whole of the field, the electric potential, at different distances from the sun, would differ in accordance with all experiment and observation. The greatest electric potential would therefore be nearest the sun's surface, and would be greatest in the equatorial regions of the sun, in accordance with

a well-known rule which determines electric density and electric potential on conductors.

As we proceed from the sun's surface east and west into space, we should pass equipotential surfaces of different potentials. Thus the pressure on every point of equipotential surfaces would be regulated by the electric density of the Aether, which would coincide with the actual aetherial density at that point ; and as the aetherial density is the measure of its elasticity or pressure, so the electric potential would correspond with the elasticity or pressure at the same point.

Thus it is possible to map out the electric field east and west by ever-increasing and widening circles which would be at lower potential the further they receded from the sun. So that by carrying out the electro-magnetic theory of light to its logical conclusion, we are able to bring the whole of the solar system into line with electric phenomena ; and, as we proceed, we shall see that all other facts relating to electricity, and magnetism also, are equally as applicable thereto, otherwise this theory of light must fall to the ground.

That this conception of the universal Aether in its application to solar space is not extravagant may be proved from the writings of Prof. Tyndall and Clerk Maxwell. Tyndall, writing on the subject of Faraday's Lines of Force, says :¹ " The aspect of these curves so fascinated Faraday that the greater part of his intellectual life was devoted to pondering over them. He invested the space through which they run with a kind of materiality, and the probability is that the progress of science, by connecting the phenomena of magnetism with the luminiferous Aether, will prove these 'Lines of Force,' as Faraday loved to call them, to represent a condition of this mysterious substratum of all radiant action."

While Clerk Maxwell,² writing on " Action at a Distance," says: " These Lines of Force *must not be regarded as mere mathematical abstractions*. They are the *directions in which the medium is exerting tension like that of a rope*, or rather like that of our own muscles." I therefore premise, that both these statements will find a literal fulfilment in the conception of the Aether advanced and perfected in this work.

ART. 81. *Aether and Induction*.—We have seen in the preceding Arts. that the sun is an electrified body, possessing an electric field, which field possesses different intensities at different distances from its surfaces.

If such be the case, the question at once confronts us, as to what is the effect of such an electrified body with its electric

¹ Tyndall on *Light*.

² *Collected Papers*, by Niven.

field upon all the planets which revolve around it; for, if its electric field extends as far as Neptune, then all the planets and meteors, that revolve around the sun, must revolve in the sun's electric field.

Such a question can best be answered from the consideration of experiments and theories advanced first by Faraday, who gave to the world his theory of Induction, which we shall now consider.

Let A be an electrified body (Fig. 13), and C be a body not electrified, but situated within the electric field of A . Then it can be experimentally proved, that C will also become an electrified body by induction. As is well known, there are two kinds of electricity, Positive and Negative. We will suppose A to be charged with positive electricity. Then it can be proved that C will also be charged with negative electricity on the half nearest to A , while the other half will be charged with positive electricity.

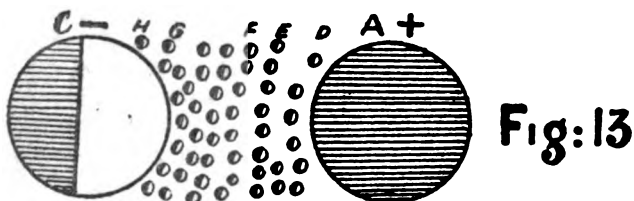

Fig:13

Now how has this result been brought about? According to Faraday's theory the particles of air, the dielectric, between A and C play a most important part in the process. As a matter of fact, each atom or particle of air is polarized, as the process of separating the two kinds of electricity is termed, so that every atom has one half of it covered with positive electricity, and the other half with negative electricity.

For example, let A and C be the same brass balls with the particles of air between them, A being the positively charged ball and C the unelectrified ball, the shaded parts representing positive electricity and the unshaded parts negative electricity.

Then A will act inductively on the unelectrified ball C through the medium of the particles of air d, e, f, g, h . The electrified ball A will act first on the layer of particles next to it, attracting their negative electricity and repelling the positive according to the well-known law that "Unlike electricities attract, like electricities repel each other."

The positive electricity in the first layer then acts in the particles of the next layer in the same way, and thus the

inductive action is transmitted through the particles, from layer to layer, until we come to the last layer of particles next to the ball *C*.

As the half of each atom or particle nearest to *C* is positively electrified, then the half of the ball *C* nearest to the layer becomes negatively electrified, while the half further away is positively electrified. Thus we say that *C* has become electrified by induction through the polarization of the particles of air which lie between the two bodies. Faraday on this point says: "Thus induction appears to be essentially an action of contiguous particles, through the intermediations of which the Electric Force, originating at a certain place, is propagated or sustained at a distance, appearing there as a Force of the same kind exactly equal in amount, but opposite in its direction and tendencies."¹

While again he states:² "Induction appears to consist in a certain polarized state of particles into which they are thrown by the electrified body sustaining the action, the particles assuming positive and negative parts which are symmetrically the lines of Inductive Force." Thus in the case of any electrified body, acting on an unelectrified body at a distance, it has to be definitely understood that *the action at a distance* is alone communicated and propagated by the dielectric or medium which exists between the two bodies. Though in the case of Gravitation it has been mathematically assumed, that action at a distance is possible, yet experimentally and physically such an assumption is philosophically incorrect, as all experience and experiment go to prove that there is no such thing as action at a distance manifested, except such action is propagated through the intervening medium, as stated and proved by Faraday.

In order to bring Gravitation, therefore, into line with our experience, it will have to be demonstrated that it, too, is the result of the action of the intervening medium, that is, the Aether, which is a result we are being led up to.

We have already seen that the sun is an electrified body, possessing an electric field, and as all electrified bodies can act on other bodies in their field inductively, then a similar result should happen in the solar system, that happens in any electrical experiment on induction, with the result that all the planets should become electrified bodies by induction, such action taking place, as Faraday points out, through the medium which divides the sun and the planets, that is, the Aether.

Of course with a frictionless and non-atomic Aether such a

¹ *Exp. Res.*, 1297, 1298.

² Par. 1298.

result would be an impossibility, but with our conception of an atomic and gravitative Aether the result is now attainable. We have therefore to think of the sun, the centre of the solar system, being an electrified body, and for illustration we will suppose it to be a positively charged body.

All around the sun is the atomic Aether, which is polarized in the same way that the particles of air were polarized ; that is, the two kinds of electricities in the aetherial atom are separated, the negative being on that side nearest to the sun, and the positive on the side further away. In this way the whole aetherial medium would be polarized, and any body in the field would be electrified by induction, with the result that the side nearest the sun would be negatively charged, and the opposite side positively charged.

Thus let S (Figs. 10 and 11) be the sun, and the circles represent equipotential surfaces, then one half of every surface would be negatively electrified and the other half positively electrified, that is, assuming the sun to be a positively electrified body.

If M represents Mercury, V represents Venus, and E represents the Earth (Fig. 10), then it can readily be seen that all these would be negatively electrified on the side facing the sun ; and, as they rotate on their axes, each part of the planet would be positively and negatively electrified once each day.

We are assuming that the medium is at rest, but according to our conception in Art. 44, all the aetherial atoms are in rotation on their axes, in the same way that the earth rotates on its axis, so that each of these aetherial atoms would present different parts of its surface to the sun as it rotates on its axis ; but, as that does not affect the principle of induction, such a fact need not now be fully considered.

Let us now ask, What is the result of all the planets becoming electrified bodies in the same way that the sun is an electrified body? Arguing from experience, we come to the conclusion that each planet must also possess its electric field, which also must have its lines of force, its different potentials at different distances, and its equipotential surfaces. So that Mercury, Venus, the Earth, Mars, Jupiter, Saturn, Uranus, and Neptune all have their electric fields, with their own lines of force, and with their equipotential surfaces.

If we carry the analogy further still, then it can also be proved that the Earth, and those planets which have moons or satellites, also act inductively on their satellites, with the result that they too become electrified bodies, with their own smaller electric fields and lines of force. This may seem at first sight a little confusing, but the confusion will gradually disappear if we will look at it carefully for a moment or two. Let us endeavour to

picture the solar system from this new standpoint, and map out the equipotential surfaces, which this idea suggests. Let **S** represent the sun (Fig. 14), the initials of all the planets and satellites representing the various planets; then we get the following plan of the solar system with the various equipotential surfaces shown by the circular lines.

We are now supposed to be looking down on all the solar system from above it, so to speak, so that we should be looking at what we call the North Poles of the sun and planets.

Fig: 14

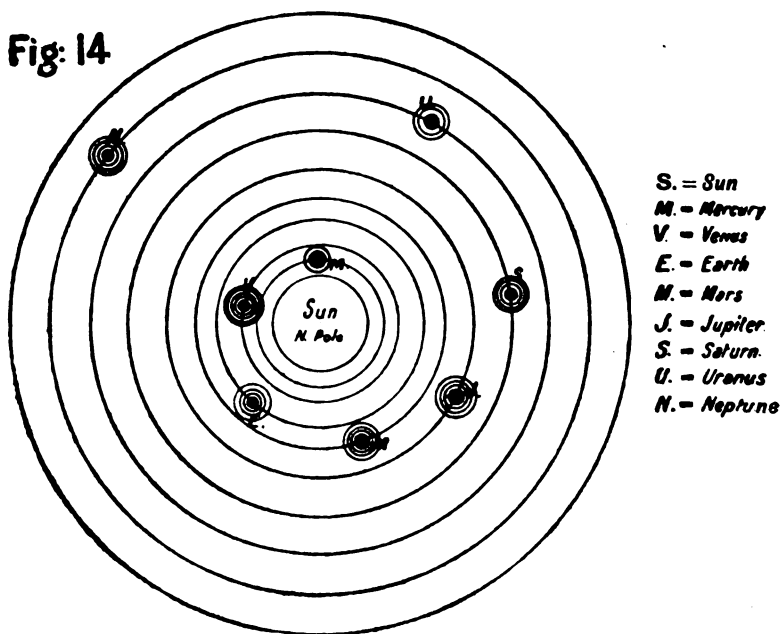

Thus we see that the equipotential surfaces around the sun are huge circles which stretch out as far as Neptune or even beyond, but within those circles we find each of the planets revolving round the sun, each with its own equipotential spheres, which are circles also, while around the various planets are the satellites, from the moon of our Earth, to the two satellites of Mars, five of Jupiter, eight of Saturn, each with its own lines of force and electric fields.

Of course we must not forget that all these revolve round the sun, and the question may suggest itself to the reader's mind, if such a result is possible. I shall prove later on, that according

to Maxwell such an event is possible, but at present we will consider them stationary.

Now let us see how such a conception compares with our hypothesis of a gravitative Aether. If Aether be gravitative, then the sun must have an attraction for the Aether, and its aetherial field would stretch out into space as far as Neptune at least.

So that it can readily be seen that the aetherial field of the sun's attractive power coincides with the electric field which the sun possesses as an electrified body. Again, if Aether be gravitative, then all the planets must also have an aetherial field, which will be co-extensive with their electric field also. The same principle applies to each of the satellites, with the result that they too will possess an aetherial field which will be equal in extent and limit to their electric field.

As the satellites revolve around their primary planet taking their electric fields with them, so the planets with their associated satellites revolve around the sun taking their electric and aetherial fields with them. Thus we get a glimpse, though at this point very shadowy and indistinct, of those motions of the universal Aether, which help to constitute the harmony, beauty, and order of the universe. We have seen, therefore, that as the sun is an electrified body, so all the planets and satellites are electrified bodies also, each possessing its own field, with all that such a field implies.

We shall find that such a conception is borne out by experience and observation, when we come to deal with the Earth as a magnet; because we shall afterwards learn that the Earth is an electro-magnet, possessing its magnetic field, which is co-existent and equipollent with its electric field.

ART. 82. *Energy of the Field.*—We have seen in Art. 79 that every electrified body has an electric field. We have further learned, in carrying the electro-magnetic theory of light to its logical conclusion, that all the planets and satellites together with the sun must be electrified bodies, each possessing its electric field.

We have now to determine the effect of such a truth from its dynamical aspect upon the bodies within the field, that is to say, we have to consider the energy of such electric fields, and endeavour to find out the effect of such energy upon other bodies within that field. Maxwell,¹ in his introduction to a paper on "The Dynamical Theory of the Electro-magnet Field," writes on the matter thus: "It appears therefore that certain phenomena in electricity and magnetism lead to the same conclusion as those of optics, namely, that there is an aetherial

¹ *Collected Papers*, by Niven.

medium pervading all bodies and modified only in degree by their presence; that the parts of this medium are capable of being set in motion by electric currents and magnets; that this motion is communicated from one part of the medium to another by forces arising from the connection of these parts; that under the action of these forces, there is a certain yielding depending upon the elasticity of these connections; and that therefore energy in two different forms may exist in the medium, the one form being the actual energy of motion of its parts, and the other being the potential energy stored up in the connections in virtue of their elasticity."

The two forms of energy he gives us in his work on *Magnetism and Electricity*, where, in the quotation already given in Art. 79, he states them to be electro-static and electro-kinetic energy, while in paragraph 792 of the same work he adds: "The intrinsic energy of the medium is half electro-static and half electro-kinetic, that is, half is due to electricity and half is due to magnetism."

We are, however, only dealing at this point with the electro-static energy in the electric field, as we shall deal with the electro-kinetic energy in the following chapter.

We have, therefore, to conceive of an electrified body generating electric or electro-magnetic waves, which speed away from the generating source on every side with the velocity of light. Now we have already seen that the aetherial waves which give rise to heat and light possess a repulsive power, that is, they exert a pressure on the body with which they come into contact.

If, therefore, in the electric field there is this energy manifested as proved by Maxwell, and that energy takes partly the form of a pressure as stated by Maxwell, then we have in the electro-static energy of the electric field, another indication of that centrifugal force for which we are looking, and whose existence was so satisfactorily demonstrated to Herschel by the phenomena of comets' tails.

That there is this pressure in an electric field was conclusively proved by Maxwell, and experimentally demonstrated by Professor Lebedew (Art. 77). Maxwell distinctly states on this point, "that the combined effect of the electro-static and electro-kinetic stresses is a pressure equal to 2 P. in the direction of the propagation of the waves," that is, away from the electrified or charged body.

He continues: "Thus, if in strong sunlight the energy of light which falls on one square foot is 83.4 foot-pounds per second, the mean energy in one cubic foot of sunlight is about 0,000,000,882 of a foot-pound, and the mean pressure on a square foot is 0,000,000,882 of a pound weight. A flat body

exposed to sunlight would experience this pressure on its illuminated side only, and would therefore be *repelled* from the side on which the light falls."¹

This pressure only gives the result due to the pressure of one cubic foot of sunlight. What must be the pressure, therefore, due to the whole of the sunlight received by the flat body from the sun? The total pressure, whatever it may be, would be equal to 2 P. according to Maxwell, and half of that is due to electricity, and half due to magnetism. Now such a result is entirely in harmony with the conception of the Aether as given in this work. For, if Aether possess an electric basis as suggested by Maxwell, and it is also gravitative as suggested in Art. 45, then it must follow, as pointed out in a previous Art., that throughout the field there is a varying difference in the potential of the field; the potential being regulated by the electric density, that density being equivalent to the aetherial density. Further, as the elasticity of the medium which regulates the pressure is proportional to the density, so the pressure must decrease, as the elasticity decreases—that is, as the electric potential decreases, or the electric density is diminished. Therefore, if the sun be an electrified body, ever generating electro-magnetic waves which speed away from it on every side, then, whenever any of these waves come into contact with a planet or comet, that planet or comet would be repelled from the sun by the pressure of these electro-magnetic waves to which the sun gives rise in its electric or electro-magnetic field.

Thus we again come to the conclusion that the sun is not only the centre of a centripetal force due to Gravitation, and subject to certain laws, whose physical cause is unknown, but it is equally the centre and source of a centrifugal force, in that it is an electrified body, and gives rise to electric waves which produce a pressure on any body upon which they fall, in the sun's electric or aetherial field. It has only to be demonstrated, therefore, that this centrifugal force satisfactorily fulfils all the laws required as laid down in Art. 24, that is, that its course is along the same path as the Centripetal Force of Gravitation, that it is subject to the same law of intensity, which is inversely as the square of the distance; and further (what is the most important at this stage), that the combined effect of the pressure of two bodies is equal to the product of their masses, then we shall have discovered that which we set out to discover, viz. a complementary force to the attractive force of Gravitation.

Unlike the centripetal force, however, the centrifugal force will be purely a physical one, due to a purely physical medium,

¹ *Magnetism and Electricity*, Arts. 791 and 793.

the Aether, whose properties and motions can be accounted for on a physical, and not on a hypothetical basis.

Further, as the planets are also electrified bodies (Art. 81), they too will possess an electric field, and will generate electric waves, which will also exert a centrifugal force upon all bodies upon which the waves fall. So that, like the sun, the planets are not only the centre of a centripetal force, which ever acts towards their centre ; but they are also the centre of a centrifugal force, due to the aetherial electric waves to which they give rise in the Aether.

The application of the same principle may be extended to every satellite that exists in the solar system, and indeed to every particle and atom of matter that exist throughout the universe, for wherever we find the Aether, there we find this centrifugal force, which is due to the electric aetherial waves generated by the atom or particle of matter, or by any combination of atoms, as a meteor, satellite, planet, sun or star.

ART. 83. *Electric Radiation*.—We learn, therefore, that the sun, together with every planet and satellite in the solar system, is the centre of a centrifugal force, which is due to the radiation of electric waves by an electrified body. We have now to prove that this force fulfils all the laws required, in order for it to become the complementary law to the Centripetal Force of Gravitation. We will first show that this centrifugal force which proceeds from the electrified body is radiated out into space in straight lines with the velocity of light and radiant heat.

As we have already seen, it was due to the genius of Hertz to show the identity between electric radiation and radiant light and heat. In his paper on Electric Radiation he says :¹ " I have succeeded in producing distinct rays of electric force, and in carrying out with them the elementary experiments which are commonly performed with light and radiant heat." We have seen in Arts. 65 and 76 that radiant heat and light are propagated in straight lines, so that, according to Maxwell's electro-magnetic theory, a ray of electric radiation should also be propagated in straight lines.

This Hertz proved, and gave his results in his paper " On the Action of a Rectilinear Oscillation upon a Neighbouring Circuit," in which he fully demonstrated that when electric action takes place between two charged bodies, the electric force is radiated out into space in straight lines in the same way that light and radiant heat are radiated. In his paper on " The Finite Velocity of Electro-magnetic Actions," he showed that the velocity of the electro-magnetic waves was the same as that of light. In the

¹ Hertz on *Electric Waves*.

summary of this paper (paragraph 3) he states: "There are many reasons for believing that the transverse waves of light are electro-magnetic waves; a firm foundation for this hypothesis is furnished by showing the actual existence in free space of electro-magnetic transverse waves which are propagated with a velocity akin to light."

Again, in his paper on "Electric Radiation," he not only showed how the radiation was propagated in straight lines, like light, but also proved that while it was reflected by metals, the electric beam was able to pass through doors and stone walls, and adds, "that it was with astonishment that one saw the electric beam appear inside a closed room after its passage through the door."

Thus Hertz has shown that both electric and magnetic effects are propagated through the Aether with finite velocity, and that that velocity is exactly the same as the velocity of light. He further proved that this propagation takes place in straight lines, in the same way that radiant heat and light are propagated. This being so, it is necessary for us to apply these truths to the solar system, with a view to find out what such a result teaches us.

We have seen in a preceding article, that the sun is an electrified body; therefore it, too, must generate these electro-magnetic waves, and radiate them into space on every side with the velocity of light. Let us try to picture the scene. Let S represent the sun, and the circle round it represent the equipotential spheres which exist round the sun. (See Figs. 10 and 11.) As the intensity of the electric force is greater nearer the sun than further away, these equipotential surfaces will be closer nearer the sun than further away.

Then let the straight lines which radiate out from the sun represent the path of an electric ray. It can be easily seen that these electric rays cut the equipotential surfaces at right angles, as they pass from the centre of the sun outwards into space. Now these lines not only represent the path which the electric ray takes in its journey through space, but exactly coincide with the electric lines of force as conceived by Faraday. This great thinker and experimentalist not only conceived lines of magnetic forces existing in the dielectric or medium between two electrified bodies, which in this case is the Aether, but also conceived lines of electric force which started at a conductor, or an electrified body, and radiated out into space.

Thus a line of electric force has a definite direction, and always starts from an electrified body. If it were possible to move a planet along one of these lines of force, its path would be that of a straight line. If on the other hand a planet moved at right angles to one of these lines of force, that is, along the surface of an equipotential sphere, then no work would be done

against the electric force, as on such a sphere the electric force would be of the same intensity.

So that from Hertz' experiments it can be demonstrated, that if there be any electric force existent in the Aether, due to the action of the sun upon the Aether, then such a force is directed along the path of a straight line into space with the velocity of light, which, as already pointed out, is the path taken by a ray of radiant heat and light, and coincides with the path taken by the centripetal force.

It has been demonstrated that such electric force is accompanied by a repulsive force, or more correctly a pressure, so that here we have further evidence of the existence of a centrifugal force which finds its generating source in the sun, which is also the centre of the attractive force of Gravitation in the solar system.

The application of Hertz' experiments may be made not only to the sun, but also to every planet and satellite that exists in space with the same result; and, further, may be extended to every particle and atom that exists throughout the universe. For, according to Art. 43, we have learned that Aether is universal, and we have seen that it is gravitative, and have learned from the electro-magnetic theory of light that it has an electro-magnetic basis. Therefore, to be thoroughly consistent, we must not stop in the application of this principle at any point in the whole universe.

Either the whole principle is of universal application, or it ceases to be a universal law. Therefore, if there is this centrifugal force operating along a straight line from the centre of an electrified body, such centrifugal force must be in its application universal, in order to be complete, and in order to satisfactorily form the counterpart of the centripetal force which is also universal, and operates along the straight line joining the centres of gravity of any two bodies.

ART. 84. *Law of Inverse Squares.*—We have learned therefore from the preceding Arts., that the solar system may be looked upon as an electric field, with the sun as the electrified body occupying the centre. We have also seen that there is a centrifugal force in all electric fields, which is due partly to electric waves, and partly to the magnetic waves of the Aether.

It will be interesting to find out, what law governs the intensity of this force in any part of the field, or at a given distance from the central body. We have seen (Art. 66) that the law governing the intensity of heat at any distance from the sun, is the law of inverse squares. Further, from Art. 75 we have also learned that light is subject to the same law of inverse squares, as indeed it should be, if it be due to one and the same medium, the Aether.

If, therefore, electricity is also due to certain motions of the aetherial medium originated by the action of an electrified body as the sun, in the same way that light and heat waves are originated, then it ought to follow that the repulsive power of electricity is also subject to the same law of inverse squares. As a matter of fact, that is exactly the state of affairs, so that we find the intensity of the repulsive power in the Aether from any central body, due to the electric waves, or the pressure due to the wave motions of the electric Aether, in relation to that body, is governed and controlled by the same law that governs light and heat.

It may be suggested that such a coincidence is not a very strong argument, as all forces emanating from a central body are subject to the same law of inverse squares. In reply to that, I should like to point out, that even that objection only strengthens the conception of the Aether that we are endeavouring to complete. Our contention is, that all physical forces, whether they be light, heat, electricity, magnetism or Gravitation, are all due to the motions of the aetherial medium; which motions may be generated by a heated or luminous or electrified body, and are radiated from such a body in waves of concentric spherical form, and are all subject to the laws of inverse squares.

So that the fact of the intensity of the centrifugal force due to the repulsive power of electricity falling into line with the law governing light and heat is, to my mind at any rate, only a clearer proof of the one common origin of all the physical forces. The law of inverse squares in relation to electricity may be thus stated. The Centrifugal or Repulsive Force between two charged electrified bodies acts inversely as the square of the distance between them.

This law was proved by Coulomb by means of an instrument known as Coulomb's Torsion Balance, and I must refer the reader to any work on electricity for a full establishment of this law. Suffice to say, that it has been experimentally demonstrated that the law holds good in relation to the phenomena of electricity; and, wherever we get the two kinds of electricity present in any medium or conductor, owing to the polarization of its particles, there we have this law operating in relation to the intensity of the repulsions of the two bodies directly concerned.

We have already learned that the sun is an electrified body, and from that hypothesis we have arrived at the conclusion that the earth and all the other planets are electrified bodies. This being so, it naturally follows that the intensity of the centrifugal force between any two of these bodies, as the sun and the earth for example, or the sun and Jupiter, is subject to the law of inverse squares; and that the repulsion of the sun and the earth for each

other is always regulated by their distance, being inversely as the squares of the distance between them.

Thus, if the distance between the sun and any planet is reduced to one-half, which is an exaggerated view, the intensity of the centrifugal force is increased four times; if the distance be doubled the force is reduced to four times its former intensity, and so on.

Whatever the distance may be between the sun and any of the planets, if that distance be increased or decreased, then the intensity of the centrifugal force due to electric waves is increased or decreased in accordance with the law of inverse squares. This agrees with the centripetal law of Gravitation, as the Attraction of Gravitation is also subject to the same law of inverse squares, and, as we have seen (Art. 83), its path coincides with the path of centrifugal force, as it pursues the path represented by the straight lines joining the two bodies.

So that, whenever, and wherever, at any point in space in relation to the central body, the sun, the intensity of the attractive force is increased according to the law of inverse squares by the distance from the central body being diminished, at exactly the same time and in exactly the same manner, the repulsive force due to aetherial electric waves is also increased. If the attractive force is doubled, then the repulsive force is doubled. If the attractive force is halved, the repulsive force is halved. If the attractive force is lessened gradually, then the repulsive force is lessened gradually; and if quickly, by the quicker motion of the planet through space, then the repulsive motion is also increased with a quicker motion.

Further, like the repulsive power of light and heat, the repulsive power of electricity takes exactly the same path as the attractive power of Gravitation.

Thus we learn that the sun is the centre of two forces: first, a centrifugal force due to the pressure of the aetherial medium which is ever directed away from the sun, and which may either be produced by electric or thermal or light waves; and second, it is the centre of a centripetal force known as the Law of Gravity, whatever that may be due to. Further, the centrifugal force is also subject to the same law of intensity as the centripetal force, and moreover takes exactly the same path which the centripetal force takes.

So that we have only to prove that they both agree in another particular, viz. that their power is regulated by the product of their masses, and then we shall have discovered a real physical force, which is the exact complement and counterpart of the centripetal force due to gravity.

ART. 85. *Second Law of Electricity. (Product of Masses.)*—

We have now to prove that the centrifugal force exerted by any electrified body operates upon another electrified body in the same proportion and with exactly the same force which governs the centripetal force. From Art. 21 we learn that the centripetal force which is exerted by one body upon another is equal to the product of their masses. In order, therefore, for any centrifugal force to be the exact counterpart of that force, it too must be subject to the same law of proportion, that is, the repulsive force between any two bodies must be equal to the product of their masses.

We have shown that there is a repulsive force exerted by the Aether from the phenomena of heat, light, and electricity, and that that repulsive force or energy fulfils every condition required by a centrifugal force or motion, with the exception of the part referring to the fact that such a force must be proportionate to the product of their masses. What we were unable to accomplish, however, from the phenomena of heat or light we are now able to accomplish from the phenomena of electricity.

For in the phenomena of electricity we find a law which runs thus: "The force of repulsion" (which is the part of electricity we are now dealing with) "between two electrified bodies is equal to the quantities of electricity with which the body is charged." This law was established and proved by Coulomb by means of a delicate instrument known as the Torsion Balance, with which he also established the law of inverse squares.

It will be seen at a glance that there is a slight difference between stating the law of proportion with reference to the centripetal force, and the centrifugal force or motion. In the former we state the proportion is equal to the product of the masses, while in the latter we say that the proportion is equal to the product of the quantities of electricity.

In the one case we deal with the mass of the body, whether it be atom, molecule, planet or star; in the other case we deal with quantities of electricity. At first sight it may seem that there is little, if any, connection between the two laws, but a careful reflection of the hypotheses laid down with regard to the aetherial medium will show that there is not only a close connection between these two laws of proportion, but also that the law governing the repulsive power of the aetherial electric waves is the direct outcome of the law of proportion governing the centripetal force. Let us restate our case in regard to the aetherial medium.

We have learned that the Aether is gravitative, and that it also has an electro-magnetic basis is proved from Maxwell's electro-magnetic theory of light. Let me ask the reader this

question therefore. If the Aether be gravitative, what must be the rule governing the extent and density of the aetherial atmosphere surrounding any planet or sun or other body? If the Law of Gravity teaches us anything at all, it distinctly teaches us that the gravitating power of any body is regulated by the mass of the body, as the law states that the attraction is proportionate to the product of the masses. It states nothing about volume or condition of a body.

The exact size or state of a body has no direct result bearing on gravitation attraction; the underlying principle being that the attractive force is dependent on the mass, and only on the mass of a body. So that if the volume of any body, whether atom, planet, satellite or sun, be doubled, its attractive power remains the same, simply because the mass of the whole body remains the same. Mass, we are told by mathematicians, is equal to the volume multiplied by the density, and whenever we increase the volume of a body we decrease the density, the total mass of the body remaining the same.

If the volume be doubled, then the density of the body would be halved, and *vice versa*, but through all the changes of volume and density that may arise from the addition of heat or diminution of heat, the total mass of a body always remains the same. Looked at from the atomic standpoint, taking hydrogen as unity, an atom of oxygen would always weigh sixteen times an atom of hydrogen, and this principle applies throughout the whole realm of the atomic world. Further, the same principle or law, that the mass is equal to the volume multiplied by the density, is true of the planetary or even the stellar world. Thus the great regulating principle of the attractive force of gravity is mass, and not volume, or density, or any other condition.

Now as Aether is subject to the attractive force of gravity, the extent of the aetherial field, and the density of the Aether near the surface of any body, must be subject to the same law regarding mass. That is, the aetherial atmosphere of any atom, or molecule, or satellite, or planet, or star is dependent upon the mass of the atom, the molecule, or the planet, or the star as the case may be.

Thus an atom of oxygen would have a larger or denser aetherial atmosphere than an atom of hydrogen, exactly proportionate to their respective masses. A planet whose mass was represented by 1,000,000 tons would have twice the quantity of Aether around it, compared to a planet weighing only 500,000 tons, and so on, the aetherial atmosphere always being proportionate to the mass of the planet, or the satellite, or the sun, or the star. The fact which we learn from these con-

siderations is that the quantity of Aether, which is attracted by any body, is always proportionate to the mass of the body attracting it.

But we have learned from Art. 78 that Aether has an electro-magnetic basis, and that the density of the Aether is co-equal with electric density, so that the quantity of Aether which is attracted and held bound by any body is really equal to the quantity of electricity that such a body is covered with, or is charged with. If the quantity of Aether around any body is doubled because its mass is doubled, then the quantity of electricity is also doubled, but as long as the mass remains unaltered, the quantity of electricity held bound by that mass remains unaltered also. The area of the mass may be doubled, and in that case the density of the electricity would be halved, but as long as the mass remained the same, the quantity of electricity would remain the same also. So that we learn from this reasoning that the mass of a body, and quantities of electricity on that mass, are always proportionate to each other, because of the fact that Aether is gravitative, and also has an electro-magnetic basis.

If we wanted further evidence of the hypothesis that has just been advanced, such evidence is to be found in the hypothesis suggested by Faraday as to the electro-chemical equivalents of all elements. According to this hypothesis every element has its exact electro-chemical equivalent, or definite quantities of electricity are to be found in association with each and every particular atom of each element. Writing on the subject in his *Exp. Res.*, par. 852, he says: "The theory of definite electro-chemical action appears to me to touch upon the absolute quantity of electricity or electrical power belonging to different bodies. Although we know nothing of what an atom is, yet we cannot resist forming some idea of a small particle which represents it to our mind, and though we cannot say what electricity is, so as to be able to say whether it is a particular matter or matters, or mere motion of ordinary matter, yet there is immensity of facts which justify us in believing that the atoms of matter are in some way endowed or associated with electrical powers to which they owe their most striking qualities, and amongst them their chemical affinity." Further, in Art. 857, he states: "I can have no doubt that, assuming hydrogen as 1, and dismissing small fractions for the simplicity of expression, the equivalent number or atomic weight of oxygen is 8, of chlorine 36, of bromine 78.4, and of lead 103.5, etc., notwithstanding that a high authority doubles several of these numbers."

Then, writing upon the definite relationship of these equivalents in compounds, he states (Art. 835): "Electro-chemical

equivalents are always consistent, that is, the same number which represents the equivalent of a substance *A* when it is separating from a substance *B* will also represent *A* when separating from a third substance *C*. Thus 8 is the electro-chemical equivalent of oxygen, whether separating from hydrogen, tin, or lead; and 103.5 is the electro-chemical equivalent of lead, whether separating from oxygen, or chlorine, or iodine."

Here, then, from the pen of one of the greatest thinkers and experimentalists of modern times we have confirmatory evidence that the mass of any body is practically synonymous with the quantity of electricity associated with that body. For if the principle is true in its application to atoms, it is true in its application to molecules; and if it is true in relation to molecules, it is equally true in relation to small bodies composed of molecules. And if it holds good in relation to small bodies, the principle is equally true in its application to larger bodies, as the earth, and therefore is of universal application and proves the statement already made, that the masses of bodies and quantities of electricity in association with that mass are always proportionate to each other.

We are now in a position to compare the proportion of the centripetal and centrifugal forces. The attractive power of the former, between two bodies, is equal to the product of their masses; the repulsive power of the latter is equal to the product of the quantities of electricity bound to them, and that, as we have seen, is regulated by the respective mass of each body. Let us apply this fact to the solar system and see how it works.

Taking the mass of the earth as unity, we find that the mass of the sun is 324,000 greater, so that the attractive power of the two bodies would be represented by the product of the two numbers; but because the sun is that number of times greater, its aetherial and, therefore, its electric field would be so many times greater, with the result that the proportion of the repulsive forces between the two bodies would be exactly the same as the attractive forces between the two bodies, that is, if the mean distance remains the same.

In the same way, it can be shown that the attractive forces between the earth and Jupiter exactly equal the repulsive forces between the two planets at their mean distance, or the attractive forces between any two planets or satellites are exactly counter-balanced by the repulsive power of the centrifugal force at their mean distances.

Thus the centrifugal force of every body is the exact opposite of its centripetal force at their mean distance, because the laws governing the centrifugal force are the exact counterpart of the laws governing the centripetal force. A comparison of the two

will prove this. From Arts. 20, 21, and 22 we have seen that the centripetal force is exerted along the straight lines joining the attracting bodies, that the intensity of the attracting body is inversely as the square of the distance, while the total force is proportionate to the product of their masses.

From the phenomena of light, heat, and electricity, we learn that the centrifugal force due to aetherial pressure is exerted along straight lines, that the intensity is inversely as the square of the distance, while the total force between two bodies is equal to the product of the quantities of electricity, which are regulated by the product of their masses.

Thus, if every planet and satellite could be conceived to be motionless in space, and these two forces could be set in operation without producing rotation or translation in space, which is impossible, then every planet and satellite would occupy, by the joint exercise of these two forces, the same position in relation to the sun represented by their mean distances, as long as the solar system existed as a separate system in the realm of aetherial space. We have therefore discovered by strict philosophical reasoning, based on Newton's Rules of Philosophy, a real tangible centrifugal force existing throughout the universe; because it is entirely due to the pressure of an universal Aether, whose operation is ever directed from a central body, which force was indicated by Herschel, and its existence to his mind was demonstrated by the repulsion exhibited in connection with the tails of comets.

We have now to go a step further, and show that the same pressure also includes the magnetic phenomena, as indicated by Clerk Maxwell, and that magnetic phenomena are also due to the aetherial medium, and then we shall have linked together in one common medium the majority of the forms of energy, as light, heat, electricity and magnetism, with which we are familiar.

If it be demonstrated that these two forces, the centrifugal force and the centripetal force, can conjointly account for all the motions of the celestial bodies, then we shall have conclusive evidence that one of the forces is physical and due to the pressure of a physical medium. After that it will be comparatively easy to show that the centripetal force is also due to the same aetherial medium, and then we shall have accomplished that which we set out to accomplish, viz. the establishment of a physical cause for universal Gravitation, which physical cause is alone to be found in the pressures, tensions and motions of an universal Aether.

CHAPTER IX

AETHER AND MAGNETISM

ART. 86. *Electro-magnetism*.—We have now to look at the relation of magnetism to electricity, or, in other words, to prove the identity that exists between magnetism and electricity. In Art. 78 we have proved the identity between electricity and light, so that if we can now prove the identity between electricity and magnetism, then, wherever we get aetherial light waves, we must also get aetherial electro-magnetic waves.

As the light waves due to the vibrations of the Aether are practically universal in extent, then it must follow, if the identity of the light waves with electro-magnetic waves is established, that the universality of electro-magnetic waves is established also, with the natural result, that, wherever we get these electro-magnetic waves, there we shall have the conditions by which all electro-magnetic phenomena are produced.

Now it can be demonstrated by actual experiment that wherever we get a circular current of electricity, there we have magnetic phenomena manifested. The two are inseparably connected, and it is impossible to obtain the one without the other. For example, suppose we have a wire conveying a current of electricity and make it into a coil as in Figure 15, what is the result? The result is, that the coil of wire has actually been converted into a magnet.

It will attract iron filings that are brought near it, and also magnetize an iron bar placed in the centre of the coils, and convert that into a magnet. Indeed, there is nothing which can be done by an ordinary bar magnet which cannot be done by a coiled wire conveying an electric current.

From this and similar experiments it can be demonstrated that wherever we get a circular current of electricity, there, associated with that current, are all the phenomena incidental to and associated with the ordinary bar magnet. This leads us to the truth discovered by Ampère, that magnetism is nothing more or less than electricity in rotation, or that it is due to a whirl of electricity circulating round the molecule of any body. From certain experiments which he made in relation to the mutual

action of two circuits on each other, with currents flowing through them, he came to the conclusion that the magnetism of the molecule of each magnet is due to electric currents circulating round it.

The question arises as to what effect our new theory of the Aether has upon Ampère's theory: does it confirm it, or does it destroy it? We have learned that every atom has its aetherial atmosphere, so to speak, which is bound to the atom by the Law of Gravitation (Art. 45). We have also learned that Aether has an electrical basis, as proved by Maxwell and Hertz, so that we learn that every atom has really an aetherial electric atmosphere in association with it. We have only to conceive of this atmosphere being set in rotation either by the rotation of the atom or molecule itself, or by outside agencies, and we have at

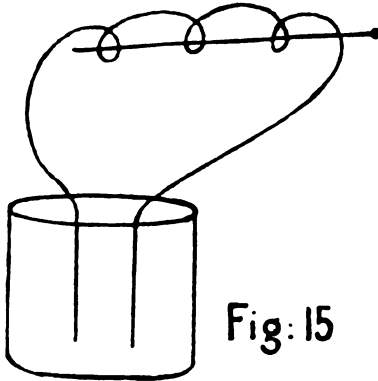

Fig: 15

once a physical interpretation of Ampère's theory of magnetism in the rotation of electric currents around the atom, such currents being due to the circulating or rotating motion of the Aether which surrounds the atom or molecule.

Thus we learn from experiment, and from Ampère's theory also, that magnetism is directly associated with circulating currents of electricity, and that wherever we get currents of electricity circulating round any atom or body, there we get all the phenomena associated with magnetism. That is to say, we shall have such phenomena as magnetic fields, magnetic lines of force, magnetic induction, and the production of permanent magnets by electricity.

Further, with reference to the identity of electricity and magnetism, Faraday has conclusively proved their relation to each other; and I would strongly advise any reader who desires further light on the subject to carefully read paragraphs 3265-3269

in his *Experimental Researches*, where he will find experiments which place the identity of electricity and magnetism beyond the possibility of doubt. In paragraph 3265 he writes: "The well-known relation of the electric and magnetic forces may be thus stated. Let two rings in planes at right angles to each other represent them. If a current of electricity be sent round the ring *E* in the direction marked, then lines of magnetic force will be produced. As these rings represent the lines of electro-dynamic force and of magnetic force respectively, they will serve for a standard of comparison."

"I have elsewhere called the electric current or the line of electro-dynamic force an axis of power having contrary forces exactly equal in amount in contrary directions (517). The line of magnetic force may be described in precisely the same terms,

Fig: 16.

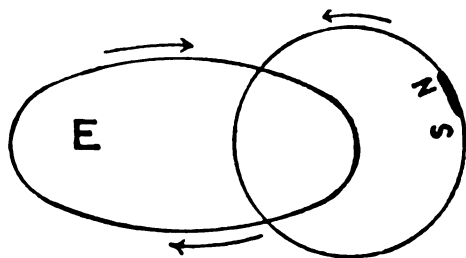

and these two axes of power considered as right lines are perpendicular to each other," etc.

Again in 3267 he adds: "Like electric currents or lines of force, or axes of power when placed side by side attract each other. This is well known and well illustrated when wires carrying such currents are placed parallel to each other. But like magnetic axes of power or lines of force repel each other. The parallel case to that of electric currents is given by placing two magnetic needles side by side with like poles in the same direction."

Then in 3268 he shows that these effects are not merely contrasts, but they are contrasts which coincide when the two axes of power at right angles to each other are considered. Then in 3269 he adds: "The mutual relation of the magnetic lines of force and the electric axis of power has been known since the time of Oersted and Ampère," and further states he is of the opinion that "the magnetic lines have a physical

existence the same as the electric lines," and having that opinion, asks whether "the lines have a dynamic condition analogous to the electric axis to which they are so closely and inevitably associated, or whether they consist in a state of tension of the Aether round the electric axis, and may therefore be considered as static in their nature." Thus Faraday proved the intimate and close relationship that existed between the electric current and the circles which represent the magnetic force in association with that current; and, what is more noticeable, he asks whether such magnetic results are due to a state of tension in the Aether around the axis of the electric current, evidently being of the opinion that the Aether played an important part in the phenomena of magnetism, as well as in electricity, as other parts of his writings abundantly show.

If, therefore, there is this close identity between electricity and magnetism, then in view of the fact that all electricity is due to the motions of the universal Aether, it must follow that all magnetism is also due to motions of the same aetherial medium, which is as universal as it is invisible.

What these motions are has already been indicated by previous statements in this article, being comprised of circular or rotatory motions of the aetherial electric medium about any body, whether that body be an atom, planet, or sun or star. Such a conclusion as this is perfectly in harmony with Maxwell's electro-magnetic theory of light, as the conclusion that he arrived at in that theory was, that the light waves were identical in nature and character with electro-magnetic waves produced by an electro-magnetic source.

Up to the present we have only dealt with the electric character of those waves, and have therefore now to deal with the magnetic character of the same. So that throughout the whole realm of space, and indeed wherever there is Aether, there we have the conditions which give rise to magnetic phenomena, such as those already indicated.

It matters not whether it be in the atomic systems whose combinations comprise all material forms of life with which we are familiar, or whether it is in the systems of planets that revolve around their central sun, or whether it be in the constellations that fill the universe, wherever we find the Aether, there we find the conditions in that Aether which will produce all the results ordinarily produced by magnetism, or with which magnetism is associated, and it is to the application of these phenomena to our solar system that we will now turn our attention.

ART. 87. *The Earth a Magnet.*—If there is any fact in relation to a planet that holds good, it is that the earth, with which

planet we are more intimately associated than any other, is a magnet.

This truth was clearly explained by Dr. Gilbert about the year 1600 in his work on "De Magnete." Not only has the earth geographical North and South poles, but it has also magnetic North and South poles, and indeed has all the phenomena incidental to a magnet, such as magnetic dip and magnetic lines of force, as we shall see later on.

We know, however, that the earth is simply one of a system of planets, which revolves with all the others of that system round its central body the sun; and the question arises, whether the earth is the only one out of all the planets that is actually a magnet. Suppose it is affirmed that the earth is the only planet which is a magnet. On what basis would such a statement be made? The only ground for making such a statement that I can see is, that we have never lived on Mars or Jupiter or Saturn, or any of the other planets, and therefore been unable to experiment on them, which reason is totally insufficient and inadequate for such a conclusion.

If philosophy simply dealt with the results attained by such limited reasoning, then the progress of science would be retarded, and would be limited and confined to actual experience obtained on our own planet and in relation only to that planet. But philosophy is not satisfied with such a narrow and limited outlook, but drawing its conclusions from actual experience on our own planet, in accordance with the rules of philosophy, it seeks to apply such experience gained to the explanation of phenomena of other planets which also revolve round the sun.

By such reasoning we learn that all the other planets have North and South geographical poles like our earth, although we have never actually trodden on those planets, or discovered the poles. We also learn that Mars possesses climatic conditions probably similar to our own earth, as there are certain changes on the surface around the poles, which by analogy we assume to be caused by increase and decrease of snow during the Arctic winter and summer of Mars respectively.

The analogy between our earth and the other planets is very full and complete, as the following results show. Our earth has an atmosphere, so have all the rest of the planets. The earth revolves on its axis from West to East, so do all the rest. The earth possesses two geographical poles, so do all the other planets. The earth revolves round the sun in an orbit of elliptic form, so do the other planets. The earth fulfils all the laws of motion as given by Newton, and all the other planets do the same. The earth fulfils all Kepler's laws, and this is also true of all the others. Indeed, the only difference apparently that

exists at present between the earth and all the other planets is, that our earth is a magnet, while at present it is not conceded that all the others are magnets.

Now such a conclusion I venture to say is altogether opposed to every rule of philosophy. For if experience be any guide in philosophy, then according to experience and observations made in respect to the only planet that we can actually experiment on, it most conclusively follows, that not only the earth, but every planet, and indeed every satellite that revolves round its primary planet, is a magnet; otherwise the rule of philosophy which permits us to formulate hypotheses based on experience is entirely violated, and ceases at once to be an universal rule.

So that either the earth is not a magnet, or else, being a magnet by our second Rule of Philosophy, all the other planets are magnets also. This conclusion has already been arrived at by Lord Kelvin, who in writing in his *Popular Lectures*¹ on the subject says: "If it is true that terrestrial magnetism is a necessary consequence of the magnetism and the rotation of the earth, other bodies comparable in these qualities with the earth, and comparable also with the earth in respect to materials and temperature, such as Venus and Mars, must be magnets, comparable in strength with the earth; and they must have poles similar to the earth, North and South poles on the North and South sides of the equator. It seems probable also that the sun, because of its great mass and its rotation in the same direction as the earth's rotation, is a magnet, with polarities on the North and South sides of the equator, similar to terrestrial North and South magnetic poles." Further, such a conclusion is entirely in harmony with the view of the solar system revealed in Art. 81, where we saw that each planet was an electrified body having its own electric field, with its lines of force, being capable of giving rise to all the phenomena associated with electricity. So that if we combine that view of the subject with the view that we are now coming to, we arrive at the conclusion that each planet and satellite, and indeed all bodies that move or revolve in space, are electro-magnets giving rise to magnetic waves in the Aether, which assumption is fully consistent with the electro-magnetic theory of light.

We must now go one step further and apply a similar line of reasoning to the sun, when we shall arrive at exactly the same result that Lord Kelvin arrived at, according to the previous extract. All planets possess an atmosphere, the sun also possesses an atmosphere. All planets revolve on their axes from West to East, so does the sun. All planets possess a North and South pole the same as the sun.

¹ *Popular Lectures*, Vol. II.

The equatorial diameter of every planet is greater than its polar diameter, and the same truth applies to the sun. It is hotter at the equatorial regions of every planet, and this truth also applies to the sun. Now, if the sun agrees with all the planets in these respects, then we may philosophically conclude that it agrees with them in another respect, viz. that the sun is also a magnet possessing its own magnetic field, which is co-equal and co-extensive with its aetherial electrical field. We have already seen that the sun is an electrified body, possessing its electric field, with its electric lines of force. Therefore the sun is also a magnet, or, to speak more correctly, it is an electro-magnet, and as such gives rise to electro-magnetic waves.

The conclusion to which we have come, that the sun is an electro-magnet, can be arrived at from an altogether different method of reasoning, and as that different method of reasoning will tend to confirm the statement made, I will just indicate it, and then leave it for fuller development in another article.

It is a matter of common knowledge to all students, that the magnetism of the earth varies in several important particulars from time to time. The magnetic poles of the earth do not always occupy the same place in relation to the geographical poles, so that the magnetic force varies as regards intensity or magnitude. The reasons of the variations have never been satisfactorily accounted for, though various hypotheses have been suggested as a solution from time to time.

There is, I believe, only one satisfactory solution to the problem, and that is, that the sun is an electro-magnet, and this conclusion may be arrived at by strictly adhering to Newton's rules of Philosophy. For we have learned that any hypothesis put forward to account for any phenomena, must be simple in character, must agree with experience and observation, and, lastly, must satisfactorily account for the phenomena sought to be explained.

Here then are the variations in time of the magnetic force of the earth, the variations in intensity, and in the inclination of the magnetic axis, together with other variations. What solution shall we offer to such a problem? The only philosophical solution that can be suggested lies in the statement that the sun is an electro-magnet. Such statement is simple in conception, does not violate our experience or observation, as we find a similar revolving body, the earth, which is a magnet; and further, such a statement I premise will satisfactorily account for the whole of the variations and changes in relation to the magnetic forces of the earth. We shall see that this is so when we consider more fully the sun as an electro-magnet. Therefore, apart altogether from any previous analogies, we can philosophically arrive at the

conclusion that the sun is an electro-magnet, as well as all the planets.

That being so, it will possess its magnetic field, its magnetic lines of force, and be capable of bringing into operation in the solar system all the phenomena or effects associated with any ordinary magnet that we may experiment with on the earth.

ART. 88. *The Sun an Electro-magnet.*—If the sun is an electro-magnet, as stated in the previous article, then it is necessary for us to apply the phenomena of magnetism to it in order to ascertain what effect such application will have on the solar system as a whole.

The first thing that we will look at is the magnetic field which is always associated with every magnet. The magnetic field may be defined as that region or space around every magnet in which the magnetic force acts or is in operation. An illustration of a magnetic field may easily be obtained by taking

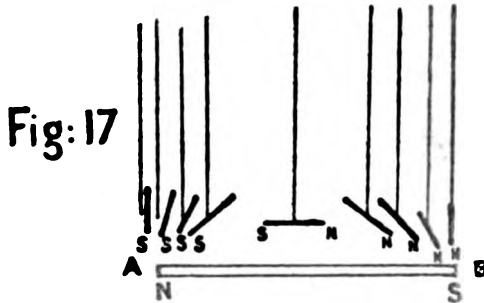

a bar magnet and bringing near to it a magnetized needle, when it will be found that the needle will set itself in various positions relative to the magnet, on account of the lines of force which exist in the field. Thus let AB (Fig. 17) be a bar magnet with its North pole at point A and South pole at point B . If a number of freely suspended needles be hung above it, as shown in the figure, they assume the positions indicated there. It will be seen that at the North and South poles the needles hang vertical, while midway between the two poles there is no dip of the needle, as it is parallel to the bar magnet; while between the place of no dip and the place of vertical dip, which is directly over each pole, the dip gradually changes, becoming more and more vertical as it gets nearer to the pole. If the bar magnet be a strong one, then its magnetic field will be manifested at a great distance; and any magnetized needle brought into the field will be affected by the same, and will tend to set itself along the lines of force.

As already stated in Art. 80, it was Faraday who originated the term "Lines of Force," and gave to the world some idea of the motions of the aetherial medium, which plays so important a part in electro-magnetic phenomena. A visible manifestation of these lines of force which gather round every magnet may be made by strewing iron filings over a piece of glass, underneath which are several bar magnets, when it will be found that the iron filings will set themselves in well-defined lines or curves, which Faraday termed "Lines of Force."

As the bar magnets are placed in different positions, North pole to North pole, or North to South, and so on, the iron filings will change the figures assumed, indicating in each case the effect of the lines of force of each magnet upon one another. The iron filings strewed over the magnet are magnetized by induction, with the result that the North pole of one filing attracts the South pole of the next one to it, and this is continued

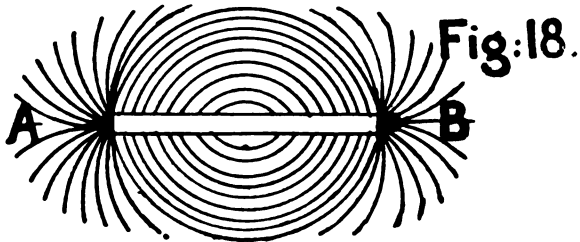

Fig:18.

along the whole of one line of force, as revealed by the united iron filings. Faraday believed in the real physical existence of these lines of force, and that belief has been perfected by Clerk Maxwell in two papers which he wrote on "Physical Lines of Force," which will be considered in another article. We will simply deal with them at present as indications of the existence of the magnetic forces in the medium surrounding any magnet.

Let us apply these facts to the solar system and see what the application yields. We have the sun revolving in the Aether medium represented by the circle *S* in Fig. 19. Then we have the lines of force extending in curved lines *E.* and *W.*, but in almost straight lines North and South. We will suppose the axis of the sun to be vertical for the sake of simplicity. It may be asked, how far will these lines of force stretch out into space? The reply is that they stretch and extend throughout the whole solar system, and far away into the depths of space, though with ever-decreasing intensity according to the law of inverse squares. Wherever the aetherial light waves are manifested, there the

electro-magnetic waves, with all that they imply, are manifested also. We know that the light waves are existent at least as far as Neptune, a distance of 2800 millions of miles, therefore at least to that extent the electro-magnetic waves are manifested; and wherever the electro-magnetic waves to which the sun has given birth are manifested, there we have the existence of the electro-magnetic field, which is co-existent and co-extensive with the electric field of the sun. Further, wherever we get the magnetic field, there we get the lines of force which are as real as air or ocean currents, and are caused, as Maxwell indicated (Art. 44), by the motions of the atomic Aether. Wherever these lines of force are closest together, there the intensity of the magnetic force is at its greatest.

By actual experiment, it can be demonstrated that the lines of force are closest together nearest to the magnet, and therefore

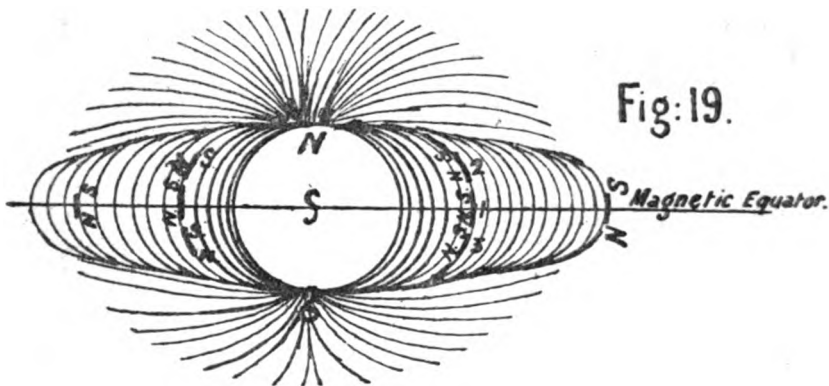

applying that fact to the solar magnetic field, the lines of force should be closest together nearest to the surface of the sun, which is exactly what we have already learned. For if Aether be gravitative, then it will be densest nearest to the sun than further away, and the vortex atoms which represent our aetherial atoms will be pressed more closely together near to the surface than further away.

We have learned that Aether has an electro-magnetic basis, and it is that very fact which gives rise to the existence of these lines of force. So that the magnetic phenomena as indicated in the lines of force conceived by Faraday harmonize with the fact that the sun is an electro-magnet; and that Aether, which has an electro-magnetic basis, is also gravitative, with the result that the lines of force are closest together nearest the surface of the sun, where the magnetic force is greatest in its intensity and power.

Now let us apply the principle of the experiment to the solar system by bringing a magnet into a magnetic field, and let us see what the result is. We have learned from the experiment, that if a magnet is moved along any one of the lines of force the dip of the magnet changes, gradually changing from a horizontal to a perpendicular position in accordance with its relation to the two poles of the magnet. From the previous article we have come to the conclusion that not only is the earth a magnet, but that all the other planets are magnets also, so that if any of these are brought into the magnetic field of the sun, then the magnetic axis of the planet, which corresponds to the needle in our experiment, must assume a certain dip in relation to the sun, setting itself along those lines of force which are in the immediate neighbourhood of the planet.

Let us place the earth, for example, at a distance of 90 millions of miles from the sun in the magnetic equator, or that line which exactly divides the magnetic field into two equal halves. According to our experiment, the magnetic axis will now be exactly parallel with the axis of the sun, that is, exactly vertical, pointing North and South, as seen in position 1 in Fig. 19. But suppose that the earth is to the North of the magnetic equator of the field, what happens then? The result will be that the magnetic axis of the earth will dip towards the magnetic North pole of the sun (position 2, Fig. 19), while if the earth be to the South of the magnetic equator, its axis will dip in the opposite direction (position 3), the magnetic axis setting itself in each case along the lines of force which exist in the Aether in that region or space. Thus it can be seen at a glance, that if the earth changes its position at any time in its orbit in relation to the magnetic equator, such a change will effect the total dip of the magnetic axis. In other words, the magnetic poles which indicate the position of the magnetic axis will not occupy the same position in relation to the geographical North and South poles, sometimes appearing to the East and sometimes to the West, and at other times being coincident with the same as it moves to the North or South of the magnetic equator of the sun's electro-magnetic field.

We have to remember, also, that the earth is constantly varying its distance in relation to the sun, being at a distance of ninety and a half millions of miles at its perihelion, or that part of its orbit nearest to the sun; while it is ninety-four and a half millions of miles at its aphelion, or that part of its orbit furthest away from the sun. This implies that as it proceeds from that point in space furthest away from the sun, and approaches a point nearer to the sun, it will pass into places of greater magnetic intensity, with the result that the intensity of the electro-magnetic waves

is increased; and the magnetism of the earth is accordingly affected by that fact.

When we come to deal with the earth as a magnet more directly, we shall see that all the variations of terrestrial magnetism may be satisfactorily explained by the fact that the sun is, as we have indicated in this article, an electro-magnet, possessing its magnetic field with its lines of force, and therefore able to give rise to all the phenomena incidental to and associated with any ordinary magnet.

ART. 89. *Aether and Faraday's Lines of Force.*—We have now to face the question of the physical character of the Lines of Force conceived by Faraday. We have seen in Fig. 18 illustration of these lines of force, which are manifested by the iron filings in the neighbourhood of a magnet, and the question suggests itself to the mind, as to what is the relation of the Aether to those lines of force? Does the Aether play any part in their existence, and if so what?

Faraday was of the opinion that the Aether did play some part in the existence of the lines, and that they were no mere hypothetical lines, but were caused by the actual physical state or condition of the aetherial medium, which existed around every magnet and every electrified body. On this point he says, Art. 3263:¹ "To acknowledge the action in curved lines seems to me to imply at once that the lines have a physical existence. It may be the vibration of the hypothetical Aether, or a state of tension of that Aether equivalent to either a dynamic or static condition."

Par. 3277: "I conceive that when a magnet is in free space, there is such a medium, magnetically speaking, around it. That a vacuum has its own magnetic relations of attractions and repulsions is manifest from former experimental results (2787). What that surrounding magnetic medium deprived of all material substance may be, I cannot tell, perhaps the Aether."

It was, however, left for Clerk Maxwell to develop the idea as to their physical character, and this he did in his paper on "Physical Lines of Force," *Phil. Mag.*, 1861. He had previously written a paper on "Faraday's Lines of Force," delivered to the Cambridge Phil. Society in 1855 and 1856, but his more matured conception of Faraday's Lines of Force was given in the later article.

What Maxwell did was to conceive a physical theory of electricity and magnetism, by which electrified and magnetized bodies could act upon each other by means of the stress or strain of some medium, which existed in the space surrounding these

¹ *Exp. Res.*

bodies. Now Faraday looked upon electro-static and magnetic induction as always taking place along curved lines. These lines may be conceived as atoms or molecules starting from the poles of a magnet, and acting on all bodies in the electro-magnetic field. These atoms or molecules, joined together in a definite manner, tend to shorten in the direction of their length, that is to say, there is a tension along the lines of force while at the same time they swell out laterally or sideways. Thus there is a tension along the lines of force, and a pressure at right angles to them owing to their bulging out sideways. Maxwell used as an illustration of the tension and pressure, the contraction and thickening of a muscle. As the fibres of the muscle contract, and the arm or leg is drawn up, the muscle swells in its centre outwardly, and so thickens. Thus there would be a tension along the muscle, and a pressure at right angles to it, which would cause any body placed on it to move away from it, owing to the pressure of the contracted muscle.

In the conception of an aetherial atom (Art. 44) drawn purely from observation of the shape of the earth, we came to the conclusion that the aetherial atom was a spherical vortex atom, or, to be more correct, that it was an oblate spheroid with its polar diameter, so to speak, shorter than its equatorial diameter, and further, that the aetherial atom possessed polarity.

Now if we can conceive of these aetherial vortex atoms being joined together, North pole to South pole, and revolving round their axes, we shall then have an exact image of Maxwell's physical conception of Faraday's Lines of Force.

We know that when any liquid body is caused to rotate rapidly about its axis, it will expand laterally and contract longitudinally in the direction of the axis; and it was on this analogy that Maxwell worked out his physical conception of the lines of force. Maxwell's fundamental idea was, that in a magnetic field there is a rotation of the molecule ever going on about the lines of force. For example, let $A B$ be a magnet, and $A C B$ be a line of force composed of spherical vortex atoms joined end to end, that is, each North pole (assuming the vortex atoms to be magnets) being directly associated with the South pole of the one next to it, and *vice versa* (Fig. 20).

Thus it can be readily seen that there will be a tension along the line of force, while there will be a pressure at right angles to it owing to the lateral expansion, partly due to the rotation of the vortex atom, and partly due to the attraction of the vortices for each other in the direction of the line of force.

Maxwell in his paper says: "It appears therefore that the stress in the axis of the line of magnetic force is a tension like that of a rope." Further, he adds: "Let us now suppose that the

phenomena of magnetism depend upon the existence of the tension in the direction of the lines of force, combined with a hydrostatic pressure, or in other words, a pressure greater in the equatorial than in the axial direction. The next question is, What mechanical explanation can we give of these inequalities of pressure in a fluid or mobile medium? The explanation which most readily occurs to the mind is, that the excess of pressure in the equatorial direction arises from the centrifugal force of the vortices or eddies in the medium, having their axes in the direction parallel to the lines of force." He adds: "A medium of this kind filled with molecular vortices, having their axes parallel, differs from an ordinary medium in having different pressures in different directions."

He then goes on to develop the idea in relation to different intensities of the magnetic field. I must, however, refer the

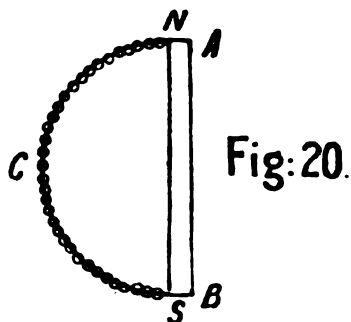

reader to the paper itself for fuller details. In his greatest work,¹ writing on this subject, he says: "I think we have good evidence for the opinion that some phenomenon of rotation is going on in the magnetic field, that this rotation is performed by a great number of very small portions of matter, each rotating on its own axis, being parallel to the direction of the magnetic force, and that the rotations of these different vortices are made to depend on one another by means of some kind of mechanism."

From the foregoing extracts taken from Maxwell's writings, we learn that the constitution of the Aether, as given in Art. 44, exactly coincides with, and satisfactorily fulfils the conditions that he lays down with reference to his physical conception of the lines of force around a magnet or electrified body.

So that the theory of Maxwell is not merely hypothetical, as is suggested by scientists, but exactly describes the conditions

¹ *Magnetism and Electricity.*

and state of the atomic Aether medium which surrounds all magnets. We have, however, seen that the sun is a magnet, and therefore it possesses around it on every side, the same as any other magnet, these aetherial lines of force composed of infinitesimal vortices, or mere whirling points which correspond to an aetherial atom.

These aetherial lines of force stretch out into space on every side of the sun, and in fact form concentric magnetic shells around the sun; which magnetic shells coincide with the equipotential surfaces of the Aether viewed merely from the point of elasticity and density of the medium. We learn by experiment, that these lines are closest together nearest to the magnet, which fact agrees with the statement that Aether is gravitative, and therefore the Aether would be densest nearest the sun. That is, the atoms would be pressed closer together, so that the lines of force of which these atoms are composed ought also to be closer together at the surface of the magnet, which we find by experiment is the case. As the sun is an electro-magnet, therefore, it possesses these magnetic lines of force on all sides, forming a series of magnetic shells. We have now arrived by the aid of Maxwell's theory to a physical conception of the Aether from a magnetic standpoint, which fully agrees with our physical conception of the Aether which was arrived at by purely philosophical reasoning, based on Newton's Rules of Philosophy.

Thus we are able to combine into one whole by our conception that Aether is matter, and therefore atomic and gravitative, not only Faraday's Lines of Force, but also Maxwell's physical conception of the same, apart from the solutions given to the other problems of science by the self-same conception, which solutions will be dealt with in their proper order.

As further evidence of Maxwell's belief in the physical existence of Faraday's Lines of Force, let me again quote from his paper on "Action at a Distance,"¹ already referred to in Art. 43. He writes: "Its minute parts may have rotatory as well as vibratory motions, and the axes of rotation form those lines of Magnetic Force which extend in unbroken continuity into regions which no eye has seen. . . . These lines must *not be regarded as mere mathematical abstractions*. They are the directions in which the medium is exerting tension like that of a rope, or rather like that of our own muscles."

ART. 90. *Terrestrial Magnetism*.—We have already seen that the earth is a magnet, and like any other magnet will therefore possess its magnetic field with its magnetic lines of force. The earth's magnetic field is co-existent and co-equal with its

¹ *Collected Works*, by Niven.

electric field (Art. 80), and that is co-existent with the earth's aetherial atmosphere which is held bound to the planet by the force of gravity.

How far the earth's magnetic field reaches, is impossible to say, but we know that it extends at least as far as 260,000 miles, the distance of the moon; as we find that this satellite of the earth is affected very considerably by the electro-magnetic attractive power of the earth. Any body which is placed in the earth's magnetic field is affected by the lines of force which exist in the magnetic field; for wherever the field exists, there the lines of force exist also.

These lines of force, which are associated with the earth, extend therefore into space, and any body such as the moon would become a magnet, if not already one by the process known as magnetic induction, which physical process is well illustrated in the action of a magnet upon iron filings strewed over it as in the illustration (Art. 88).

An experiment which well illustrates the inductive power of the earth's magnetism, may be made by placing a poker in one of these lines of force, whose direction can be found at any part of the earth's surface by means of proper instruments. When the poker is so placed, it will be seen that it has actually become magnetized by the magnetism of the earth, and it is itself able to attract iron filings or small needles. These lines of force of the earth are closer together nearest to the earth's surface than further away in space, and congregate around the North and South magnetic poles, where they are greatest in number in a given area, and there the magnetic intensity is the greatest.

Faraday, writing on the terrestrial lines of force, says: "The lines of force issue from the earth in the northern and southern parts with different but corresponding degrees of inclination, and incline to, and coalesce with each other over the equatorial parts. There seems reason to believe that the lines of magnetic force which proceed from the earth return to it, but in their circuitous course they may extend through space to a distance of many diameters of the earth, to tens of thousands of miles."¹

From this extract it will be seen that Faraday was of the opinion that the lines of force extended beyond the atmosphere of the earth into the Aether, which statement is confirmed by other parts of his writings; though he was not able to give any physical explanation of how these lines extended beyond the atmosphere on account of the doubtful constitution and character of the Aether, although in another part of his work he definitively refers to the magnetic character of space.

¹ Art. 2850, *Exp. Res.*

In writing on the magnetic character of space he says:¹ "From such experiments, and also from general observations and knowledge, it seems manifest that the lines of magnetic force can traverse pure space, just as gravitating force does, and as static electric forces do (1616), and therefore space has a magnetic character of its own, and one that we shall probably find hereafter to be of the utmost importance in natural phenomena." With the view of the Aether presented in this work, viz. that Aether is matter, though in an infinitely more rarefied and elastic form, we can now see the physical cause of the lines of force with which by his imagination he filled all space.

Again, from the conception of the Aether presented to the reader in Art. 45, we learn that around any body in space there are existing aetherial concentric spheres or shells which are equipotential surfaces, or surfaces of equal pressure, and that these surfaces coincide with the electric equipotential surfaces, as shown in Art. 80.

Not only so, but they coincide with the magnetic shells which the lines of force actually form around a circular and globular magnet, as the earth. For it must not be forgotten that these lines of force exist equally on all sides of the earth, and therefore really form a spherical shell, or to speak more correctly an aetherial electro-magnetic shell, which is an oblate spheroid in shape, partaking of the shape of the earth or other planet which the lines of force surround.

If these shells were divided into two equal halves, the line so dividing them would be called the magnetic equator, and on that line any magnet would set itself in a horizontal position, so that all round the earth on the magnetic equator would correspond to a line of no dip. At the magnetic poles, a magnet would set itself vertically, or at an angle of 90° , and between these two parts, the place of no dip, and that of 90° , the dip gradually changes as illustrated in the figure. Again, in relation to the magnetism of the earth we find that there are certain variations in the magnetic force, which not only influence the dip at any place, but also the intensity at that place. The variations in Magnetic Force are chiefly three—

- 1st. Diurnal Variations.
- 2nd. Annual Variations.
- 3rd. Secular Variations.

Let us look at these three variations from the standpoint of the magnetic lines of force which exist around the earth, and around every planet. In relation to the variations of the magnetic forces upon the surface of the earth, Faraday points

¹ Art. 2757, *Exp. Res.*

out that these variations are caused by the action of the sun's rays upon the terrestrial lines of force. He uses the following figure to illustrate his meaning. Let H be the sun, E the earth—

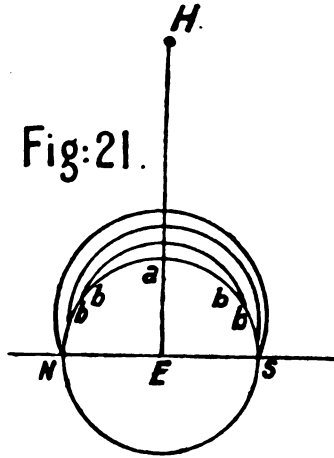

He writes as follows: "If the magnetic and astronomical poles of our earth be supposed to be coincident, then North and South poles will also represent the North and South magnetic poles, and the different curves cutting the earth will sufficiently represent a course of magnetic lines as they occur at, or about, the surface of the earth. H represents the sun, and a the place immediately underneath it, which is also coincident with the magnetic equator. Point a will be a line of no dip, while at point b there will be dip. This dip will be increased by the action of the sun's rays, because the atmosphere under the influence of the sun's rays has expanded the air, and has thus acquired a power to affect the lines of magnetic force."

"All the lines passing through the heated and expanded air will, because of its being a worse magnetic conductor, tend to open out, and the mass of heated air will as a whole assume the condition of diamagnetic polarity (2923). The case may be more simply stated for the facility of recollection by saying, that the effect of the sun is to raise the magnetic circles over the equatorial and neighbouring parts from their normal position, in doing which the North and South dip are simultaneously affected and increased."

Thus it can readily be seen that every day as the earth turns round on its axis, and presents each side of the globe successively

P

to the rays of the sun, there should be a gradual change in the intensity of the terrestrial magnetism. In Art. 2925, Faraday points out that the maximum of dip would be when the sun was at its zenith or directly overhead. With reference to the Annual Variation, Faraday points out (2882) that if the axis of the earth were perpendicular to the plane of its orbit, the intensity and direction of the magnetic forces might be considered constant, but (2883) as the axis of the earth's rotation is inclined 23° to the plane of the ecliptic, the two hemispheres will become alternately warmer and colder than each other, and then a variation in the magnetic condition may arise. The consideration of this annual variation is further considered by Faraday in the subsequent paragraphs to those already quoted, and I must refer the reader to them for fuller details; I wish simply to indicate the possible explanation of the terrestrial magnetism, in so far as that explanation is in conformity with the aspect of the Aether submitted in Chapter IV.

With regard to secular variations Faraday points out (2880) that the temperature of the air at the equatorial parts of the earth is greater than in latitudes north and south, and as an elevation of temperature diminishes the conducting power of magnetism, so the proportion of force passing through those parts ought to be less, and that passing through the cooler parts, greater, than if the temperature were at the same degree over the whole surface of the globe.

Now with our definite conception of the aetherial lines of force traversing space, and existing on all sides of the earth, these suggestions of Faraday's obtain an increased value in relation to the varying intensity of terrestrial magnetism, and will account for the variations in a satisfactory manner from the aetherial standpoint, if taken in conjunction with the electro-magnetic character of the Aether. Of course, what applies to the earth equally applies to all the other planets, as they also are magnets according to Art. 87, so that they will also possess their magnetic fields, with their own lines of force, and their variations in intensity and magnetic dip.

Hitherto we have only considered the problem of the earth and all the other planets, as magnets, from the stationary standpoint, and the problem faces us as to what effect the movement of the earth and all other planets through the Aether will have upon their magnetic fields, and their lines of force. Now from Clerk Maxwell's mathematical calculations, we learn that the movement of any magnetic body through space will practically have no effect upon the relation of the field, and the lines of force to the moving magnet; that is to say, the magnetic field and the lines of force move with the earth and the planets

through space, as they journey round the sun with their varying velocity. Maxwell has conclusively proved that the mathematical equations for moving bodies in relation to their magnetic lines of force, and induction, are exactly the same as the equations for stationary bodies, and if this be true, then it follows that the physical conditions for both stationary and moving bodies are the same.

On this point Maxwell writes: "By its motions this (moving) matter carries with it its lines of force, and electricity and magnetism may be regarded as free ends of these lines. Hence when both causes act together there can be no relative motion of true magnetism with reference to surrounding matter," etc.

"Under these circumstances electricity and magnetism move with the matter in which they are present as if they were indestructible and adhered firmly to the parts thereof." So that from Maxwell's equations and statements we learn that the magnetic lines of force around every planet, and every satellite in space, move with the planets in their orbits round the sun. But as these magnetic lines of force are composed of aetherial atoms, as already indicated, it follows that the Aether which is associated with each planet and held bound to it by the so-called force of gravity moves with the planet also.

This result is entirely consistent with our experience and observation, as we shall see later on. We find that the atmosphere, which is also gravitative, moves with the earth, and therefore from experience we are compelled to arrive at the conclusion that the Aether which is also gravitative moves with each planet, and this result is confirmed by mathematical calculations given by Clerk Maxwell, and is in perfect harmony with the same.

Here then is the key to one of the problems that has been the subject of investigation and research for many years past, and one which is at the present time occupying the attention of some of our most advanced scientists, viz. the relation of the Aether to moving matter.

That problem was solved by Maxwell from an electric and magnetic standpoint, and his result was that the Aether, which we now know to be the source of all electricity and magnetism, moves with the moving matter. What is more, this result has been confirmed by actual experiment made by Michelson and Morley in America, which experiment conclusively proves that Maxwell's result is physically correct, and that the Aether does move through space with its associated planet, and therefore its magnetic field and its lines of force move with it because of the electro-magnetic character of the Aether.

ART. 91. *Solar Magnets*.—We have now to attack the problem as to the cause of all the satellites and planets, together with the

sun, being electro-magnets. What is the continuing and ever-acting cause which makes all planetary bodies, including the sun, their centre, to be permanent magnets? According to the Rules of Philosophy there are two causes which would be simple in conception, which are suggested by experiment and observation, and both causes would satisfactorily account for all the planets being magnets.

The first cause suggested to our minds is, that in view of the fact that the sun is an electro-magnet, and therefore possesses a magnetic field with its aetherial line of force, all the planets may become magnets by the process of magnetic induction, which process has already been illustrated by the action of the iron filings placed over the magnet. Such a hypothesis would fulfil all the Rules of Philosophy, as it would be simple in conception, would not violate experience, and would satisfactorily account for the fact sought to be explained.

But such a hypothesis would be based upon the assumption that the sun was an electro-magnet, and then we should have to find out the cause of that fact also. Hence the hypothesis that the planets are magnets, because they are situated in the magnetic field of the sun, is not a satisfactory solution of the whole problem, as it fails to account for the fact that the sun is also an electro-magnet. We must therefore seek for another solution of the problem, which, while fulfilling all the Rules of Philosophy as laid down in Art. 3, will also account for the sun being an electro-magnet, as well as every planet, satellite, meteor, or any other body that exists in space. If we can ascertain such a cause by philosophical reasoning, then we may say we have satisfactorily solved the problem as to the cause of all planetary and stellar bodies being electro-magnets.

If, at the same time, we can solve other outstanding problems by the solution thus offered, then such solution is more likely to be correct than if it simply solved the problem of solar magnetism. The only other solution that can possibly present itself to our minds, as to the cause of all magnetism in any planet, sun, or star, is the explanation which has already been given in Art. 86 on electro-magnetism.

In that article we learned that magnetism was really due to the circular motion of an electric current; and that, whenever and wherever we had an electric current moving or revolving with a circular motion, there we should always have those conditions which would give rise to an electro-magnet. As long as the current continued to flow in its circular course, so long would there be those conditions which would give rise to permanent magnetism.

Now in the solar system we find that there are these

magnets, which have been in existence for millions of years. We also learn from the electro-magnetic theory of light that Aether has an electro-magnetic basis, which gives rise to electro-magnetic waves when disturbed, or set in motion by any heated or luminous body. It can readily be seen, therefore, that we have only to set this electro-magnetic Aether in circular motion around any planet or sun, and we have at once a circular current of electricity flowing round that planet or sun, which would give rise to those conditions by which any body within its influence may be formed into a magnet.

Our hypothesis, therefore, to explain the reason why all the planets and the sun are magnets, is that the electro-magnetic Aether moves round the sun or planet or satellite as the case may be, thus giving rise to currents of electricity around the planet or sun, and so forming those conditions in the Aether by which the permanency of any planetary or stellar magnetism may be maintained and perpetuated.

In other words, to put it plainly and tersely, each aetherial atmosphere revolves round the planet, subject to certain limitations, in the same way that the aerial atmosphere turns round with the earth, as that planet revolves on its axis. At first sight, such an assumption may seem impossible, but a little careful consideration will show not only the possibility of such a cause, but will establish it, as the only reasonable and philosophical explanation for the phenomena we are seeking to explain, viz. the electro-magnetism of all celestial bodies.

There is nothing extravagant in this assumption, as we already have a similar illustration in the case of the atmosphere which goes round with the earth as it revolves on its axis. We have only to extend the same principle a little further, viz. to the aetherial atmosphere, and we at once get the true physical conception of the hypothesis suggested to explain the magnetism of all celestial bodies. We have already learned that Maxwell has proved that the equations for moving magnetic bodies are the same as those for stationary bodies, from which we came to the conclusion that the electric and magnetic field of any planet goes with that planet as it revolves on its axis in its journey round the sun.

I would like to ask the reader to try to conceive of any electric or magnetic field traversing space in association with any planet or sun which is revolving on its axis, while that electric or magnetic field does not revolve either partially or wholly with the revolving body. The field can only be stationary relatively to the planet or sun, as it revolves with the planet or sun on its axis.

There may be, as there doubtless are, conditions governing

that revolution, as is the case with the atmosphere moving and revolving with the planet, but it is an absolute impossibility for Maxwell's equations relating to moving magnetic bodies to be carried to their logical conclusion, without affirming some such hypothesis as we have affirmed in relation to the cause of all solar magnetism.

Let me at once point out, this solution has already been offered by one whose name has been referred to several times. I refer to Professor Challis. Let us see what he has to say as to the cause of the earth's magnetism. In dealing with this subject, and writing in the *Phil. Mag.*, 1872, par. 42, he states: "With respect to all magnetism which has a cosmical origin, the view I now take is that it is due to gyrations of the Aether, produced by the impulses which it receives from the motions of the constituent atoms of the bodies of the solar system. The gyrations may either be immediately generated by the rotations of the bodies about their axes, or directly result from disturbances of the Aether caused by their motions of translation. This impressed motion will be converted into circulatory or gyrotory motion. Such circulatory motion will necessarily partake of the motion of translation of the bodies which generate them, so as to have always the same geometrical relation to these bodies provided their motion be uniform."

In paragraph 46 he continues: "From what has been already argued (42), the motions impressed on the Aether by the earth in consequence of its rotatory or orbital motions result in circulating motions which would be steady motions, having always the same geometrical relation to the position of the earth's centre."

Again, Ampère and Faraday were also of the opinion that the magnetism of the earth was due to the circulation of electric currents round it, for in par. 446, *Exp. Res.*, Faraday states: "Assuming with Ampère that the magnetism of the earth is due to electric currents circulating round it, parallel to the equator."

I think it will be seen from these extracts that the hypothesis suggested for all planetary and stellar magnetic bodies is thus confirmed by Professor Challis, and by Faraday and Ampère. Professor Challis in these passages clearly and definitely points out that there are circulatory motions in the Aether, which motions are produced by the rotation of the earth or other body on its axis, and that these circular motions of the aetherial medium always maintain the same geometrical shape relative to the earth's centre. So that we have only to combine with his hypothesis the electro-magnetic basis of the Aether, and we at once get the circulating currents of electricity constantly flowing round the heavenly bodies, which produce and give rise to the permanent magnetism of those bodies.

If we desired still further confirmation as to the circulating motions of the Aether caused by a rotating body, we find it in the writings of Herschel, who in relation to this matter asks:¹ "What is the law of density of the resisting medium which surrounds the sun? Is it at rest or in motion? If the latter, in what direction does it move? Circularly round the sun, or traversing space? If circularly, in what plane? Supposing the neighbourhood of the sun to be filled with material fluid, it is not conceivable that the circulation of the planets in it for ages should not have impressed upon it some degree of rotation in their own direction, and this may preserve them from the extreme effects of accumulated resistance!" Words like these from one of the most searching intellects of the last century are well worthy of our consideration, and the suggested effect on the Aether caused by the continued rotation of the earth gives us the key not only to the problem of celestial magnetism, but also to the other outstanding scientific problems.

For example, there is the problem of the relation of moving matter to the Aether around it which still remains unsolved. The physical cause of the rotation of the earth, and all other celestial bodies upon their axes, with unceasing regularity, still remains to be discovered. The physical explanation as to the reason why the earth moves round the sun in its orbit according to Kepler's Laws, has yet to be determined, and, lastly, there is the relation of the magnetic vibration to the electric vibration in connection with the electro-magnetic theory of light still to be solved.

Now, presuming that all these can be solved by the philosophical hypothesis, that the electro-magnetic Aether circulates round each planet and sun and star, that revolves in space, then we are justified in our conclusion that such is the true cause of all electro-magnetism that exists in connection with planetary and stellar bodies. I venture to premise that all these problems can be solved by the simple solution here given, and will prove that this solution adequately accounts for all the other phenomena referred to.

Before proceeding to do this, we will endeavour to prove this hypothesis by an altogether different method of reasoning, in order to confirm the statements made in this article. Let us therefore endeavour to form a complete view of the physical state of the solar system, and for the sake of simplicity we will suppose it to be at rest in space. We shall deal with the effect of its motion upon its own planetary system, when we explain Kepler's Laws.

¹ *Outlines of Astronomy*, Herschel.

We have, therefore, the Sun in the centre (see Fig. 14) of the system, with Mercury, Venus, the Earth, Mars, Jupiter, Saturn, Uranus, and Neptune revolving round the sun at their respective distances, which are subject to variations owing to certain causes which can be satisfactorily explained. But circulating round the sun, in the same direction as the rotation of the sun on its axis, we have the electro-magnetic Aether, with its wide-spreading flow and extensive electro-magnetic field. In like manner, we have each planet with its aetherial electro-magnetic field, which also circulates round each planet in the same direction as the planet revolves, that is, from west to east, and in the same direction as the sun's electro-magnetic field revolves.

Thus we have to picture the whole of the solar system in a state of regular and harmonious rotation, while each planet adds to the harmony of the rotation by itself rotating in its own aetherial electro-magnetic field, while all rotate in the same direction, viz. from west to east.

Of course there are several objections that can be raised to such a hypothesis, and those objections will be briefly dealt with in a subsequent article, but I venture to think that this hypothesis is the true philosophical explanation of a problem which has formed one of the greatest outstanding difficulties in regard to the Aether medium for many years, that problem being the relative motion of the Aether and Matter. Lord Kelvin, in an article in the *Phil. Mag.* for July 1901, entitled "Clouds over the Dynamical Theory of Light," refers to this very difficulty, and states there are two clouds over the present undulatory theory of light, one of which has reference to the difficulty of conceiving a body like the earth or any planet rushing through the Aether without subjecting the Aether to enormous laceration, and concludes by saying that "we must still regard this cloud as very dense." Here, then, is the key to the solution of the problem.

The earth does not rush through the Aether, but the Aether being gravitative, it is associated with and bound to each planet, and accompanies that planet in its journey through space, rotating with it in the same way that the atmosphere does, as we shall prove later on.

This conception is fully in accord with our hypothesis as to the physical explanation of the cause of the electro-magnetic character of all the heavenly bodies, and indeed is the only physical solution that can adequately account for all the varied phenomena hitherto unexplained in connection with the celestial mechanism.

From the foregoing statements, we are now in a position to consider the term Electro-Kinetic Energy, as used by Clerk

Maxwell. What does he mean by Electro-Kinetic Energy? Let us see what he has to say about the term himself.

In par. 636 of his *Magnetism and Electricity* he writes: "According to our hypothesis we assume kinetic energy to exist wherever there is magnetic force, that is, in general, in every part of the field. This energy exists, therefore, in some kind of motion of the matter in every portion of space;" while again, in par. 569, he states: "The electric current cannot be conceived except as a kinetic phenomenon." Even Faraday speaks of the electric current as "something progressive, and not a mere arrangement" (*Exp. Res.* 283).

Then again in par. 552 he writes: "It appears, therefore, that a system containing an electric current is a seat of energy of some kind, and, since we can form no conception of an electric current except as a kinetic phenomenon, its energy must be kinetic energy, that is to say, the energy which a moving body has in virtue of its motion."

Here, therefore, according to Clerk Maxwell, the kinetic energy of an electro-magnetic field is nothing more or less than the energy which a moving body possesses in virtue of its motion. Any other explanation of kinetic energy would be opposed to all the Rules of Philosophy; for experience in its widest form incontrovertibly proves that all kinetic energy is associated, and alone associated, with a moving body; therefore in all electro-magnetic fields there is this kinetic energy ever being manifested. We have, however, learned that the solar system forms a huge electro-magnetic field, traversed by lines of force, as Maxwell and Faraday suggested. Therefore, in the solar system, there must be this kinetic energy due to the motion of a moving body, which is the electro-magnetic Aether.

We have, however, just arrived at the conclusion that in the solar system there is ever going on a circulatory or rotatory movement of the electro-magnetic Aether forming currents around each electro-magnet. On the hypothesis of an atomic and gravitating Aether we have, therefore, a medium or body continually circulating, which medium possesses inertia and momentum, and it is philosophically possible for such a rotating medium to possess kinetic energy. So that our explanation of this term, as used by Clerk Maxwell, is, that this kinetic energy is indeed due to the momentum of the moving Aether. Such a hypothesis is strictly philosophical, and literally fulfils the statements made by Clerk Maxwell himself in the paragraphs already referred to.

A remarkable feature about this hypothesis lies in the fact, that it is the very hypothesis that Von Helmholtz suggested as the explanation of the term. He came to the conclusion that

the kinetic energy was due to the momentum of the moving Aether. But with a frictionless Aether such a hypothesis, although correct, was philosophically untenable. In view of the theory of the Aether presented in this work, however, both Clerk Maxwell's and Von Helmholtz's statements find their literal and perfect fulfilment. So that in an atomic Aether, which is gravitative because atomic, and rotatory because it is gravitative, combined with its electro-magnetic basis as proved by Hertz, we find for the first time a correct philosophical explanation of one of the most puzzling terms used by Maxwell in his greatest work on *Magnetism and Electricity*. This solution alone ought to stamp the theory of an atomic and gravitating electro-magnetic Aether with that authority that is always associated with the names of two such great thinkers and experimentalists as those just mentioned.

The fact that the Aether is held bound to a planet has already been suggested by Sir G. Stokes to account for the aberration of light already referred to. In the *Phil. Mag.*, July 1845, he writes: "I shall suppose that the earth and the planets carry a portion of Aether along with them, so that the Aether close to the surface is at rest relatively to the earth, while its velocity alters as we recede from its surface, till at no great distance it is at rest in space." Sir G. Stokes does not, however, say how the Aether is held bound to the earth, and apart from an Aether which is gravitative, no satisfactory explanation can be given. Further, it is noticeable, that he suggests that the other planets also carry part of the Aether associated with them along with each planet as it pursues its journey. It would be distinctly unphilosophical to assume that the earth was the only planet that carried its aetherial field with it. So that by following Sir G. Stokes' suggestion, we practically arrive at the same conclusion in relation to the motions of the Aether that we have already arrived at from magnetic phenomena.

With this view of the case we are now in a position to answer a question asked by Professor Schuster at the British Association in 1892. He asked, "Is not every large rotating mass a magnet?" and added, "If it is, the sun must be a powerful magnet. The comets' tails, which eclipse observations show stretching out from the sun in all directions, probably consist of electric discharges." Now, in relation to this question, the answer is that every rotating body in the Aether is undoubtedly an electro-magnet. Thus, not only is the sun an electro-magnet, but every planet and satellite, and every meteor that rotates in the electro-magnetic Aether, is converted into a magnet, partly by that rotation, and partly by the currents induced in the Aether by that rotation. We shall also find when we come to

deal with the phenomena of comets' tails, that Professor Schuster is also right as to their cause, and that they are due to electro-magnetic repulsions originated in the Aether by the sun, which is an electro-magnet.

ART. 92. *Cause of Rotation of the Earth on its Axis.*—If there is one fact true in relation to the earth as a planet, it is that the earth rotates on its axis every 24 hours. Day in and day out, for centuries past, this revolution has taken place as the earth journeys in its annual path round the sun.

Not only does the earth rotate on its axis, but every other planet rotates on its axis in varying times, as the following table shows—

	HRS.	MIN.	SEC.
Mercury	24	5	0
Venus	23	24	0
The Earth	23	56	4
Mars	24	37	23
Jupiter	9	55	0
Saturn	10	14	23
Uranus	?		
Neptune	?		

Further, the sun also rotates on its axis in a period of 26 days. Here, then, are certain phenomena in connection with the solar system, for which up to the present no explanation as to the physical cause of rotation has ever been offered. Surely there is some physical cause, to account for such a rotation, and if there be a physical cause, then the problem to be solved is—find the physical cause to account for the continuous and ever-recurring rotation of all the planets and the sun on their axes, which shall be so effective and continual that, year in and year out, the rotation of all the planets may be continued as observed. In solving this problem we have to revert to our reason why the earth is a magnet. In Art. 91 we learned that the earth and all the other planets, and indeed all stellar bodies, were electro-magnets, because the electro-magnetic Aether was constantly circulating round them.

If, by accepting this explanation, we can at the same time solve the problem of the rotation of the planets, and the sun, on their axes, then we shall have further evidence that our hypothesis is the correct one. Now let me ask, What is the effect of an electric current continually circulating round any magnet in the same way that the electro-magnetic Aether continually circulates round the earth, which is a magnet?

To find out what the effect is, we must resort to experiment. Professor Lodge, in his *Modern Views of Electricity*, shows us the effect of any circulating current of electricity revolving round

a magnet. In his chapter on Electro-Magnetism he writes as follows: "How does a current act on a magnetic pole? Two currents attract or repel each other, two poles attract or repel each other, but a current and a pole exert a mutual force which is neither attraction nor repulsion. It is a rotatory force. They tend neither to approach nor to recede, they tend to revolve round each other." "A singular action this and at first sight unique" (p. 135). "The two things will revolve round each other for ever. This affords and has afforded a fine field for the perpetual motionist, and if only the current would maintain itself without a sustaining power, perpetual motion in fact would be attained."

Faraday has shown by experiment the action of a current on the magnet, and *vice versa*. Faraday, in his description of an electro-magnetic apparatus for the exhibition of rotatory motion, shows how the rotation of a current round a magnet, and a magnet round a current, may be experimentally proved. With the apparatus used he shows that the current of electricity may be made to revolve round the pole of the magnet in the direction dependent on the pole used, and further, illustrates how the magnet may be made to revolve round the current. (Plate 4, Fig. 5, *Exp. Res.*)

Thus we learn that wherever we have a current constantly circulating round a magnet, there we have the conditions by which, according to Professor Lodge, perpetual motion may be obtained, that is to say, the two will revolve round each other as long as the current is maintained. Here then we find in space those very conditions by which perpetual motion may be obtained.

We find the electro-magnetic Aether constantly circulating round the planetary magnets, with the result that not only will the current continue to revolve around the planet, but the planet will continue to revolve upon its axis as it revolves round the current. In fact we get in space an example of perpetual motion. We know that the rotation of the earth on its axis has been in existence for several thousand years, and therefore we have a right to assume that it revolved on its axis through the untold ages of past geological times as revealed by the strata, and rocks of pre-historic ages. Thus the motion must have continued, so far as the earth is concerned, at least 100,000,000 years, accepting that period as the age of the earth, but no physical reason so far as I know has ever been assigned for such continued rotation.

If, therefore, it be true that the joint action of a current and a magnet is a rotatory one, then, seeing that in all planetary and stellar space we have both these conditions of matter, that is, the

electro-magnetic aetherial current, constantly circulating round an electro-magnet, we have, in space, the conditions by which perpetual rotation may be maintained. We have therefore presented to us in that joint action, the true cause of the continued rotation of the earth on its axis, and therefore of all the planets on their axes, together with the sun on its axis; and, if we carry the principle into the stellar world, we can philosophically come to the conclusion that the same conditions prevail there that prevail in the solar system, with the result that we have now a physical cause which fully satisfies all Rules of Philosophy to account for certain phenomena which up to the present have never yet been accounted for from the physical standpoint. Thus in solving the problem of the earth's rotation on its axis, we find greater confirmation in the view presented in a previous article as to the circulating motion of the electro-magnetic Aether around any and every body in space. We shall deal again with the relation of a current and a magnet, when we come to the physical explanation of Kepler's Laws.

ART. 93. *Vortex Motion*.—From Art. 91 we have seen that the electro-magnetic Aether possesses a circulating or rotatory motion around each central body, and because of this rotatory motion, the body is at once converted into a magnet. We have also seen that Professor Challis believed in the circulatory or rotatory motion of the Aether, as also did Ampère.

Thus we are led back by scientific experiment and philosophical reasoning to the conception of vortex motion with which the world was familiar in the days of Kepler, Descartes, Huyghens and Bernoulli. There is this difference, however, that whereas the vortex motion of those philosophers was to displace and do away with Gravitation, the circulatory or rotatory Aether suggested by electro-magnetic phenomena is to supplement, confirm and establish more firmly than ever the true powers and laws of Gravitation Attraction.

Before passing, it will be as well to briefly glance at the conception of vortex motion as suggested by Kepler and Descartes and others. Whewell on this matter in his *Inductive Sciences* states that "Kepler assumed that a certain force or virtue resided in the sun by which all bodies within his influence were carried round him. He illustrated the nature of the force in various ways, comparing it to light, and to the magnetic power which it resembles in the circumstances of operating at a distance, and also of exercising a feebler influence as the distance increases." "Another image to which he referred suggested a much more conceivable kind of mechanical action by which the celestial motions might be produced, viz. a current of fluid matter circulating round the sun, and carrying the planets with it like a

boat in a stream." Whewell adds: "A Vortex fluid constantly whirling round the sun, kept in this whirling motion by the sun itself, and carrying the planets round the sun by its revolution, as a whirlpool carries straws, could be readily understood, and though it appears to have been held by Kepler that this current and Vortex were immaterial, he ascribes to it the power of overcoming the inertia of bodies, and of putting them and keeping them in motion."

Now, as we have seen, the electro-magnetic Aether is not immaterial but material, as it is matter possessing mass and inertia, the same as any other matter, as Tyndall and Lord Kelvin stated (Chap. IV.). Thus the objection to Kepler's immaterial vortices is met and overcome by our conception of the Aether (Chap. IV.). Descartes, as Whewell points out, asserted, "that a vacuum in any part of the universe is impossible. The whole universe must be filled with matter, which must be divided into equal angular parts. This matter being in motion, the parts are necessarily grounded into a spherical form, and the corners thus rubbed off, forming a second or subtle matter. There is besides a third kind of matter, of parts more coarse and less fitted for motion. The first part makes the luminous bodies as sun and stars, the second part is the transparent substance of the skies, and the third part is the material of opaque bodies as the earth, planets and comets. We may suppose that the motion of these parts takes the form of revolving circular currents or vortices. By this means the first matter will be collected to the centre of each vortex, while the second or subtle matter surrounds it, and by its centrifugal effect constitutes light. The planets are carried round the sun by the motion of the vortex, each planet being at such distance from the sun as to be in a part of the vortex suitable to its solidity and mobility. The satellites are in like manner carried round their ordinary planets by subordinate vortices."

It would almost seem from this quotation that we had adopted purely and simply Descartes' and Kepler's ideas *in toto*, whereas the truth is that the hypothesis of a rotating electro-magnetic Aether has been arrived at by following Newton's own Rules of Philosophy, and by discarding everything not in harmony with experience and experiment.

Further, Descartes was unable to give, or explain the ellipticity of the orbits of planets, and had to assume that there were elliptic vortices. When we come to deal with Kepler's Laws, and their physical interpretation, the correct solution of this problem will be given from a purely experimental and philosophical standpoint, and in a way and manner never suggested by Descartes or any other believer in the theory of vortices as

then known and understood. Indeed there is no objection to the theory of vortices, which cannot be satisfactorily explained by a rotating electro-magnetic Aether, as we shall see when we deal with Newton's Laws of Motion and Kepler's Laws.

Both Leibnitz and Huyghens were believers in the theory of vortices, and the fact that Huyghens' undulatory theory of light stands to-day as an accepted theory, is conclusive evidence that he was a philosopher of the highest order, and his adhesion to the theory of vortices proves that he was convinced that there was some truth in it.

It is a result greatly to be desired, therefore, if it can be demonstrated, that in the Aether there is this rotatory motion continually going on around every planet, satellite, sun or star ; because it will then join together, in perfect harmony, two great theories in relation to celestial phenomena, that contended with each other for supremacy for very many years.

It will prove that, after all, men like Kepler, Descartes, Huyghens, and Bernoulli had caught glimpses of the great truth which was partly revealed by celestial phenomena, and that it was only for lack of data that they were unable to successfully compete with Newton's mathematical genius, by which he was able to bring his Law of Gravitation safely through the conflict with the simpler conception of aetherial vortex motion. Of course certain objections will have to be met and answered before this aspect of aetherial dynamics can be expected to supplant the more cumbersome and somewhat intricate mathematical laws of motion, but I shall prove later on, that all these objections can be answered from a satisfactory standpoint.

So that if a modified form of aetherial vortex motion can be successfully demonstrated to exist in the electro-magnetic Aether, then we shall see the conflict that waged about two hundred years ago, brought to a satisfactory issue, in the union of the two greatest philosophic theories for the explanation of celestial phenomena that the world has ever seen.

From that union, therefore, there will then emerge a truer, simpler, and yet grander conception of the motions of the universe, which, when perfected by abler minds, will be as perfect a theory as human intelligence and philosophy can make it. So that, what an atomic and gravitative Aether has done for Newton's corpuscular theory of light, in showing that it can be united and combined with the undulatory theory, and by such combination, for the first time, such phenomena as the transverse action of light can be probably demonstrated and explained, together with other phenomena relating to reflection and refraction of light, the enlarged conception of a rotating electro-magnetic Aether will do for the two great theories that vied with

each other for supremacy for so many years. Thus it will be shown that the philosophers like Kepler, Descartes, and Huyghens, the former of whom has stamped his name on the three laws that bear his name to-day, and the latter who gave us the inception of the very theory that overthrew Newton's theory of light, had after all a more or less true philosophic conception of the physical mechanism of the solar system and of the universe at large.

ART. 94. *Relative Motion of Aether and Matter.*—There is hardly any subject of greater importance which is engaging the attention of scientists at the present time, than the question as to what is the relative motion of Matter to the Aether in which it moves.

I venture to premise the successful solution of the problem will be accompanied with the greatest advance to science that has been known for a long time. The problem to be solved may be stated thus: "Does the Aether surrounding a planet or sun or any body in space move with that body, or does it allow the body to pass through it?"

Up to the present, opinions on the subject have been varied and conflicting. Some scientists hold that the planetary and other bodies in space pass through the Aether without disturbing it, while others hold that part of the Aether is carried along by the moving planet. Fresnel assumed that the surrounding Aether was carried along by the earth, so that all relative phenomena would be the same as if the earth were at rest. Fizeau, from experiments which he conducted on running water, also came to the same conclusion.

With the old idea of a frictionless medium, some of the present accepted theories are altogether untenable, because, if Aether is frictionless, how can it be carried along with the moving body, unless it is held bound to that body? and how can it be held bound to that body if it is frictionless?

The whole view of the Aether is, however, changed by the conception of the Aether put forward in Chapter IV. Aether is Matter, and being matter it is also gravitative, and therefore is just as much subject to the Law of Gravitation as any other kind of matter, as Young stated in his Fourth Hypothesis (Art. 45).

We will therefore attack the problem of the relative motion of the earth and the Aether around it from this new standpoint. In order to be strictly philosophical, we must base our hypothesis and conception on experience and observation. Where in the whole of planetary phenomena do we find similar conditions which exist between the Aether and the earth? Such conditions are alone to be found between the atmosphere and the earth.

The analogy between the atmosphere and the earth, and the Aether and the earth is very striking, as the following comparisons will prove.

The atmosphere (when pure) is invisible, so is the Aether. The atmosphere is atomic, the Aether is also atomic. Both are subject to the same laws of elasticity and density, and both are gravitative, according to our conception of the Aether. Now what is the effect of any large revolving body on a liquid or gaseous medium surrounding that revolving body?

If experience is any guide, we learn that the motion of the revolving body is either partially or entirely transmitted to the liquid or gaseous medium surrounding such a body. So far as our experience teaches us anything, it teaches us that to that rule there is no exception, and no experiment can be devised of any body revolving in water or a gaseous medium as air, without that body imparting its rotation to the water or the air. The atmosphere in relation to the earth is no exception to this rule. We know that the earth has an equatorial circumference of about 24,000 miles, and that it revolves on its axis once every day, so that at the equator the surface of the earth is whirling round in space at the rate of 1000 miles per hour.

Try to conceive what the result would be if the atmosphere were stationary at the earth's surface in the equatorial regions. It would mean that any body on its surface would be whirled round at that rate, while the atmosphere, being stationary, would exert a power equal to a wind travelling at the rate of 1000 miles per hour.

Under the influence of such a hurricane, nothing could exist on the surface of the earth at the equator, if the earth revolved on its axis and the atmosphere did not participate in that motion. But the atmosphere is gravitative, and being gravitative, it is not only held bound to the earth as it revolves on its axis in its onward rush through space, but accepts the revolving motion of the earth, with the result that as the earth revolves on its axis, the atmosphere revolves also.

Thus a balloon at the equator if allowed to rise several hundred feet above the surface could remain comparatively stationary if held by a rope to overcome its tendency to rise, whereas such an event would be impossible if the atmosphere failed to receive only half of the motion of the earth's surface, as it would still have a power equal to that of a wind blowing at the rate of 500 miles an hour. If, however, we come further north, or go further south, then we find that the surface of the earth does not have the same velocity as at the equator, with the result that the atmosphere has not the same velocity either; consequently it would travel slower in the temperate regions

than in the equatorial regions, and slower still at the poles than in the temperate regions.

We know by experiment what the effect of increased velocity has upon any whirling body ; it tends to enlarge the body at those parts where the velocity is the greatest, the consequence being that the bulging out of the atmosphere would be greatest at the equator. We find a similar result in the shape of the earth, where the equatorial diameter is greater than the polar diameter, because of the centrifugal force being greatest in the equatorial regions.

We have, therefore, to apply these facts to the aetherial medium which surrounds all planetary and stellar bodies in the same way as the atmosphere does ; and which, being also gravitative, is equally subject to the same laws of motion. We have seen, therefore, that not only does the earth revolve on its axis, but that the atmosphere revolves on its axis also, and that the velocity of its revolution is greatest in the equatorial regions, the atmosphere spreading or bulging out in those parts more than in any other part of the earth's surface.

Let us suppose that the atmosphere extends 200 miles above the earth, and that there we come to the pure Aether of universal space. In view of the fact that Aether is Matter, and therefore gravitative, it is reasonable and logical to conclude that exactly the same result follows in relation to the atmosphere and the Aether at that height, as follows in relation to the earth and the atmosphere 200 miles beneath.

Unless this view is accepted, we should then have our second Rule of Philosophy violated, as we should have matter revolving in more rarefied matter, and failing to impress upon that rarefied condition of matter the motion either partially or wholly which it itself possesses ; and such a result being contradictory to all experience cannot be admitted from a philosophical standpoint.

Therefore, the only solution is, that the rotating atmosphere imparts some of its motion to the aetherial atmosphere, which in its turn rotates, and that that rotation is governed by exactly the same conditions as govern the relation that exists between the earth and the atmosphere. Therefore the Aether in space associated with each planet or satellite or sun or star, rotates with the rotating body, and that rotation imparts to the Aether a greater bulging out in the equatorial regions of the aetherial atmosphere than in any other part thereof. It is interesting in relation to this point to note Herschel's view of the effect of the rotation of any body upon the Aether. In his *Outlines of Astronomy*, in a note, p. 358, he states : "Supposing the neighbourhood of the sun to be filled with a material fluid ; it is not conceivable that the circulation of planets in it for ages

should not have impressed upon it some degree of rotation in their own direction, and this may preserve them from the effects of accumulated resistance."

In this way we arrive at the conception of the motions of the Aether suggested by Prof. Challis from the magnetic character of the earth, which he thought were due to aetherial currents circulating around it, and we learn that such physical conception of the Aether fully agrees with the explanation of celestial bodies being electro-magnets; because, we have only to add to our rotating Aether that which it has been proved to possess, viz. an electro-magnetic basis, and we have at once the currents of electricity circulating round the earth and other planetary or solar bodies, by which is obtained the true explanation of the permanent magnetism of all celestial bodies.

Now to some minds unacquainted with scientific research and knowledge, such a supposition may seem to be incredible, but that incredibility may disappear, when I say that the fact that the Aether is bound to the earth, and goes along through space with it, has actually been proved by some of the most delicate and successful experiments that have been made in recent times: experiments of which Lord Kelvin has stated that he can find no error or flaw in them. I refer to the scientific experiments of Michelson and Morley of America. For full particulars of these experiments I must refer the reader to the *American Journal of Science*, 1886, vol. 31, or to the *Phil. Mag.*, vol. 44.

The conclusion which is arrived at from their experiments is, that the Aether is carried along with the earth as it rushes on its journey through space. Of course such a result is altogether opposed to the ordinary conception of a frictionless medium, and indeed to any conception of the Aether except to that submitted in this work, which is also in harmony with Young's Fourth Hypothesis (Art. 45).

So that Michelson's and Morley's experiment is a direct experimental demonstration of the fact that Aether is gravitative, and because it is gravitative, it is carried along with the earth, as that planet journeys through space. It further conclusively proves that not only is the Aether carried along with the earth, but that the Aether circulates round the earth in the same way that the atmosphere circulates round the earth.

This result naturally follows from the experiment, because, if it were carried along by the earth and yet did not rotate with the atmosphere, then we should have a result opposed to all experience and experiment, as these teach us that when a body revolves in a medium which is held bound to that body by Gravitation, the medium so held bound participates in the rotation of the revolving body.

So that in Michelson's and Morley's experiment we have experimental evidence of the fact, already stated, that the Aether circulates round the earth, and therefore, in view of the electro-magnetic character of the Aether, this circulation results in the production of magnetism in all the planets, and other bodies around which it circulates.

Thus not only does the Aether circulate round the earth, but it also circulates around every other planet, and not only round every other planet, but equally so around every sun and star, as stated in Art. 91.

These results are perfectly consistent with philosophical reasoning, and any other result would be inconsistent with the analogies presented to us by the phenomena of the Aether in relation to our earth as ascertained by experiments made by the scientists referred to. Thus for the first time the experiment is brought into harmony with our Philosophy, which up to the present has not been the case, a result which at once stamps the experiment with that validity of truth and fact which will ultimately win for it universal acceptance and favour.

We are now in a position to answer some queries regarding the motions of the Aether asked by Herschel in his work on *Astronomy*, p. 345. These I give with the answers opposite.

QUERIES.	ANSWERS.
1. What is the law of density of the resisting medium which surrounds the sun ?	The Law of Gravitation (Art. 45).
2. Is it at rest or in motion ?	In motion.
3. If the latter, in what direction does it move ?	Rotates round the sun.
4. Circularly round the sun or traversing space ?	Both, as it circulates round the sun while that body traverses space.
5. If circularly, in what plane ?	The plane of the ecliptic.

ART. 95. *Physical Explanation of the Vibration in the Electro-Magnetic Theory of Light.*—In Art. 78 we learned that light was an electro-magnetic disturbance in the Aether which was propagated through the Aether, with a finite velocity; and from this we gathered that light waves were nothing more or less than electro-magnetic waves, which were radiated from the sun, out into the Aether on every side.

We were unable, however, at that time to give a definite physical conception of the aetherial vibrations, or of the relation of the various types of vibration to each other. Since, however, the

development of the Aether from the electric and magnetic standpoint, which has led us up to the fact that the Aether possesses a circulating motion round the sun (Art. 91), the solution of the problem appears probable. I am of the opinion that the physical conception of the various vibrations to each other is now within the region of possibility, and in this article I wish to endeavour to give what seems to me to be a correct and philosophical explanation of this part of the electro-magnetic theory of light, the physical conception of which up to the present has not been generally understood.

The explanation may, or may not, be fully complete, but even if it be not perfectly correct, I am convinced that it will ultimately lead to a satisfactory physical explanation of this part of Maxwell's Theory of Light. In forming a conception as to the physical character of the vibrations in the electro-magnetic theory, we have to remember that there are three distinct vibrations, or motions, concerned in this theory.

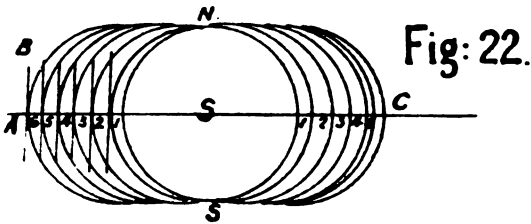

1st. There is the direction of propagation.

2nd. There is the direction of the electric vibration which is at right angles to the direction of propagation.

3rd. There is the direction of the magnetic vibration or motion which is at right angles to both of the other two.

Now we have seen that the direction of propagation of any aetherial light ray, is that of a straight line from the sun corresponding to the radius vector (Art. 76). We have also seen that the front of a light wave is really that of a spherical shell (Art. 71).

We have also learned that the electric and the magnetic vibrations are in the wave front, so that these two vibrations, which are at right angles to each other, are to be found on the surface, so to speak, of each aetherial spherical shell, that surrounds the sun with ever-decreasing density, and ever-decreasing elasticity.

Let us try to picture the actual fact by an illustration. Let S be the sun, with concentric spherical aetherial shells surrounding it (Fig. 22). Then SA and SC will be rays of light being radiated out from the sun, and the magnetic and electric vibrations

have to be both at right angles to the line of propagation and in the wave front; the wave front being represented by the circular lines showing the section of the concentric shells running north and south.

Now how can we picture these two motions at right angles to each other, and yet both at right angles to the line of propagation? First, let us take three straight lines and see how this may be done (Fig. 23).

Let AB , AS be two straight lines at right angles to each other, and AC another straight line at right angles to both. This can only be done by making AC perpendicular to the plane of the paper, and can be illustrated by supposing that it represents a pencil or pen placed upright on the paper, the point of the pencil being at point A . If this be done, then not only will AB and AC be at right angles to each other, but both will be at right angles to AS , which corresponds to the line of propagation.

Now refer to Fig. 22, and we shall see that the line AB and the boundary of the shell will practically correspond. So that

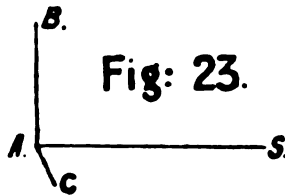

any section of a spherical wave front will always be at right angles to the ray of light. But we have learned from Art. 89 that these sections of the aetherial spherical shell are really identical with Faraday's Lines of Force, with the result that along any line which stretches from the North pole of the sun to the South pole, there will ever be an electric vibration, which is put into motion by the elasticity of the aetherial vortex atoms. So that on every side of the sun there is ever going on this electric vibration, along the lines of force which correspond to a section of the aetherial shell, the surface of which really constitutes the wave front.

Therefore it can readily be seen, that, as these lines are at right angles to the propagation of the ray of light, the electric vibration is at right angles to the lines of propagation, and is thus in accordance with the result demanded by Maxwell's theory.

We have now to give a physical conception of the magnetic vibration or motion of the Aether, and this has to be at right angles to both the electric vibration and the line of propagation.

In Art. 91 we have learned that the Aether possesses a rotatory motion, by which it rotates round the central body of the solar system, the sun. So that if we take any point, for example, in the path of the ray as S_1 , S_2 , S_3 , and S_4 , situated upon some definite equipotential surface or lines of force, and if we will imagine those lines to rotate round the sun, as the sun rotates on its axis, then in time the points will have described half the circle, and will come to the position on the right of the sun indicated by the same Nos. S_1 , S_2 , S_3 , S_4 . Thus there has been an aetherial motion at right angles to the electric motion, as the Aether circulates round the sun, because this motion may be represented as taking place from west to east of the sun, while the electric vibration takes place from north to south, or transverse to the line of propagation.

We have, however, learned that the Aether has an electro-magnetic basis, and therefore the rotation of the Aether gives rise to electro-magnetic currents; hence the motion west to east is really the motion of electro-magnetic currents which circulate round the sun. As these are at right angles to the line of propagation, and we have seen that they are at right angles to the electric vibration, it follows that all three are at right angles to each other, which is in accordance with the requirements as laid down by Maxwell.

We have considered these vibrations, first, from the view of the solar system as a whole in its relation to the universal Aether; but the same principle holds good if considered from the aetherial atomic standpoint. For if we take a line of force, composed as it is of aetherial vortex atoms, and suppose them to be rotating, we know that by that rotation there will be a tension due to that rotation, and Maxwell has shown this tension is due to magnetism, as in his standard work he says: "This magnetic force is the effect of the Centrifugal Force of the Vortices."

So that by postulating a rotatory movement for the Aether around the sun, as we have done in Art. 92, we have not only solved the problem of all planetary and solar magnetism, but we have also solved the problem of the relative motion of the Aether and the earth, and also given for the first time (though it may be in an incomplete form) a physical explanation of that part of the electro-magnetic theory of light, which has hitherto been unexplained from the purely physical standpoint.

Such results, therefore, supported as they are by the direct experiment of Michelson and Morley of America, justify us in concluding that the conception of a rotating Aether is not only philosophically correct, but is in actual accord with experimental investigation and research, as indeed it ought to be.

CHAPTER X

ÆTHER AND NEWTON'S LAWS OF MOTION

ART. 96. *Centrifugal Force*.—Before proceeding to apply some of the principles and laws which govern the electromagnetic ætherial medium to solar and stellar phenomena, it will be as well just to review the conception of our new ætherial Centrifugal Force, so that we may form a right view of it in its completeness and entirety.

In Art. 11 we premised that there was in existence another force, which was the exact opposite of the centripetal force, and that this force was the complementary and counterpart of the centripetal force or Gravitation Attraction ; and further, that this force was due to the motion of the universal Æther which filled all space.

In Art. 13 we saw that all force resolved itself into energy of some kind, the same being due either to potential energy, *i. e.* energy of position, or to kinetic energy, which is the energy belonging to matter actually in motion. From Art. 56 we learned that all energy was energy of motion, so that all force resolves itself into motion of some kind.

Thus our term Centrifugal Force really implies, and demands, a motion of the Æther which is ever directed away from the centre of gravity of any body, whether that body be an atom or molecule, satellite or planet, sun or star. From the phenomena of heat we have seen that there exists a repulsive motion, due to the ætherial medium, which is ever exerted from the central body of any atomic, planetary or stellar system, that repulsive motion being due to the pressure of the universal Æther, which not only surrounds all atoms, but also surrounds all other bodies in the universe.

From the phenomena of light we have also seen that the Æther possesses a repulsive or centrifugal motion, which is also due to the pressure of the same Æther as mathematically proved by Maxwell, and experimentally proved by Prof. Lebedew, and Nichols and Hull of America. Further, from the phenomena of electricity, we have also seen that there exists this centrifugal motion, due to the pressure of the same ætherial medium, which

pressure is ever directed away from the electrified body, as the sun or planets.

So that from these three phases of the universal Aether, that is, from its thermal or heat manifestation, its luminiferous or light manifestation, and its electro-magnetic manifestation, we get irrefutable evidence of the existence of a centrifugal motion, which motion is ever directed away from the central body ; and the result of that motion takes the form of a pressure upon any body with which the motion comes into contact.

Again, it was premised, that such a centrifugal force or motion must fulfil all the laws which governed the centripetal force or motion.

First, it had to be universal (Art. 19). Second, it had to follow exactly the same path as the centripetal force or motion, which was that of a straight line joining the centre of gravity of two bodies, as for example the earth and the sun (Art. 20). Third, the centrifugal force or motion must be equal to the product of the masses, in the same way that the centripetal force was governed by such a law (Art. 21). Fourth, its intensity was to be governed by the law of inverse squares, the same as the centripetal force or Gravitation Attraction was governed (Art. 22).

Now all these conditions are satisfactorily fulfilled, and have been shown to be satisfactorily fulfilled, from the phenomena of heat, light, and electricity in their relation to the universal Aether. For in Art. 43 we saw that the Aether was universal, and therefore if the centrifugal motion is produced and originated by the Aether, then such motions must be as universal as that medium, which under qualifying conditions gives rise to these motions.

From Arts. 65 and 76 we have learned that the path of this centrifugal motion is that of a straight line, and follows exactly the same path that the centripetal force of gravity takes. In Art. 85 we learned that the centrifugal force between any two bodies was equal to the product of their masses, which is exactly the same as the centripetal force that exists between any two bodies ; and, lastly, from the phenomena of heat, light, and electricity we learned that the intensity of this centrifugal motion due to aetherial pressure was inversely as the square of the distance, which is the law governing the intensity of its counterpart, the centripetal force. Thus we have learned that there is in existence throughout universal space, a physical force or motion due to a physical medium, the universal Aether, which force or motion is the exact opposite of the centripetal force or Gravitation Attraction, which may be stated as follows—

Every particle in the universe repels every other particle with

a force whose direction is in the line joining the centres of gravity of the two bodies, and whose magnitude is directly as the product of their masses, and inversely as the square of the distance between them, at their mean distances.

We shall see that it is by the conjoint working of these two forces, the Centripetal and Centrifugal, in combination with other motions of the Aether, that the harmonious working of the whole celestial mechanism is maintained and perpetuated. In confirmation of the existence of the centrifugal force, I should like to draw the attention of the reader to certain phenomena relative to the solar system, which phenomena violate the centripetal force as at present recognized, and can alone be accounted for by the existence of another force or motion existing in space, such as the centrifugal motion already proved and demonstrated.

We know that the law governing the centripetal force, or Gravitation Attraction, is regulated by the product of the masses of the two attracting bodies. So that if there were three bodies in space whose masses are respectively represented by 2, 3 and 100, the proportion of the attractive force of gravitation between the largest and the other two, would be 200 (100×2) and 300 (100×3) respectively. So that if the centripetal force, or the Attraction of Gravitation, is the only governing force in the universe, then it naturally follows that the two bodies, between which the attractive force is greater, will be closer together than the two bodies between which the attractive force is less.

Thus the two bodies, whose product of their masses is represented by 300, will, according to the Law of Gravitation, be closer together than the two bodies, the product of whose masses is represented by only 200. Unless this is so, we should have a violation of the Law of Gravitation, and it would at once cease to be a law.

Let us therefore apply the centripetal force, or Gravitation Attraction, to the solar system, and see how it works out. The law strictly defined is given in Art. 18, from which we learn that the attractive force between two bodies is as the product of their masses. Now what are the masses of some of the bodies in the solar system?

We find that the sun, with its diameter of 865,000 miles, is about 324,000 times greater in mass than our earth, so that it would take about 324,000 bodies of the size and density of our earth to equal a body of the size and density of the sun. It has been calculated, however, by Von Asten, from observations made on comets by the planet Mercury, that the mass of Mercury is about $\frac{1}{24}$ of the mass of the Earth. Therefore the mass of the sun must exceed the mass of Mercury $324,000 \times 24 = 7,776,000$; the exact relation according to Von Asten is 7,636,440. Again,

the planet Jupiter, with its diameter of 85,000 miles and its density of 1.38, is only $\frac{1}{1048}$ part of the mass of the sun, so that it would take about 1048 Jupiters to equal the mass of the sun, therefore Jupiter must weigh about 7400 times the mass of Mercury.

If the mass of Mercury, therefore, be represented by 1, the mass of the Earth would be represented by 24, the mass of Jupiter by 7400, and the mass of the sun by 7,636,400. So that the attractive forces between the planets as regards their masses only will be represented numerically as follows—

Sun and Mercury	$7,636,400 \times 1$	=	7,636,400.
Sun and Earth	$7,636,400 \times 24$	=	190,008,000.
Sun and Jupiter	$7,636,400 \times 7,400$	=	56,435,360,000.

Thus we see that the attractive force between the sun and the earth exceeds 24 times the attractive force between the sun and Mercury, while the attractive force of gravity between the sun and Jupiter is 7400 times greater than the attractive force between the sun and Mercury, relative to their masses.

Therefore, according to the Law of Gravity, as regards the masses of bodies, Jupiter and the sun should be nearer together than Mercury and the sun, because their attractive powers are greater, and the earth and the sun should be nearer together than Mercury and the sun, because their joint attractive powers are also greater. In the same way it can be proved that all the other planets whose masses are greater than Mercury ought, according to the Law of Gravity in regard to masses only, to be nearer to the sun than what Mercury is, simply because the total attractive forces between any two are greater than the attractive force between Mercury and the sun.

The respective masses of the planets compared with the sun, taking the mass of the sun as unity, are as follows—

Jupiter	$\frac{1}{1,048}$	of mass of sun.
Saturn	$\frac{1}{3,529}$	" "
Neptune	$\frac{1}{18,520}$	" "
Uranus	$\frac{1}{22,020}$	" "
Earth	$\frac{1}{324,439}$	" "
Venus	$\frac{1}{397,000}$	" "

Mars	$\frac{1}{2,994,790}$	of mass of sun.
Mercury	$\frac{1}{7,636,440}$	" "

Therefore, if the total attractive force of gravity is equal to the product of the masses of any two bodies, then the planets ought to be in the following order in relation to their distance from the sun : Jupiter, first, followed by Saturn, Neptune, Uranus, Earth, Venus, Mars and Mercury ; that being the order in which the attractive power of gravity is regulated by their respective masses.

Yet the very opposite is nearly the case, as we find that some of the further planets, as Jupiter, Saturn, Uranus and Neptune, possess greater masses than any of the nearer planets ; so that here we have a distinct violation of the Law of Gravitation Attraction, which states that the attraction between any two bodies is directly as the product of their masses, because we find certain bodies with greater attracting powers further away from the sun, than other planets possessing less attracting powers, because of their smaller masses. I cannot recall having ever read of any explanation which has been given for such an anomaly, and indeed this apparent violation admits of no other explanation than the conception of the dual character of the so-called Law of Universal Gravitation, which includes a repelling or repulsive force or motion, such motion being due to the pressure of the universal Aether.

Thus in the light of the centrifugal motion, combined with the fact that Aether is gravitative, by which each body possesses an aetherial atmosphere and electrical equivalent proportionate to its mass, it can be demonstrated within a reasonable limit how it is that such planets as Jupiter, Saturn, Uranus, Neptune, possessing aetherial atmospheres and electrical equivalents proportionate to their masses, revolve in orbits round the sun at much greater distances than Mercury, Venus, the Earth, or Mars. This explanation will follow as we consider the Centrifugal Force and the Centripetal Force in their relation to Newton's Laws of Motion.

ART. 97. *Centripetal Force*.—We have now to apply the Centripetal Force, together with the new Aetherial Centrifugal Force, to the solar system, and show that by their conjoint working taken in conjunction with the motions of the Aether, all celestial phenomena may be satisfactorily explained on a physical basis, in a similar way that Newton proved the same result from the mathematical standpoint.

We saw in Art. 10 that the centripetal force was really none

other than the Attraction of Gravitation, in that it always acted to a centre, and in no other way, and therefore by the centripetal force for the present we must understand is meant the attractive power of Gravitation.

Afterwards, when it has been demonstrated that the centripetal force and the new aetherial centrifugal force can account for all celestial phenomena, then we shall be in a position to show what the physical cause of the centripetal force is.

Let us again refer to the centripetal force, so that we may see exactly what its governing conditions are. In Art. 18 we learned that this force might be thus expressed: "Every particle of matter in the universe attracts every other particle with a force whose direction is that of a line joining their centres of gravity, and whose magnitude is directly as the product of their masses, and inversely as the square of the distance between them." Now we have seen from the previous Art. that the centrifugal force due to the pressure of the Aether medium is the exact counterpart of this, in every way, so that if we combine the two, we get the complete statement of the universal law which governs all matter, and which we may define as follows—

"Every particle in the universe attracts and repels every other particle in the universe with a force whose direction is that of a line joining their centres of gravity, and whose magnitude is directly as the product of their masses, and inversely as the square of the distance between them." This complete law, however, only holds good when the two forces are in equilibrium.

With this conception of the universal law which governs all matter, the harmony and stability of the universe becomes possible from the physical standpoint. Apart from this conjoint working of the two forces or motions, a physical explanation of Universal Gravitation is impossible, as with one force operating only throughout the universe, ultimate stability is inconceivable, and the harmony of the spheres might at any time be suddenly destroyed.

With this conception of the universal law which governs all matter, the great Law of Gravitation is brought into harmony with all experience and observation. Look where we will, or at what we will, there we find forces possessing a dual character, as we have already seen proved. Professor Tyndall, as we have already learned (Art. 63), definitely states that the stability of atomic systems is preserved by the existence and operation of *two forces, one attractive and the other repulsive*, and what is true of the atomic world is equally true of solar or stellar worlds. Thus for the first time in this respect, our philosophy agrees with our experience, and the true relation of the centrifugal force or motion to the centripetal force is made manifest. So

that, wherever in the solar system the centripetal force or Gravitation Attraction operates, there, with exactly equal intensity and power, the aetherial centrifugal force operates, at the respective mean distances of the planets and satellites, where the two forces are in equilibrium.

If it were possible to conceive of a stationary solar system, then, by the conjoint working of the two forces, it would be equally possible to conceive of perfect stability and harmony existing between the respective planets and satellites of that system while stationary.

Such a conception is altogether impossible in the present state of Philosophy, as the stability of the system, with the old view of the Centrifugal Force, is entirely dependent upon the motions of the respective bodies in that system ; and if such orbital motions could be stayed, then the only physical conception possible would be, that every planet and satellite, planetoid and meteor within the attractive force of the central body, the sun, would be slowly but surely drawn to a fiery death, as they would all ultimately be attracted and swallowed up by the sun.

Thus we learn, that while the sun is the centre of a centripetal force, which ever operates far and wide throughout space, it is equally the centre of a repulsive or centrifugal force or motion which also operates co-extensively and co-equally with the former.

Not only so, but every planet and satellite, nay every particle and every atom, while it is the centre of a centripetal force, is also the centre of a repulsive force, as pointed out by Professor Tyndall, which force is due in each and every case to the pressure of the aetherial atmosphere which surrounds the atom or molecule, satellite or planet. Thus the physical conception of heat in its effect on molecules having a repulsive force (Art. 63) is confirmed, and that that force is due to the pressure of the Aether is also confirmed by subsequent investigations into the phenomena of light and electricity, by which we have arrived at our physical conception of the Universal Centrifugal Force.

So that we have now a physical conception of the experiment performed by Nichols and Hull of America, and by Professor Lebedew of Russia, in which they conclusively demonstrated the existence of the pressure of aetherial light waves, which proves beyond the possibility of doubt the existence of this physical centrifugal force. Every atom and molecule, therefore, is the centre of two forces, which co-exist together, and every meteor and satellite and every planet is also the centre of the same two forces, and this we shall find in its application to planetary phenomena will have a most important bearing on the physical conception of those phenomena. Thus it is the Aether medium,

by its energy of motions, that constitutes the companion and complementary force to Gravitation Attraction, and which, as we shall see later, is the medium which forms the physical basis of that attraction also. It is, then, by the combined and harmonious working of these two co-equal, co-existent, and co-extensive forces that worlds roll and rush, sweep and swing, move and rotate about their respective centres ; and, by these two forces working in perfect harmony, that that order and stability are produced, which everywhere pervade the universe of worlds, and form them in their entirety into one grand, ultimate, and harmonious system.

To develop and prove this fact, by explaining their manner and mode of working, we shall now proceed to consider Newton's Laws of Motion, and their relation to the aetherial medium, and by so doing shall be able to show the unmistakable reality and complete efficiency of this physical conception of the Aether medium, which forms the physical basis of all universal motion and phenomena.

ART. 98. *Newton's First Law of Motion.*—We will now apply the centrifugal and centripetal forces to Newton's Laws of Motion, and endeavour to form a physical conception of the same from the aetherial standpoint. Before doing so, we must recall some of the statements made in Art. 14 with reference to the First Law of Motion.

It will be remembered that we divided the First Law of Motion into two parts : 1st, "Every body continues in a state of rest except in so far as it is compelled by impressed forces, *i. e.* impulses or motions, to change that state." This we saw agreed with our experience, and therefore was philosophically correct, and must hold good in its application to the centrifugal and centripetal forces of the Aether in their effect upon any body in space.

Let us proceed to apply the First Law of Motion to the planetary world. We have seen in the previous Art. so far as the distances of the planets are concerned in their relation to the sun, that the Law of Gravity is violated, and that planetary distance is not regulated by the law governing the centripetal force of Gravitation, otherwise the planets possessing the largest masses would be nearer to the sun than those possessing smaller masses.

The question arises, as to whether there is any law which governs planetary distance, by which the distance of any planet was regulated at the birth or creation of the solar system. It has been assumed by some scientists that planetary density is the regulating factor which determines the relative distance of the respective planets from their central body, the sun, but such

an assumption is not consistent with scientific data. For we find that Venus, with a density of 4.81 compared with water, occupies a nearer position than the Earth with a density of 5.66, whereas the reverse should be the case if the density of a planet were the deciding factor in regulating a planet's distance.

Again, we find Saturn, which possesses a density of .75, occupying a nearer position to the sun than Uranus, which possesses a density of 1.28; so that here again, if density were the regulating factor which decided planetary distance, such a law is violated. According to the various densities of the planets, the respective positions of the planets in relation to the sun would be as follows: The nearest planet would be Mercury, which possesses a density of 6.85. This would be followed by the Earth, with a density of 5.66. Then Venus would come next, with a density of 4.81, followed by Mars, with a density of 4.01. After these we should have Jupiter, whose density is 1.38, with Uranus, whose density is 1.28, followed by Neptune possessing a density of 1.15, and Saturn would take Neptune's place, as it possesses the least density of all, its density being only .75. So that it is manifest, that density cannot be the governing condition, as has been proved in the previous article.

Now, if all the planets ever formed part of the sun, and they were hurled off into space by the centrifugal motion of the Aether, then there certainly would be some law which governs the relative distance of the various planets; but as far as we can see, there is no such law, as a law which is violated ceases to be a law, so that the law of masses or densities of a planet, governing their distances, has no place in the solar system.

This leads up to the question as to whether the planets ever did form part of the sun, as is generally supposed; and, in view of the fact that there is no law by which planetary distances are regulated, we are compelled to come to the conclusion that each planet and satellite once existed in an aetherial condition in space, and that it was by the condensation of that Aether, that each planet was formed; and that, at its birth, each planet occupied the relative distance from the sun which it occupies to-day.

At first sight this may appear startling, but I would ask the reader how he can account otherwise for the great irregularity which exists in the distances of the planets in their relation to the sun, as every known law which governs masses and density seems to be altogether set at defiance.

I hope to prove later on, that all matter has an aetherial origin, and if that be correct, then the origin of a planet briefly outlined can be accepted without violating the results of experience or experiment, and to that extent will be philosophically correct.

Dr. Larmor speaks of the aetherial constitution of matter, and refers to the views of Faraday and Davy in support of such a theory, while Lord Kelvin has referred to the same principle in an article on the "Condensation of Gravitational Matter in any part of the Universe" (*Phil. Mag.*, July 1902). So that if it be possible for Aether to be condensed, and so form the nucleus of a planet or satellite, then, seeing that the Aether is universal, any planet or satellite or meteor may be formed in any part of the solar system; and the process has only to be continued, until we have planets of various sizes at various distances from the central body, the sun.

Here, therefore, at any rate, is a physical hypothesis which will satisfactorily account for all the different distances of the various planets. Apart from some such hypothesis, I fail to see how we can account for the irregularity that exists between planetary distances, when viewed from the standpoint of their masses and their densities.

Further, such a conception is entirely in harmony with the view of the dual character of the motions or powers of the aetherial medium, that would co-exist with the evolution and development of the planet. For, as the planet was evolved and developed from the aetherial medium which surrounded it on every side, two motions would be developed and grow with it—the centrifugal force or motion, and the centripetal motion of the Aether, or the attractive force known as Gravity. Thus, through all the growth and development of a planet, these two powers, the centripetal force and the centrifugal force, would be co-equal and co-existent.

The same truth applies to the sun or any other body in the universe; so that, if a planet, as the Earth, was formed in the beginning at its mean distance of 92,700,000 miles, then the joint centripetal motions produced by the Earth and sun in the Aether, would always equal the joint centrifugal motions produced by the same two bodies, simply because the two laws are the exact opposite of each other both in regard to intensity, distance, and magnitude.

Thus the Earth would always occupy its relative position in relation to the sun that it occupies to-day, as long as the two aetherial forces or motions, the centripetal and the centrifugal, exist. With this brief outline of a planet's history, we are now in a position to form a physical picture of the solar system when it first existed in the beginning.

We find the sun then occupying its centre. At various distances, we find the various planets situated without any regard to their relative masses or densities, as the following table shows. (The mass of sun is taken as unity.)

R

	MEAN DISTANCE.	MASS.	DENSITY.
Mercury	35,900,000	7,853 $\frac{1}{2}$,440	6.85
Venus	67,000,000	337,000	4.81
Earth	92,700,000	334,433	5.66
Mars	141,000,000	2,533 $\frac{1}{2}$,730	4.01
Jupiter	482,000,000	1,048	1.38
Saturn	884,000,000	3,333	.75
Uranus	1,780,000,000	32,033	1.28
Neptune	2,780,000,000	18,333	1.15

Now, in order for any of these planets to fulfil Newton's First Law of Motion, the sun, which occupies the centre of the solar system, must be assumed to have no rotatory or orbital motion of its own; because, so long as it has a rotatory motion on its axis, or an orbital motion of its own through space, so long will even the first part of Newton's First Law of Motion be inapplicable to the solar system.

But if the sun can be assumed to possess at some point in its history no orbital motion, or rotatory motion on its axis, then the physical interpretation of the first law of motion can be physically conceived, and a planet at rest will remain at rest relatively to its central body, the sun, for ever.

Let us take the sun and Mercury as an example of the effect of the two motions operating in the aetherial medium. We will consider first the effect of the centrifugal motion. The sun, with its huge form, occupies the centre of the solar system, while Mercury has its mean distance about 36,000,000 miles away.

The solar fires are intensely burning, and every atom and every particle composing them are excited thereby into the most intense activity, and by their energy of motion create myriads upon myriads of waves in the surrounding Aether, which flow away on every side with the velocity of light.

With such velocity are they generated, that they speed across the distance of 36,000,000 miles which exist between Mercury and the sun in the short time of about three minutes, and if it were not for the aetherial and aerial atmosphere of the planet, would fall upon the surface of Mercury with an intensity of heat that would scorch up all vegetable life, if any existed thereon.

Now let us for a moment ignore the existence of the centripetal force, and then in that light view the influence of the electromagnetic Aether waves upon Mercury. We have seen that when aetherial light waves come into contact with any body, they exert a pressure upon that body (Art. 77), so that under the influence of the centrifugal force only, Mercury would be borne away from its central body, the sun, with a power and energy of motion entirely dependent upon the intensity of the

electro-magnetic Aether waves which give rise to the centrifugal force.

Thus Mercury would be carried away from the sun, far far away into the depths of space, with ever-decreasing rapidity, the rapidity of its motion through space being entirely dependent upon the intensity and energy of the Aether waves; and, as that intensity varies inversely as the square of the distance from the central body, the sun, so the impelling and repelling energy of the Aetherial waves would vary inversely as the square of the distance from the central body.

Thus the motion of Mercury or any other planet through space would not be uniform, but would gradually decrease, and such a result is perfectly in harmony with all experience and experiment in relation to moving bodies on this earth.

This effect of the Aetherial electro-magnetic light waves upon a planet is in harmony with Newton's nineteenth query in *Optics*, and is indeed the physical illustration of that query in its corrected form which we have already referred to in Art. 46, where Newton says: "Doth it (Aether) not grow denser and denser, etc.; every body endeavouring to go from the denser parts of the medium towards the rarer?"

That the Aether does grow denser and denser nearer to a body we have already seen in Art. 46, and now we learn that a body, when under the influence of the centrifugal force only, would pass from the denser parts of a medium to the rarer parts, as suggested by Newton. We will now suppose that Mercury has been repelled, by the pressure due to the aetherial waves generated by the sun, to the distance of Neptune, a distance of 2,780,000,000 miles; and that at this point the centrifugal force is cancelled, and in its place is put the centripetal force of Gravitation. What will be the effect upon Mercury then? At first sight the effect will be exceedingly slight, but slowly, yet surely, the attractive power of the sun would begin to make itself manifest, and we should find Mercury retracing its path along exactly the same straight line that it had taken in its outward journey.

Not only so, but its motion would be accelerated just in the same proportion that it had decreased on its outward journey. On and on through the intervening space the planet would rush, and if there were no centrifugal force in existence, the planet would ultimately rush into the central body, the sun, and being swallowed up by it, would maintain for a time the heat thereof.

Let us now view the case from the conjoint working of these forces, or motions, the centripetal and centrifugal, and we shall see, that under certain conditions it is possible to conceive physically of a planet being in a state of rest as stated in

Newton's First Law of Motion, and also remaining in that state of rest, until it is compelled by other forces or motions to change that state. Mercury is now situated at its mean distance of about 36,000,000 miles. At the same instant let both the centrifugal and the centripetal forces or motions be applied to it, and to the sun. What is the result of such application? Will the planet move nearer the sun, which we are supposing to be perfectly at rest, or will it be urged further away? The effect is nil! for the simple reason, that when we set in motion the centripetal force of Gravitation, at exactly the same time we set in motion an exactly opposite force which is the exact complement and counterpart of the other, so that they exactly counterbalance each other, and Mercury under the influence of both forces still retains its mean position of 36,000,000 miles; and, until we either set the sun rotating, or give it a motion of its own through space, Mercury would remain at its distance of 36,000,000 miles comparatively at rest. The same reasoning may be applied to all the other planets, in relation to their mean distances, with the result that they too would remain in a comparative state of rest, so long as they were only under the influence of the two forces or motions, viz. the centrifugal and centripetal.

Each of these, being the exact complement and counterpart of the other, when applied together to any planet of any size or mass or density, at any distance, fails to affect the distance of that planet in its relation to the sun, but simply establishes it in that distance, subject to certain regulations dependent upon other motions of the sun, and the ætherial medium in which they exist. Thus we learn, that if, in the beginning, Mercury were formed at a distance of 36,000,000 miles, it would for ever remain at that distance; and the same is true of the other planets at their mean distances, no matter what their mass or density may be; and that, according to the first law of motion, the planet would remain in a state of rest until compelled by other forces or motions to change that state, when it would continue moving with uniform motion so long as the motive power applied was uniform.

If, however, the motive power applied was not uniform, then the result would be an increase or decrease of the planet's motion, just in proportion to the increase or decrease of the motive power. This result is in perfect harmony with our statement in Art. 15, and is in accordance with observation and experience.

ART. 99. *Second Law of Motion.*—According to Newton's Second Law of Motion, "Change of motion is proportional to the impressed force, and takes place in the direction in which the force is impressed."

From a consideration of this Law (Art. 15) we saw that the

impressed force was a compound quantity, being regulated by the mass of the moving body which exerted the impressed force, and that it was also proportionate to the velocity of the moving body; so that if either of these quantities are changed, the total impressed force would be changed also.

We have now to show that our aetherial medium agrees with this second law of motion in so far as the second law of motion agrees with experience and experiments. To do this, we must review our conception of the universal Aether, and remember that Aether is matter, and being matter, it is atomic and gravitative, possessing density, elasticity, inertia, and kinetic energy, the same as any other moving matter.

In this Aether medium we have, according to this conception, something that can both push and pull, or exert force upon any body with which it comes into contact. Further, the inertia and kinetic energy of the Aether at any part of space will be regulated by its mass in that particular part, and if its mass is denser in some parts than others, that part of the aetherial medium possessing the greatest mass will also possess the greatest capacity for impressing force upon any body that exists in the medium. Now we have learned from Art. 45 that Aether being gravitative, it is denser nearer to the sun, getting gradually less and less dense, the further it recedes from the central body, except where it is bound or associated to some other planet or satellite, and there it gradually gets denser, for the same reason that it is denser nearer to the sun. As, therefore, the Aether gets gradually less dense as it recedes from the sun, the density of the Aether at the mean distance of Mercury, 35,900,000 miles, would not be so great as near the sun's surface; while the density of the aetherial medium at the distance of Venus, 67,000,000 miles, would be less than the density of the aetherial medium at the distance of Mercury. This principle may be applied right through the sun's aetherial electro-magnetic field, until we come to the mean distance of Neptune, which is 2,780,000,000 miles, and there the density of the Aether would be less than at any other part of the aetherial electro-magnetic field around the sun.

So that the mass of the Aether at Mercury, which is equal to the number of aetherial atoms per unit volume, is greater than the mass at Venus. Thus the impressed force which the aetherial medium at the mean distance of Mercury can exert upon any body in its neighbourhood, is greater than the impressed force which the Aether can exert upon any body at the distance of Venus, because of its decreased mass at that distance. In the same way it can be proved that the impressed force which the electro-magnetic Aether exerts on any body at the distance of

Venus, is greater than the impressed force which the Aether exerts upon a body at the mean distance of the Earth. So that at the respective mean distances of Mercury, Venus, Earth, Mars, Jupiter, Saturn, Uranus and Neptune, the electro-magnetic Aether, if in motion, would exert less force at each of the mean distances of these planets exactly proportionate to the decreased mass and decreased velocity of the Aether.

Now what is the motion which the Aether possesses, so far as the sun is concerned? because, upon the particular kind of motion which it possesses will depend the direction in which the impressed force will be exerted according to the second law of motion.

In Art. 98 we supposed the sun and planets to be stationary in the solar system, each planet being at its respective mean distance, from which it cannot move owing to the equality of the two forces. Now give to the central sun from whence the electro-magnetic Aether waves flow, a rotatory motion on its own axis, which it really possesses, as it rotates on its axis once in every twenty-six days nearly, and this will give to the Aether medium a circular or rotatory motion. This circular or rotatory motion the Aether has already been proved to possess (Art. 91, where we learned that all solar magnets were caused by electro-magnetic aetherial currents constantly circulating round them). So that the Aether will actually possess two motions: 1st, a radial motion due to the Aether waves generated by the sun, which are radiated out into space with the velocity of light; and 2nd, a circular or rotatory motion. This result is in perfect harmony with our hypothesis as to the cause of the electro-magnetism of the sun (Art. 91, where we saw that solar magnetism was due to electric currents circulating round the various planets), and we have proved that the Aether has an electro-magnetic basis; thus the rotatory Aether currents and the rotatory electro-magnetic currents are due to one and the same medium.

Now what will be the effect of these circular or rotatory Aether currents on the bodies situated within their field? It must be remembered that we are no longer dealing with a frictionless medium, but with a medium which possesses inertia and kinetic energy the same as any other moving matter. Therefore, as soon as it is set in motion, it will impress its motions upon all planets that come under its control and influence, with the result that as the impressed force is ever directed in a circular form, the planet will be pushed along through space by the moving Aether, and the path it describes will be circular also.

Thus the actual result of the rotatory electro-magnetic Aether currents will be, that all dependent and associated planets under

their influence will be carried by them around the central body which generates the Aether currents. So that they will literally and truly have an orbit, and the circle they describe will be, in its size and circumference, regulated by the mean distance of each planet, which mean distance will form the radius of the circular orbit.

Further, as we shall see later, if the sun were always stationary, and had no orbital motion of its own, then the orbit of each planet would always be circular, each planet always occupying its mean distance from the sun, because at that mean distance the centripetal and centrifugal forces are equal.

That the actual path of any planet is a circle has been proved by Sir W. R. Hamilton. Tait, in his *Natural Philosophy*, on this point writes (Art. 38): "The Hodograph for the motion of a planet or comet is always a circle, whatever be the form and dimensions of the orbit." This path has been termed the Hodograph. So that we have in the circling electro-magnetic Aether currents a physical explanation for the Hodograph of any planet.

In applying the rotatory Aether currents to the various planets, and in endeavouring to find out the quantity of the force impressed upon the various planets at their mean distances, by those currents, we have to take into consideration, as we have already seen, two facts, viz. the mass of the Aether at any point in space, and the velocity of the Aether at the same point. We will first take the effect of the difference in mass. We have seen that at the distance of Mercury from the sun the density of the Aether is greater than at the distance of Venus, and that the density at Mars is greater than the aetherial density at the Earth, the aetherial density decreasing the further the Aether recedes from the sun.

What, therefore, is the effect of the decreased density of the Aether on each planet? Even supposing the velocity of the moving Aether is the same at the respective mean planetary distances, which it is not, the total impressed force at the respective mean planetary distances will gradually be decreased upon the various planets, proportionate to the decrease in the mass and density of the Aether.

So that on Mercury, which is pushed along by a denser electro-magnetic Aether than Venus, the impressed force, according to Newton's Second Law of Motion, will be greater than the impressed force exerted by the moving electro-magnetic Aether on Venus; and, consequently, Mercury should have a greater velocity through space than Venus, due partly to the difference of the aetherial mass and density, by which the impressed force or motive power that acts upon Mercury is produced.

In the same way, Venus should have a greater velocity through space than Mars, and Mars a greater velocity than the Earth. The same principle, when applied to the outer planets, equally holds good ; with the result, that the greater the mean distance, the less the orbital velocity of each planet, due partly to the decreased aetherial density at the increased distance from the sun. But this is only part of the cause. Not only is there a decrease in density of the Aether, as the distance from the sun is increased, but there is also a decrease in the velocity of the moving Aether, with the result that the Aether at the distance of Mercury, possesses a greater angular velocity than at the distance of Venus.

It may be at once asked, How do we know that? Well, Philosophy alone can give us the key, and Philosophy tells us to base our theories and hypotheses on experience and experiment. Now what does experiment and experience teach us as to the effect of a body revolving in any medium upon that medium? If experience teaches us anything at all, it teaches us that the further away any medium is from the revolving body, the less is the angular velocity of that medium at that distance, while the nearer the medium is to the revolving body, the greater is the angular velocity.

This applies in each and every case, whether the medium is either fluid or gaseous, and I will challenge the reader to perform any experiment on any solid body rotating in a fluid or gaseous medium, and prove by that experiment that the angular velocity of the outermost part of the fluid or gaseous medium is equal to the angular velocity of the medium directly associated with the body, or even at a short distance from it.

But we have most conclusive evidence of the fact that a solid body does not communicate all its rotational surface motion to the medium directly in contact with that body in the case of the earth revolving on its axis, surrounded by an atmosphere. If the principle held good anywhere in relation to a revolving body, viz. that the whole of the rotational velocity is communicated to the medium surrounding the body, it should certainly hold good at the surface of the body where the two media, the solid and gaseous media, meet.

If a solid body fails to impart all its rotational velocity to the medium there, then it will certainly fail to impart its full rotational velocity to the enveloping medium 100 miles away, and fail still more at a distance of 1000, and still more at a distance of 100,000,000, and so on proportionate to the distance.

What, then, is the effect of the rotational velocity of the surface of the earth on the atmosphere near to it? We know that the velocity of the surface of the earth is greatest at the equator, as

at that place the circumference of the earth is about 25,000 miles, but the further we get away from the equator, and the nearer we get to the North and South poles, the velocity of the surface decreases, simply because the circumference of the earth decreases.

Or, to reverse the statement, the velocity of the surface of the earth is least at the poles, but increases the nearer we get to the equator. It is also familiar knowledge that there are currents of cold air ever moving from the North and South poles to the equatorial regions near the surface of the earth. Thus the cold air currents, in passing from the North and South poles, are ever passing over surfaces which are increasing in velocity as they journey on their way to the equator. This of course occurs all round the earth, so that the earth is continually revolving in these currents, and if the rotational velocity of the surface of the earth were wholly imparted to the air directly over its surface, then the currents would be always flowing due North and South.

If, however, the earth fails to impart all its rotational velocity to the atmosphere, or the atmosphere fails to pick up the whole of the rotational velocity at once, then the result will be that the atmosphere as it passes over the surfaces of greatest velocity will lag behind, because its rotational velocity will be less than the velocity of the earth's surface.

Now this is exactly what does happen in regard to the atmosphere, with the result, that instead of getting winds blowing due north and south, we get what are known as Trade Winds, which blow north-east in the northern hemisphere and south-east in the southern hemisphere. Here then we have direct experimental proof on a large scale of the very principle I have stated, viz. that a medium surrounding any rotating body does not move through the whole of its extent with the same velocity as it does at the surface. Thus it can be seen that the velocity of the rotating Aether will be greatest at the surface of the sun, but its angular velocity will decrease the further the medium recedes from the sun.

The same principle can easily be proved from an electrical standpoint; for if we consider the Aether currents as electric currents, no one would think of suggesting that the intensity of the currents was the same at a distance of several million miles away, as it is near the source of the currents, which in this case may be looked upon as the sun, because at its surface we have the greatest electric potential (Art. 80).

So that we see from this reasoning, that not only is there a decreased mass of the Aether at the distance of Venus, compared with Mercury, but there is also a decreased velocity in the rotatory electro-magnetic Aether currents, with the result

that the impressed force exerted upon Venus is less than the impressed force exerted upon Mercury, and therefore Venus should move slower through space than Mercury, which is exactly what happens, as Mercury has an orbital velocity of 29 miles per second, while Venus has an orbital velocity of 22 miles per second.

As the angular velocity decreases in proportion as the distance increases, it follows that at the respective mean distances not only of Venus, but also of Mars, Jupiter, Saturn, Uranus and Neptune, the capacity of the Aether to exert its impressed force upon the various planets will decrease as the distance increases, with the result that the farther a planet is from the sun, the less force will the Aether currents exert upon that planet, with the result that its orbital velocity should decrease as the distance increases, and this is perfectly in accordance with planetary phenomena.

Here, then, we have at once a physical basis for Newton's Second Law of Motion, the results of which are entirely in harmony with observation and experiment, and whose conception fully satisfies all the Rules of Philosophy; as it is simple in conception, fully agrees with observation and experiment, and satisfactorily explains the Second Law of Motion sought to be explained.

Thus we find that from the physical standpoint, as well as from the mathematical standpoint, "Change of motion is proportional to the impressed force, and takes place in the direction in which the force is impressed," that is, in a circular direction.

We have therefore arrived at exactly the same result that Newton arrived at, except that he had to introduce a third factor, viz. the Parallelogram of Forces, while we have produced the result by a simpler method, which, according to his own rules, is more philosophical, as all effects are produced by the simplest causes, as Newton himself stated in Rule 1. Thus it is the rotatory electro-magnetic Aether currents that urge the planets round the sun; and, as will be shown later, it is the same Aether currents in combination with the other motions that give rise to the physical cause of Kepler's Laws. It is the electro-magnetic Aether currents that produce the regular decrease in the velocity of the planets in their orbits, because of the regular decrease of the mass and velocity of the Aether currents themselves.

We have now a physical cause as well as a mathematical explanation of the decrease of the velocity of a planet in its orbit, which physical cause is in perfect harmony with all philosophical rules. The following table shows the gradual decrease

in the velocity of each planet as the various planets recede from the sun—

	MEAN DISTANCE.	PERIOD OF REVOLUTION.	VELOCITY IN ORBIT PER HOUR.
Mercury	35,900,000	87·9 days	
Venus	67,000,000	224·7	77·000
Earth	92,700,000	365·2	66·500
Mars	141,000,000	686·9	53·000
Jupiter	482,000,000	4,332·6	28·744
Saturn	884,000,000	10,759·	21·221
Uranus	1,780,000,000	30,687·	14·963
Neptune	2,780,000,000	60,127·	11·958

ART. 100. *Aether and Third Law of Motion.*—We have seen (Art. 16) that action and reaction are equal and opposite, and that it is true of the centripetal force in its application to all matter throughout the universe. If, therefore, the centrifugal force is the exact opposite of the centripetal force, then the Third Law of Motion should equally hold good in relation to that force also.

We have, therefore, to form a physical conception of the application of the third law of motion, as it relates to the centrifugal force. As we have already learned, this force is due to the universal electro-magnetic Aether, which being gravitative, surrounds all atoms and molecules that may exist throughout the whole universe. It can readily be seen, therefore, that if the Aether surrounds every atom and molecule, then each atom repels another atom or molecule when the two forces are in equilibrium with exactly the same intensity with which the atom and molecule attract each other.

But the centrifugal force in each case is due to the pressure of the Aether, which presses always proportionately to the density of the Aether surrounding the atom or molecules, as suggested by Professor Challis.

The mean density, however, of each atomic or molecular atmosphere is regulated solely by the mass of the atom or planet, therefore the pressure exerted by one atom on another is proportionate to the mass of each atom, and to that extent is strictly in accordance with the law which governs the proportion of the forces between the two atoms or molecules. If, therefore, we have two atoms, A and B, of different masses, then it is true that while A exerts a pressure on B, which pressure takes the form of a repulsion, at the same time B exerts a pressure on A which is equal and opposite in its character and intensity, and in each case the pressure is due to the aetherial medium which surrounds each atom or molecule.

When the atoms are equal in mass, then the resultant motion

produced on each atom would be exactly equal, but when the masses vary, the resultant motion produced on each atom would vary also, though the momentum in each case would be exactly equal and opposite, as momentum is a compound term dependent partly upon the mass of the body concerned.

In Art. 16 we saw that when this third law was applied to planetary phenomena, not only did the sun attract all the planets, but all the planets attracted the sun with equal and opposite forces, and the planets also attracted each other with equal and opposite forces. In the same way it can be proved, that as the sun repels all the planets by the pressure exerted by the aetherial centrifugal force on those planets, the planets repel the sun with an exactly equal and opposite force at their mean distances. In Newton's conception, however, of the third law of motion, there was simply mathematical data to deal with, by which the law was shown to apply to the planetary and stellar world. In the case, however, of the centrifugal motion, we have a definite physical medium, which by its motions produces the pressure on the planets or suns that exist in space, which pressure forms the physical centrifugal force that forms the counterpart of Gravitation Attraction.

Let us look at this phase of the case in detail, and by so doing help to establish and confirm the physical existence of the force or motion referred to. We have learned from Chapter IV. that as Aether is gravitative, it surrounds all satellites and planets, suns and stars that exist in the universe.

We have also learned from Art. 86 that Aether has an electro-magnetic basis, as mathematically proved by Maxwell and experimentally proved by Hertz. Thus we came to the conclusion that each satellite and planet, sun and star, was an electrified body (Art. 81), or an electro-magnet (Art. 88), possessing its own electric or electro-magnetic field.

We also learned that in every electro-magnetic field there was a pressure which was ever directed away from the body that generated the electro-magnetic waves. Now, as every satellite and planet, sun and star, is a generator of these waves according to our theory, it follows that every satellite and planet, sun and star, is the centre of a centrifugal force, which centrifugal force is regulated by the mass of the satellite, planet, sun or star which gives rise to the centrifugal force or motion.

Now, in relation to all electro-magnetic action, it can be experimentally demonstrated, that action and reaction are equal and opposite, so that if we have two electrified or magnetized bodies, then the joint forces of attraction or repulsion between them are equal and opposite. This being so, when we apply the

same law of action and reaction to the planets' influence on each other, it follows that the same law must hold good in relation to them.

So that if we compare the repulsive powers of two planets on each other in the solar system, say the Earth and Jupiter, then, according to the third law of motion, the repulsive action of Jupiter on the Earth is exactly equal and opposite to the repulsive action of the Earth on Jupiter. If we compare the Earth and the sun, the repulsive action of the sun on the Earth is exactly equal and opposite to the repulsive action of the Earth on the sun, that action or force being caused directly by the electro-magnetic Aether waves, which are generated by each electric, or electro-magnetic body.

Thus, as the third law of motion is true of the centripetal force, whether in relation to the atomic world, or in relation to the solar system, or even to the universe at large, seeing that the centrifugal force is the exact counterpart in every way of the centripetal force, exactly fulfilling all the laws which govern it, it follows as a matter of absolute necessity that the third law is also applicable to its complement or counterpart also, or else it would cease to be the complement and counterpart of the centripetal force.

ART. 101. *Why Planets revolve from West to East.*—In Art. 99 we have seen that the revolution of the planets around the sun is produced and maintained by the electro-magnetic Aether currents, which are generated by the axial motion of that electro-magnetic body. There is, however, another effect produced, and another scientific fact which can be accounted for by the circulating motions of the Aether medium, viz. that the orbital direction of each and all the planets would not only be in the same direction, but they would also be in the same direction as the sun's rotation on its axis.

So that, whichever way the sun turns upon its axis, that way, and that alone, should be the orbital direction of all the planets in which they are circled round the sun by the circulating electro-magnetic Aether currents. It is the sun's axial motion that partly gives to the Aether currents their circling motion, and it is the circling motion of the Aether currents that gives rise to the orbital motion of the planets, literally carrying them round the sun by their kinetic energy and power.

Therefore, if this be true, whichever way the sun turns upon its axis, that will be the direction in which the Aether currents must circle round the sun, and in that direction the planets should travel in their orbits. As must readily be seen, it is the inevitable result of the established working of the electro-magnetic Aether currents. If the sun rotated on its axis from

east to west, then the electro-magnetic Aether currents would also travel in the same direction, from east to west, and the planets would then revolve round the sun from east to west.

If the sun, however, rotates on its axis from west to east, then, if there are such electro-magnetic Aether currents in existence, as those we have already proved to exist, they, too, would travel from west to east, and as a natural result the planets, which are carried round the sun by the currents, would also possess the same orbital motion, that is from west to east.

As is well known, the sun rotates on its axis from west to east, therefore the Aether currents also rotate from west to east, with the result that the orbital directions of all the planets should also be in the same direction, from west to east. Now, as is well known, all the planets without exception, Mercury, Venus, the Earth, Mars, Jupiter, Saturn, Uranus, and Neptune, all travel round the sun from west to east.

Here, then, we have indisputable evidence of the existence and mode of working of the electro-magnetic aetherial currents, whose action alone can produce the phenomena with which we are so familiar, and for which there must be some physical cause. I am not aware that any reason or explanation either mathematical or otherwise has ever been given, or even suggested, as to the cause of the phenomena which we have just endeavoured to explain.

Indeed, there can be no other physical explanation of the fact, that all the planets revolve round the sun in the same direction that the sun rotates on its axis, than the one here given, viz. that the cause is to be found, and alone found, in the circulating electro-magnetic Aether currents which are generated in the Aether by the electro-magnetic body, the sun. Again, in order to confirm the existence of these Aether currents that exist in space, not only those generated by the sun, but also by all the other electro-magnetic bodies, as all the planets (Art. 88), we will consider the working of the same upon the satellites of those planets which possess them.

The Earth we know has one satellite, the moon, Mars has two satellites, Phobos and Deimos, Jupiter has five satellites, Saturn has eight satellites, while up to the present Uranus has been found to possess four, and Neptune one. There is, however, little doubt but that both Uranus and Neptune possess more than those already discovered, as it is inconceivable that Jupiter and Saturn, which are nearer to the sun, should possess a greater number of satellites by which the nights of the respective planets are illuminated, while the further planets, which need the increased lighting, because of the decreased intensity of the

aetherial light waves at the increased distance, possess apparently a less number of satellites, and therefore less illumination for their respective nights.

But what have these satellites to teach us as to the existence of the electro-magnetic aetherial currents that circulate round the planets? We have to apply a similar course of reasoning to the planets, as we have done in the case of the sun. If the sun is an electro-magnetic body, by its axial rotation it generates rotating Aether currents, and those Aether currents partake of the same rotation as the revolving body, that is, from west to east. In a like manner each planet, being an electro-magnet, generates electro-magnetic aetherial currents which also possess the same rotation as the planetary body which gives rise to them.

So that if the planets rotate on their axes from east to west, the Aether currents will also rotate from east to west, but if the rotation of each planet is from west to east, then the rotation of the Aether currents associated with each planet will also be from west to east, with the result that each satellite will be carried round its primary planet by the circulating Aether currents in exactly the same way as the planet rotates on its axis.

Now if this is the case, then we have further evidence of the existence of the circulating electro-magnetic Aether currents, not only those associated with the sun, but those also associated with each of the planets, as explained in Art. 91. It might have been urged in the case of the planet's revolution round the sun being in the same direction as the sun's axial action, that such a fact was merely a coincidence, but such an objection loses its force if it is proved that the same principle or truth when applied to other bodies equally holds good. When we come to analyze the direction of the satellites round their primary planets, we find that each satellite has an orbital motion, or is carried round its central and controlling planet by that planet's Aether currents in exactly the same direction that the planet rotates on its axis, viz. from west to east. So that we have in the orbital direction of the satellites, as we have also in the orbital direction of the planets, conclusive evidence of the existence and mode of working of the Aether and of the electro-magnetic currents generated in that aetherial medium by the electro-magnetic bodies which rotate in it.

CHAPTER XI

AETHER AND KEPLER'S LAWS

ART. 102. *Aether and Kepler's First Law.*—In Art. 26 we learned that according to the First Law of Kepler, each planet revolves round the sun in an elliptic orbit, with the sun occupying one of the foci.

We also saw that that elliptic orbit was produced according to Newton by the conjoint working of the centripetal and centrifugal forces in association with the three Laws of Motion, to which laws had to be added a corollary, which is termed the Parallelogram of Forces, before the First Law of Kepler could be fulfilled.

In making any hypothesis as to the physical cause of Kepler's Laws, if it can be shown that the same aetherial medium that gives rise to the centrifugal force, also gives rise to the centripetal force, and that the same medium by its rotatory motions also fulfils the three laws of motion, and gives a satisfactory physical explanation of all Kepler's Laws; then, according to our three Rules of Philosophy, we shall have found a physical medium which, by its motions and pressures and tensions, can give rise to all the phenomena exhibited in the celestial mechanism. Such a physical explanation will be philosophically correct, in that it is simple in its conception, is entirely in harmony with observation and experiment, and satisfactorily accounts for, and that on a physical basis, all the phenomena associated with the whole of the celestial mechanism.

We have therefore to apply the motions of the Aether medium to the solar system, and by so doing reveal the physical explanation of all Kepler's Laws, in the same way that Newton revealed their correctness from the mathematical standpoint. Let us review the conception of the solar system as given in Art. 99, so that we may be able to proceed from that physical conception of a stationary solar system to a moving system.

Thus we see the sun in a stationary system occupying exactly the centre of that system. The solar energies are in full play, generating electro-magnetic Aether waves which are radiated

forth into space with the velocity of light. Then, as there is given to the sun a rotatory motion on its axis, that rotatory motion imparts to the gravitating aetherial medium a circulatory or rotatory motion which spreads out through space with ever-decreasing intensity.

By their radiating motion the Aether waves would repel all planets from their central body, the sun, if they were not counterbalanced by the centripetal force; and the two forces, the centrifugal and the centripetal forces, find their equilibrium at the mean distance of each planet, thus fixing and regulating permanently the distance and orbit of each planetary world.

At the same time, the rotatory motion of the electro-magnetic Aether currents, according to the second law of motion, would act on the planets by their kinetic or moving energy, and so circle them round the sun, their controlling centre. As long as the sun was quite stationary, while still possessing a rotation on

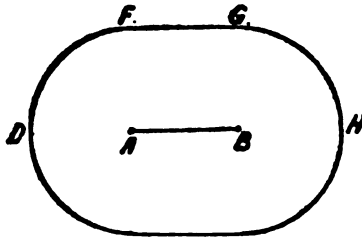

Fig: 24.

its axis, if such a thing were possible, so long would the conception of the ancients be fulfilled, and the rotation of all the planets would be strictly circular in form, and their orbits would be that of a circle only, as proved by Sir W. R. Hamilton (Art. 99).

But, as is well known, the sun itself possesses an orbital motion of its own, so that, while all the associated planetary system is revolving round it, the sun with all that system is being carried along through space in an orbit which is also elliptic in form, as we shall see later on.

According to Herschel, the sun is moving towards the constellation of Hercules with a velocity of about 18,000 miles per hour, and the problem to be faced is, what is the effect of the sun's orbital velocity upon the circular motion of the planets? By solving that problem, we shall arrive at a physical conception for the first time of Kepler's Laws, and shall see that the first of Kepler's Laws is solved simply by giving an orbital velocity to

s

any central body, the result of which will be that the circular form of any planet's orbit will be changed from the circular into one of elliptic form.

Let me ask the reader to perform a very simple experiment to confirm this fact. Take a piece of string and a lead pencil, and start to draw a circle on a piece of paper (Fig. 24). When, however, one quarter of the circle has been drawn, viz. DF , move the end of the piece of string representing the centre of the circle along the paper, as represented in the diagram, from A to B . The result will be that the pencil will now travel parallel with the moving centre for a time from F to G , and then, when the centre is brought to rest again, the other part of the half ellipse GH may be completed. In the same way, by reversing the motion, the other half of the ellipse may be completed. So that it is possible for an ellipse to be formed simply by moving the central point of a circle, and the motion of that central point will change the form of a circle into an ellipse. It is something

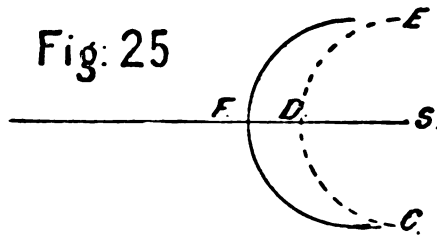

like this that takes place in the planetary world, with this difference, that the central point which represents the sun does not return from one focus to another, but continues to journey on through space, with the result that the orbit of any planet is not strictly an ellipse, as we shall see later on. We have, then, the sun occupying the centre of the solar system, with all the planets revolving round it. We will take the sun and the Earth as examples. Let S in the diagram represent the sun, and E the Earth at its mean distance of 92,000,000 miles away (Fig. 25).

The Earth we know is moving with a velocity of about 64,800 miles per hour around the sun, or an average velocity of 18 miles per second, so that while the Earth is moving 64,800 miles through space to perform the half-circle, EDC , the sun is also travelling 18,000 miles towards the point D .

What, therefore, is the effect of this onward movement of the sun towards the Earth as it tries to complete the half-circle EDC ? We have seen that the centrifugal force due to the pressure of the electro-magnetic Aether waves is exactly equal to

the centripetal force exerted by the sun on any planet, and if that be so, it can be readily seen that as the sun journeys towards the point *D* of the Earth's orbit, it tends to approach nearer and nearer the Earth. Thus the intensity of the aetherial pressure owing to the decreased distance will be greatly increased, and the effect of the increased pressure of the Aether upon the planet will be to push it away from the sun, so that the two forces may be equalized, and its mean distance, which is definitely fixed, be maintained as far as possible.

The result will be that, instead of the Earth describing the half-circle *EDC*, it actually describes the part of the ellipse *EF C*. Thus it can be seen that while the sun is travelling through space, it is at the same time giving rise to the electro-magnetic Aether waves, which, by their repelling power, repel the Earth from the sun in the direction that the sun is travelling, and hence the half-circle is elongated into that part of the elliptic orbit known as the perihelion, which is that part of

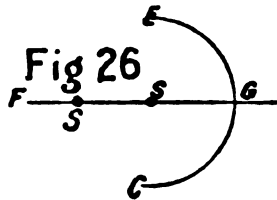

the orbit where the distance of any planet from the sun is the least.

The repelling power of the Aether waves is not, however, sufficient to overcome altogether the centripetal force in conjunction with the Earth's motion, with the result that when the Earth arrives at *F*, its distance is only 91 million miles, that being the least distance between the sun and the Earth. We shall see the result of this decreased distance when we deal with Kepler's Second Law.

We will now proceed to notice the effect of the sun's orbital velocity upon that part of the Earth's orbit which includes the aphelion, or that part in which the Earth occupies a position of the greatest distance from the sun. Proceeding on the same method of reasoning, if the sun were stationary, with the Earth being circled round it by the electro-magnetic Aether currents, then the path described by the Earth would be that of a circle, being represented by the half-circle *CGE* (Fig. 26).

¶ But it has to be remembered that while the Earth is being circled round the sun by the rotatory electro-magnetic Aether

currents, the sun is still travelling on towards $S F$ at the rate of 18,000 miles per hour, while the Earth is travelling in almost an opposite direction towards $C G$, so that by the time the Earth has got to G , which we will suppose is one quarter of its ellipse, the sun has travelled millions of miles in that time.

Thus it can readily be seen, that by the time the Earth has got to its aphelion, it is at its furthest distance from the sun, simply because the sun has been travelling onwards through space all the time, while the Earth has been receding from it; and as the motion of the Earth has been in an opposite direction, the mean distance has been exceeded, and instead of the Earth being now at its mean distance from the sun, its distance is now 94,500,000 miles. At that part of its orbit, its orbital velocity is at a minimum, because the rotating Aether currents have there a decreased flow and a decreased mass and density, and therefore possess a decreased kinetic energy or motive power.

Thus by the rotating Aether currents working in conjunction with the centrifugal and centripetal forces, can be accounted on a physical basis the first of Kepler's Laws in a manner which is strictly philosophical, as the explanation is simple in conception, does not violate experience or experiment, and satisfactorily accounts for, on a physical basis, the law which it is required to explain.

If we consider the rotating Aether currents as purely currents of electricity, then exactly the same results follow. For, as we shall see later, Professor Lodge in his *Modern Views of Electricity* proves that electricity possesses both inertia and momentum, and if electricity possesses these properties, then it also possesses the requisite properties to enable the currents to propel or push any planet around its central body, or a satellite round its primary planet. Therefore the same course of reasoning that applies to the rotating Aether currents, equally applies to the currents of electricity that circulate round each satellite, planet, and sun and star, and by that circulation gives rise to the electro-magnetism associated with each body, while at the same time they supply the kinetic energy which enables any dependent or associated body to be propelled round their controlling centre.

ART. 103. *Second Law of Kepler.*—According to Kepler's Second Law (Art. 27), we learn that the radius vector, which is the imaginary straight line joining any planet to the sun, describes, or sweeps over, equal areas in equal times. So that, while Kepler's First Law describes the path which a planet takes in revolving round the sun, the Second Law shows how the velocity of that planet varies in different parts of its orbit.

While, however, there is a difference in the velocity of any planet at various points in the orbit, there is still a proportion

existing between its various velocities, in that equal areas are covered in equal times. We have now to apply the hypothesis of our rotatory Aether currents, in conjunction with the centripetal and centrifugal forces, in order to see whether the Second Law of Kepler can be explained on a physical basis, in the same way that Newton explained it from the mathematical standpoint.

We have again to conceive the sun as the centre of two equal but exactly opposite forces, and also possessing a rotatory motion on its axis, with the electro-magnetic Aether currents ever circulating round it. If the sun were stationary, it will be manifest at once that Kepler's Second Law would be literally and strictly fulfilled, for in that case the orbit of all the planets would be perfect circles, and the motion of planets in their orbits would be perfectly uniform, and therefore equal areas would be covered by the radius vector in equal times. Thus any quarter of the orbit would be described in exactly a $\frac{1}{4}$ of a year, $\frac{1}{2}$ in $\frac{1}{2}$ of a year, $\frac{3}{4}$ in $\frac{3}{4}$ of a year, and so on, the time being exactly proportional to the proportion of the area covered by the radius vector.

The area covered would always be uniform, because the radius vector would always be uniform in length. But, as we have seen in the previous article, the distance of a planet from the sun, that is, the length of the radius vector, is not uniform, as the Earth is nearer to the sun at perihelion, and further away at aphelion, its distance gradually changing as it passes from each of these points to the other.

Now what is the effect of the decreased distance upon the circulating or rotatory Aether currents? We have already seen (Art. 99) that the closer these Aether currents are to the central body, the sun, the greater is their velocity and the greater their mass, so that the total impressed force which they exert over any planet is greater the nearer that planet is to the sun. This is proved by the fact that Mercury has a greater orbital velocity than Venus, Venus than the Earth, the Earth than Mars, and so on right through the whole of the planetary system. In view of these facts, let us again consider the effect of the sun not being stationary, but having an orbital velocity of its own through space. Thus let the sun be at *S* and the Earth be at point *D* of its orbit (Fig. 25).

The circulating Aether currents are ever acting upon the Earth, carrying it round the sun with them, while at the same time the centripetal force is pulling it towards the sun with a certain intensity, but the centrifugal force is repelling the Earth with exactly the same intensity, and if the sun remained motionless the two forces would exactly balance each other, while the Earth would describe the half-circle *EDC*. But while the Earth is moving towards the point *D* with a velocity of 64,000

miles per hour, the sun is also moving at the velocity of about 18,000 miles per hour towards that point.

Thus the repelling power of the radiating electro-magnetic Aether waves has to overcome, not only its exact counterpart, the centripetal force, but also the onward motion of the sun as it rushes on its course through space. This the centrifugal force is unable to do, with the result that the distance is gradually lessened, and instead of the Earth describing the arc ED , it describes the arc EF , at which point its distance is at the minimum, or about 91 millions of miles.

Or, to put the same fact in another way. When the Earth is at E , the centripetal force and the orbital velocity of the Earth and the sun are acting conjointly, with the result that they overcome the centrifugal force, and the distance is gradually decreased. This decreased distance means an increased aetherial density and an increased velocity of the aetherial currents, with the result, that as the distance is decreased, the orbital velocity of the Earth is gradually increased, so that by the time the Earth gets to F , at its perihelion, it has now acquired its greatest orbital velocity, and is carried round the sun by the electro-magnetic Aether currents at its maximum velocity.

Now let us look at the Earth being circled round the sun by the electro-magnetic Aether currents as it goes on to perform the other half of the orbit. In this case we have the orbital motion of the sun and the centrifugal force working conjointly, with the result that together they overcome the centripetal force, and the Earth is repelled and carried beyond its mean distance. Let S represent the sun, the Earth being at point C of its orbit, after passing round its perihelion, and at this decreased distance it is carried along by the circulating and denser Aether with its maximum velocity (Fig. 26).

Now while the Earth is going on to describe the half-circle CGE , the sun is still pursuing its journey at the rate of about 18,000 miles per hour, only this time in a direction away from the Earth. As, however, the Earth has not yet regained its mean distance of 92,000,000 miles, the centrifugal force is still greater than the centripetal force, so that the centrifugal force is urging the planet away from the sun with greater intensity than the centripetal force is attracting it, as the two forces are only in equilibrium at the mean distance of the Earth.

Thus, as stated, the orbital motion of the sun and the centrifugal forces are now working conjointly together, with the result that the Earth is repelled gradually further and further from its central body, until it reaches its maximum distance of 94,500,000 miles. While, however, the distance is gradually being increased, it is passing into a part of the Aether possessing

not only a decreased mass, but also a decreased velocity, with the result that the motive power or kinetic energy of the aetherial currents at the increased distance is gradually lessened, and as a natural result the velocity of the Earth is also decreased; so that by the time the Earth has got to its furthest distance from the sun, its orbital velocity is slowest, because of the decreased momentum of the aetherial currents.

Thus we can account for the difference of velocity of a planet in its orbit by the same electro-magnetic Aether currents working in conjunction with the sun's orbital motion, and that upon a strictly physical basis. This result is in perfect harmony with Kepler's Second Law, which states that equal areas are described by the radius vector in equal times. Newton proved that by the Law of Gravitation Attraction he could account for this second law, as well as all the others, and as we have not destroyed that law, but perfected it by giving it its exact complement and counterpart, the same mathematical reasoning that applies to the centripetal force must equally apply to the centrifugal force, and if it is true that the centripetal force works harmoniously with the second of Kepler's Laws, then it is equally true that the centrifugal force does also, as the two are inseparably and indisputably united together in the atomic Aether. We have, however, a physical basis for this centrifugal force, and we have an equal physical basis for the centripetal force, as we shall see later, and therefore, by the conjoint working of these two forces taken in conjunction with the orbital motion of the sun, we have now a physical conception for the first time of Kepler's Laws, as well as a mathematical conception, that physical conception being derived from the pressure and motions of the universal Aether.

ART. 104. *Aether and Kepler's Third Law.*—In Art. 28 we saw that according to the Third Law of Kepler, the square of the periodic time was proportionate to the cube of the mean distance of that planet from its controlling centre. Newton proved that this Third Law was mathematically correct, and that it could be mathematically accounted for by the existence and operation of the universal Law of Gravitation. As the centrifugal force is the exact opposite of that force in intensity, proportion and mode of operation, it follows that mathematically the centrifugal force also bears the same relation to the Third Law that the centripetal force does.

We have, however, a physical basis for the centrifugal force, and it is with the physical conception of this Third Law rather than with its mathematical character that we are now dealing. Kepler by his Third Law showed that the chief regulating factor in the orbital velocity of a planet was its mean distance from the sun.

The great regulator of the velocity of any planet in its orbit

is simply planetary distance, and planetary distance alone. If there were no other law which operated in the solar system than the centripetal force, or the attractive force due to gravity, then such factors as mass and density of a planet ought to play a most important part in the orbital velocity of a planet, as the centripetal force directly recognizes the influence of mass, that is, volume and density, but says nothing about mean distances. This fact unmistakably points to the existence, and demands the operation, of another force, which shall explain, and that on a physical as well as a mathematical basis, how it is that the mean distance of a planet from any centre regulates the orbital velocity of that planet.

The only real and true conception of such a force is to be found in the radiating waves and circulating motions of the aetherial medium, which waves, like water waves, increase in their radial outflow and extent with a regular decreasing intensity, and at the same time decrease in their angular velocity as they recede from the sun. With such a regular decrease of kinetic energy, there must necessarily be imparted to the planets, as their mean distance is increased, a decreased velocity of motion, with the natural result, that the further a planet is from the sun, the less will be its orbital velocity, and that in a regular and uniform proportion as the distance is increased.

Now let us view the matter for a moment in its application to the solar system, and by so doing show the simplicity of the explanation, and at the same time give added proof to the existence and operation of the circulating aetherial currents that exist in space. Let us again picture the solar fires burning in all their fierceness and intensity, every atom and particle of the sun being thrown thereby into the most intense state of activity, and by their energy of motion creating electro-magnetic Aether waves in their myriads, which speed away from the sun on every side.

Under their influence, all subordinate worlds would be carried away into space, were it not for the complementary Law of Gravitation Attraction, that is, the centripetal force. But to every planet, by the operation of some governing and determining principle, a mean distance has been given, and at that mean distance the two forces find their equilibrium; and by their conjoint and co-equal working hold each planet at that mean distance with a power that cannot be broken. Each power or force may be modified under certain conditions, as shown in the two preceding articles; but, whether the planet be repelled further away, or attracted nearer to the sun, through the onward motion of the sun, the two forces ever seek to maintain their equilibrium, and to place the planet at its mean position assigned to it in the solar system.

The nearer that mean position is to the sun, the greater is the velocity of the aetherial currents which circulate round the sun ; and the greater their mass, volume for volume, on account of the increasing density of the Aether, the nearer it is to the sun. The effect of this increased velocity, and the increased mass of the circulating Aether currents, is to impart to planets nearest to the sun the greatest orbital velocity; while, the greater the distance, the less will be the orbital velocity of the planet. That this is exactly in accordance with observation and experience may be proved by considering the respective mean distances and orbital velocities of the various planets.

Mercury, with a mean distance of 35,900,000 miles, is circled round the sun at the enormous rate of about 108,000 miles per hour, accomplishing its entire journey in the short period of 88 days. Venus, whose mean distance is about 67,000,000 miles, is carried round the sun at the reduced rate of 78,000 miles per hour, completing her orbit in the increased time of 224 days. Our own Earth, at the still further increased mean distance of 92,000,000 miles, performs her journey at the reduced velocity of 64,000 miles per hour, accomplishing the journey round the sun in a period of 365 days.

Thus, the further we get from the sun, the slower becomes the movement of a planet in its orbit, and the longer it takes to complete its revolution round its controlling centre. Mars, at the increased distance of 141,000,000 miles, possesses a reduced velocity of 54,000 miles per hour, and completes its orbit in the increased duration of 686 days. So the decrease of velocity goes on, as the planets increase their mean distance from the sun, as the following figures show—

	MEAN DISTANCE.	PERIOD OF REVOLUTION.	ORBITAL VELOCITY PER HOUR.
Jupiter	482 millions	4,332 days	28,000 miles
Saturn	884 "	10,759 "	21,600 "
Uranus	1,780 "	30,687 "	1,800 "
Neptune	2,780 "	60,127 "	900 "

The relation of this decrease of velocity to the mean distance is exactly determined by Kepler's Third Law, in which he states that the square of the periodic time is proportionate to the cube of the mean distance. That this is true has already been proved in Art. 28.

In conclusion on this point, let me ask the reader to try to conceive any other physical explanation for this decrease of orbital velocity as the mean distance is increased, than the one given here, namely, the decrease in the velocity and mass of the radiating and circulating Aether currents, and if such attempt is

made, I premise that its only result will be utter failure. No other physical conception to account on a physical basis for all Kepler's Laws can be given or conceived, than that which finds its origin in the universal electro-magnetic Aether, which by its pressures, tensions and motions gives rise to all the phenomena incidental to, and associated with, planetary and stellar phenomena.

Therefore, inasmuch as all the laws of motion, and all Kepler's Laws can be accounted for by a gravitating and rotatory Aether medium, those facts alone, apart from the explanation of other phenomena associated with light and heat, would stamp the circulating Aether medium as the physical cause of all the motions and phenomena associated with the whole of the celestial mechanism.

ART. 105. *Orbital Motions of Satellites and Planets.*—According to Kepler's First Law, the Earth and all the other planets move round the sun in orbits which are in the shape of an ellipse. Not only, however, is the first law true of planetary motion, it is equally true of the motions of all satellites moving round their primary planets. I wish, however, to point out, and prove in an indisputable manner, that Kepler's First Law does not sufficiently explain and determine the exact orbit of any satellite as it revolves around its primary planet, or even of any planet as it revolves around the sun.

Simply because, if any satellite or planet is to perform a perfect ellipse as it revolves around its central body, that central body must only move for a time and must then come to rest, or partly return in its journey in order for a perfect ellipse to be formed, as shown in a previous figure. Now we know from observation that such a thing as rest in space by any planet, or by the sun, is absolutely unknown in the celestial mechanism.

From Art. 92 we learned that the electro-magnetic Aether currents not only circulate round the sun, but they also circulate round each planet. Thus we found there were electro-magnetic Aether currents circulating round each planet, while those planets themselves were circled round the sun by the Aether currents generated by the sun; the planetary Aether currents in their turn propel the satellites round their primary planets. It can easily be seen, therefore, that such phenomena as rest and return of a planet in its journey are physical impossibilities, for either the circulating Aether currents would have to cease circulating, or would have to return upon themselves in some inconceivable manner.

Thus there is ever going on this conjoint motion, so to speak, of the sun's aetherial currents which circle all the planets round that body, and the planetary aetherial currents which circle all

the satellites round their central body, and it is the effect of the conjoint working of these currents on the planets and satellites to which I wish to call the reader's attention.

Let us in starting represent the earth's orbit by a perfect ellipse $A B C D$, with the sun occupying one of the foci S (Fig. 27). We will suppose that the earth is at point A of its orbit and is being circled round the sun with uniform velocity. As it is circled round the sun by the sun's aetherial currents, at the same time its satellite the moon is being circled round the earth by the electro-magnetic Aether currents which circulate round that planet. We will represent the orbit of the moon by part of a smaller circle $D E F$, and suppose the moon to be at point D of that orbit. The mean distance of the moon from the earth is

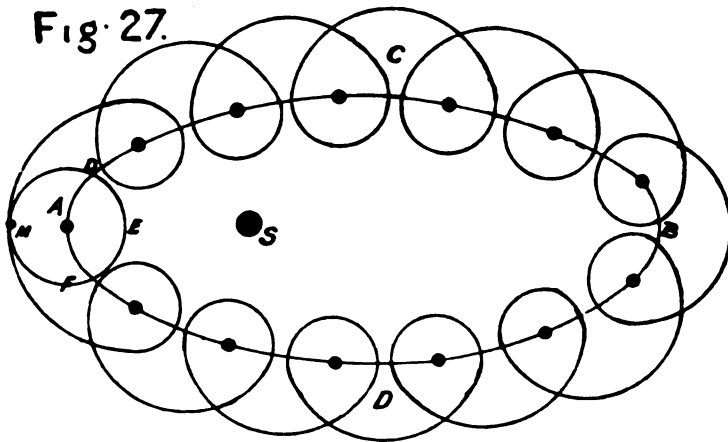

about 240,000 miles, so that the diameter of the orbit is 480,000 miles, therefore the circumference of the orbit is $480,000 \times 3.1416$, which gives us about 1,500,000 miles.

That distance is traversed in about 28 days, so that the moon's average velocity in its orbit, as it is circled or pushed round the earth, is about 2200 miles per hour. While, therefore, the moon is travelling 2200 miles, the earth in its journey round the sun has travelled about 64,800 miles in the same time. So that by the time the moon has travelled half its orbit, that is, from D to F , which would take about 14 days, the earth has also travelled in its orbit $64,800 \times 24 \times 14 = 21,772,800$ miles, with the result, that instead of the moon arriving at point F , which it would do if the earth were stationary, it really arrives at a point about 21,772,800 miles in front of that point.

In a similar way, while the moon goes on to describe the other

half of the orbit, the earth still proceeds on its journey, so that at the end of 14 days it is again 21,772,800 miles further on, with the result, that the centripetal force (by which the moon is attracted to the earth) keeps it at the distance of 240,000 miles according to Kepler's Second Law as explained in Art. 103.

The moon, therefore, completes its orbit about 21,772,800 miles further on than it would do if the earth were stationary. The effect of this continual progress of the earth on the moon's orbit as it describes its orbit round the sun is seen in the diagram. As the moon revolves round the earth thirteen times in one year, it performs thirteen revolutions round that planet; but it cannot be said that these orbits are perfect ellipses, as the earth is ever being circled round its central body, the sun. Even this diagram does not accurately represent the orbital motion of the moon through space, as it assumes that the earth returns to the same point in space from whence it started. This, however, is incorrect, as we have to remember that the sun has also an orbital velocity of 18,000 miles per hour, so that while the earth has performed one revolution in its orbit, the sun has actually progressed through space to the extent of $18,000 \times 24 \times 365 = 157,680,000$ miles.

When we come to deal with the sun's motion through space, we shall see that this distance only represents a fraction of the sun's orbit, as it can be philosophically proved, that if the sun moves at all, it, too, obeys Kepler's Laws; and therefore, according to his First Law, it also describes and possesses an orbit of its own. So that by the time the earth has made its annual revolution round the sun, the whole system has been carried 157,680,000 miles through space, and therefore the earth does not complete a perfect ellipse, but its orbital motion round the sun will be represented by a similar kind of diagram to the one which represents the orbital motions of the moon, or any other satellite round its central body.

ART. 106. *Eccentricity of Orbit of Moon.*—From astronomical observation we learn, that all the satellites and planets do not possess uniformity of motion, as they are carried round their controlling centres by the circulating aetherial currents, because the respective controlling centres themselves move through space. The result is, that the orbit of any satellite or planet is not always of the same size, but constantly varies, sometimes having a larger circumference than at other times, and sometimes a smaller circumference.

This change in the size of the orbit of a satellite or planet is known as the eccentricity of the orbit, which eccentricity is constantly changing, being sometimes greater and sometimes less. We will look at this truth in its relation to the moon first, and

then consider the same principle in its relation to the earth and other planets later on. For the purpose of illustration, we will consider the earth as being circled round the sun by the electromagnetic Aether currents in a closed orbit, $A B C D$, which forms a perfect ellipse, the sun occupying one of the foci S (Fig. 28), the earth occupying a position in the orbit represented by point C , with the moon being circled round the earth by that planet's aetherial currents. As we have already seen in Art. 103, according to Kepler's Second Law, at this point the earth is furthest from the sun, being now at a distance of $94\frac{1}{2}$ millions of miles, and therefore its orbital velocity will be slowest at that part of its orbit.

If it were absolutely at rest in space, and simply revolving on its own axis, then the result would be that the moon would be circled round the earth in an orbit $M C F$ which is perfectly circular in form; but, as the earth is being carried along slowly through space by the circulating Aether currents, this onward

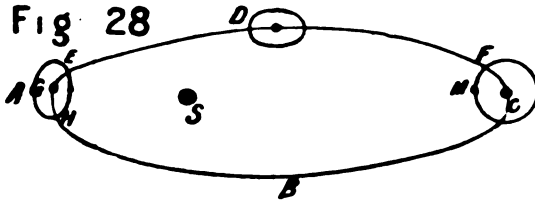

movement changes the circular orbit into an orbit of elliptic form.

The eccentricity of the moon's orbit when the earth is at its aphelion, or furthest from the sun, is now at a minimum, for the simple reason that the earth is proceeding slowly through space, owing to the decreased kinetic energy of the aetherial currents at the increased distance.

So that, at this point of the earth's orbit, the difference between the two axes of the moon's orbit will be the least, and its orbit at that point will be the nearest approach to that of a circle. But, as we have already seen, as soon as the earth leaves this part of its orbit, and begins to get nearer to the sun, it passes into a part of the aetherial medium possessing greater kinetic energy, with the result that its own velocity is accelerated. Now what is the effect of this increased acceleration of the earth on the eccentricity of the orbit of the moon?

The earth's rotation on its axis remains unaltered during this increasing orbital velocity, consequently the aetherial currents generated by the earth will remain uniform, and the moon will still be circled round the earth in the same period of about

28 days. But while the time of the moon's revolution remains unaltered, the orbit that she has to describe is now increased owing to the increased orbital velocity of its central body, with the result, that by the time the earth gets to that part of its orbit represented by point *D*, it is then two millions of miles nearer to the sun than at point *C*, and will be circled round the sun by the aetherial currents at a much greater rate. Therefore, the eccentricity of the moon's orbit is increased just in proportion to the increased velocity of the earth in its orbit round the sun. By the time the earth has arrived at point *A*, when it is only a distance of about 91 millions of miles from the sun, it reaches the minimum distance, and is circled round at the decreased distance with its maximum velocity.

At this point, therefore, the eccentricity of the orbit of the moon will be at its greatest, and, if one revolution could be represented by an ellipse *E G H*, then that ellipse would be more elongated, and the difference between the two axes of the moon's orbit would be greater than at any other point of the earth's orbit.

Thus it can readily be seen that the eccentricity of the moon's orbit is primarily due to the different velocities of the central body, in this case the earth, as that body is carried round its central body, the sun. Where the earth's motion is slowest, there the eccentricity of the moon's orbit will be at a minimum; but where the earth's velocity is greatest, there the eccentricity of the moon's orbit will be at a maximum.

Between this minimum and maximum velocity of the earth in its orbit there is the constant increase or decrease in the eccentricity of the orbit of the moon; the eccentricity increasing as the orbital velocity of the central body increases, and decreasing as the orbital velocity of the earth decreases. A further fact has, however, to be taken into consideration, which is that the primary body about which the moon revolves is itself subject to the same eccentricity of its orbit, and for similar reasons, as we shall see later on. So that when the eccentricity of the earth's orbit is at its greatest, then the moon's orbit will possess its greatest possible eccentricity, and as the eccentricity of the earth's orbit is dependent upon the orbital velocity of the sun, so the greatest possible eccentricity of the moon's orbit is indirectly connected and associated with the sun's motion through space, which motion will now be considered.

ART. 107. *The Sun and Kepler's First Law.*—We have learned in the previous articles that Kepler's Laws not only apply to planetary motion, but are equally applicable to the motion of all satellites as they revolve round their respective planets.

The question now confronts us, as to whether Kepler's Laws

are equally true in their application to the sun? Now the sun is one of the host of stars that move in the vast infinity of space, and if it can be proved that Kepler's Laws hold good in relation to one star, as they do in relation to all planets and satellites, then such a result will have a most important bearing upon the motions of other stars, and we shall be able to determine with some degree of exactness what are the motions and orbits by which all the stars in the universe are governed.

Sir Wm. Herschel first attacked the question as to whether the sun, like all the other stars, was in motion, and if in motion, what was the shape of its orbit, and the laws which governed its orbital velocity.

We know that the sun is the centre of the solar system, and the question to be considered is, whether that system is circled round a controlling centre while the sun is at rest in space, simply possessing its one axial rotation, or whether, like every planet and satellite, it is subject to two motions, an axial rotation and an orbital velocity through space. Further, if it possesses an orbital velocity through space, what is the cause of that orbital velocity?

It was due to the genius of Sir Wm. Herschel to first solve this problem, and by careful research he was able to determine that the sun, with all its attendant planets, was indeed moving through space.

Not only did he discover this fact, but he also found out the direction in which the whole of our solar system was moving, as well as the velocity with which the general movement was performed. Herschel proved that the onward march of the solar system was in the direction of the constellation of Hercules, and that the velocity of the march of this system exceeds five miles per second, or 500,000 miles per day.

Thus we learn that the whole of our solar system, comprising the sun, with all its planets with their attendant satellites which circle round each planet, and the asteroids or minor planets, are bound together by the two forces, the centripetal and the centrifugal, while the system as a whole is urged on its way by some force or power through the realms of space.

What that power is we shall try to find out as we consider the application of Kepler's Laws to this onward movement of the sun. If, then, the sun is moving through space with this enormous velocity, the question arises as to what is the shape of the path or orbit which it describes? Sir Wm. Herschel attacked this question from a mathematical standpoint, and came to a certain conclusion, as we shall see. We will, however, attack the problem solely from the philosophical standpoint, by applying to it the Rules of Philosophy given in our first chapter, and we

will then see whether our result is in harmony with the conclusions arrived at by Sir Wm. Herschel.

Now what has experience and observation to tell us regarding the orbit which any body moving in space assumes? Take, for example, our moon as illustrating the movement of all satellites, and our earth as illustrating all planetary motion.

What does observation teach us as to the orbits which these bodies describe? If it teaches us anything at all, it teaches us that every satellite and planet moves with varying velocity in a varying orbit around some central body. So far as our observation goes, then, in relation to planetary motion, or the motion of satellites, we learn that every body which moves in space fulfils Kepler's First Law, and describes an orbit round a central body, that body occupying one of the foci.

Thus, wherever we get any body moving in space, if there be any truth in philosophy which is based on experiment and observation, that body ought also to move in similar elliptic orbits, and be subject to exactly similar conditions governing those orbits. But we have learned that the sun moves through space with a velocity of about five miles per second, therefore it follows, philosophically, that the sun must also move around some other central body, and the path of such movement is that of an elliptic orbit, with the central body around which it moves occupying one of the foci.

In other words, the sun obeys the first of Kepler's Laws, the same as all the planets and satellites do. Suppose, for a moment, that it is denied that the sun moves in an elliptic orbit! What path would it pursue in place of that? Would the path be that of a straight line towards the constellation of Hercules? Such an assumption would be altogether unphilosophical, as it is contrary to all experience and observation, and is therefore untenable.

Before such an assumption can be made, it must be proved that every planet and satellite moves in a straight line, and not till that has been done can it be assumed that the sun moves in a straight line, or indeed in any other path than that stated in the first of Kepler's Laws.

This conclusion is in perfect harmony with the conclusion arrived at by Herschel, for in his work on *Astronomy*, in Arts. 292, 295 and 297, he points out that the sun's path is elliptic in form, and that Kepler also showed the sun fulfilled the first of his laws, and described an orbit which was in the shape of an ellipse. We have therefore philosophically arrived at the conclusion that the sun moves in an elliptic orbit, and to do so it must move round some central body, which is to the sun what the sun is to the planets, and what the planets are to the satellites.

It is impossible to conceive of the sun moving in an elliptic orbit, and yet not moving around some central body, as we should have a celestial phenomenon altogether opposed to all experience and observation. For we have already seen that the central body is just as important a factor to the elliptic orbit as the planet itself, because, without the central body there cannot possibly be any elliptic orbit. Where then in the universe is the central body around which the sun revolves? What is its distance away from the sun? What is its size? These are questions that philosophy alone cannot answer, as there is no law, so far as I can see, that regulates the size and distance of the central body in proportion to the size and distance of the planets or satellites.

If there were, then it would be possible for philosophy to apply such a law or rule. That there is a central body around which the sun revolves is as true as the fact that there is a central body about which each planet revolves, or each satellite revolves, and it remains for the practical astronomer, or the mathematician, to endeavour to discover the exact part of the heavens in which it is situated, and ascertain its distance and possibly its size. What will be the effect of the existence of this central body of the sun upon the solar system? One effect will be to do away with that isolation that up to the present has apparently existed with regard to our solar system and stellar space.

Instead of the solar system being a solitary system that moves through space subject to apparently no law, and moved by apparently no physical power, that system, through the influence and effect of the aetherial currents originated by that central body, will be linked to other parts of the universe, and will become a part of one harmonious whole, its physical connection being made manifest and plain in the self-same electromagnetic Aether medium that forms the connecting medium between the satellites and planets, or the planets and the sun.

Another result will be, that as the sun is a star, we shall be able to apply the self-same principles and laws of Kepler to the stellar world in exactly the same way that we have done to the solar system. Thus, by bringing all stellar phenomena under the influence of Kepler's Laws, we shall be able to philosophically give an unity to the universe, and show, within rational limits, how such unity may be physically conceived, which result will be an advance upon any physical conception of the universe hitherto manifested or revealed. Further, by accepting the first of Kepler's Laws in relation to the sun, and admitting the existence of a central body, we shall be able then to apply the second of Kepler's Laws, and by so doing shall be able to give a

physical explanation of two scientific facts which up to the present have never been physically explained, viz. the physical conception of the plane of the ecliptic, and a physical explanation of the eccentricity of the earth's orbit, which is but the result of the application of Kepler's Second Law to the sun's orbital motion around its central body.

ART. 108. *The Sun and Kepler's Second Law.*—We will now proceed to apply the second of Kepler's Laws to the orbital motion of the sun, and, in so doing, shall find we are able to give at the same time a physical explanation of the eccentricity of the earth's orbit.

In order to obtain a physical conception of the sun's orbital motion according to Kepler's First Law, it is essential that we should consider the effect of the existence of a central body around which the sun revolves; or, to put the matter into another form, we will ask the question as to what is the physical cause of the sun revolving round that central body?

Let us look at the case for a moment. Here, according to astronomical observation, we find a certain phenomenon which takes the form of a huge body 865,000 miles in diameter moving through space with a velocity of nearly 500,000 miles per day. What then is the physical cause of the movement of this large sphere?

Certainly there must be some physical cause, or else we have a violation of all experience, which indisputably teaches us that no body moves unless it is either pushed or pulled. We have, however, done away with a pulling power so far as the cause of the actual revolution of bodies around a central body is concerned, and in its place have substituted a medium that pushes or carries them round each central body. For over 200 years the scientific world has accepted a pulling power, that is, an attractive power, solely as the cause of the movements of celestial bodies, with the result that the physical cause of all the motions of planets and satellites has been outstanding and undiscovered.

It would, therefore, be unphilosophical to revert to the old conception of a gravitating attractive power as the sole cause of the sun's orbital motion through space. If we desire to know what is the cause of its revolution round that central body, then we must seek to find the same from the result of observation and experience in other directions.

We have learned from Art. 102 that the orbital motion of the moon is caused by the electro-magnetic Aether currents that circulate round its central body, the earth. By the same means every satellite is circled round its central body also. We have also learned from Art. 99 that the earth is carried round the sun

by the circulating and rotating electro-magnetic Aether currents, and that these same currents also form the physical cause of the revolution of all the other planets round their central body, the sun.

Thus we arrive at the fact that wherever there is a body moving in space, it is moving solely because it is pushed along, or carried round its controlling centre by the rotating Aether currents. But we have just learned that the sun is moving through space, and that it describes an elliptic orbit around some central body in accordance with Kepler's First Law. So that the only philosophical conclusion that we can possibly arrive at in relation to the orbital motion of the sun is, that such motion is caused by similar electro-magnetic Aether currents whose circulating motion is partly caused by the rotation of that central body.

Thus we are led up to the philosophical conclusion, that it is the aetherial currents of the central body around which the sun revolves, that produce, and alone produce, the onward motion of the sun through space. Any other conclusion must be unphilosophical, and therefore untenable. We have, therefore, to conceive of the sun's central body generating and giving rise to electro-magnetic aetherial currents that extend through space to the limits at least of the solar system, and these aetherial currents, acting upon the sun's huge form by their kinetic energy, carry it with all its associated worlds through infinite space.

There is nothing extravagant in this conception, when we remember that the solar system has been moving on and on through infinite space year after year, and yet it never seems to get appreciably nearer to the other stars, but I hope to show the reason of this by strictly philosophical reasoning later on. With this conception of the sun in its relation to its central body we are now in a position to consider the application of Kepler's Second Law upon the sun's orbital motion, and its resultant effect upon the orbit of our earth and all the other planets.

From Kepler's Second Law we know that equal areas are described by the radius vector in equal times, and if the first law of Kepler is at all applicable to the sun, then it must follow that if the sun has an orbit, and moreover an elliptic orbit as stated by Kepler himself, then, as a natural result, the radius vector of the sun must move over equal areas in equal times.

The physical explanation of Kepler's Second Law was given in Art. 103, and there is no need to traverse the same ground again. It is, therefore, true that the sun moves faster in certain parts of its orbit than in others, being urged through space at its greatest velocity when it is nearest its controlling centre, and slowest when farthest away from that controlling centre.

Herschel, in his work on *Astronomy*, states: "The motion of the sun will be such that equal areas are thus swept over by the revolving radius vector in equal times in whatever part of the circumference of the ellipse the sun may be moving." He, however, suggested that the earth forms a focus of the sun's ellipse, a suggestion which is unphilosophical, it seems to me, as we might equally suggest that the earth revolves round the moon, which is contrary to all observation. Thus the sun is not carried uniformly through space by the aetherial currents of its central body, because it is nearer to that central body at certain times; its velocity being regulated by its distance from that body, the same being increased as the distance is decreased, and decreased as the distance increases.

Now if this reasoning be correct, and if the sun really moves round a central body and is subject to Kepler's Second Law, then that increase and decrease of distance will be made manifest in the increase and decrease of the eccentricity of the earth's orbit.

So that if the eccentricity of the earth's orbit should vary from century to century, then we have conclusive evidence that the sun obeys the first and second of Kepler's Laws, and therefore that it revolves around a controlling centre of its own. From observation we find that this is exactly what is happening, and that at the present time the eccentricity of the earth's orbit is gradually diminishing, and in about 24,000 years the orbit will be very nearly a circle.

Now, from what was stated in Art. 106, we know that the moon's orbit will be nearly a circular orbit when the earth is farthest from the sun, and that then its orbital velocity is at a minimum.

In order for this result to be produced, the earth must reach that part of its orbit known as aphelion, where the distance from its controlling centre is greatest, so that the eccentricity of the moon's orbit is always an indication of the position of the earth in its relation to the sun. When the eccentricity of the moon's orbit is decreasing, the earth's distance from the sun is increasing, but when the eccentricity of the moon's orbit is increasing, then the earth's distance from the sun is decreasing.

Now if we apply this analogy to the eccentricity of the earth's orbit, we shall be able to obtain some idea of the relation of the sun to its central body. We find then that the eccentricity of the earth's orbit is decreasing, therefore, arguing from analogy, we arrive at the conclusion that the sun's distance from its controlling centre is increasing, and that its orbital velocity is decreasing.

If it be true that in 24,000 years the earth's orbit will be

nearly circular, then it follows that in 24,000 years the sun will be at that part of its orbit corresponding to the aphelion of the orbit of the earth, that is, its distance from its controlling centre will then be at a maximum. After that the eccentricity of the earth's orbit will begin to increase, and will continue to increase for about 40,000 years, according to some scientists, which implies that the sun will then have started from its aphelion point, so to speak, and will begin its return journey towards its central body, gradually getting nearer and nearer. As it gets nearer its orbital velocity will be proportionately increased, with the result that the eccentricity of the earth's orbit will increase also. From a consideration of the movement of the major axis of the earth's orbit, which is moving forward at the rate of 11° per year, we are told that a whole revolution will be made in 108,000 years.

We have here, then, an indication of the time that the sun takes to revolve round its central body, because the time of the whole revolution of the eccentricity of the orbit should correspond with one complete revolution of the sun around its central body. So that from a consideration of the eccentricity of the earth's orbit, we are not only able to demonstrate that the sun satisfactorily fulfils the first and second of Kepler's Laws, but, conversely, we are able to give a satisfactory physical explanation of the cause of the eccentricity of the earth's orbit, which explanation is again primarily to be found in the universal Aether medium.

ART. 109. *Plane of the Ecliptic and Zodiacal Light.*—As already pointed out, another phenomenon which can be physically accounted for by the sun's orbital motion through space around its central body, is that celestial plane known as the Plane of the Ecliptic.

What then is the Plane of the Ecliptic whose physical explanation we are to attempt? We know that the moon revolves round the earth as the earth revolves round the sun, while the sun is pursuing its way through space. It has been found also, that all these motions of these different bodies take place on one level, so to speak; that is to say, they do not go up or down in space, but straight on.

So straight do they move, that their path has been likened to the level of the ocean, on which a ship may sail for thousands of miles, always keeping the same level and even course. On some such ocean as this in space all the planetary systems and solar systems seem to move, ever moving on and on with the same uniformity of level through infinite space. Further, this plane of the ecliptic is to the celestial sphere what the sea-level is to the earth. The height of a mountain on the earth is stated to be so much above the sea-level.

In a similar way astronomers say that a star is a certain height above the plane of the ecliptic. What then is the physical explanation of this scientific term? We will lead up to it by first considering the effect that rotation has upon a liquid body.

It has been demonstrated that if a mass of oil is placed in a transparent liquid of the same density, so long as the oil is perfectly at rest, its shape will be that of a sphere which will float about in the liquid, but as soon as the oil is made to rotate by means of a piece of wire, then the spherical shape is changed into that of an oblate spheroid.

Further, the faster it is made to rotate, the more it will bulge out, so that its equatorial diameter will greatly exceed its polar diameter. The same principle may be illustrated by making a hoop to revolve rapidly on its axis, when a similar effect of bulging out will be produced.

Now let us apply this principle to the earth with its electro-magnetic Aether currents circulating round it, and ask what is the effect of the rotation first upon the earth, and then upon the rotating Aether currents?

It is a matter of common knowledge that the effect of rotation upon the earth when it was in a fluid state was to make its equatorial parts bulge out as it rotated, with the result that as it solidified the equatorial diameter exceeded the polar diameter by 26 miles.

If, therefore, the result of rotation upon the earth when in its fluid state was to make it spread out greater in the equatorial regions than in any other part of its surface, what must be the effect of a similar rotation upon the rotatory Aether currents? It can easily be seen that the rotation of these currents will be to make them spread out into space in a region which corresponds to the equatorial regions of the earth, so that the rotating Aether currents will be congregated more in the equatorial regions of the earth than in any other part of the earth's surface. The further also they extend into space the less depth they will have, gradually tapering off, as shown in the illustration, where *E* represents the earth and *BC* the Aether currents (Fig. 29).

Any body, therefore, situated within the sphere of their influence would be carried round the earth by the currents, and the currents would be to them their governing and controlling level.

So that the moon, which is held bound to the earth by the two opposite and equal forces, would always be carried around the earth by those electro-magnetic Aether currents, and outside of those currents it could not pass. But the earth is only 8000

miles in diameter, therefore if the currents gradually tapered off as suggested, by the time the aetherial currents reached the distance of the moon, their depth would not exceed 2000 or 3000 miles.

The diameter of the moon is, however, only 2160 miles, so that the rotating Aether currents would practically form an ocean in which the moon would swim, and one constant level on which it revolves in space. Wherever the earth was carried by the aetherial currents of the sun, there the aetherial currents of the earth would carry the moon, its mean distance by the conjoint working of the two co-equal forces having been permanently fixed.

So that it can be readily seen, as regards the moon, that the earth's aetherial currents form the plane on which it revolves around the earth. Now in exactly the same way it can be proved that it is the sun's aetherial currents which form the

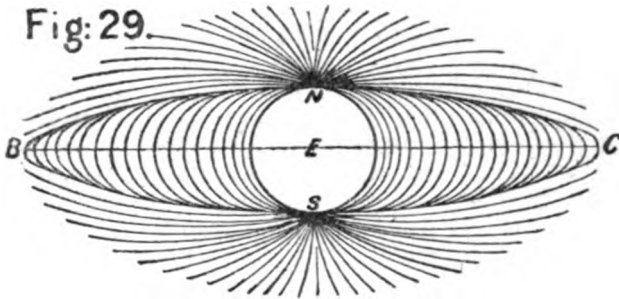

plane or level on which all the planets revolve or are carried around their central body. We have only to enlarge our conception and the same result follows. Instead of dealing with a body 8000 miles in diameter, we are now dealing with a body 865,000 miles in diameter, and as this huge body is more or less in an incandescent state, the aetherial currents will therefore be proportionate in intensity and flow to its size and atomic activity.

Instead, therefore, of the aetherial currents which circulate round the sun only extending a quarter of a million of miles, their energy and flow extend far away into space, even beyond the greatest distance of Neptune, a distance of 2,800,000,000 miles. The same truths apply here, however, as in the case of the earth and the moon. The aetherial currents which circulate round the sun congregate together, and possess their greatest depth nearest to the equator, while the further away they recede, the less and less depth they possess, with a decreased intensity and decreased kinetic energy. These Aether currents will be to

all the planets, therefore, what the earth's aetherial currents will be to the moon, being to them the ocean level on which they alone can move, and by which they are carried round their central body.

Thus these currents will form for all the planets the level in infinite space upon which they float, and from which they cannot pass. Let us further consider the movements of these currents in space, and we shall find further confirmation of this fact by so doing. Astronomers tell us that it takes light about three and a half years to reach us from the nearest star. By calculation, therefore, we find that the nearest star to our system is about 205,000,000,000,000 miles away, that being about the distance that light travels in three and a half years.

The diameter of the sun is about 865,000 miles, so that the distance of the nearest star is 240,000,000 times the diameter of the sun. We could therefore put 240,000,000 of our solar systems in the space that exists between us and the nearest star. How is it, then, that all the planets as they revolve round the sun do not float up and down in the space that extends between us and the nearest star?

I can give no other answer, and can see no other possible physical explanation than the one already given, which is, that they are bound to the sun by the two co-equal forces, the centrifugal and centripetal forces, and while so bound are carried round the sun by the electro-magnetic aetherial currents which extend out into space. It has to be remembered that the aetherial electro-magnetic currents circulating round the earth are situated within the aetherial currents which circulate round the sun, therefore the plane of the moon's orbit will coincide more or less with the plane of the earth's orbit. We have now only to go one step further to get our complete conception of the plane of the ecliptic.

In Arts. 107 and 108 we learned that the sun was subject to Kepler's 1st and 2nd laws, and as a natural result we came to the conclusion that it, too, was circled round some central body. We have only to apply a similar course of reasoning to the sun and its central body as we have to the moon and the earth, and the earth and the sun, and then we arrive at our physical conception of the plane of the ecliptic, which is due to the aetherial currents that circle round the sun, while that body is carried round some other central body.

Thus by the circulating Aether currents, originated and out-flowing from their respective sources, each source being immutably fixed and bound to each other by the two equal and complementary forces, can be accounted for, the uniformity of position and plane of the various orbits of the various satel-

lites, planets, and the sun, as they move in one great plane, termed the Plane of the Ecliptic.

It could not be otherwise than it is, and thus another celestial phenomenon can be accounted for on a real tangible basis by accepting the existence of those aetherial currents which form the physical basis of all the celestial mechanism.

If further evidence were required of the existence of these rotating Aether currents round the sun, such evidence is found in that phenomenon of the solar system known as the Zodiacal Light, of which up to the present no physical explanation has been forthcoming. In the conception of the atomic and gravitating Aether which rotates round the sun, I venture to premise will be found the physical solution of this phenomenon also.

I will refer the reader to an extract taken out of *Outlines of Astronomy*, by Herschel (Art. 894), so that we may see what his conception of the zodiacal light was, and we will see how far his explanation is in conformity with our hypothesis of an atomic, gravitating and rotatory Aether medium.

He writes: "We shall conclude this chapter by the mention of two phenomena, which to me indicate the existence of some slight degree of nebulosity about the sun itself, and even to place it in the list of nebulous stars. The first is that called the Zodiacal Light, which may be seen any very clear evening soon after sunset, about the months of March, April and May, as a cone or lenticularly-shaped light extending from the horizon obliquely upwards, and following generally the course of the ecliptic, or rather that of the sun's equator. The apparent angular distance of its vertex from the sun varies, according to circumstances, from 40° to 90° , and the breadth of its base perpendicular to its axis from 8° to 30° . It is extremely faint and ill-defined, at least in this climate, though better seen in tropical regions, but cannot be mistaken for any atmospheric meteor or aurora borealis. It is manifestly in the nature of a *lenticularly-formed envelope surrounding the sun*, and extending beyond the orbits of Mercury and Venus, and nearly, perhaps quite, attaining that of the earth, since its vertex has been seen fully 90° from the sun's place in a great circle. It may be conjectured to be no other than the *denser part* of that medium which we have some reason to believe resists the motions of comets; loaded perhaps with the actual materials of the tails of millions of those bodies of which they have been stripped in their successive perihelion passage. If its particles have inertia, they must necessarily stand with respect to the sun in the relation of separate and independent minute planets, each having its own orbit, plane of motion, and periodic time."

Let me call the reader's special attention to one or two state-

ments of Herschel's given in this extract, in order to see how these statements harmonize with the view of the Aether submitted in this work. In the first place he states its shape is that of a lenticularly-formed envelope surrounding the sun, and extending beyond the orbits of Mercury and Venus, and probably to our earth. This harmonizes with the shape of the aetherial envelope as given in Art. 70. Then Herschel states it may be the denser part of that medium which we have reason to believe resists the motions of comets. That is exactly what it is, though Herschel failed to show why it should be the denser part of the Aether, as we have seen is the case, on account of its being gravitative. I will also prove later on, that Herschel was right with regard to the resistance of the motion of comets through it. Then he refers to its particles probably possessing inertia, as though he had anticipated the atomicity of the Aether, and assuming that atomicity, he was compelled to postulate inertia also as we have done in Art. 48.

Lastly, he points out that each separate particle must have its own plane of motion, its own orbit, and its periodic time. Now this view fully coincides with that laid down in this article, where we have learned that the rotating Aether has its own plane of motion, that plane being the Plane of the Ecliptic, and as every particle or atom has its allotted place in the rotating Aether, then, as Herschel points out, the particle must have its own orbit, and plane of motion, and also its own periodic time. If, therefore, we had desired fuller confirmation of this atomic gravitating Aether, we could not have wished for more conclusive proof than that given by one of the greatest philosophical astronomers of the last century. We shall see later that Herschel also had a clearer view of cometary phenomena, and of the forces which played a part in those phenomena, than any of his contemporaries, when we deal with the origin and motions of all comets. Thus from Herschel we learn that the zodiacal light is caused by the atomic, gravitating, and rotatory Aether as that aetherial medium revolves round the sun, while at the same time every atom of the medium is itself in a state of rotation on its axis, as it performs its journey in its own orbit and in its own plane of motion.

ART. 110. *Centripetal Force*.—We have now to consider what is the physical cause of that part of the compound Law of Gravitation known as the Centripetal Force. As we have already learned (Art. 10), this force is really none other than the Attractive Force of Gravitation, in that its mode of operation always acts towards the centre of the attracting body, and hence was called by Newton the Centripetal Force.

The centripetal force is, however, the exact counterpart and complement of the centrifugal force, in the same way that the latter is the exact counterpart of the former, as we have already learned that the centrifugal force operates along the same path, and that it is subject to the same law of proportion, being equal to the product of the masses of a body (Art. 85), and further, that its intensity is inversely as the square of the distance (Arts. 66, 74 and 84).

We have, however, discovered that the physical cause of the centrifugal force is due to the pressure of the electro-magnetic Aether (Art. 96). If, therefore, the physical cause of that law which is the complement and counterpart of Gravitation Attraction is to be found, and alone found, in the pressure and motions of the electro-magnetic Aether, then it is only logical and reasonable to infer that the physical cause of the Attraction of Gravitation is to be found in the same electro-magnetic Aether. That the Attraction of Gravitation is to be found in this medium is now an accepted hypothesis among scientists. Because, unless the physical cause of Gravitation Attraction is to be found in this electro-magnetic Aether, then, in order to account for that attraction, we should have to postulate the existence of another medium in space, in lieu of the Aether, which would be to the centripetal force what the Aether is to the centrifugal force. This would be distinctly unphilosophical, as it would be a violation of the first two rules of our philosophy, in that it would not be simple in its conception, and that such a hypothesis would imply the existence of two media which would occupy the same planetary and interstellar space at one and the same time, and this is a violation of all experience in its widest form.

Therefore the physical cause of Gravitation must be sought for in the same medium which gives the physical cause of the companion force, and that medium is the electro-magnetic Aether. Professor Preston in his *Theory of Light* is of this opinion. In Art. 327 he writes: "To account for the propagation of heat and light, that is, of radiant energy, we have postulated the existence of a medium filling all space. But the transference of the energy of radiant heat and light is not the only evidence we have in favour of the existence of an Aether. Electric, magnetic and electro-magnetic phenomena and Gravitation itself point in the same direction."

Professor Lodge, in his *Modern Views of Electricity*, is even more explicit in his statement of the case. On page 338 he states: "Gravitation is explainable by differences of pressure in the medium (*i. e.* the Aether) caused by some action between it and matter not yet understood." Further, Newton himself suggested that the physical cause of Gravitation Attraction

was to be found in that aetherial medium which pervaded all space.

If, therefore, we attempt to explain the physical cause of Gravitation Attraction by the tensions of the universal Aether, we shall not only be dealing with the subject from a philosophical standpoint, but we shall solve the problem in that direction in which Professors Preston and Lodge and other scientists have suggested we are to seek for the solution. Professor Curry, in his *Theory of Electricity and Magnetism*, page 406, states: "If we regard the luminiferous Aether, as defined by Von Helmholtz's equations, as the given medium or transmitter of so-called gravitating action, we are then able on the one hand to interpret its longitudinal oscillations as gravitational waves propagated through space with the given enormous velocity, and on the other hand, to form some conception of the mysterious force of Gravitation itself, for we can then conceive it as a medium stress arising from a certain type of Aether oscillations, its longitudinal ones, that pervade entire space."

Now in order for us to lead up to the physical cause of the centripetal force, we must recall some of the facts already given with regard to planetary and solar space. Thus we have learned that the sun is an electro-magnet possessing its own magnetic field, with its lines of force (Art. 88). We have also learned that all the planets are electro-magnets, each possessing its own field with its lines of force (Art. 91).

We have further seen that the cause of all this electro-magnetism is due to the fact that electric currents are continually circulating round each body, and by their conjoint action with the magnets there are produced the electro-magnetic fields that are associated with each body in the solar system. From this hypothesis we arrived at the conclusion, that wherever there was Aether, there we found electricity, because of the electro-magnetic basis which Aether possesses. This result is fully confirmed by Maxwell's electro-magnetic theory of light (Art. 78), which has been so fully experimentally demonstrated by Hertz. Indeed, in the minds of several scientists there is a growing conviction that Aether and Electricity are possibly one and the same substance.

Professor Lodge, in the work already referred to, in relation to this hypothesis, writes in the preface to that book: "Crudely, one may say that as heat is a form of energy, so electricity is a form of Aether, or a mode of aetherial manifestation." And again: "A rough and crude statement adapted for popular use is that *Electricity and Aether are identical*. But that is not all that has to be said, for there are two opposite kinds of electricities, and there are not two Aethers. But there may be two

aspects of one. Aether, just as there are two sides to a sheet of paper."

As, therefore, we learn that Aether has an electro-magnetic basis, and that electricity is a mode of aetherial manifestation, we have therefore to consider one of the most fundamental laws of electricity, and note its application to solar and planetary space.

It is one of the fundamental laws of electricity, that equal and opposite quantities of electricity are always generated at one and the same time. Faraday's well-known ice-pail experiment proved this. It is an absolute impossibility for one kind of electricity to be generated without an equal quantity of the opposite kind being produced, although it is not strictly correct to use the term generated or produced in relation to electricity, as electricity cannot really be produced by any process whatever.

Another way of stating this law is, that the total induced charge on any body is always equal and opposite to the inducing charge. So that if we look upon the sun as an electrified body (Art. 80) surrounded by the aetherial envelopes or shells, then we can conceive of the inductive action of the sun upon any planet as taking place along the tubes of force in the Aether, which tubes are sections of the spherical envelopes that surround it. But this inductive action implies the existence of the very law already enunciated, viz. that equal and opposite quantities are always generated at one and the same time, and before that law can become operative in relation to the Aether, it must be postulated that the Aether possesses a dual character, that is, it possesses a positive and negative electrical basis.

This view of the Aether has already been developed by Dr. Larmor in his *Electron Basis of the Aether*, as in that hypothesis he postulates both positive and negative electrons. In his *Aether and Matter* he writes, page 3: "It assumes that the mass of each sub-atom is proportional to the absolute number of electrons, positive and negative, that it carries, and that the effective inter-atomic forces are entirely or mainly electric." Further, Professor Lodge on this point writes:¹ "We now proceed a step further and analyze the Aether into two constituents, two equal opposite constituents, each endowed with inertia and each connected to the Aether by elastic ties. The two constituents are called positive and negative electricity respectively, and of these two electricities we imagine the Aether to be composed." Again, later on, p. 349 of the same work, he adds: "Is Aether electricity then? I do not say so, but that they are connected there can be no doubt. What I have to suggest is, *that positive and negative electricity together may make up the Aether.*"

¹ *Modern Views of Electricity*, p. 221.

Now, accepting this as correct, and I will prove that it is correct later on, from experiments performed by Faraday, we can see how the inductive action of the sun may be transmitted through space, and how that inductive action will effect any body in its electrical field, such inductive action always taking place through the polarization of the atomic Aether, and taking the form of an attractive power which is exerted towards the centre of the attracting body.

Further, this inductive action will be subject to the same laws of electricity as the centrifugal force is, which is the repulsive power due to the pressure of the Aether. Therefore the inductive action of the sun upon any body will, according to the laws of electricity, act inversely as the square of the distance (Art. 84), and will be directly as the product of the charges on the two attracting bodies, which we have seen according to Art. 85 is equal to the product of their masses. Not only will this inductive action apply to the sun, but it will equally apply to all planets, satellites and stars that exist in the heavens, each of these bodies according to Art. 80 being an electrified body possessing its electric field and lines of force radiating out into space.

Thus we arrive at the conclusion, that each body in the solar system is not only the centre of a centrifugal force due to the pressure of the electro-magnetic Aether, but that it is also the centre of an attractive force due to the existence of the positive and negative elements of the Aether, and of their attractive power for each other.

This attractive power is also subject to exactly the same laws that the centrifugal force is subject to in regard to intensity, proportion, and the direction which it takes. So that we have now two centripetal forces existing in space, which exactly correspond with each other, viz. Gravitation Attraction and the attraction due to Electrical Induction. The cause of one, however, is known, being due to the inductive influence of the various electrified bodies that exist in space, which inductive influence can be traced through the whole of the atomic Aether that exists between the two bodies, whereas the cause of the centripetal force or Gravitation Attraction is unknown. According to the Rules of Philosophy, therefore, it will be much simpler if we replace our Gravitation Attraction, whose cause is unknown, by the inductive power of the various bodies, the physical cause of which lies in the electro-magnetic Aether, or the dielectric as Faraday called it. In other words, we are compelled to come to the conclusion that the centripetal force, or Gravitation Attraction so called, is an electrical phenomenon, which finds its physical cause in the same universal Aether that the centrifugal force does.

Unless this view of the attraction of Gravitation is accepted, we should have two forces operating between all bodies, both operating at exactly the same time, in exactly the same direction, and with exactly the same intensity, and this phenomenon according to Newton would be unphilosophical. In Art. 4 we learn that Newton in the first rule states that "Nature is simple, and does not abound in superfluous causes of things." And again: "In the nature of Philosophy nothing is done in vain; and by means of many things, it is done in vain when it can be done by fewer." Here then we have apparently two forces which act in the same molecular or planetary or interstellar space, at one and the same time. Therefore if this be true, Nature does abound in a superfluous cause, because we have two forces in existence where one will suffice, and one of them therefore exists in vain. So that it will be philosophical if we do away with one of the causes, and replace the two causes by only one. Now which shall be done away with—the electrical attraction which is due to a physical medium, the electro-magnetic Aether, or the Gravitation Attraction, that is caused by some virtue of a body of which we have no knowledge, which is transmitted through space in a way that we cannot understand, and acts upon distant bodies in a manner altogether outside our usual experience and observation? There can only be one answer. If either of the two forces has to be done away with, it must be the mysterious, intangible, unphilosophical attraction of Gravitation, which must be replaced by the philosophical and known attraction of electricity, which can be traced to a physical medium, the electro-magnetic Aether that joins atom to atom, molecule to molecule, satellite to planet, planet to sun, and sun to star, and so gives unity to the universe of worlds. From philosophical considerations, therefore, we are compelled to come to the conclusion that the attraction of gravity and electrical attraction are one and the same.

Faraday arrived at this conclusion and performed certain experiments to confirm that conclusion, but he was unable to experimentally prove the truth. It does not follow, however, that because he failed to experimentally establish the connection, therefore the conclusion is wrong. In his *Experimental Researches* he writes, par. 2705, "On the possible relation of gravity to electricity":—"First of all, a body which was to be allowed to fall, was surrounded by a helix, and then its effect in falling sought for." This experiment Faraday states produced negative results (par. 2706). "A solid cylinder of copper was introduced into the helix, and carefully fastened to it, and this compound arrangement was allowed to fall." "The result of this experiment may be classified as doubtful. It gave very minute, but remarkable indications of a current in the galvanom-

meter, and the probability of these being related to gravity appeared the greater, when it was found, in raising the helix or core, similar indications of contrary currents appeared." In par. 2717 Faraday thus sums up: "Here end my trials for the present. The results are negative. They do not shake my strong feeling of the existence of a relation between gravity and electricity, though they give no proof that such a relation exists." Here then we have expressed the strong conviction of the relation that undoubtedly exists between gravity and electricity by one of the greatest scientists that has ever lived, and I believe that it is a fact that he was engaged upon experiments to prove his conviction about the time of his death.

We will now endeavour to trace the action of the Law of Gravitation in its compound working, in its application to the atomic Aether that fills all space, and by its gravitating property surrounds all bodies situated in that space. We are dealing no longer with a frictionless medium, which is incapable of accepting and transmitting motion of any kind or sort, but we are now dealing with a medium composed of atoms, which can give rise to pressures and tensions, or repulsions and attractions from any one part of space to another.

If we can prove that an atomic Aether can give rise to these pressures and tensions from one body to another, and those pressures and tensions harmonize with, and satisfactorily account for, the phenomena sought to be explained, then we shall have succeeded in making our philosophy agree with our experience, and such a result as action at a distance will for ever disappear from the mental conception of all men, as it has long disappeared from the pages of philosophical and scientific works, though that disappearance was not accompanied with a satisfactory solution of the problem.

Let us, therefore, consider these pressures and tensions, or so-called repulsions and attractions that exist in this electromagnetic Aether from the atomic standpoint, and by so doing try to realize how it is that one body, as the sun, acts upon another body, as the earth, through the intervening medium, the Aether. We can either consider it from the material standpoint, that is, by considering the Aether as matter, pure and simple, or by viewing it from the electrical standpoint, which may be considered from Clerk Maxwell's physical conception of an electric field. We will briefly consider it from the latter standpoint. Our conception of an aetherial atom was that of a spherical vortex atom possessing polarity and rotation on an axis. We must, however, make the distinction between the two kinds of aetherial atoms that Clerk Maxwell first indicated in his paper on Physical Lines of Force, *Phil. Mag.*, 1861, and that Dr.

Larmor has worked out in his *Aether and Matter* from the electron standpoint, viz. that the Aether is composed of positive and negative electrons. Or we can accept Professor Lodge's theory, that Aether is made up of positive and negative electricity. We are compelled to accept the hypothesis of two kinds of aetherial or electrical atoms, whatever they may be called, in view of the teaching of electricity, that positive and negative electricity are always to be found in association, and in combination, wherever electricity exists. We have proved that electricity is to be found throughout the realm of space (Art. 78); therefore in all planetary and stellar regions electricity is present. Thus it exists in the so-called space between the sun and planets, and between the planets and satellites, forming around them all spherical shells, that become less and less dense as they recede from the central body. Now it is by the action of these positive and negative electrical atoms, that the attraction of one body is transmitted across space from the sun to the earth, or from the earth to the sun, or from the earth to Jupiter, or from Jupiter to any of the planets, the action always taking place along the line joining the centres of gravity of the bodies, *i. e.* the radius vector, and with a force equal to the quantities of electricity in association with those bodies (Art. 85), and with an intensity that always acts inversely as the square of the distance. Thus the inductive action of any sun, planet or satellite, or any other planet or satellite, can be mentally traced from atom to atom, across the intervening space, that is filled with the atomic Aether, between any two attracting bodies. So that, if the sun attracts the earth, it attracts it by and through the motions and properties of the electro-magnetic Aether that is made up of positive and negative electricity, and that attraction, being produced by a physical medium which is as real and tangible as air or water, is brought into harmony with our experience and observation, as no body pushes or pulls another body, be it what it may, unless both bodies are joined together by some medium which transmits the push or the pull. Professor Lodge, in his *Modern Views of Electricity*, has illustrated from an electrical standpoint how the pressure and tension in any electrical field may be transmitted from particle to particle, or atom to atom. He supposes that a positive atom of electricity rotates in one direction while a negative atom rotates in the opposite direction. In any electric field these atoms are so associated with each other, that when one atom revolves, it makes the other to revolve in the opposite direction, with the result, that the spin or rotation is transmitted through the medium at a speed dependent upon the density of the medium.

For fuller details of the description I must refer the reader to

U

the work already referred to. What I wish to call the reader's attention to is, that the tension and pressure in this field is not transmitted across a vacuum, in some unknown way, but is transmitted solely by a physical medium. The action is direct, and is produced, and alone produced, continued, and perpetuated by a physical medium which is composed of atoms of negative and positive electricity. So that if one body *A* acts upon another body *B*, it acts upon *B* solely and entirely by the action of the atoms which form the magnetic lines of force, and the equipotential surfaces around the electrified body, and that action can be traced mentally step by step across the intervening space that may exist between the two bodies. It is in an exactly similar manner, that the Attraction of Gravitation, which we conceive to be the same as electrical attraction, is transmitted from body to body in the atomic, molecular, planetary or stellar world. In each and every case, the pressure and tensions, which are inseparably connected, are transmitted by the atoms of the electro-magnetic Aether, that is, by the positive and negative atoms of electricity of which, according to Professor Lodge and Dr. Larmor, the Aether is composed. So that, if the sun acts on the earth, by the centrifugal force, it acts on it solely through and by the pressures which are originated in the atomic Aether by the central body. If the sun attracts the earth, by the centripetal force, that action can also be traced to the tensions that are originated among the atoms of the electro-magnetic Aether. There is nothing mysterious about the phenomenon in either case, as by accepting this view of an atomic Aether with its dual character of positive and negative electricity, the action may be traced mentally from point to point across the so-called intervening space that exists between any two bodies. In each and every case, wherever the centripetal or centrifugal force acts, the action is direct, because it is caused by a physical medium, which physical medium is in direct contact with each body acted upon, and also fills the space between those bodies. With this view of the centripetal force of Gravitation, our Philosophy is made to agree definitely with our experience, which teaches us beyond contradiction, that no body moves, unless it is either pushed or pulled by a physical medium. Unless this view of the centripetal force is accepted, we shall have to stumble on in darkness as to the physical cause of the centripetal force, and mentally accept the unphilosophical proposition, that a body can act on another in a way that we cannot understand, and by means which lie outside our experience and observation, and this hypothesis, as Newton and Herschel pointed out, is distinctly an unphilosophical proposition.

CHAPTER XII

AETHER AND COMETS

ART. III. *Comets. What are Comets?*—In addition to the planets and asteroids which revolve around the sun, there are also other bodies termed Comets, which revolve round the solar orb.

Unlike the planets, however, they do not all keep to the plane of the ecliptic, but approach to, and recede from the sun at all angles to that plane, as well as in that plane itself. Comets are supposed to be huge masses of gaseous matter, in a more or less condensed condition. That they are not composed of absolutely solid matter is proved by the fact that it is possible to see the stars through the gaseous matter of which they are composed.

How the gaseous matter of which these comets are formed is originated, or how it is formed in solar or stellar space, has, I believe, up to the present never been explained, and indeed, with the idea of a frictionless Aether, I fail to see how any physical explanation of the origin and development of a comet can be satisfactorily given. With the conception of the Aether, however, that is put forward in this work, viz. that Aether is matter in its most rarefied and attenuated form, which can be condensed into a gaseous condition, with such a conception of the universal aetherial medium, the origin and development of gaseous matter from this Aether becomes a physical possibility.

Lord Kelvin, in the *Philosophical Magazine*, July 1902, on the "Clustering of Gravitational Matter in any part of the Universe," has already suggested the possibility of the condensation of the Aether, but with the old idea of a frictionless Aether, that is, an Aether which does not possess mass, such a hypothesis is improbable. Because, if the Aether becomes condensed at all, it must be condensed into gaseous and solid matter, and all experiments and observation teach us that both these forms of matter possess mass and weight.

Therefore, if the frictionless Aether, which possesses no mass and weight, is to be condensed into gaseous or solid matter, there must come a period in the process of condensation when it must pass out of the condition of possessing no mass and no weight,

into the condition of possessing mass and weight, which assumption is altogether opposed to those Rules of Philosophy based upon experiment and observation.

Aether can only pass into a gaseous or solid condition, in which condition it will possess mass and weight, on the assumption that in the aetherial condition it possesses the same properties, only in a modified form, which it possesses after the process of condensation has taken place. In a similar way that air can pass out of its gaseous condition into a liquid condition, or any gas can pass out of its gaseous into a liquid condition, so Aether, on the conception as given in Chapter IV., can pass out of its aetherial and rarefied condition into that form of matter which is known as gaseous. We shall deal with this aspect of Aether more fully when we come to deal with the Nebular Hypothesis, as the same principle underlies that hypothesis as underlies the origin and development of comets.

Thus, comets may be formed at any time in interstellar space out of the Aether that exists there, provided the conditions of its formation are to be found there. Then, as they are gradually formed, they would, like any other bodies, come more directly under the influence of any large bodies, as the sun, and be attracted by them.

This conception of the origin and development of a comet will also account, and that on a logical and philosophical basis, for another fact which is associated with cometary phenomena. I refer to the fact of the expulsion of gaseous matter out of the head of a comet as it nears the sun, which expulsion will be dealt with in the article on "Parts of a Comet."

Another problem that might be solved by this conception of a comet lies in the question, as to whether comets shine by their own light?

If comets are really formed of condensed Aether, as I believe them to be, then, as light is due to a periodic wave motion of the Aether, as soon as the Aether (of which the comets' tails, for example, were formed) was made to vibrate with that rapidity sufficient to produce light waves in the surrounding Aether, the tails would then shine by their own light, in exactly the same way that any other body emits light waves, as soon as its aetherial vibrations reach the rapidity necessary to produce the waves of light, which vibrations would lie between 2000 to 8000 billions per second.

The number of the comets that exist in the solar system cannot be ascertained with any degree of accuracy, but the total probably extends into millions. They are of all sizes, from those which possess diameters of several miles, to those extending over thousands of miles. They also possess orbits, with which we will now deal.

ART. 112. *Orbits of Comets.*—As has already been pointed out, comets perform their journey round the sun, not only in the plane of the ecliptic, but also at all angles relatively to that plane. In this respect they differ from the orbits of planets and satellites, which perform their journey in orbits situated wholly in the plane of the ecliptic (Art. 109).

There is another important difference between the orbits of the comets and those of the planets. In the case of the latter the orbit is that of an ellipse, while in the case of the comet the orbit may be either that of a parabola or a hyperbola, which may be looked upon as elongated ellipses open at one end. There are, however, some comets whose orbits are perfectly elliptical, and whose return may be calculated with a fair amount of accuracy.

These are known either as Short Period Comets, as represented by Faye's Comet, Encke's and De Vico's; or Long Period Comets, as represented by the comets of 1811, 1844, and 1858. In the case of all these, as their return to our solar system can be determined, it follows that they must revolve around the sun in some sort of a closed orbit, probably that of an exceedingly elongated ellipse.

There are, however, other comets which appear once, or it may be several times only, and then disappear out of the solar system for ever. Now the question arises, as to whether the orbits of the comets which are so variable can be explained by the motions of the Aether which we have already ascribed to it? We have seen (Art. 109) how it is possible to account physically for the plane of the ecliptic from the motions of the Aether, and how it is that all the planets move within that plane, but here we have a phenomenon of a different kind, as observation distinctly teaches us that the comets do not move in, or keep within the plane of the ecliptic, but gravitate round the sun at all angles to that plane.

In order for us, therefore, to be able to account, and that on a philosophical basis, for this fact, we must revert to our conception of the sun in its relation to the solar system. In Art. 88 we learned that the sun was an electro-magnet possessing its electro-magnetic field, and generating electro-magnetic waves which were radiated forth from it on every side. From Art. 89 we learn that an electro-magnetic body possesses lines of force, and that these lines of force take various directions as they are generated by the body, as proved by Faraday's illustrations. Further, a moving electro-magnet, as the sun for example, carries its lines of force with it, as proved by Maxwell.

Now these lines of force extend not only east and west, but also north and south, as depicted in Fig. 29.

Hitherto we have only dealt with the lines of force proceeding from the sun equatorially, which lines form the plane of the ecliptic. We have, now, to take into consideration those lines which extend out into space, north and south of that plane. These are not so curved as the others, but are more inclined to be straight, or less curved, as they are really parts of large curves which extend much further outwards into space.

The orbits of the Short or Long Period Comets can be explained by the fact that they perform their journey more or less in the plane of the ecliptic, though in some cases at a much greater angle than that of any of the planets. Provided, however, they remain within the influence of the electro-magnetic field of the sun, there is then a physical explanation as to their orbital motion round the sun, in a similar way to the orbital motion of the planets, though at greater angles to the plane of the ecliptic.

For we have to remember, that wherever the electro-magnetic waves of the sun's electro-magnetic field extend, there we have also the rotation of that field round its central body, though with a continually decreasing intensity, as already pointed out. Wherever, therefore, we get rotatory Aether currents, due to the rotation of the electro-magnetic field, there we get the conditions which would enable any kind of gaseous or material body to be circulated round the sun. The case, however, of comets which do not return has to be viewed from a different standpoint. Here it seems to me we are dealing with masses of condensed Aether that come within the inductive influence of the electro-magnetic waves of the sun, as that body moves through space with its velocity of about 500,000 miles per day. We have to conceive of this condensed Aether situated north and south of the plane of the ecliptic, and situated probably millions of miles away. As the sun moves onward in its journey through space, carrying its electro-magnetic field with it, then, by the inductive action of the sun, the comet would be attracted by that body, and so would be gradually drawn towards it.

Under this inductive influence it would rush towards the sun, until, approaching very close to it, it would be repelled by the electro-magnetic waves or centrifugal force of that body, and be hurled again by their repulsive energy far far away into space to the north or south of the plane of the ecliptic. As it was moving away from the sun, north or south of the ecliptic, the sun would be moving onwards through space in the plane of the ecliptic, which would practically be at right angles to the motion of the comet, so that by the time the comet had receded far into the depths of space, the sun with its electro-magnetic field would have moved on also in a direction at right angles to the comet's motion.

The effect of the sun's orbital motion would be, that it would be unable to again exert sufficient inductive power upon the comet to bring it within its inductive influence once more. For example, suppose there is a mass of Aether condensing at point *A* in interstellar space situated some millions of miles north of the plane of the ecliptic, which is represented by the straight line *BC*. The sun is moving in the direction towards the part of space represented by point *B*. We will suppose that when the sun is near point *C* the mass of Aether at point *A* is too far away to be appreciably influenced by the inductive action of the sun. But as the sun moves towards point *F*, then the condensed Aether, which practically forms the body of the comet, will come within its influence and be drawn towards the sun, at an angle to the plane of the ecliptic.

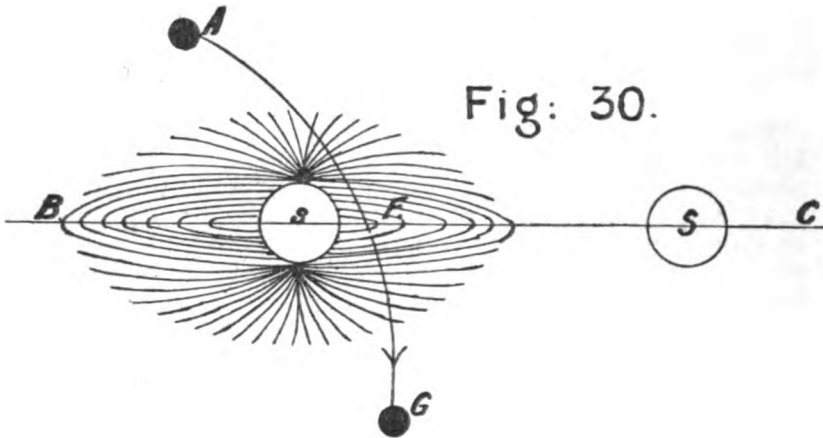

By the time the body of the comet has reached the sun, it will have acquired a momentum which enables it to rush past the sun, and then it will be repelled by the electro-magnetic waves in the direction of *FG*, which is still at an angle to the plane of the ecliptic; but its motion, combined with the repulsive power of the electro-magnetic waves, is carrying it outside the sphere and influence of the sun's electro-magnetic field. At the same time the sun is proceeding onwards through space, leaving the comet far behind, so that by the time the comet has reached the confines of the solar system, it has either passed under the influence of another star, or has become further condensed to form a meteor, which begins to circle around the largest and nearest body. I do not assert that this hypothesis is strictly correct, but it seems to me that only on some such hypothesis can the appearance and apparent loss of irregular comets be explained.

ART. 113. *Short Period Comets and Long Period Comets.*— We have seen in the previous article, that some Comets revolve round the sun in closed orbits of exceeding great eccentricity, and the return of these may be calculated with certainty. There are about two dozen comets which revolve around the sun, and which return at intervals lying between three years and 76 years.

This class of comets may be divided into two kinds, which are known as Short Period Comets and Long Period Comets respectively. The following table gives a list of the chief of the Short Period Comets, together with some particulars relating to time of revolution, etc. :—

COMETS.	PERIOD OF REVOLUTION.	PERIHELION DISTANCE.	APHELION DISTANCE.
Encke's ...	3½ years.	32,000,000 miles.	387,000,000 miles.
De Vico's ...	5½ "	110,000,000 "	475,000,000 "
Biela's ...	6½ "	82,000,000 "	585,000,000 "
D'Arrest's ...	6½ "	"	"
Faye's ...	7½ "	192,000,000 "	603,000,000 "
Halley's ...	76½ "	56,000,000 "	3,200,000,000 "

Encke's Comet was discovered by Professor Encke of Berlin, and named after him. It revolves in an ellipse of great eccentricity, as proved by the fact that when nearest to the sun, it is inside Mercury's orbit, but when furthest away from the sun, it passes beyond the orbit of Mars, reaching almost to the orbit of Jupiter. One of the most remarkable facts about this comet is, that it has done more to establish the existence of that resisting medium around the sun, whose existence we have demonstrated, than any other comet. Encke found on its periodical return that its mean distance was gradually getting less, and in order to account for this, he supposed that it was due to the existence of a resisting medium which enveloped the sun, and extended some distance into space.

This conclusion has been supported in recent years by Von Asten, a German mathematician, who has supported the theory of a resisting medium. On this point Herschel writes in his *Outlines of Astronomy*, Art. 577: "This is evidently the effect which would be produced by a resistance experienced by the comet from a very rare aetherial medium pervading the regions in which it moves; for such resistance, by diminishing its actual velocity, would diminish its centrifugal force. Accordingly, this is the solution proposed by Encke, and at present generally received."

So that we have in Encke's Comet another proof of the existence of that aetherial medium, which is not frictionless, but has the power to oppose any body which moves through it, when that body moves in an opposite direction to its own motions.

Another Short Period Comet worthy of notice is that of Biela, named after M. Biela, its discoverer. This comet had a period of six and a half years, and reappeared at several successive intervals until about the year 1845, when it seems to have been broken or split up into two parts. In December 1845 the comet divided into two parts, which travelled parallel to each other for a long distance. During this separation, very singular changes were observed to be taking place in both the original comet and its offshoot.

Both had a nucleus, and both had tails, which were parallel to each other. The comets continued to travel together until the 15th March 1846, when the new comet began to fade away, until, on the 24th March, the old comet only was visible, while in April both had disappeared entirely. A similar phenomenon was again observed at its next passage in 1852, but since then Biela's Comet has entirely disappeared. It is suggested by astronomers, that the comet has become condensed, and broken up, forming a shoal of meteors.

Support is lent to this theory by the fact that in November 1872, when the earth was passing through space and had arrived at that part of its orbit which intercepted the orbit of Biela's Comet, instead of the comet being seen, the earth came into contact with a swarm of meteors, and this is accepted as evidence that Biela's Comet was condensed far away in the colder regions of interplanetary space into a more solid form of matter, known as meteors. One of the more famous of the short period class of comets is that known as Halley's Comet, which has a period of about 76 years. This comet has been seen in its return journey to the sun about 25 times. It was named after its discoverer, Edmund Halley. He was led to identify this comet with that of 1531 and 1607, and thus to conclude that it had a period of 75 or 76 years. He therefore predicted its reappearance in 1759. As the year approached, its arrival was eagerly looked for, to see if the prediction would be verified.

It was thought, however, by a certain astronomer named Clairaut, that the larger planets, as Saturn and Jupiter, might interfere with its orbital motions, and after careful calculations a difference of 618 days was allowed, which brought its anticipated reappearance down to April 1759. It actually reappeared in March of that year. Its next reappearance was fixed to take place about November 1835. The comet became visible on 5th August 1835, and continued to be seen till April 1836, when it again disappeared.

As the reappearance of the comet was calculated by the application of the Newtonian Law of Gravitation, such a result

only gave added confirmation to the application of that law to cometary bodies.

Of the Long Period Comets there are several known. That of 1858 has a period, it is thought, of 2000 years. The 1811 comet has a period of 3000 years, while that of 1844 has a period of over 10,000 years. All these comets move in orbits of such great size that their return is improbable. One of the characteristic features about Long Period Comets is their great brilliancy and size.

The 1858 comet, known as Donati's Comet, was first seen by that astronomer at Florence in June. It was invisible, however, to the naked eye, as it only appeared through the telescope like a faint cloud of light, gradually getting brighter and brighter. Toward the end of August it began to show signs of developing a tail, and became visible to the eye on August 29th. During September and October it greatly increased in size and brilliancy, and was plainly visible in the western heavens. After October 10th it was only visible in the southern hemisphere, gradually decreasing in brightness. It was seen till March 1859, when it disappeared, and will probably not return till the year 3858, as its period of revolution is about 2000 years.

Donati's Comet passed between the earth and many stars, which could be seen very distinctly through its tail. One of the stars was Arcturus, and, though some of the densest parts of the comet passed over it, yet the star could be seen all the time, thus conclusively proving that the head and tail of a comet are only composed of gaseous matter, probably condensed Aether, as suggested in Art. 111.

ART. 114. *Parts of a Comet.*—A comet may be divided into three parts: 1st, Nucleus; 2nd, Head or Coma; and 3rd, Tail.

The nucleus is the central part of the head or coma, and is generally the brightest part of the whole comet. On the theory that a comet is due to the condensation of Aether, the nucleus would represent the first act in the process of condensation, as there would have to be some centre of condensation, and that centre would be represented by the nucleus. Further, the process of condensation would assume a spherical form, as the conception of our aetherial atom is that of a sphere or an oblate spheroid. As the process of condensation went on, the layers that would be produced would form a kind of envelope around the point of condensation, with the result that the nucleus would ultimately consist of a large mass of gaseous matter, made up of layer upon layer of condensed Aether around some central point, which formed the nucleus.

This hypothesis agrees with observed phenomena, because, when we deal with the tails of comets, we shall see that the tail

is simply formed by the reverse process to that of condensation, as in the case of cometary tails the gaseous envelopes so formed will be thrown off (either through heat generated by friction, or by the increased heat as the comet nears the sun), which are then repelled away from the sun by the centrifugal force. Herschel,¹ referring to the nucleus, states, paragraph 559: "An atmosphere free to expand in all directions would envelop the nucleus spherically," while in his Reflection on Halley's Comet, he states, Art. 570, "1st, That the matter of the nucleus of a comet is powerfully excited and dilated into a vaporous state by the action of the sun's rays, escaping in streams and jets at those points of its surface which oppose the least resistance. 2nd, That the process chiefly takes place in that portion of the nucleus which is turned towards the sun, the vapour escaping in that direction. 3rd, That when so emitted, it is prevented from proceeding in the direction originally impressed upon it, by some force directed *from* the sun, drifting it back and carrying it out to vast distances behind the nucleus forming the tail."

When we come to deal with the question of the formation of the tail, we shall find that every reflection made by Herschel is satisfactorily fulfilled by the conception of a gravitating and condensing Aether. Before considering the tail, however, we will deal with the head or coma.

The head or coma is that part of the comet which exists round the nucleus. It is less bright than the nucleus, and oftentimes appears as a shadowy mass of light. Herschel, in his 4th Reflection, states that "a considerable part of the vapour actually produced remains in the neighbourhood of the nucleus forming the head or coma." So that the head of a comet is simply the vaporised part of the nucleus which is produced by the increased heat of the sun, in the same way that water would be vaporised by the addition of heat, the vapour in that case being thrown off in the form of steam.

This formation of the head is but a continuation of the reversal of the process of condensation, which originally gave existence to the mass of matter termed the comet. The diameter of this head or coma often extends to thousands of miles. The head of the 1811 comet was 540,000 miles in diameter, while that of the 1843 was 112,000 miles. As the nucleus is formed of a series of envelopes, so the head also consists of a series of envelopes.

The comet of 1858 constantly threw off these envelopes, which were first expelled *towards* the sun, and then repelled away *from* the sun, forming the tail. The matter forming the head and the nucleus is perfectly transparent, as stars have been seen

¹ *Outlines of Astronomy.*

through the matter which forms those parts. Herschel,¹ paragraph 558, states "that whenever powerful telescopes have been turned on these bodies, they have not failed to dispel the illusion which attributes solidity to that more condensed part of the head which appears to the naked eye, though it is true that in some a very minute stellar point has been seen indicating the existence of a stellar body."

Tails.—The tail of a comet is that part which flows from the head, and is afterwards repelled by the repulsive power of the sun into space. We shall deal with this repulsive power, whose existence we have already demonstrated, and the part which it plays in the formation of a comet's tail, in the next article. The tail of a comet is oftentimes considered to be the comet itself, rather than a part of the same, but as the tail is the most distinctive feature of a comet, and is the part most visible to the naked eye, there has arisen the popular but mistaken idea of identity between the tail and the comet itself.

Tails are of all kinds. There are some which are short, while others are long. Then we have comets with single tails, or double, and in some cases even multiple tails. Occasionally comets appear which have no tails at all. The comet of 1744 had six tails, which spread out in the shape of a large fan.

One of the most remarkable features of tails is their abnormal length, which oftentimes reaches into millions of miles. The comet of 1843 had a tail 112,000,000 miles long. Another feature about the tails of comets is that they are always directed *away* from the sun. Up to the present I believe no satisfactory explanation has been given of this fact, but with the conception of the rotating Aether as given in Art. 94, we shall for the first time be able to give a satisfactory physical explanation of that phenomenon. In addition to this, the formation of cometary tails of all shapes receives a physical explanation, when taken into account with the fact that the sun is an electro-magnet, possessing its electro-magnetic field, and its lines of force, as described in Art. 88.

ART. 115. Centrifugal Force and Comets' Tails.—In order to account for the existence of the tails of comets, various repulsive forces have been introduced from time to time into the solar system, so that the phenomena of cometary tails might be satisfactorily accounted for.

It has been felt by every astronomer that some repulsive force, which had its origin in the sun, was absolutely necessary to explain the existence of the tails, and as no real force could be demonstrated to exist, recourse had to be made to repulsive

¹ *Outlines of Astronomy.*

forces of a more or less hypothetical nature. The necessity of this repulsive force is nowhere more plainly indicated than by Sir J. Herschel in his *Lectures on Scientific Subjects*, where, dealing with the phenomena of comets' tails, he writes: "They have furnished us with a proof, amounting to demonstration, of the existence of a repulsive force directed from the sun, as well as that great and general attractive force which keeps planets in their orbits."

In the same work, referring to the comet of 1680, he writes: "This comet was perhaps the most magnificent ever seen. It appeared from November 1680 to March 1681. In its approach to the sun it was not very bright, but began to throw out its tail when about as far from the sun as the earth. It passed its perihelion on December 8th, and when nearest to the sun was only about $\frac{1}{10}$ part of the sun's diameter from the surface. No wonder it gave evidence of violent excitement, coming from the cold region outside planetary space. Already, when arrived even in our temperate regions, it began to show signs of internal activity. The head had begun to develop and the tail to elongate, till the comet was for a time lost sight of. No human eye beheld the wondrous spectacle which it must have offered on December 8th. Only *four days* afterwards, however, it was seen again, and the tail, whose direction was reversed, and which observe could not possibly be the same tail, its tail had already lengthened out to the extent of about 90 millions of miles, so that it must have been shot out with immense force in a direction *from* the sun."

The reader will have observed it took from November 10th to December 8th, or 28 days, to fall to the sun for the same distance, and that with all the velocity it had on November 10th to start with. Herschel sums up the matter thus: "Beyond a doubt, the widest and most interesting prospect of future discovery which their study (comets' tails) holds to us, is, that distinction between gravitating and levitating matter, that positive and unrefutable demonstration of the existence in nature of a repulsive force co-extensive with, but enormously more powerful than the attractive force we call gravity, which the phenomena of their tails afford."

Thus the philosophic mind of Herschel saw in the existence of cometary tails, the irrefutable evidence of the existence of a repulsive force, not of a hypothetical character, but as real as the existence of gravity itself. Various attempts have been made to define that repulsive force which was thus demanded, and the same force has been ascribed by scientists to the repulsion due to heat, to light, and also to electricity.

Several French scientists have suggested that the repulsive force was due to the heat of the sun. M. Roche was one of those

who stated that the phenomena of cometary tails was due to the repulsive power of heat, which found its origin in the heat of the sun. M. Faye, another French scientist, states that the repulsive force had its origin in the heat of the sun. By a series of experiments he demonstrated that there was a repulsive power in all heat waves, which gave his theory that experimental support that any theory must possess to make it permanent.

Now in Art. 63 it was shown that heat does possess a repulsive power, but that that power is rather due to the electro-magnetic Aether whose vibrations produce the heat waves, than to the repulsion of heat ; so that, indirectly, the assumption of both these French scientists, that the repulsive power of heat gave rise to the tails of comets, is correct. Then again it has been suggested that the repulsive power is produced by the pressure of the light waves. Professor Lebedew suggested this after he had experimentally proved that light waves did possess a repulsive power (*Annalen der Physik*, November 1901). It can easily be seen, as pointed out in Art. 70, that, inasmuch as light is due to the vibrations of the Aether, they too possess this repulsive power, and therefore Professor Lebedew's suggestion as to the nature of the repulsive power is correct, as the real centrifugal force is really due to an aetherial pressure.

Whether, therefore, we consider it from the standpoint of heat, or light or electricity, it ultimately resolves itself into the same aetherial medium which is at once the common source of all these forces. Again, it has been suggested that the repulsive power is electrical or electro-magnetic, and this view is receiving more support than either of the others from modern scientists.

Herschel suggested that the repulsive power was electrical, while Bredichin has worked out a very careful theory as to the effect of electrical repulsion upon different elements that are found in the comets' tails, with a view to explain the different shapes of the tails. But whether the force is looked at from the standpoint of heat, light or electricity, it ultimately resolves itself into the motions of the Aether, which gives rise by its different vibrations and motions to all the three forms of energy referred to.

When we also take into account the fact that Aether is gravitative, and therefore denser nearer to the sun than further away, and that it is also rotating round the central body the sun (Art. 91), then we have at once every condition necessary to explain all the various kinds of cometary tails, and also for the remarkable fact that the tail is always turned away from the sun, which is simply due to the effect of the rotating Aether with its outflowing electro-magnetic waves upon the gaseous matter of the comet. Thus from the phenomena of comets' tails, we have again arrived at the conclusion of the existence of that centrifugal force, whose

origin and continuity are to be found in the electro-magnetic Aether which surrounds the sun, and which by its electro-magnetic waves gives rise to pressure on all bodies upon which they fall.

ART. 116. *Formation of Tails.*—With the conception of the formation of the comet advanced in Art. 111, viz. that it is nothing more or less than Aether in a state of condensation, and remembering the explanation given of the parts of the comet, as the nucleus, and head or coma, we are now in a position to give a philosophical account of the formation of the tails of comets, which will satisfactorily fulfil all the Rules of Philosophy. In addition to the facts already referred to in the previous articles of this chapter, we must also recall our conception of the Aether as given in Chapter IV., remembering that it gets denser nearer the sun, and that it is not frictionless; therefore, when a body is urged through it, friction is produced, and heat is generated.

We must also remember that the Aether is rotating round the sun as that body proceeds through space. We have, therefore, to picture the condensed mass of Aether situated out in the cold interstellar space, gradually coming under the influence of the sun, as that body rushes on its journey through space with a velocity of 500,000 miles per hour.

Slowly, but surely, the mass of condensed Aether begins to respond to the attractive power of the sun, and to move through space towards the sun. So long as it is moving towards the sun, it is encountering and having to overcome the resistance of the Aether.

At first this resistance is very feeble, owing to the decreased density of the Aether, but as it proceeds on its journey it is constantly passing into denser parts of the aetherial electro-magnetic field around the sun. The result is, that as the resistance is increased, so there is greater friction between the matter of the comet and the atomic Aether in space, and, in consequence, heat is generated.

In addition to the generated heat, the comet is all the while passing into regions of greater intensity of heat. In both cases, the effect is only manifested on that side of the comet which is approaching the sun; for, if there be any friction at all, it will only be on that half of the comet which encounters the Aether, so to speak, while the same part will receive the added heat, as the distance between the comet and the sun is decreased. As can readily be seen therefore, this added heat acts only upon the half of the comet which is advancing, and which faces the sun, and as the effect of heat is always to vaporise, so the effect on the nucleus of the comet is to vaporise the condensed aetherial matter, and this vaporised aetherial matter is thrown

off in layers which are partly spherical in form, the layers always being expelled in the first instance *towards* the sun, on account of that centrifugal motion which has its birth in the nucleus of the comet.

This explanation fully establishes and confirms the first and second Reflections of Herschel as given in Art. 114, and, moreover, is itself established by the very phenomena which comets present in their approach to the sun. As soon, however, as the vaporised matter is expelled from the nucleus towards the sun, it is met by the centrifugal motion of the electro-magnetic Aether which proceeds *from the sun*, and this pressure of the aetherial waves on the advancing comet acts as a repelling power, literally repelling the vaporised matter from the sun, and thus giving rise to the existence of its tail.

This explanation fully confirms the third Reflection of Herschel referred to in Art. 114, and is itself also confirmed by actual observation. During all this time, however, the comet has been approaching *from the sun* with a decreased velocity, for its velocity has been minimised by the resistance it has had to overcome in its approach to the sun. As soon, however, as it reaches the sun, it is whirled round that body by the rotating Aether medium, as the intensity of its rotation is greatest nearest the sun, with a velocity which often exceeds thousands of miles per hour.

Having passed its perihelion, in view of the physical existence of our centrifugal motion, let us now ask ourselves what ought to happen to the comet? Previous to its perihelion, the comet's motion and the centrifugal motion due to the pressure of the Aether were in opposition, but after passing the perihelion, the comet's motion and the centrifugal motion will be acting conjointly, with the result that the motion of the comet would be accelerated. Now this is exactly what observation teaches us does happen in regard to comets, when they have passed their perihelion passage.

As Herschel pointed out with reference to the comet of 1680 (Art. 114), it took 28 days to fall to the sun, but only took four days to cover the *same* distance, after it had passed the sun and rounded the perihelion. So that we have here, as Herschel stated, an irrefutable evidence of the existence of the repulsive power whose existence we have demonstrated.

Again, there is another fact which has to be taken into consideration in regard to the tails of comets. Observation teaches us that their tails are invariably turned *from* the sun, though why they always are so turned away is an unsolved problem, apart from some real or hypothetical repulsive power. We have, however, to further remember that the electro-magnetic Aether around

the sun is ever rotating with that body, and carrying with it in its rotation all associated planets and meteors.

This rotation of the Aether plays a most important part in the phenomena stated. Whether the comet is approaching the sun, or receding from the sun, it is still subject to the influence of this rotatory Aether medium. The result will be that the lighter particles of the vaporised matter will be acted upon more powerfully than the heavier parts, so that even when the comet is receding from the sun, after it has passed the perihelion, the lighter parts which go to form the tail will be more under the influence of the repelling Aether waves than the heavier parts, as the nucleus, as suggested by Bredichin.

Thus the natural result will be that the tail will still be directed away from the sun even when it is receding from that body. Gradually, however, as the comet recedes, it passes out of the denser Aether, where the intensity of motion and vibration are greatest, to those slower parts of the sun's aetherial field where they are less intense.

The effect of this is soon made manifest on the tail and head of the comet. The process which took place as it approached the sun is now exactly reversed, as it is now passing out of a denser into a more rarefied medium, where its motions and vibrations are less intense. The tail, therefore, appears to be drawn back to the head, while the head will itself gradually contract into the nucleus, as it recedes further and further into space. If the comet be situated within the plane, or nearly the plane of the ecliptic, then it is possible for it to return again, and go through the same process, unless it is captured on its outward journey by some of the large outer planets, as Jupiter. If, however, their planes do not coincide with the plane of the ecliptic, then it is very possible that they will not reappear again, but pass on to some other stellar system. Thus we can explain on a strictly philosophical basis one of the most interesting, and yet one of the most mysterious phenomena associated with our solar system, from the simple yet truly philosophical assumption that Aether is matter, in conjunction with all that that assumption logically involves.

CHAPTER XIII

AETHER AND STARS AND NEBULAE

ART. 117. *The Starry World.*—In addition to the planets and comets that are found in the heavens, there are other bodies, countless in their number, which we know as stars. Who has not looked up into the heavens on some clear night, and noticed how the vault of heaven was spangled over with points of light, each point representing a huge sun that exists in far-off space? For it must be remembered that every star is a sun, which, reasoning by analogy, is the centre of a stellar system, just in the same way that our sun is the centre of our solar system. Like our sun, all stars shine by their own light, and the quality of that brilliancy decides the magnitude of the star, the magnitude being indicative of the relative brilliancy of a star rather than its size. So that stars are divided into groups according to their magnitude, the magnitudes ranging from the first to the sixteenth, and even beyond. Those of the first magnitude are more brilliant than those of the second, those of the second more brilliant than those of the third, each magnitude decreasing in relative brilliancy as the number which indicates the magnitude increases. There are about sixteen different degrees of magnitude, in which are classified the millions of stars that exist in infinite space, but only stars up to the sixth magnitude are visible to the naked eye, the telescope revealing those which lie beyond. The total number of stars visible to the naked eye are about 6000, half of which are visible in each hemisphere.

About 20 stars comprise the group of the first magnitude, which include all the brightest stars visible, as Sirius, Canopus, Alpha, Arcturus, Rigel, and Capella.

Those of the second magnitude number about 65, and include the brighter stars to be found in the constellation known as the Great Bear. Stars of the third magnitude number about 200, of the fourth magnitude about 400, of the fifth magnitude 1100, and of the sixth magnitude about 3200.

With the aid of the telescope about 13,000 stars of the seventh magnitude are revealed to us, and 40,000 of the eighth magnitude, while of the ninth magnitude over 140,000 are revealed by the

telescope. As the power of the telescope is increased, so the number revealed is increased also, until by the time we have reached stars of the fourteenth magnitude, at least 20,000,000 are revealed to us.

If we look into the heavens on a clear moonlight night, we shall further see that here and there are groups of stars clustered together. These clusters are termed constellations, and are named after some object which the arrangement of the stars seemed to suggest. Thus every one is familiar with that constellation known as the Great Bear, or the "Plough," so called because of its resemblance to a plough.

The brightest stars of each constellation are named after the letters of the Greek alphabet, the brightest being called Alpha, the next in brilliancy Beta, and so on, right through the Greek alphabet. For example, the seven stars in the Great Bear are known as Alpha, Beta, Gamma, Delta, Epsilon, Zeta, and Eta.

The constellations are grouped into two divisions, known as the Northern and Southern constellations respectively.

The visible Northern constellations are 25 in number, and include the following well-known groups—

Ursa Major	The Great Bear.
Ursa Minor	The Little Bear.
Draco	The Dragon.
Hercules	Hercules.
Cygnus	The Swan.
Lyra	The Lyre.

The visible Southern constellations are 18 in number, and include such groups as—

Cetus	The Whale.
Orion	Orion.
Canis Major	The Great Dog.
Canis Minor	The Little Dog.
Corona Australis . .	The Southern Crown.
Crux Australis . . .	The Southern Cross.

Variable Stars.—Not only are the stars of different magnitudes, but the brilliancy of some of them changes from time to time. This class of stars is known as variable stars, and has received the attention of modern astronomers for many years, in order that the cause of their variation might, if possible, be ascertained. The periods of variation differ in length, ranging from a number of days to 60 or 70 years.

One of the most interesting of variable stars is that known as Omicron Ceti, whose period of change is about 331 days. Its

brilliancy varies from one of the second magnitude to one of the tenth.

Beta Persei is another well-known variable star. This star shines as one of the second magnitude for 2 days and 13 hours, and then suddenly loses its light, and in less than 4 hours becomes a star of the fourth magnitude. Its brilliancy then increases again, and in a similar time it regains its former brilliancy.

The conclusion that has been arrived at in regard to the cause of the variation of these stars is, that in each case the diminution of light is due to the existence of dark bodies, probably planets, which revolve round the central star.

This hypothesis was confirmed by Professor Vogel about 1889 by means of spectroscopic results.

Another interesting fact about stars is that they shine with various colours. The colours of stars are as various as the colours of the rainbow, and range through the whole spectrum, of red, orange, yellow, green, blue, indigo, violet, and white. What is more remarkable is the fact that the colours of the stars seem to change through great periods of time. If we turn to ancient records we learn that Sirius was red then, but is now green, while Capella was also red, but is now pale blue.

Double and Multiple Stars.—Many stars when looked at through powerful telescopes are found to be double, triple, quadruple, and even multiple, although when looked at by the naked eye, they seem to be single in appearance.

An example of a double star is to be found in the constellation of Lyra. A moderate telescope reveals this as a double star, while a still more powerful telescope reveals the strange fact that each apparently single star which forms the double is itself double, so that we have in this constellation a system of four stars, in which each pair revolves round a point situated between them.

Several thousand double stars are known altogether, while the motions of several hundreds of them have been detected with powerful telescopes. Some of the double stars are as follows—Zeta Hercules, Eta Coronae Borealis, Gamma Coronae Borealis, Beta Cygni, Alpha Centauri.

The colours of some of the double stars are very beautiful. Some are yellow and blue; others, yellow and purple, while others are orange and green. Some of the double stars are only optical doubles, that is to say, they apparently seem close together, while as a matter of fact they are immense distances from each other, the apparent doubleness being due to the fact that they are more or less in the same line of vision. Real double stars, where the component stars are situated close

together, are known as physical doubles, to distinguish them from the optical doubles.

Binary Stars.—Another class of double stars are known as Binary Stars. This class of stars is composed of two stars which revolve around each other in regular orbits, and are among some of the most interesting objects in the heavens. About 1000 Binary stars are known altogether. Their motions, however, are very slow, and only in a comparatively few cases have the dimensions of their orbits been ascertained. Some of the Binary stars are Zeta Hercules, which has a period of about 36 years; Eta Coronae Borealis, which has a period of 43 years; while the brightest star, Sirius, is also a Binary star, with a period of about 50 years.

The Milky Way.—The Milky Way is the name given to that band of light which stretches across the sky at night-time, and forms a zone or belt that completely circles the celestial sphere.

This belt of light has maintained from the earliest ages the same relative position among the stars, and, when resolved by powerful telescopes, is found to consist entirely of stars scattered by millions across the expanse of the heavens.

The whole zone or belt is composed of nothing but stars, whose average magnitude, according to Herschel, is about the tenth.

Stars of all magnitudes are, however, found in this zone.

Of the brightest stars, about twelve are found in this region, while the majority of stars of the second, third, and fourth magnitudes are also found in or near it.

The great majority of star clusters are also found along the course of the Milky Way, while many of the irresolvable nebulae seem to congregate near the poles of this starry region.

The Milky Way is divided in one part of its course by a stream of stars, which seems to branch off as a separate stream, thus dividing it into two parts.

All these facts seem to point to the conclusion that the stars of the universe, instead of being scattered about haphazard in the space, form a ring or layer, of which the thickness is very small compared with its length and breadth.

Our own solar system, according to Herschel, occupies a place somewhere about the middle of the thickness of the zone, and near the point where it divides into two parts.

Recent observations go to show that there is a tendency of the sun's apex to drift along the edge of the Milky Way, and this drift seems to point to a plane of motion of the sun, nearly coinciding with the plane of the Milky Way.

ART. 118. *Stars and Kepler's Laws.*—We have learned in a previous chapter that the sun is the centre of a system which

comprises a retinue of planets, with their attendant satellites, together with a number of asteroids or minor planets, with the addition of meteors and comets to complete the system.

Now if the sun is a star, then, according to our First and Second Rules of Philosophy, every star ought also to be the centre of a stellar system and the centre of two aetherial motions, that is, the Centrifugal and Centripetal forces, due to the pressures and tensions of the Aether medium. Further, every stellar system would be composed of exactly similar bodies to those which compose our solar system, as planets with their attendant satellites, together with meteors and comets; the whole of the stellar planets being bound to the central body by the combination of the two aetherial motions, and kept revolving round the central star by the rotating electro-magnetic Aether currents.

Such a hypothesis is entirely philosophical, as it is simple in conception, and fully agrees with our experience in relation to the only star of which we have any complete knowledge.

It is unthinkable to conceive of a star existing in so-called space, and constantly radiating out its light and heat for no purpose at all. All Nature teaches us that there is not a single thing in existence but what has a definite purpose, and a definite place to fill in the universe. Even the aetherial atoms, which form the foundation stones of the universe, have their own purpose to fulfil in the glorious scheme of the Universe conceived by the Eternal Infinite; and to suppose that a star has no purpose to fulfil, no task to perform, is to suppose something altogether opposed to the teaching of all Philosophy. Why even man, with his finite wisdom, would not be so foolish, so unwise, as to make a star, and set it in the firmament of heaven for no purpose at all! Are we therefore to suppose that the Divine Creator of all things possesses less wisdom than the creatures which He Himself hath made? Such an assumption would be a reflection not only on the wisdom of an All Wise Being, but would also be a reflection on our own ideas of philosophical reasoning.

Therefore the conclusion that we are compelled to come to, in relation to the millions of stars that exist in interstellar space, is that every star is the centre of a stellar system, and the centre of two aetherial motions due to the pressures and tensions of the electro-magnetic Aether; while rotating round each star are the ever-circulating electro-magnetic Aether currents, which form the medium by which all the stellar planets with their attendant satellites are ever made to revolve around that central body which supplies them with their light and heat. Some such conclusion as this Sir John Herschel arrived at, for in his *Treatise of Astronomy*, Art. 592, he writes: "Now for what purpose are we

to suppose such magnificent bodies scattered through the abyss of space? Surely not to illuminate our nights, which an additional moon of the ~~1000~~ part of our own moon would do much better. He must have studied astronomy to little purpose who can suppose man to be the only object of the Creator's care, or who does not see in the vast and wonderful apparatus around us, provisions for other races of animated beings. The stars, doubtless, are themselves suns, and may perhaps each in its sphere be the presiding centre around which other planets or bodies may be circulating."

Further, with reference to the stability of each of these stellar systems, it is essential that the existence of a physical centrifugal force should be recognized, in order that the unity and harmony of the spheres should be maintained.

Professor Challis points this out very conclusively in the *Phil. Mag.* of 1859, where, writing on this point, he states: "It may also be remarked, that if the Law of Gravity be absolute, there is no security for the stability of a system of stars, whether the system be a Milky Way or a nebulous cluster. For, however small the mutual attraction between the constituent bodies may be, in the course of ages it must produce a general movement towards the centre or densest region. But the form of the Milky Way and of certain nebulae seems to present an utter contradiction to any such tendency." With the conception, however, of a physical centrifugal force or motion due to the pressure of a physical medium, the stability of even the Milky Way may be physically conceived and understood.

Again, when we consider the sun as a star, we find that it has two motions of its own, one of rotation on an axis, and the other of translation in an orbit, such rotation being due to the fact that it is a magnet and has ever circulating round it electromagnetic Aether currents (Art. 91). By inference, therefore, we arrive at the fact that every star is a magnet, as suggested by Professor Schuster, and possesses rotation on an axis, such rotation being due to exactly the same cause as produces the rotation of any other planetary or solar body (Art. 92). Not only has each star a rotation on its axis, but it must also possess translational motion in an orbit, and that orbital motion must be due to exactly a similar cause as that which produces the orbital motion of the sun. Are there any indications given by astronomical observations which lead us to the conclusion that stars do possess such orbital motions? The answer is unanimously in the affirmative; for, although all the stars and the constellations retain apparently the same relative position to each other, yet they are all in motion. The actual translational motion of the stars is termed proper motion, and has been calculated with

more or less success in relation to many of the stars nearest to us. There are other motions of the stars known as apparent motions, which are easily noted by any observer. These apparent motions are due to the rotation of the earth on its axis, and its orbital motion round the sun.

Nothing is more certain, however, than that careful astronomical observations have revealed the fact that stars have actual orbital motions of their own through space. In many cases the orbital velocity has been approximately ascertained.

Halley discovered proper motions of certain stars as far back as 1715, when he found out, by comparing different observations, that Sirius, Arcturus, and Aldebaran had moved during the period which had elapsed since the respective observations were taken.

More recent observations tend to confirm the fact that stars have indeed proper motions, due to their actual translation through space. It has been ascertained, for example, that Arcturus is travelling at least 54 miles per second.

The proper motion of the stars, however, only gives us an indication of their relative motion through so-called space. It does not tell us whether the star is apparently receding from the earth, or approaching it.

Dr. Vogel has ascertained by a special system of photography in relation to the spectra of stars, that Rigel has a velocity away from the earth of nearly 39 miles per sec., Aldebaran of 30 miles per sec., and Capella of 15 miles per sec., while the Pole star is apparently approaching the earth at a rate of nearly 16 miles per sec.

Now if all the stars move through space with varying velocities, as spectroscopic and telescopic observations seem to suggest, the question naturally confronts us as to what is the particular kind of orbit which each star completes? Is the orbit that of an ellipse, or a circle, or a parabola?

That it must have some kind of orbit is obvious from the proper motions exhibited by the several stars. We have already learned from Arts. 107 and 108 that the sun possesses an orbit, which orbit fulfils the first and second of Kepler's Laws.

If therefore the sun, as representing all stars, is subject to Kepler's Laws, then, according to our Second Rule of Philosophy by which we base our hypotheses on our experience, we are compelled to come to the conclusion that every star which possesses any motion at all through space must also be subject to Kepler's Laws, and therefore must each possess a controlling centre around which they severally revolve. Kepler himself was of the opinion that the stars were subject to the laws which go by his name, and this view of the subject was also accepted by Sir William Herschel.

Thus from philosophical considerations we affirm that each star, while it is itself the centre of a starry system, is also dependent upon and associated with some other body, to which it is held bound by the electro-magnetic Aether, and around which it is made to revolve by the circulating electro-magnetic currents associated with that central body. So that by philosophical reasoning we are led to view the whole of the innumerable stars that flood interstellar space, not as so many individual and isolated units, that have no relation to each other, but rather as parts of one great system, which in its entirety may form in its ultimate unity one harmonious whole, a universe.

As we come to consider star clusters and nebulae, we shall see how this idea of unity seems to be manifested throughout all celestial phenomena.

ART. 119. *Aether and Nebulae*.—In addition to the host of stars that flood the infinite space, there are other celestial bodies that meet the gaze of the astronomer as the telescope is turned upon the heavens.

These bodies, which are glowing masses of gaseous matter, are termed Nebulae. The word Nebulae signifies a cloud, but they are not clouds in the same sense as we apply that term to masses of vapour that exist in our own atmosphere. Sir Wm. Herschel did more towards the discovery of nebulae than perhaps any other astronomer, either before his time or since. His labours in the direction were completed and enlarged by his son, Sir John Herschel, who surveyed the Southern heavens in a way that had never been accomplished before.

The result of the combined labours of the two Herschels has placed information of the nebulae at our disposal which is invaluable. Several thousands of different nebulae are now known to us, and as the telescope is improved and its powers increased, fresh nebulae are being added to the number. Like stars, nebulae vary not only in size, but also in colour, shape, and even in the materials of which they are composed. They also vary in brightness, the light from some being much fainter than the light from others.

It has been estimated by Huggins that the light received from a nebula will not exceed the light of a sperm candle looked at from a distance of a quarter of a mile. It is thought by some astronomers that the light received from a nebula is indicative of the stage of development to which it has arrived. Where the light is faint, the nebulae are in their first stages of formation, and where it is brighter it is indicative of a more advanced stage of development. Thus nebulae may consist of nebulous matter in various stages of condensation, but they are not yet in that

condition which corresponds to the condition supposed to exist in our sun.

Nearly all the nebulae lie outside the Milky Way, so that it would seem as if in ages past all the nebulae that had ever existed in this starry zone had passed out of their nebulous condition and been further condensed into suns or stars, as they are called. Astronomical observations teach us that there are very few nebulae indeed to be seen in this starry highway, the part of the heavens which are richest in them lying far beyond the confines of this zone. For many years certain aggregations of luminous points in the heavens were supposed to be nebulae, but by the aid of more powerful telescopes they have now been resolved into clusters of stars. One of these clusters is the cluster in Hercules, while another is the great nebula of Orion. In the case of the former, situated in the constellation of Hercules, we find a great number of very small points of light grouped together in a more or less globular form. When looked at through a small telescope, this object looks like a nebula, but looked at through Lord Rosse's, or some other great telescope, it becomes at once resolved into an immense number of separate points of light, each one representing a star, there being between one and two thousand altogether in this constellation.

Clusters of stars are usually globular in form, though some are irregular in outline. The latter are generally rich in stars, with a less condensation of stars towards the centre. Sir Wm. Herschel considered the irregular clusters as being in a less advanced stage of condensation, as he was of the opinion that all groups ultimately tended to clusters which were globular in form. Before dealing with the different kinds of true nebulae we will now consider the question as to "What are Nebulae?"

ART. 120. *What are Nebulae?*—The question which presents itself to the mind of all astronomers when they have viewed the wondrous nebulae that exist in far-off space is, "What are Nebulae?" This question is so closely identified with the question as to "What is Matter?" that the solution of the one will give us the key to the solution of the other. It is now generally admitted, that nebulae are composed of a glowing mass of gaseous matter, that gaseous matter being partly composed of the gas Hydrogen. Dr. Huggins in 1864 first made the discovery of the existence of Hydrogen in certain nebulae by means of the spectroscope, which distinctly revealed certain lines that proved the existence of Hydrogen in the nebulae.

In the spectra of some of the nebulae, that of 31 Andromeda, for example, there are no dark lines shown, but only a continuous band of bright light, which would seem to indicate that there was no glowing gaseous matter in that nebula at all. But

accepting the fact that the nebulae are composed of glowing gaseous matter, the problem confronts us as to where this gaseous matter comes from.

If, as spectrum analysis seems to teach us, there are nebulae in various stages of formation, there must be a period in their history of development when they had an origin. What, then, is the origin of a nebula, and what the physical explanation of that origin? From optical phenomena we learn that all space is not empty, but filled with the Aether which is universal (Art. 42). What is the relation, then, of this glowing nebulous matter to this universal Aether? If it be suggested that there is no relation, then we are in the unphilosophical position of having to admit, either that the nebulous matter of which the nebulae are composed never had any origin, or that it had its origin in some unknown and still undiscovered medium which exists in space. But both of these hypotheses are unphilosophical, as the former is contrary to all experience, while the latter is opposed to that simplicity of conception by which we only postulate one medium, the Aether, to fill all space.

Thus we are led to the conclusion, that the gaseous matter, be it hydrogen or nitrogen, must have some relation to the electromagnetic Aether that is so universal in its extent. Already this relationship has been dealt with by one who has done more for the development of aetherial physics than any other scientist. Lord Kelvin, in his paper "On the Clustering of Gravitational Matter in any part of the Universe,"¹ has solved this relationship, though in so doing he has had to depart somewhat from the idea of an incompressible Aether. In that paper he writes as follows: "If we consider Aether to be matter, we postulate that it has rigidity enough for the vibrations of light, but we have no right to say that it is absolutely incompressible. We must admit that sufficiently great pressure could condense the Aether in a given space, allowing the Aether in the surrounding space to come in towards the ideal shrinking surface." In another part of the paper, dealing with the same question, he writes: "In regions where the density was greater than in neighbouring regions, the density would become greater still; in places of less density, the density would become less, and large regions would quickly become void or nearly void of atoms. These large void regions would extend so as to completely surround regions of greater density." He then points out, that as soon as this density becomes something like the density of the atmosphere, then collisions would take place between the particles, and continues: "Each collision would give rise to a train of waves in the Aether.

¹ *Philosophical Magazine*, July 1902.

These waves would carry away energy, spreading it out through the void Aether of infinite space. The loss of energy thus taken away from the atoms would reduce large condensing clusters to the conditions of a gas in equilibrium under the influence of its own gravity, rotating like our sun or moving at moderate speed as in spiral nebulae. Gravitational condensation would at first produce rise of temperature, followed later by cooling, ultimately freezing, giving solid bodies, collision between which would produce meteoric stones such as we see them."

Here then we have a definitive relationship between Aether and nebulae given to us from one of the keenest intellects of the present time, but in order for that relationship to become strictly philosophical, the conception of the Aether as advanced in this work must be accepted. For with the present conception of a frictionless Aether, such a hypothesis is altogether untenable, because it supposes something that is contrary to all experience and observation.

On the basis of a condensing frictionless Aether into any kind of solid body, be it nebula, meteor, sun or star, we have to suppose that it is possible for a medium (the Aether, which is outside the Law of Gravitation according to the present theory) to be condensed into a body, that is, a nebula or meteor which is subject to the Law of Gravitation; and the question arises, at what point in the history of its condensation does this frictionless Aether pass out of the condition of having no weight, to the condition when it has weight; or, in other words, from the condition when it is outside the Law of Gravitation, to the condition when it comes under the Law of Gravitation?

No satisfactory solution can possibly be offered to such a problem. Therefore one of two results must follow, either that the Aether is not frictionless, but possesses weight; or, that the condensation of the Aether is not possible. With the theory of Aether presented in this work, the whole question receives a simple and philosophical solution. As Aether is matter, it is therefore atomic; and being atomic, it is subject to the Law of Gravitation; and therefore, possessing mass and weight, it can readily pass into other forms of matter, and with such a conception Lord Kelvin's hypothesis becomes not only possible but probable. So that it is exceedingly probable that nebulae are nothing more nor less than condensed Aether, the same as comets were suggested to be condensed Aether. It may be asserted that such a hypothesis lacks that experimental evidence which is so necessary for its establishment, but I hope to show in the last chapter that Faraday has given the world that very experimental evidence which will place this hypothesis upon a firm and solid foundation, and enable it to pass out of

the region of the hypothetical into the region of fact and experiment.

According to our hypothesis, therefore, nebulae are simply condensations of the electro-magnetic Aether that exists in inter-stellar space, and the various spectra of the different nebulae indicate the stage of development to which the process has arrived. Where the spectra are bright, and continuous, and free from any dark lines, there we have simply the Aether in its very first stage of condensation; and where we have the dark lines appearing, such lines indicate a more advanced stage to which the process has arrived.

ART. 121. *Nebular Hypothesis*.—The Nebular Hypothesis was first introduced by Kant in his work on the *History of the Earth and Theory of the Heavens*.

In that work he attempted to explain the origin of the universe on purely mechanical lines. Laplace, a French mathematician, about the same time came to similar conclusions as Kant had done, and published his views in his work on *Exposition du Système du Monde*, and later on in his more famous work the *Mécanique Céleste*.

A feature common to both these theories rested in the fact, that they supposed that all material bodies which exist in the universe once existed in a nebulous condition, and that they were formed out of this nebulous matter. Further, that this nebulous matter gradually condensed, and as it condensed, a rotational motion was imparted to them, which rotation quickened as the condensation was continued.

Then, as the rotation was accelerated, portions were flung off by the centrifugal force, and these portions of nebulous matter gradually condensed, forming the various planets of the system. As these condensed, they, in their turn, parted with some of their nebulous matter through the repulsive energy of the centrifugal force, and these secondary parts gave origin to the various satellites that exist round the planets.

Now, while the general principle involved in the nebular hypothesis is true, yet the conception according to Laplace is not verified by fact, as we learn that Uranus and Neptune are still in a state of self-luminosity, while their density is the smallest of all the planets. From this we should infer that the two outermost planets are the youngest planets of our solar system, but according to Laplace's theory, they ought to be the oldest, as they would have been flung off first by the parent body as it rotated; and therefore, being flung off first, should be in a more advanced stage of development than any of the inner planets. M. Faye has suggested a remedy for this defect in the theory. He supposes that the nebulous matter out of which the planets

were formed, was not flung off by the central body the sun, but that each planet was formed at different centres of condensation within the nebular mass that existed in space. This would, undoubtedly, meet the difficulty already referred to, and solves the problem as to how the various planets were formed at different distances in space.

Further, such a solution is in perfect harmony with all the Rules of Philosophy. It is much more simple to conceive of Aether condensing at various points in what originally was the solar nebula, than it is to conceive of Aether condensing and shrinking towards one central point, and yet while condensing and shrinking, portions were flung off into space which would form the planet. A greater objection has to be met, when we come to deal with the origin of all the meteors and minor planets that exist in their numbers in the solar system. In relation to their origin, it is much easier to conceive of portions of the Aether condensing at different centres of condensation, than to suppose that each portion of aetherial matter that originally formed the meteor, or asteroid, was flung off as a separate portion from the central body.

With the conception of an atomic and gravitating Aether, the Nebular Hypothesis, therefore, for the first time is placed upon a sound and philosophical basis, because the condensation of Aether, which is matter and possesses mass, admits of the origin of other matter from it which also possesses mass, together with other properties, as elasticity, density, compressibility and inertia.

When there is added to the atomic Aether the conception of a rotatory aetherial atom, as was indicated in Art. 44, we have at once a source from whence the rotation of the whole mass may be derived. Thus, as the condensation continued, and the nucleus or central part of the body was gradually formed, the rotation would be accelerated, because of the inherent energy which would exist in the condensed part. Further, as the condensation continued, the body so formed would be more or less spherical in form, as the conception of our aetherial atom was spherical, and when we conceive of the primary point of condensation, we have to think of a large number of spherical atoms coming together; and, as all the motions of the Aether which give rise to light, heat, electricity and magnetism, and which now include gravitation, are spherical in their operations, so their effect upon any condensing Aether would take a spherical form. Thus such bodies as nebulae, comets, asteroids, satellites, planets and suns should possess bodies more or less of a spherical form, subject to certain qualifying conditions, as rotation and orbital velocity, and this is in harmony with observation and experience. For we shall find that even in the case of nebulae, we have globular, ring

or annular nebulae, and elliptic nebulae, while in the case of comets, the nuclei and coma are more or less spherical. Further, it is a familiar fact that the shape of all asteroids, satellites, planets, and even the sun is spherical or that of an oblate spheroid, which latter is simply due to its rotational velocity on its axis.

Thus the principle involved in the nebular hypothesis receives its confirmation in the atomic and gravitating Aether, and with certain modifications of the different hypotheses advanced, is capable of uniting all those hypotheses that have ever been put forth in this direction into one perfect and harmonious whole.

Again, the condensation of the Aether, composed as it is of its atoms, ever in a state of rotation, does away with the Primitive impulse which was objected to in Art. 9. For in that article it was shown that the conception of a primitive impulse as conceived by Newton was unphilosophical, in that its conception was not simple, and failed to satisfactorily account for observed phenomena. With the hypothesis, however, of a rotatory aetherial atom, we have at once those conditions which at any time, in the history of the universe, may give rise to those conditions by which a body may be set rotating not only on its axis, but also revolving around some central body, as the process of condensation is continued.

So that in the primordial and universal electro-magnetic Aether that exists in all space, we get those conditions which will not only give rise to the phenomena of light, heat, magnetism and electricity, but also those properties, qualities and motions by which are produced, maintained and perpetuated, the various bodies that exist in the Aether, which is at once the physical source and cause of the bodies.

ART. 122. *Kinds of Nebulae.*—Nebulae may be classified into the following groups—

1. Irregular Nebulae.
2. Ring and Elliptical Nebulae.
3. Spiral or Whirlpool Nebulae.
4. Planetary Nebulae.

Irregular Nebulae.—Of this class the most conspicuous are those in the constellations of Orion and Andromeda. So clearly defined are they, that they are oftentimes seen by the naked eye on a clear night, and are often mistaken for comets.

The great nebula in Orion is one of the most noticeable objects in the heavens. It is noted for its size and brilliancy, and also for the successful observation which it has been subjected to from time to time. This large nebula is situated in that part of Orion which is occupied by several stars known as the Sword

Handle. These multiple stars are known by the name of Theta. Around these multiple stars is to be seen the nebula, as though the multiple stars really were enveloped by the nebula extending for a great distance out into space. It is of a faint bluish colour, with the central parts possessing the greatest brilliancy. The suggestion arises in our mind as to whether the nebulae are in any ways indicative of the presence of the electro-magnetic aetherial field that each star undoubtedly possesses. We learned in Art. 88 that the sun is an electro-magnet, and that it possesses its electro-magnetic field. We have also seen in Art. 109 that the zodiacal light, which is to be observed in connection with our solar system, is really indicative of the presence of that electro-magnetic field, as it rotates round the central body. Now, if an observer were situated out in space, where the nebula of Orion is situated, and could look at our system with telescopes equally as powerful as those we possess, would not our sun present an equally nebulous light to them because of the presence of its electro-magnetic field?

Conversely, if every star possesses an electro-magnetic aetherial field, as they undoubtedly do, then it seems only reasonable to infer that that electro-magnetic field possesses a nebulosity which corresponds with our zodiacal light. The fact that the spectra of the nebulae are continuous, revealing no dark lines, seems to indicate the purity of some of the nebulae, and that therefore they are free from all known elements.

So that spectroscopic results seem to confirm this hypothesis, as the pure Aether that would surround every star, or multiples of stars, would certainly not reveal any dark lines by means of the spectroscope. Such a hypothesis, as to the real nature of a nebula, is entirely in harmony with the theory of the Aether presented in Chapter IV., because being gravitative it will surround each star or multiples of stars, and therefore be denser nearest to those stars, and being atomic, there will be a certain amount of nebulosity manifested by the denser parts of the medium, as is the case in our own solar system.

Ring or Elliptical Nebulae.—These forms of nebulae are so named from their ring-shaped appearance, sometimes being known as Annular Nebulae. The elliptical nebulae are usually classed with them, as they are supposed to be similar kinds of nebulae looked at edgewise. The best known of this class is that found in the constellation of Lyra, and known as 57M, which is the number of the star in Messier's catalogue of stars. It is small but well-defined, so that it looks more like a flat oval solid ring than a nebula.

The central part is not entirely dark, but is filled up with a hazy light. Another annular nebula is that situated to the south-

west of Lambda Scorpii. Sir J. Herschel¹ writes of it thus: "It is a delicate but well-defined annulus. The field is crowded with stars, two of which are nebulae. A beautiful delicate ring of a faint ghost-like appearance, about 40" in diameter, in a field of about 150 stars, of 11 and 12 magnitude and under."

Of the elliptical nebulae the best known is the one in the constellation of Andromeda, which goes by the name of 31M. It is visible on a clear night, and can be seen by the naked eye as a hazy light. There are several other elliptical nebulae, lying to the north-west of this great nebula.

Planetary Nebulae.—The planetary nebulae represent a number of minute objects visible in the heavens. They look like globes of a bluish-coloured gas and are sometimes mistaken for small stars. Sir J. Herschel writes about them as follows: "Planetary nebulae are very extraordinary objects. They have, as their name implies, a resemblance to planets, presenting discs, round or slightly oval, some being quite sharply defined, terminating in others a little hazy or softened at the border. They are comparatively rare objects, not more than 25 having been observed, and of these nearly three-quarters are in the southern hemisphere. Their disc is circular or slightly elliptic, with sharp, clear, and well-defined outline, having exactly the appearance of a planet with the exception only of its colour, which is full blue, varying somewhat upon green. M. Arago has surmised that they may possibly be envelopes shining by reflected light from a solar body placed in their centre, invisible to us because of its excessive distance."

The suggestion which arises to our mind in view of the atomic and gravitating Aether is, that the planetary nebulae are exactly what their names imply, that is, nebulous matter around planets. We have already learned that each satellite and planet possesses an electro-magnetic field, which field takes more or less the shape of a spherical form, so that if there are planets existing in the far-off systems in space, as we are compelled to believe that there are, then they too would possess an electro-magnetic field, which would be composed of spherical envelopes surrounding the several planets. These planets would shine by reflected light, as suggested by M. Arago.

The possession by the planet of the nebulous matter, which we have already suggested is composed of the denser parts of the Aether around the planet, would give to the planet a nebulous appearance which would satisfactorily account for the term already given. They would indeed be what Sir John Herschel suggested they were, viz. planetary nebulae.

¹ *Outlines of Astronomy.*

Spiral Nebulae.—The Spiral, or Whirlpool Nebulae, are remarkable objects, and were first discovered by Lord Rosse with his six-foot telescope. One of the best examples of the spiral nebulae is that known as 51M. Small telescopes show this as two clusters, one of them being surrounded by a ring, at a distance, which is divided into two parts. Lord Rosse, however, found it to be really a spiral nebula, the ring running into a series of spiral coils of nebulous matter, the outlying parts being connected with the main part by curved bands.

Huggins has found that the spectrum of this nebula is not gaseous. Other examples of this class are 99M and 33M. What these spiral or whirlpool nebulae are, is unknown, but, on the hypothesis of a condensing and gravitating Aether which is in a state of rotation, the spiral nebulae can be easily pictured. For, as the condensation goes on, rotation will set in, and if we can picture such a phenomenon taking place in a plane which is at right angles to the line of vision, then we should have a full view of a nebula which would present a spiral form. Indeed, there is no phenomenon in connection with nebulae that cannot be physically explained by a condensing, gravitating and rotatory Aether; and as Aether is universal, the same properties will apply to it in distant space as they do in the solar system; and apart from a gravitating and rotatory electro-magnetic Aether, the phenomena of our own solar system cannot be physically conceived or explained.

Therefore, if such an Aether can explain the phenomena associated with our own system, it ought also to explain, and that to the fullest extent, all phenomena incidental to and associated with the innumerable systems that flood the universe at large.

CHAPTER XIV

UNITY OF UNIVERSE

ART. 123. *The Universe.*—In the preceding chapters we have endeavoured to deal with some of the principal phenomena that help to give a mechanical conception to the entire Universe.

It now remains for us to show, in this last chapter, how, underlying all the physical structure of the Universe, there is one fundamental and primordial medium, in which all the forms of matter and motion find their ultimate unity.

The Universe literally means one ultimate whole, though that whole may be compounded of many parts, the very essence of the term embodying the idea of a complete unity which runs throughout its whole physical structure.

Apart from some such hypothesis as will be suggested in this chapter, that ultimate unity is incapable of a physical or mechanical conception. In Art. 29 we learned that the Universe was composed of two classes of things, matter and motion, while in Art. 30 we learned that the sum total of matter according to the law of the conservation of matter ever remains the same; while further, in Art. 53, according to the law of the conservation of energy, the sum total of energy ever remains the same. We have also learned that the two are indissolubly united, so that wherever we found matter, whether that matter was in its atomic, molecular, planetary or stellar form, there, as its necessary complement and counterpart, was the ever-present and unceasing motion, in one or other of its many forms. Thus, throughout the entire Universe, we find the same two essentials ever working in unison and harmony.

Nowhere in the realm of infinite space is there such a phenomenon as rest or absolute death. The ideal that seems to be the key of the Universe, is that continuity of motion which science teaches us is so inseparably connected with all matter. Grouped, however, here and there throughout the Universe are modifications of this aetherial matter, termed molecules, satellites, planets, suns, or stars, which modifications are, however, not so real and abiding as the electro-magnetic Aether from which they receive their physical origin.

The physical character of the universe is progressive. Even in its ultimate unity there is no such thing as stagnation or standing still; for, while in some parts of the Universe new stars and suns and planets, yea, even new systems are being evolved out of the primordial Aether, in other parts of the Universe old stars and suns, with all their attendant planets and satellites, are passing on towards that final end, when they themselves will be again resolved into the original form of matter from which they were first made. This assertion is in perfect harmony not only with science, but also with revelation. For even revelation teaches us that all the stars shall grow old as doth a garment, and as a vesture shall they be folded up (Heb. i. 11), and that (out of their ruins) a new heaven and a new earth shall be created and the former shall not be remembered (Isaiah lxv. 17).

Thus amid all the modifications of that which is the real physical basis of all matter, we find indissolubly associated with each and all of the varied forms and modifications certain motions which are analogous to each other. In the aetherial atom itself, so infinitesimal in its proportions that even our imagination is almost strained in our attempt to conceive it, yet even here we have rotation and translation in an orbit, such rotation and translation being due to the motions of the electro-magnetic Aether. Then in the gaseous forms of matter into which these atoms may be condensed, we find the same two essentials, of matter and motion, of rotation and translation in an orbit, always working harmoniously together, through the motions of the selfsame Aether, which gives rise to the attraction and repulsions of the atoms.

Then following the principle into the planetary world, and taking the planet Saturn with its ring of satellites as an example, we find again the same two factors ever working in unison and in harmony, with their incessant rotation and translation in an orbit, forming a complete and perfect unity in themselves, such unity being due to the pressures and tensions of the Aether combined with its rotatory character. Then going a step further, we find a number of planets, with or without satellites, all rotating around one central body, that rotation and translation again being due to the motions of the rotating electro-magnetic Aether, combined with its pressures and tensions.

For millions of years, so far as we can tell, this solar system of ours has been moving through space as one complete unit.

Then out in stellar space there are millions of such systems, each distinct and perfect in themselves, each of which is made up of exactly similar parts to our solar system, these innumerable systems being doubtless joined together by the same electro-

magnetic Aether, forming one larger and grander unity, known as a constellation. Then these constellations, increasing in their number, are again joined together, and form a still larger unity called a Galaxy; and galaxy being joined to galaxy, constellations to constellations, we get such an ocean of suns and stars like that known as the Milky Way, the ultimate whole revealing in all its beauty and harmony the unison of the two essentials of matter and motion. It may even be that all the oceans of suns and stars, that exist in far-off space, are joined together by one common bond, the universal electro-magnetic Aether by its two complementary motions, the centripetal and the centrifugal, the whole forming one ultimate unity which we call the Universe, having for its centre one common point or central orb, which indeed forms the centre of gravity of the entire Universe.

Thus the key to the physical conception of the Universe is to be found, and alone found, in that beauty of order, and harmony of motion, which are so inseparably associated with the varied forms of matter, graduating through a series of units or atoms, each with its dual nature complete in itself, through a series of minor entities termed elements, which in their aggregations form meteorites, satellites, planets, suns and stars, and systems of stars and oceans of suns and stars, until all are united into one ultimate unity where all are blended into one complete and perfect whole; the whole of the universal fabric being held together in its mechanical order and beauty by the electro-magnetic Aether. Then in the very centre of the Universe there dwells that Supreme Being whom we call God, who is at once the one real fountain and source of all the light and life of the Universe itself. For it is His universal Spirit that moulds and fashions the plastic matter into the many forms which it assumes, and uses the various modes of motion, as heat, light, electricity and magnetism, as instruments to build up and erect in all their beauty and harmony the innumerable systems that flood immensity and space.

For if there be a centre of gravity to an atomic system, and a centre of gravity to a planetary system, and a centre of gravity to a solar system, then there is also a centre of gravity to a group of systems, even to a constellation, or a galaxy; otherwise our philosophy relative to the centres of gravity of masses fails in its application to wider phenomena of an exactly similar kind.

Thus, if there is a centre of gravity to a galaxy, even to the Milky Way itself, then, going one step further, with a faith that laughs at scientific data and leaps beyond the narrow bounds of pure reasoning, we affirm that there must even be a centre of gravity to the entire Universe. Now let me ask the reader, What can be more fitting, more appropriate, more reasonable

than to infer that the centre of gravity of the Universe is to be found in that celestial orb or orbs where the throne of God exists and endures, and where ultimately there will be congregated together in perfect felicity the spirits of just men made perfect, not only from our insignificant planet, but all the spirits of all beings from all the planets which in their almost infinite number are circled round their central suns by the electro-magnetic Aether? It is there, in these bright orbs, with their vision and powers spiritualized, quickened and intensified, that all perfected spirits shall look out into space, with increasing wonder, upon the birth and decay of worlds, the evolution and devolution of planets and systems and constellations, and shall watch the continuation and working out of that grand and glorious plan, which alone finds its perfection and its ultimate fulfilment in the wisdom, and power, and glory of the Eternal Spirit of the Living God.

To see if this conception of the Universe is borne out by scientific data, we will now address ourselves more particularly to those fundamental truths which underlie the unity of the Universe.

ART. 124. *The Unity of the Universe.*—The Unity of the Universe is a dream which has passed before the imagination of many philosophers in by-gone times, and has been a fruitful source of speculation to old-world, as well as more modern philosophers. The researches of such living scientists as Sir William Crookes, Professor J. J. Thomson and others, have, however, made this dream come within the range of practical research and direct experiment. Professor J. J. Thomson believes that it is possible to break off from an atom, a part which is only $\frac{1}{1000}$ part of the whole, and these infinitesimal parts he has called corpuscles, which he considers are the carriers of the electric current.

If, therefore, it can be philosophically proved that the hypothesis of an atomic, gravitating, and condensing Aether can satisfactorily account for the physical existence of all atoms, and therefore of all matter, the dream of old-world philosophers will be helped on its way to a successful realization.

We have already suggested, that nebulae are formed out of the condensation of the electro-magnetic Aether that fills the Universe; and as that nebula, according to the Nebular Hypothesis, ultimately resolves itself into a sun, or planet, or satellite, as the case may be, it follows that the condensation of this electro-magnetic Aether forms the basis of all the various elements, as Hydrogen, Nitrogen, Oxygen and the other seventy elements of which those bodies are composed. Thus the conclusion that we are compelled to come to in regard to the ultimate nature of matter, in its primordial condition, is, that all matter which exists

in its varied forms throughout the entire Universe finds its physical origin and source in the universal electro-magnetic Aether, which is itself atomic, and possesses all the essential properties of matter.

With the conception of the Aether as advanced in this work, this hypothesis is perfectly philosophical and logical. For the conception is simple, in that it supposes one form of matter to spring out of another form, that is, from an aetherial form to gaseous, in a similar manner to that in which a gaseous form changes into a liquid form, that is, by condensation, or a closer drawing together of the aetherial elastic envelopes that surround each atom; each particular gas, as Hydrogen, Nitrogen, or Oxygen, representing different quantities of aetherial condensations, as will be seen in the next article.

The aetherial constitution of matter has received recognition from the hands of such scientists as Lord Kelvin and Dr. Larmor. The latter, in his *Aether and Matter*, writes on the subject as follows (page 7): "Matter must be constituted of isolated portions, each of which is of necessity a permanent nucleus or singularity in and belonging to the Aether, of some such type as is represented for example by a minute vortex ring in a perfect fluid, or a centre of permanent strain in a rotational elastic medium." And again on the same page he adds: "It is incumbent on us to recognize an aetherial substratum of matter, in so far as this proves conducive to simplicity and logical consistency in our scheme of physical relations, and helpful towards the discovery of hitherto unnoticed ones."

Dr. Larmor, as has already been pointed out in Art. 44, speaks of his aetherial atoms as electrons, which are of two kinds, negative and positive, and of these he states (page 97): "Each electron has an effective mass of aetherial origin, which forms part, and may be the whole of the mass of the matter to which it is attached."

Here, then, we have definite statements as to the hypothesis of all matter having a definite aetherial origin. If, therefore, it can be proved experimentally that matter does possess this aetherial basis, then the hypothesis will pass out of the region of speculation into the region of fact and science.

The question, therefore, suggests itself to our mind, as to whether among all the experiments that have ever been performed by any scientist, there are any which will conclusively confirm and establish the hypothesis as to the aetherial origin of all matter. In my opinion there are such experiments, which have been given to the world by such eminent scientists as Faraday and Sir Humphry Davy. Before, however, the value of their experiments can be rightly understood and valued, we shall

have to ask ourselves another question, and that is, "What is the relation of Aether to electricity?" Upon the correct answer to this question depends the application of Faraday's experiments to the hypothesis of the aetherial constitution of all matter, and therefore of the great underlying principle of the unity of the Universe.

Is there any relation therefore between Aether and electricity? If so, what is that relation, and to what extent does it hold good? Professor Lodge, in his preface to *Modern Views of Electricity*, asks a similar question. "Electricity," he states, "has been thought to be a form of energy, it has been shown to be a form of Aether. There remains the question, What is Aether?"

While again he writes: "A rough and crude statement adopted for popular use is that electricity and Aether are identical. But that is not all that has to be said, for there are two opposite kinds of electricities, and there are not two Aethers. But there may be two aspects of one Aether, just as there are two sides to a sheet of paper."

That there is a definite relation between Aether and electricity is as certain as there is a definite relation between electricity and light. In order to find out how far the relationship and identity between Aether and electricity extend we will review our conception of the Aether as given in Chapter IV. According to the conception advanced in that chapter, on the hypothesis that Aether was matter, we philosophically came to the conclusion that Aether was atomic, and therefore gravitative. Because it was gravitative, it possessed density, and varying degrees of density; and having mass, it possesses the property of inertia the same as any other matter; and was also elastic.

We have now to add to these properties that of compressibility, which property we have ascribed to it from philosophical considerations when dealing with comets, and nebulae, and the origin of planets and satellites. Now, if there is any identity between Aether and electricity, then it follows that that identity will be more or less manifested, as we find electricity possessing more or less of the properties which have been ascribed to the electro-magnetic Aether. For, if we find two apparently different substances, or entities, possessing exactly the same properties, and occupying the same space at one and the same time, then the only logical conclusion that we can come to is, that these two apparently different substances are not two substances, but one.

We have already proved that they both occupy exactly the same space, that is, they occupy the planetary and interstellar regions of space, and fill indeed the entire Universe. The electro-magnetic theory of Light (Art. 78) indisputably proves this. We will there-

fore find out if electricity possesses the properties which have already been ascribed to the Aether. The first property, and indeed the fundamental property, of Aether is that it is atomic, and upon the atomicity of the medium depends the whole of the theory as worked out in relation to heat, light, electricity and so-called gravitational phenomena. Is there anything about electricity that can suggest the hypothesis that electricity is atomic? The answer is unquestionably in the affirmative. Many of the greatest scientists of the past and present century have believed and worked at the hypothesis of the atomic character of electricity, and none more so than Dr. Larmor in his *Aether and Matter* and Professor J. J. Thomson.

Now what is Dr. Larmor's opinion as to the atomicity of electricity? These are some of his statements quoted in the work. In the very first words of his preface he writes:¹ "The following essay was originally undertaken mainly as a contribution towards the development of the standpoint which considers electricity, as well as the matter, to be constituted on an atomic basis." He continues: "Since Faraday's work on Electrolysis, the notion of the atomic constitution of electrification in its electro-chemical aspect has never been entirely absent." While later on he adds: "Thus, for example, the present view of the atomic character of electricity, which is at length coming within the scope of direct experiment, has been in evidence with gradually increasing precision ever since theoretical formulations were attempted on the subject."

We are, however, possibly indebted to Professor J. J. Thomson for the most direct experimental evidence as to the atomic nature of electricity, for, as is well known to scientists, he has discovered what he termed corpuscles, in association with electricity, which he makes the carriers of the charges involved in electrical phenomena.

Here, then, we have one proof of the identity that exists between Aether and electricity, in that while they both fill the same space, they are both equally atomic; Dr. Larmor's ultimate atom, as we have already seen, being known as positive and negative electrons. Aether, we also learned, was gravitative (Art. 45), but we have since learned that gravitation is itself an electrical phenomenon, in that both the centripetal and centrifugal forces are due to the repulsions and attractions or pressure and tension of this electro-magnetic Aether.

So that when we affirm that Aether is gravitative, we do but affirm it is subject to the laws of electricity, which govern all electrical phenomena, and therefore we might just as truly affirm

¹ *Aether and Matter.*

that electricity is gravitative, because such an affirmation is simply another way of saying that electricity gives rise to the attractions and repulsions incidental to, and associated with, all electrical phenomena. Here, again, we have further evidence of the identity that exists between Aether and electricity.

Then we learned that Aether possessed density, and also different degrees of density, and the question arises as to whether there is anything corresponding to this property in electricity. As a matter of fact, this very property of density is itself recognized and known to all scientists by the term Electric Density, the electric density being always proportionate to the charge of electricity on a given area.

We learned also in Art. 79 that aetherial density and electrical density were identical in relation to solar and planetary space; so that, wherever there was the denser Aether, there was also the denser electricity, the density of the one increasing or decreasing exactly in the same ratio as the other increased or decreased. From aetherial and electrical density, therefore, we have another proof of the close identity that exists between Aether and electricity.

Again, we learned (Art. 48) that Aether possessed inertia. Here at least, it may be thought, we shall find the first point of difference between the two entities. Surely such an intangible, aetherial manifestation as electricity cannot possess inertia. Let us see what Professor Lodge has to say on the subject. In the chapter on electrical inertia he writes (p. 89, par. 365 of *Modern Views of Electricity*): "A current does not start instantaneously: it takes a certain time, often very short, to rise to its full strength; and when started it tends to persist, so that if its circuit be suddenly broken, it refuses to stop quite suddenly, and bursts through the introduced insulating partition with violence and heat. It is this ram or impetus of the electric current which causes the spark seen on breaking a circuit; and the more sudden the breakage, the more violent is the spark apt to be. We shall understand them better directly; meanwhile they appear to be direct consequences of the inertia of electricity; and certainly if electricity were a fluid possessing inertia it would behave to a superficial observer just in this way."

From these statements we learn then that electricity does possess inertia, although there are other phenomena of electricity that would destroy the hypothesis. But undoubtedly an electric current possesses momentum, and it is philosophically impossible to associate momentum with any body that does not possess inertia, as one of the factors of momentum implies mass, even though it be a mass of an infinitesimal form, and mass is the very essence of the property of inertia (Art. 40).

Dr. Larmor, in the work already referred to, dealing with the subject of electric inertia, explains that it is concentrated at the nucleus of the electron (p. 230), while on p. 202 he states: "Each electron as it is moved by the aetherial displacement belonging to the radiation, resists with its own definite inertia."

Apart from this evidence, the philosophical evidence already adduced in Chapter X. is altogether in favour of the fact that electricity possesses inertia. So that we may say that, though the evidence as to the identity of electrical and aetherial inertia is not fully complete, the balance of opinion lies in favour of the identity rather than otherwise. See *Appendix A.*

It can further be demonstrated that electricity possesses elasticity the same as the Aether does. The charge and discharge of a Leyden jar are conclusive evidence of the elasticity associated with electrical phenomena, while further proof is to be found in the fact that Dr. Larmor attributes elasticity to his electrons, such elasticity being of a rotational type.

The identity, therefore, that exists between Aether is now almost complete. We have now only to prove that both are compressible, and the identity is fully established. This will be done by reference to certain of Faraday's experiments before the conclusion of this article. As we have established, logically, the identity that exists between Aether and electricity, the question arises now as to whether they are not one and the same medium. If they are not one and the same medium, then we are in the distinctly unphilosophical position of having to admit that all interplanetary and interstellar space are filled at one and the same time by two different media, and such an assumption is directly opposed to all observation and experience.

Therefore, to be strictly philosophical, one of these media must be done away with, and we may either assert that interplanetary and interstellar space is filled with electricity, or else it is filled with Aether, as it is much simpler to conceive of space being filled with one medium, than it is to suppose it to be filled with two media, which are absolutely identical in all their characteristic properties and functions. Both can give rise to exactly the same kind of phenomena, whether they are the phenomena of heat, light, electricity, or magnetism, and even gravitation itself. So that, if Science wishes to be distinctly philosophical in her statements in future, it will be necessary, it seems to me, to do away either with the Aether, or with the electricity, and as the latter is the better known entity, I am of the opinion that Science will retain the electric conception of space and matter, and do away with the aetherial, as being altogether unnecessary. See *Appendix B.*

Thus are we led to the conclusion that electricity is itself a

form of matter, as indeed it must be if it is atomic, as suggested by Dr. Larmor and Professor Thomson.

Professor Lodge, on p. 9 of the work already referred to, states: "Electricity in this respect behaves just like a substance;" and again, p. 313, he writes: "We cannot assert that it is a form of matter, neither can we deny it; on the other hand, we certainly cannot assert that it is a form of energy, and I should be disposed to deny it. It may be that electricity is an *entity per se*, just as matter is an *entity per se*."

Whether electricity be a form of matter or not, as I believe it undoubtedly is, we have arrived at the fact, in view of the identity between Aether and electricity, that, wherever the one is present, the other is present also. So that if it can be demonstrated by direct experiment that matter can be changed into its equivalent quantities of electricities, or that equivalent quantities of electricities could produce their equivalent forms of matter, then the electrical basis of matter, and consequently the aetherial basis of matter, are proved beyond contradiction, and we are thus led one step nearer to the ultimate unity of the Universe, which unity is to be found in the universal electro-magnetic Aether, which is identical with universal electricity. For if Aether be the basis of all modes of motion, as heat, light, and gravitation, and it is identical with electricity, it follows that electricity is equally the basis of all the varied phenomena, and if to that we add the constitution of matter itself, then we are within sight of the medium in which the ultimate unity of the Universe is to be found.

This view of the subject has already been dealt with by a German scientist, Professor Vogt, in his book on *The Nature of Electricity and Magnetism*, a book, however, which is not translated into English. In that work I believe he shows the possibility of all matter having its origin in electricity; and if that be so, then that theory is really identical with an aetherial basis of matter, seeing that Aether and electricity philosophically seem to be one and the same medium. Let us therefore turn to Faraday's experiments, and see what they teach us on the subject of the electrical basis of matter, and therefore the aetherial basis at the same time.

In paragraph 852 of his *Experimental Researches* Faraday writes: "The theory of definite electro-chemical action appears to me to touch upon the absolute quantity of electricity, or electrical power, belonging to different bodies. Although we know nothing of what an atom is, yet we cannot resist forming some idea of a small particle which represents it to our mind, and though we cannot say what electricity is, so as to be able to say whether it is a particular *matter or matters*, or mere motion

of ordinary matter, yet there is immensity of facts which justify us in believing that the atoms of matter are in some way endowed or associated with electrical powers to which they owe their most striking qualities, and amongst them their chemical affinity. As soon as we perceive, through the teaching of Dalton, that chemical powers are (however varied the circumstances in which they are exerted) definite for each body, we learn to estimate the relative degree of Force which resides in such bodies; and when upon that knowledge comes the fact that electricity, which we appear to be capable of loosening from its habitation for a while, or conveying from place to place, whilst it retains its chemical Force, can be measured out, and being so measured, is found to be as definite in its action as any of those portions which, remaining associated with the particles of matter, give them their chemical relation, we seem to have found a link which connects the proportion of that belonging to the particles in their natural state."

Then in paragraph 855 he writes as follows: "It seems a probable and almost a natural consequence, that the quantity which passes is the equivalent of, and therefore equal to, that of the particles separated, *i. e.* that if the electrical power which holds the elements of a grain of water in combination (or which makes a grain of oxygen and hydrogen, in the right proportions, unite into water when they are made to combine) could be thrown into the condition of a current, it would exactly equal the current required for the separation of that grain of water into its elements again."

Further, in Art. 857, he states, "I can have no doubt that, assuming hydrogen as 1, and dismissing small fractions for the simplicity of expression, the equivalent number or atomic weight of oxygen is 8, of chlorine 36, of bromine 78.4, of lead 103.5, of tin 59, etc., notwithstanding that a very high authority doubles several of these numbers." Then, writing upon the definite relationship of electro-chemical equivalents, he states, Art. 835: "Electro-chemical equivalents are always consistent; *i. e.* the same number which represents the equivalent of a substance *A*, when it is separating from a substance *B*, will also represent *A* when separating from a third substance *C*. Thus 8 is the electro-chemical equivalent of oxygen, whether separating from hydrogen or tin or lead; and 103.5 is the electro-chemical equivalent of lead, whether separating from oxygen or chlorine or iodine."

So that from Faraday's experiments we learn definitely that the electro-chemical equivalents coincide with and agree with the ordinary chemical equivalents according to Dalton's theory. From these experimental results of Faraday's we therefore learn that Faraday was of the opinion that each atom had a definite

and certain quantity of electricity associated with it ; and if this be true, then, in view of the identity of Aether with electricity, it follows that each atom must have definite and certain quantities of Aether associated with each atom. So that through Faraday's experimental researches we are again led to the hypothesis enunciated by Lord Kelvin in his paper "On the Clustering of Gravitational Matter in any part of the Universe," viz. that all matter has an aetherial, that is, an electrical basis, and that it is by the condensation of this electricity, and combinations of the condensational particles, that all the various elements are formed which compose the infinite variety of forms that constitute the entire Universe. Here, then, it seems to me, we have the evidence which gives to the aetherial Nebular Hypothesis (Art. 121) that experimental evidence which places that hypothesis upon a firm and philosophical foundation, and conclusively proves that it is possible for Aether out in the colder regions of interstellar space to be condensed into masses of gaseous matter, which form nebulae, and other masses in the cold regions of interplanetary space to condense and form comets and meteors.

ART. 125. *Physical Constitution of Matter.*—In Art. 31 we learned that all matter was made up of minute parts called atoms. When these atoms enter into combination with each other, they form the smallest particles of elementary substances as well as compound bodies, these particles or bodies being termed molecules.

A molecule, therefore, may consist of any number of atoms of the same element, or may be formed of the union of the atoms of two different elements. In the preceding article we have learned that the atom of hydrogen or carbon, however, is divisible, at least theoretically if not experimentally, as we came to the conclusion that all atoms are composed of infinitesimal aetherial atoms, which are synonymous with atoms of electricity.

Whether we shall ever be able to experimentally prove the existence of such an atom remains to be seen, though Dr. Larmor states that the atomicity of electricity is coming within the scope of direct experiment ; while the researches of Professors Crookes and J. J. Thomson have undoubtedly given direct evidence of the existence of corpuscles, which are part of the atoms of the various elements.

When we try to conceive, however, of the manner in which the various elements can be formed from one primary medium, that is, the Aether or electricity, we find it difficult to arrive at a simple physical conception of the process involved.

We are indebted to Professor J. J. Thomson for what is practically the only simple physical conception of the method in which various elements may be formed from that medium, which

gives unity to the whole of the universe. In the Adams Prize Essay of 1883 Professor Thomson indicated a theory based on the vortex atom (Art. 43) which satisfactorily accounted for the various laws which governed gaseous matter, and also showed how the varied chemical combinations might be physically conceived as being produced from one primary medium.

In this theory we have to conceive of the vortex atom as possessing a hollow core, while in our conception of an aetherial atom (Art. 43) we conceived it as being more of a spherical or globular form than ring-shaped. We have, then, to consider the atom of any element as being composed of a vortex ring of various thickness, the thickness of the ring being an indication of its atomic weight.

Each vortex ring must also be conceived as itself being composed of a number of aetherial atoms, or atoms of electricity, the number of such atoms being proportionate to the respective atomic weights of the various elements. Dr. Larmor suggests that a vortex ring may have this constitution in his work on *Aether and Matter*.

According to Professor J. J. Thomson, then, any vortex ring, which we have supposed to be constituted of aetherial atoms, or atoms of electricity, may unite with any other vortex ring, thus producing a vortex ring of double density, which would possess double the electricity of the unit vortex ring. If we united three vortex rings, then the result would be an atom of threefold the density and strength of the unit vortex ring.

We might conceive of four or any number of these rings uniting together to form a separate element, and then each element would simply be a multiple of the unit vortex ring, and so possess regular multiples of the atoms of electricity, each multiple representing a distinct element.

We will now let Professor Thomson speak for himself on the matter, and will describe the theory in his own words, always keeping in mind the hypothesis that the unit vortex ring is itself composed of a definite number of atoms of electricity or electrons, as proved by Faraday. See *Appendix C*.

In the work already referred to, Professor Thomson states: "We may suppose that the union or pairing in this way of two vortex rings of different kinds is what takes place, when two elements of which these vortex rings are atoms combine chemically; while, if the vortex rings are of the same kind, this process is what occurs when atoms combine to form molecules. Now let us suppose that the atoms of different chemical elements are made up of vortex rings, all of the same strength, but that some of these elements consist of only one ring, others of two rings linked together, others of three loops, and so on. Then if

any of these rings combine to form a permanent combination, the strength of all the primaries in the system so formed by the combination must be equal."

"Thus an atom of one element may combine with another atom of the same kind, to form a molecule of that substance consisting of two atoms. Again, three of these atoms may combine, and form a system consisting of three primary elements, but the chance of their doing so is small compared with the chance of two pairing; so that the number of systems of this kind will be small compared with the number of the systems consisting only of two atoms. We might have systems of four atoms, but the number would be small compared with the number of systems that consist of three atoms."

"Now, suppose that an atom of one element is to combine with an atom of another. Suppose, to fix our ideas, that the atom consisting of two vortex rings linked together, is to combine with an atom consisting of one vortex ring; then, since, for the stability of connection, the strength of all the primaries which form the components of the compound must be equal, the atom consisting of two links must unite with molecules containing two atoms of the one with one link. Thus the compound formed will be the simplest combination, consisting of one of the atoms which consist of two vortex rings linked together with two of the atoms consisting of only one vortex ring. Similarly, if an atom consisting of three vortex rings linked together were to combine directly with atoms consisting of only one vortex ring, the compound formed would consist of the three linked atoms with three of the others, and so on for all the combinations of atoms formed by any number of vortex rings linked together. This suggests that the elements, called by the chemists monads, dyads, triads and so on, consist of one, two, etc. vortex rings linked together, for then we should know that a dyad could not combine with less than two atoms of a monad to form a stable compound, or a triad with less than three, and so on, which is just the definition of the terms monad, dyad, triad."

"On looking at chemical combination from this point, we expect to find that such compounds as Hydrochloric acid, where one atom of Hydrogen has only to meet one atom of Chlorine; or water, where one atom of Oxygen has only to meet two atoms or a molecule of Hydrogen, would be much more easily and quickly formed than a compound such as ammonia gas, to form which an atom of Nitrogen has to find itself close to three atoms of Hydrogen at once."

"It is the case, I believe, in direct combination, that simple compounds are formed more quickly than compound ones. We might call the ratio of the number of links in the atom of any

element, to the number in the atom of Hydrogen, the Valency of the element. Thus the compounds H-CL, H-I, H-F, show that the atoms of Chlorine, Iodine, Fluorine have the same number of links as the atom of Hydrogen, so that the valency of each of these elements is unity. From the compound H_2O we infer that the atom of Oxygen consists of twice as many links as the atom of Hydrogen. The compound H_2S indicates that the atoms of Sulphur have twice as many links as the atom of Hydrogen."

"The molecules CO_2 and Marsh Gas have each three primaries represented by C-O-O and C-H-H respectively. According to the view we have taken, atomicity corresponds to complexity of atomic arrangement, and the elements of high atomicity consist of more vortex rings than those whose atomicity is low."

"Thus high atomicity corresponds to complicated atomic arrangement, and we should expect to find the spectra of bodies of low atomicity much simpler than those of high. This seems to be the case, for we find that the spectra of Sodium, Potassium, Lithium, Hydrogen, Chlorine, which are all monad elements, consist of comparatively few lines."

Here then, on the vortex theory of matter, especially when that vortex theory is given an electric basis, as is the case in Dr. Larmor's electron theory, we have a thinkable and logical explanation of the physical and chemical properties of matter, by which all elements and compounds may be formed from the primordial aetherial or electric atom. As all Nature is composed of about seventy elements, and it has been conclusively demonstrated that an atom of Hydrogen is the same all over the universe, no matter whether it exists on this planet, or in some distant star or nebula, we arrive at the conclusion that all the other elements are exactly the same in their properties and qualities wherever they are found. If, therefore, we couple Faraday's experiments and results as to the electro-chemical equivalents of all atoms, with this theory of Professor J. J. Thomson's, then we are again compelled to come to the conclusion that the unity of the universe in all its universality, and infinite variety of forms and modes of matter, is to be found, and alone found, in the universal Aether, which is co-existent and co-extensive with electricity.

ART. 126. *Quod Erat Faciendum*.—Before concluding this work let us briefly review the whole of the theory submitted herein to the reader.

That which was to be done consisted primarily in ascertaining the physical cause of Gravitation, by which would be accounted for on a philosophical basis all the phenomena incidental to and associated with the Law of Gravitation. Such phenomena included

the physical cause of the Centripetal and Centrifugal Forces, the physical cause of Kepler's Laws, together with a physical conception of the application of Newton's Laws of Motion to all solar and stellar bodies. In addition to this, there were other outstanding problems in physics that it was premised would receive either a partial or an entire physical explanation. It was premised, for example, that the problem of the relative motion of Aether and matter would be solved, that the cause of the permanent magnetism of the earth would be revealed, and the great problem of the constitution of matter attacked, together with the unity of the universe which arose from that conception.

In order, however, for any theory to be philosophical in its initial stages, the rules of some of the greatest philosophers which govern the making of any hypotheses were briefly outlined, and were found to resolve themselves into three divisions.

The first rule dealt with the general simplicity of Nature's mode of working, and therefore the general simplicity which must govern our hypotheses in perfecting any theory as to the cause of all phenomena, gravitational or otherwise.

The second rule showed that the only sound basis from whence we could derive all our data upon which to speculate and reason, lay in our experience of all natural phenomena. Whatever else we might do, or not do, it was absolutely necessary, if we wished to be perfectly philosophical in our conclusions, that we should not traverse the direct results of observations and experiments.

The third rule laid down was the obvious axiom, that the theory so perfected by logical reasoning must satisfactorily account for and explain all the phenomena sought to be explained.

Now I wish to submit the whole theory as propounded in this work in its completion and in its entirety to the reader, and to ask him if the Rules of Philosophy have not been adhered to throughout the whole work? Can any theory be more simple than the one submitted in this work, by which we have endeavoured to account for all, and even more, than was premised in the opening chapters?

The very simplicity of the fundamental hypothesis that Aether is matter, in all its properties and qualities, has been the chief obstacle to the retardation of its earlier discovery.

Any proposition more simple, more easy of comprehension, is, to my mind, difficult of conception. Why, children in our homes and schools may be taught the truth, and grasp it in its concrete form, and that is the highest test of the simplicity of any hypothesis.

Thus the first Rule of Philosophy is satisfied and fulfilled in the initial hypothesis, and I venture to affirm that the same simplicity has characterized the development of the theory throughout its

entire progress. Step by step, simple facts and simple truths which are known to any ordinary student have been shown to have a wider and more universal application than even the writer dreamed of, when he started out on his voyage of discovery in philosophical research.

When we consider the second Rule of Philosophy in its application to our theory, we find that experience, as revealed by observation and experiment, is fulfilled to the minutest detail. The simple hypothesis that Aether is matter, fulfils to the very fullest extent all requirements demanded by the experience of all the scientists and experimentalists that the world has ever known. To assert that Aether is not matter is to assert a proposition contrary to all the accumulated experience of the past generations. Therefore, if Aether is matter, then its fundamental qualities must be those which belong to and are associated with all matter, those qualities being atomicity, gravity, density, elasticity, inertia, and compressibility.

The objector to this statement is himself violating the chief rule of all philosophy, in that he is going contrary to the tenor and teaching of his own experience. Then, following out the second rule step by step we arrive at the one grand central truth, that electricity is also a form of matter, and that all the forces of the entire universe are but different modes of motion, different vibrations of the universal electro-magnetic Aether; while all the varied bodies that exist are themselves but different manifestations in a gaseous, liquid, or solid form of the same electro-magnetic substance.

Thus, step by step, we have tried to build up a theory of the physical cause of all phenomena, which will satisfactorily account for those phenomena, and even for the structure of the universe itself, from the mechanical standpoint, and by so doing have fulfilled the third Rule of our Philosophy as enunciated by Newton and others.

So that by the conception that Aether is matter, in its primordial state, we have more than fulfilled all that was premised should be done.

Thus the long-sought-for and long-expected cause of Gravitation, together with the cause of the two complementary forces, is found in the simple statement that Aether is matter, with all that is logically included therein. Kepler's Laws and Newton's Laws of Motion also receive a physical explanation in the same universal electro-magnetic Aether.

In addition to the solution of these problems, the transverse vibrations of light has received for the first time a physical conception, and a physical explanation, even admitting that that explanation may not be perfect in detail.

The origin of the permanent magnetism of the earth has also received a physical explanation through the motions of this same electro-magnetic Aether, while certain theories in relation to electricity given to the world by Ampère, Weber, Faraday, and Clerk Maxwell have found their consummation in this atomic electro-magnetic medium.

Further, astronomical hypotheses in relation to comets and nebulae are not untouched by the theory of a compressible and condensing atomic Aether. Indeed, there is not a phase of natural phenomena which is not affected in some way or other by the philosophical result arrived at that Aether is matter in its original state. Therefore, we claim, however imperfectly it may have been done, that not only have the Rules of Philosophy been fulfilled, but that the theory so advanced has accomplished more than even we in our wildest imagination hoped and dreamed for it.

Look at the problem of the Aether how we may, the advantages of the theory of an atomic electro-magnetic Aether far surpass and outweigh the advantages of a frictionless medium, which in some unknown way possesses mass and inertia, although the conception of such properties themselves disproves the existence of such a frictionless medium.

After all, how much of this theory is there which is entirely new or absolutely original? Age after age, men have had exactly similar dreams, and seen similar visions. In the old Grecian days similar views were expressed by their philosophers; and, even in the philosophy of less civilized countries, many of the suggested hypotheses found their place in a more or less perfect form.

Analyze the whole theory from its initial stages to the last chapter, and we shall find, with the exception of one or two features, that every hypothesis first had its origin in the mind of some of the greatest thinkers and philosophers that the world has ever known.

Take several hypotheses as examples. The hypothesis that Aether is atomic was suggested by such men as Newton, Huyghens, Descartes, Challis, Clerk Maxwell, and others.

That Aether is gravitative has been suggested by Young, Grove, Faraday, and Lord Kelvin. Huyghens, Fresnel, and Young postulated different degrees of density for the Aether, while Stokes and McCullagh have affirmed and proved different degrees of elasticity of the medium.

The inertia of the medium has received experimental evidence from Tyndall, Maxwell, Faraday, Lodge, and others, and its compressibility has received the adherence of men like Faraday, Maxwell, and Lord Kelvin.

Then, when we come to deal with the causes of the forces involved in gravitational phenomena, we find that exactly similar hypotheses in regard to the Centrifugal Force have been postulated by Herschel, Bredichin, M. Faye, and Lebedew ; while Faraday, Gauss and others have suggested the close relationship that exists between electrical and gravitational phenomena.

The physical explanation of Kepler's Laws was suggested by Kepler himself, while Huyghens, Bernoulli, Descartes, and many of their contemporaries believed in the existence of some kind of vortices.

The unity of the universe has been a dream of philosophers for generations past, and that dream is now crystallized in the definite conception of an atomic universal electro-magnetic medium, while the electrical basis of matter receives the support of such men as Crookes, J. J. Thomson, Larmor and Vogt.

Thus we learn that all the dreams and thoughts, all the hypotheses and postulates of old-world as well as present-day philosophers find their consummation and ultimate realization in one universal, atomic, electro-magnetic medium.

If this fact does not stamp the theory with that authority which is undeniably associated with the names of some of the scientists quoted, then all the greatest men in the scientific world have lived and toiled, thought and dreamed in vain, while the priceless gems of their imagination and research are treated as worthless and valueless.

Again, what shall we say of the discoveries of to-day ?

What is the key to the greatest scientific discovery of modern times, viz. wireless or aetherial telegraphy, which is girdling the earth with its mysterious communications? Is not the key to that discovery to be found in this universal electro-magnetic medium ?

Whence come the X-rays, Rontgen rays, and other light rays with their adaptability to human suffering, if they come not from this same electro-magnetic medium ? their adaptability to human suffering being dependent upon the intimate and close relationship that exists between the physical body and the electro-magnetic medium.

Where is the key to the principle underlying the gramophone, the phonograph and the telephone, if it be not in this self-same atomic and easily impressible medium ?

Nay ! let us go further, and ask ourselves where is the key to be found for the many marvellous effects of so-called spirit phenomena ? Who can read F. W. Myer's *Human Personality and its Survival of Bodily Death*, and not feel that we are standing on the threshold of the unseen world ?

Already men are asking themselves the meaning of the strange sensations which they receive from unseen sources; already men's spirits are vibrating in unison with vibrations that come from the unseen world; and to-day we see spiritual phenomena as through a glass darkly, and the question arises, what is the medium of all this communication, of all these vibrations?

Is there no medium at all which forms the medium of communication? To assert that would be to assert something opposed to all experience and therefore would be unphilosophical.

May not then the theory of an atomic universal electromagnetic medium help us on in our groping and searching after light in this direction? Who will uplift the veil? Already we peer almost into the spirit world. A little more light, a little more truth, and then there will burst forth upon the hearts and minds of men the grandest and most glorious truth that Nature can reveal of her Creator, and then men shall come to know and understand the place that God holds in the Universe, such truth being advanced on its way by an atomic, universal electromagnetic Aether which is as truly matter as our own bodies.

ART. 127. *God and the Universe.*—To the superficial reader it may appear at first sight, that the theory of the Aether suggested in this work leaves no place in the Universe for the operations and existence of an Infinite and living Spirit, a God. It may be objected, that if all matter and all modes of motion find their physical origin in one common and primordial medium, the electro-magnetic Aether, where is the necessity for the existence of an Eternal and Infinite Spirit?

At first sight there appears some force in the objection, but it loses its point when we come to view the Universe from the standpoint of spirit phenomena. The purpose of the writer in this work has been to deal with natural phenomena only, purely from the philosophical and scientific standpoint. Spirit phenomena (which is equally as real and obvious as natural phenomena) have no part or place in a work which deals with scientific facts and data, but demand and will receive in a future work equal consideration and philosophic treatment. A man must indeed be lacking in vision who cannot see behind all things the evidence of a richer and fuller truth than that which merely lies on the surface, or who fails to read and learn the greatest truth that circles the Universe in its ultimate unity, which indisputably points to the existence of an Eternal and ever-living Spirit, a God. I affirm that there is no scientific truth, even including the law of the conservation of matter and motion, which has been enunciated in this work, but what is reconcilable with the

existence of an Eternal and Infinite Spirit; and although such a statement may seem a paradox, yet I am convinced that before many more years have passed, the reconciliation of natural with spiritual phenomena will be an accomplished fact. The fool to-day may say in his heart, there is no God, but ere long not only religion, but Science herself, shall expose his lack of wisdom and his folly.

For all things derive their existence primarily, with all the energies and powers they possess, from God. Look where we will, or at what we will, from the smallest atom or molecule up to the most stupendous world, or myriads of worlds that roll and sparkle in the blue infinity, in each and all we see the indisputable evidence of the existence of a mysterious spirit, or power, that controls and governs them. A spirit or power that we cannot see, but which is so indisputably evidenced that its existence cannot be denied. For example, we see forms of many kinds, some of which are simple entities of themselves, while others are complex and made up of many parts, but while each part is inseparably connected with the other, yet each part is itself distinct from the others in nature and substance. The whole combined forms a complete mechanism or organism, and, like all mechanisms of human make, not only needs a controlling and governing power, but also evidences a maker. Even the laws of Nature and modes of motion, whether it be heat, light, electricity, or magnetism, are, however, unable of themselves to control the mechanism, and therefore prove themselves to be but the servants of an infinite Intelligence, a GOD.

Thus, behind and beyond all we see, in every living form, there is the evidence of a hidden spirit, which is the governing and controlling and sustaining power, and without which the organism ceases to be an organism. A spirit which animates the mechanism, and uses its activities and powers as it wills for its own purposes and ends. This spirit or power we call its life, which gives to the form its existence, together with all that it possesses, as its powers, activities, energies and productions, for all are but the effects of the hidden life. If this mysterious something, termed its life, becomes in any way separated from the mechanism or organism, then as a distinct and separate organism it ceases to be; and though the mechanism may still exist for a time, yet all its powers are gone, while the organism, robbed of its very life, begins slowly to decay.

We cannot see this power; we cannot find it. We may search for it, rend and tear part from part, only to find that it baffles all our skill, and laughs at our endeavours to discover the secret of its existence. We know that it is there, just as truly as we know that in these forms of ours, these living

stoves, these perfect mechanisms called our bodies, there exists and dwells a spirit, a living, conscious, self-acting and controlling power. A spirit which we know is not the mechanism itself, and which by experience and observation we know to be distinct from the organism. It is this mysterious spirit which controls and governs all our acts, that rules and reigns as king of our bodies, and makes the physical mechanism, with all its wondrous parts, obey and do its bidding. That this is so, that the spirit is distinct from the body, and is the controlling and governing principle within us, is evident in a thousand ways. If, however, that spirit departs from the mechanism of our bodies, then the controlling and governing influence is gone; and the mechanism, robbed of its life, ceases to work, ceases to fulfil its functions, and ceases to exist in that particular form.

Just as it is with ourselves, so it is with the Universe. For look where we will, from the smallest atom to the great aggregation of atoms, as our earth, or even to the more stupendous orbs of heaven, the working of a secret and mysterious power or spirit meets our gaze. A spirit or power that is not the form or the mechanism, but is separate and distinct from the mechanism, while at the same time it is inseparably connected with each and all. For everything that we see, from an atom to the Universe itself, is a perfect mechanism, or complexity of mechanisms. The entire Universe is one vast, intricate, and elaborate piece of mechanism, beginning with the simple aetherial atom, ranging through all the atomic systems, graduating by successive steps through compound substances, which, in their aggregations, form meteors, satellites, planets, suns, and stars; until the ultimate whole is reached, where everything is blended into one vast whole; a perfect, infinite, complex mechanism, a Universe.

Now if philosophy teaches anything at all regarding mechanisms of human invention, it indisputably teaches that every machine or mechanism that has ever been made, implies the existence of a maker, and that the maker possessed intelligent attributes, as reason, judgment, perception, and imagination. For example, stand before some elaborate machine of human invention, as a lace machine, and watch the working of that machine in all its details. It is composed of many parts, each of which is perfect in itself. Each part may be distinct in nature and purpose, yet each and all are inseparably and unitedly connected with each other, and all work harmoniously together for the accomplishment of a definite and specific end, that is, the production of a lace curtain of exquisite design and pattern. As we watch the machine and its workings, we see therein the evidence of the existence of a spirit or power that

gave it its birth. A spirit or mind that made and formed the machine, that constituted, arranged, and gave it its governing and controlling power; fitted and ordered every part, gave to each part its allotted task, and moulded all to the harmonious fulfilment of the definite end and purpose he had in view.

Thus in the machine we see evidence of contrivance and design, of method and arrangement, of conception, perception and judgment, which are all the effects and outflowings of intelligence which belong, and alone belong, to mind; and therefore we say, "The machine was made, and there was and must have been a maker." So universally is this fact accepted, that any one who seriously challenged the statement, or dared to deny it, would be at once pitied as insane or laughed at as a fool. Thus all experience proves, and philosophy testifies, that wherever we get a machine or mechanism of any kind or sort, there must have been a living, conscious being or person, who is distinct from and outside of the machine. He made it, and therefore must have existed before it, in order to make it. Wherever, therefore, we find a mechanism that bears the marks of intelligence and design, of judgment, perception and conception, it is only logical and philosophical to infer, that such a mechanism equally evidences the existence of an intelligent being. The more intricate and elaborate the mechanism, the greater the ingenuity displayed, the more complex and perfect the design, the more harmonious the working, the greater will be the wisdom, the more profound the judgment, the keener the perception, the more perfect the understanding, and the vaster, nobler, and more sublime the order of Being who originated and made it. This being so, according to philosophical reasoning, let us glance at the Universe in all its fulness and oneness, and we shall see the indisputable evidence of the existence of an Infinite Being, who made, controls and governs the infinite Universe.

In the atomic world we get an illustration of the perfect mechanism that underlies all atomic systems. Our conception of an aetherial atom was based upon the analogy of our own planet, and there is every reason to believe that the little world in which all atoms live and move and have their being, is analogous to a planetary or solar system, in which we find the two essentials of matter and motion ever associated together, to form a larger and more complete mechanism. For atoms are not simply mere points; they possess real dimensions, with a determinate and fixed form, differing in their relative weights, and in the amount of motion or force with which each is endowed. The very fact that they possess atomic weights which are unalterable throughout the long periods of time that mark the history of the Universe, and that they combine in

definite and fixed proportions, indisputably evidence the fact that they but do the bidding of an Eternal and Infinite Spirit, a God. Thus each molecule, or atomic system forms a perfect mechanism in itself, with its own centre of gravity, and subject to the same laws of repulsion and attraction, or pressures and tensions—due to the vibrations and motions of the universal electro-magnetic Aether.

In each of the planetary systems we get an illustration of the same perfect mechanism, which is indicative of all systems whether large or small ; each system being characterised by the same beauty of order and harmony of motion which are equally characteristic of atomic systems.

Our own solar system, composed as it is of many parts, of thousands of meteors and comets, of numbers of satellites and planets, all revolving around one common centre, also forms a complete and perfect mechanism in itself. For millions and millions of years this perfect mechanism has been harmoniously working together in all its parts, as it moves in all its unity through the realms of infinite space. Yet through all the unknown ages of the past, such a phenomenon as disorder in the working of any part of the system is inconceivable and unknown. Out in stellar space there are, however, innumerable systems, similar to our own solar system, each distinct and perfect in itself ; each being made up of similar parts, as meteors, comets, satellites, planets, and central sun. These systems are, however, united together into one vast aggregation of worlds, having one common controlling centre of their own, and by their unity form a constellation, a larger and grander mechanism. Throughout the whole constellation there is the same order, and harmonious working of part with part, that characterise the solar system. Then these constellations increasing in their aggregations form a still larger complexity of systems, called a Galaxy ; and galaxy being added to galaxy, constellation to constellation, there is formed by such union, an ocean of suns and stars like our own Milky Way, the ultimate whole being characterised by the same mechanical order and harmonious working that characterise the solar system. It may even be, that there are numbers of these oceans of suns and stars existing in infinite space, all bound together by one common bond, the universal electro-magnetic Aether, and forming one vast ultimate whole, a Universe ; with all its oceans of suns moving around one central Orb or mass of Orbs called the Throne of GOD.

Thus the whole Universe is a mechanism, complete and perfect in every detail, and forming a system, so great, so grand, so sublime, so magnificent that it puts all mechanisms of human origin to shame and scorn. Now, if a mechanism of

human invention evidences the existence of intelligence and mind, and proves itself to be the production of a living, sentient, conscious, and intelligent being, how much more, incomparably more, does the Universe with its infinite complexity evidence a Maker also; and that Maker must be as infinitely greater in wisdom, knowledge, perception and judgment as the Universe is infinitely greater in mechanical perfection than any mechanism of human origin.

The Universe is God's teaching in symbol and in type. It is His great picture-book, where in living form He has portrayed Himself, and all that belongs to Him—His nature, character, wisdom; His greatness, glory, and His power. The Universe is a temple, where He sits enshrined in the things His own hands have made, and where those who have eyes to see, and hearts to learn and understand, may adore and worship Him.

Thus is it true that "the heavens declare the glory of God," *i. e.* the character of God, His infinite wisdom, His infinite knowledge, His profound judgment, and His eternal righteousness; while the firmament showeth His handiwork. "Day unto day uttereth speech, and night unto night showeth (His) knowledge."

"The Lord by wisdom hath founded the earth, by understanding hath He established the heavens."

"He hath made the earth by His power. He hath established the world by His wisdom, and hath stretched out the heavens by His discretion."

"Thou, Lord, in the beginning hast laid the foundations of the earth, and the heavens are the work of Thy hands; they shall perish, but Thou remainest; and they all shall wax old, as doth a garment; and as a vesture shalt Thou fold them up, and they shall be changed; but Thou art the same, and Thy years shall not fail."

To prove the validity of these statements from a scientific and philosophic standpoint, and to show the harmony that exists between the natural and the Divine revelation as given in the Word of God, will form the subject of a future work.

APPENDIX A

ACCORDING to Sir Oliver Lodge the fact that electricity possesses mass or inertia has now passed out of the hypothetical stage into the realm of fact and experiment. In his Romanes Lecture recently published, he states, page 4: "My first thesis is that an electric charge possesses the most fundamental and characteristic property of matter, viz. mass or inertia; so that if any one were to speak of a milligramme or an ounce or a ton of electricity, though he would certainly be speaking inconveniently, he might not necessarily be speaking erroneously."

Now in view of the identity that exists between Aether and electricity, as proved by Hertz' experiments, the only logical conclusion that can be arrived at is, that Aether must also possess mass and inertia. So that the most recent experiments in relation to electricity confirm the theory of the Aether presented in this work, viz. that it also possesses mass and inertia, otherwise we should have a massless medium being composed of electrons which possess mass, and that would be a violation of all experience, and therefore an unphilosophical statement.

APPENDIX B

THE hypothesis of electricity being the fundamental basis of all matter made in the last chapter on the "Unity of the Universe," receives confirmation from Sir Oliver Lodge in his *Modern Views of Matter*, where he writes, page 13: "The fundamental ingredient of which, in this view, the whole of matter is made up, is nothing more or less than electricity, in the form of an aggregate of an equal number of positive and negative electric charges. This, when established, will be a unification of matter such as has through all the ages been sought; it goes further than had been hoped, for the substratum is not an unknown and hypothetical protile, but the familiar electric charge."

APPENDIX C

THE hypothesis that all elements have definite quantities of electricity in them, or a definite number of electrons, as suggested on page 335, receives added weight by the testimony of Sir Oliver Lodge in the work already referred to. Writing on the subject, he says: "It is a fascinating guess that the electrons constitute the fundamental substratum of which all matter is composed. That a grouping of say 700 electrons, 350 positive and 350 negative, interleaved or interlocked in a state of violent motion so as to produce a stable configuration under the influence of their centrifugal inertia and their electric forces, constitutes an atom of hydrogen. That sixteen times as many, in another stable grouping, constitute an atom of oxygen. That some 16,000 of them go to form an atom of sodium; about 100,000 an atom of barium; and 160,000 an atom of radium."

From these extracts, taken from *Modern Views of Matter*, the author claims that the theory of the Aether presented to the reader in *Aether and Gravitation* receives added confirmation and support.

ERRATA

The author regrets that Professor J. J. Thomson's name has been incorrectly spelled in several places.

INDEX

- ABERRATION of light, 69, 149, 218
Absorption, 104-6
Acceleration, 239
Actinic rays, 141
Action at a distance, 96, 174, 176
 and re-action, 20, 251
Adams' discovery of Neptune, 25
Aether is matter, 54-8
 is atomic, 59-67
 is gravitative, 64-9
 density of, 69, 71, 136, 243
 elasticity of, 74-7
 inertia of, 76, 330
 its motions, 80
 compressibility of, 291, 315
 waves, 79-80
Aetherial basis of matter, 326
Affinity, chemical, 43
Aldebaran, 312
Aluminium, 79
Ampère, 192
Ampère's theory of magnetism, 193
Andromeda, 314
Annual magnetic variation, 208
Annular nebulae, 320
Aphelion of earth, 36
Arago, M., 321
Arcturus, 312
Areas, Kepler's law of, 36
Asten, Von, 234, 296
Asteroids, 31
Atmosphere, 68, 73, 102, 225
Atom, vortex, 45, 46, 61
 what it is, 43
 electron, 63
 Boscovitch, 61
 hard, 61
 size of, 43
Attraction, electrical, 2, 286
 of gravitation, 13, 24, 31
 magnetic, 195
Balance, Torsion, 187
Bernoulli, 221, 341
Beta Persei, 308
Biela's comet, 296-7
Binary compound, 143
 stars, 25, 309
Biot, 138
Boscovitch atoms, 44, 138
Boyle and Marriotte's law, 76, 103
Bradley's discovery of aberration, 149
Bredichin on comets' tails, 302
Brilliancy of stars, 307, 309
British Association Report, 57, 59
Calcium, 79
Canis major, 307
 minor, 307
Capella, 312
Carbon, 48
Carboniferous period, 115
Carnot on heat, 116-18
Cassini, 307
Cause and effect, 14
 of gravitation, 1, 282-9
Cavendish experiment, 24
Centauri, 79
Centre of gravity, 325
Centrifugal force, 9, 13, 15, 30, 236-8
Centripetal force, 9, 12, 282
Cetus, 307
Chalk, 6
Challis, Prof., 74, 96, 100, 107, 151, 155,
 214, 227, 311
Chemistry, 47, 336

- Coal, 86, 88
 Clairaut, 297
 Clusters of stars, 314
 Cohesion, 48
 Colour, 138
 Colours of stars, 308
 seven primary, 139
 Comets, 291
 attracted by planets, 298
 condensation of, 292
 Comets and meteors, 297
 short period, 293-4
 long period, 293-4
 tails of, 298-9
 orbits of, 293
 nucleus of, 298-9
 coma, 298-9
 Compressibility of aether, 291, 315
 Condensation of gases, 47
 Conservation of matter, 42
 of energy, 84
 of motion, 92
 Constellations, 307
 Corollary, 15
 Corona Borealis, 309
 Corpuscles, 42, 64, 136
 Corpuscular theory of light, 122
 Correlation of forces, 83
 Coulomb Torsion balance, 185, 187
 Crookes, Sir William, 42, 136, 326, 341
 Current, electric, 163
 magnetic, 192
 Currents, 90
 Curry, Prof., 284
 Cycle of operations, 114, 116
 Cygnus, 307

 Dalton's atomic theory, 42
 Davy, 99, 107
 Day and night, 4
 D'Arrest's comet, 296
 Deimos, 38
 Democritus, 44
 Density of matter, 51
 of aether, 69
 electric, 170
 of earth, 242
 of sun, 27
 of planets, 242
 Descartes, 221-2, 341
 Dewar, Prof., 47

 Diameter of earth, 29
 polar, 29
 equatorial, 29
 of sun, 280
 of planets, 29
 Dielectric, 168, 175
 Diffusion, 49
 Dip, magnetic, 199
 Distances of stars, 280
 Diurnal variations, magnetic, 209
 Dog star (Sirius), 306
 Donati's comet, 298
 Double stars, 308
 Draco, 307
 Dynamical equivalent of heat, 114
 value of light, 150
 Dynamics, laws of thermo-, 114-18
 Dynamo, 87, 90

 Ear, 120
 Earth, mass of, 235, 242
 a magnet, 196-8
 size of, 29
 rotation of, 219
 orbit of, 276
 periodic time of, 251
 gravity of, 29
 shape of, 29
 distance from sun, 242, 251
 velocity in orbit, 251
 Eccentricity of orbits, 268, 276
 Eclipse, 145, 148
 Ecliptic, plane of, 277-9
 Elasticity, 46
 of matter, 51
 of aether, 74
 Electric current, 154
 potential, 170
 induction, 175
 radiation, 182
 density, 170
 energy, 179
 field, 166, 179
 lines of force, 173
 Electricity, 64, 162
 two kinds of, 175
 positive, 175
 negative, 175
 laws of, 184
 theories of, 162
 Electrons, 136, 163

- Electro-static, 158, 164
 kinetic, 158, 164
 kinetic energy, 217
 magnetism, 192-5
 magnets, 199
 magnetic theory of light, 229
 chemical equivalents, 189, 333
 Elements of matter, 47
 Ellipse, 34
 Kepler's discovery of, 34
 Elliptical nebulae, 320
 Emission theory of light, 122
 Encke's comet, 293, 296
 resisting medium, 228
 Energy, 83, 84
 what it is, 83
 conservation of, 84
 transformation of, 86
 potential, 87
 kinetic, 89, 164
 radiant, 109
 electrical, 179
 and motion, 91
 Engine, Carnot's heat, 116
 Envelopes of comets, 298
 Epicureans, 44
 Equal areas, 36
 times, 36
 Equator, N. and S. Poles, 29
 magnetic, 202
 terrestrial, 29
 Equipotential surfaces, 171
 Equivalents, electro-chemical, 189, 333
 Euler, 123
 Exchanges, theory of, 105
 Experience, 4
 Experiments of Rumford, 98
 of Michelson and Morley, 67, 227
 of Lebedew, 302
 of Nichols and Hull, 153
 of Hertz, 165
 of Faraday, 65, 285
 of M. Faye, 302
 of Joule, 114

 Falling stone, 21, 29
 Faraday, 45, 175, 220
 on matter, 56
 on Lines of Force, 168, 200, 203-5
 on magnetic space, 208
 on gravitation, 287

 Faraday, on electricity, 332
 on induction, 176
 Faye, M., 111, 302, 319
 Faye's comet, 293, 296
 Field, electric, 179
 magnetic, 199
 Fizeau, 149, 224
 Fluids, 48
 Food, 89
 Forbes, 121
 Force, 16, 19, 90
 centrifugal, 9, 13, 236
 centripetal, 9, 12, 282
 lines of, 200
 Forces, direction of the, 26
 proportion of the, 26
 Foucault, 149
 Franklin, 106
 Fresnel, 75, 131
 Frictionless medium, 17, 131, 136, 224
 Fundamental medium, 54

 Galaxy, 325, 346
 Gaseous nebulae, 313
 Gases, condensation of, 47
 liquefaction of, 47
 kinetic theory of, 49
 Glazebrook, Prof., on aether and gravi-
 tation, 22
 Globular clusters of stars, 314
 Gravitation, law of, 61, 65
 universal, 24
 intensity of, 27
 law of proportion, 26
 cause of, 1, 282
 and binary stars, 25
 Gravity, centre of, 325
 Great Bear, 307
 Grove, 83

 Halley's comet, 296-7
 Hamilton, Sir W. R., 247
 Head of comets, 298
 Heat is motion, 98
 a mode of motion, 107
 radiant, 109
 dynamical equivalent of, 116
 effects of, 107
 nature of, 98
 radiation of, 109
 transformation of, 87

- Heat engine, Carnot's, 116
 of sun, 109
 and matter, 100
 and work, 114
 refraction of, 121
- Helmholtz, Von, 45, 86
- Hercules, 257, 271, 307
- Herschel, Sir J., 3, 4, 7, 226, 228, 281,
 299, 301, 310, 321
 Sir W., 109, 271-2, 313
- Hertz, 138, 159, 182
- Hicks, Prof., 13
- Hodograph of planets, 247
- Hot springs, 90
- Huggins, 313-14
- Huyghens, 54, 123, 125, 128
- Hydrogen, 40, 42, 44, 60, 93, 314, 333
- Hypotheses, 3, 338
- Ice, 42
- Identity of heat and light, 119
 light and electricity, 156, 160, 165
 aether and electricity, 331
- Imponderable, 71
- Impressed force, 20
- Impressible aether, 78
- Induction, electric, 174-5
 magnetic, 199
 Faraday's theory of, 175
- Inertia of matter, 52
 of aether, 330
- Intensity of light, 28, 146
 of heat, 28, 113
 of electricity, 184
 of gravity, 28
- Iron, 42
 expansion by heat, 101
 contraction by cold, 102
- Joule, 85, 114
- Jupiter, 26, 68
 mass of, 235
 satellites of, 149, 178
 rotation of, 219
 orbital velocity of, 251, 265
 size of, 235
 distance from sun, 242, 251
 density of, 242
 and comets, 305
- Kant, 317
- Kelvin, Lord, 43, 71, 77, 80, 95, 216, 227
 on aether, 56-7
 on vortex atom, 63 ⁴⁵⁻⁴⁶
 on compressible aether, 291, 315
 on light, 151
- Kepler's laws, 32
 first, 33, 256-9
 second, 36, 260-2
 third, 37, 263-5
 on vortex motion, 221-2
- Kinetic energy, 89
 electro, 217
- Kirchhoff, 43
- Laplace, 317
 nebular hypothesis, 317
- Larmor, Dr., 22, 44, 56, 63, 93, 163
 on electrons, 284
 on aetherial physics, 22, 327-9
- Lavoisier, 42
- Law of gravitation, 24
 of inverse squares, 27
- Laws of electricity, 184
 of light, 145
 of heat, 113
 of motion, 9, 15, 233
- Lead, 88, 333
- Lebedew, 32, 76, 153
- Le Verrier, 25
 discovery of Neptune, 25
- Leyden jar, 157
- Liebnitz, 223
- Light, 75
 a mode of motion, 122
 corpuscular theory of, 123
 undulatory theory of, 123, 136
 electro-magnetic theory of, 156
 path of a ray of, 144
 intensity of, 145
 reflection of, 136
 refraction of, 135
 aberration of, 149
 composition of, 139
 velocity of, 148
 zodiacal, 277
 transverse vibration of, 130
- Lines of force, electric, 173
 magnetic, 201-3
- Liquefaction of gases, 47
- Liquid air, 47
- Liquids, 48

- Little Bear, 307
 Dog, 307
 Lockyer, 109
 Lodge, Dr., 219
 on aether density, 69
 on aether, 284, 289, 328, 332
 on electric inertia, 330
 on electricity, 64, 69, 284, 285
 on force, 17
 on gravitation, 283
 Lorentz on light, 154
 Lyra, 307
- MacLaurin, 2, 10, 17
 Magnesium, 79
 Magnet, 21
 Magnets, bar, 199
 moving, 211
 Magnetic axis, 202
 field, 199
 lines of force, 200
 shells, 205
 equator, 202
 induction, 199
 variation, 208
 molecules of, 193
 polarity, 194
 Magnetism of earth, 207-12
 of planets, 211
 cause of solar, 211
 Ampère's theory of, 193
 Mars, 68, 79
 a magnet, 196
 rotation of, 219
 size of, 236
 orbital velocity of, 251
 satellites of, 178
 orbit of, 33
 Mass, 27, 53, 187
 of earth, 235, 242
 of planets, 235, 242
 of sun, 190
 Matter, elements of, 40
 properties of, 42, 50
 and motion, 41, 322
 conservation of, 42
 divisibility of, 44
 four states of, 48
 aetherial basis of, 48, 333
 physical constitution of, 334
 Maxwell, J. C., 43, 73, 85, 151, 211
- Maxwell, J. C., on physical lines of force,
 168, 203-5, 288
 on aether, 59, 206
 on magnetism, 205
 on electro-kinetic energy, 180, 217
 on aether, 58
 Mayer, 84, 86, 114, 118
 McCullagh, 75
 Mechanical energy, 87
 Medium, Descartes on a, 221
 Kepler on a, 222
 Mercury, 68, 79
 a magnet, 196
 rotation of, 219
 eccentricity of orbit, 33
 mass of, 242
 orbital velocity of, 251
 Meteorites, 95, 118
 Meteors, 31, 85, 118
 Michelson and Morley, 7, 67
 Milky way, 79, 309, 314
 Molecules, 44
 Momentum, 20
 Moon, 61
 Motion of stars, 310
 planetary, 253
 of sun, 274
 of aether, 80
 and work, 95
 modes of, 92, 122, 163
 first law of, 15, 16, 239
 second law of, 19, 244
 third law of, 20, 251
 Multiple stars, 308
- Natural philosophy, 4
 Nebulae and aether, 313
 structure of, 314
 spiral, 322
 annular, 320
 elliptical, 320
 planetary, 321
 spectrum of, 314
 irregular, 319
 Nebular hypothesis, 317
 Nebulous stars, 311
 Neptune, 68
 discovery of, 25
 mass of, 235
 orbital velocity of, 251, 265
 distance from sun, 242

- Neptune, a magnet, 196
 Newton's coloured rings, 107
 Optics, 72, 98, 122
 letter to Bentley, 2, 96
 Rules of Philosophy, 3
 Principia, 3, 7, 38
 emission theory, 123
 law of gravitation, 24
 atoms, 44
 on aether, 98
 Nichols and Hull, 32, 153

 Ocean, 81, 90
 Operations, cycle of, 114
Optics, Newton's, 2, 122
 Orbital motions of planets, 266
 Orbit of earth, 33
 of Venus, 33
 Orbits of satellites, 34
 of planets, 33-4, 266
 moon, 267
 stars, 310
 sun, 270
 Origin of sun's heat, 95
 Orion, 79, 307, 314, 319
 Oxygen, 40, 44, 60, 93

 Parallelogram of forces, 15
 Pendulum, 88
 Periodic times, 37
 Perpetual motion, 93, 220
Phil. Mag., 58, 67, 71, 73, 74, 80
Phil. Trans., 58, 62, 64, 75
 Philosophy, Rules of, 3
 Phobos, 38
 Physical lines of force, 203-6
 Pitch of Sound, 105, 120, 139
 Plane of ecliptic, 277-9
 Planetoids, 31
 Planets, minor, 31
 origin of, 240
 orbits of, 33, 266
 electrified bodies, 177
 masses of, 242
 relative distances of, 242
 orbital velocities of, 251
 periodic times of, 251
 Platinum, 48
 Pleiades, 79
 Polarization, 176
 Potential energy, 87

 Potential, electric, 170
 magnetic, 194
 Pouillet, M., 109
 Poynting, 91
 Pressure, aetherial, 181
 Preston, Prof., 283
 Prevost, theory of exchanges, 105
 Primitive impulse, 9, 10, 12, 319
Principia, Newton's, 3, 7, 38-9, 122
 Properties of matter, 42

 Quantity of sun's heat, 109
 Query, 18-19
 Optics, 72, 122

 Radiant heat, 109
 energy, 115
 Radiation, 104
 Radius Vector, 26
 Rankine, 103
 Rays, actinic, 141
 dark heat, 140
 infra-red, 141
 ultra-violet, 140
 Röntgen, 341
 X, 341
 Rectilinear propagation of light, 144
 of heat, 111
 Reflection, 160
 Refraction, 160
 Relative motion of aether and matter,
 224-6
 Resistance to motion, 17
 Resisting medium, 228
 Reversible cycle, 116, 118
 Rings, vortex, 45
 Rival theories, 8
 Rivers, 89-90
 Römer, and velocity of light, 148
 Rotation of earth, 219
 of planets, 219
 of sun, 246
 Rotatory motion, 93
 Rucker, Prof., 59
 Rules of Philosophy, 3
 first, 3
 second, 4
 third, 3, 7
 Rumford, 98
 Running water, 95

- Satellites of Mars, 38, 178
 Jupiter, 149, 178
 Uranus, 254
 Neptune, 254
- Saturn, 26-7, 68
 mass of, 235, 242
 orbital velocity of, 251, 265
 rotation of, 219
 density of, 242
 a magnet, 196
 satellites of, 178
- Schuster, Prof., 8, 218, 311
- Sirius, 306, 308-9
- Sodium, 43
- Solar system, motion of, 257, 271
 spectrum, 79, 139
 magnetism, 211
- Sound, 75
 waves, 104, 120
- Space, interstellar, 310, 313
- Spectroscope, 47, 79
- Spectrum analysis, 50, 139
- Spiral nebulae, 322
- Stars, fixed, 58
 number of, 11, 306
 binary, 309
 distances of, 280
 magnitude of, 306, 309
 colour of, 79, 308
 motion of, 310-11
 nebulous, 320
 proper motions of, 312
 variable, 307
 double, 308
 clusters of, 314
 orbits of, 310
 are magnets, 307
- Stokes, Sir G., 69, 152, 218
- String, 21
- Sun, diameter of, 280
 constitution of, 79
 a magnet, 164, 198-9
 mass of, 190
 heat of, 109
 motions of, 270
 orbital velocity of, 35
 rotation of, 246
 centre of two forces, 186
- Tails of comets, 300, 304
 straight, 300
 Tails of comets, curved, 301
 multiple, 300
- Tait, Prof., 18, 40-1, 88, 247
- Telescope, 79
- Temperature, 104-5
- Terrestrial magnetism, 207-12
 gravity, 29
- Theory, atomic, 44
 rules for making, 3
 undulatory, 123
 of exchanges, 105
- Thermodynamics, first law of, 87, 114
 second law of, 116
- Thomson, J. J., Prof., 43, 326, 335
- Tidal water-power, 88
- Tides, 89, 96
- Torsion balance, 185
- Trade winds, 96, 249
- Transformation of energy, 86
 of motion, 93
- Transverse vibration of light, 130
- Tuning-fork, 104
- Tympanum, 120
- Tyndall on radiation, 104, 106
 on light, 71
 on Lines of Force, 174
 on aether, 77
 on atoms, 106
 on aether waves, 112
- Ultra-violet rays, 140
 red rays, 140
- Unity of universe, 322-9
- Universal gravitation, 24
 aether, 58
- Universe, 313, 322, 347
- Uranus, 68
 mass of, 235
 density of, 242
 orbital velocity of, 265
 a magnet, 196
- Ursa Major, 307
 Minor, 307
- Vapour, 49
- Variation, magnetic, 209-11
- Velocity of light, 148
 of electric waves, 182
 of heat waves, 148
 of falling bodies, 21
 of wave motion, 76

- Velocity, angular, 250
 Venus, 33, 68, 79
 a magnet, 197
 mass of, 235
 rotation of, 219
 orbital velocity of, 251
 periodic time of, 251
 Vibration, atomic, 75
 Vibrations, transverse, 130
 longitudinal, 130
 of sound, 123
 Vibratory motion, 91
 Vogel, Prof., 308, 312
 Vogt, Prof., 332
 Volume of sun, 27
 Von Asten, 234, 296
 Vortex theory, 92, 337
 motion, 221-4
 atom, 93, 126, 337, 45-46
 rings, 125, 337
 Vortices, molecular, 103

 Water waves, 124
 currents, power of, 95
 composition of, 141
 power, 88
 Wave front, 128
 motion, 124, 160

 Wave lengths, 120
 envelope, 112
 Waves, chemical, 141
 sound, 104, 120, 124
 light, 126
 heat, 141
 electric, 159
 spherical, 112
 electro-magnetic, 165
 Weight, 29, 69, 84
 variation of, 29
 pound, 30
 Whewell, 3, 221
 Winds, 81, 90
 energy of, 90
 trade, 225
 Work, 96
 and energy, 84
 from heat, 116

 Young, Thomas, 54, 64, 67, 123
 on aether, 58
 fourth hypothesis, 70
 Prof., of America, on electric space,
 166

 Zinc, 88
 Zodiacal light, 277-9

Some New Publications

OF

Messrs. Chapman & Hall, Ltd.

1903—4

MR. H. G. WELLS'S NEW WORK.

MANKIND IN THE MAKING. By H. G. WELLS, author of "Anticipations," etc. Crown 8vo, 7s. 6d.

In this new and important work Mr. Wells attempts to deal with social and political questions in a new way and from a new starting-point, viewing the whole social and political world as aspects of one universal evolving scheme, and placing all social and political activities in a defined relation to that; and it is to this general method and trend that the attention of the reader is especially directed.

DR. ALFRED RUSSEL WALLACE'S NEW BOOK.

MAN'S PLACE IN THE UNIVERSE. A study of the results of scientific research in relation to the unity or plurality of worlds. By ALFRED RUSSEL WALLACE, LL.D., D.C.L., F.R.S., author of "Natural Selection," "Darwinism," etc., etc. With Diagrams. Demy 8vo, 12s. 6d. net.

This volume is an amplification and extension of the much-discussed article contributed by Dr. Wallace to the *Fortnightly Review* for March 1903, and presents the whole subject in a more complete and systematic manner, besides containing many new and forcible arguments which a more careful consideration of the whole problem has suggested.

In the course of the work the various astronomical and other criticisms of the article are considered and replied to.

A NEW THEORY OF GRAVITATION.

AETHER AND GRAVITATION. By W. G. HOOPER, F.S.S. With Diagrams. Demy 8vo, 12s. 6d. net.

This work seeks to offer an acceptable solution of the greatest scientific problem that has puzzled scientists for the past 200 years. Ever since the discovery of universal gravitation by Sir Isaac Newton, the question has arisen, over and over again, as to what is the physical cause of the attraction of gravitation. Is it due, as Newton himself suggested, to the properties and qualities of the universal aether, or is it due to some still unknown and undiscovered medium?

By the theory propounded in this work, the author has for the first time brought aetherial physics into harmony with all observation and experiments; so that the inertia, the density, and the elasticity of the aether are brought into harmony with all experience by philosophical reasoning based on Newton's Rules of Philosophy.

LIFE AND TOPOGRAPHY OF DICKENS.

THE REAL DICKENS LAND. With an outline of Charles Dickens's life. By H. SNOWDEN WARD and CATHARINE WARD, authors of "Shakespeare's Town and Times." With a Steel Plate Portrait of Dickens, Three Photogravures, and nearly 300 full-page and other Illustrations. Crown 4to, 10s. 6d. net.

Charles Dickens's understanding of the human character is apparent to every good reader of his works; but his intimate knowledge of the "character" of places, and of the important effect of place upon the human being, is not so apparent, because the reader has not the necessary knowledge of the places upon which to base an estimate.

In "The Real Dickens Land" the authors have attempted to supply this necessary knowledge, not only by literary identification, but by presenting one of the fullest collections of photographic views thus identified ever got together.

LONDON: CHAPMAN & HALL, LTD.

CARLYLE'S LIFE AND TOPOGRAPHY.

THE CARLYLE COUNTRY. With a study of Carlyle's life. By J. M. SLOAN. With a Foreword by SIR JAMES CRICHTON-BROWN, M.D., LL.D., F.R.S. With a Photogravure of the Whistler Portrait of Carlyle, Two other Photogravures, and about 100 Portraits, full-page and other Illustrations. Crown 4to, 10s. 6d. net.

This new Carlyle Book deals with the Carlyles in all their multifarious relations to the Carlyle Country, and casts much valuable light upon the complex problems raised by Carlyle's earlier and later life.

It forms a most useful and instructive Guide to the Carlyle Country, and will appeal to old Carlylean Readers by its careful grouping of biographical events around the places with which they are inextricably identified.

A valuable Carlyle Chronology is appended, together with an Index and Map.

HISTORY OF CHINA.

CHINA, PAST AND PRESENT. By E. H. PARKER, Professor of Chinese at the Owens College, Manchester; formerly H.B.M. Consul at Kiungchow; Author of "China," "John Chinaman," etc., etc. With a Map of China. Demy 8vo, 10s. 6d. net.

Mr. Parker is one of the great authorities on all that concerns China and the Chinese, and has been writing upon every phase of the subject for many years past. In this work he deals with the whole history of the nation from the earliest times to the present day. His volume is divided into nine books: I. Historical and Statistical; II. The "Boxer" Wars; III. Religious; IV. The Imperial Power; V. The Foreigner in China; VI. Mandarin or Official; VII. Celestial Peculiarities; VIII. Political; IX. The Seamy Side.

Each of these books is divided into chapters dealing comprehensively with the whole subject.

NEW WORK ON PAGAN IDOLATRY.

THE WORSHIP OF THE DEAD. The Origin, Nature, and History of Pagan Idolatry. By COLONEL J. GARNIER, R.E. With Four full-page Illustrations and numerous Pictures in the text. Demy 8vo, 16s. net.

The intimate relation of the ancient Paganism to the early history of mankind and its influence on the fate and fortunes of the human race gives no little interest and importance to any inquiry into its origin and nature, and the facts collected and compared in the present work will be found, not only to throw a remarkable light on the early history of Egypt and Babylonia but to have an especial bearing on important questions of the present day.

EVERYDAY LIFE IN CHINA.

LIFE AND SPORT IN CHINA. By OLIVER G. READY, B.A. With Thirteen Illustrations and a Map. Demy 8vo, 10s. 6d. net.

In this work the author, who has resided in various parts of the country for upwards of twelve years, has endeavoured to place before readers an account of things and events as he saw them, and to convey to their minds an idea of how Europeans live there, of their amusements, of their work, and of those things which are matters of daily interest to them, so that the work may serve as a kind of preface to that enthralling volume, the current history of China, as it is daily revealed in the Press, in Magazines, and in learned works.

IZAAK WALTON.

IZAAK WALTON AND HIS FRIENDS. By STAPLETON MARTIN, M.A., Christ's College, Cambridge, Barrister-at-Law. With Portraits and Illustrations. Demy 8vo, 10s. 6d. net.

Mr. Stapleton Martin has written this book with the primary object of bringing out the spiritual side of Walton's character. He traces carefully the inner workings of Walton's mind, and aims at setting forth the man as he was best known to the circle of intimates with whom he shared his confidences.

The better to indicate this aspect, the volume also contains brief biographical sketches of Walton's poet and ecclesiastic friends, together with a fine collection of portraits and illustrations of places connected with Walton's life. There is also a selection from the poetical works of Walton, Cotton, Donne, Herbert, Wotton, Duport.

LONDON: CHAPMAN & HALL, LTD.

Digitized by Google

UNIVERSITY OF MICHIGAN



3 9015 04633 0158

